

ADS54J40 双通道 14 位 1.0GSPS 模数转换器

1 特性

- 14 位分辨率、双通道、1GSPS ADC
- 本底噪声：-158dBFS/Hz
- 频谱性能 ($f_{IN} = 170\text{MHz}$ ，-1dBFS)：
 - SNR：69.0dBFS
 - NSD：-155.9dBFS/Hz
 - SFDR：86dBc (包括交错音调)
 - SFDR：89dBc (不包括 HD2、HD3 和交错音调)
- 频谱性能 ($f_{IN} = 350\text{MHz}$ ，-1dBFS)：
 - SNR：66.3dBFS
 - NSD：-153.3dBFS/Hz
 - SFDR：75dBc
 - SFDR：85dBc (不包括 HD2、HD3 和交错音调)
- 通道隔离： $f_{IN} = 170\text{MHz}$ 时为 100dBc
- 满量程输入：1.9V V_{PP}
- 输入带宽 (3dB)：1.2GHz
- 片上抖动
- 集成宽带 DDC 块
- 支持子类 1 的 JESD204B 接口：
 - 10.0Gbps 时每个 ADC 具有 2 条信道
 - 5.0Gbps 时每个 ADC 具有 4 条信道
 - 支持多芯片同步
- 功率耗散：1GSPS 时为每通道 1.35W
- 封装：72 引脚 VQFN (10mm × 10mm)

2 应用

- [雷达](#)和天线阵列
- [无线宽带](#)
- 电缆 CMTS、DOCSIS 3.1 接收器
- [通信测试设备](#)
- [微波接收器](#)
- 软件定义无线电 (SDR)
- 数字转换器
- [医疗成像和诊断](#)

3 说明

ADS54J40 是一款低功耗、高带宽、14 位、1.0GSPS 双通道模数转换器 (ADC)。该器件具有高信噪比 (SNR)，可为需要在高瞬时带宽内实现超高动态范围的应用提供 -158dBFS/Hz 的本底噪声。该器件支持 JESD204B 串行接口，数据传输速率高达 10.0Gbps，每个 ADC 可支持双通道或四通道。经缓冲的模拟输入可在较宽频率范围内提供统一的输入阻抗，并尽可能降低采样和保持毛刺脉冲能量。可选择将每个 ADC 通道连接至数字下变频器 (DDC) 模块。ADS54J40 以超低功耗在宽输入频率范围内提供出色的无杂散动态范围 (SFDR)。

JESD204B 接口减少了接口线路数，从而实现高系统集成度。内部锁相环 (PLL) 会将 ADC 采样时钟加倍，以获得对各通道的 14 位数据进行串行化所使用的位时钟。

器件信息

器件型号	封装 ⁽¹⁾	封装尺寸 (标称值)
ADS54J40	VQFN (72)	10.00mm x 10.00mm

(1) 如需了解所有可用封装，请参阅数据表末尾的可订购产品附录。

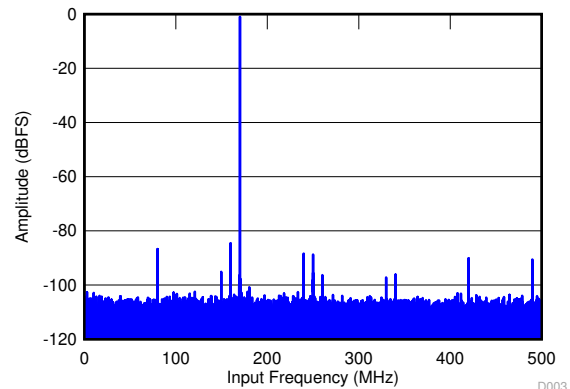

(SNR = 69dBFS ; SFDR = 86dBc ; $f_{IN} = 170\text{MHz}$, IL 毛刺 = 84dBc ; 非 HD2、HD3 毛刺 = 89dBc)

用于 170MHz 输入信号的 FFT



Table of Contents

1 特性.....	1	8.3 Feature Description.....	28
2 应用.....	1	8.4 Device Functional Modes.....	36
3 说明.....	1	8.5 Register Maps.....	48
4 Revision History.....	2	9 Application Information Disclaimer.....	85
5 ADS54J40 Comparison.....	5	9.1 Application Information.....	85
6 Pin Configuration and Functions.....	6	9.2 Typical Application.....	103
7 Specifications.....	8	10 Power Supply Recommendations.....	106
7.1 Absolute Maximum Ratings.....	8	10.1 Power Sequencing and Initialization.....	106
7.2 ESD Ratings.....	8	11 Layout.....	107
7.3 Recommended Operating Conditions.....	9	11.1 Layout Guidelines.....	107
7.4 Thermal Information.....	9	11.2 Layout Example.....	107
7.5 Electrical Characteristics.....	10	12 Device and Documentation Support.....	108
7.6 AC Characteristics.....	11	12.1 Documentation Support.....	108
7.7 Digital Characteristics.....	15	12.2 Receiving Notification of Documentation Updates.....	108
7.8 Timing Requirements.....	16	12.3 支持资源.....	108
7.9 Typical Characteristics.....	18	12.4 Trademarks.....	108
8 Detailed Description.....	27	12.5 静电放电警告.....	108
8.1 Overview.....	27	12.6 术语表.....	108
8.2 Functional Block Diagram.....	27		

4 Revision History

注：以前版本的页码可能与当前版本的页码不同

Changes from Revision B (January 2017) to Revision C (December 2020)	Page
• 向特性要点添加了文本“(包括交错音调)”	1
• Added <i>ADS54J40 Comparison</i> section, moved <i>Device Comparison Table</i> to this section	5
• Changed the description of SYSREFM, SYSREFP, and PDN pins in <i>Pin Functions</i> table	6
• Changed $f_{IN} = 470$ MHz test conditions and typical values across parameters in <i>AC Characteristics</i> table	11
• Added $f_{IN} = 720$ MHz test conditions across parameters in <i>AC Characteristics</i> table	11
• Changed ENOB unit from <i>dBFS</i> to <i>Bits</i> in <i>AC Characteristics</i> table	11
• Changed typical values of SFDR_IL parameter	11
• Changed first IMD3 typical value from -85 dBFS to -89 dBFS	11
• Changed first footnote in <i>Timing Characteristics</i> table	16
• Changed typical value of <i>FOVR latency</i> from $18 + 4$ ns to 18	16
• Changed t_{PD} parameter name to t_{PDI} in <i>Timing Characteristics</i> table	16
• Changed <i>FFT for 470-MHz Input Signal at -3 dBFS</i> figure, title, and conditions	18
• Added <i>FFT for 720-MHz Input Signal at -6 dBFS</i> figure	18
• Changed <i>Spurious-Free Dynamic Range vs Input Frequency</i> figure	18
• Changed <i>IL Spur vs Input Frequency</i> figure	18
• Changed <i>16-bit</i> to <i>14-bit</i> in first sentence of <i>Overview</i> section	27
• Added <i>DDC Block</i> section	30
• Changed 表 8-6	36
• Added last sentence to Step 4 in <i>Serial Register Readout: Analog Bank</i> section	39
• Added last sentence to Step 4 in <i>Serial Register Readout: JESD Bank</i> section	40
• Added <i>SDOUT Timing Diagram</i> figure	40
• Changed the <i>JESD204B Test Patterns</i> section	43
• Changed <i>Serial Interface Registers</i> diagram	48
• Added register addresses 1 and 2 to <i>GENERAL REGISTERS</i> in <i>Register Map</i> section	48
• Changed the name of <i>JESD ANALOG PAGE (6A00h)</i> to <i>JESD ANALOG PAGE (JESD BANK PAGE SEL=6A00h)</i> in <i>Register Map</i> table	48
• Changed bit 1, register 12 of <i>JESD ANALOG PAGE (6A00h)</i> from 0 to <i>ALWAYS WRITE 1</i>	48

• Added <i>OFFSET READ Page</i> and <i>OFFSET LOAD Page</i> registers to <i>Register Map</i> table	48
• Added <i>ADS54J40 Access Type Codes</i> table.....	52
• Deleted legends from bit registers in <i>Register Descriptions</i> section.....	53
• Added register 1h and 2h to <i>Register Descriptions</i> section	53
• Added text '6100h = OFFSET READ or LOAD Page' to the JESD BANK PAGE SEL[7:0] bit description.....	53
• Changed description of <i>Registers 3h and 4h</i> (address = 3h and 4h)in <i>General Registers Page</i>	54
• Changed description of bit 0 in Register 4Fh (address = 4Fh), Master Page (080h).....	58
• Changed <i>Register 53H</i>	59
• Changed <i>Register 54H</i>	59
• Changed <i>Register 55H</i>	60
• Added <i>Register 40h</i>	62
• Changed <i>Register 4Eh</i>	67
• Changed <i>Register 52h</i>	67
• Added <i>Register 68h</i>	68
• Changed the <i>Register ABh</i> description.....	69
• Changed bit 1 from 0 to <i>ALWAYS WRITE 1</i> in Register 12h (address = 12h), JESD Analog Page (6A00h)...	76
• Changed <i>Register 1Ah</i>	79
• Added <i>Offset Read Page Register</i> and <i>Offset Load Page Register</i> sections to <i>Register Descriptions</i> section... 81	
• Changed <i>Register 075h, 077h, 079h, 7Bh</i> (address = 075h, 077h, 079h, 7Bh	82
• Changed <i>Register 00h, 04h, 08h, 0Ch</i>	83
• Changed <i>Register 01h, 05h, 09h, 0Dh</i>	83
• Added <i>Register 78h</i>	84
• Added <i>DC Offset Correction Block</i> in the <i>ADS54J40</i> section.....	89
• Added <i>Idle Channel Histogram</i> section.....	93
• Added the <i>Interleaving (IL) Mismatch Compensation</i> section.....	94
• Changed the description in Transformer-Coupled Circuits section.....	104
• Changed the <i>Layout Guidelines</i>	107

Changes from Revision A (October 2015) to Revision B (January 2017)

Page

• Added the <i>Device Comparison Table</i>	5
• Added CDM row to <i>ESD Ratings</i> table.....	8
• Changed the minimum value for the input clock frequency in the <i>Recommended Operating Conditions</i> table .. 9	
• Changed Sample Timing, <i>Aperture jitter</i> parameter typical specification in <i>Timing Characteristics</i> section.....	16
• Added the FOVR latency parameter to the <i>Timing Characteristics</i> table.....	16
• Changed <i>Overview</i> section	27
• Changed <i>Functional Block Diagram</i> section: changed Control and SPI block and added dashed outline to FOVR traces.....	27
• Changed <i>SYSREF Signal</i> section: changed 表 8-4 and added last paragraph.....	34
• Added <i>SYSREF Not Present (Subclass 0, 2)</i> section.....	34
• Changed the number of clock cycles in the <i>Fast OVR</i> section.....	35
• Deleted <i>Lane Enable with Decimation</i> subsection	45
• Added the <i>Program Summary of DDC Modes and JESD Link Configuration</i> table.....	45
• Added 图 8-27 to <i>Register Maps</i> section.....	48
• Changed the <i>Register Map</i>	48
• Deleted register 39h, 3Ah, and 56h	48
• Added 表 8-63	71
• Changed <i>Power Supply Recommendations</i> section	106
• Added the <i>Power Sequencing and Initialization</i> section.....	106

-
- Added the *Receiving Notification of Documentation Updates* section..... 108
-

Changes from Revision * (May 2015) to Revision A (October 2015) Page

- 已投入量产..... 1
-

5 ADS54J40 Comparison

表 5-1 lists companion devices to the ADS54J40 .(TBD: Why has it been shifted to this place?)

表 5-1. Device Comparison Table

PART NUMBER	SPEED GRADE (MSPS)	RESOLUTION (Bits)	CHANNEL
ADS54J20	1000	12	2
ADS54J42	625	14	2
ADS54J40	1000	14	2
ADS54J60	1000	16	2
ADS54J66	500	14	4
ADS54J69	500	16	2

6 Pin Configuration and Functions



图 6-1. RMP Package, 72-Pin VQFN, Top View

表 6-1. Pin Functions

PIN		I/O	DESCRIPTION
NAME	NO.		
CLOCK, SYSREF			
CLKINM	28	I	Negative differential clock input for the ADC.
CLKINP	27	I	Positive differential clock input for the ADC.
SYSREFM	34	I	Negative external SYSREF input. Connect this pin to GND if not used.
SYSREFF	33	I	Positive external SYSREF input. Connect this pin to 1.8 V if not used.
CONTROL, SERIAL			
PDN	50	I/O	Power down, active low pin. Can be configured via an SPI register setting. Can be configured to fast overrange output for channel A through the SPI. This pin has an internal 20k Ω pulldown resistor.
RESET	48	I	Hardware reset; active high. This pin has an internal 20-k Ω pulldown resistor.
SCLK	6	I	Serial interface clock input

表 6-1. Pin Functions (continued)

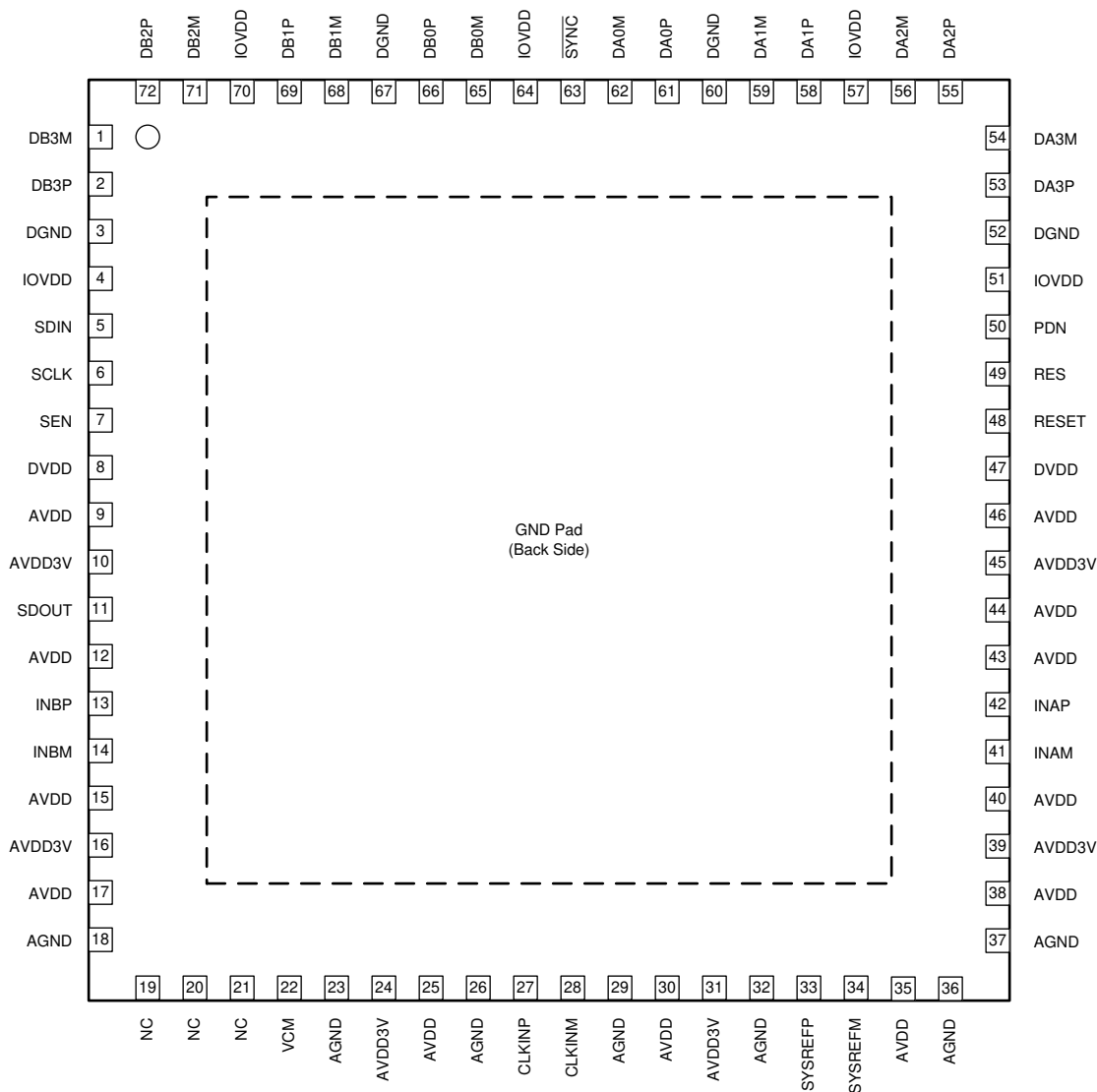
PIN		I/O	DESCRIPTION
NAME	NO.		
SDIN	5	I	Serial interface data input
SDOUT	11	O	Serial interface data output. Can be configured to fast overrange output for channel B through the SPI.
SEN	7	I	Serial interface enable
DATA INTERFACE			
DA0M	62	O	JESD204B serial data negative outputs for channel A
DA1M	59		
DA2M	56		
DA3M	54		
DA0P	61	O	JESD204B serial data positive outputs for channel A
DA1P	58		
DA2P	55		
DA3P	53		
DB0M	65	O	JESD204B serial data negative outputs for channel B
DB1M	68		
DB2M	71		
DB3M	1		
DB0P	66	O	JESD204B serial data positive outputs for channel B
DB1P	69		
DB2P	72		
DB3P	2		
SYNC	63	I	Synchronization input for the JESD204B port
INPUT, COMMON MODE			
INAM	41	I	Differential analog negative input for channel A
INAP	42	I	Differential analog positive input for channel A
INBM	14	I	Differential analog negative input for channel B
INBP	13	I	Differential analog positive input for channel B
VCM	22	O	Common-mode voltage, 2.1 V. Note that analog inputs are internally biased to this pin through 600 Ω (effective), no external connection from the VCM pin to the INxP or INxM pin is required.
POWER SUPPLY			
AGND	18, 23, 26, 29, 32, 36, 37	I	Analog ground
AVDD	9, 12, 15, 17, 25, 30, 35, 38, 40, 43, 44, 46	I	Analog 1.9-V power supply
AVDD3V	10, 16, 24, 31, 39, 45	I	Analog 3.0-V power supply for the analog buffer
DGND	3, 52, 60, 67	I	Digital ground
DVDD	8, 47	I	Digital 1.9-V power supply
IOVDD	4, 51, 57, 64, 70	I	Digital 1.15-V power supply for the JESD204B transmitter
NC, RES			
NC	19-21	—	Unused pins, do not connect
RES	49	I	Reserved pin. Connect to DGND.

7 Specifications

7.1 Absolute Maximum Ratings

over operating free-air temperature range (unless otherwise noted)⁽¹⁾

		MIN	MAX	UNIT
Supply voltage range	AVDD3V	- 0.3	3.6	V
	AVDD	- 0.3	2.1	
	DVDD	- 0.3	2.1	
	IOVDD	- 0.2	1.4	
Voltage between AGND and DGND		- 0.3	0.3	V
Voltage applied to input pins	INAP, INBP, INAM, INBM	- 0.3	3	V
	CLKINP, CLKINM	- 0.3	AVDD + 0.3	
	SYSREFP, SYSREFM	- 0.3	AVDD + 0.3	
	SCLK, SEN, SDIN, RESET, SYNC, PDN	- 0.2	2.1	
Storage temperature, T _{stg}		- 65	150	°C

- (1) Stresses beyond those listed under *Absolute Maximum Ratings* may cause permanent damage to the device. These are stress ratings only, which do not imply functional operation of the device at these or any other conditions beyond those indicated under *Recommended Operating Conditions*. Exposure to absolute-maximum-rated conditions for extended periods may affect device reliability.

7.2 ESD Ratings

		VALUE	UNIT
V _(ESD) Electrostatic discharge	Human-body model (HBM), per ANSI/ESDA/JEDEC JS-001 ⁽¹⁾	±1000	V
	Charged-device model (CDM), per JEDEC specification JESD22-C101 ⁽²⁾	±500	

- (1) JEDEC document JEP155 states that 500-V HBM allows safe manufacturing with a standard ESD control process.
 (2) JEDEC document JEP157 states that 250-V HBM allows safe manufacturing with a standard ESD control process.

7.3 Recommended Operating Conditions

over operating free-air temperature range (unless otherwise noted)^{(2) (3)}

		MIN	NOM	MAX	UNIT
Supply voltage range	AVDD3V	2.85	3	3.6	V
	AVDD	1.8	1.9	2.0	
	DVDD	1.7	1.9	2.0	
	IOVDD	1.1	1.15	1.2	
Analog inputs	Differential input voltage range	1.9			V _{PP}
	Input common-mode voltage	2			V
	Maximum analog input frequency for 1.9-V _{PP} input amplitude ^{(4) (5)}	400			MHz
Clock inputs	Input clock frequency, device clock frequency	250 ⁽⁶⁾		1000	MHz
	Input clock amplitude differential (V _{CLKP} - V _{CLKM})	Sine wave, ac-coupled	0.75	1.5	V _{PP}
		LVPECL, ac-coupled	0.8	1.6	
		LVDS, ac-coupled	0.7		
Input device clock duty cycle	45%	50%	55%		
Temperature	Operating free-air, T _A	- 40			°C
	Operating junction, T _J	105 ⁽¹⁾		125	

- (1) Prolonged use above the nominal junction temperature can increase the device failure-in-time (FIT) rate.
- (2) SYSREF must be applied for the device to initialize; see the [SYSREF Signal](#) section for details.
- (3) After power-up, always use a hardware reset to reset the device for the first time; see [表 9-1](#) for details.
- (4) Operating 0.5 dB below the maximum-supported amplitude is recommended to accommodate gain mismatch in interleaving ADCs.
- (5) At high frequencies, the maximum supported input amplitude reduces; see [图 7-37](#) for details.
- (6) See [表 8-10](#).

7.4 Thermal Information

THERMAL METRIC ⁽¹⁾		ADS54J40	UNIT
		RMP (VQFN ^P)	
		72 PINS	
R _{θJA}	Junction-to-ambient thermal resistance	22.3	°C/W
R _{θJC(top)}	Junction-to-case (top) thermal resistance	5.1	°C/W
R _{θJB}	Junction-to-board thermal resistance	2.4	°C/W
ψ _{JT}	Junction-to-top characterization parameter	0.1	°C/W
ψ _{JB}	Junction-to-board characterization parameter	2.3	°C/W
R _{θJC(bot)}	Junction-to-case (bottom) thermal resistance	0.4	°C/W

- (1) For more information about traditional and new thermal metrics, see the [Semiconductor and IC Package Thermal Metrics](#) application report (SPRA953).

7.5 Electrical Characteristics

Typical values are at $T_A = 25^\circ\text{C}$, full temperature range is from $T_{\text{MIN}} = -40^\circ\text{C}$ to $T_{\text{MAX}} = 85^\circ\text{C}$, ADC sampling rate = 1 GSPS, 50% clock duty cycle, AVDD3V = 3 V, AVDD = DVDD = 1.9 V, IOVDD = 1.15 V, -1-dBFS differential input, and 0-dB digital gain (unless otherwise noted)

PARAMETER		TEST CONDITIONS	MIN	TYP	MAX	UNIT
GENERAL						
ADC sampling rate			250		1000	MSPS
Resolution			14			Bits
POWER SUPPLIES						
AVDD3V	3.0-V analog supply		2.85	3.0	3.6	V
AVDD	1.9-V analog supply		1.8	1.9	2.0	V
DVDD	1.9-V digital supply		1.7	1.9	2.0	V
IOVDD	1.15-V SERDES supply		1.1	1.15	1.2	V
I _{AVDD3V}	3.0-V analog supply current	V _{IN} = full-scale on both channels		334	360	mA
I _{AVDD}	1.9-V analog supply current	V _{IN} = full-scale on both channels		359	510	mA
I _{DVDD}	1.9-V digital supply current	Eight lanes active (LMFS = 8224)		197	260	mA
I _{IOVDD}	1.15-V SERDES supply current	Eight lanes active (LMFS = 8224)		566	920	mA
P _{dis}	Total power dissipation	Eight lanes active (LMFS = 8224)		2.71	3.1	W
I _{DVDD}	1.9-V digital supply current	Four lanes active (LMFS = 4244)		211		mA
I _{IOVDD}	1.15-V SERDES supply current	Four lanes active (LMFS = 4244)		618		mA
P _{dis}	Total power dissipation	Four lanes active (LMFS = 4244)		2.80		W
I _{DVDD}	1.9-V digital supply current	Four lanes active (LMFS = 4222), 2X decimation		197		mA
I _{IOVDD}	1.15-V SERDES supply current	Four lanes active (LMFS = 4222), 2X decimation		593		mA
P _{dis}	Total power dissipation	Four lanes active (LMFS = 4222), 2X decimation		2.74		W
I _{DVDD}	1.9-V digital supply current	Two lanes active (LMFS = 2221), 4X decimation		176		mA
I _{IOVDD}	1.15-V SERDES supply current	Two lanes active (LMFS = 2221), 4X decimation		562		mA
P _{dis} ⁽¹⁾	Total power dissipation	Two lanes active (LMFS = 2221), 4X decimation		2.66		W
Global power-down power dissipation				139	315	mW
ANALOG INPUTS (INAP, INAM, INBP, INBM)						
Differential input full-scale voltage				1.9		V _{PP}
V _{IC}	Common-mode input voltage			2.0		V
R _{IN}	Differential input resistance	At 170-MHz input frequency		0.6		k Ω
C _{IN}	Differential input capacitance	At 170-MHz input frequency		4.7		pF
Analog input bandwidth (3 dB)		50- Ω source driving ADC inputs terminated with 50 Ω		1.2		GHz
CLOCK INPUT (CLKINP, CLKINM)						
Internal clock biasing		CLKINP and CLKINM are connected to internal biasing voltage through 400 Ω		1.15		V

(1) See the [Power-down Mode](#) section for details.

7.6 AC Characteristics

Typical values are at $T_A = 25^\circ\text{C}$, full temperature range is from $T_{\text{MIN}} = -40^\circ\text{C}$ to $T_{\text{MAX}} = 85^\circ\text{C}$, ADC sampling rate = 1 GSPS, 50% clock duty cycle, $AVDD3V = 3\text{ V}$, $AVDD = DVDD = 1.9\text{ V}$, $IOVDD = 1.15\text{ V}$, -1-dBFS differential input, and 0-dB digital gain (unless otherwise noted)

PARAMETER		TEST CONDITIONS	MIN	TYP	MAX	UNIT
SNR	Signal-to-noise ratio	$f_{\text{IN}} = 10\text{ MHz}, A_{\text{IN}} = -1\text{ dBFS}$		69.7		dBFS
		$f_{\text{IN}} = 100\text{ MHz}, A_{\text{IN}} = -1\text{ dBFS}$		69.5		
		$f_{\text{IN}} = 170\text{ MHz}, A_{\text{IN}} = -1\text{ dBFS}$	66.2	68.9		
		$f_{\text{IN}} = 230\text{ MHz}, A_{\text{IN}} = -1\text{ dBFS}$		68.4		
		$f_{\text{IN}} = 270\text{ MHz}, A_{\text{IN}} = -1\text{ dBFS}$		67.9		
		$f_{\text{IN}} = 300\text{ MHz}, A_{\text{IN}} = -1\text{ dBFS}$		67.5		
		$f_{\text{IN}} = 370\text{ MHz}, A_{\text{IN}} = -1\text{ dBFS}$		66.5		
		$f_{\text{IN}} = 470\text{ MHz}, A_{\text{IN}} = -3\text{ dBFS}$		66.5		
		$f_{\text{IN}} = 720\text{ MHz}, A_{\text{IN}} = -6\text{ dBFS}$		64.9		
		$f_{\text{IN}} = 720\text{ MHz}, A_{\text{IN}} = -6\text{ dBFS},$ gain = 5 dB		63.3		
NSD	Noise spectral density	$f_{\text{IN}} = 10\text{ MHz}, A_{\text{IN}} = -1\text{ dBFS}$		156.7		dBFS/Hz
		$f_{\text{IN}} = 100\text{ MHz}, A_{\text{IN}} = -1\text{ dBFS}$		156.5		
		$f_{\text{IN}} = 170\text{ MHz}, A_{\text{IN}} = -1\text{ dBFS}$	153.2	155.9		
		$f_{\text{IN}} = 230\text{ MHz}, A_{\text{IN}} = -1\text{ dBFS}$		155.4		
		$f_{\text{IN}} = 270\text{ MHz}, A_{\text{IN}} = -1\text{ dBFS}$		154.9		
		$f_{\text{IN}} = 300\text{ MHz}, A_{\text{IN}} = -1\text{ dBFS}$		154.5		
		$f_{\text{IN}} = 370\text{ MHz}, A_{\text{IN}} = -1\text{ dBFS}$		153.5		
		$f_{\text{IN}} = 470\text{ MHz}, A_{\text{IN}} = -3\text{ dBFS}$		153.5		
		$f_{\text{IN}} = 720\text{ MHz}, A_{\text{IN}} = -6\text{ dBFS}$		151.9		
		$f_{\text{IN}} = 720\text{ MHz}, A_{\text{IN}} = -6\text{ dBFS},$ gain = 5 dB		150.3		
SINAD	Signal-to-noise and distortion ratio	$f_{\text{IN}} = 10\text{ MHz}, A_{\text{IN}} = -1\text{ dBFS}$		69.6		dBFS
		$f_{\text{IN}} = 100\text{ MHz}, A_{\text{IN}} = -1\text{ dBFS}$		69.3		
		$f_{\text{IN}} = 170\text{ MHz}, A_{\text{IN}} = -1\text{ dBFS}$	65.2	68.8		
		$f_{\text{IN}} = 230\text{ MHz}, A_{\text{IN}} = -1\text{ dBFS}$		68.3		
		$f_{\text{IN}} = 270\text{ MHz}, A_{\text{IN}} = -1\text{ dBFS}$		67.6		
		$f_{\text{IN}} = 300\text{ MHz}, A_{\text{IN}} = -1\text{ dBFS}$		67		
		$f_{\text{IN}} = 370\text{ MHz}, A_{\text{IN}} = -1\text{ dBFS}$		65.5		
		$f_{\text{IN}} = 470\text{ MHz}, A_{\text{IN}} = -3\text{ dBFS}$		65.7		
		$f_{\text{IN}} = 720\text{ MHz}, A_{\text{IN}} = -6\text{ dBFS}$		64.1		
		$f_{\text{IN}} = 720\text{ MHz}, A_{\text{IN}} = -6\text{ dBFS},$ gain = 5 dB		63.2		

7.6 AC Characteristics (continued)

Typical values are at $T_A = 25^\circ\text{C}$, full temperature range is from $T_{\text{MIN}} = -40^\circ\text{C}$ to $T_{\text{MAX}} = 85^\circ\text{C}$, ADC sampling rate = 1 GSPS, 50% clock duty cycle, AVDD3V = 3 V, AVDD = DVDD = 1.9 V, IOVDD = 1.15 V, -1-dBFS differential input, and 0-dB digital gain (unless otherwise noted)

PARAMETER		TEST CONDITIONS	MIN	TYP	MAX	UNIT
SFDR	Spurious free dynamic range (excluding IL spurs)	$f_{\text{IN}} = 100 \text{ MHz}, A_{\text{IN}} = -1 \text{ dBFS}$		83		dBc
		$f_{\text{IN}} = 170 \text{ MHz}, A_{\text{IN}} = -1 \text{ dBFS}$	76	86		
		$f_{\text{IN}} = 230 \text{ MHz}, A_{\text{IN}} = -1 \text{ dBFS}$		85		
		$f_{\text{IN}} = 270 \text{ MHz}, A_{\text{IN}} = -1 \text{ dBFS}$		81		
		$f_{\text{IN}} = 300 \text{ MHz}, A_{\text{IN}} = -1 \text{ dBFS}$		78		
		$f_{\text{IN}} = 370 \text{ MHz}, A_{\text{IN}} = -1 \text{ dBFS}$		73		
		$f_{\text{IN}} = 470 \text{ MHz}, A_{\text{IN}} = -3 \text{ dBFS}$		71		
		$f_{\text{IN}} = 720 \text{ MHz}, A_{\text{IN}} = -6 \text{ dBFS}$		67		
		$f_{\text{IN}} = 720 \text{ MHz}, A_{\text{IN}} = -6 \text{ dBFS},$ gain = 5 dB		71		
HD2	Second-order harmonic distortion	$f_{\text{IN}} = 10 \text{ MHz}, A_{\text{IN}} = -1 \text{ dBFS}$		85		dBc
		$f_{\text{IN}} = 100 \text{ MHz}, A_{\text{IN}} = -1 \text{ dBFS}$		90		
		$f_{\text{IN}} = 170 \text{ MHz}, A_{\text{IN}} = -1 \text{ dBFS}$	76	92		
		$f_{\text{IN}} = 230 \text{ MHz}, A_{\text{IN}} = -1 \text{ dBFS}$		85		
		$f_{\text{IN}} = 270 \text{ MHz}, A_{\text{IN}} = -1 \text{ dBFS}$		81		
		$f_{\text{IN}} = 300 \text{ MHz}, A_{\text{IN}} = -1 \text{ dBFS}$		81		
		$f_{\text{IN}} = 370 \text{ MHz}, A_{\text{IN}} = -1 \text{ dBFS}$		76		
		$f_{\text{IN}} = 470 \text{ MHz}, A_{\text{IN}} = -3 \text{ dBFS}$		71		
		$f_{\text{IN}} = 720 \text{ MHz}, A_{\text{IN}} = -6 \text{ dBFS}$		67		
		$f_{\text{IN}} = 720 \text{ MHz}, A_{\text{IN}} = -6 \text{ dBFS},$ gain = 5 dB		71		
HD3	Third-order harmonic distortio	$f_{\text{IN}} = 10 \text{ MHz}, A_{\text{IN}} = -1 \text{ dBFS}$		85		dBc
		$f_{\text{IN}} = 100 \text{ MHz}, A_{\text{IN}} = -1 \text{ dBFS}$		83		
		$f_{\text{IN}} = 170 \text{ MHz}, A_{\text{IN}} = -1 \text{ dBFS}$	76	86		
		$f_{\text{IN}} = 230 \text{ MHz}, A_{\text{IN}} = -1 \text{ dBFS}$		87		
		$f_{\text{IN}} = 270 \text{ MHz}, A_{\text{IN}} = -1 \text{ dBFS}$		81		
		$f_{\text{IN}} = 300 \text{ MHz}, A_{\text{IN}} = -1 \text{ dBFS}$		78		
		$f_{\text{IN}} = 370 \text{ MHz}, A_{\text{IN}} = -1 \text{ dBFS}$		73		
		$f_{\text{IN}} = 470 \text{ MHz}, A_{\text{IN}} = -3 \text{ dBFS}$		71		
		$f_{\text{IN}} = 720 \text{ MHz}, A_{\text{IN}} = -6 \text{ dBFS}$		74		
		$f_{\text{IN}} = 720 \text{ MHz}, A_{\text{IN}} = -6 \text{ dBFS},$ gain = 5 dB		83		

7.6 AC Characteristics (continued)

Typical values are at $T_A = 25^\circ\text{C}$, full temperature range is from $T_{\text{MIN}} = -40^\circ\text{C}$ to $T_{\text{MAX}} = 85^\circ\text{C}$, ADC sampling rate = 1 GSPS, 50% clock duty cycle, $AVDD3V = 3\text{ V}$, $AVDD = DVDD = 1.9\text{ V}$, $IOVDD = 1.15\text{ V}$, -1-dBFS differential input, and 0-dB digital gain (unless otherwise noted)

PARAMETER		TEST CONDITIONS	MIN	TYP	MAX	UNIT
Non HD2, HD3	Spurious-free dynamic range (excluding HD2, HD3, and IL spur)	$f_{\text{IN}} = 10\text{ MHz}$, $A_{\text{IN}} = -1\text{ dBFS}$		94		dBFS
		$f_{\text{IN}} = 100\text{ MHz}$, $A_{\text{IN}} = -1\text{ dBFS}$		97		
		$f_{\text{IN}} = 170\text{ MHz}$, $A_{\text{IN}} = -1\text{ dBFS}$	79	93		
		$f_{\text{IN}} = 230\text{ MHz}$, $A_{\text{IN}} = -1\text{ dBFS}$		95		
		$f_{\text{IN}} = 270\text{ MHz}$, $A_{\text{IN}} = -1\text{ dBFS}$		95		
		$f_{\text{IN}} = 300\text{ MHz}$, $A_{\text{IN}} = -1\text{ dBFS}$		91		
		$f_{\text{IN}} = 370\text{ MHz}$, $A_{\text{IN}} = -1\text{ dBFS}$		85		
		$f_{\text{IN}} = 470\text{ MHz}$, $A_{\text{IN}} = -3\text{ dBFS}$		89		
		$f_{\text{IN}} = 720\text{ MHz}$, $A_{\text{IN}} = -6\text{ dBFS}$		89		
		$f_{\text{IN}} = 720\text{ MHz}$, $A_{\text{IN}} = -6\text{ dBFS}$, gain = 5 dB		93		
ENOB	Effective number of bits	$f_{\text{IN}} = 10\text{ MHz}$, $A_{\text{IN}} = -1\text{ dBFS}$		11.3		Bits
		$f_{\text{IN}} = 100\text{ MHz}$, $A_{\text{IN}} = -1\text{ dBFS}$		11.2		
		$f_{\text{IN}} = 170\text{ MHz}$, $A_{\text{IN}} = -1\text{ dBFS}$	10.5	11.1		
		$f_{\text{IN}} = 230\text{ MHz}$, $A_{\text{IN}} = -1\text{ dBFS}$		11.1		
		$f_{\text{IN}} = 270\text{ MHz}$, $A_{\text{IN}} = -1\text{ dBFS}$		10.9		
		$f_{\text{IN}} = 300\text{ MHz}$, $A_{\text{IN}} = -1\text{ dBFS}$		10.8		
		$f_{\text{IN}} = 370\text{ MHz}$, $A_{\text{IN}} = -1\text{ dBFS}$		10.6		
		$f_{\text{IN}} = 470\text{ MHz}$, $A_{\text{IN}} = -3\text{ dBFS}$		10.6		
		$f_{\text{IN}} = 720\text{ MHz}$, $A_{\text{IN}} = -6\text{ dBFS}$		10.4		
		$f_{\text{IN}} = 720\text{ MHz}$, $A_{\text{IN}} = -6\text{ dBFS}$, gain = 5 dB		10.2		
THD	Total harmonic distortion	$f_{\text{IN}} = 10\text{ MHz}$, $A_{\text{IN}} = -1\text{ dBFS}$		82		dBc
		$f_{\text{IN}} = 100\text{ MHz}$, $A_{\text{IN}} = -1\text{ dBFS}$		80		
		$f_{\text{IN}} = 170\text{ MHz}$, $A_{\text{IN}} = -1\text{ dBFS}$	73	83		
		$f_{\text{IN}} = 230\text{ MHz}$, $A_{\text{IN}} = -1\text{ dBFS}$		82		
		$f_{\text{IN}} = 270\text{ MHz}$, $A_{\text{IN}} = -1\text{ dBFS}$		78		
		$f_{\text{IN}} = 300\text{ MHz}$, $A_{\text{IN}} = -1\text{ dBFS}$		75		
		$f_{\text{IN}} = 370\text{ MHz}$, $A_{\text{IN}} = -1\text{ dBFS}$		70		
		$f_{\text{IN}} = 470\text{ MHz}$, $A_{\text{IN}} = -3\text{ dBFS}$		70		
		$f_{\text{IN}} = 720\text{ MHz}$, $A_{\text{IN}} = -6\text{ dBFS}$		66		
		$f_{\text{IN}} = 720\text{ MHz}$, $A_{\text{IN}} = -6\text{ dBFS}$, gain = 5 dB		70		

7.6 AC Characteristics (continued)

Typical values are at $T_A = 25^\circ\text{C}$, full temperature range is from $T_{\text{MIN}} = -40^\circ\text{C}$ to $T_{\text{MAX}} = 85^\circ\text{C}$, ADC sampling rate = 1 GSPS, 50% clock duty cycle, AVDD3V = 3 V, AVDD = DVDD = 1.9 V, IOVDD = 1.15 V, -1-dBFS differential input, and 0-dB digital gain (unless otherwise noted)

PARAMETER		TEST CONDITIONS	MIN	TYP	MAX	UNIT
SFDR_IL	Interleaving spur	$f_{\text{IN}} = 10 \text{ MHz}, A_{\text{IN}} = -1 \text{ dBFS}$		85		dBc
		$f_{\text{IN}} = 100 \text{ MHz}, A_{\text{IN}} = -1 \text{ dBFS}$		84		
		$f_{\text{IN}} = 170 \text{ MHz}, A_{\text{IN}} = -1 \text{ dBFS}$	69	83		
		$f_{\text{IN}} = 230 \text{ MHz}, A_{\text{IN}} = -1 \text{ dBFS}$		82		
		$f_{\text{IN}} = 270 \text{ MHz}, A_{\text{IN}} = -1 \text{ dBFS}$		81		
		$f_{\text{IN}} = 300 \text{ MHz}, A_{\text{IN}} = -1 \text{ dBFS}$		81		
		$f_{\text{IN}} = 370 \text{ MHz}, A_{\text{IN}} = -1 \text{ dBFS}$		77		
		$f_{\text{IN}} = 470 \text{ MHz}, A_{\text{IN}} = -3 \text{ dBFS}$		78		
		$f_{\text{IN}} = 720 \text{ MHz}, A_{\text{IN}} = -6 \text{ dBFS}$		78		
		$f_{\text{IN}} = 720 \text{ MHz}, A_{\text{IN}} = -6 \text{ dBFS},$ gain = 5 dB		74		
IMD3	Two-tone, third-order intermodulation distortion	$f_{\text{IN1}} = 185 \text{ MHz}, f_{\text{IN2}} = 190 \text{ MHz},$ $A_{\text{IN}} = -7 \text{ dBFS}$		-89		dBFS
		$f_{\text{IN1}} = 365 \text{ MHz}, f_{\text{IN2}} = 370 \text{ MHz},$ $A_{\text{IN}} = -7 \text{ dBFS}$		-79		
		$f_{\text{IN1}} = 465 \text{ MHz}, f_{\text{IN2}} = 470 \text{ MHz},$ $A_{\text{IN}} = -7 \text{ dBFS}$		-75		
Crosstalk	Isolation between channel A and B	Full-scale, 170-MHz signal on aggressor; idle channel is victim		100		dB

7.7 Digital Characteristics

Typical values are at $T_A = 25^\circ\text{C}$, full temperature range is from $T_{\text{MIN}} = -40^\circ\text{C}$ to $T_{\text{MAX}} = 85^\circ\text{C}$, ADC sampling rate = 1 GSPS, 50% clock duty cycle, $\text{AVDD3V} = 3\text{ V}$, $\text{AVDD} = \text{DVDD} = 1.9\text{ V}$, $\text{IOVDD} = 1.15\text{ V}$, -1-dBFS differential input, and 0-dB digital gain (unless otherwise noted)

PARAMETER		TEST CONDITIONS	MIN	TYP	MAX	UNITS
DIGITAL INPUTS (RESET, SCLK, SEN, SDIN, SYNC, PDN)⁽¹⁾						
V_{IH}	High-level input voltage	All digital inputs support 1.2-V and 1.8-V logic levels	0.8			V
V_{IL}	Low-level input voltage	All digital inputs support 1.2-V and 1.8-V logic levels			0.4	V
I_{IH}	High-level input current	SEN		0		μA
		RESET, SCLK, SDIN, PDN, SYNC		50		
I_{IL}	Low-level input current	SEN		50		μA
		RESET, SCLK, SDIN, PDN, SYNC		0		
DIGITAL INPUTS (SYSREFP, SYSREFM)						
V_{D}	Differential input voltage		0.35	0.45	1.4	V
$V_{(\text{CM_DIG})}$	Common-mode voltage for SYSREF			1.3		V
DIGITAL OUTPUTS (SDOUT, PDN)⁽³⁾						
V_{OH}	High-level output voltage		$\text{DVDD} - 0.1$	DVDD		V
V_{OL}	Low-level output voltage				0.1	V
DIGITAL OUTPUTS (JESD204B Interface: DxP, DxM)⁽²⁾						
V_{OD}	Output differential voltage	With default swing setting		700		mV_{PP}
V_{OC}	Output common-mode voltage			450		mV
	Transmitter short-circuit current	Transmitter pins shorted to any voltage between -0.25 V and 1.45 V	-100		100	mA
Z_{os}	Single-ended output impedance			50		Ω
	Output capacitance	Output capacitance inside the device, from either output to ground		2		pF

- (1) The RESET, SCLK, SDIN, and PDN pins have a 20-k Ω (typical) internal pulldown resistor to ground, and the SEN pin has a 20-k Ω (typical) pullup resistor to IOVDD.
- (2) 100- Ω differential termination.
- (3) When functioning as an OVR pin for channel B.

7.8 Timing Requirements

Typical values are at $T_A = 25^\circ\text{C}$, full temperature range is from $T_{\text{MIN}} = -40^\circ\text{C}$ to $T_{\text{MAX}} = 85^\circ\text{C}$, ADC sampling rate = 1.0 GSPS, 50% clock duty cycle, AVDD3V = 3.0 V, AVDD = DVDD = 1.9 V, IOVDD = 1.15 V, and -1-dBFS differential input, unless otherwise noted.

	MIN	TYP	MAX	UNITS
SAMPLE TIMING (TBD are any of these Switching Characteristics?TBD: No)				
Aperture delay	0.75		1.6	ns
Aperture delay matching between two channels on the same device		± 70		ps
Aperture delay matching between two devices at the same temperature and supply voltage		± 270		ps
Aperture jitter		120		f_s rms
WAKE-UP TIMING				
Wake-up time to valid data after coming out of global power-down		150		μs
LATENCY (1)				
Data latency: ADC sample to digital output		134		Input clock cycles
OVR latency: ADC sample to OVR bit		62		Input clock cycles
FOVR latency: ADC sample to FOVR signal on pin		18		Input clock cycles
t_{PDI} Propagation delay: logic gates and output buffers delay (does not change with f_s)		4		ns
SYSREF TIMING				
$t_{\text{SU_SYSREF}}$ Setup time for SYSREF, referenced to the input clock falling edge	300		900	ps
$t_{\text{H_SYSREF}}$ Hold time for SYSREF, referenced to the input clock falling edge	100			ps
JESD OUTPUT INTERFACE TIMING CHARACTERISTICS				
Unit interval	100		400	ps
Serial output data rate	2.5		10	Gbps
Total jitter for BER of 1E-15 and lane rate = 10 Gbps		26		ps
Random jitter for BER of 1E-15 and lane rate = 10 Gbps		0.75		ps rms
Deterministic jitter for BER of 1E-15 and lane rate = 10 Gbps		12		ps, pk-pk
$t_{\text{R}}, t_{\text{F}}$ Data rise time, data fall time: rise and fall times are measured from 20% to 80%, differential output waveform, 2.5 Gbps \leq bit rate \leq 10 Gbps		35		ps

(1) Overall latency = latency + t_{PDI} .



图 7-1. SYSREF Timing



图 7-2. Sample Timing Requirements

7.9 Typical Characteristics

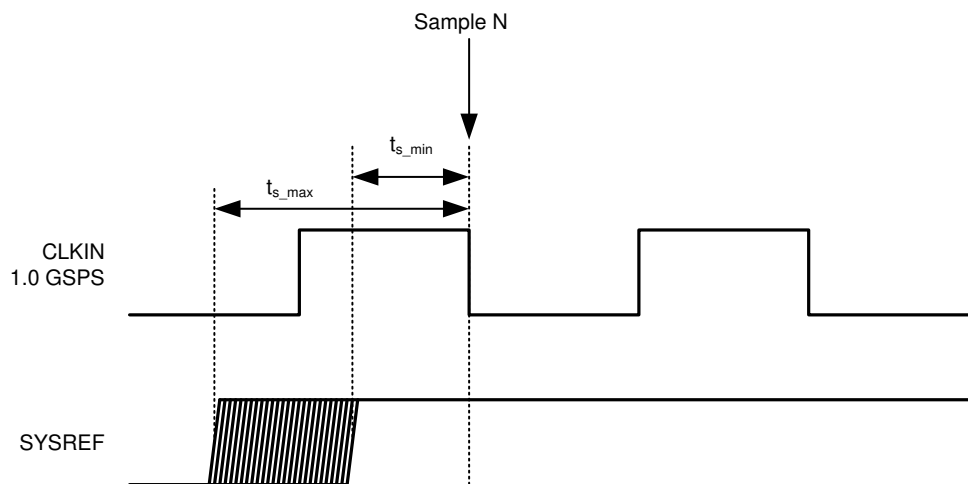
Typical values are at $T_A = 25^\circ\text{C}$, full temperature range is from $T_{\text{MIN}} = -40^\circ\text{C}$ to $T_{\text{MAX}} = 85^\circ\text{C}$, ADC sampling rate = 1.0 GSPS, 50% clock duty cycle, $AV_{\text{DD}3\text{V}} = 3.0\text{ V}$, $AV_{\text{DD}} = DV_{\text{DD}} = 1.9\text{ V}$, $IOV_{\text{DD}} = 1.15\text{ V}$, and -1-dBFS differential input, unless otherwise noted.

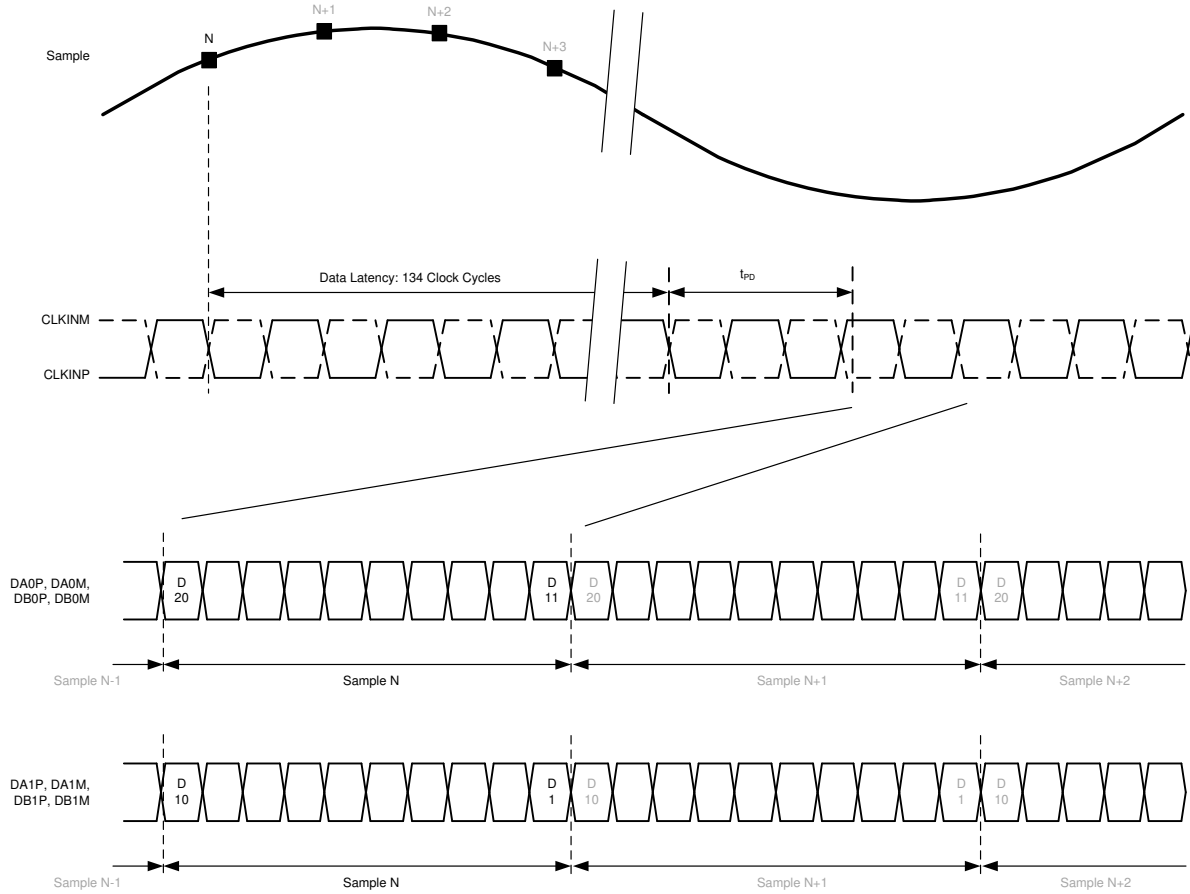
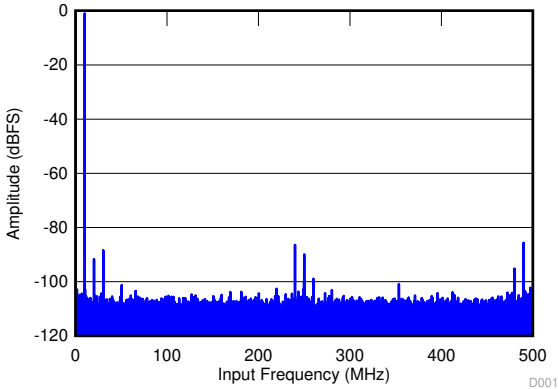

SNR = 69.7 dBFS; SFDR = 85 dBc; IL spur = 86 dBc; non HD2, HD3 spur = 89 dBc

图 7-3. FFT for 10-MHz Input Signal

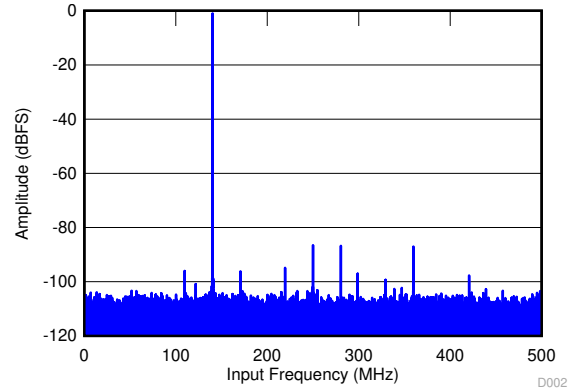

SNR = 69.2 dBFS; SFDR = 86 dBc; IL spur = 85 dBc; non HD2, HD3 spur = 94 dBc

图 7-4. FFT for 140-MHz Input Signal

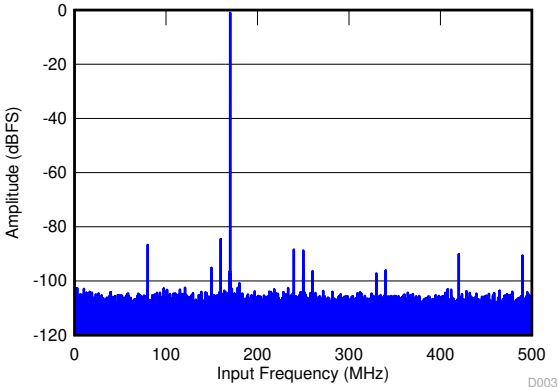

SNR = 68.9 dBFS; SFDR = 86 dBc; IL spur = 84 dBc; non HD2, HD3 spur = 89 dBc

图 7-5. FFT for 170-MHz Input Signal

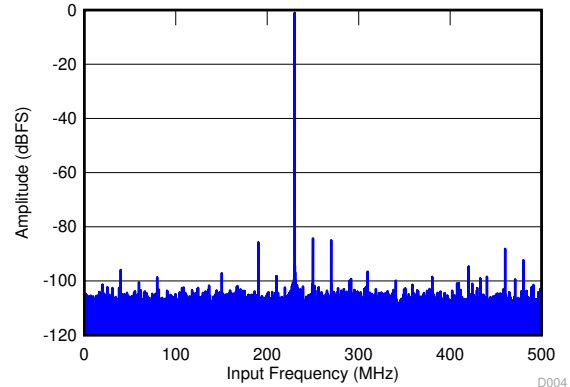

SNR = 68.1 dBFS; SFDR = 84 dBc; IL spur = 86 dBc; non HD2, HD3 spur = 86 dBc

图 7-6. FFT for 230-MHz Input Signal

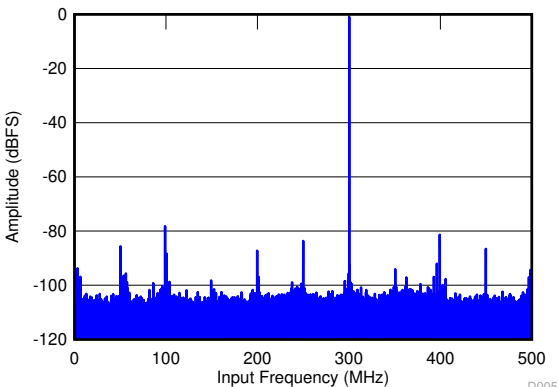

SNR = 67.4 dBFS; SFDR = 77 dBc; IL spur = 83 dBc; non HD2, HD3 spur = 85 dBc

图 7-7. FFT for 300-MHz Input Signal

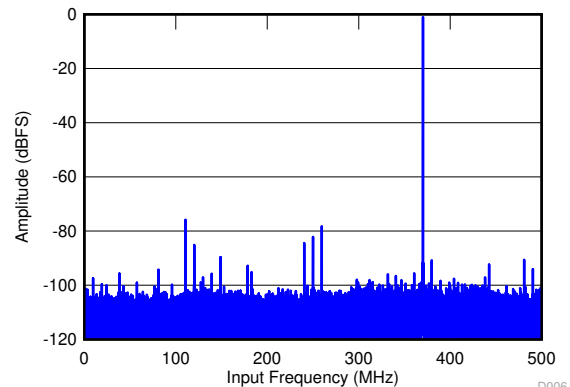

SNR = 66.2 dBFS; SFDR = 72 dBc; IL spur = 84 dBc; non HD2, HD3 spur = 78 dBc

图 7-8. FFT for 370-MHz Input Signal

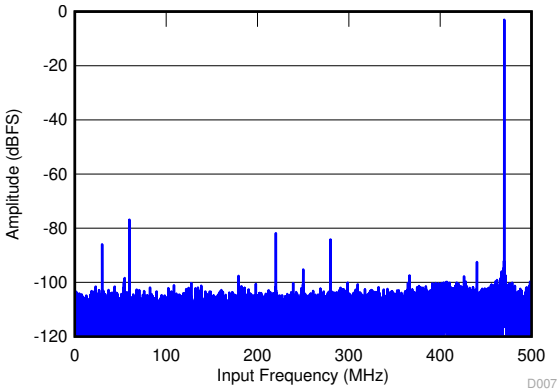

SNR = 66.5 dBFS; SFDR = 73 dBc; IL spur = 81 dBc; non HD2, HD3 spur = 88 dBc

图 7-9. FFT for 470-MHz Input Signal at - 3 dBFS

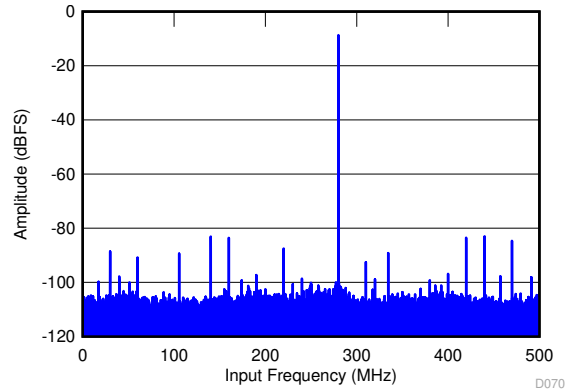

SNR = 65.3 dBFS; SFDR = 71 dBc; IL spur = 83 dBc; non HD2, HD3 spur = 89 dBFS

图 7-10. FFT for 720-MHz Input Signal at - 6 dBFS

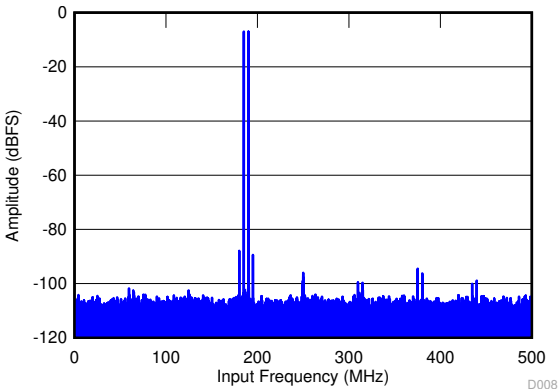

$f_{IN1} = 185$ MHz, $f_{IN2} = 190$ MHz, each tone at - 7 dBFS, IMD3 = 85 dBFS

图 7-11. FFT for Two-Tone Input Signal (- 7 dBFS)

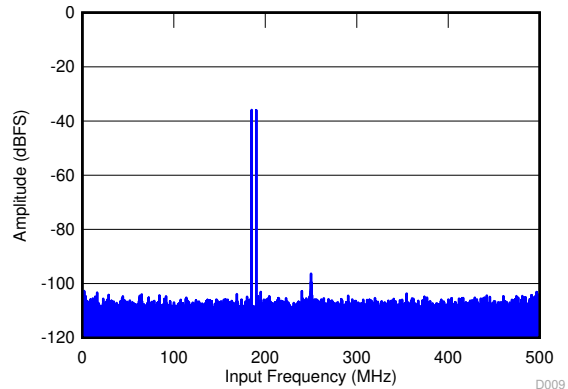

$f_{IN1} = 185$ MHz, $f_{IN2} = 190$ MHz, each tone at - 36 dBFS, IMD3 = 103 dBFS

图 7-12. FFT for Two-Tone Input Signal (- 36 dBFS)

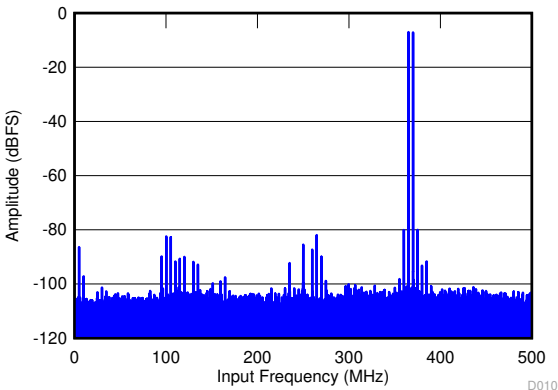

$f_{IN1} = 370$ MHz, $f_{IN2} = 365$ MHz, each tone at - 7 dBFS, IMD3 = 80 dBFS

图 7-13. FFT for Two-Tone Input Signal (- 7 dBFS)

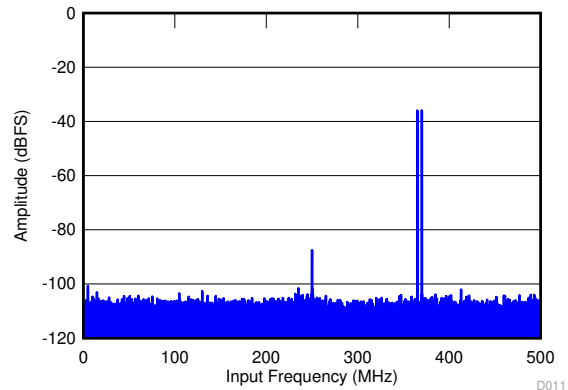

$f_{IN1} = 370$ MHz, $f_{IN2} = 365$ MHz, each tone at - 36 dBFS, IMD3 = 109 dBFS

图 7-14. FFT for Two-Tone Input Signal (- 36 dBFS)

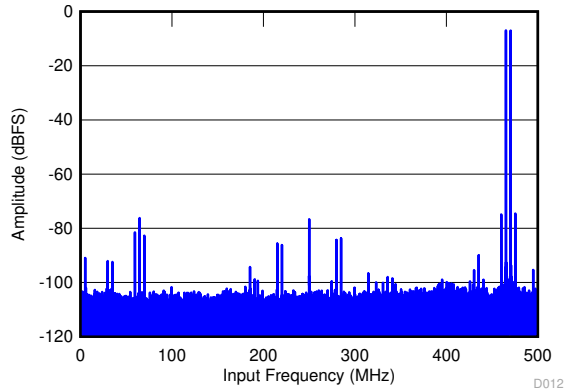

$f_{IN1} = 470 \text{ MHz}$, $f_{IN2} = 465 \text{ MHz}$, each tone at -7 dBFS , $\text{IMD3} = 74.9 \text{ dBFS}$

图 7-15. FFT for Two-Tone Input Signal (-7 dBFS)

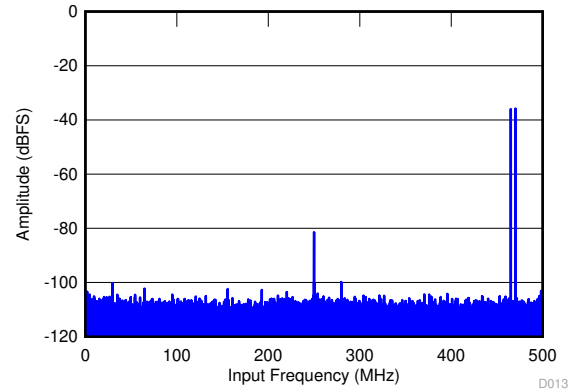

$f_{IN1} = 470 \text{ MHz}$, $f_{IN2} = 465 \text{ MHz}$, each tone at -36 dBFS , $\text{IMD3} = 109.2 \text{ dBFS}$

图 7-16. FFT for Two-Tone Input Signal (-36 dBFS)

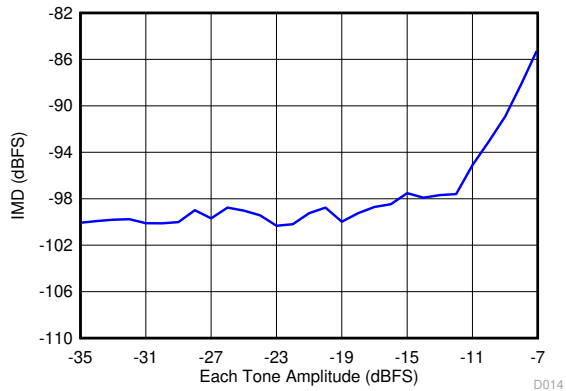

$f_{IN1} = 185 \text{ MHz}$, $f_{IN2} = 190 \text{ MHz}$

图 7-17. Intermodulation Distortion vs Input Tone Amplitude

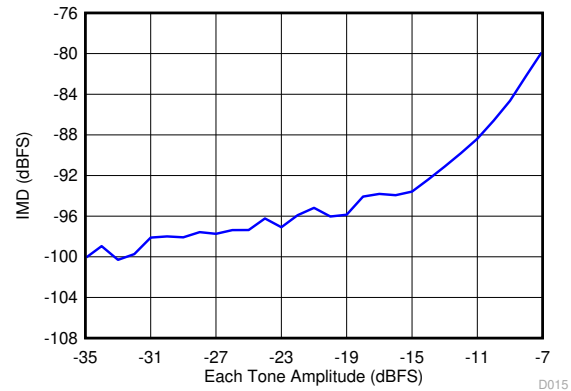

$f_{IN1} = 365 \text{ MHz}$, $f_{IN2} = 370 \text{ MHz}$

图 7-18. Intermodulation Distortion vs Input Tone Amplitude

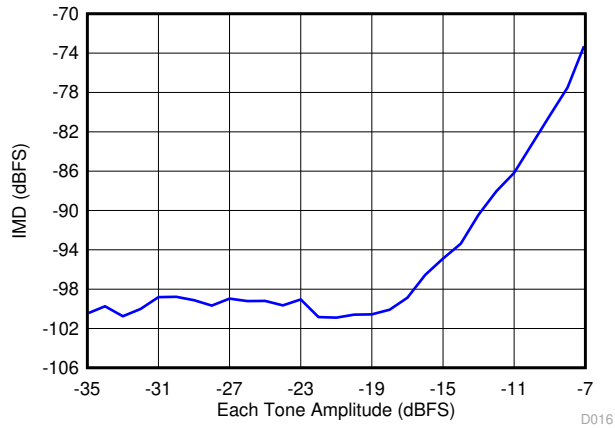

$f_{IN1} = 465 \text{ MHz}$, $f_{IN2} = 470 \text{ MHz}$

图 7-19. Intermodulation Distortion vs Input Tone Amplitude



图 7-20. Spurious-Free Dynamic Range vs Input Frequency



图 7-21. IL Spur vs Input Frequency

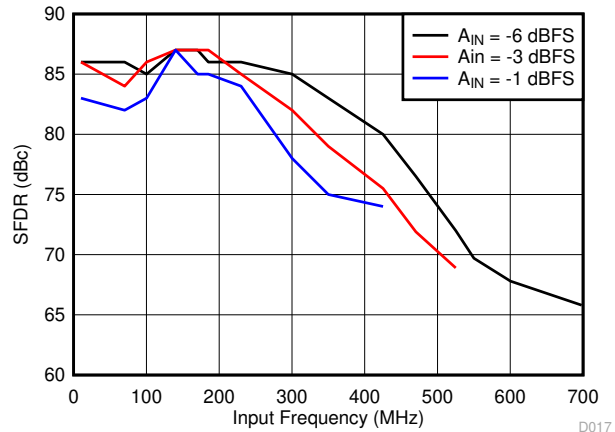

图 7-22. Signal-to-Noise Ratio vs Input Frequency

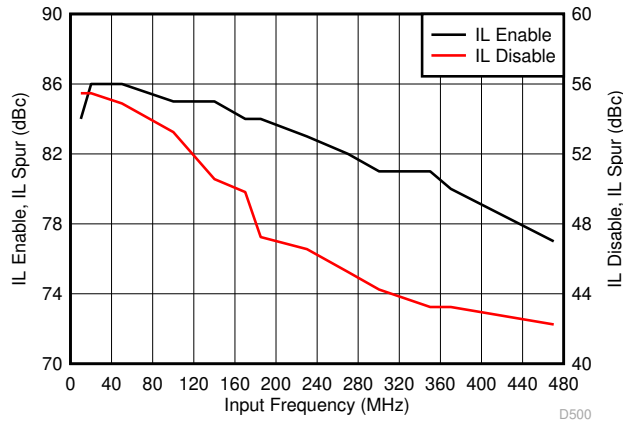

图 7-23. Signal-to-Noise Ratio vs AVDD Supply and Temperature

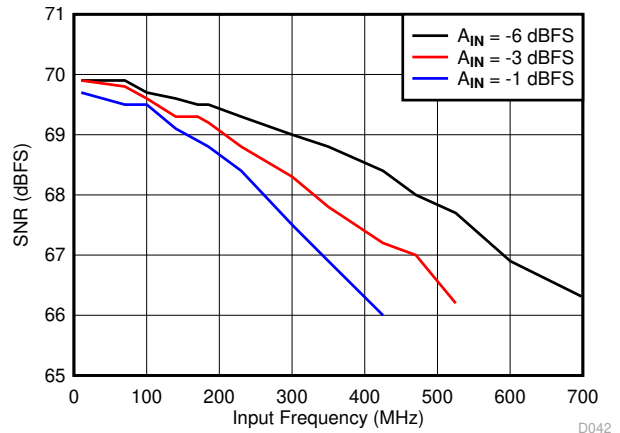

图 7-24. Spurious-Free Dynamic Range vs AVDD Supply and Temperature

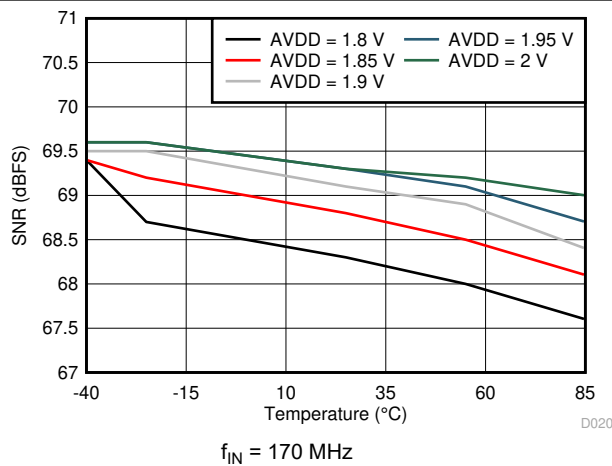

图 7-25. Signal-to-Noise Ratio vs AVDD Supply and Temperature

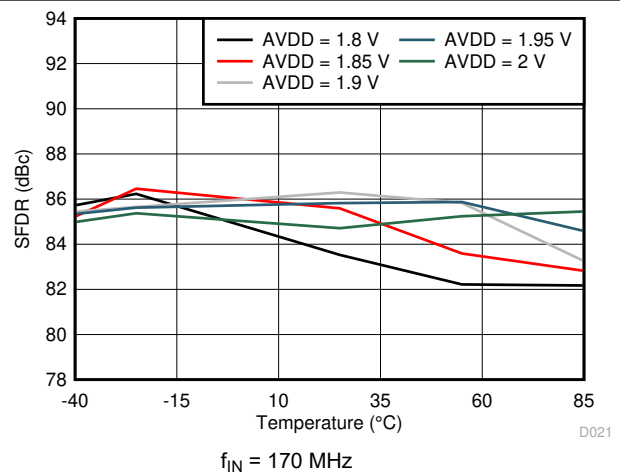

图 7-26. Spurious-Free Dynamic Range vs AVDD Supply and Temperature

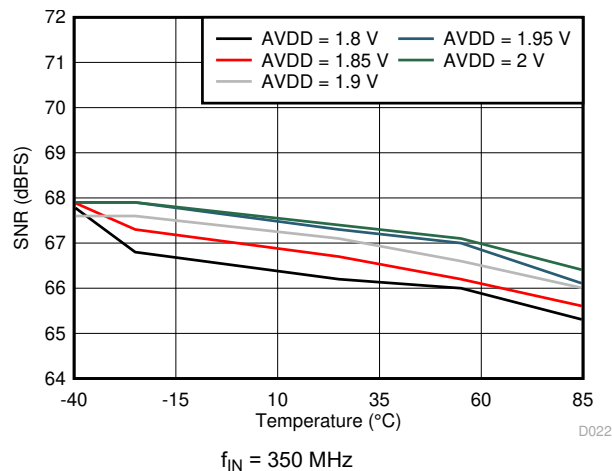

图 7-27. Signal-to-Noise Ratio vs DVDD Supply and Temperature

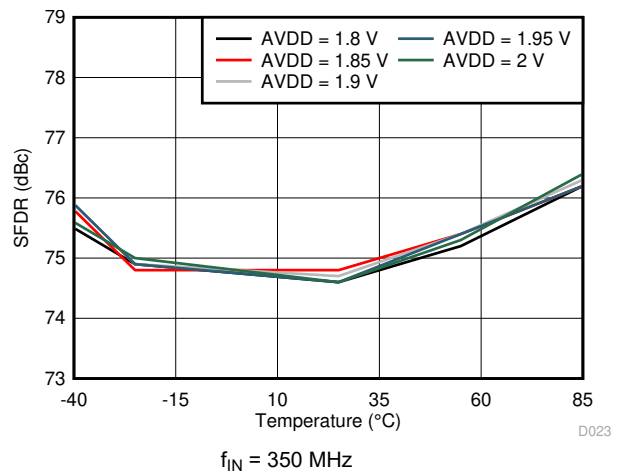

图 7-28. Spurious-Free Dynamic Range vs DVDD Supply and Temperature

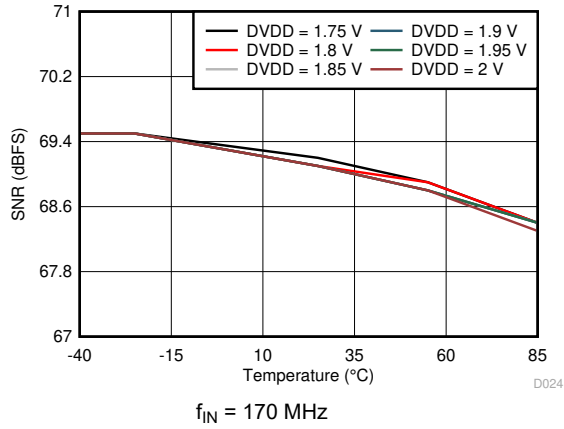

图 7-29. Signal-to-Noise Ratio vs DVDD Supply and Temperature

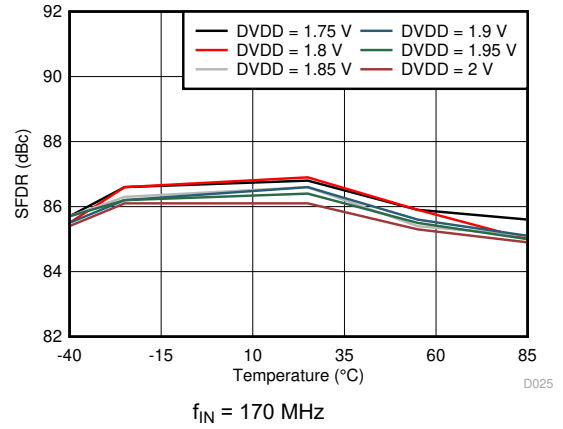

图 7-30. Spurious-Free Dynamic Range vs DVDD Supply and Temperature

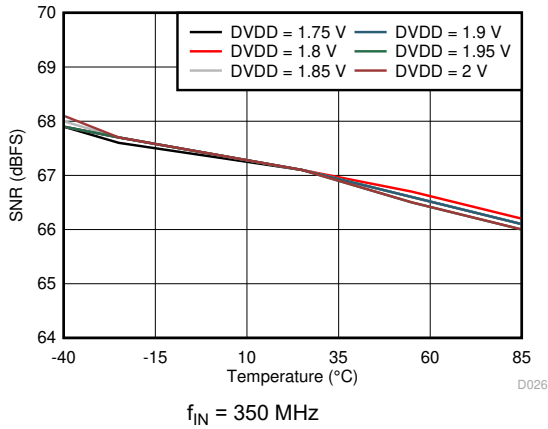

图 7-31. Signal-to-Noise Ratio vs AVDD3V Supply and Temperature

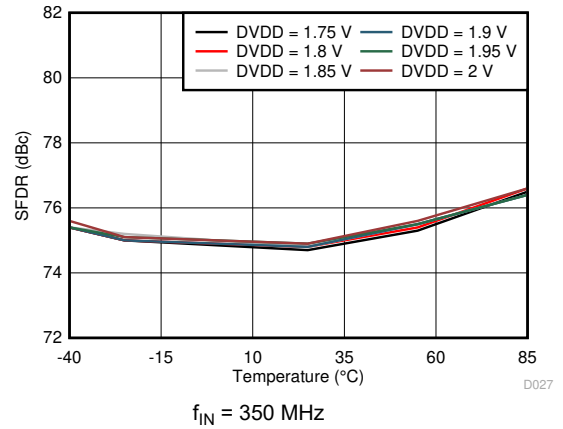

图 7-32. Spurious-Free Dynamic Range vs AVDD3V Supply and Temperature

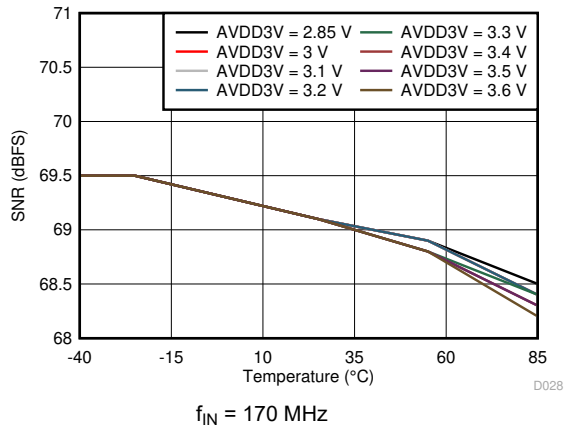

图 7-33. Signal-to-Noise Ratio vs AVDD3V Supply and Temperature

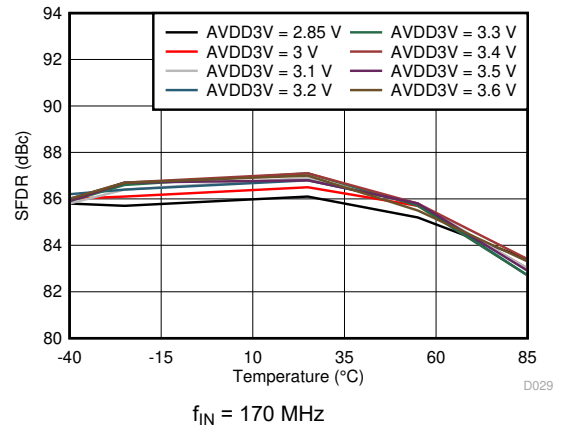

图 7-34. Spurious-Free Dynamic Range vs AVDD3V Supply and Temperature

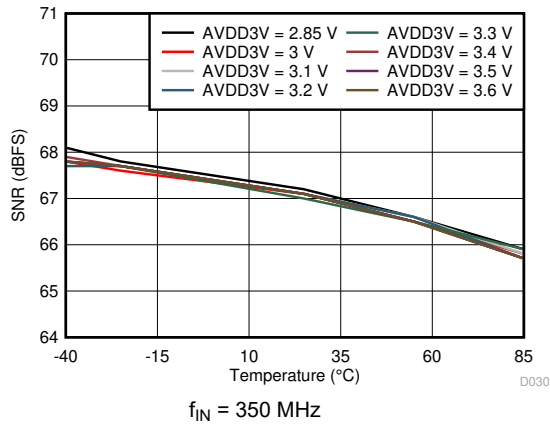

图 7-35. Signal-to-Noise Ratio vs Gain and Input Frequency

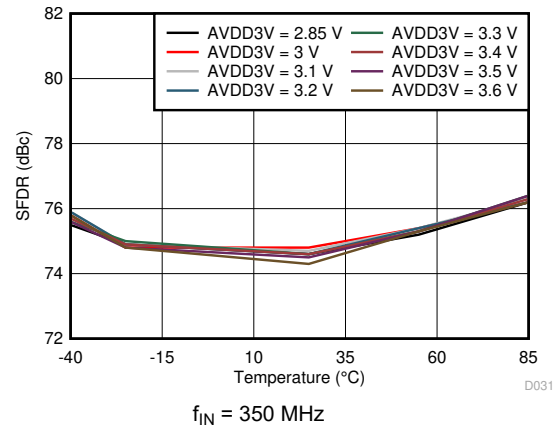

图 7-36. Spurious-Free Dynamic Range vs Gain and Input Frequency

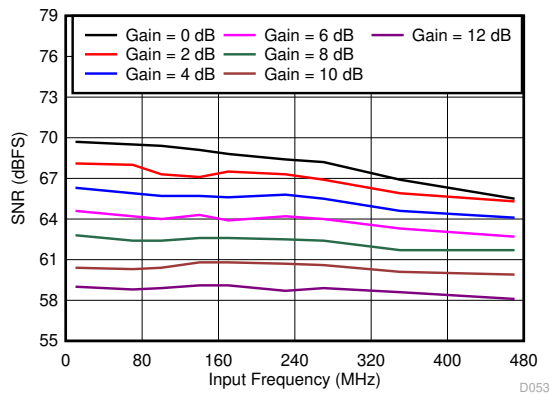

图 7-37. Maximum Supported Amplitude vs Frequency

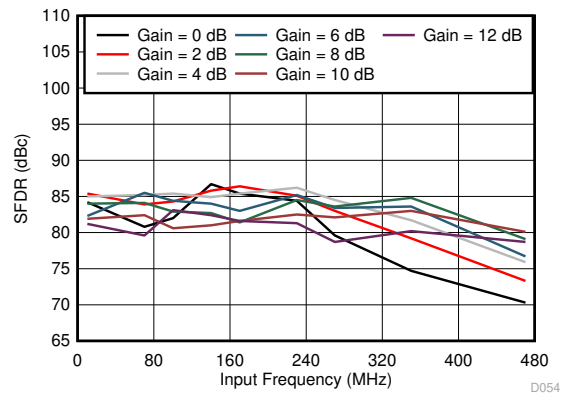

图 7-38. Performance vs Input Amplitude

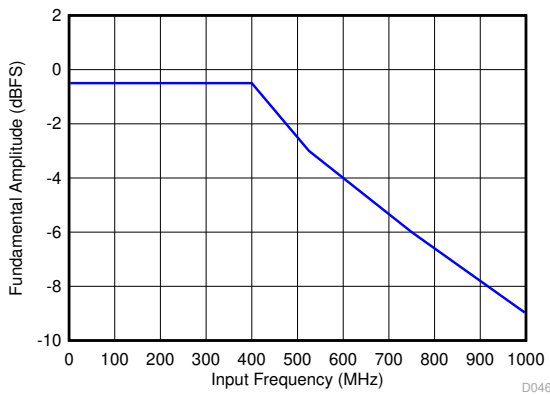

图 7-39. Performance vs Input Amplitude

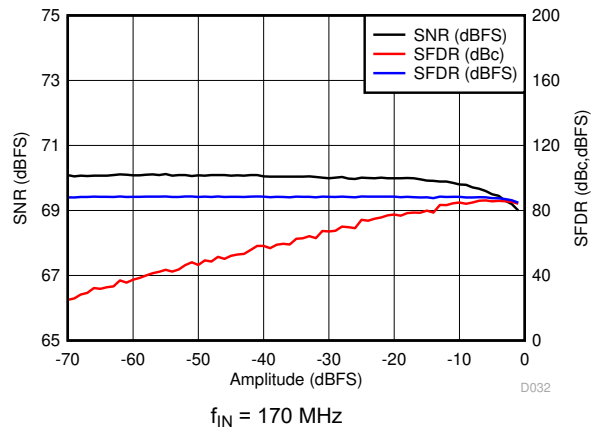

图 7-40. Performance vs Sampling Clock Amplitude

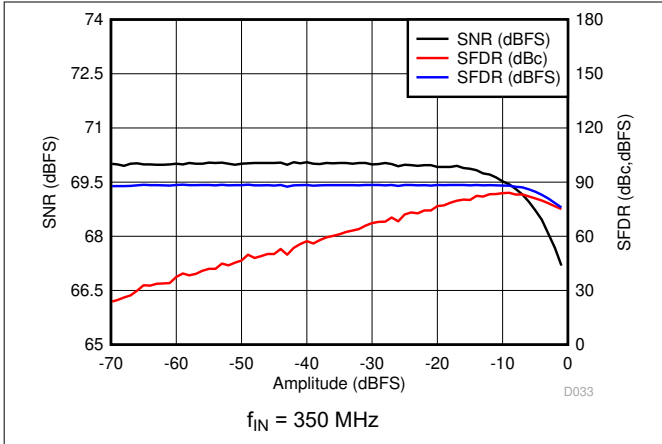

图 7-41. Performance vs Sampling Clock Amplitude

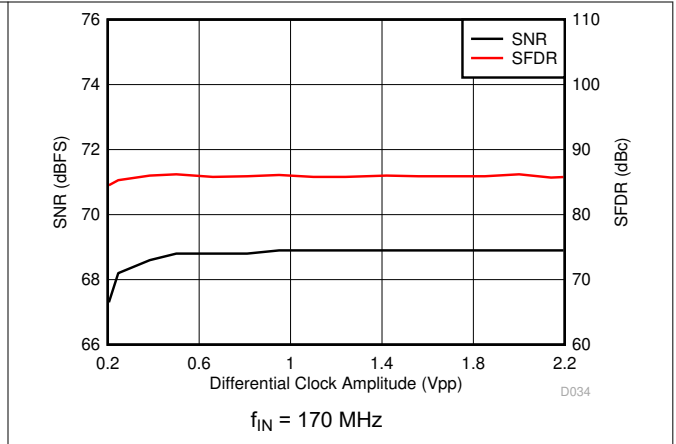

图 7-42. Performance vs Input Clock Duty Cycle

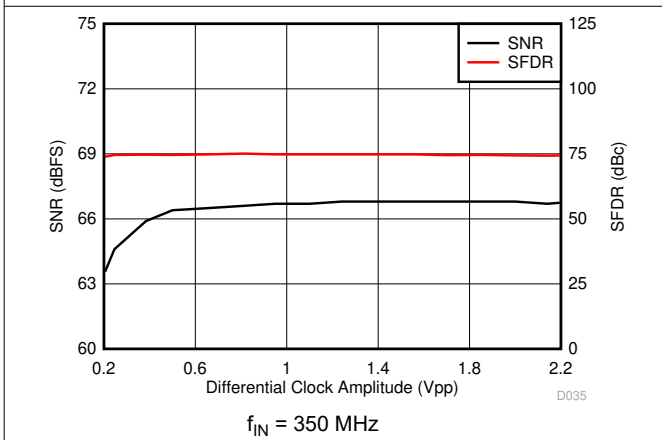

图 7-43. Performance vs Input Clock Duty Cycle

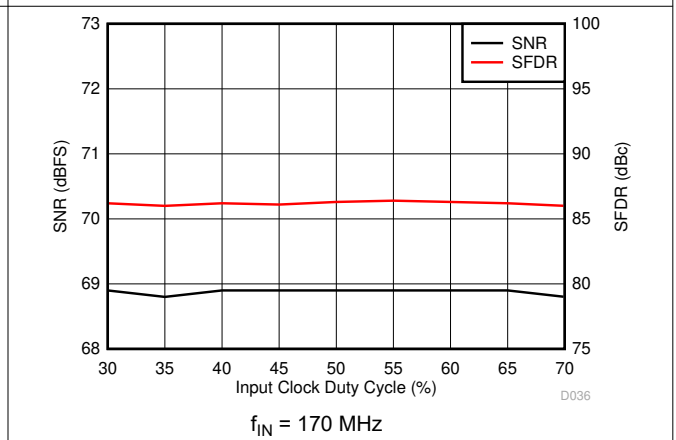

图 7-44. Power-Supply Rejection Ratio vs Test Signal Frequency

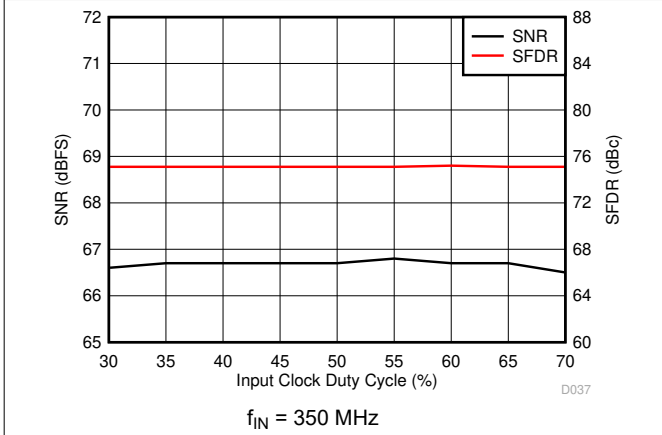

$f_{IN} = 170 \text{ MHz}$, $A_{IN} = -1 \text{ dBFS}$, $SINAD = 65.7 \text{ dBFS}$, $SFDR = 79 \text{ dBc}$, $f_{PSRR} = 5 \text{ MHz}$, $A_{PSRR} = 25 \text{ mV}_{PP}$, amplitude of $f_{IN} - f_{PSRR} = -74 \text{ dBFS}$, amplitude of $f_{IN} + f_{PSRR} = -76 \text{ dBFS}$

图 7-45. Power-Supply Rejection Ratio FFT for Test Signals on the AVDD Supply

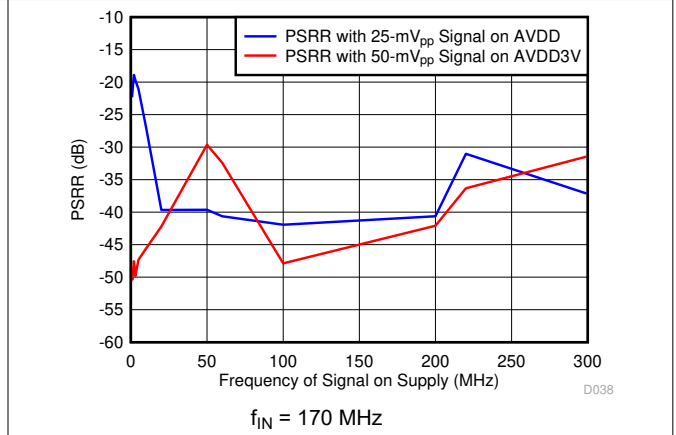
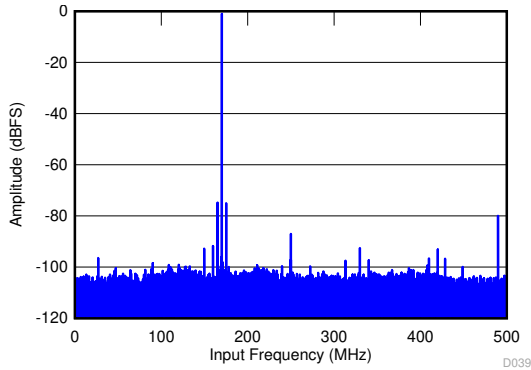
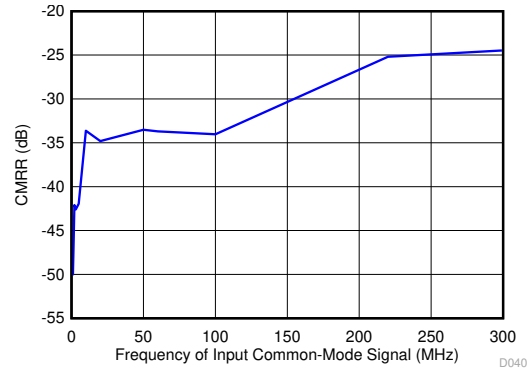

$f_{IN} = 170 \text{ MHz}$

图 7-46. Common-Mode Rejection Ratio vs Test Signal Frequency

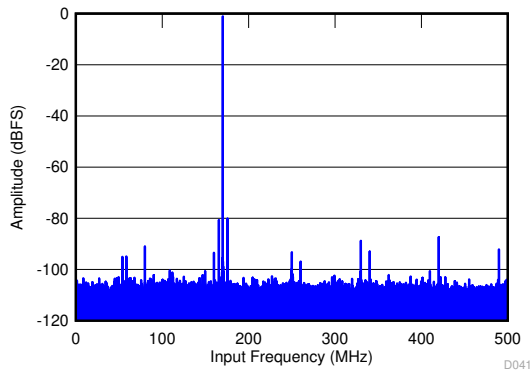

$f_{IN} = 170.1 \text{ MHz}$, $A_{IN} = -1 \text{ dBFS}$, $f_{CMRR} = 5 \text{ MHz}$, $A_{CMRR} = 50 \text{ mV}_{PP}$, $SINAD = 67.3 \text{ dBFS}$, $SFDR = 85 \text{ dBc}$, amplitude of $f_{IN} \pm f_{CMRR} = -80 \text{ dBFS}$

图 7-47. Common-Mode Rejection Ratio FFT



图 7-48. Power Consumption vs Sampling Speed



图 7-49. Power vs Temperature

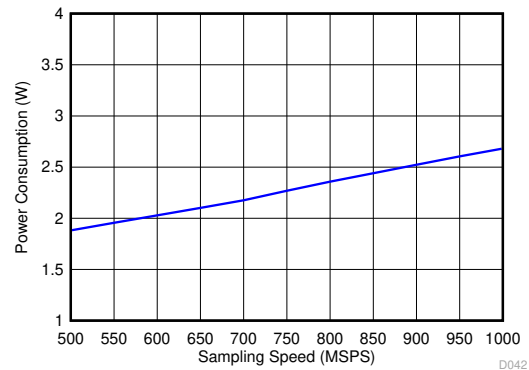

$SNR = 73.1 \text{ dBFS}$, $SFDR = 88.6 \text{ dBc}$

图 7-50. FFT for 60-MHz Input Signal in Decimate-by-4 Mode

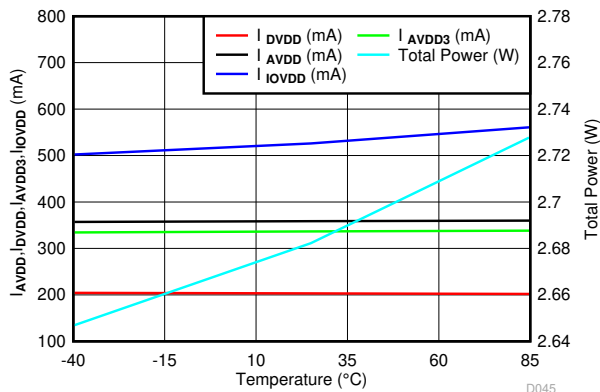
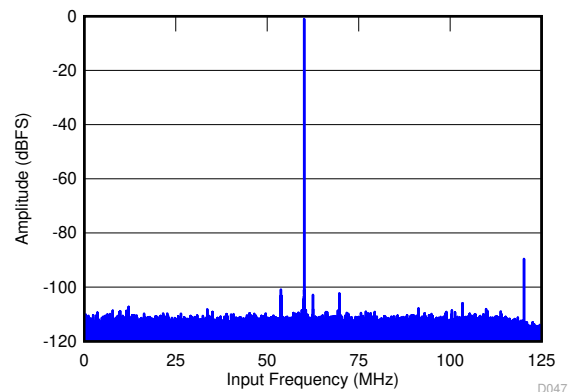

图 7-51. FFT for 170-MHz Input Signal in Decimate-by-4 Mode



图 7-52. FFT for 300-MHz Input Signal in Decimate-by-4 Mode

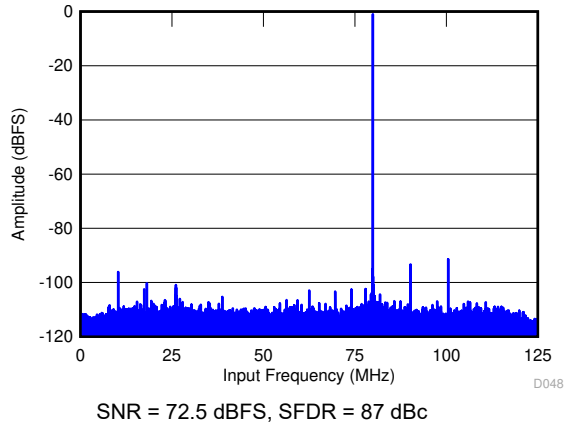

图 7-53. FFT for 450-MHz Input Signal in Decimate-by-4 Mode

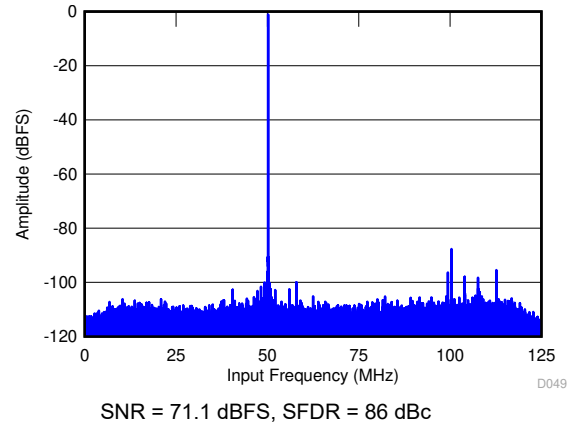

图 7-54. FFT for 170-MHz Input Signal in Decimate-by-2 Mode

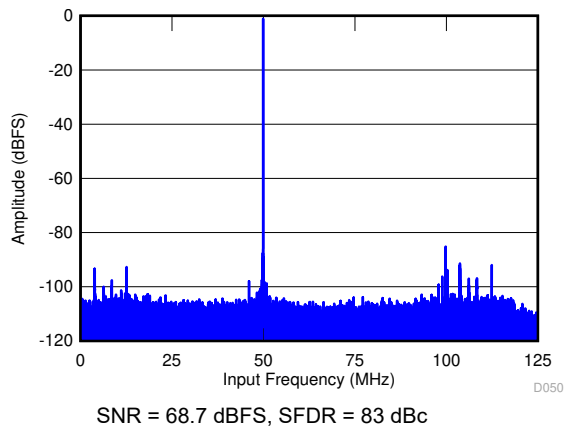

图 7-55. FFT for 350-MHz Input Signal in Decimate-by-2 Mode

8 Detailed Description

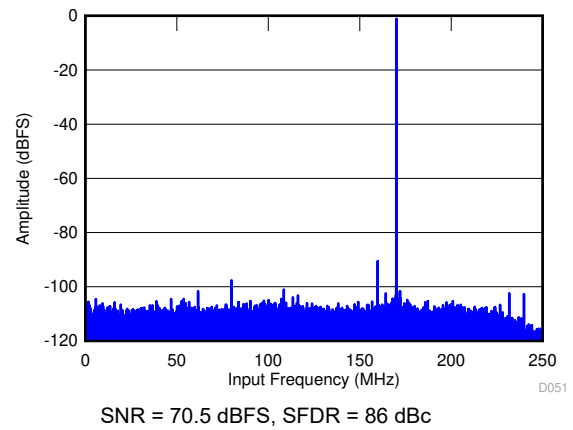
8.1 Overview

The ADS54J40 is a low-power, wide-bandwidth, 14-bit, 1.0-GSPS, dual-channel, analog-to-digital converter (ADC). The ADS54J40 employs four interleaving ADCs for each channel to achieve a noise floor of -159 dBFS/Hz. The ADS54J40 uses TI's proprietary interleaving and dither algorithms to achieve a clean spectrum with a high spurious-free dynamic range (SFDR). The device also offers various programmable decimation filtering options for systems requiring higher signal-to-noise ratio (SNR) and SFDR over a wide range of frequencies.

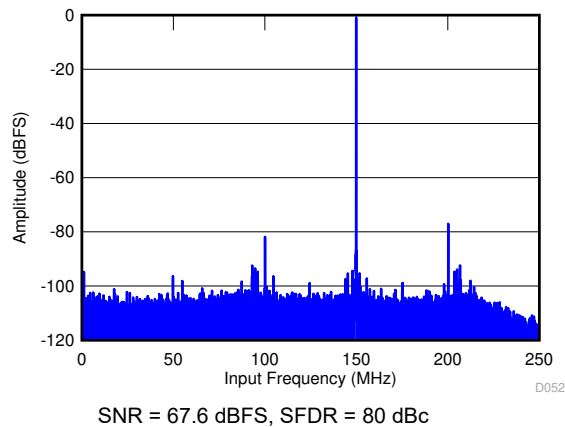
Analog input buffers isolate the ADC driver from glitch energy generated from sampling process, thereby simplify the driving network on-board. The JESD204B interface reduces the number of interface lines with two-lane and four-lane options, allowing a high system integration density. The JESD204B interface operates in subclass 1, enabling multi-chip synchronization with the SYSREF input.

8.2 Functional Block Diagram

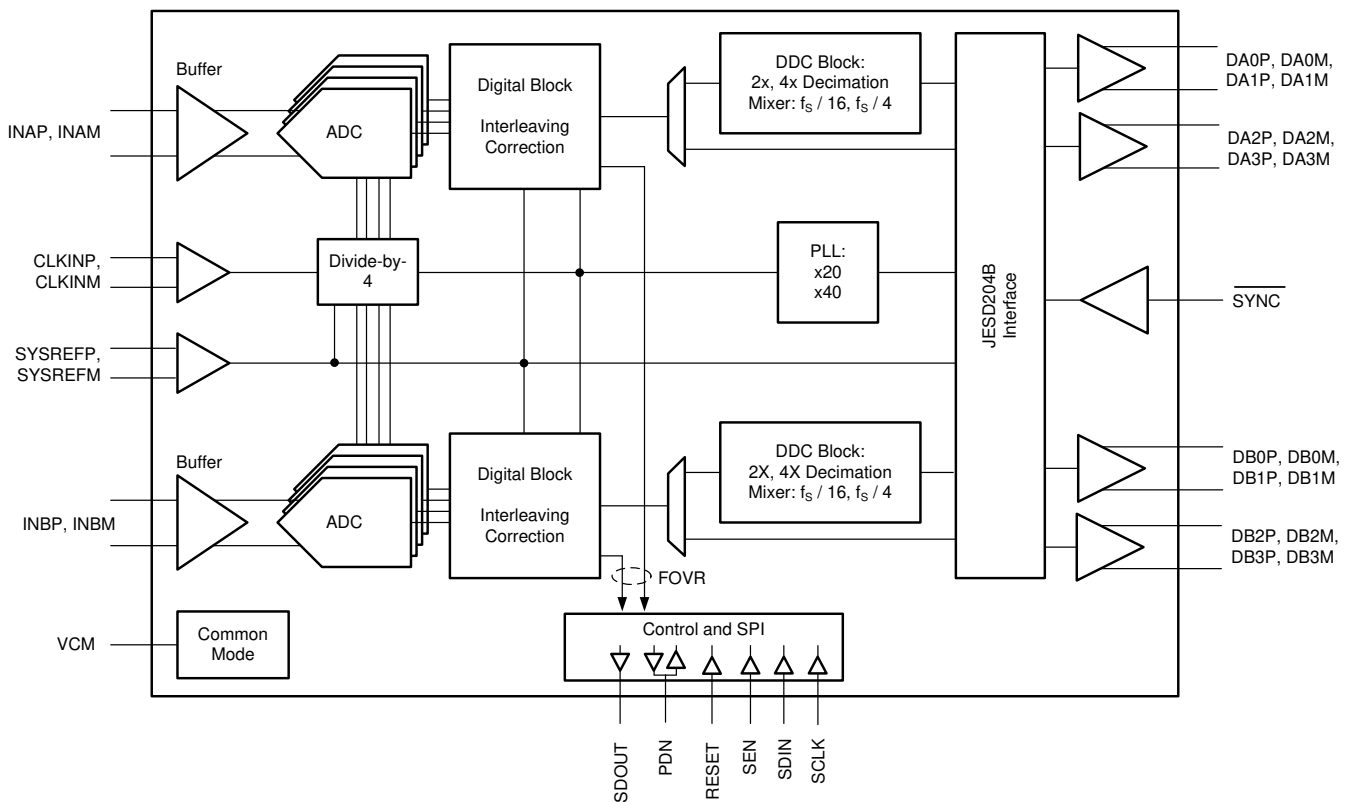

8.3 Feature Description

8.3.1 Analog Inputs

The ADS54J40 analog signal inputs are designed to be driven differentially. The analog input pins have internal analog buffers that drive the sampling circuit. As a result of the analog buffer, the input pins present a high impedance input across a very wide frequency range to the external driving source that enables great flexibility in the external analog filter design as well as excellent 50-Ω matching for RF applications. The buffer also helps isolate the external driving circuit from the internal switching currents of the sampling circuit, resulting in a more constant SFDR performance across input frequencies.

The common-mode voltage of the signal inputs is internally biased to VCM using 600-Ω resistors, allowing for ac-coupling of the input drive network. Each input pin (INP, INM) must swing symmetrically between (VCM + 0.475 V) and (VCM - 0.475 V), resulting in a 1.9-V_{PP} (default) differential input swing. The input sampling circuit has a 3-dB bandwidth that extends up to 1.2 GHz. An equivalent analog input network diagram is shown in [Figure 8-1](#).



图 8-1. Analog Input Network

The input bandwidth shown in [Figure 8-2](#) is measured with respect to a 50-Ω differential input termination at the ADC input pins. Figure x shows the signal processing done inside the DDC block of the ADS54J40.

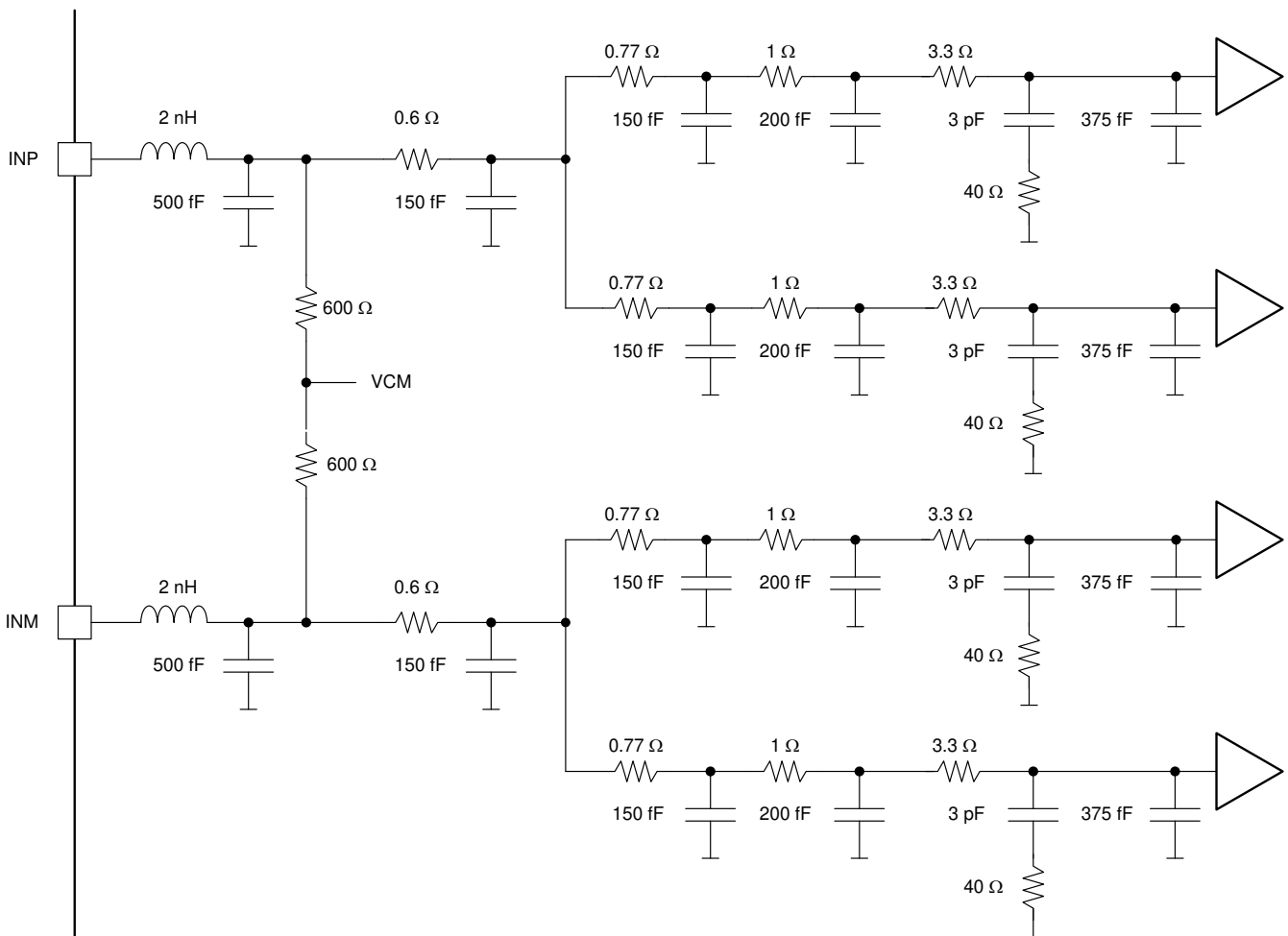

图 8-2. Transfer Function vs Frequency

8.3.2 DDC Block

The ADS54J40 has an optional DDC block that can be enabled via an SPI register write. Each ADC channel is followed by a DDC block consisting of three different decimate-by-2 and decimate-by-4 finite impulse response (FIR) half-band filter options. The different decimation filter options can be selected through SPI programming. [Figure 8-3](#) shows the signal processing done inside the DDC block of the ADS54J40

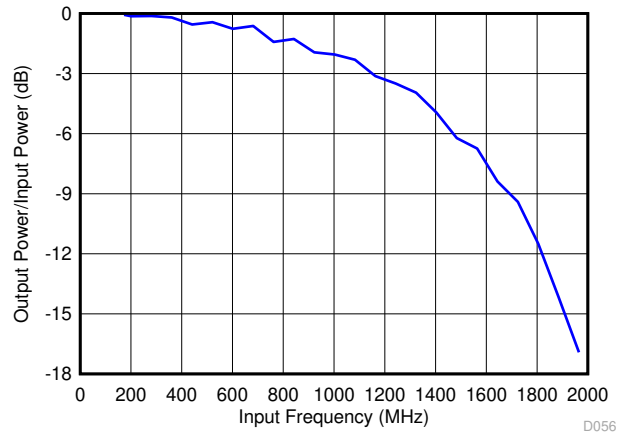
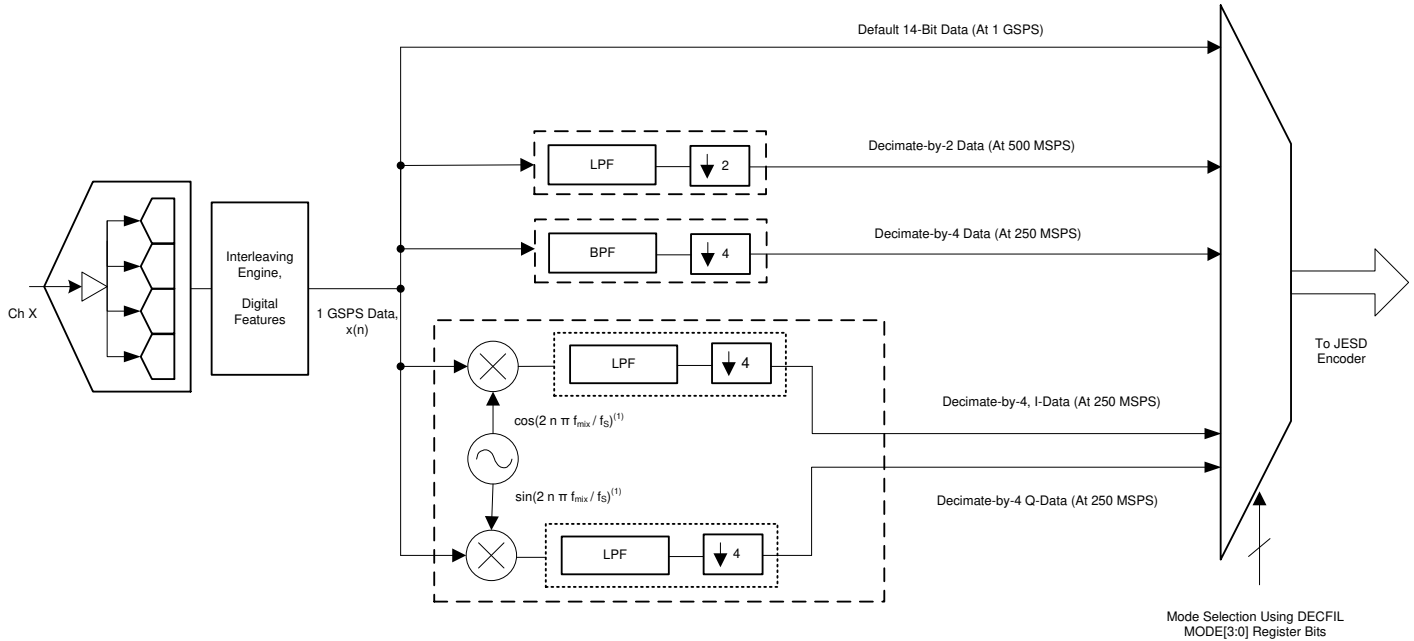

A. In IQ decimate-by-4 mode, the mixer frequency is fixed at $f_{mix} = f_s / 4$. For $f_s = 1$ GSPS and $f_{mix} = 250$ MHz.

图 8-3. DDC Block

8.3.2.1 Decimate-by-2 Filter

This decimation filter has 41 taps. The stop-band attenuation is approximately 90 dB and the pass-band flatness is ± 0.05 dB. 表 8-1 shows corner frequencies for low-pass and high-pass filter options.

表 8-1. Corner Frequencies for the Decimate-by-2 Filter

CORNERS (dB)	LOW PASS	HIGH PASS
- 0.1	$0.202 \times f_S$	$0.298 \times f_S$
- 0.5	$0.210 \times f_S$	$0.290 \times f_S$
- 1	$0.215 \times f_S$	$0.285 \times f_S$
- 3	$0.227 \times f_S$	$0.273 \times f_S$

图 8-4 和 图 8-5 show the frequency response of decimate-by-2 filter from dc to $f_S / 2$.

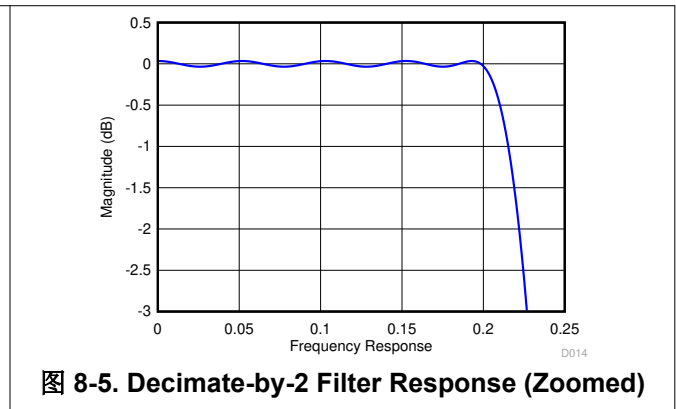
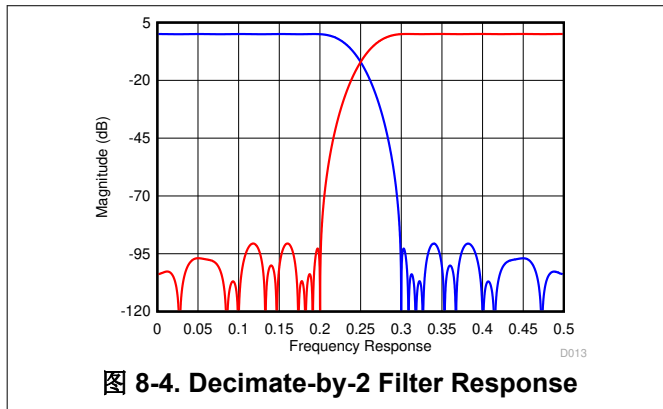

8.3.2.2 Decimate-by-4 Filter Using a Digital Mixer

This band-pass decimation filter consists of a digital mixer and three concatenated FIR filters with a combined latency of approximately 28 output clock cycles. The alias band attenuation is approximately 55 dB and the pass-band flatness is ± 0.1 dB. By default after reset, the band-pass filter is centered at $f_S / 16$. Using the SPI, the center frequency can be programmed at $N \times f_S / 16$ (where $N = 1, 3, 5, \text{ or } 7$). 表 8-2 shows corner frequencies for two extreme options.

表 8-2. Corner frequencies for the Decimate-by-4 Filter

CORNERS (dB)	CORNER FREQUENCY AT LOWER SIDE (Center Frequency $f_S / 16$)	CORNER FREQUENCY AT HIGHER SIDE (Center Frequency $f_S / 16$)
- 0.1	$0.011 \times f_S$	$0.114 \times f_S$
- 0.5	$0.010 \times f_S$	$0.116 \times f_S$
- 1	$0.008 \times f_S$	$0.117 \times f_S$
- 3	$0.006 \times f_S$	$0.120 \times f_S$

图 8-6 和 图 8-7 show the frequency response of the decimate-by-4 filter for center frequencies $f_S / 16$ and $3 \times f_S / 16$ ($N = 1$ and $N = 3$, respectively).

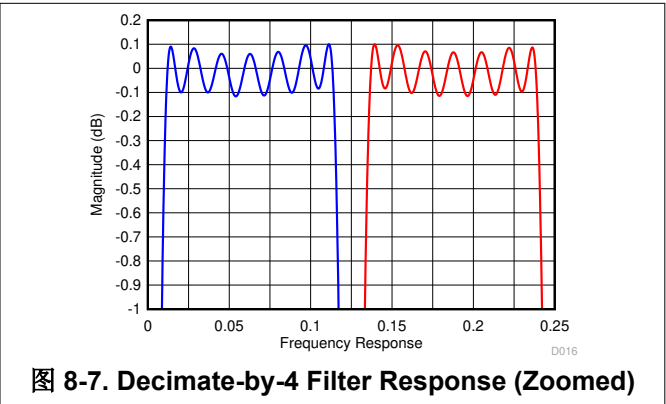
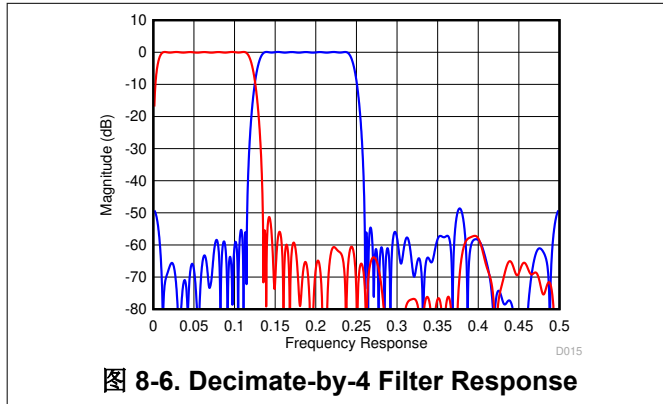

8.3.2.3 Decimate-by-4 Filter with IQ Outputs

In this configuration, the DDC block includes a fixed digital $f_s / 4$ mixer. Thus, the IQ pass band is approximately ± 110 MHz, centered at $f_s / 4$. This decimation filter has 41 taps with a latency of approximately ten output clock cycles. The stop-band attenuation is approximately 90 dB and the pass-band flatness is ± 0.05 dB. 表 8-3 shows the corner frequencies for a low-pass, decimate-by-4 IQ filter.

表 8-3. Corner Frequencies for a Decimate-by-4 IQ Output Filter

CORNERS (dB)	LOW PASS
- 0.1	$0.107 \times f_s$
- 0.5	$0.112 \times f_s$
- 1	$0.115 \times f_s$
- 3	$0.120 \times f_s$

图 8-8 和 图 8-9 show the frequency response of a decimate-by-4 IQ output filter from dc to $f_s / 2$.

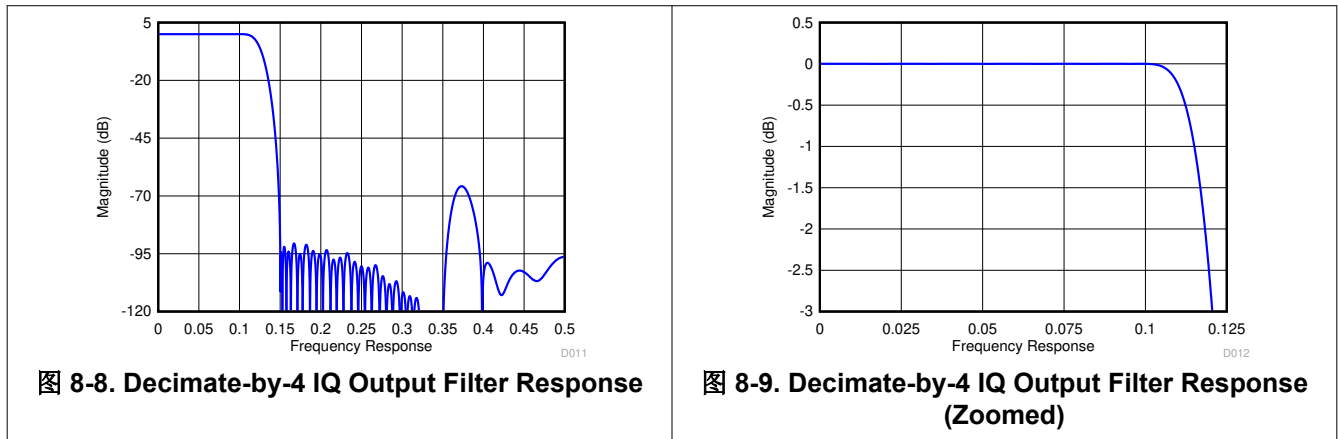

8.3.3 SYSREF Signal

The SYSREF signal is a periodic signal that is sampled by the ADS54J40 device clock and used to align the boundary of the local multi-frame clock inside the data converter. SYSREF is required to be a sub-harmonic of the local multiframe clock (LMFC) internal timing. To meet this requirement, the timing of SYSREF is dependent on the device clock frequency and the LMFC frequency, as determined by the selected DDC decimation and frames per multi-frame settings. The SYSREF signal is recommended to be a low-frequency signal in the range of 1 MHz to 5 MHz to reduce coupling to the signal path both on the printed circuit board (PCB) as well as internal in the device.

The external SYSREF signal must be a sub-harmonic of the internal LMFC clock, as shown in [方程式 1](#) and [表 8-4](#).

$$\text{SYSREF} = \text{LMFC} / 2^N \tag{1}$$

where

- N = 0, 1, 2, and so forth.

表 8-4. Local Multi-Frame Clock Frequency

LMFS CONFIGURATION	DECIMATION	LMFC CLOCK ^{(1) (2)}
4211	—	f_s / K
4244	—	$(f_s / 4) / K$
8224	—	$(f_s / 4) / K$
4222	2X	$(f_s / 4) / K$
2242	2X	$(f_s / 4) / K$
2221	4X	$(f_s / 4) / K$
2441	4X (IQ)	$(f_s / 4) / K$
4421	4X (IQ)	$(f_s / 4) / K$
1241	4X	$(f_s / 4) / K$

(1) K = Number of frames per multi frame (JESD digital page 6900h, address 06h, bits 4-0).

(2) f_s = sampling (device) clock frequency.

For example, if LMFS = 8224 then the programmed value of K is 9 (the actual value is 9 + 1 = 10 because the actual value for K = the value set in the SPI register + 1). If the device clock frequency is $f_s = 1000$ MSPS, then the local multi-frame clock frequency becomes $(1000 / 4) / 10 = 25$ MHz. The SYSREF signal frequency can be chosen as the LMFC frequency / 8 = 3.125 MHz.

8.3.3.1 SYSREF Not Present (Subclass 0, 2)

A SYSREF pulse is required by the ADS54J40 to reset internal counters. If SYSREF is not present, as can be the case in subclass 0 or 2, this pulse can be done by doing the following register writes shown in [表 8-5](#).

表 8-5. Internally Pulsing SYSREF Twice Using Register Writes

ADDRESS (Hex)	DATA (Hex)	COMMENT
0-011h	80h	Set the master page
0-054h	80h	Enable manual SYSREF
0-053h	01h	Set SYSREF high
0-053h	00h	Set SYSREF low
0-053h	01h	Set SYSREF high
0-053h	00h	Set SYSREF low

8.3.4 Overrange Indication

The ADS54J40 provides a fast overrange indication that can be presented in the digital output data stream via SPI configuration. Alternatively, if not used, the SDOOUT (pin 11) and PDN (pin 50) pins can be configured through the SPI to output the fast OVR indicator.

JESD 8b/10b encoder receives 16-bit data that is formed by 14-bit ADC data padded with two 0s as LSBs. When the FOVR indication is embedded in the output data stream, it replaces the LSB of the 16-bit data stream going to the 8b/10b encoder, as shown in 图 8-10.



图 8-10. Overrange Indication in a Data Stream

8.3.4.1 Fast OVR

The fast OVR is triggered if the input voltage exceeds the programmable overrange threshold and is presented after only 18 clock cycles + t_{PD} (t_{PD} of the gates and buffers is approximately 4 ns), thus enabling a quicker reaction to an overrange event.

The input voltage level that the overload is detected at is referred to as the *threshold*. The threshold is programmable using the FOVR THRESHOLD bits, as shown in 图 8-11. The FOVR is triggered 18 clock cycles + t_{PD} (t_{PD} of the gates and buffers is approximately 4 ns) after the overload condition occurs.

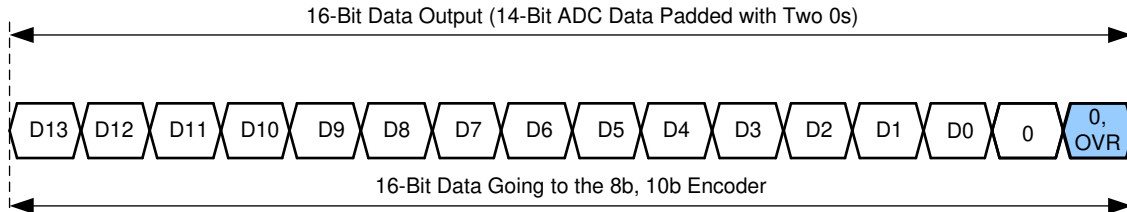

图 8-11. Programming Fast OVR Thresholds

The input voltage level that the fast OVR is triggered at is defined by 方程式 2:

$$\text{Full-Scale} \times [\text{Decimal Value of the FOVR Threshold Bits}] / 255 \quad (2)$$

The default threshold is E3h (227d), corresponding to a threshold of - 1 dBFS.

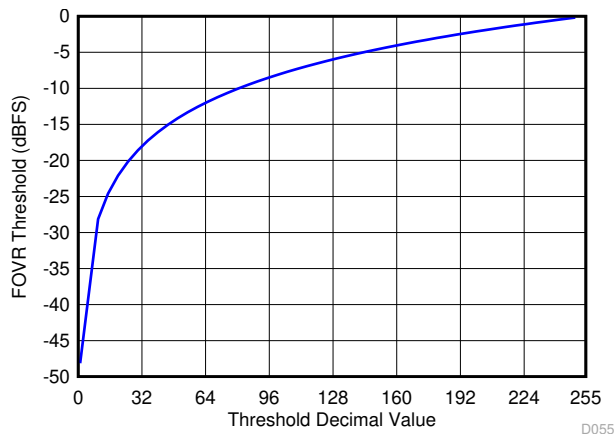
In terms of full-scale input, the fast OVR threshold can be calculated as 方程式 3:

$$20\log(\text{FOVR Threshold} / 255) \quad (3)$$

8.4 Device Functional Modes

8.4.1 Power-Down Mode

The ADS54J40 provides a highly-configurable power-down mode. Power-down can be enabled using the PDN pin or SPI register writes.

A power-down mask can be configured that allows a trade-off between wake-up time and power consumption in power-down mode. Two independent power-down masks can be configured: MASK 1 and MASK 2, as shown in [表 8-6](#). See the master page registers in [Register Maps](#) for further details.

表 8-6. Register Address for Power-Down Modes

REGISTER ADDRESS	COMMENT	REGISTER DATA							
		7	6	5	4	3	2	1	0
MASTER PAGE (80h)									
20	MASK 1	PDN ADC CHA				PDN ADC CHB			
21		PDN BUFFER CHB	PDN BUFFER CHA	0	0	0	0		
23	MASK 2	PDN ADC CHA				PDN ADC CHB			
24		PDN BUFFER CHB	PDN BUFFER CHA	0	0	0	0		
26	CONFIG	GLOBAL PDN	OVERRIDE PDN PIN	PDN MASK SEL	0	0	0	0	0
55		0	0	0	PDN MASK	0	0	0	0

To save power, the device can be put in complete power-down by using the GLOBAL PDN register bit. However, when JESD must remain linked up when putting the device in power-down, the ADC and analog buffer can be powered down by using the PDN ADC CHx and PDN BUFFER CHx register bits after enabling the PDN MASK register bit. The PDN MASK SEL register bit can be used to select between MASK 1 or MASK 2. [表 8-7](#) shows power consumption for different combinations of the GLOBAL PDN, PDN ADC CHx, and PDN BUFF CHx register bits.

表 8-7. Power Consumption in Different Power-Down Settings

REGISTER BIT	COMMENT	I _{AVDD3V} (mA)	I _{AVDD} (mA)	I _{DVDD} (mA)	I _{IOVDD} (mA)	TOTAL POWER (W)
Default	After reset, with a full-scale input signal to both channels	336	358	198	533	2.68
GBL PDN = 1	The device is in complete power-down state	2	6	22	199	0.29
GBL PDN = 0, PDN ADC CHx = 1 (x = A or B)	The ADC of one channel is powered down	274	223	135	512	2.09
GBL PDN = 0, PDN BUFF CHx = 1 (x = A or B)	The input buffer of one channel is powered down	262	352	194	545	2.45
GBL PDN = 0, PDN ADC CHx = 1, PDN BUFF CHx = 1 (x = A or B)	The ADC and input buffer of one channel is powered down	198	222	132	508	1.85
GBL PDN = 0, PDN ADC CHx = 1, PDN BUFF CHx = 1 (x = A and B)	The ADC and input buffer of both channels are powered down	60	85	66	484	1.02

8.4.2 Device Configuration

The ADS54J40 can be configured by using a serial programming interface, as described in the [Serial Interface](#) section. In addition, the device has one dedicated parallel pin (PDN) for controlling the power-down mode.

The ADS54J40 supports a 24-bit (16-bit address, 8-bit data) SPI operation and uses paging (see the [Register Maps](#) section) to access all register bits.

8.4.2.1 Serial Interface

The ADC has a set of internal registers that can be accessed by the serial interface formed by the SEN (serial interface enable), SCLK (serial interface clock), and SDIN (serial interface data) pins, as shown in [图 8-12](#). Legends used in [图 8-12](#) are explained in [表 8-8](#). Serially shifting bits into the device is enabled when SEN is low. Serial data on SDIN are latched at every SCLK rising edge when SEN is active (low). The interface can function with SCLK frequencies from 2 MHz down to very low speeds (of a few Hertz) and also with a non-50% SCLK duty cycle.



图 8-12. SPI Timing Diagram

表 8-8. SPI Timing Diagram Legend

SPI BITS	DESCRIPTION	BIT SETTINGS
R/W	Read/write bit	0 = SPI write 1 = SPI read back
M	SPI bank access	0 = Analog SPI bank (master and ADC pages) 1 = JESD SPI bank (main digital, JESD analog, and JESD digital pages)
P	JESD page selection bit	0 = Page access 1 = Register access
CH	SPI access for a specific channel of the JESD SPI bank	0 = Channel A 1 = Channel B By default, both channels are being addressed.
A[11:0]	SPI address bits	—
D[7:0]	SPI data bits	—

表 8-9 shows the timing requirements for the serial interface signals in 图 8-12.

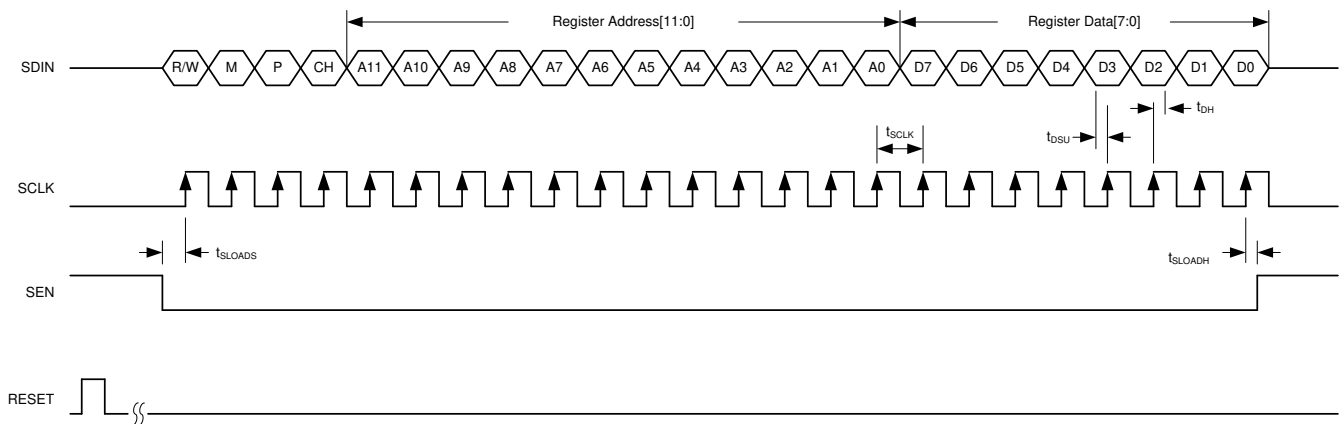
表 8-9. SPI Timing Requirements

		MIN	TYP	MAX	UNIT
f_{SCLK}	SCLK frequency (equal to $1 / t_{SCLK}$)	> dc		2	MHz
t_{SLOADS}	SEN to SCLK setup time	100			ns
t_{SLOADH}	SCLK to SEN hold time	100			ns
t_{DSU}	SDIN setup time	100			ns
t_{DH}	SDIN hold time	100			ns

8.4.2.2 Serial Register Write: Analog Bank

The analog SPI bank contains of two pages (the master and ADC page). The internal register of the ADS54J40 analog SPI bank can be programmed by:

1. Driving the SEN pin low.
2. Initiating a serial interface cycle specifying the page address of the register whose content must be written.
 - Master page: write address 0011h with 80h.
 - ADC page: write address 0011h with 0Fh.
3. Writing the register content as shown in 图 8-13. When a page is selected, multiple writes into the same page can be done.



图 8-13. Serial Register Write Timing Diagram

8.4.2.3 Serial Register Readout: Analog Bank

The content from one of the two analog banks can be read out by:

1. Driving the SEN pin low.
2. Selecting the page address of the register whose content must be read.
 - Master page: write address 0011h with 80h.
 - ADC page: write address 0011h with 0Fh.
3. Setting the R/W bit to 1 and writing the address to be read back.
4. Reading back the register content on the SDOOUT pin, as shown in 图 8-14. When a page is selected, multiple read backs from the same page can be done. SDOOUT comes out at the SCLK falling edge with an approximate delay (t_{SD_DELAY}) of 68 ns; see 图 8-18.

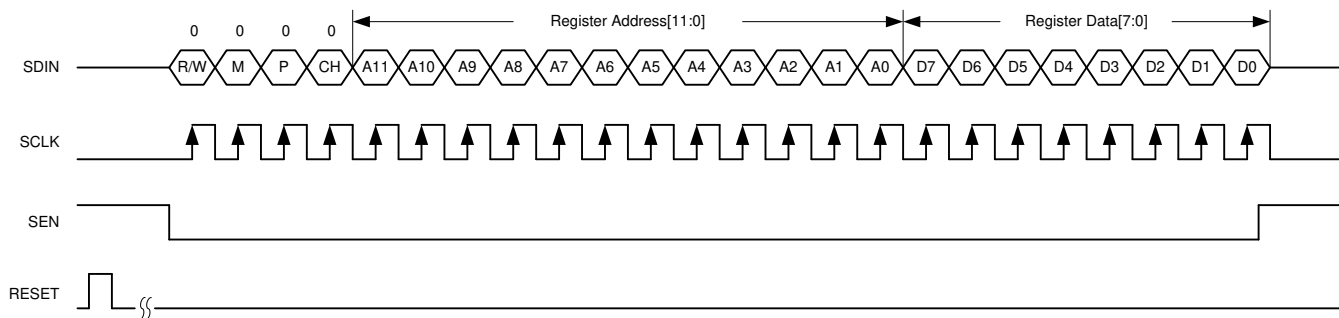

图 8-14. Serial Register Read Timing Diagram

8.4.2.4 JESD Bank SPI Page Selection

The JESD SPI bank contains four pages (main digital, JESD digital, and JESD analog pages). The individual pages can be selected by:

1. Driving the SEN pin low.
2. Setting the M bit to 1 and specifying the page with two register writes. Note that the P bit must be set to 0, as shown in 图 8-15.
 - Write address 4003h with 00h (LSB byte of the page address).
 - Write address 4004h with the MSB byte of the page address.
 - For the main digital page: write address 4004h with 68h.
 - For the JESD digital page: write address 4004h with 69h.
 - For the JESD analog page: write address 4004h with 6Ah.

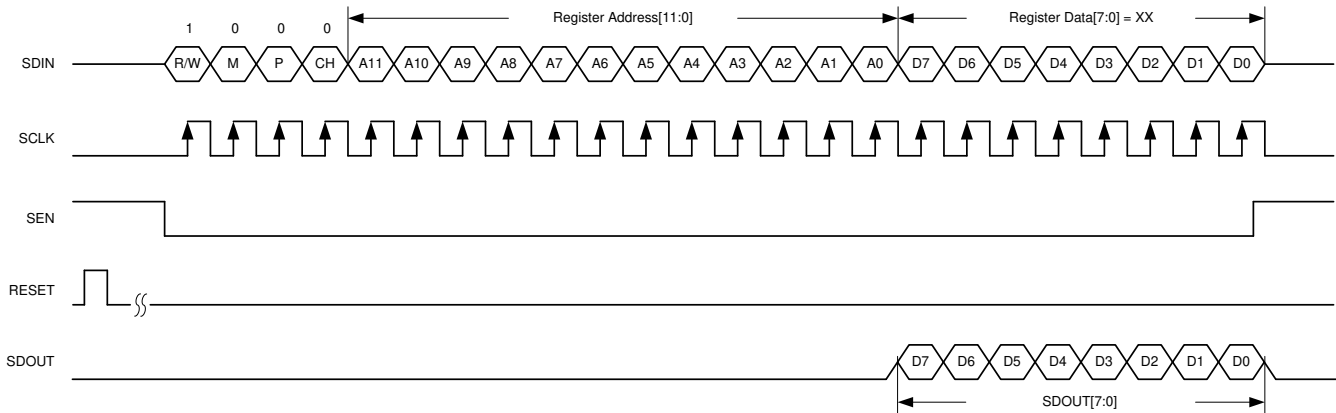

图 8-15. SPI Page Selection

8.4.2.5 Serial Register Write: JESD Bank

The ADS54J40 is a dual-channel device and the JESD204B portion is configured individually for each channel by using the CH bit. Note that the P bit must be set to 1 for register writes.

1. Drive the SEN pin low.
2. Select the JESD bank page. Note that the M bit = 1 and the P bit = 0.
 - Write address 4003h with 00h.
 - Write address 4005h with 01h to enable separate control for both channels.
 - For the main digital page: write address 4004h with 68h.
 - For the JESD digital page: write address 4004h with 69h.
 - For the JESD analog page: write address 4004h with 6Ah.
3. Set the M and P bits to 1, select channel A (CH = 0) or channel B (CH = 1), and write the register content as shown in [图 8-16](#). When a page is selected, multiple writes into the same page can be done.

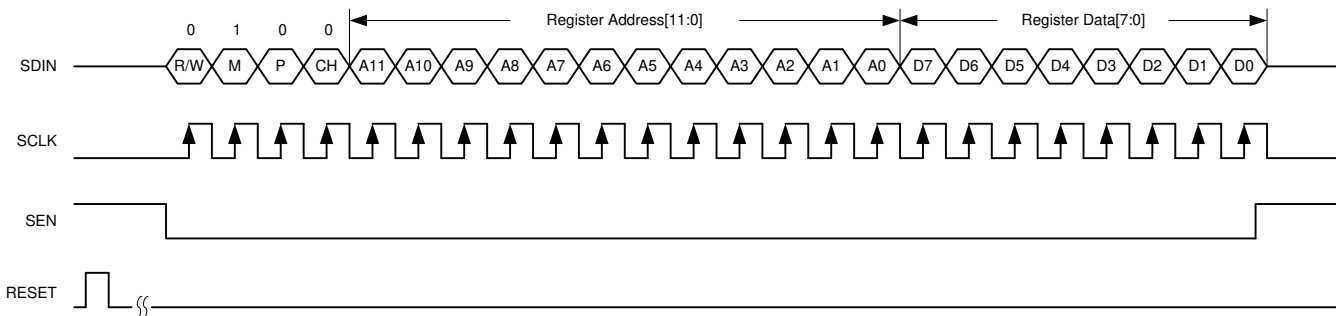

图 8-16. JESD Serial Register Write Timing Diagram

8.4.2.5.1 Individual Channel Programming

By default, register writes are applied to both channels. To enable individual channel writes, write address 4005h with 01h (default is 00h).

8.4.2.6 Serial Register Readout: JESD Bank

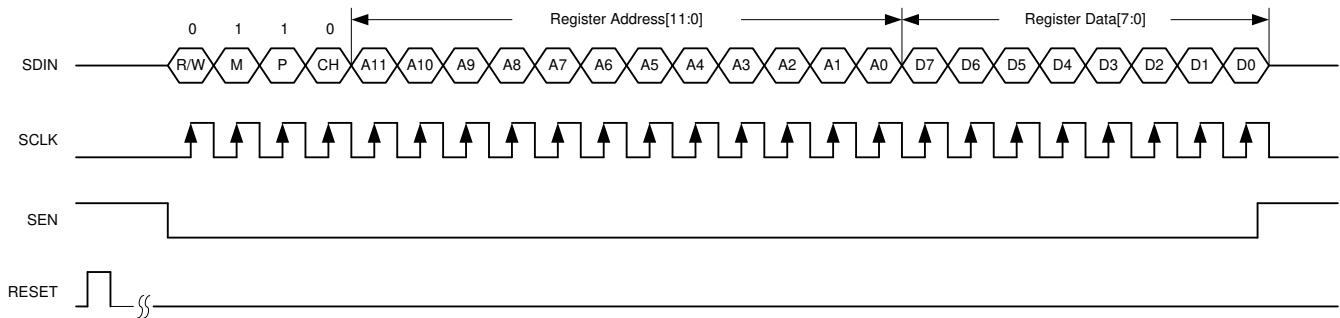
The content from one of the pages of the JESD bank can be read out by:

1. Driving the SEN pin low.
2. Selecting the JESD bank page. Note that the M bit = 1 and the P bit = 0.
 - Write address 4003h with 00h.
 - Write address 4005h with 01h to enable separate control for both channels.
 - For the main digital page: write address 4004h with 68h.
 - For the JESD digital page: write address 4004h with 69h.
 - For the JESD analog page: write address 4004h with 6Ah.
3. Setting the R/W, M, and P bits to 1, selecting channel A or channel B, and writing the address to be read back.
4. Reading back the register content on the SDOUT pin; see [图 8-17](#). When a page is selected, multiple read backs from the same page can be done. SDOUT comes out at the SCLK falling edge with an approximate delay (t_{SD_DELAY}) of 68 ns; see [图 8-18](#).



图 8-17. JESD Serial Register Read Timing Diagram



图 8-18. SDOUT Timing Diagram

8.4.3 JESD204B Interface

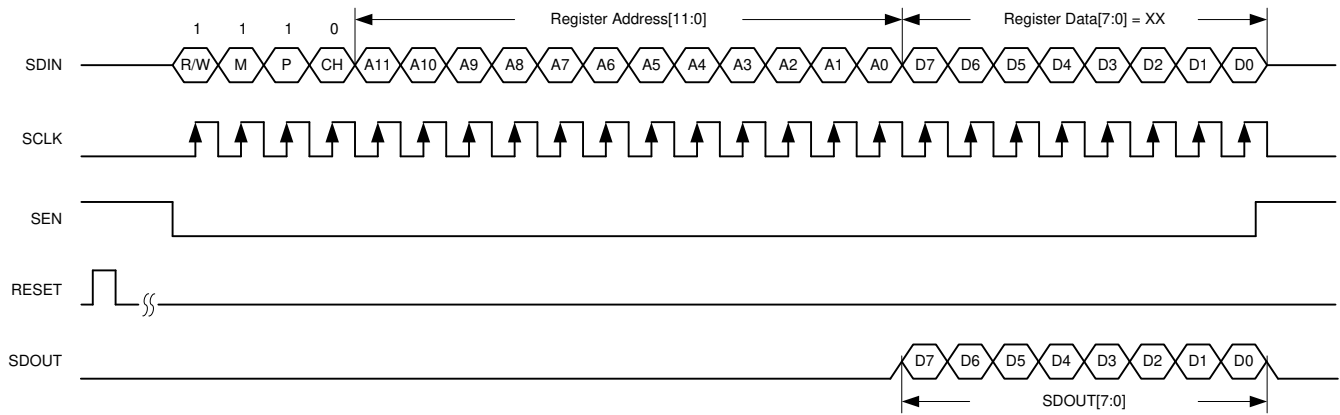
The ADS54J40 supports device subclass 1 with a maximum output data rate of 10.0 Gbps for each serial transmitter.

An external SYSREF signal is used to align all internal clock phases and the local multi-frame clock to a specific sampling clock edge, allowing synchronization of multiple devices in a system and minimizing timing and alignment uncertainty. The $\overline{\text{SYNC}}$ input is used to control the JESD204B SERDES blocks.

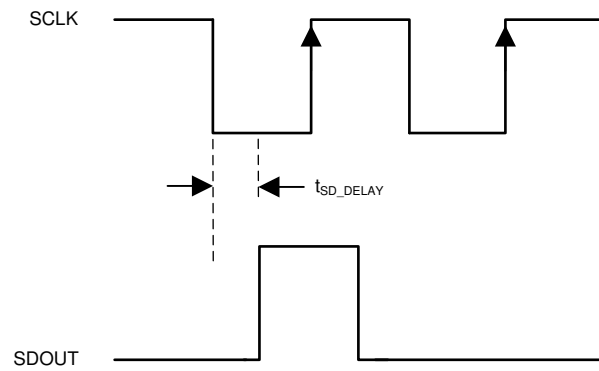
Depending on the ADC output data rate, the JESD204B output interface can be operated with either two or four lanes per single ADC, as shown in [图 8-19](#). The JESD204B setup and configuration of the frame assembly parameters is controlled through the SPI interface.



图 8-19. ADS54J40 Block Diagram

The JESD204B transmitter block shown in [图 8-20](#) consists of the transport layer, the data scrambler, and the link layer. The transport layer maps the ADC output data into the selected JESD204B frame data format. The link layer performs the 8b/10b data encoding as well as the synchronization and initial lane alignment using the $\overline{\text{SYNC}}$ input signal. Optionally, data from the transport layer can be scrambled.

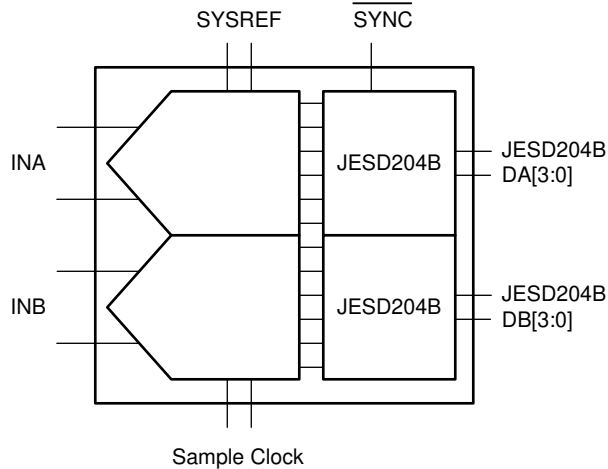

图 8-20. JESD204B Transmitter Block

8.4.3.1 JESD204B Initial Lane Alignment (ILA)

The initial lane alignment process is started when the receiving device de-asserts the $\overline{\text{SYNC}}$ signal, as shown in [图 8-21](#). When a logic low is detected on the $\overline{\text{SYNC}}$ input pin, the ADS54J40 starts transmitting comma (K28.5) characters to establish a code group synchronization.

When synchronization is complete, the receiving device asserts the $\overline{\text{SYNC}}$ signal and the ADS54J40 starts the initial lane alignment sequence with the next local multi-frame clock boundary. The ADS54J40 transmits four multi-frames, each containing K frames (K is SPI programmable). Each of the multi-frames contains the frame start and end symbols and the second multi-frame also contains the JESD204 link configuration data.

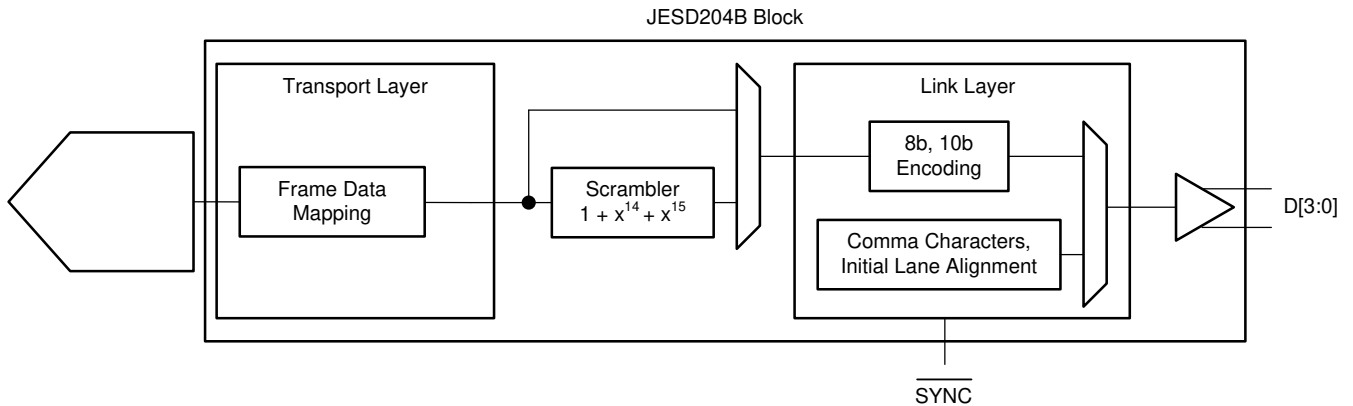

图 8-21. Lane Alignment Sequence

8.4.3.2 JESD204B Test Patterns

There are three different test patterns available in the transport layer of the JESD204B interface. The ADS54J40 supports a clock output-encoded test pattern, and a 12-octet RPAT. These test patterns can be enabled via an SPI register write and are located in the JESD digital page of the JESD bank.

8.4.3.3 JESD204B Frame

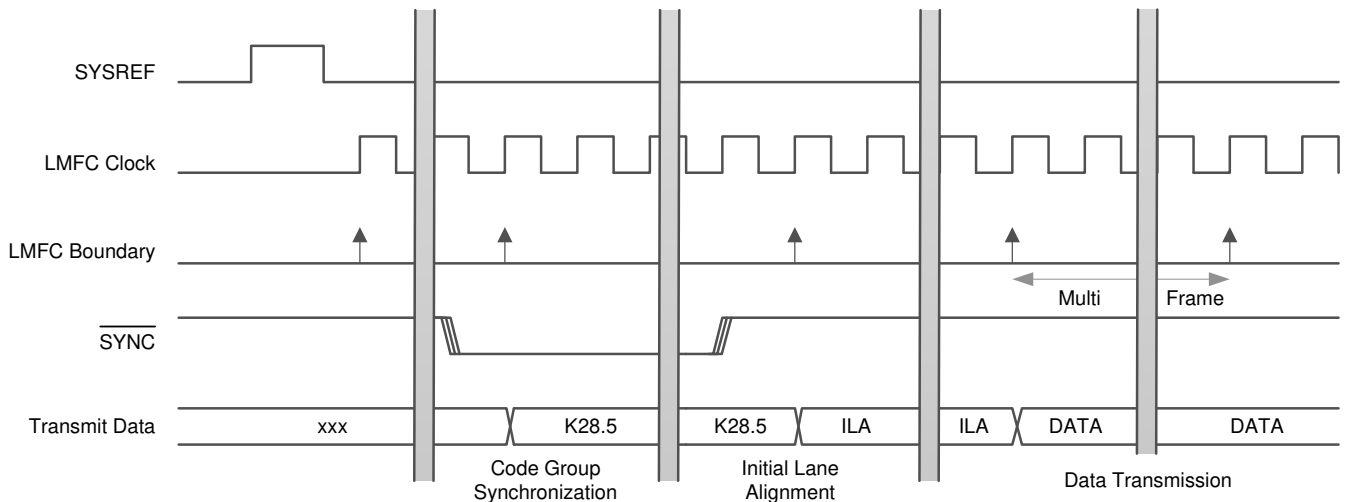
The JESD204B standard defines the following parameters:

- L is the number of lanes per link.
- M is the number of converters per device.
- F is the number of octets per frame clock period, per lane.
- S is the number of samples per frame per converter.

表 8-10 lists the available JESD204B formats and valid ranges for the ADS54J40 when the decimation filter is not used. The ranges are limited by the SERDES lane rate and the maximum ADC sample frequency.

Note

16-bit data going to JESD 8b/10b encoder is formed by padding two 0s as LSBs into the 14-bit ADC data.

表 8-10. Default Interface Rates

L	M	F	S	DECIMATION	MINIMUM RATES		MAXIMUM RATES	
					SAMPLING RATE (MSPS)	SERDES BIT RATE (Gbps)	SAMPLING RATE (MSPS)	SERDES BIT RATE (Gbps)
4	2	1	1	Not used	250	2.5	1000	10.0
4	2	4	4	Not used	250	2.5	1000	10.0
8	2	2	4	Not used	500	2.5	1000	5.0

Note

In the LMFS = 8224 row of 表 8-10, the sample order in lane DA2 and DA3 are swapped.

The detailed frame assembly is shown in 表 8-11.

表 8-11. Default Frame Assembly

PIN	LMFS = 4211	LMFS = 4244				LMFS = 8224	
DA0						A ₃ [15:8]	A ₃ [7:0]
DA1	A ₀ [7:0]	A ₂ [15:8]	A ₂ [7:0]	A ₃ [15:8]	A ₃ [7:0]	A ₂ [15:8]	A ₂ [7:0]
DA2	A ₀ [15:8]	A ₀ [15:8]	A ₀ [7:0]	A ₁ [15:8]	A ₁ [7:0]	A ₀ [15:8]	A ₀ [7:0]
DA3						A ₁ [15:8]	A ₁ [7:0]
DB0						B ₃ [15:8]	B ₃ [7:0]
DB1	B ₀ [7:0]	B ₂ [15:8]	B ₂ [7:0]	B ₃ [15:8]	B ₃ [7:0]	B ₂ [15:8]	B ₂ [7:0]
DB2	B ₀ [15:8]	B ₀ [15:8]	B ₀ [7:0]	B ₁ [15:8]	B ₁ [7:0]	B ₀ [15:8]	B ₀ [7:0]
DB3						B ₁ [15:8]	B ₁ [7:0]

8.4.3.4 JESD204B Frame Assembly with Decimation

表 8-12 lists the available JESD204B formats and valid ranges for the ADS54J40 when enabling the decimation filter. The ranges are limited by the SERDES line rate and the maximum ADC sample frequency.

表 8-13 lists the detailed frame assembly with different decimation options.

表 8-12. Interface Rates with Decimation Filter

L	M	F	S	DECIMATION	MINIMUM RATES			MAXIMUM RATES		
					DEVICE CLOCK FREQUENCY (MSPS)	OUTPUT SAMPLE RATE (MSPS)	SERDES BIT RATE (Gbps)	DEVICE CLOCK FREQUENCY (MSPS)	OUTPUT SAMPLE RATE (MSPS)	SERDES BIT RATE (Gbps)
4	4	2	1	4X (IQ)	500	125	2.5	1000	250	5.0
4	2	2	2	2X	500	250	2.5	1000	500	5.0
2	2	4	2	2X	300	150	3	1000	500	10.0
2	2	2	1	4X	500	125	2.5	1000	250	5.0
2	4	4	1	4X (IQ)	300	75	3	1000	250	10.0
1	2	4	1	4X	300	75	3	1000	250	10.0

表 8-13. Frame Assembly with Decimation Filter

PIN	LMFS = 4222, 2X DECIMATION		LMFS = 2242, 2X DECIMATION				LMFS = 2221, 4X DECIMATION		LMFS = 2441, 4X DECIMATION (IQ)				LMFS = 4421, 4X DECIMATION (IQ)		LMFS = 1241, 4X DECIMATION			
	A1 [15:8]	A1 [7:0]	A0 [15:8]	A0 [7:0]	A1 [15:8]	A1 [7:0]	A0 [15:8]	A0 [7:0]	A10 [15:8]	A10 [7:0]	AQ0 [15:8]	AQ0 [7:0]	A10 [15:8]	A10 [7:0]	A0 [15:8]	A0 [7:0]	B0 [15:8]	B0 [7:0]
DA0														AQ0 [15:8]	AQ0 [7:0]			
DA1	A0 [15:8]	A0 [7:0]	A0 [15:8]	A0 [7:0]	A1 [15:8]	A1 [7:0]	A0 [15:8]	A0 [7:0]	A10 [15:8]	A10 [7:0]	AQ0 [15:8]	AQ0 [7:0]	A10 [15:8]	A10 [7:0]	A0 [15:8]	A0 [7:0]	B0 [15:8]	B0 [7:0]
DA2																		
DA3																		
DB0	B1 [15:8]	B1 [7:0]												BQ0 [15:8]	BQ0 [7:0]			
DB1	B0 [15:8]	B0 [7:0]	B0 [15:8]	B0 [7:0]	B1 [15:8]	B1 [7:0]	B0 [15:8]	B0 [7:0]	B10 [15:8]	B10 [7:0]	BQ0 [15:8]	BQ0 [7:0]	B10 [15:8]	B10 [7:0]				
DB2																		
DB3																		

表 8-14. Program Summary of DDC Modes and JESD Link Configuration

LMFS OPTIONS				DDC MODES PROGRAMMING				JESD LINK (LMFS) PROGRAMMING						
L	M	F	S	DECIMATION OPTIONS	DEC MODE EN, DECFIL EN ⁽¹⁾	DECFIL MODE[3:0] ⁽²⁾	JESD FILTER ⁽³⁾	JESD MODE ⁽⁴⁾	JESD PLL MODE ⁽⁵⁾	LANE SHARE ⁽⁶⁾	DA_BUS_REORDER ⁽⁷⁾	DB_BUS_REORDER ⁽⁸⁾	BUS_REORDER EN1 ⁽⁹⁾	BUS_REORDER EN2 ⁽¹⁰⁾
4	2	1	1	No decimation	00	00	000	100	10	0	00h	00h	0	0
4	2	4	4	No decimation	00	00	000	010	10	0	00h	00h	0	0
8	2	2	4	No decimation (default after reset)	00	00	000	001	00	0	00h	00h	0	0
4	4	2	1	4X (IQ)	11	0011 (LPF with $f_s / 4$ mixer)	111	001	00	0	0Ah	0Ah	1	1
4	2	2	2	2X	11	0010 (LPF) or 0110 (HPF)	110	001	00	0	0Ah	0Ah	1	1
2	2	4	2	2X	11	0010 (LPF) or 0110 (HPF)	110	010	10	0	0Ah	0Ah	1	1
2	2	2	1	4X	11	0000, 0100, 1000, or 1100 (all BPFs with different center frequencies).	100	001	00	0	0Ah	0Ah	1	1
2	4	4	1	4X (IQ)	11	0011 (LPF with an $f_s / 4$ mixer)	111	010	10	0	0Ah	0Ah	1	1
1	2	4	1	4X	11	0000, 0100, 1000, or 1100 (all BPFs with different center frequencies)	100	010	10	1	0Ah	0Ah	1	1

- (1) The DEC MODE EN and DECFIL EN register bits are located in the main digital page, register 04Dh (bit 3) and register 041h (bit 4).
- (2) The DECFIL MODE[3:0] register bits are located in the main digital page, register 041h (bits 5 and 2-0).
- (3) The JESD FILTER register bits are located in the JESD digital page, register 001h (bits 5-3).
- (4) The JESD MODE register bits are located in the JESD digital page, register 001h (bits 2:0).
- (5) The JESD PLL MODE register bits are located in the JESD analog page, register 016h (bits 1-0).
- (6) The LANE SHARE register bit is located in the JESD digital page, register 016h (bit 4).
- (7) The DA_BUS_REORDER register bits are located in the JESD digital page, register 031h (bits 7-0).
- (8) The DB_BUS_REORDER register bits are located in the JESD digital page, register 032h (bits 7-0).
- (9) The BUS_REORDER EN1 register bit is located in the main digital page, register 052h (bit 7).
- (10) The BUS_REORDER EN2 register bit is located in the main digital page, register 072h (bit 3).

8.4.3.4.1 JESD Transmitter Interface

Each of the 10-Gbps SERDES JESD transmitter outputs requires ac coupling between the transmitter and receiver. The differential pair must be terminated with 100-Ω resistors as close to the receiving device as possible to avoid unwanted reflections and signal degradation, as shown in 图 8-22.



图 8-22. Output Connection to Receiver

8.4.3.4.2 Eye Diagrams

图 8-23 到 图 8-26 显示 ADS54J40 在 5.0 Gbps 和 10 Gbps 下的串行输出眼图，分别显示了默认和增加输出电压摆幅的情况，并与 JESD204B 掩模进行了对比。

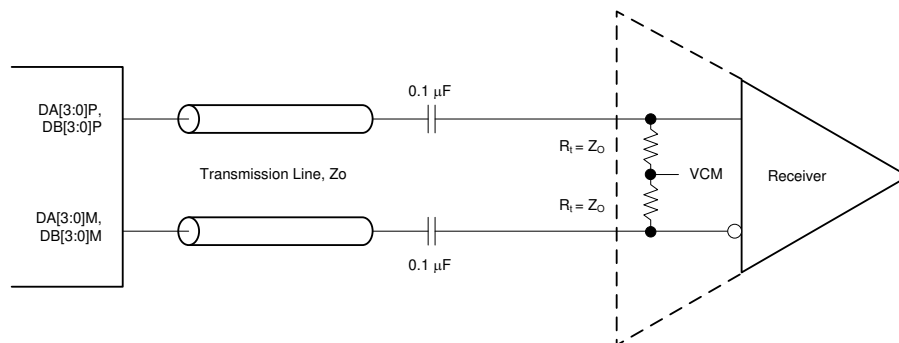

图 8-23. Eye at 5-Gbps Bit Rate with Default Output Swing



图 8-24. Eye at 5-Gbps Bit Rate with Increased Output Swing

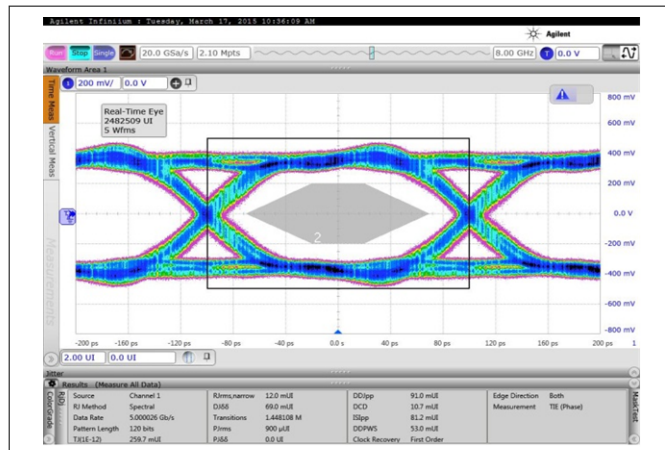

图 8-25. Eye at 10-Gbps Bit Rate with Default Output Swing

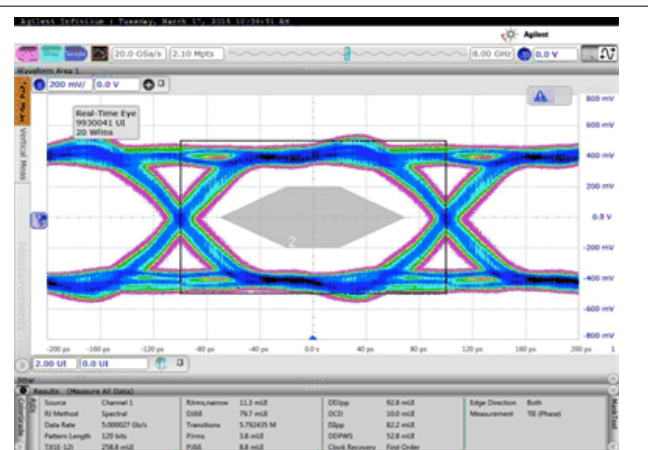

图 8-26. Eye at 10-Gbps Bit Rate with Increased Output Swing

8.5 Register Maps

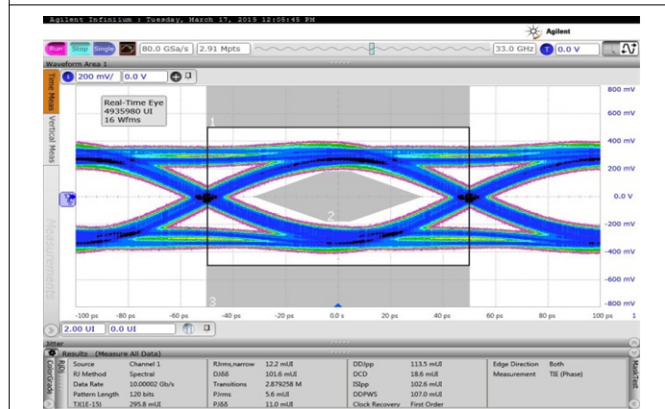
图 8-27 shows a conceptual diagram of the serial registers.

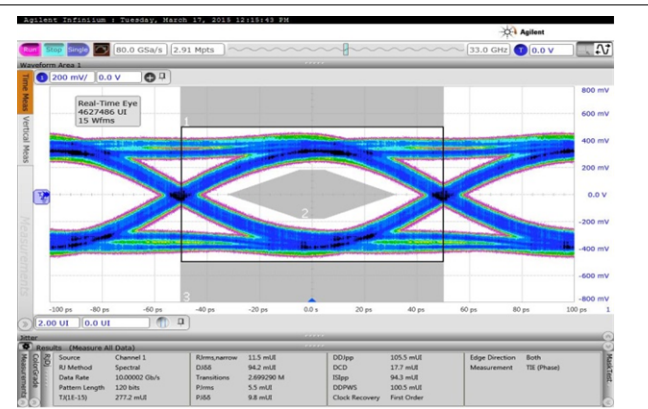

图 8-27. Serial Interface Registers

The ADS54J40 contains two main SPI banks. The analog SPI bank gives access to the ADC analog blocks and the digital SPI bank controls the interleaving engine and anything related to the JESD204B serial interface. The analog SPI bank is divided into two pages (master and ADC) and the digital SPI bank is divided into three pages (main digital, JESD digital, and JESD analog). 表 8-15 lists a register map for the ADS54J40.

表 8-15. Register Map

REGISTER ADDRESS	REGISTER DATA ⁽¹⁾								
	A[11:0] (Hex)	7	6	5	4	3	2	1	0
GENERAL REGISTERS									
0	RESET	0	0	0	0	0	0	0	RESET
1	JESD BANK PAGE SEL1[7:0]								
2	JESD BANK PAGE SEL1[15:8]								
3	JESD BANK PAGE SEL[7:0]								
4	JESD BANK PAGE SEL[15:8]								
5	0	0	0	0	0	0	0	0	DISABLE BROADCAST
11	ANALOG BANK PAGE SEL								
MASTER PAGE (80h)									
20	PDN ADC CHA				PDN ADC CHB				
21	PDN BUFFER CHB		PDN BUFFER CHA		0	0	0	0	
23	PDN ADC CHA				PDN ADC CHB				
24	PDN BUFFER CHB		PDN BUFFER CHA		0	0	0	0	
26	GLOBAL PDN	OVERRIDE PDN PIN	PDN MASK SEL	0	0	0	0	0	
4F	0	0	0	0	0	0	0	0	EN INPUT DC COUPLING
53	0	0	0	0	0	0	0	0	EN SYSREF DC COUPLING SET SYSREF
54	ENABLE MANUAL SYSREF	0	MASK SYSREF	MASK SYSREF	0	0	0	0	0
55	0	0	0	PDN MASK	0	0	0	0	0
59	FOVR CHB	0	ALWAYS WRITE 1	0	0	0	0	0	0
ADC PAGE (0Fh)									
5F	FOVR THRESHOLD PROG								
MAIN DIGITAL PAGE (6800h)									
0	0	0	0	0	0	0	0	0	PULSE RESET
40	IL ENGINE MODE								
41	0	0	DECFIL MODE[3]	DECFIL EN	0	DECFIL MODE[2:0]			
42	0	0	0	0	0	NYQUIST ZONE			
43	0	0	0	0	0	0	0	0	FORMAT SEL

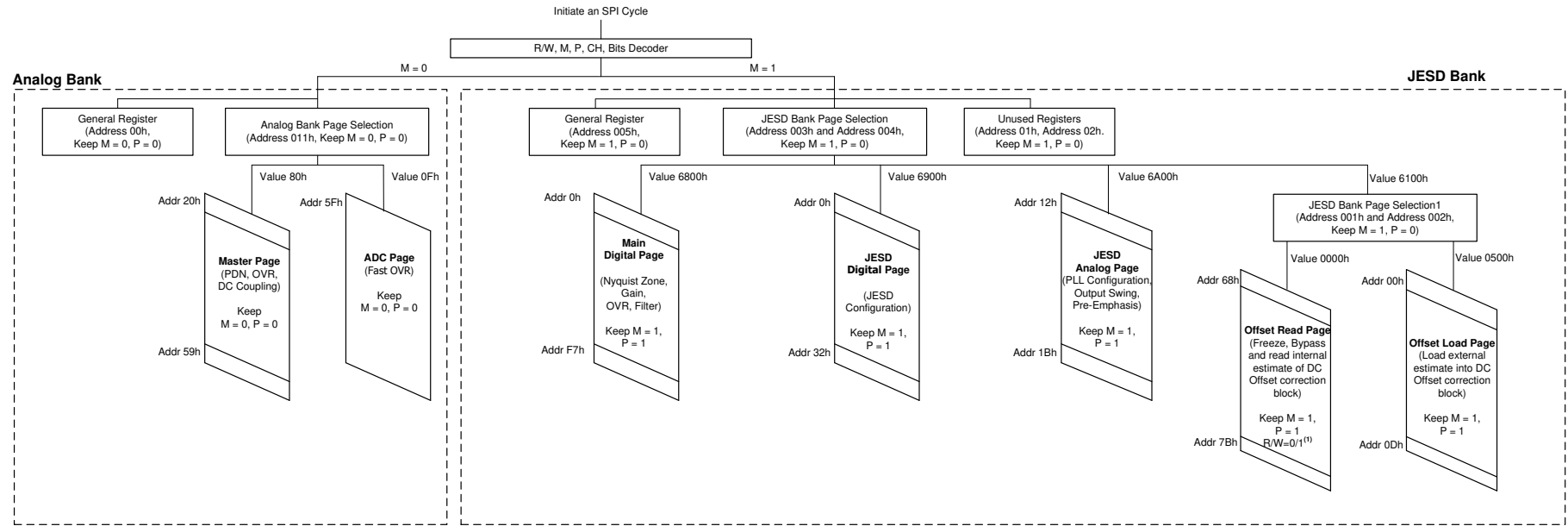
表 8-15. Register Map (continued)

REGISTER ADDRESS	REGISTER DATA ⁽¹⁾							
A[11:0] (Hex)	7	6	5	4	3	2	1	0
44	0	DIGITAL GAIN						
4B	0	0	FORMAT EN	0	0	CTRL IL ENGINE MODE	0	0
4D	0	0	0	0	DEC MODE EN	0	0	CTRL FREEZE IL ENGINE
4E	CTRL NYQUIST	0	IMPROVE IL PERF	0	0	0	0	0
52	BUS_REORDER EN1	0	0	0	0	0	0	DIG GAIN EN
68	0					FREEZE IL ENGINE	0	
72	0	0	0	0	BUS_REORDER EN2	0	0	0
AB	0	0	0	0	0	0	0	LSB SEL EN
AD	0	0	0	0	0	0	LSB SELECT	
F7	0	0	0	0	0	0	0	DIG RESET
JESD DIGITAL PAGE (6900h)								
0	CTRL K	0	0	TESTMODE EN	FLIP ADC DATA	LANE ALIGN	FRAME ALIGN	TX LINK DIS
1	SYNC REG	SYNC REG EN	JESD FILTER			JESD MODE		
2	LINK LAYER TESTMODE			LINK LAYER RPAT	LMFC MASK RESET	0	0	0
3	FORCE LMFC COUNT	LMFC COUNT INIT				RELEASE ILANE SEQ		
5	SCRAMBLE EN	0	0	0	0	0	0	0
6	0	0	0	FRAMES PER MULTI FRAME (K)				
7	0	0	0	0	SUBCLASS	0	0	0
16	ALWAYS WRITE 1	0	0	LANE SHARE	0	0	0	0
31	DA_BUS_REORDER[7:0]							
32	DB_BUS_REORDER[7:0]							
JESD ANALOG PAGE (JESD BANK PAGE SEL = 6A00h)								
12	SEL EMP LANE 1						ALWAYS WRITE 1	0
13	SEL EMP LANE 0						0	0
14	SEL EMP LANE 2						0	0
15	SEL EMP LANE 3						0	0

表 8-15. Register Map (continued)

REGISTER ADDRESS	REGISTER DATA ⁽¹⁾									
	A[11:0] (Hex)	7	6	5	4	3	2	1	0	
16	0	0	0	0	0	0	0	JESD PLL MODE		
17	0	PLL RESET	LANE PDN 1	0	LANE PDN 0	0	0	0	0	
1A	0	0	0	0	0	0	FOVR CHA	0	0	
1B	JESD SWING			0	FOVR CHA EN	0	0	0	0	
OFFSET READ PAGE (JESD BANK PAGE SEL = 6100h, JESD BANK PAGE SEL1 = 0000h)										
68	FREEZE CORR	DC OFFSET CORR BW	DC OFFSET CORR BW	DC OFFSET CORR BW	DC OFFSET CORR BW	BYPASS CORR	ALWAYS WRITE 1	0	0	
69	0	0	0	0	0	0	0	0	EXT CORR EN	
74	ADC0_CORR_INT_EST[7:0]									
75	0	0	0	0	0	ADC0_CORR_INT_EST[10:8]				
76	ADC1_CORR_INT_EST[7:0]									
77	0	0	0	0	0	ADC1_CORR_INT_EST[10:8]				
78	ADC2_CORR_INT_EST[7:0]									
79	0	0	0	0	0	ADC2_CORR_INT_EST[10:8]				
7A	ADC3_CORR_INT_EST[7:0]									
7B	0	0	0	0	0	ADC3_CORR_INT_EST[10:8]				
OFFSET LOAD PAGE (JESD BANK PAGE SEL = 6100h, JESD BANK PAGE SEL1 = 0500h)										
00	ADC0_LOAD_INT_EST[7:0]									
01	0	0	0	0	0	ADC0_CORR_INT_EST[10:8]				
04	ADC1_LOAD_INT_EST[7:0]									
05	0	0	0	0	0	ADC1_CORR_INT_EST[10:8]				
08	ADC2_LOAD_INT_EST[7:0]									
09	0	0	0	0	0	ADC2_CORR_INT_EST[10:8]				
0C	ADC3_LOAD_INT_EST[7:0]									
0D	0	0	0	0	0	ADC3_CORR_INT_EST[10:8]				
78h	0	0	0	0	0	IL ENGINE FREEZE SECONDARY CONTROL				

(1) X = Don't care

8.5.1 Example Register Writes

This section provides three different example register writes. 表 8-16 describes a global power-down register write, 表 8-17 describes the register writes when the default lane setting (eight active lanes per device) is changed to four active lanes (LMFS = 4211), and 表 8-18 describes the register writes for 2X decimation with four active lanes (LMFS = 4222).

表 8-16. Global Power Down

ADDRESS (Hex)	DATA (Hex)	COMMENT
0-011h	80h	Set the master page
0-026h	C0h	Set the global power-down

表 8-17. Two Lanes per Channel Mode (LMFS = 4211)

ADDRESS (Hex)	DATA (Hex)	COMMENT
4-004h	69h	Select the JESD digital page
4-003h	00h	Select the JESD digital page
6-001h	02h	Select the digital to 40X mode
4-004h	6Ah	Select the JESD analog page
6-016h	02h	Set the SERDES PLL to 40X mode

表 8-18. 2X Decimation (LPF for Both Channels) with Four Active Lanes (LMFS = 4222)

ADDRESS (Hex)	DATA (Hex)	COMMENT
4-004h	68h	Select the main digital page (6800h)
4-003h	00h	Select the main digital page (6800h)
6-041h	12h	Set decimate-by-2 (low-pass filter)
6-04Dh	08h	Enable decimation filter control
6-072h	08h	BUS_REORDER EN2
6-052h	80h	BUS_REORDER EN1
6-000h	01h	Pulse the PULSE RESET bit (so that register writes to the main digital page go into effect).
6-000h	00h	
4-004h	69h	Select the JESD digital page (6900h)
4-003h	00h	Select the JESD digital page (6900h)
6-031h	0Ah	Output bus reorder for channel A
6-032h	0Ah	Output bus reorder for channel B
6-001h	31h	Program the JESD MODE and JESD FILTER register bits for LMFS = 4222.

表 8-19 lists the access codes for the ADS54J40 registers.

表 8-19. ADS54J40 Access Type Codes

Access Type	Code	Description
R	R	Read
R-W	R/W	Read or write
W	W	Write
-n		Value after reset or the default value

8.5.2 Register Descriptions

8.5.2.1 General Registers

8.5.2.1.1 Register 0h (address = 0h)

图 8-22. Register 0h

7	6	5	4	3	2	1	0
RESET	0	0	0	0	0	0	RESET
W-0h	W-0h	W-0h	W-0h	W-0h	W-0h	W-0h	W-0h

表 8-20. Register 0h Field Descriptions

Bit	Field	Type	Reset	Description
7	RESET	W	0h	0 = Normal operation 1 = Internal software reset, clears back to 0
6-1	0	W	0h	Must write 0
0	RESET	W	0h	0 = Normal operation 1 = Internal software reset, clears back to 0

8.5.2.1.2 Register 1h (address = 1h)

图 8-23. Register 1h

7	6	5	4	3	2	1	0
JESD BANK PAGE SEL1[7:0]							
R/W-0h							

表 8-21. Register 1h Field Descriptions

Bit	Field	Type	Reset	Description
7-0	JESD BANK PAGE SEL1[7:0]	R/W	0h	Program these bits to access the desired page in the JESD bank. 0000h = OFFSET READ Page 0500h = OFFSET LOAD Page

8.5.2.1.3 Register 2h (address = 2h)

图 8-24. Register 2h

7	6	5	4	3	2	1	0
JESD BANK PAGE SEL1[15:8]							
R/W-0h							

表 8-22. Register 2h Field Descriptions

Bit	Field	Type	Reset	Description
7-0	JESD BANK PAGE SEL1[15:8]	R/W	0h	Program these bits to access the desired page in the JESD bank. 0000h = OFFSET READ Page 0500h = OFFSET LOAD Page

8.5.2.1.4 Register 3h (address = 3h)

图 8-25. Register 3h

7	6	5	4	3	2	1	0
JESD BANK PAGE SEL[7:0]							
R/W-0h							

表 8-23. Register 3h Field Descriptions

Bit	Field	Type	Reset	Description
7-0	JESD BANK PAGE SEL[7:0]	R/W	0h	Program these bits to access the desired page in the JESD bank. 6800h = Main digital page selected 6900h = JESD digital page selected 6A00h = JESD analog page selected 6100h = OFFSET READ or LOAD Page

8.5.2.1.5 Register 4h (address = 4h)

图 8-26. Register 4h



表 8-24. Register 4h Field Descriptions

Bit	Field	Type	Reset	Description
7-0	JESD BANK PAGE SEL[15:8]	R/W	0h	Program these bits to access the desired page in the JESD bank. 6800h = Main digital page selected 6900h = JESD digital page selected 6A00h = JESD analog page selected 6100h = OFFSET READ or LOAD Page

8.5.2.1.6 Register 5h (address = 5h)

图 8-27. Register 5h

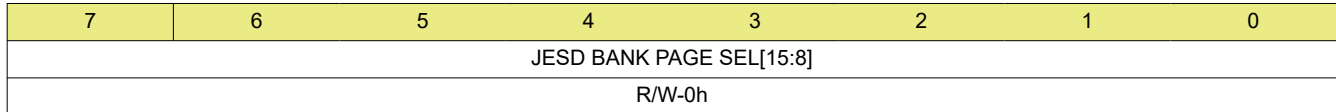
7	6	5	4	3	2	1	0
0	0	0	0	0	0	0	DISABLE BROADCAST
W-0h	W-0h	W-0h	W-0h	W-0h	W-0h	W-0h	R/W-0h

表 8-25. Register 5h Field Descriptions

Bit	Field	Type	Reset	Description
7-1	0	W	0h	Must write 0
0	DISABLE BROADCAST	R/W	0h	0 = Normal operation. Channel A and B are programmed as a pair. 1 = Channel A and B can be individually programmed based on the CH bit.

8.5.2.1.7 Register 11h (address = 11h)

图 8-28. Register 11h

7	6	5	4	3	2	1	0
ANALOG PAGE SELECTION							
R/W-0h							

表 8-26. Register 11h Field Descriptions

Bit	Field	Type	Reset	Description
7-0	ANALOG BANK PAGE SEL	R/W	0h	Program these bits to access the desired page in the analog bank. Master page = 80h ADC page = 0Fh

8.5.2.2 Master Page (080h) Registers

8.5.2.2.1 Register 20h (address = 20h), Master Page (080h)

图 8-29. Register 20h

7	6	5	4	3	2	1	0
PDN ADC CHA				PDN ADC CHB			
R/W-0h				R/W-0h			

表 8-27. Registers 20h Field Descriptions

Bit	Field	Type	Reset	Description
7-4	PDN ADC CHA	R/W	0h	There are two power-down masks that are controlled through the PDN mask register bit in address 55h. The power-down mask 1 or mask 2 are selected via register bit 5 in address 26h. Power-down mask 1: addresses 20h and 21h. Power-down mask 2: addresses 23h and 24h. 0Fh = Power-down CHB only. F0h = Power-down CHA only. FFh = Power-down both.
3-0	PDN ADC CHB	R/W	0h	

8.5.2.2.2 Register 21h (address = 21h), Master Page (080h)

图 8-30. Register 21h

7	6	5	4	3	2	1	0
PDN BUFFER CHB		PDN BUFFER CHA		0	0	0	0
R/W-0h		R/W-0h		W-0h	W-0h	W-0h	W-0h

表 8-28. Register 21h Field Descriptions

Bit	Field	Type	Reset	Description
7-6	PDN BUFFER CHB	R/W	0h	There are two power-down masks that are controlled through the PDN mask register bit in address 55h. The power-down mask 1 or mask 2 are selected via register address 26h, bit 5. Power-down mask 1: addresses 20h and 21h. Power-down mask 2: addresses 23h and 24h. There are two buffers per channel. One buffer drives two ADC cores. PDN BUFFER CHx: 00 = Both buffers of a channel are active. 11 = Both buffers are powered down. 01 - 10 = Do not use.
5-4	PDN BUFFER CHA	R/W	0h	
3-0	0	W	0h	Must write 0.

8.5.2.2.3 Register 23h (address = 23h), Master Page (080h)

图 8-31. Register 23h

7	6	5	4	3	2	1	0
PDN ADC CHA				PDN ADC CHB			
R/W-0h				R/W-0h			

表 8-29. Register 23h Field Descriptions

Bit	Field	Type	Reset	Description
7-4	PDN ADC CHA	R/W	0h	There are two power-down masks that are controlled through the PDN mask register bit in address 55h. The power-down mask 1 or mask 2 are selected via register address 26h, bit 5. Power-down mask 1: addresses 20h and 21h. Power-down mask 2: addresses 23h and 24h. 0Fh = Power-down CHB only. F0h = Power-down CHA only. FFh = Power-down both.
3-0	PDN ADC CHB	R/W	0h	

8.5.2.2.4 Register 24h (address = 24h), Master Page (080h)

图 8-32. Register 24h

7	6	5	4	3	2	1	0
PDN BUFFER CHB		PDN BUFFER CHA		0	0	0	0
R/W-0h		R/W-0h		W-0h	W-0h	W-0h	W-0h

表 8-30. Register 24h Field Descriptions

Bit	Field	Type	Reset	Description
7-6	PDN BUFFER CHB	R/W	0h	<p>There are two power-down masks that are controlled through the PDN mask register bit in address 55h. The power-down mask 1 or mask 2 are selected via register address 26h, bit 5.</p> <p>Power-down mask 1: addresses 20h and 21h.</p> <p>Power-down mask 2: addresses 23h and 24h.</p> <p>Power-down mask 2: addresses 23h and 24h.</p> <p>There are two buffers per channel. One buffer drives two ADC cores.</p> <p>PDN BUFFER CHx: 00 = Both buffers of a channel are active. 11 = Both buffers are powered down. 01 - 10 = Do not use.</p>
5-4	PDN BUFFER CHA	R/W	0h	
3-0	0	W	0h	Must write 0.

8.5.2.2.5 Register 26h (address = 26h), Master Page (080h)

表 8-31. Register 26h

7	6	5	4	3	2	1	0
GLOBAL PDN	OVERRIDE PDN PIN	PDN MASK SEL	0	0	0	0	0
R/W-0h	R/W-0h	R/W-0h	W-0h	W-0h	W-0h	W-0h	W-0h

表 8-32. Register 26h Field Descriptions

Bit	Field	Type	Reset	Description
7	GLOBAL PDN	R/W	0h	Bit 6 (OVERRIDE PDN PIN) must be set before this bit can be programmed. 0 = Normal operation 1 = Global power-down through the SPI
6	OVERRIDE PDN PIN	R/W	0h	This bit ignores the power-down pin control. 0 = Normal operation 1 = Ignores inputs on the power-down pin
5	PDN MASK SEL	R/W	0h	This bit selects power-down mask 1 or mask 2. 0 = Power-down mask 1 1 = Power-down mask 2
4-0	0	W	0h	Must write 0

8.5.2.2.6 Register 4Fh (address = 4Fh), Master Page (080h)

表 8-33. Register 4Fh

7	6	5	4	3	2	1	0
0	0	0	0	0	0	0	EN INPUT DC COUPLING
W-0h	W-0h	W-0h	W-0h	W-0h	W-0h	W-0h	R/W-0h

表 8-34. Register 4Fh Field Descriptions

Bit	Field	Type	Reset	Description
7-1	0	W	0h	Must write 0
0	EN INPUT DC COUPLING	R/W	0h	The device has an internal biasing resistor of 600 Ω from VCM to the INP and INM pins. A small common-mode current flows through these resistors causing approximately a 100-mV drop. To compensate for the drop, the device raises the VCM voltage by 100-mV by default. This compensation is particularly helpful in AC-coupling applications where the common-mode voltage on the INP and INM pins is established by internal biasing resistors. In DC-coupling applications, because the common-mode voltage is established by an external circuit, there is no need to raise VCM by 100-mV. 0 = Device raises VCM voltage by 100 mV, useful in AC-coupling applications 1 = Device does not raise the VCM voltage, useful in DC-coupling applications.

8.5.2.2.7 Register 53h (address = 53h), Master Page (080h)

表 8-35. Register 53h

7	6	5	4	3	2	1	0
0	0	0	0	0	0	EN SYSREF DC COUPLING	SET SYSREF
W-0h	W-0h	W-0h	W-0h	W-0h	W-0h	R/W-0h	R/W-0h

表 8-36. Register 53h Field Descriptions

Bit	Field	Type	Reset	Description
7:2	0	W	0h	Must write 0
1	EN SYSREF DC COUPLING	R/W	0h	This bit enables a higher common-mode voltage input on the SYSREF signal (up to 1.6 V). 0 = Normal operation 1 = Enables a higher SYSREF common-mode voltage support
0	MANUAL SYSREF	R/W	0h	The device has a feature to apply the SYSREF signal manually through the serial interface instead of the SYSREFP, SYSREFM pins. This application can be done by first setting the ENABLE MANUAL SYSREF register bit, then using the MANUAL SYSREF bit to set the SYSREF signal high or low. 0 = Set SYSREF low 1 = Set SYSREF high

8.5.2.2.8 Register 54h (address = 54h), Master Page (080h)

图 8-33. Register 54h

7	6	5	4	3	2	1	0
ENABLE MANUAL SYSREF	0	MASK SYSREF	MASK SYSREF	0	0	0	0
R/W-0h	W-0h	W-0h	R/W-0h	W-0h	W-0h	W-0h	W-0h

表 8-37. Register 54h Field Descriptions

Bit	Field	Type	Reset	Description
7	ENABLE MANUAL SYSREF	R/W	0h	This bit enables manual SYSREF
6	0	W	0h	Must write 0
5-4	MASK SYSREF	R/W	0h	00 = Normal operation 11 = The SYSREF signal is ignored by the device irrespective of how the signal was applied (through a pin or manually by the serial interface) 01 and 10 = Not applicable
3-0	0	W	0h	Must write 0

8.5.2.2.9 Register 55h (address = 55h), Master Page (080h)

表 8-38. Register 55h

7	6	5	4	3	2	1	0
0	0	0	PDN MASK	0	0	0	0
W-0h	W-0h	W-0h	R/W-0h	W-0h	W-0h	W-0h	W-0h

表 8-39. Register 55h Field Descriptions

Bit	Field	Type	Reset	Description
7-5	0	W	0h	Must write 0
4	PDN MASK	R/W	0h	This bit enables power-down via a register bit. 0 = Normal operation 1 = Power-down is enabled by powering down the internal blocks as specified in the selected power-down mask
3-0	0	W	0h	Must write 0

8.5.2.2.10 Register 59h (address = 59h), Master Page (080h)

图 8-34. Register 59h

7	6	5	4	3	2	1	0
FOVR CHB	0	ALWAYS WRITE 1	0	0	0	0	0
W-0h	W-0h	R/W-0h	W-0h	W-0h	W-0h	W-0h	W-0h

表 8-40. Register 59h Field Descriptions

Bit	Field	Type	Reset	Description
7	FOVR CHB	W	0h	This bit outputs the FOVR signal for channel B on the SDOUT pin. 0 = Normal operation 1 = The FOVR signal is available on the SDOUT pin
6	0	W	0h	Must write 0
5	ALWAYS WRITE 1	R/W	0h	Must write 1
4-0	0	W	0h	Must write 0

8.5.2.3 ADC Page (0Fh) Register

8.5.2.3.1 Register 5F (addresses = 5F), ADC Page (0Fh)

图 8-35. Register 5F

7	6	5	4	3	2	1	0
FOVR THRESHOLD PROG							
R/W-E3h							

表 8-41. Register 5F Field Descriptions

Bit	Field	Type	Reset	Description
7-0	FOVR THRESHOLD PROG	R/W	E3h	Program the fast OVR thresholds together for channel A and B, as described in the Overrange Indication section.

8.5.2.4 Main Digital Page (6800h) Registers

8.5.2.4.1 Register 0h (address = 0h), Main Digital Page (6800h)

表 8-42. Register 0h

7	6	5	4	3	2	1	0
0	0	0	0	0	0	0	PULSE RESET
W-0h	W-0h	W-0h	W-0h	W-0h	W-0h	W-0h	R/W-0h

表 8-43. Register 0h Field Descriptions

Bit	Field	Type	Reset	Description
7-1	0	W	0h	Must write 0
0	PULSE RESET	R/W	0h	This bit must be pulsed after power-up or after configuring registers in the main digital page of the JESD bank. Any register bits in the main digital page (6800h) take effect only after this bit is pulsed; see the Start-Up Sequence section for the correct sequence. 0 = Normal operation 0 → 1 → 0 = This bit is pulsed

8.5.2.4.2 Register 40h (address = 40h), Main Digital Page (6800h)

表 8-44. Register 40h

7	6	5	4	3	2	1	0
IL ENGINE MODE							
W-0h							

表 8-45. Register 40h Field Descriptions

Bit	Field	Type	Reset	Description
7-0	IL ENGINE MODE	W	0h	Specifies the Interleaving Engine Mode 0 = Interleaving Engine is enabled 8 = Interleaving Engine is disabled Other Values = Reserved Note that for this register setting to take effect, CTRL IL ENGINE field should be set to 1

8.5.2.4.3 Register 41h (address = 41h), Main Digital Page (6800h)

图 8-36. Register 41h

7	6	5	4	3	2	1	0
0	0	DECFIL MODE[3]	DECFIL EN	0	DECFIL MODE[2:0]		
W-0h	W-0h	R/W-0h	R/W-0h	W-0h	R/W-0h		

表 8-46. Register 41h Field Descriptions

Bit	Field	Type	Reset	Description
7-6	0	W	0h	Must write 0
5	DECFIL MODE[3]	R/W	0h	This bit selects the decimation filter mode. 表 8-47 lists the bit settings. The decimation filter control (DEC MODE EN, register 4Dh, bit 3) and decimation filter enable (DECFIL EN, register 41h, bit 4) must be enabled.
4	DECFIL EN	R/W	0h	This bit enables the digital decimation filter. 0 = Normal operation, full rate output 1 = Digital decimation enabled
3	0	W	0h	Must write 0
2-0	DECFIL MODE[2:0]	R/W	0h	These bits select the decimation filter mode. 表 8-47 lists the bit settings. The decimation filter control (DEC MODE EN, register 4Dh, bit 3) and decimation filter enable (DECFIL EN, register 41h, bit 4) must be enabled.

表 8-47. DECFIL MODE Bit Settings

BITS (5, 2-0)	FILTER MODE	DECIMATION
0000	Band-pass filter centered on $3 \times f_S / 16$	4X
0100	Band-pass filter centered on $5 \times f_S / 16$	4X
1000	Band-pass filter centered on $1 \times f_S / 16$	4X
1100	Band-pass filter centered on $7 \times f_S / 16$	4X
0010	Low-pass filter	2X
0110	High-pass filter	2X
0011	Low-pass filter with $f_S / 4$ mixer	4X (IQ)

8.5.2.4.4 Register 42h (address = 42h), Main Digital Page (6800h)

表 8-48. Register 42h

7	6	5	4	3	2	1	0
0	0	0	0	0	NYQUIST ZONE		
W-0h	W-0h	W-0h	W-0h	W-0h	R/W-0h		

表 8-49. Register 42h Field Descriptions

Bit	Field	Type	Reset	Description
7-3	0	W	0h	Must write 0
2-0	NYQUIST ZONE	R/W	0h	The Nyquist zone must be selected for proper interleaving correction. The CONTROL NYQUIST register bit (register 4Eh, bit 7) must be enabled to use these bits. 000 = 1st Nyquist zone (0 MHz to 500 MHz) 001 = 2nd Nyquist zone (500 MHz to 1000 MHz) 010 = 3rd Nyquist zone (1000 MHz to 1500 MHz) All others = Not used

8.5.2.4.5 Register 43h (address = 43h), Main Digital Page (6800h)

图 8-37. Register 43h

7	6	5	4	3	2	1	0
0	0	0	0	0	0	0	FORMAT SEL
W-0h	W-0h	W-0h	W-0h	W-0h	W-0h	W-0h	R/W-0h

表 8-50. Register 43h Field Descriptions

Bit	Field	Type	Reset	Description
7-1	0	W	0h	Must write 0
0	FORMAT SEL	R/W	0h	This bit changes the output format. Set the FORMAT EN bit to enable control using this bit. 0 = Twos complement 1 = Offset binary

8.5.2.4.6 Register 44h (address = 44h), Main Digital Page (6800h)

图 8-38. Register 44h

7	6	5	4	3	2	1	0
0	DIGITAL GAIN						
R/W-0h	R/W-0h						

表 8-51. Register 44h Field Descriptions

Bit	Field	Type	Reset	Description
7	0	R/W	0h	Must write 0
6-0	DIGITAL GAIN	R/W	0h	These bits set the digital gain setting. The DIG GAIN EN register bit (register 52h, bit 0) must be enabled to use these bits. Gain in dB = 20log (digital gain / 32) 7Fh = 127 equals a digital gain of 9.5 dB

8.5.2.4.7 Register 4Bh (address = 4Bh), Main Digital Page (6800h)

图 8-39. Register 4Bh

7	6	5	4	3	2	1	0
0	0	FORMAT EN	0	0	CTRL IL ENGINE MODE	0	0
W-0h	W-0h	R/W-0h	W-0h	W-0h	R/W-0h	W-0h	W-0h

表 8-52. Register 4Bh Field Descriptions

Bit	Field	Type	Reset	Description
7-6	0	W	0h	Must write 0
5	FORMAT EN	R/W	0h	This bit enables control for data format selection using the FORMAT SEL register bit. 0 = Default, output is in twos complement format 1 = Output is in offset binary format after the FORMAT SEL bit is set
4-3	0	W	0h	Must write 0
2	CTRL IL ENGINE MODE	R/W	0h	This bit enables control of interleaving engine mode selection using the IL ENGINE Mode register field. 0 = Default. IL Engine Mode (IL Engine enabled) 1 = IL Engine Mode is determined from IL ENGINE MODE field setting.
1-0	0	W	0h	Must write 0

8.5.2.4.8 Register 4Dh (address = 4Dh), Main Digital Page (6800h)

图 8-40. Register 4Dh

7	6	5	4	3	2	1	0
0	0	0	0	DEC MOD EN	0	0	CTRL FREEZE IL ENGINE
W-0h	W-0h	W-0h	W-0h	R/W-0h	W-0h	W-0h	R/W-0h

表 8-53. Register 4Dh Field Descriptions

Bit	Field	Type	Reset	Description
7-4	0	W	0h	Must write 0
3	DEC MOD EN	R/W	0h	This bit enables control of decimation filter mode through the DECFIL MODE[3:0] register bits. 0 = Default 1 = Decimation mode control is enabled
2-1	0	W	0h	Must write 0
0	CTRL FREEZE IL ENGINE	R/W	0h	This bit enables control of interleaving engine freeze/unfreeze state using the FREEZE IL ENGINE register field. 0 = IL Engine continues in its current state (either frozen or unfrozen). 1 = IL Engine state enters a frozen or unfrozen state base on FREEZE IL ENGINE register field setting.

8.5.2.4.9 Register 4Eh (address = 4Eh), Main Digital Page (6800h)

图 8-41. Register 4Eh

7	6	5	4	3	2	1	0
CTRL NYQUIST	0	IMPROVE IL PERF	0	0	0	0	0
R/W-0h	W-0h	R/W-0h	W-0h	W-0h	W-0h	W-0h	W-0h

表 8-54. Register 4Eh Field Descriptions

Bit	Field	Type	Reset	Description
7	CTRL NYQUIST	R/W	0h	This bit enables selecting the Nyquist zone using register 42h, bits 2-0. 0 = Selection disabled 1 = Selection enabled
6	0	W	0h	Must write 0
5	IMPROVE IL PERF	R/W	0h	Improves interleaving performance. Effective only for input frequencies that are within $\pm f_s / 64$ band centered at $n * f_s / 8$ ($n = 1, 2, 3$ or 4). For example, at a 1-Gsps sampling rate, this bit may improve IL performance when the input frequencies fall within ± 15.625 MHz band located at 125 MHz, 250 MHz, 375 MHz and 500 MHz. 0 = Default 1 = Improves IL performance for certain input frequencies
6-0	0	W	0h	Must write 0

8.5.2.4.10 Register 52h (address = 52h), Main Digital Page (6800h)

图 8-42. Register 52h

7	6	5	4	3	2	1	0
BUS_REORDER_EN1	0	0	0	0	0	0	DIG GAIN EN
R/W-0h	W-0h	W-0h	W-0h	W-0h	W-0h	W-0h	R/W-0h

表 8-55. Register 52h Field Descriptions

Bit	Field	Type	Reset	Description
7	BUS_REORDER_EN1	R/W	0h	Must write 1 in DDC mode only
6-1	0	W	0h	Must write 0
0	DIG GAIN EN	R/W	0h	Enables selecting the digital gain for register 44h. 0 = Digital gain disabled 1 = Digital gain enabled

8.5.2.4.11 Register 68h (address = 68h), Main Digital Page (6800h)

图 8-43. Register 68h

7	6	5	4	3	2	1	0
		0	FREEZE IL ENGINE			0	
		W-0h	W-0h			W-0h	

表 8-56. Register 68h Field Descriptions

Bit	Field	Type	Reset	Description
7-3	0	W	0h	Must write 0
2	FREEZE IL ENGINE	W	0h	IL Engine Freeze/Unfreeze Configuration. 0 = IL Engine is unfrozen (i.e. Interleaving Mismatch estimation is resumed) 1 = IL Engine is frozen (i.e. Interleaving Mismatch estimation is frozen, correction continues with estimates computed prior to freeze) Note - 1. Value specified here takes effect when CTRL FREEZE IL ENGINE is 1. 2. For IL Engine to be frozen, register field IL ENGINE FREEZE SECONDARY CONTROL should be set to 0 3. Unlike other register fields in the Main Digital Page, FREEZE IL ENGINE does not need a PULSE RESET to take effect. FREEZE IL ENGINE can be asserted/de-asserted at any time and the setting takes effect immediately.
1-0	0	W	0h	Must write 0

8.5.2.4.12 Register 72h (address = 72h), Main Digital Page (6800h)

图 8-44. Register 72h

7	6	5	4	3	2	1	0
0	0	0	0	BUS_REORDER_EN2	0	0	0
W-0h	W-0h	W-0h	W-0h	R/W-0h	W-0h	W-0h	W-0h

表 8-57. Register 72h Field Descriptions

Bit	Field	Type	Reset	Description
7-4	0	W	0h	Must write 0
3	BUS_REORDER_EN2	R/W	0h	Must write a 1 in DDC mode only
2-0	0	W	0h	Must write 0

8.5.2.4.13 Register ABh (address = ABh), Main Digital Page (6800h)

图 8-45. Register ABh

7	6	5	4	3	2	1	0
0	0	0	0	0	0	0	LSB SEL EN
W-0h	W-0h	W-0h	W-0h	W-0h	W-0h	W-0h	R/W-0h

表 8-58. Register ABh Field Descriptions

Bit	Field	Type	Reset	Description
7-1	0	W	0h	Must write 0
0	LSB SEL EN	R/W	0h	Enable control for the LSB SELECT register bit. 0 = Default 1 = LSB of the 16-bit data (14-bit ADC data padded with two 0s as the LSBs) can be programmed as fast OVR using the LSB SELECT register bit.

8.5.2.4.14 Register ADh (address = ADh), Main Digital Page (6800h)

图 8-46. Register ADh

7	6	5	4	3	2	1	0
0	0	0	0	0	0	LSB SELECT	
W-0h	W-0h	W-0h	W-0h	W-0h	W-0h	R/W-0h	

表 8-59. Register ADh Field Descriptions

Bit	Field	Type	Reset	Description
7-2	0	W	0h	Must write 0
1-0	LSB SELECT	R/W	0h	These bits enable the output of the FOVR flag instead of the output data LSB. Ensure that LSB SEL EN register bit is set to 1. 00 = Output is 16-bit data (14-bit ADC data padded with two 0s as LSBs) 11 = LSB of 16-bit output data is replaced by the FOVR information for each channel.

8.5.2.4.15 Register F7h (address = F7h), Main Digital Page (6800h)

图 8-47. Register F7h

7	6	5	4	3	2	1	0
0	0	0	0	0	0	0	DIG RESET
W-0h	W-0h	W-0h	W-0h	W-0h	W-0h	W-0h	W-0h

表 8-60. Register F7h Field Descriptions

Bit	Field	Type	Reset	Description
7-1	0	W	0h	Must write 0
0	DIG RESET	W	0h	This bit is the self-clearing reset for the digital block and does not include interleaving correction. 0 = Normal operation 1 = Digital reset

8.5.2.5 JESD Digital Page (6900h) Registers

8.5.2.5.1 Register 0h (address = 0h), JESD Digital Page (6900h)

图 8-48. Register 0h

7	6	5	4	3	2	1	0
CTRL K	0	0	TESTMODE EN	FLIP ADC DATA	LANE ALIGN	FRAME ALIGN	TX LINK DIS
R/W-0h	W-0h	W-0h	R/W-0h	R/W-0h	R/W-0h	R/W-0h	R/W-0h

表 8-61. Register 0h Field Descriptions

Bit	Field	Type	Reset	Description
7	CTRL K	R/W	0h	This bit is the enable bit for a number of frames per multi frame. 0 = Default is five frames per multi frame 1 = Frames per multi frame can be set in register 06h
6-5	0	W	0h	Must write 0
4	TESTMODE EN	R/W	0h	This bit generates the long transport layer test pattern mode, as per section 5.1.6.3 of the JESD204B specification. 0 = Test mode disabled 1 = Test mode enabled
3	FLIP ADC DATA	R/W	0h	0 = Normal operation 1 = Output data order is reversed: MSB to LSB.
2	LANE ALIGN	R/W	0h	This bit inserts the lane alignment character (K28.3) for the receiver to align to lane boundary, as per section 5.3.3.5 of the JESD204B specification. 0 = Normal operation 1 = Inserts lane alignment characters
1	FRAME ALIGN	R/W	0h	This bit inserts the lane alignment character (K28.7) for the receiver to align to lane boundary, as per section 5.3.3.5 of the JESD204B specification. 0 = Normal operation 1 = Inserts frame alignment characters
0	TX LINK DIS	R/W	0h	This bit disables sending the initial link alignment (ILA) sequence when SYNC is de-asserted. 0 = Normal operation 1 = ILA disabled

8.5.2.5.2 Register 1h (address = 1h), JESD Digital Page (6900h)

图 8-49. Register 1h

7	6	5	4	3	2	1	0
SYNC REG	SYNC REG EN	JESD FILTER			JESD MODE		
R/W-0h	R/W-0h	R/W-0h			R/W-01h		

表 8-62. Register 1h Field Descriptions

Bit	Field	Type	Reset	Description
7	SYNC REG	R/W	0h	This bit is the register control for the sync request. 0 = Normal operation 1 = ADC output data are replaced with K28.5 characters; the SYNC REG EN register bit must also be set to 1
6	SYNC REG EN	R/W	0h	This bit enables register control for the sync request. 0 = Use the SYNC pin for sync requests 1 = Use the SYNC REG register bit for sync requests
5-3	JESD FILTER	R/W	0h	These bits and the JESD MODE bits set the correct LMFS configuration for the JESD interface. The JESD FILTER setting must match the configuration in the decimation filter page. 000 = Filter bypass mode See 表 8-63 for valid combinations for register bits JESD FILTER along with JESD MODE.
2-0	JESD MODE	R/W	01h	These bits select the number of serial JESD output lanes per ADC. The JESD PLL MODE register bit located in the JESD analog page must also be set accordingly. 001 = Default after reset(Eight active lanes) See 表 8-63 for valid combinations for register bits JESD FILTER along with JESD MODE.

表 8-63. Valid Combinations for JESD FILTER and JESD MODE Bits

REGISTER BIT JESD FILTER	REGISTER BIT JESD MODE	DECIMATION FACTOR	NUMBER OF ACTIVE LANES PER DEVICE
000	100	No decimation	Four lanes are active
000	010	No decimation	Four lanes are active
000	001	No decimation (default after reset)	Eight lanes are active
111	001	4X (1Q)	Four lanes are active
110	001	2X	Four lanes are active
110	010	2X	Two lanes are active
100	001	4X	Two lanes are active
111	010	4X (1Q)	Two lanes are active
100	010	4X	One lane is active

8.5.2.5.3 Register 2h (address = 2h), JESD Digital Page (6900h)

图 8-50. Register 2h

7	6	5	4	3	2	1	0
LINK LAYER TESTMODE		LINK LAYER RPAT		LMFC MASK RESET	0	0	0
R/W-0h		R/W-0h		R/W-0h	W-0h	W-0h	W-0h

表 8-64. Register 2h Field Descriptions

Bit	Field	Type	Reset	Description
7-5	LINK LAYER TESTMODE	R/W	0h	These bits generate a pattern as per section 5.3.3.8.2 of the JESD204B document. 000 = Normal ADC data 001 = D21.5 (high-frequency jitter pattern) 010 = K28.5 (mixed-frequency jitter pattern) 011 = Repeat initial lane alignment (generates a K28.5 character and continuously repeats lane alignment sequences) 100 = 12-octet RPAT jitter pattern All others = Not used
4	LINK LAYER RPAT	R/W	0h	This bit changes the running disparity in the modified RPAT pattern test mode (only when the link layer test mode = 100). 0 = Normal operation 1 = Changes disparity
3	LMFC MASK RESET	R/W	0h	This bit masks the LMFC reset coming to the digital block. 0 = LMFC reset is not masked 1 = Ignore the LMFC reset request
2-0	0	W	0h	Must write 0

8.5.2.5.4 Register 3h (address = 3h), JESD Digital Page (6900h)

图 8-51. Register 3h

7	6	5	4	3	2	1	0
FORCE LMFC COUNT	LMFC COUNT INIT					RELEASE ILANE SEQ	
R/W-0h	R/W-0h					R/W-0h	

表 8-65. Register 3h Field Descriptions

Bit	Field	Type	Reset	Description
7	FORCE LMFC COUNT	R/W	0h	This bit forces the LMFC count. 0 = Normal operation 1 = Enables using a different starting value for the LMFC counter
6-2	LMFC COUNT INIT	R/W	0h	When SYSREF transmits to the digital block, the LMFC count resets to 0 and K28.5 stops transmitting when the LMFC count reaches 31. The initial value that the LMFC count resets to can be set using LMFC COUNT INIT. In this manner, the receiver can be synchronized early because it receives the LANE ALIGNMENT SEQUENCE early. The FORCE LMFC COUNT register bit must be enabled.
1-0	RELEASE ILANE SEQ	R/W	0h	These bits delay the generation of the lane alignment sequence by 0, 1, 2, or 3 multi frames after the code group synchronization. 00 = 0 01 = 1 10 = 2 11 = 3

8.5.2.5.5 Register 5h (address = 5h), JESD Digital Page (6900h)

图 8-52. Register 5h

7	6	5	4	3	2	1	0
SCRAMBLE EN	0	0	0	0	0	0	0
R/W-0h	W-0h	W-0h	W-0h	W-0h	W-0h	W-0h	W-0h

表 8-66. Register 5h Field Descriptions

Bit	Field	Type	Reset	Description
7	SCRAMBLE EN	R/W	0h	This bit is the scramble enable bit in the JESD204B interface. 0 = Scrambling disabled 1 = Scrambling enabled
6-0	0	W	0h	Must write 0

8.5.2.5.6 Register 6h (address = 6h), JESD Digital Page (6900h)

图 8-53. Register 6h

7	6	5	4	3	2	1	0
0	0	0	FRAMES PER MULTI FRAME (K)				
W-0h	W-0h	W-0h	R/W-8h				

表 8-67. Register 6h Field Descriptions

Bit	Field	Type	Reset	Description
7-5	0	W	0h	Must write 0
4-0	FRAMES PER MULTI FRAME (K)	R/W	8h	These bits set the number of multi frames. Actual K is the value in hex + 1 (that is, 0Fh is K = 16).

8.5.2.5.7 Register 7h (address = 7h), JESD Digital Page (6900h)

图 8-54. Register 7h

7	6	5	4	3	2	1	0
0	0	0	0	SUBCLASS	0	0	0
W-0h	W-0h	W-0h	W-0h	R/W-1h	W-0h	W-0h	W-0h

表 8-68. Register 7h Field Descriptions

Bit	Field	Type	Reset	Description
7-4	0	W	0h	Must write 0
3	SUBCLASS	R/W	1h	This bit sets the JESD204B subclass. 000 = Subclass 0 is backward compatible with JESD204A 001 = Subclass 1 deterministic latency using the SYSREF signal
2-0	0	W	0h	Must write 0

8.5.2.5.8 Register 16h (address = 16h), JESD Digital Page (6900h)

图 8-55. Register 16h

7	6	5	4	3	2	1	0
1	0	0	LANE SHARE	0	0	0	0
W-1h	W-0h	W-0h	R/W-0h	W-0h	W-0h	W-0h	W-0h

表 8-69. Register 16h Field Descriptions

Bit	Field	Type	Reset	Description
7	1	W	1h	Must write 1
6-5	0	W	0h	Must write 0
4	LANE SHARE	R/W	0h	When using decimate-by-4, the data of both channels are output over one lane (LMFS = 1241). 0 = Normal operation (each channel uses one lane) 1 = Lane sharing is enabled, both channels share one lane (LMFS = 1241)
3-0	0	W	0h	Must write 0

8.5.2.5.9 Register 31h (address = 31h), JESD Digital Page (6900h)

图 8-56. Register 31h

7	6	5	4	3	2	1	0
DA_BUS_REORDER[7:0]							
R/W-0h							

表 8-70. Register 31h Field Descriptions

Bit	Field	Type	Reset	Description
7-0	DA_BUS_REORDER[7:0]	R/W	0h	Use these bits to program output connections between data streams and output lanes in decimate-by-2 and decimate-by-4 mode. 表 8-14 lists the supported combinations of these bits.

8.5.2.5.10 Register 32h (address = 32h), JESD Digital Page (6900h)

图 8-57. Register 32h

7	6	5	4	3	2	1	0
DB_BUS_REORDER[7:0]							
R/W-0h							

表 8-71. Register 32h Field Descriptions

Bit	Field	Type	Reset	Description
7-0	DB_BUS_REORDER[7:0]	R/W	0h	Use these bits to program output connections between data streams and output lanes in decimate-by-2 and decimate-by-4 mode. 表 8-14 lists the supported combinations of these bits.

8.5.2.6 JESD Analog Page (6A00h) Registers

8.5.2.6.1 Register 12h (address = 12h), JESD Analog Page (6A00h)

TBD I separated this register since it is now different from the rest

图 8-58. Register 12h

7	6	5	4	3	2	1	0
SEL EMP LANE 1						ALWAYS WRITE 1	0
R/W-0h						W-0h	W-0h

表 8-72. Register 12h Field Descriptions

Bit	Field	Type	Reset	Description
7-2	SEL EMP LANE 1, 0, 2, or 3	R/W	0h	These bits select the amount of de-emphasis for the JESD output transmitter. The de-emphasis value in dB is measured as the ratio between the peak value after the signal transition to the settled value of the voltage in one bit period. 000000 = 0 dB 000001 = - 1 dB 000011 = - 2 dB 000111 = - 4.1 dB 001111 = - 6.2 dB 011111 = - 8.2 dB 111111 = - 11.5 dB
1	ALWAYS WRITE 1	W	0h	1 = Always write 1
0	0	W	0h	0 = Must write 0

8.5.2.6.2 Registers 13h-15h (addresses = 13h-5h), JESD Analog Page (6A00h)

图 8-59. Register 13h

7	6	5	4	3	2	1	0
SEL EMP LANE 0						0	0
R/W-0h						W-0h	W-0h

图 8-60. Register 14h

7	6	5	4	3	2	1	0
SEL EMP LANE 2						0	0
R/W-0h						W-0h	W-0h

图 8-61. Register 15h

7	6	5	4	3	2	1	0
SEL EMP LANE 3						0	0
R/W-0h						W-0h	W-0h

表 8-73. Registers 13h-15h Field Descriptions

Bit	Field	Type	Reset	Description
7-2	SEL EMP LANE x (where x = 1, 0, 2, or 3)	R/W	0h	These bits select the amount of de-emphasis for the JESD output transmitter. The de-emphasis value in dB is measured as the ratio between the peak value after the signal transition to the settled value of the voltage in one bit period. 000000 = 0 dB 000001 = - 1 dB 000011 = - 2 dB 000111 = - 4.1 dB 001111 = - 6.2 dB 011111 = - 8.2 dB 111111 = - 11.5 dB
1-0	0	W	0h	Must write 0

8.5.2.6.3 Register 16h (address = 16h), JESD Analog Page (6A00h)

图 8-62. Register 16h

7	6	5	4	3	2	1	0
0	0	0	0	0	0	JESD PLL MODE	
W-0h	W-0h	W-0h	W-0h	W-0h	W-0h	R/W-0h	

表 8-74. Register 16h Field Descriptions

Bit	Field	Type	Reset	Description
7-2	0	W	0h	Must write 0
1-0	JESD PLL MODE	R/W	0h	These bits select the JESD PLL multiplication factor and must match the JESD MODE setting. 00 = 20X mode, four lanes per ADC 01 = Not used 10 = 40X mode, two lanes per ADC 11 = Not used 表 8-14 lists a programming summary of the DDC modes and JESD link configuration.

8.5.2.6.4 Register 17h (address = 17h), JESD Analog Page (6A00h)

图 8-63. Register 17h

7	6	5	4	3	2	1	0
0	PLL RESET	LANE PDN 1	0	LANE PDN 0	0	0	0
W-0h	R/W-0h	R/W-0h	W-0h	R/W-0h	W-0h	W-0h	W-0h

表 8-75. Register 17h Field Descriptions

Bit	Field	Type	Reset	Description
7	0	W	0h	Must write 0
6	PLL RESET	R/W	0h	Pulse this bit after powering up the device; see 表 9-1 . 0 = Default 0 → 1 → 0 = The PLL RESET bit is pulsed.
5	LANE PDN 1	R/W	0h	This bit powers down unused SERDES lanes DA0, DA3, DB0, and DB3 in certain LMFS settings (applicable for LMFS = 4244, 2242, 2441, 4211, and 2221). Powering down unused lanes puts the SERDES buffers in tri-state mode and saves approximately 15-mA current on the IOVDD supply. This bit must be used with LANE PDN 0 to take effect. 0 = Default 1 = DA0, DB0, DA3 and DB3 are powered down
4	0	W	0h	Must write 0
3	LANE PDN 0	R/W	0h	This bit powers down unused SERDES lanes DA0, DA3, DB0, and DB3 in certain LMFS settings (applicable for LMFS = 4244, 2242, 2441, 4211, and 2221). Powering down unused lanes puts the SERDES buffers in tri-state mode and saves approximately 15-mA current on the IOVDD supply. This bit must be used with LANE PDN 1 to take effect. 0 = Default 1 = DA0, DB0, DA3 and DB3 are powered down
2-0	0	W	0h	Must write 0

8.5.2.6.5 Register 1Ah (address = 1Ah), JESD Analog Page (6A00h)

图 8-64. Register 1Ah

7	6	5	4	3	2	1	0
0	0	0	0	0	0	FOVR CHA	0
W-0h	W-0h	W-0h	W-0h	W-0h	W-0h	R/W-0h	W-0h

表 8-76. Register 1Ah Field Descriptions

Bit	Field	Type	Reset	Description
7-2	0	W	0h	Must write 0
1	FOVR CHA	R/W	0h	This bit outputs the FOVR signal for channel A on the PDN pin. FOVR CHA EN (register 1Bh, bit 3) must be enabled for this bit to function. 0 = Normal operation 1 = The FOVR signal of channel A is available on the PDN pin
0	0	W	0h	Must write 0

8.5.2.6.6 Register 1Bh (address = 1Bh), JESD Analog Page (6A00h)

图 8-65. Register 1Bh

7	6	5	4	3	2	1	0
JESD SWING			0	FOVR CHA EN	0	0	0
R/W-0h			W-0h	R/W-0h	W-0h	W-0h	W-0h

表 8-77. Register 1Bh Field Descriptions

Bit	Field	Type	Reset	Description
7-5	JESD SWING	R/W	0h	These bits select the output amplitude V_{OD} (mV _{PP}) of the JESD transmitter (for all lanes). 0 = 860 mV _{PP} 1 = 810 mV _{PP} 2 = 770 mV _{PP} 3 = 745 mV _{PP} 4 = 960 mV _{PP} 5 = 930 mV _{PP} 6 = 905 mV _{PP} 7 = 880 mV _{PP}
4	0	W	0h	Must write 0
3	FOVR CHA EN	R/W	0h	This bit enables overwrites of the PDN pin with the FOVR signal from channel A. 0 = Normal operation 1 = PDN is overwritten
2-0	0	R/W	0h	Must write 0

8.5.2.7 Offset Read Page (JESD BANK PAGE SEL = 6100h, JESD BANK PAGE SEL1 = 0000h) Registers

8.5.2.7.1 Register 068h (address = 068h), Offset Read Page

图 8-66. Register 068h

7	6	5	4	3	2	1	0
FREEZE CORR	DC OFFSET CORR BW	DC OFFSET CORR BW	DC OFFSET CORR BW	DC OFFSET CORR BW	BYPASS CORR	ALWAYS WRITE 1	0
R/W-0h	R/W-0h	R/W-0h	R/W-0h	R/W-0h	R/W-0h	R/W-0h	W-0h

表 8-78. Register 068h Field Descriptions

Bit	Field	Type	Reset	Description
7	FREEZE CORR	R/W	0h	Offset correction block is enabled by default. Set this bit to freeze the block. 0 = Default after reset 1 = Offset correction block is frozen See the DC Offset Correction Block in the ADS54J40ADS54J40W section for details.
6-3	DC OFFSET CORR BW	R/W	0h	These bits allow the user to program the 3-dB bandwidth of the notch filter centered around $k \times fs/4$ ($k = 0, 1, 2$). The notch filter is a first-order digital filter with 3-dB bandwidth: 3-dB bandwidth normalized to fs 0 = 2.99479E-07 1 = 1.4974E-07 2 = 7.48698E-08 3 = 3.74349E-08 4 = 1.87174E-08 5 = 9.35872E-09 6 = 4.67936E-09 7 = 2.33968E-09 8 = 1.16984E-09 9 = 5.8492E-10 10 = 2.9246E-10 11 = 1.4623E-10 For example, at $fs = 1$ GSPS, if DC OFFSET CORR BW is set to 1, the notch filter has a 3-dB bandwidth of 149.74 Hz.
2	BYPASS CORR	R/W	0h	0 = Default after reset 1 = Offset correction block is bypassed See the DC Offset Correction Block in the ADS54J40ADS54J40W section for details.
1	ALWAYS WRITE 1	R/W	0h	Always write 1
0	0	W	0h	Must write 0

8.5.2.7.2 Register 069h (address = 069h), Offset Read Page

图 8-67. Register 069h

7	6	5	4	3	2	1	0
0	0	0	0	0	0	0	EXT CORR EN
W-0h	W-0h	W-0h	W-0h	W-0h	W-0h	W-0h	R/W-0h

表 8-79. Register 069h Field Descriptions

Bit	Field	Type	Reset	Description
7-1	0	W	0h	Must write 0
0	EXT CORR EN	R/W	0h	Enables loading of external estimate into offset correction block. 0 = Default after reset (device uses internal estimate for offset correction) 1 = External estimate can be loaded by using the ADCx_LOAD_EXT_EST register bits See the DC Offset Correction Block in the ADS54J40ADS54J40W section for details.

8.5.2.7.3 Registers 074h, 076h, 078h, 7Ah (address = 074h, 076h, 078h, 7Ah), Offset Read Page

图 8-68. Registers 074h, 076h, 078h, 7Ah

7	6	5	4	3	2	1	0
ADCx_CORR_INT_EST[5:0]						X	X
R/W-0h						n/a	n/a

表 8-80. Registers 074h, 076h, 078h, 7Ah Field Descriptions

Bit	Field	Type	Reset	Description
7-2	ADCx_CORR_INT_EST[5:0]	R/W	0h	Internal estimate for all four interleaving ADC cores of the dc offset corrector block can be read from these bits. Keep the R/W bit set to 1 when reading from these registers. See the DC Offset Correction Block in the ADS54J40ADS54J40W section for details.
1-0	X	n/a	n/a	Don't care

8.5.2.7.4 Registers 075h, 077h, 079h, 7Bh (address = 075h, 077h, 079h, 7Bh), Offset Read Page

图 8-69. Registers 075h, 077h, 079h, 7Bh

7	6	5	4	3	2	1	0
0	0	0	0	0	ADCx_CORR_INT_EST[8:6]		
W-0h	W-0h	W-0h	W-0h	W-0h	R/W-0h		

表 8-81. Registers 075h, 077h, 079h, 7Bh Field Descriptions

Bit	Field	Type	Reset	Description
7-3	0	W	0h	Must write 0
2-0	ADCx_CORR_INT_EST[8:6]	R/W	0h	Internal estimate for all four interleaving ADC cores of the dc offset corrector block can be read from these bits. Keep the R/W bit set to 1 when reading from these registers. See the DC Offset Correction Block in the ADS54J40ADS54J40W section for details.

8.5.2.8 Offset Load Page (JESD BANK PAGE SEL= 6100h, JESD BANK PAGE SEL1 = 0500h) Registers

8.5.2.8.1 Registers 00h, 04h, 08h, 0Ch (address = 00h, 04h, 08h, 0Ch), Offset Load Page

图 8-70. Registers 00h, 04h, 08h, 0Ch

7	6	5	4	3	2	1	0	
ADCx_LOAD_EXT_EST[5:0]							X	X
R/W-0h							n/a	n/a

表 8-82. Registers 00h, 04h, 08h, 0Ch Field Descriptions

Bit	Field	Type	Reset	Description
5-0	ADCx_LOAD_EXT_EST[5:0]	R/W	0h	External estimate can be loaded into the dc offset corrector blocks for all four interleaving ADC cores. See the DC Offset Correction Block in the ADS54J40ADS54J40W section for details.
1-0	X	n/a	n/a	Don't care

8.5.2.8.2 Registers 01h, 05h, 09h, 0Dh (address = 01h, 05h, 09h, 0Dh), Offset Load Page

图 8-71. Registers 01h, 05h, 09h, 0Dh

7	6	5	4	3	2	1	0
0	0	0	0	0	ADCx_LOAD_EXT_EST[8:6]		
W-0h	W-0h	W-0h	W-0h	W-0h	R/W-0h		

表 8-83. Registers 01h, 05h, 09h, 0Dh Field Descriptions

Bit	Field	Type	Reset	Description
7-3	0	W	0h	Must write 0
2-0	ADCx_CORR_INT_EST[8:6]	R/W	0h	External estimate can be loaded into the dc offset corrector blocks for all four interleaving ADC cores. See the DC Offset Correction Block in the ADS54J40ADS54J40W section for details.

8.5.2.8.3 Registers 78h (address = 78h), Offset Load Page

图 8-72. Registers 078h

7	6	5	4	3	2	1	0
0	0	0	0	0	0	0	IL ENGINE FREEZE SECONDARY CONTROL
W	W	W	W	W	W	W	R/W

表 8-84. Registers 078h Field Descriptions

Bit	Field	Type	Reset	Description
7-1	0	W	0h	Must write 0
0	IL ENGINE FREEZE SECONDARY CONTROL	R/W	0h	Whenever IL ENGINE freeze is required, this bit needs to be set to 0.

9 Application Information Disclaimer

Note

Information in the following applications sections is not part of the TI component specification, and TI does not warrant its accuracy or completeness. TI's customers are responsible for determining suitability of components for their purposes, as well as validating and testing their design implementation to confirm system functionality.

9.1 Application Information

9.1.1 Start-Up Sequence

The steps described in [表 9-1](#) are recommended as the power-up sequence with the ADS54J40 in 20X mode (LMFS = 8224).

表 9-1. Initialization Sequence

STEP	SEQUENCE	DESCRIPTION	PAGE BEING PROGRAMMED	COMMENT
1	Power-up the device	Bring up IOVDD to 1.15 V before applying power to DVDD. Bring up DVDD to 1.9 V, AVDD to 1.9 V, and AVDD3V to 3.0 V.	—	See the Power Sequencing and Initialization section for power sequence requirements.
2	Reset the device	Hardware reset		
		Apply a hardware reset by pulsing pin 48 (low → high → low).	—	A hardware reset clears all registers to their default values.
		Register writes are equivalent to a hardware reset.		
		Write address 0-000h with 81h.	General register	Reset registers in the ADC and master pages of the analog bank. This bit is a self-clearing bit.
		Write address 4-001h with 00h and address 4-002h with 00h.	Unused page	Clear any unwanted content from the unused pages of the JESD bank.
		Write address 4-003h with 00h and address 4-004h with 68h.	—	Select the main digital page of the JESD bank.
		Write address 6-0F7h with 01h for channel A.	Main digital page (JESD bank)	Use the DIG RESET register bit to reset all pages in the JESD bank. This bit is a self-clearing bit.
Write address 6-000h with 01h, then address 6-000h with 00h.	Pulse the PULSE RESET register bit for channel A.			
3	Performance modes	Write address 0-011h with 80h.	—	Select the master page of the analog bank.
		Write address 0-059h with 20h.	Master page (analog bank)	Set the ALWAYS WRITE 1 bit.
4	Program desired registers for decimation options and JESD link configuration	Default register writes for DDC modes and JESD link configuration (LMFS 8224).		
		Write address 4-003h with 00h and address 4-004h with 69h.	—	Select the JESD digital page.
		Write address 6-000h with 80h.	JESD digital page (JESD bank)	Set the CTRL K bit for both channels by programming K according to the SYSREF signal later on in the sequence.
		JESD link is configured with LMFS = 8224 by default with no decimation.		See 表 8-14 for configuring the JESD digital page registers for the desired LMFS and programming appropriate DDC mode.
		Write address 4-003h with 00h and address 4-004h with 6Ah.	—	Select the JESD analog page.
		JESD link is configured with LMFS = 8224 by default with no decimation.	JESD analog page (JESD bank)	See 表 8-14 for configuring the JESD analog page registers for the desired LMFS and programming appropriate DDC mode.
		Write address 6-017h with 40h.		PLL reset.
		Write address 6-017h with 00h.		PLL reset clear.
		Write address 4-003h with 00h and address 4-004h with 68h.	—	Select the main digital page.
		JESD link is configured with LMFS = 8224 by default with no decimation.	Main digital page (JESD bank)	See 表 8-14 for configuring the main digital page registers for the desired LMFS and programming appropriate DDC mode.
Write address 6-000h with 01h and address 6-000h with 00h.	Pulse the PULSE RESET register bit. All settings programmed in the main digital page take effect only after this bit is pulsed.			
5	Set the value of K and the SYSREF signal frequency accordingly	Write address 4-003h with 00h and address 4-004h with 69h.	—	Select the JESD digital page.
		Write address 6-006h with XXh (choose the value of K).	JESD digital page (JESD bank)	See the SYSREF Signal section to choose the correct frequency for SYSREF.

表 9-1. Initialization Sequence (continued)

STEP	SEQUENCE	DESCRIPTION	PAGE BEING PROGRAMMED	COMMENT
6	JESD lane alignment	Pull the SYNCB pin (pin 63) low.	—	Transmit K28.5 characters.
		Pull the SYNCB pin high.		After the receiver is synchronized, initiate an ILA phase and subsequent transmissions of ADC data.

9.1.2 Hardware Reset

图 9-1 和 表 9-2 显示硬件重置的时序。



图 9-1. Hardware Reset Timing Diagram

表 9-2. Timing Requirements

		MIN	TYP	MAX	UNIT
t ₁	Power-on delay: delay from power-up to an active high RESET pulse	1			ms
t ₂	Reset pulse duration: active high RESET pulse duration	10			ns
t ₃	Register write delay: delay from RESET disable to SEN active	100			ns

9.1.3 SNR and Clock Jitter

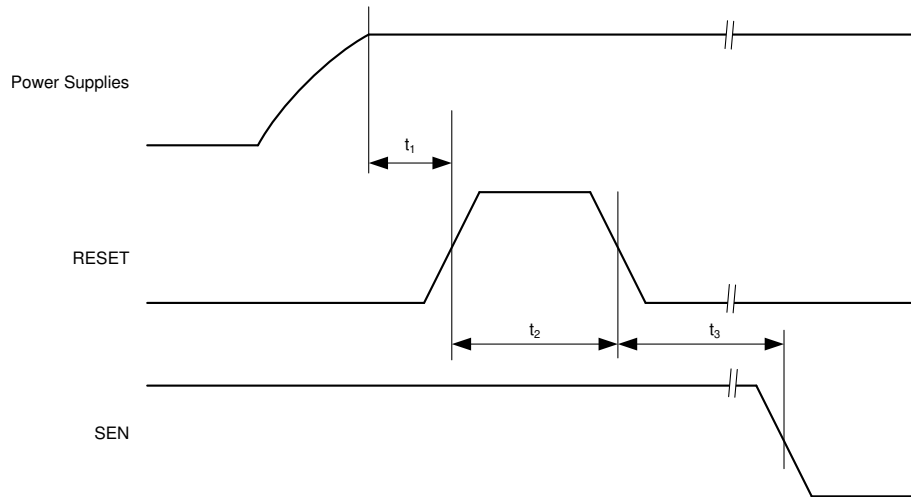
The signal-to-noise ratio (SNR) of the ADC is limited by three different factors: quantization noise, thermal noise, and jitter, as shown in 方程式 4. The quantization noise is typically not noticeable in pipeline converters and is 86 dBFS for a 14-bit ADC. The thermal noise limits SNR at low input frequencies and the clock jitter sets SNR for higher input frequencies.

$$SNR_{ADC} [dBc] = -20 \log \sqrt{\left(10^{-\frac{SNR_{Quantization\ Noise}}{20}}\right)^2 + \left(10^{-\frac{SNR_{Thermal\ Noise}}{20}}\right)^2 + \left(10^{-\frac{SNR_{Jitter}}{20}}\right)^2} \quad (4)$$

The SNR limitation resulting from sample clock jitter can be calculated by 方程式 5:

$$SNR_{jitter} [dBc] = -20 \log(2\pi \times f_{in} \times T_{jitter}) \quad (5)$$

The total clock jitter (T_{jitter}) has two components: the internal aperture jitter (130 fs) is set by the noise of the clock input buffer and the external clock jitter. T_{jitter} can be calculated by 方程式 6:

$$T_{jitter} = \sqrt{(T_{jitter, Ext_Clock_Input})^2 + (T_{Aperture_ADC})^2} \quad (6)$$

External clock jitter can be minimized by using high-quality clock sources and jitter cleaners as well as band-pass filters at the clock input. A faster clock slew rate also improves the ADC aperture jitter.

The ADS54J40 has a thermal noise of approximately 71.1 dBFS and an internal aperture jitter of 120 fs. SNR, depending on the amount of external jitter for different input frequencies, is shown in 图 9-2.



图 9-2. SNR versus Input Frequency and External Clock Jitter

9.1.4 DC Offset Correction Block in the ADS54J40

The ADS54J40 employs eight dc offset correction blocks (four per channel, one per interleaving core). 图 9-3 shows a dc correction block diagram.

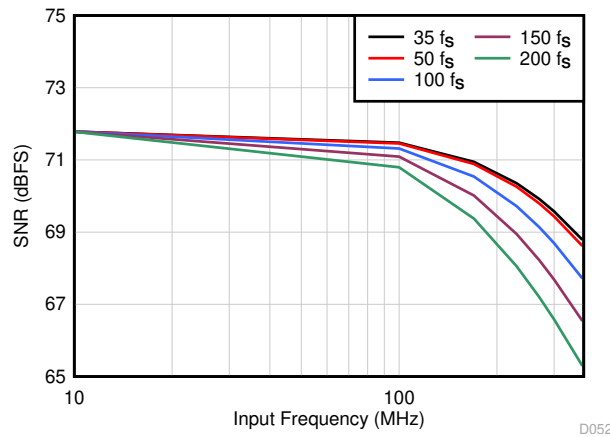

图 9-3. DC Offset Correction Block Diagram

The purpose of the dc offset correction block is to correct the dc offset of interleaving cores that mainly arise from amplifier in the first pipeline stage. Any mismatch in dc offset among interleaving cores results in spurs at $f_S / 4$ and $f_S / 2$. The dc offset correction blocks estimate and correct the dc offset of the individual core, to an ideal mid-code value, and thereby remove the effect of offset mismatch.

The dc offset correction block can correct the dc offset of individual core up to ± 1024 codes.

In applications involving dc-coupling between the ADC and the driver, the dc offset correction block can either be *bypassed* or *frozen* because the block cannot distinguish the external dc signal from the internal dc offset. 图 9-4

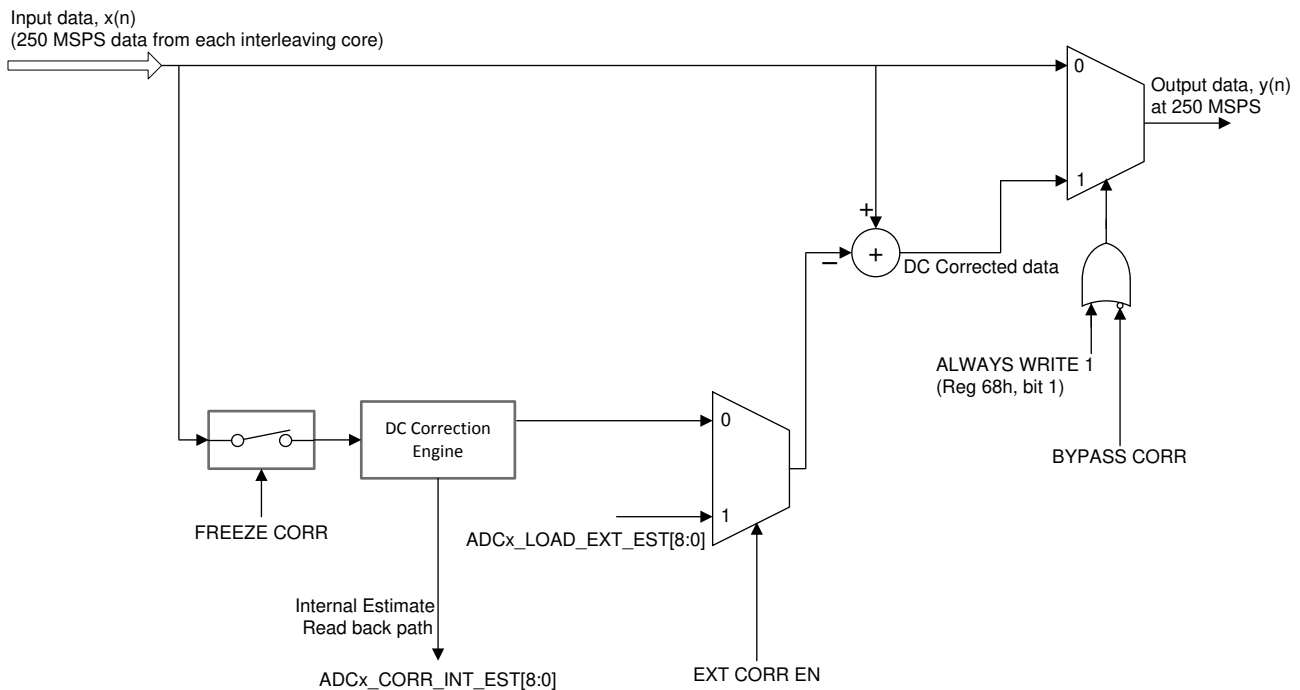
shows that when bypassed, the internal dc mismatch appears at dc, and the $f_S / 4$ and $f_S / 2$ frequency points and can be as big as -40 dBFS.



图 9-4. FFT After Bypassing the DC Offset Correction Block

9.1.4.1 Freezing the DC Offset Correction Block

After the device is powered up, the dc offset correction block estimates the internal dc offset with the idle channel input before the block is frozen. When frozen, the correction block holds the last estimated value that belongs to the internal dc offset. After the correction block is frozen, an external signal can be applied.

9.1.4.2 Effect of Temperature

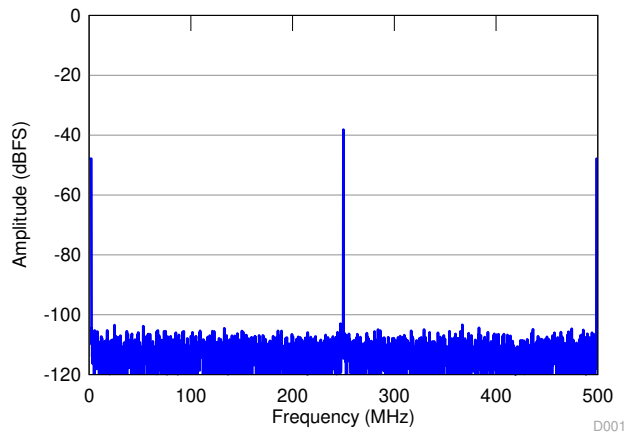
The internal dc offset of the individual cores changes with temperature, resulting in $f_S / 4$ and $f_S / 2$ spurs appearing again in the spectrum at a different temperature.

图 9-5 shows the variation of the $f_S / 4$ spur over temperature for a typical device.

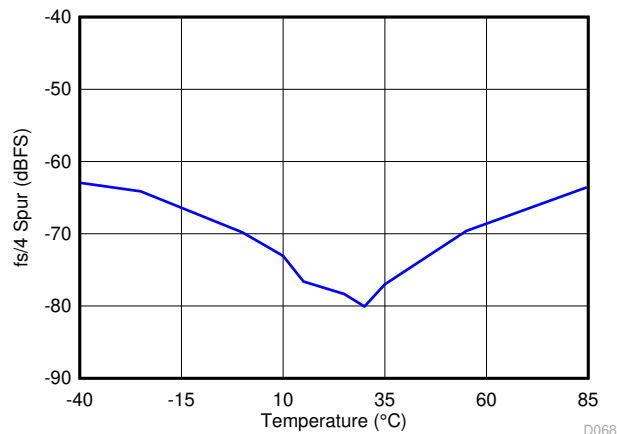

The offset correction block was frozen at room temperature, then the temperature was varied from -40°C to $+85^{\circ}\text{C}$.

图 9-5. Variation of the $f_S / 4$ Spur Over Temperature

Although some systems can accept such a variation in the $f_S / 4$ and $f_S / 2$ spurs across temperature, other systems may require the internal dc offset profile to be calibrated with temperature. To achieve the calibration of internal dc offset, the device provides an option to read the internal estimate values from the correction block for each of the interleaving cores and also to load the values back to the correction block. For calibration, after power up, a temperature sweep can be performed with the idle channel input and the internal dc offset can be read back using the ADCx_CORR_INT_EST register bits for salient temperature points. Then during operation, when the temperature changes, corresponding estimates can be externally loaded to the correction block using the ADCx_LOAD_EXT_EST register bits.

The dc offset corrector block is enabled by default. For a given channel, the device can disable and freeze the block, read the block estimate, and load the external estimate.

表 9-3 lists an example of the required SPI writes for reading an internal estimate of the dc offset correction block, and then loading the estimate back to the corrector.

表 9-3. Format (16-Bit Address, 8-Bit Data)

STEP	ADDRESS (Hex) ⁽¹⁾	DATA (Hex)	COMMENT
Reading an internal estimate from both channels	4-005	01	This setting disables broadcast mode (channel A and B can be individually programmed)
	4-004	61	Select the offset read page (61000000h)
	4-003	00	
	4-002	00	
	4-001	00	
	Data from offset read page can be read as below (keep the R/W bit = 1)		
	E-074	xx	Reading the internal estimate [5:0] for core 0, channel A on the SDOUT pin
	E-075	xx	Reading the internal estimate [8:6] for core 0, channel A on the SDOUT pin
	E-076	xx	Reading the internal estimate [5:0] for core 1, channel A on the SDOUT pin
	E-077	xx	Reading the internal estimate [8:6] for core 1, channel A on the SDOUT pin
	E-078	xx	Reading the internal estimate [5:0] for core 2, channel A on the SDOUT pin
	E-079	xx	Reading the internal estimate [8:6] for core 2, channel A on the SDOUT pin
	E-07A	xx	Reading the internal estimate [5:0] for core 3, channel A on the SDOUT pin
	E-07B	xx	Reading the internal estimate [8:6] for core 3, channel A on the SDOUT pin
	F-074	xx	Reading the internal estimate [5:0] for core 0, channel B on the SDOUT pin
	F-075	xx	Reading the internal estimate [8:6] for core 0, channel B on the SDOUT pin
	F-076	xx	Reading the internal estimate [5:0] for core 1, channel B on the SDOUT pin
	F-077	xx	Reading the internal estimate [8:6] for core 1, channel B on the SDOUT pin
	F-078	xx	Reading the internal estimate [5:0] for core 2, channel B on the SDOUT pin
	F-079	xx	Reading the internal estimate [8:6] for core 2, channel B on the SDOUT pin
	F-07A	xx	Reading the internal estimate [5:0] for core 3, channel B on the SDOUT pin
F-07B	xx	Reading the internal estimate [8:6] for core 3, channel B on the SDOUT pin	

表 9-3. Format (16-Bit Address, 8-Bit Data) (continued)

STEP	ADDRESS (Hex) ⁽¹⁾	DATA (Hex)	COMMENT	
Loading an external estimate to both channels	6-069	01	Enables the external correction bit located in the offset read page for channel A	
	7-069	01	Enables the external correction bit located in the offset read page for channel B	
	4-004	61	Change the page to the offset load page (61000500h)	
	4-003	00		
	4-002	05		
	4-001	00		
	6-000	xx	Loading the external estimate [5:0] for core 0, channel A through SPI writes	
	6-001	xx	Loading the external estimate [8:6] for core 0, channel A through SPI writes	
	6-004	xx	Loading the external estimate [5:0] for core 1, channel A through SPI writes	
	6-005	xx	Loading the external estimate [8:6] for core 1, channel A through SPI writes	
	6-008	xx	Loading the external estimate [5:0] for core 2, channel A through SPI writes	
	6-009	xx	Loading the external estimate [8:6] for core 2, channel A through SPI writes	
	6-00C	xx	Loading the external estimate [5:0] for core 3, channel A through SPI writes	
	6-00D	xx	Loading the external estimate [8:6] for core 3, channel A through SPI writes	
	7-000	xx	Loading the external estimate [5:0] for core 0, channel B through SPI writes	
	7-001	xx	Loading the external estimate [8:6] for core 0, channel B through SPI writes	
	7-004	xx	Loading the external estimate [5:0] for core 1, channel B through SPI writes	
	7-005	xx	Loading the external estimate [8:6] for core 1, channel B through SPI writes	
	7-008	xx	Loading the external estimate [5:0] for core 2, channel B through SPI writes	
	7-009	xx	Loading the external estimate [8:6] for core 2, channel B through SPI writes	
7-00C	xx	Loading the external estimate [5:0] for core 3, channel B through SPI writes		
7-00D	xx	Loading the external estimate [8:6] for core 3, channel B through SPI writes		

(1) The address field is represented in four hex bits in a-bcd format, where a contains information about the R/W, M, P, and CH bits, and bcd contains the actual address of the register.

9.1.5 Idle Channel Histogram

图 9-6 shows a histogram of output codes for when no signal is applied at the analog inputs of the ADS54J40 .
 图 9-7 shows that when the dc offset correction block of the device is bypassed, the output code histogram becomes multi-modal with as many as four peaks because the ADS54J40 is a 4-way interleaved ADC with each ADC core having a different internal dc offset.



图 9-8 shows that when the dc offset correction block is frozen (instead of bypassed), the output code histogram improves (compared to when bypassed). However, when the temperature changes, the dc offset difference among interleaving cores may increase resulting in increased spacing between peaks in the histogram.



图 9-8. Idle Channel Histogram (No Signal at Analog Inputs, DC Offset Correction is Frozen)

9.1.6 Interleaving (IL) Mismatch Compensation

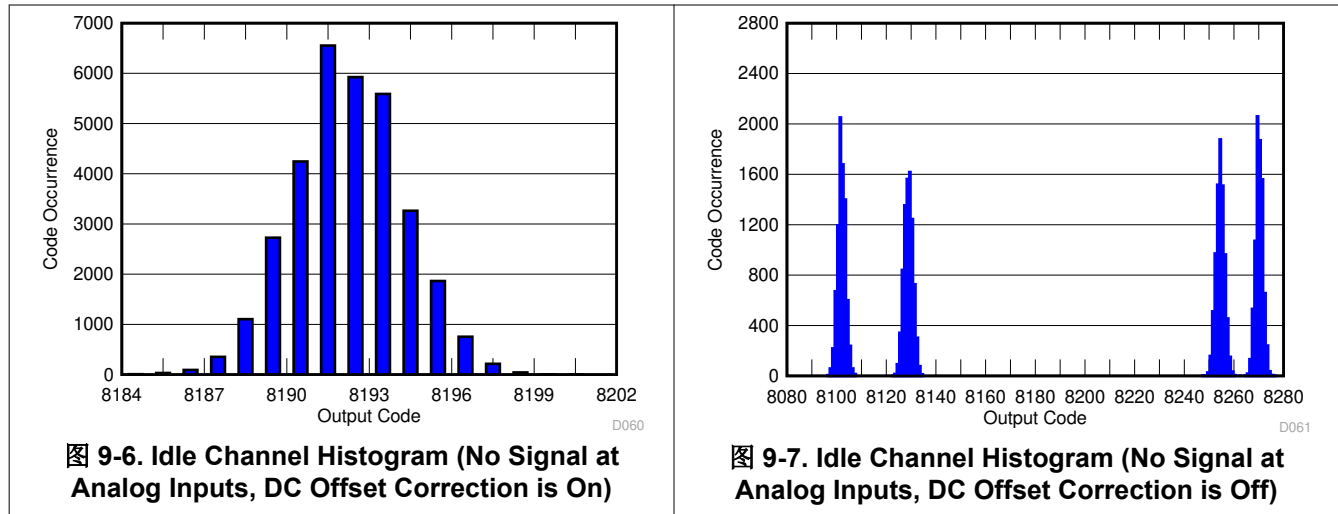
9.1.6.1 Introduction

The ADC in ADS54J40 is an interleaved ADC, which is realized by interleaving the outputs of 4 component ADCs running at one-fourth of the final rate. Gain/timing mismatches between the 4 component ADCs give rise to images in the spectrum, located at $F_{in} + kF_s/4$, $k = 1, 2, 3$, where F_{in} is the input frequency and F_s is the overall ADC sampling frequency. Note that the frequencies $F_{in} + kF_s/4$ will alias and fall within $[-F_s/2, F_s/2]$ when the ADC out is observed. The Interleaving (IL) mismatch corrector module in ADS54J40 compensates for these images.

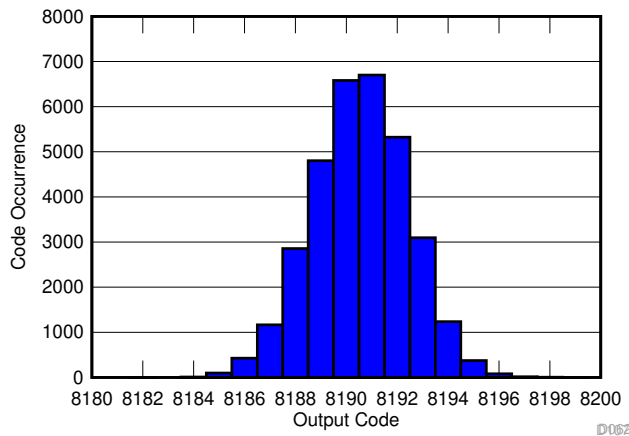

图 9-9. Block diagram of Interleaving mismatch Compensation

9.1.6.2 Features

1. IL mismatch correction has 2 components - Analog Correction component and Digital Correction component. The correction parameters are provided by the 'IL Mismatch Parameters Estimator' block shown in Fig 1.
2. Tracking of IL mismatch parameters happens continuously in the background, based on incoming data (except under certain specific conditions listed in item 5).
3. IL mismatch estimation uses Nyquist band information programmed by the user, for proper estimation from the input signals. Note that for higher Nyquist signals, the IL spurs are at $F_{in_alias} + kF_s/4$ ($k = 1, 2, 3$) where F_{in_alias} is the aliased input frequency between $[-F_s/2, F_s/2]$. This effectively gives the location of IL spurs at the ADC output.
 - a. Any change in Nyquist band should be succeeded by a "pulse reset". A pulse reset signal resets the internal IL mismatch estimation and correction and the JESD link. However; all other registers written into the IL engine or the status of the rest of the system is unaffected by a pulse reset. The IL mismatch parameters would be reestimated for the new Nyquist band after a pulse reset
 - b. In typical use cases, signals would be present only within one Nyquist band. However, if there are signals across multiple Nyquist bands (for eg the desired bands in multiple Nyquist bands may not alias after sampling enabling them to be separated later), it is possible that IL performance may be degraded.

So it is advisable to disable IL engine to get raw IL performance. The typical raw IL performance is shown in 图 9-10.

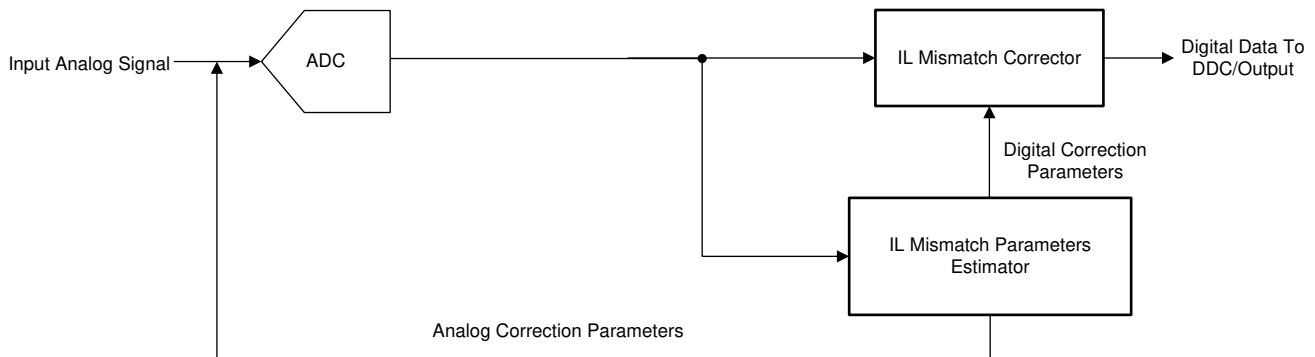
Typical raw IL Performance



图 9-10. Typical raw IL Performance

4. IL image performance starts to degrade gracefully for signal frequency components $> 0.9 \times F_s/2$, for 1st Nyquist signals, as digital correction cannot accurately correct for signals very close to Nyquist band edge .
 - a. For signals in higher Nyquist bands, the performance degrades gracefully for aliased frequency components $< 0.1F_s/2$ or $> 0.9F_s/2$
5. IL correction accuracy will continue to be maintained unless any of the following conditions are hit:
 - a. Persistent Signal absence: The IL estimator works on the input signals to estimate and track IL mismatch parameters over time. So if no input signal is present, then IL mismatch estimation is not possible. See item 5f for further details.

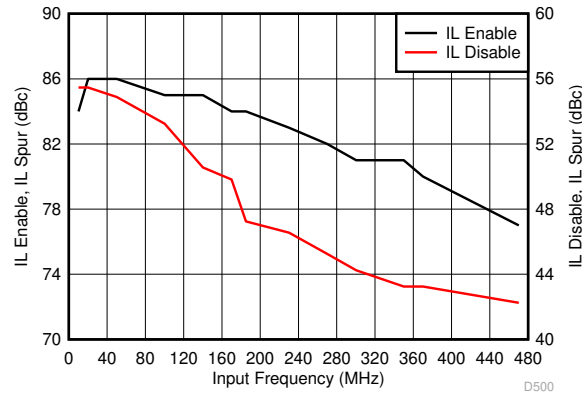
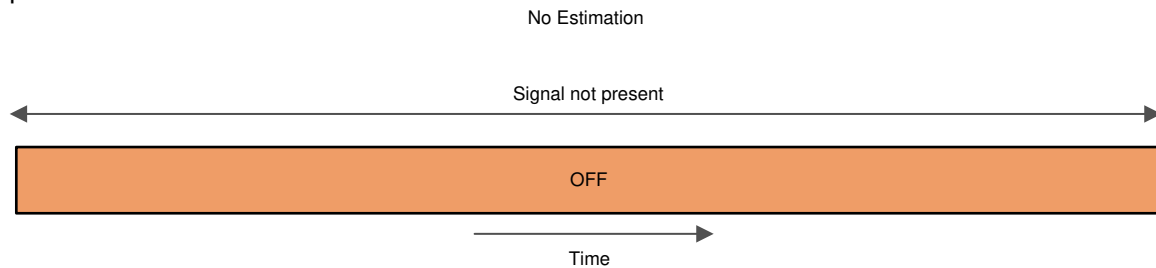

- b. Persistent very weak signal only: As IL estimator works on input signals, it needs reasonable-powered signals present for some continuous period of time to get IL estimates properly. The signal power in atleast one frequency band of width $F_s/256$ has to be > -35 dBFs for proper IL estimation. Further such signal needs to be present in chunks of atleast 100 μs for an integrated ON period of at least 10 ms over

a total time of 100 ms for proper IL estimation. See item 5f for further details.

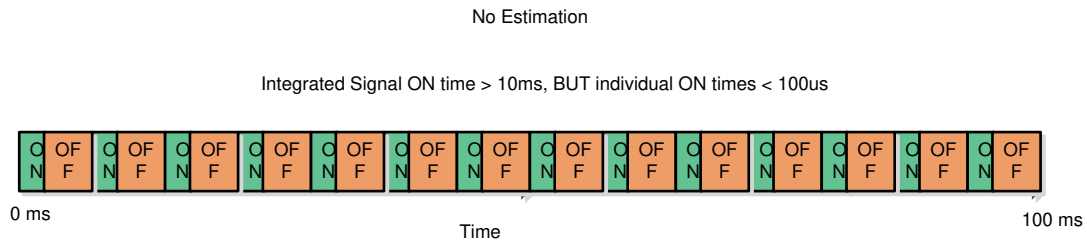
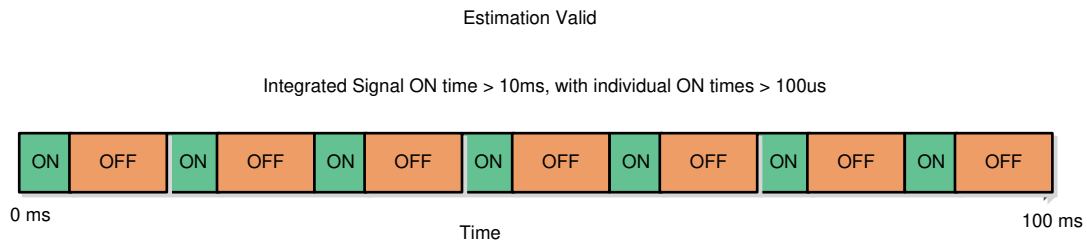
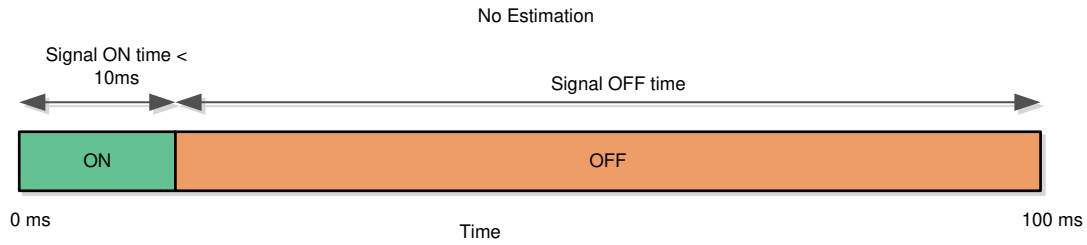
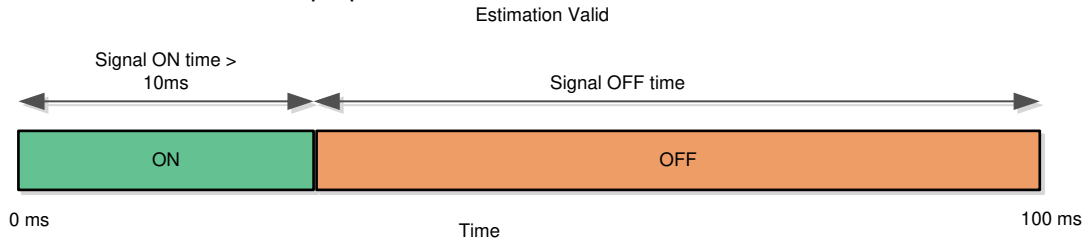

- c. Consistent Signal saturation: Whenever signal is saturated, signal gets distorted and IL estimation is no longer possible. IL estimation is possible if signal amplitude is < -0.5 dBFs for more than 100 μs in one

chunk and such chunks make up atleast 10 ms in a 100 ms window. See item 5f for further details.

No Estimation

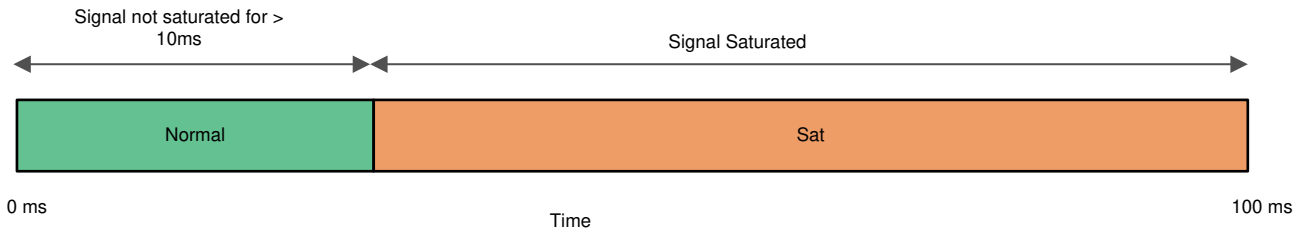

No Estimation

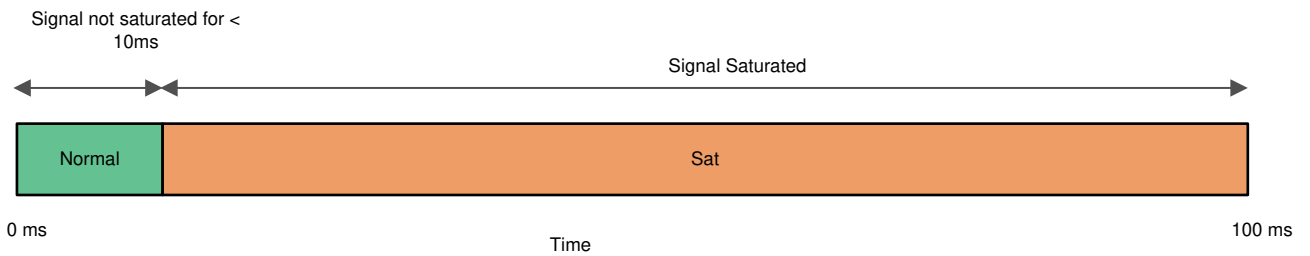

Estimation Valid

Non-saturated(normal) time blocks > 100us with total normal block time > 10ms

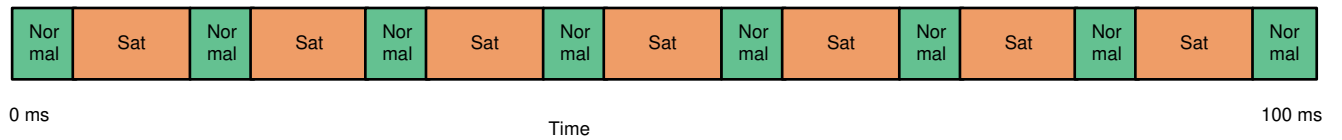

No Estimation

Non-saturated(normal) time blocks < 100us with total normal block time > 10ms

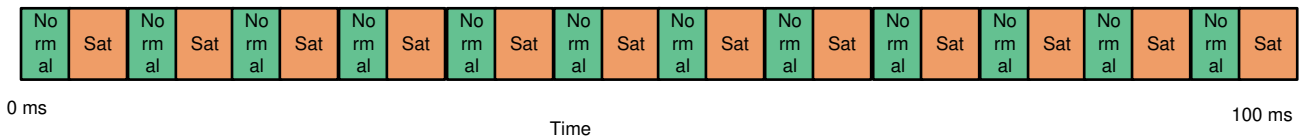

- d. Signal presence in a very small band only around $kfs/8$: If input signal is present only within $5e-7 \times F_s$ of $kFs/8$ ($k = 0,1,2,3$), then no IL estimation is possible as the IL signal and IL image are not separable.

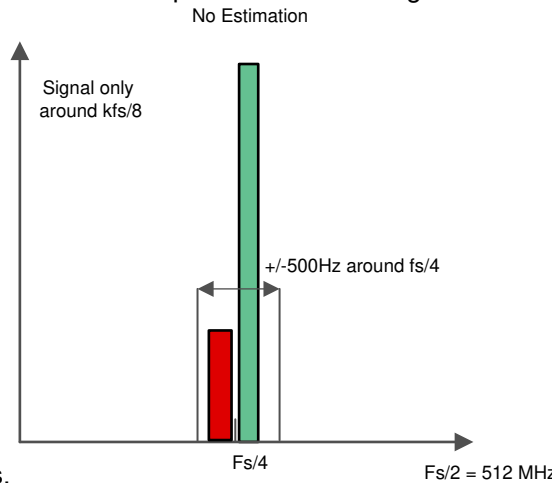

See item 5f for further details.

- e. Presence of high power signal component in the IL image band: In some cases, the signal component (such as Sig1) may be present in the IL image band of other components of the signal (such as Sig0). This signal component in IL image band (Sig1) acts as an interferer for IL estimation of the first component (Sig0). If the ratio of the power of the signal component causing IL mismatch (power of Sig0) to the power of the signal component in the IL image band (power of Sig1) is less than 25 dB, then IL estimation cannot be done for that signal component (Sig0). See item 5f for further details

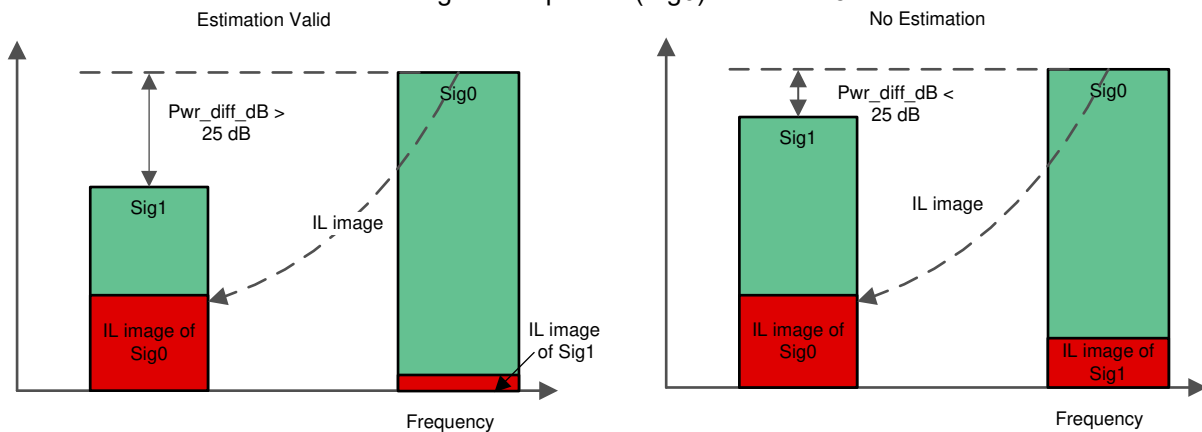

- f. In the normal course of operation, old IL mismatch estimates are retained and used for correction even if there are no current IL mismatch estimates due to any of the conditions listed in 5a - 5e. This enables good performance when any of the conditions in 5a-5e are present for a short duration. However if any of the conditions that prevent estimation listed in 5a - 5e persist for a large time (>40s), then the estimated digital IL mismatch parameters are reset and the digital IL mismatch parameters are re-estimated when the conditions for estimation becomes favorable again.
- If the user knows apriori that such a condition will occur and would like the old IL correction to be retained, then a good option is to freeze the IL engine as in item 6. This freeze stops the IL engine and so the old IL estimates are not discarded.

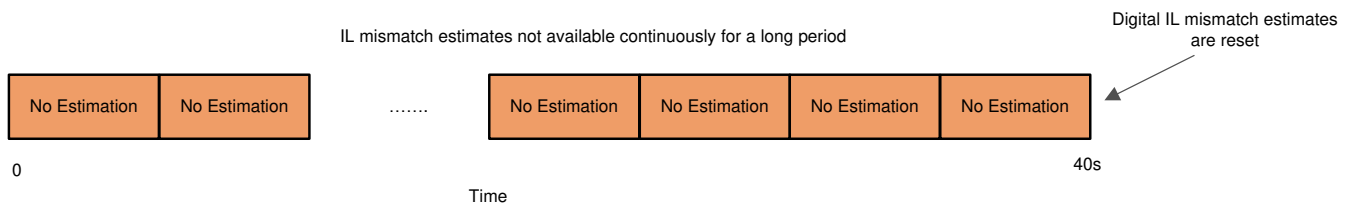

- g. Signal and IL image overlap: If signal component is present around $kfs/8$ ($k = 0,1,2,3$), then the IL image band will also overlap with the signal making it difficult to estimate IL mismatch parameters. Overlap of

signal and IL image bands around $kfs/8$ should be $< Fs/256$ MHz for 90% of the time for proper IL estimation. Note that if this condition cannot be ensured, then IL performance will be degraded. If this condition is violated in a known period, then the user can freeze IL engine when this condition occurs as described in section 6. Otherwise, user has to switch to options in items 6 or 7 to avoid performance

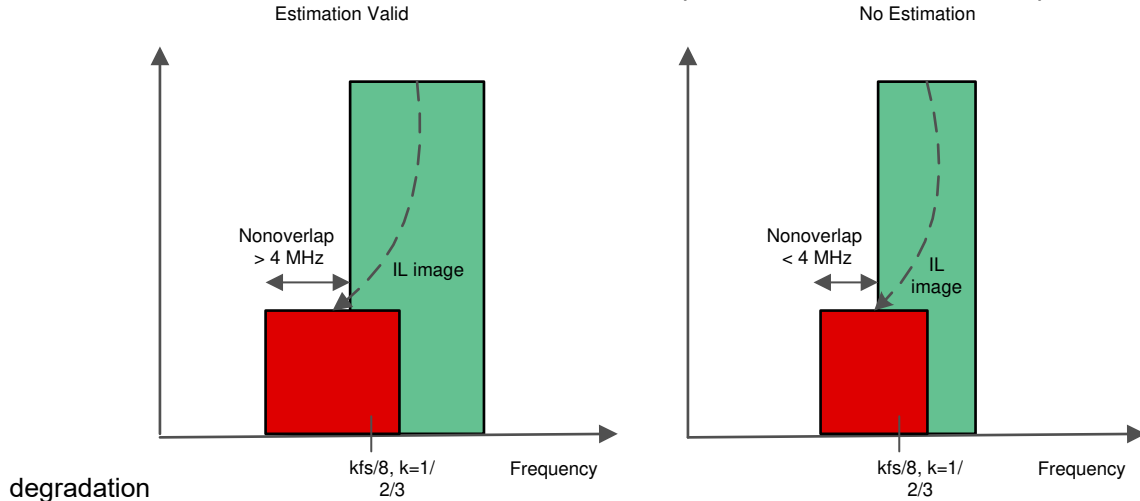

degradation

6. Freezing the IL Engine: If the user knows apriori that any of the conditions in item 5f occurs and would like the old IL correction to be retained, then a good option is to freeze the IL engine. Or, if the user knows that condition in 5g is violated at a known time, then also freezing the IL engine is a good option. Once IL engine is frozen, all past IL estimates/correction are retained and no updates are done to the IL estimates. Once the conditions described above are no longer present, then the IL engine can be unfrozen. The IL engine then starts updating the estimates as though the entire period for which it was frozen did not exist at all.

表 9-4. IL Freeze

SPI Address	SPI Data	Comments
0x4005	0x1	Enable per channel writes
0x4004	0x68	Page Select
0x4003	0x00	Page Select
0x4002	0x00	Page Select
0x4001	0x00	Page Select
0x604D	0x01	Validity for IL Freeze/Unfreeze for CHA
0x704D	0x01	Validity for IL Freeze/Unfreeze for CHB
0x6068	0x04	Freeze IL Engine for CHA
0x7068	0x04	Freeze IL Engine for CHB
0x4004	0x61	Page Select
0x4003	0x00	Page Select
0x4002	0x05	Page Select
0x4001	0x00	Page Select
0x6078	0x00	IL Engine Freeze Secondary Control for CHA
0x7078	0x00	IL Engine Freeze Secondary Control for CHB
0x4004	0x68	Page Select
0x4003	0x00	Page Select

表 9-4. IL Freeze (continued)

SPI Address	SPI Data	Comments
0x4002	0x00	Page Select
0x4001	0x00	Page Select

表 9-5. IL Unfreeze

SPI Address	SPI Data	Comments
0x4005	0x00	Enable per channel writes
0x4004	0x68	Page Select
0x4003	0x00	Page Select
0x4002	0x00	Page Select
0x4001	0x00	Page Select
0x604D	0x01	Validity for IL Freeze/Unfreeze for CHA
0x704D	0x01	Validity for IL Freeze/Unfreeze for CHB
0x6068	0x00	Unfreeze IL Engine for CHA
0x7068	0x00	Unfreeze IL Engine for CHB

7. In case the limitations in items 5 cannot be worked around in the user system and the limitations are permanent (eg a system where the entire band from $[0, fs/2]$ is nearly fully occupied or signals present around $kfs/8$ with overlap $< Fs/256$), then there are 2 options
 - a. Power up/Temp based IL calibration - Do calibration using a single tone (single tone frequency in $[0.77fs/2, 0.9 \times fs/2]$, single tone power in $[-0.5, -25]$ dBFs), either one-time or whenever temperature changes by more than a desired threshold, and then freeze IL estimation module. During calibration, the normal input should be bypassed and the calibration signal should be input to ADS54J40 for 100 ms for high power signals (≥ -3 dBFs) and 500 ms for lower powered signals. Once the calibration time is complete, IL estimation should be frozen and normal signal may be input to ADS54J40. To determine the temperature change for which calibration needs to be done, the user can refer to typical variation of IL spur with temperature, under freeze conditions, as shown in [图 9-11](#) .

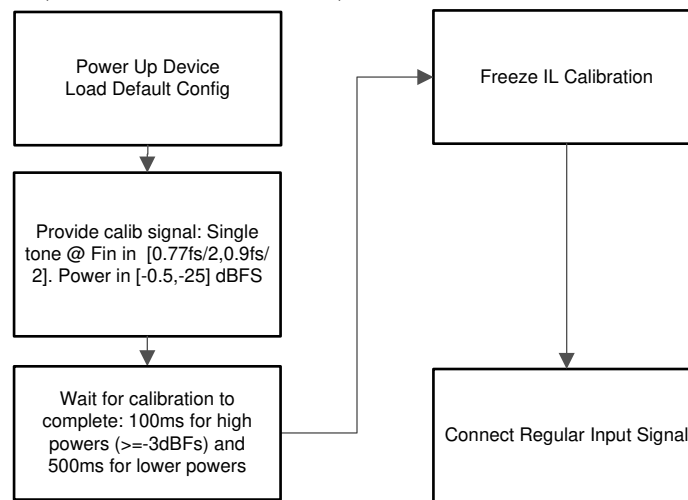

Flowchart For Powerup IL calibration

图 9-11. Flowchart for Powerup IL Calibratuion

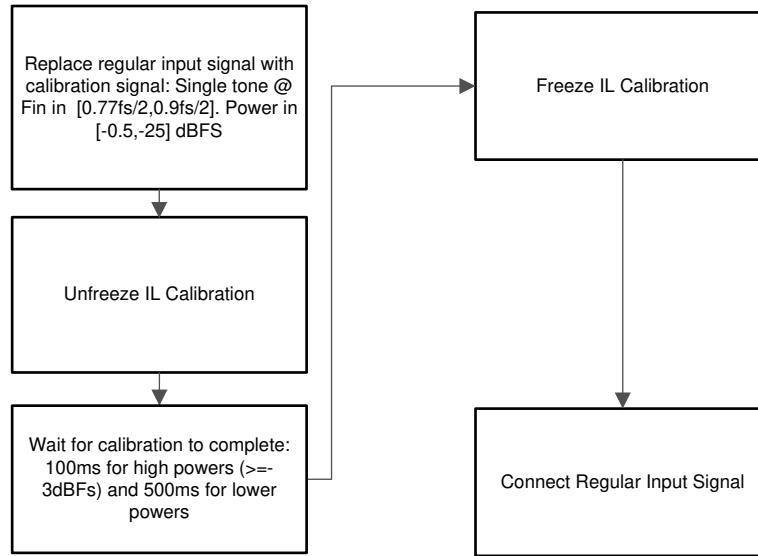

Flowchart For IL Calibration whenever temperature changes significantly

图 9-12. Flow chart for intermittent IL calibration

- b. Disable IL correction - IL performance would be limited to raw IL performance as shown in figure in the data sheet. Note that the disable IL correction sequence includes “pulse reset”. A pulse reset signal resets the internal IL mismatch estimation and correction and the JESD link. Therefore, in case IL correction disable is desired, it is preferable to insert this sequence within the device bring up sequence, just before the final pulse reset is issued.

表 9-6. IL Disable

SPI Address	SPI Data	Comments
0x4005	0x0	Enable single channel writes
0x4004	0x68	Selecting page
0x4003	0x00	Selecting page
0x4002	0x00	Selecting page
0x4001	0x00	Selecting page
0x604B	0x04	Validity for IL Correction Disable for CHA
0x704B	0x04	Validity for IL Correction Disable for CHB
0x6040	0x08	Disable IL Correction for CHA
0x7040	0x08	Disable IL Correction for CHB
0x6000	0x01	Pulse reset assert
0x6000	0x00	Pulse reset de-assert

9.1.6.3 Temperature variation

IL mismatch parameters estimator tracks IL mismatch variations across temperature and gives good performance under normal conditions. However if IL mismatch estimation is frozen, the residual IL mismatch seen would vary with temperature as shown in [图 9-13](#). To reduce the residual IL mismatch below this level, customer may put the system in calibration mode whenever significant temperature change is detected or based on a certain time lapse from the last calibration.



图 9-13. Residual IL Spur for signal at 400 Mhz vs Temperature after freezing IL calibration at 25°C

9.2 Typical Application

The ADS54J40 is designed for wideband receiver applications demanding excellent dynamic range over a large input frequency range. A typical schematic for an ac-coupled receiver is shown in [Figure 9-14](#).

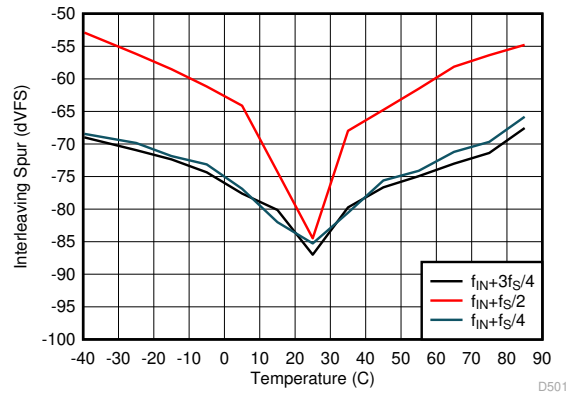
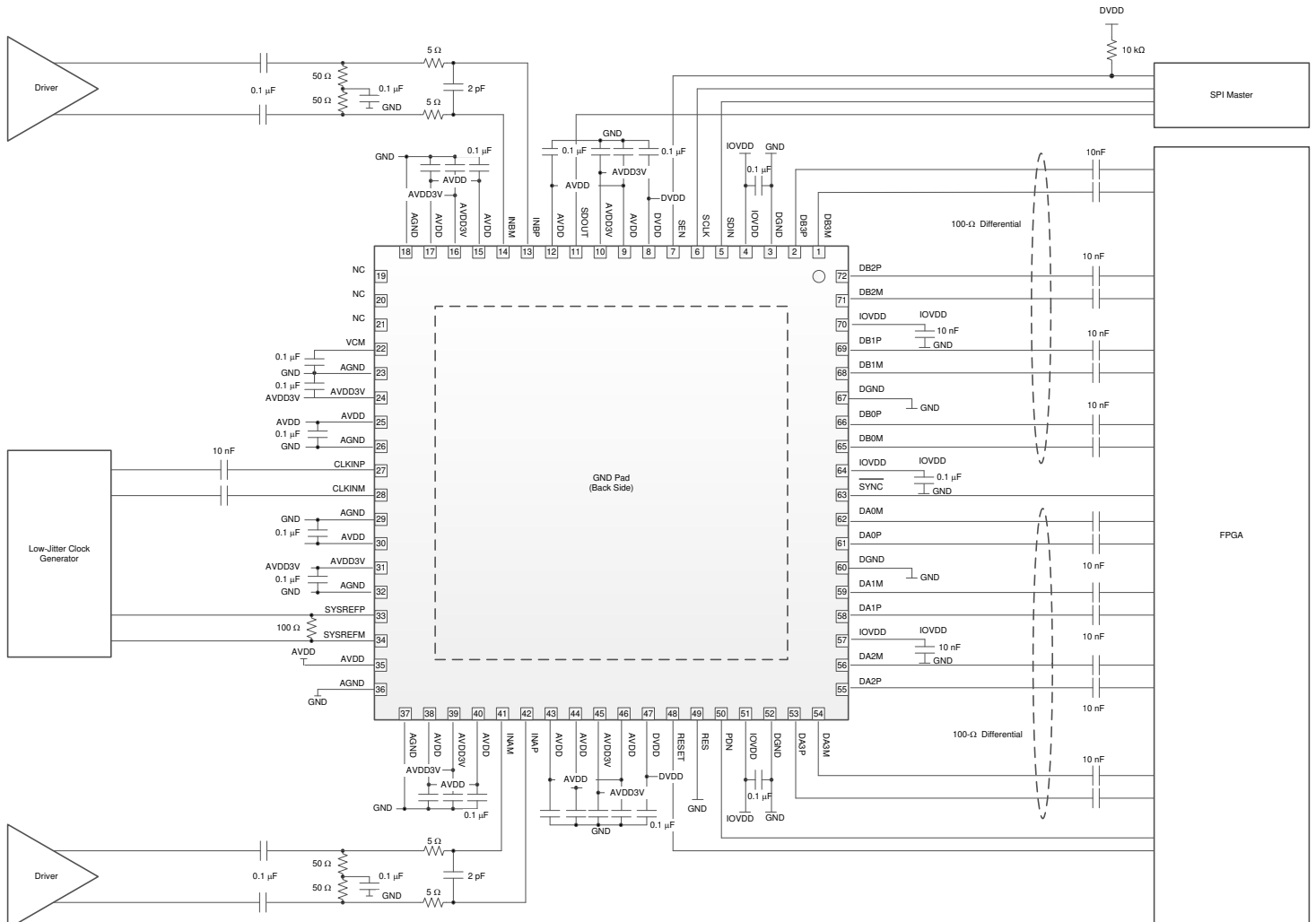

NOTE: GND = AGND and DGND connected in the PCB layout.

Figure 9-14. AC-Coupled Receiver

9.2.1 Design Requirements

9.2.1.1 Transformer-Coupled Circuits

Transformer-Coupled Circuits

Typical applications involving transformer-coupled circuits are discussed in this section. To achieve good phase and amplitude balances at the ADC input, surface-mount transformers can be used (for example transformers such as ADT1-1WT or WBC1-1 can be used for frequencies up to 300 MHz and TC1-1-13M+ for higher frequencies) to achieve good phase and amplitude balances at the ADC inputs. When designing dc-driving circuits, the ADC input impedance must be considered. 图 9-15 and 图 9-16 show the impedance ($Z_{IN} = R_{IN} \parallel C_{IN}$) across the ADC input pins.

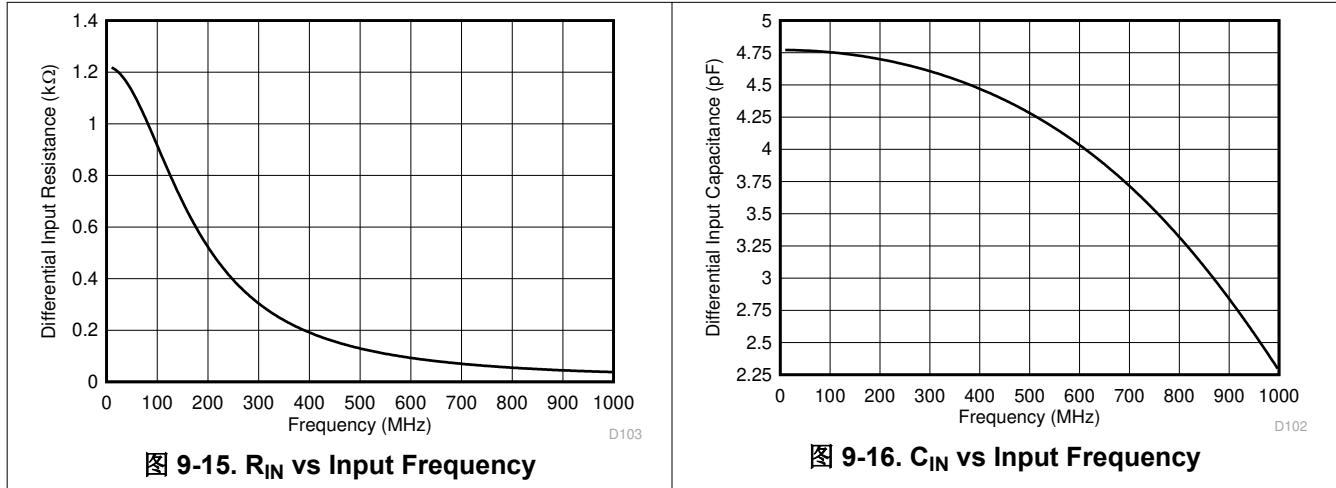

By using the simple drive circuit of 图 9-17, uniform performance can be obtained over a wide frequency range. The buffers present at the analog inputs of the device help isolate the external drive source from the switching currents of the sampling circuit.



图 9-17. Input Drive Circuit

9.2.2 Detailed Design Procedure

For optimum performance, the analog inputs must be driven differentially. This architecture improves common-mode noise immunity and even-order harmonic rejection. A small resistor (5 Ω to 10 Ω) in series with each input pin is recommended to damp out ringing caused by package parasitics, as shown in 图 9-17.

9.2.3 Application Curves

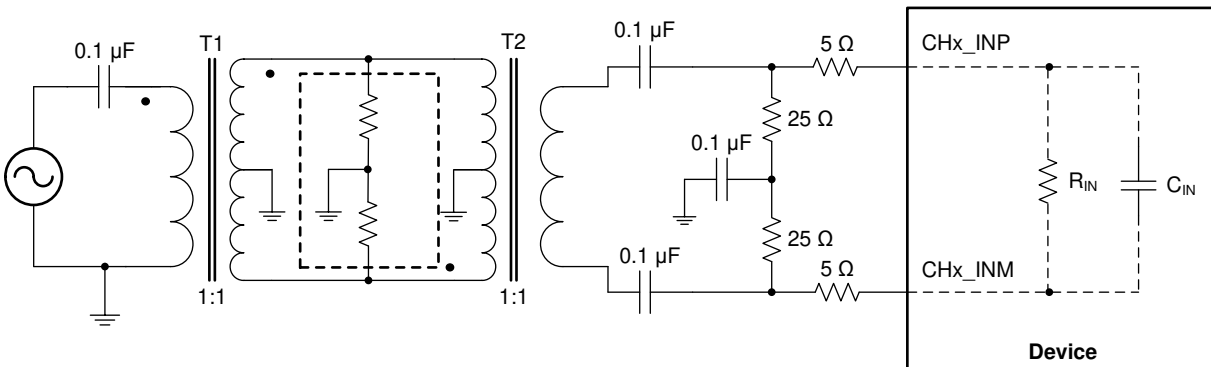
图 9-18 and 图 9-19 show the typical performance at 170 MHz and 230 MHz, respectively.

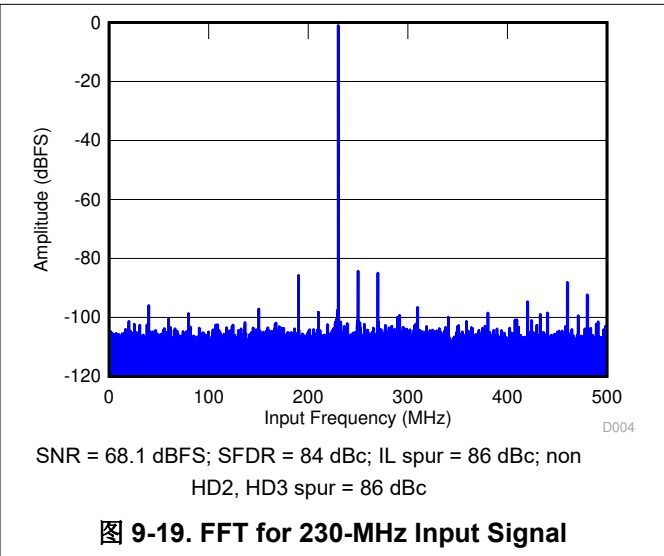
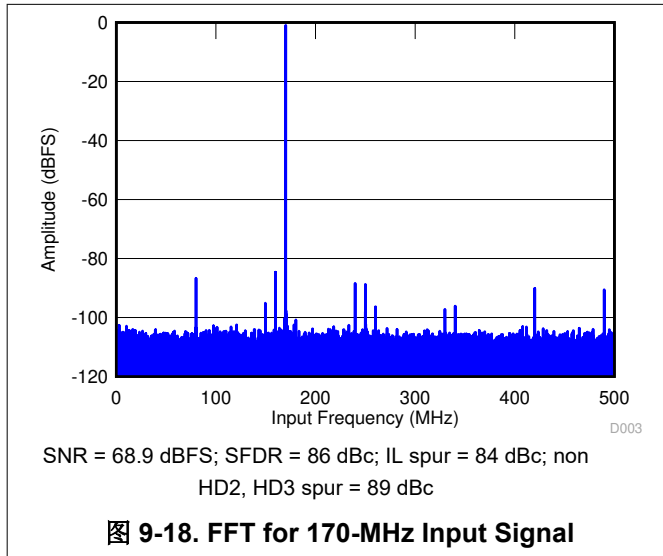

10 Power Supply Recommendations

The device requires a 1.15-V nominal supply for IOVDD, a 1.9-V nominal supply for DVDD, a 1.9-V nominal supply for AVDD, and a 3.0-V nominal supply for AVDD3V. For detailed information regarding the operating voltage minimum and maximum specifications of different supplies, see the [Recommended Operating Conditions](#) table.

10.1 Power Sequencing and Initialization

图 10-1 shows the suggested power-up sequencing for the device. Note that the 1.15-V IOVDD supply must rise before the 1.9-V DVDD supply. If the 1.9-V DVDD supply rises before the 1.15-V IOVDD supply, then the internal default register settings may not load properly. The other supplies (the 3-V AVDD3V and the 1.9-V AVDD), can come up in any order during the power sequence. The power supplies can ramp up at any rate and there is no hard requirement for the time delay between IOVDD ramp up to DVDD ramp-up (can be in orders of microseconds but is recommend to be a few milliseconds).



图 10-1. Power Sequencing for the ADS54Jxx Family of Devices

11 Layout

11.1 Layout Guidelines

The device evaluation module (EVM) layout can be used as a reference layout to obtain the best performance. A layout diagram of the EVM top layer is provided in [Figure 11-1](#). The *ADS54J40 EVM User's Guide*, [SLAU652](#), provides a complete layout of the EVM. Some important points to remember during board layout are:

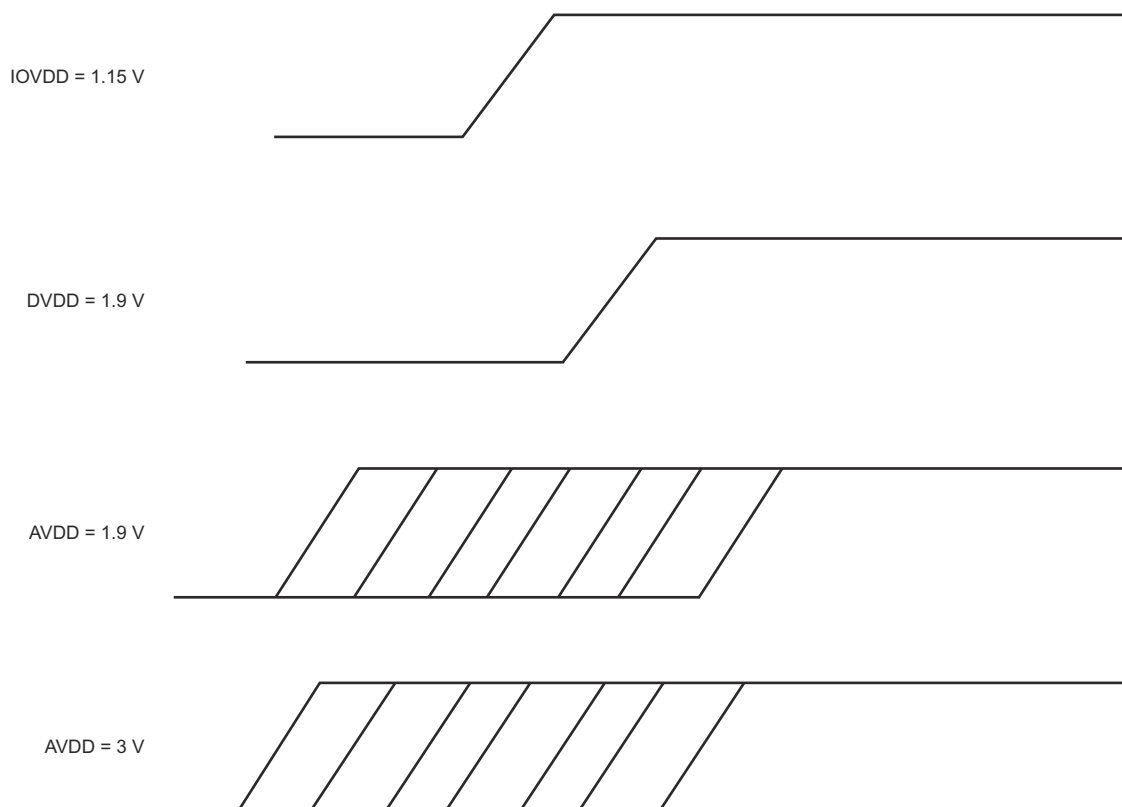
- Analog inputs are located on opposite sides of the device pinout to ensure minimum crosstalk on the package level. To minimize crosstalk onboard, the analog inputs must exit the pinout in opposite directions, as illustrated in the reference layout of [Figure 11-1](#) as much as possible.
- In the device pinout, the sampling clock is located on a side perpendicular to the analog inputs in order to minimize coupling between them. This configuration is also maintained on the reference layout of [Figure 11-1](#) as much as possible.
- Keep digital outputs away from the analog inputs. When these digital outputs exit the pinout, the digital output traces must not be kept parallel to the analog input traces because this configuration can result in coupling from the digital outputs to the analog inputs and degrade performance. All digital output traces to the receiver [such as a field-programmable gate arrays (FPGAs) or an application-specific integrated circuits (ASICs)] must be matched in length to avoid skew among outputs.
- At each power-supply pin (AVDD, DVDD, or AVDDD3V), keep a 0.1- μF decoupling capacitor close to the device. A separate decoupling capacitor group consisting of a parallel combination of 10- μF , 1- μF , and 0.1- μF capacitors can be kept close to the supply source.
- The PDN and SDOUT traces must be routed away from the analog input traces. When the PDN and SDOUT pins are programmed to carry OVR information, the proximity of these pins to the analog traces may result in degradation of the ADC performance because of coupling. For best performance, the PDN and SDOUT traces must not overlap or cross the path of the analog input traces even if routed on different layers of the PCB.

11.2 Layout Example



图 11-1. ADS54J40 EVM Layout

12 Device and Documentation Support

12.1 Documentation Support

12.1.1 Related Documentation

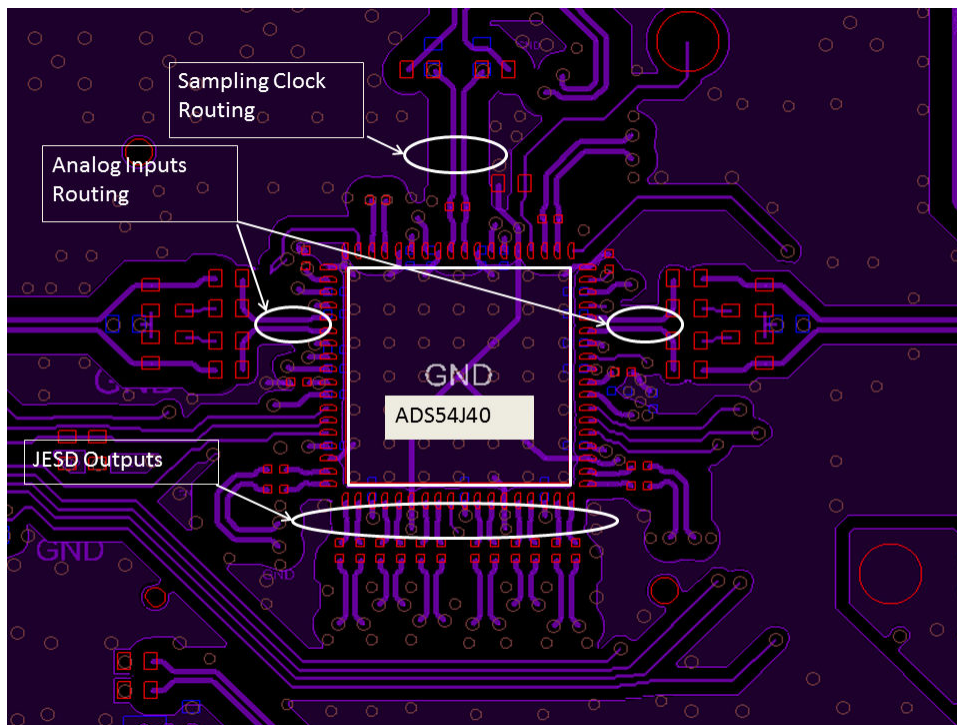
For related documentation see the following:

- [ADS54J20 Dual-Channel, 12-Bit, 1.0-GSPS, Analog-to-Digital Converter](#)
- [ADS54J42 Dual-Channel, 14-Bit, 625-MSPS, Analog-to-Digital Converter](#)
- [ADS54J60 Dual-Channel, 16-Bit, 1.0-GSPS Analog-to-Digital Converter](#)
- [ADS54J66 Quad-Channel, 14-Bit, 500-MSPS ADC with Integrated DDC](#)
- [ADS54J69 Dual-Channel, 16-Bit, 500-MSPS, Analog-to-Digital Converter](#)
- [ADS54J40EVM User's Guide](#)

12.2 Receiving Notification of Documentation Updates

To receive notification of documentation updates, navigate to the device product folder on ti.com. In the upper right corner, click on *Alert me* to register and receive a weekly digest of any product information that has changed. For change details, review the revision history included in any revised document.

12.3 支持资源

TI E2E™ 支持论坛是工程师的重要参考资料，可直接从专家获得快速、经过验证的解答和设计帮助。搜索现有解答或提出自己的问题可获得所需的快速设计帮助。

链接的内容由各个贡献者“按原样”提供。这些内容并不构成 TI 技术规范，并且不一定反映 TI 的观点；请参阅 TI 的《使用条款》。

12.4 Trademarks

TI E2E™ is a trademark of Texas Instruments.

所有商标均为其各自所有者的财产。

12.5 静电放电警告



静电放电 (ESD) 会损坏这个集成电路。德州仪器 (TI) 建议通过适当的预防措施处理所有集成电路。如果不遵守正确的处理和安装程序，可能会损坏集成电路。

ESD 的损坏小至导致微小的性能降级，大至整个器件故障。精密的集成电路可能更容易受到损坏，这是因为非常细微的参数更改都可能会导致器件与其发布的规格不相符。

12.6 术语表

[TI 术语表](#) 本术语表列出并解释了术语、首字母缩略词和定义。

Mechanical, Packaging, and Orderable Information

The following pages include mechanical, packaging, and orderable information. This information is the most current data available for the designated devices. This data is subject to change without notice and revision of this document. For browser-based versions of this data sheet, refer to the left-hand navigation.

PACKAGING INFORMATION

Orderable Device	Status (1)	Package Type	Package Drawing	Pins	Package Qty	Eco Plan (2)	Lead finish/ Ball material (6)	MSL Peak Temp (3)	Op Temp (°C)	Device Marking (4/5)	Samples
ADS54J40IRMP	ACTIVE	VQFN	RMP	72	168	RoHS & Green	NIPDAU	Level-3-260C-168 HR	-40 to 85	AZ54J40	Samples
ADS54J40IRMPT	ACTIVE	VQFN	RMP	72	250	RoHS & Green	NIPDAU	Level-3-260C-168 HR	-40 to 85	AZ54J40	Samples

(1) The marketing status values are defined as follows:

ACTIVE: Product device recommended for new designs.

LIFEBUY: TI has announced that the device will be discontinued, and a lifetime-buy period is in effect.

NRND: Not recommended for new designs. Device is in production to support existing customers, but TI does not recommend using this part in a new design.

PREVIEW: Device has been announced but is not in production. Samples may or may not be available.

OBSOLETE: TI has discontinued the production of the device.

(2) **RoHS:** TI defines "RoHS" to mean semiconductor products that are compliant with the current EU RoHS requirements for all 10 RoHS substances, including the requirement that RoHS substance do not exceed 0.1% by weight in homogeneous materials. Where designed to be soldered at high temperatures, "RoHS" products are suitable for use in specified lead-free processes. TI may reference these types of products as "Pb-Free".

RoHS Exempt: TI defines "RoHS Exempt" to mean products that contain lead but are compliant with EU RoHS pursuant to a specific EU RoHS exemption.

Green: TI defines "Green" to mean the content of Chlorine (Cl) and Bromine (Br) based flame retardants meet JS709B low halogen requirements of <=1000ppm threshold. Antimony trioxide based flame retardants must also meet the <=1000ppm threshold requirement.

(3) MSL, Peak Temp. - The Moisture Sensitivity Level rating according to the JEDEC industry standard classifications, and peak solder temperature.

(4) There may be additional marking, which relates to the logo, the lot trace code information, or the environmental category on the device.

(5) Multiple Device Markings will be inside parentheses. Only one Device Marking contained in parentheses and separated by a "~" will appear on a device. If a line is indented then it is a continuation of the previous line and the two combined represent the entire Device Marking for that device.

(6) Lead finish/Ball material - Orderable Devices may have multiple material finish options. Finish options are separated by a vertical ruled line. Lead finish/Ball material values may wrap to two lines if the finish value exceeds the maximum column width.

Important Information and Disclaimer:The information provided on this page represents TI's knowledge and belief as of the date that it is provided. TI bases its knowledge and belief on information provided by third parties, and makes no representation or warranty as to the accuracy of such information. Efforts are underway to better integrate information from third parties. TI has taken and continues to take reasonable steps to provide representative and accurate information but may not have conducted destructive testing or chemical analysis on incoming materials and chemicals. TI and TI suppliers consider certain information to be proprietary, and thus CAS numbers and other limited information may not be available for release.

In no event shall TI's liability arising out of such information exceed the total purchase price of the TI part(s) at issue in this document sold by TI to Customer on an annual basis.

TAPE AND REEL INFORMATION

QUADRANT ASSIGNMENTS FOR PIN 1 ORIENTATION IN TAPE

*All dimensions are nominal

Device	Package Type	Package Drawing	Pins	SPQ	Reel Diameter (mm)	Reel Width W1 (mm)	A0 (mm)	B0 (mm)	K0 (mm)	P1 (mm)	W (mm)	Pin1 Quadrant
ADS54J40IRMPT	VQFN	RMP	72	250	180.0	24.4	10.25	10.25	2.25	16.0	24.0	Q2

TAPE AND REEL BOX DIMENSIONS

*All dimensions are nominal

Device	Package Type	Package Drawing	Pins	SPQ	Length (mm)	Width (mm)	Height (mm)
ADS54J40IRMPT	VQFN	RMP	72	250	213.0	191.0	55.0

TRAY



Chamfer on Tray corner indicates Pin 1 orientation of packed units.

*All dimensions are nominal

Device	Package Name	Package Type	Pins	SPQ	Unit array matrix	Max temperature (°C)	L (mm)	W (mm)	K0 (µm)	P1 (mm)	CL (mm)	CW (mm)
ADS54J40IRMP	RMP	VQFN	72	168	8 X 21	150	315	135.9	7620	14.65	11	11.95

EXAMPLE BOARD LAYOUT

RMP0072A

VQFN - 0.9 mm max height

VQFN

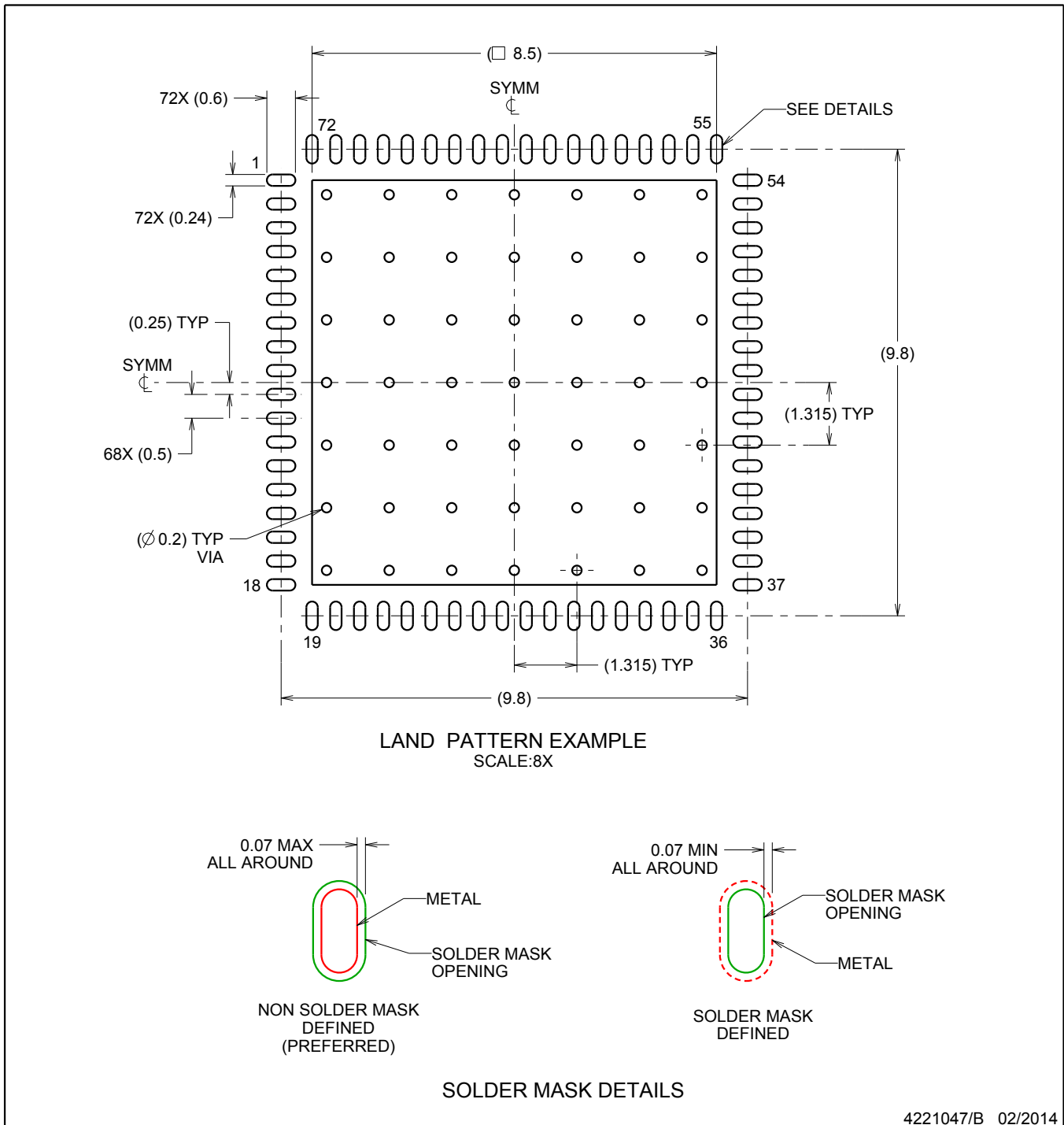

NOTES: (continued)

4. This package is designed to be soldered to a thermal pad on the board. For more information, see QFN/SON PCB application report in literature No. SLUA271 (www.ti.com/lit/slua271).

EXAMPLE STENCIL DESIGN

RMP0072A

VQFN - 0.9 mm max height

VQFN

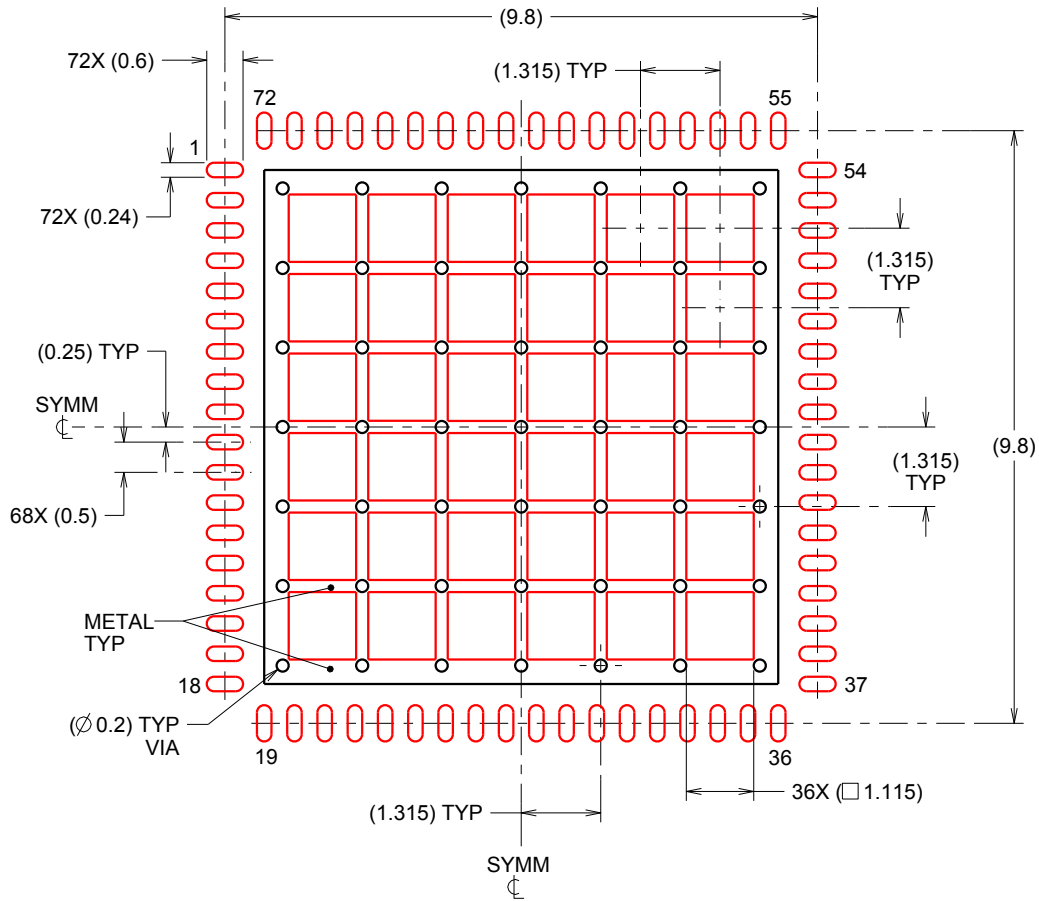

SOLDER PASTE EXAMPLE
 BASED ON 0.125 mm THICK STENCIL

EXPOSED PAD
 62% PRINTED SOLDER COVERAGE BY AREA
 SCALE:8X

4221047/B 02/2014

NOTES: (continued)

5. Laser cutting apertures with trapezoidal walls and rounded corners may offer better paste release. IPC-7525 may have alternate design recommendations.

重要声明和免责声明

TI“按原样”提供技术和可靠性数据（包括数据表）、设计资源（包括参考设计）、应用或其他设计建议、网络工具、安全信息和其他资源，不保证没有瑕疵且不做任何明示或暗示的担保，包括但不限于对适销性、某特定用途方面的适用性或不侵犯任何第三方知识产权的暗示担保。

这些资源可供使用 TI 产品进行设计的熟练开发人员使用。您将自行承担以下全部责任：(1) 针对您的应用选择合适的 TI 产品，(2) 设计、验证并测试您的应用，(3) 确保您的应用满足相应标准以及任何其他功能安全、信息安全、监管或其他要求。

这些资源如有变更，恕不另行通知。TI 授权您仅可将这些资源用于研发本资源所述的 TI 产品的应用。严禁对这些资源进行其他复制或展示。您无权使用任何其他 TI 知识产权或任何第三方知识产权。您应全额赔偿因在这些资源的使用中对 TI 及其代表造成的任何索赔、损害、成本、损失和债务，TI 对此概不负责。

TI 提供的产品受 [TI 的销售条款](#) 或 [ti.com](#) 上其他适用条款/TI 产品随附的其他适用条款的约束。TI 提供这些资源并不会扩展或以其他方式更改 TI 针对 TI 产品发布的适用的担保或担保免责声明。

TI 反对并拒绝您可能提出的任何其他或不同的条款。

邮寄地址：Texas Instruments, Post Office Box 655303, Dallas, Texas 75265
Copyright © 2024，德州仪器 (TI) 公司