

## AFE1598 用于生物电势测量的低功耗 8 通道 24 位模拟前端

### 1 特性

- 用于 ECG、起搏信号检测和呼吸测量的集成信号链
- **ECG 接收器**
  - 八个高分辨率通道，每通道的功耗低至 0.37mW
  - 可从十个电极选择的灵活八导联
  - 可编程增益: 1.25 至 9
  - 噪声：150Hz 时为 4.7  $\mu$ V<sub>PP</sub>，增益 = 4
  - 差分输入范围：±1V (增益 = 4)
  - CMRR：-140dB
  - 数据速率：125SPS 至 128kSPS
- **起搏信号检测**
  - 可编程四导联上的片上数字起搏信号检测算法
  - 四个通道上的高速 128kSPS 起搏信号输出，用于软件起搏信号检测
- **呼吸**
  - 16m $\Omega$  <sub>PP</sub> 低噪声，每个电极具备 2k $\Omega$  人体阻抗和 1k $\Omega$  除颤器保护电阻
  - 支持正弦波和方波激励
- **其他特性**
  - 内置的右腿驱动放大器可导向到任何电极
  - 直流导联脱落检测、交流导联阻抗检测、威尔逊中心终端 (WCT)、戈德伯格中心终端 (GCT)、测试信号
  - 电池电压监测
  - 灵活的断电和待机模式
  - 内置振荡器、PLL 和基准
  - 1k 样片主 FIFO 和 2k 样片空间 FIFO
  - SPI 兼容串行接口
  - 模拟电源电压 1：3.15V 至 5.25V
  - 模拟电源电压 2：1.7V 至 1.9V
  - I/O 电源电压：1.65V 至 3.6V
- 支持系统满足 AAMI EC11、AMI EC13、AMI EC38、IEC60601-1、IEC60601-2-25、IEC60601-2-27 和 IEC60601-2-51 标准

### 2 应用

- 医疗仪器 ( ECG、EMG 和 EEG ) :
  - 临床患者监护和诊断 ECG
  - 便携式遥测
  - 动态心电图监测仪和多导联贴片
- 事件、压力和生命体征监测器：
  - ECG
  - AED
  - 远程医疗双谱指数 (BIS)
  - 诱发听觉电位 (EAP)
  - 睡眠研究监视器

### 3 说明

AFE1598 是多通道同步采样 24 位  $\Delta$ - $\Sigma$  模数转换器 (ADC) 系列，此系列 ADC 具有内置可编程增益仪表放大器 (INA)、内部基准以及片上 PLL。该 AFE 支持数字起搏脉冲检测和胸阻抗测量，并包含了医疗心电图 (ECG) 和脑电图 (EEG) 应用通常需要的所有特性。可在高通道数量系统中级联多个 AFE159x 器件。凭借高集成度和出色性能，AFE159x 能够以大幅缩小的尺寸、显著降低的功耗和整体成本助力开发可扩展的医疗仪器系统。

#### 封装信息

器件型号	封装 <sup>(1)</sup>	封装尺寸 <sup>(2)</sup>
AFE1598	QFN	8mm × 8mm
AFE1598	WCSP	3.6mm × 5.2mm

- (1) 有关所有可用封装，请参阅“机械、封装和可订购信息”。  
 (2) 封装尺寸 (长 × 宽) 为标称值，并包括引脚 (如适用)。



## 内容

---

1 特性.....	1	6 机械、封装和可订购信息.....	4
2 应用.....	1	6.1 封装选项附录.....	5
3 说明.....	1	6.2 卷带包装信息.....	7
4 器件比较.....	3	6.3 机械数据.....	9
5 修订历史记录.....	4		

---

## 4 器件比较

表 4-1. AFE159x 型号间的特性比较

	AFE159RP8	AFE159P8	AFE1598
ECG 电极引脚数量	10	10	10
ECG 通道数量	8	8	8
呼吸电极引脚数量	4	4 <sup>(1)</sup>	4 <sup>(1)</sup>
呼吸接收器通道数量	1	-	-
内部起搏信号检测通道数量	4	4	-

(1) 仅 RESP\_OUT 引脚可用，RESP\_IN 引脚为 NC。

## 5 修订历史记录

注：以前版本的页码可能与当前版本的页码不同

日期	修订版本	注释
December 2025	*	量产数据

## 6 机械、封装和可订购信息

以下页面包含机械、封装和可订购信息。这些信息是指定器件可用的最新数据。数据如有变更，恕不另行通知，且不会对此文档进行修订。有关此数据表的浏览器版本，请查阅左侧的导航栏。

## 6.1 封装选项附录

### 封装信息

可订购器件	状态 <sup>(1)</sup>	封装类型	封装图	引脚	包装数量	环保计划 <sup>(2)</sup>	铅/焊球镀层 <sup>(6)</sup>	MSL 峰值温度 <sup>(3)</sup>	工作温度 (°C)	器件标识 <sup>(4) (5)</sup>
AFE159RP8RTQR	预览	VQFN	RTQ	56	2000	绿色环保 (RoHS, 无锡/溴)	NIPDAU	2级-260C-1年	-20 至 85	AFE159RP8
AFE159RP8RTQT	预览	VQFN	RTQ	56	250	绿色环保 (RoHS, 无锡/溴)	NIPDAU	2级-260C-1年	-20 至 85	AFE159RP8
AFE159P8RTQR	预览	VQFN	RTQ	56	2000	绿色环保 (RoHS, 无锡/溴)	NIPDAU	2级-260C-1年	-20 至 85	AFE159P8
AFE159P8RTQT	预览	VQFN	RTQ	56	250	绿色环保 (RoHS, 无锡/溴)	NIPDAU	2级-260C-1年	-20 至 85	AFE159P8
AFE1598RTQR	预览	VQFN	RTQ	56	2000	绿色环保 (RoHS, 无锡/溴)	NIPDAU	2级-260C-1年	-20 至 85	AFE1598
AFE1598RTQT	预览	VQFN	RTQ	56	250	绿色环保 (RoHS, 无锡/溴)	NIPDAU	2级-260C-1年	-20 至 85	AFE1598
AFE159RP8YAFR	预览	DSBGA	YAF	70	6000	绿色环保 (RoHS, 无锡/溴)	SNAGCU	Level-1-260C-UNLIM	-20 至 85	AFE159RP8
AFE159RP8YAFT	预览	DSBGA	YAF	70	250	绿色环保 (RoHS, 无锡/溴)	SNAGCU	Level-1-260C-UNLIM	-20 至 85	AFE159RP8
AFE159P8YAFR	预览	DSBGA	YAF	70	6000	绿色环保 (RoHS, 无锡/溴)	SNAGCU	Level-1-260C-UNLIM	-20 至 85	AFE159P8
AFE159P8YAFT	预览	DSBGA	YAF	70	250	绿色环保 (RoHS, 无锡/溴)	SNAGCU	Level-1-260C-UNLIM	-20 至 85	AFE159P8
AFE159P8YAFR	预览	DSBGA	YAF	70	6000	绿色环保 (RoHS, 无锡/溴)	SNAGCU	Level-1-260C-UNLIM	-20 至 85	AFE159P8

可订购器件	状态 <sup>(1)</sup>	封装类型	封装图	引脚	包装数量	环保计划 <sup>(2)</sup>	铅/焊球镀层 <sup>(6)</sup>	MSL 峰值温度 <sup>(3)</sup>	工作温度 (°C)	器件标识 <sup>(4) (5)</sup>
AFE159P8YAFT	预览	DSBGA	YAF	70	250	绿色环保 (RoHS, 无 锡/溴)	SNAGCU	Level-1-260C- UNLIM	-20 至 85	AFE159P8

(1) 销售状态值定义如下：

**正在供货：**建议用于新设计的产品器件。

**限期购买：**TI 已宣布器件即将停产，但仍在购买期限内。

**NRND：**不推荐用于新设计。为支持现有客户，器件仍在生产，但 TI 不建议在新设计中使用此器件。

**PRE\_PROD：**器件未发布，尚未量产，未向大众市场供货，也未在网络上供应，未提供样片。

**预发布：**器件已发布，但未量产。可能提供样片，也可能无法提供样片。

**已停产：**TI 已停止生产该器件。

(2) 环保计划 - 规划的环保分级包括：无铅 (RoHS)，无铅 (RoHS 豁免) 或绿色 (RoHS, 无锡/溴) - 如需了解最新供货信息及更多产品内容详情，请访问 [www.ti.com.cn/productcontent](http://www.ti.com.cn/productcontent)。

**待定：**无铅/绿色环保转换计划尚未确定。

**无铅 (RoHS)：**TI 所说的“无铅”或“无 Pb”是指半导体产品符合针对所有 6 种物质的现行 RoHS 要求，包括要求铅的重量不超过同质材料总重量的 0.1%。因在设计时就考虑到了高温焊接要求，因此 TI 的无铅产品适用于指定的无铅作业。

**无铅 (RoHS 豁免)：**该元件在以下两种情况下可享受 RoHS 豁免：1) 芯片和封装之间使用铅基倒装芯片焊接凸点；2) 芯片和引线框之间使用铅基芯片粘合剂。否则，元件将根据上述规定视为无铅 (符合 RoHS)。

绿色环保 (RoHS, 无锡/溴)：TI 定义的“绿色环保”表示无铅 (符合 RoHS 标准)、无溴 (Br) 和无锡 (Sb) 系阻燃剂 (均质材料中 Br 或 Sb 的质量不超过总质量的 0.1%)。

(3) MSL, 峰值温度-- 湿敏等级额定值 (符合 JEDEC 工业标准分级) 和峰值焊接温度。

(4) 器件上可能还有与标识、批次跟踪代码信息或环境分类相关的其他标志。

(5) 如有多个器件标识，将用括号括起来。不过，器件上仅显示括号中以“~”隔开的其中一个器件标识。如果某一行缩进，说明该行续接上一行，这两行合在一起表示该器件的完整器件标识。

(6) 铅/焊球镀层 - 可订购器件可能有多种镀层材料选项。各镀层选项用垂直线隔开。如果铅/焊球镀层值超出最大列宽，则会折为两行。

## 6.2 卷带包装信息

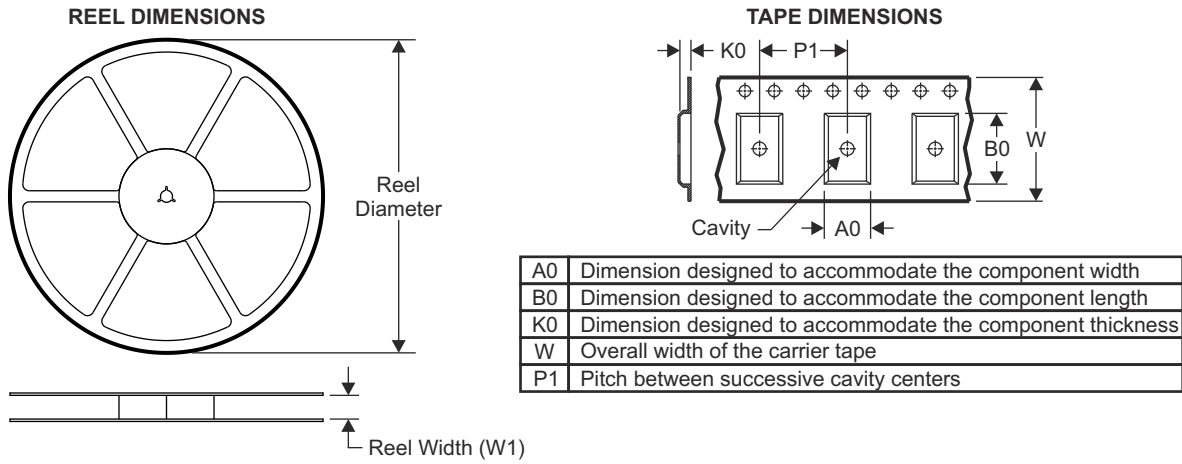

### QUADRANT ASSIGNMENTS FOR PIN 1 ORIENTATION IN TAPE

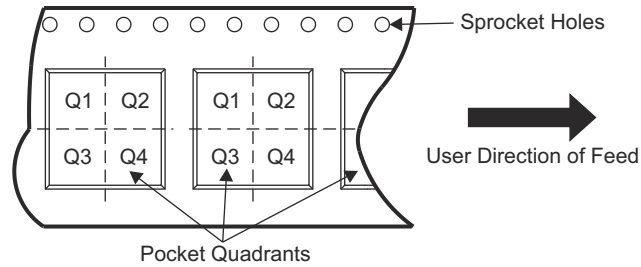

器件	封装类型	封装图	引脚	SPQ	卷带直径 (mm)	卷带宽度 W1 (mm)	A0 (mm)	B0 (mm)	K0 (mm)	P1 (mm)	W (mm)	Pin1 象限
AFE159RP8RTQR	VQFN	RTQ	56	2000	330.0	16.4	8.3	8.3	1.1	12.0	16.0	Q2
AFE159RP8RTQT	VQFN	RTQ	56	250	180.0	16.4	8.3	8.3	1.1	12.0	16.0	Q2
AFE159P8RTQR	VQFN	RTQ	56	2000	330.0	16.4	8.3	8.3	1.1	12.0	16.0	Q2
AFE159P8RTQT	VQFN	RTQ	56	250	180.0	16.4	8.3	8.3	1.1	12.0	16.0	Q2
AFE1598RTQR	VQFN	RTQ	56	2000	330.0	16.4	8.3	8.3	1.1	12.0	16.0	Q2
AFE1598RTQT	VQFN	RTQ	56	250	180.0	16.4	8.3	8.3	1.1	12.0	16.0	Q2
AFE159RP8YAFR	DSBGA	YAF	70	6000	330.0	16.4	4.36	5.56	0.81	8.0	12.0	Q1
AFE159RP8YAFT	DSBGA	YAF	70	250	180.0	16.4	4.36	5.56	0.81	8.0	12.0	Q1
AFE159P8YAFR	DSBGA	YAF	70	6000	330.0	16.4	4.36	5.56	0.81	8.0	12.0	Q1
AFE159P8YAFT	DSBGA	YAF	70	250	180.0	16.4	4.36	5.56	0.81	8.0	12.0	Q1
AFE159P8YAFR	DSBGA	YAF	70	6000	330.0	16.4	4.36	5.56	0.81	8.0	12.0	Q1
AFE159P8YAFT	DSBGA	YAF	70	250	180.0	16.4	4.36	5.56	0.81	8.0	12.0	Q1

## TAPE AND REEL BOX DIMENSIONS

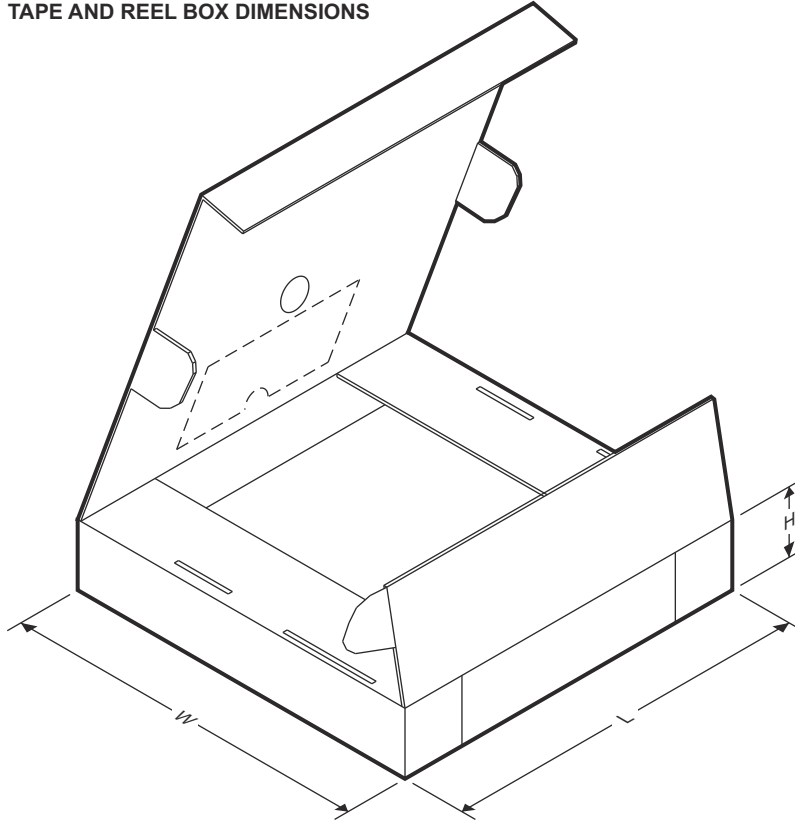

器件	封装类型	封装图	引脚	SPQ	长度 (mm)	宽度 (mm)	高度 (mm)
AFE159RP8RTQR	VQFN	RTQ	56	2000	367.0	367.0	35.0
AFE159RP8RTQT	VQFN	RTQ	56	250	210.0	185.0	35.0
AFE159P8RTQR	VQFN	RTQ	56	2000	367.0	367.0	35.0
AFE159P8RTQT	VQFN	RTQ	56	250	210.0	185.0	35.0
AFE1598RTQR	VQFN	RTQ	56	2000	367.0	367.0	35.0
AFE1598RTQT	VQFN	RTQ	56	250	210.0	185.0	35.0
AFE159RP8YAFR	DSBGA	YAF	70	6000	335.0	335.0	25.0
AFE159RP8YAFT	DSBGA	YAF	70	250	182.0	182.0	20.0
AFE159P8YAFR	DSBGA	YAF	70	6000	335.0	335.0	25.0
AFE159P8YAFT	DSBGA	YAF	70	250	182.0	182.0	20.0
AFE159P8YAFR	DSBGA	YAF	70	6000	335.0	335.0	25.0
AFE159P8YAFT	DSBGA	YAF	70	250	182.0	182.0	20.0

6.3 机械数据

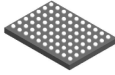
**YAF0070-C01**  **PACKAGE OUTLINE**  
**DSBGA - 0.55 mm max height**  
DIE SIZE BALL GRID ARRAY

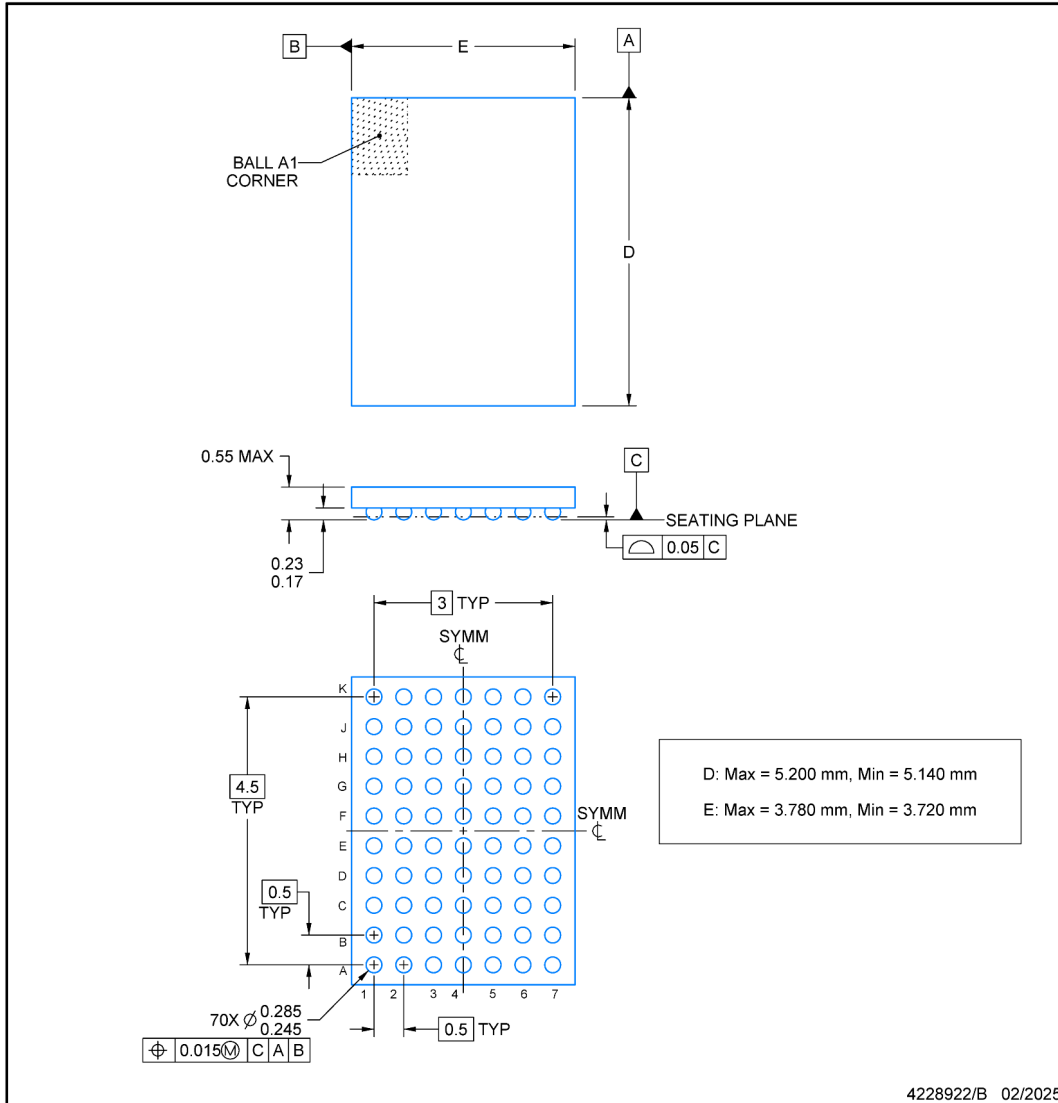

NOTES:

1. All linear dimensions are in millimeters. Any dimensions in parenthesis are for reference only. Dimensioning and tolerancing per ASME Y14.5M.
2. This drawing is subject to change without notice.

## EXAMPLE BOARD LAYOUT

**YAF0070-C01**

**DSBGA - 0.55 mm max height**

DIE SIZE BALL GRID ARRAY

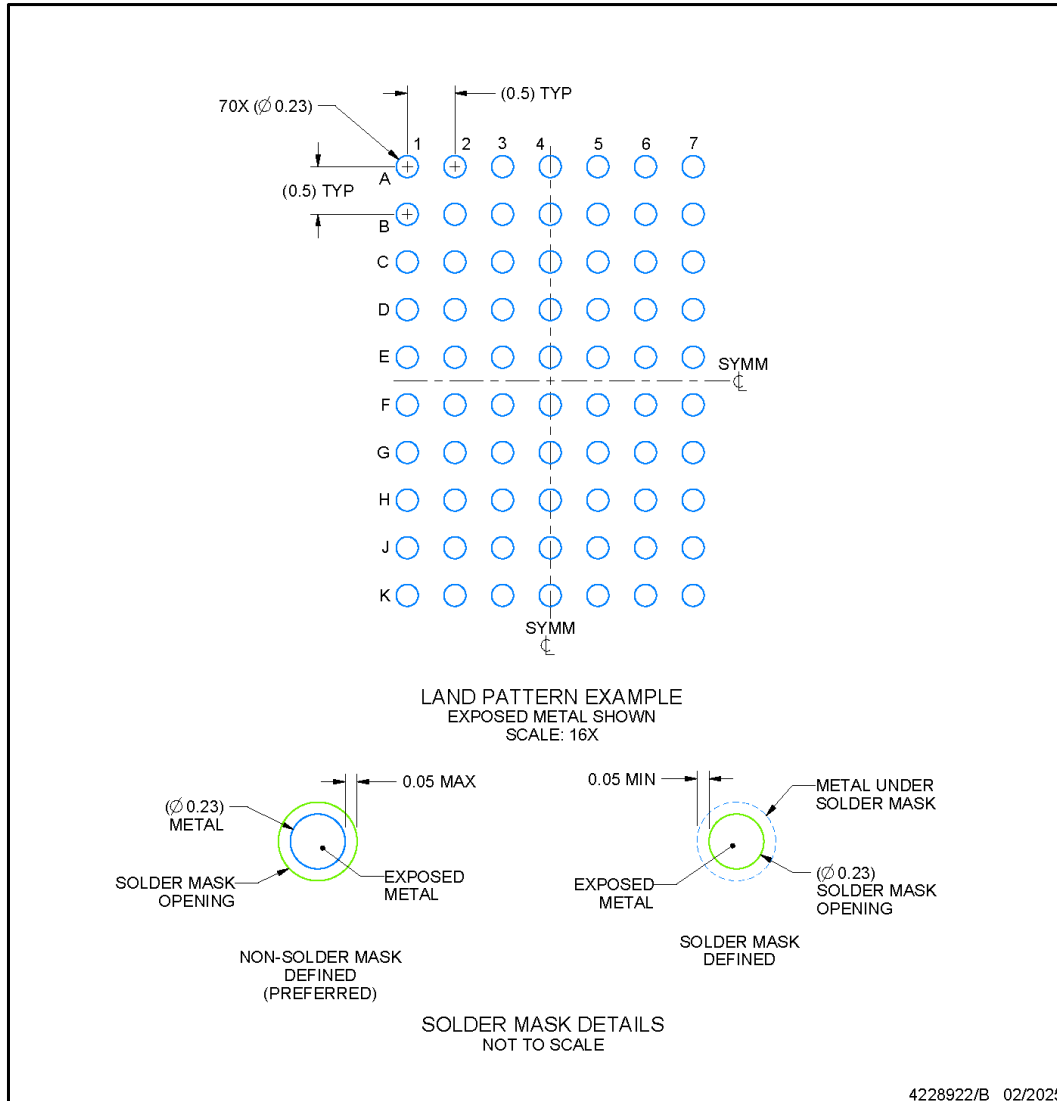

NOTES: (continued)

- Final dimensions may vary due to manufacturing tolerance considerations and also routing constraints. See Texas Instruments Literature No. SNVA009 ([www.ti.com/lit/snva009](http://www.ti.com/lit/snva009)).

## EXAMPLE STENCIL DESIGN

YAF0070-C01

DSBGA - 0.55 mm max height

DIE SIZE BALL GRID ARRAY

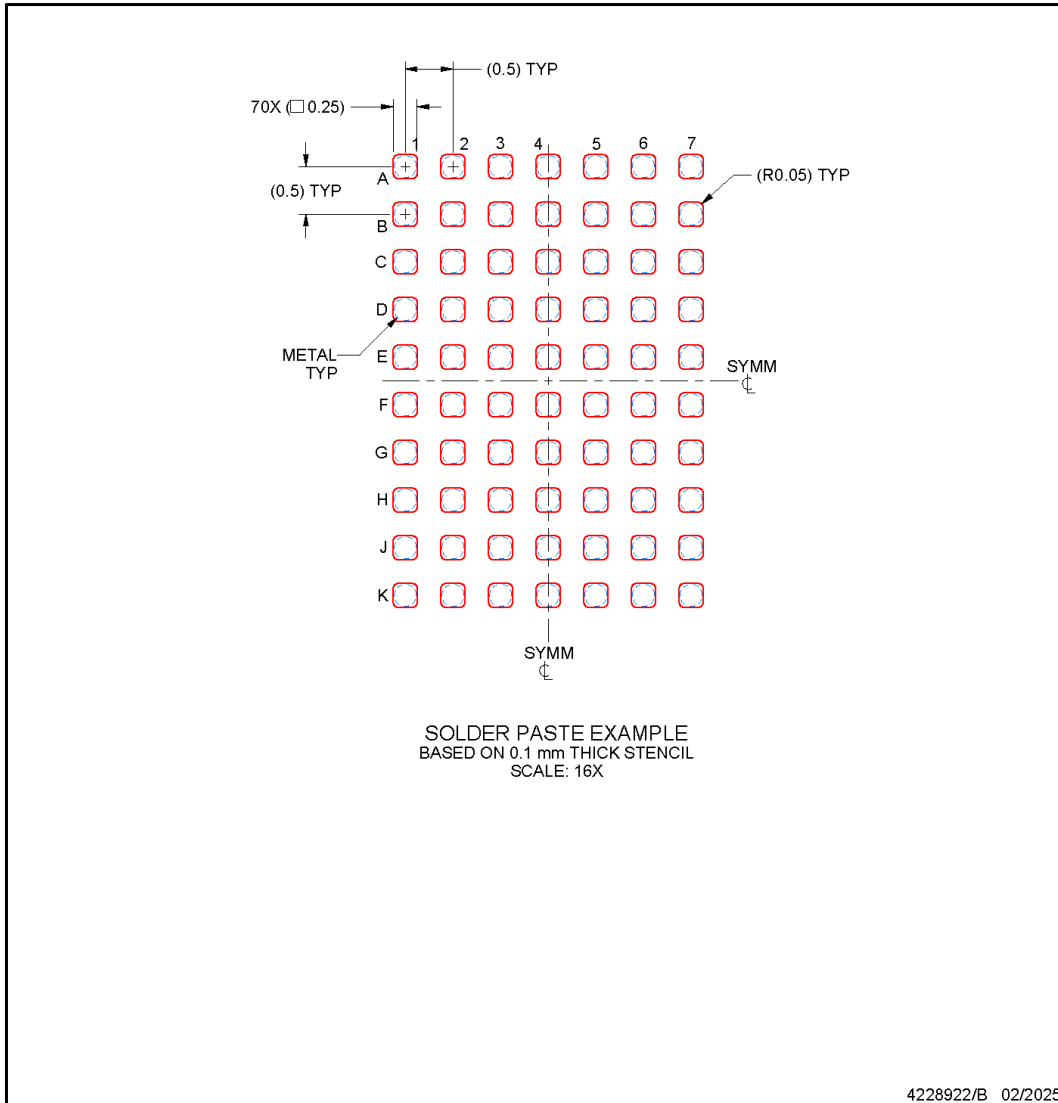

NOTES: (continued)

4. Laser cutting apertures with trapezoidal walls and rounded corners may offer better paste release.

**RTQ0056K**

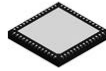

**PACKAGE OUTLINE**

**VQFN - 1 mm max height**

PLASTIC QUAD FLATPACK - NO LEAD

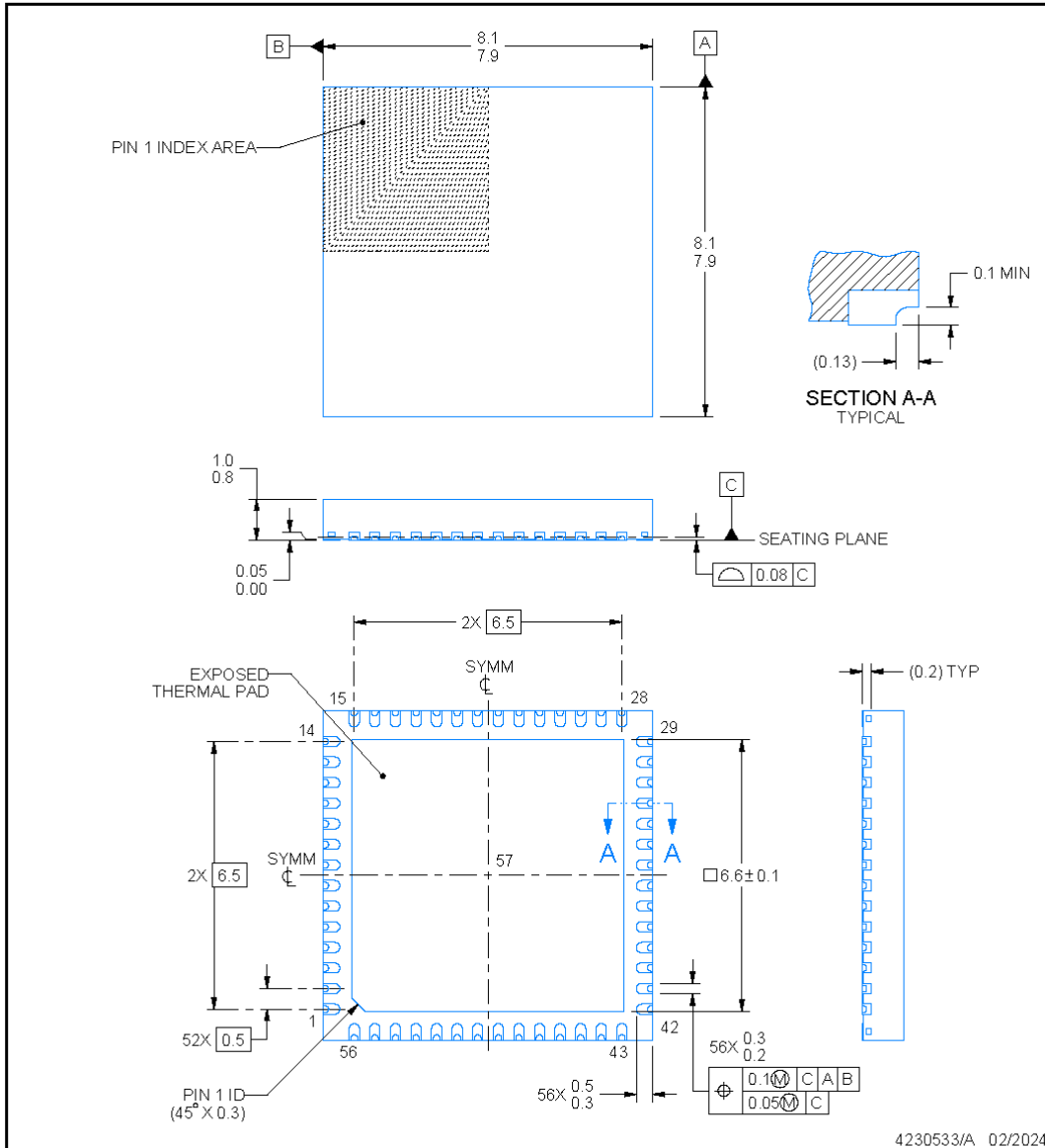

NOTES:

1. All linear dimensions are in millimeters. Any dimensions in parenthesis are for reference only. Dimensioning and tolerancing per ASME Y14.5M.
2. This drawing is subject to change without notice.
3. The package thermal pad must be soldered to the printed circuit board for thermal and mechanical performance.

## EXAMPLE BOARD LAYOUT

RTQ0056K

VQFN - 1 mm max height

PLASTIC QUAD FLATPACK - NO LEAD

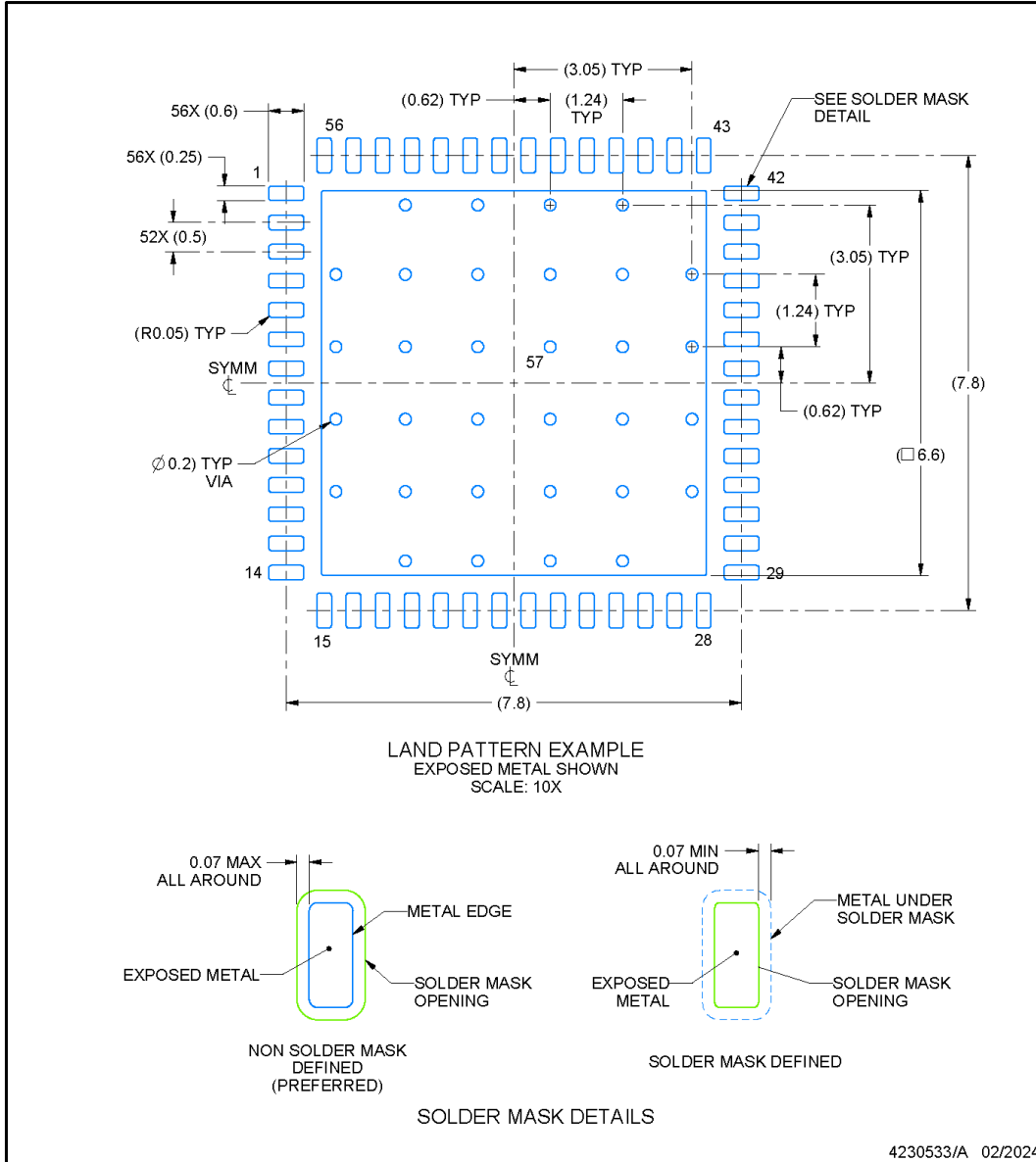

NOTES: (continued)

- This package is designed to be soldered to a thermal pad on the board. For more information, see Texas Instruments literature number SLUA271 ([www.ti.com/lit/sl原因271](http://www.ti.com/lit/sl原因271)).
- Vias are optional depending on application, refer to device data sheet. If any vias are implemented, refer to their locations shown on this view. It is recommended that vias under paste be filled, plugged or tented.

## EXAMPLE STENCIL DESIGN

**RTQ0056K**

**VQFN - 1 mm max height**

PLASTIC QUAD FLATPACK - NO LEAD

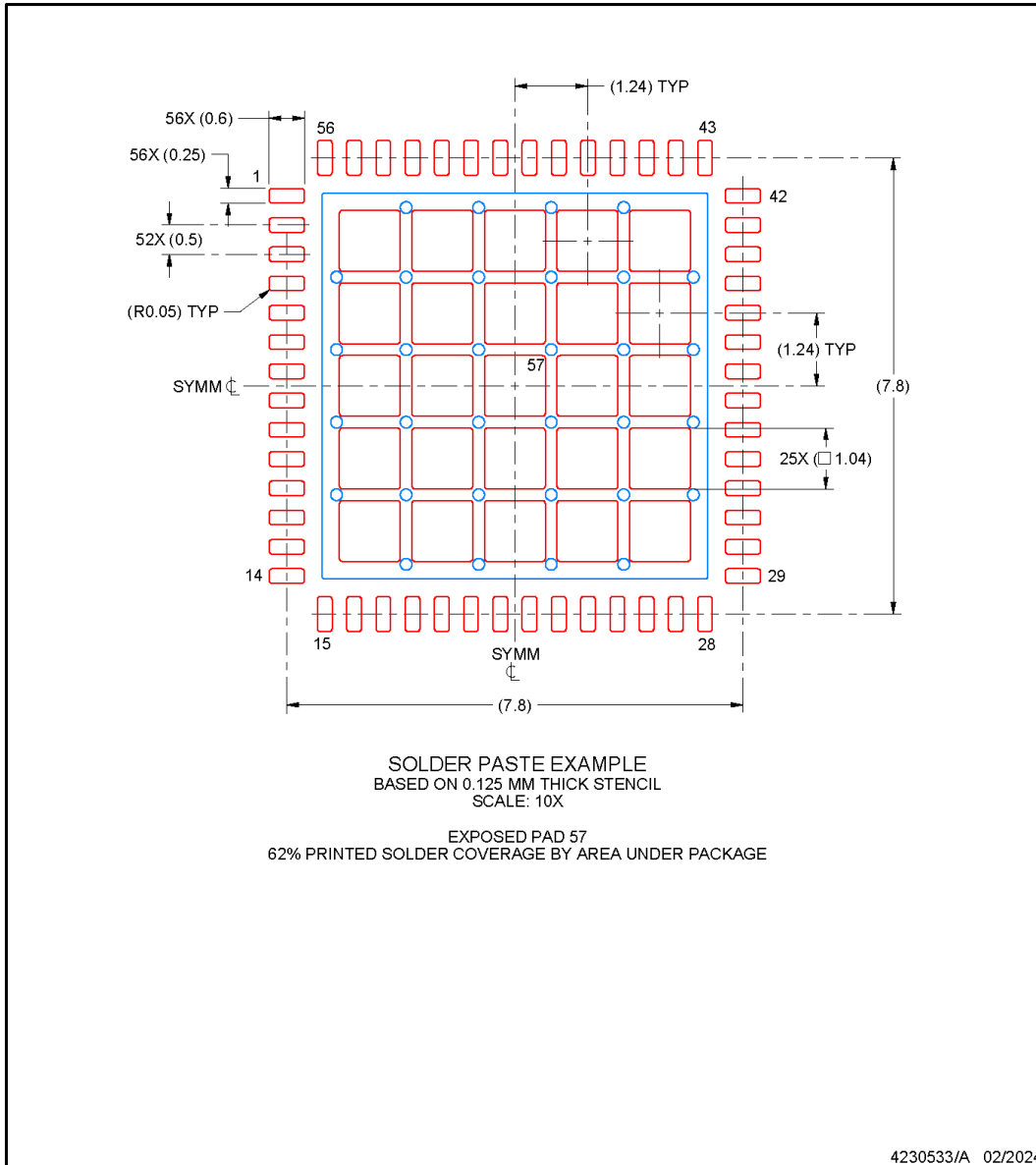

NOTES: (continued)

6. Laser cutting apertures with trapezoidal walls and rounded corners may offer better paste release. IPC-7525 may have alternate design recommendations.

## PACKAGING INFORMATION

Orderable part number	Status (1)	Material type (2)	Package   Pins	Package qty   Carrier	RoHS (3)	Lead finish/ Ball material (4)	MSL rating/ Peak reflow (5)	Op temp (°C)	Part marking (6)
<a href="#">AFE159RP8RTQR</a>	Active	Production	QFN (RTQ)   56	2000   LARGE T&R	Yes	NIPDAU	Level-2-260C-1 YEAR	-20 to 85	AFE159RP8
<a href="#">AFE159RP8RTQT</a>	Active	Production	QFN (RTQ)   56	250   SMALL T&R	Yes	NIPDAU	Level-2-260C-1 YEAR	-20 to 85	AFE159RP8

(1) **Status:** For more details on status, see our [product life cycle](#).

(2) **Material type:** When designated, preproduction parts are prototypes/experimental devices, and are not yet approved or released for full production. Testing and final process, including without limitation quality assurance, reliability performance testing, and/or process qualification, may not yet be complete, and this item is subject to further changes or possible discontinuation. If available for ordering, purchases will be subject to an additional waiver at checkout, and are intended for early internal evaluation purposes only. These items are sold without warranties of any kind.

(3) **RoHS values:** Yes, No, RoHS Exempt. See the [TI RoHS Statement](#) for additional information and value definition.

(4) **Lead finish/Ball material:** Parts may have multiple material finish options. Finish options are separated by a vertical ruled line. Lead finish/Ball material values may wrap to two lines if the finish value exceeds the maximum column width.

(5) **MSL rating/Peak reflow:** The moisture sensitivity level ratings and peak solder (reflow) temperatures. In the event that a part has multiple moisture sensitivity ratings, only the lowest level per JEDEC standards is shown. Refer to the shipping label for the actual reflow temperature that will be used to mount the part to the printed circuit board.

(6) **Part marking:** There may be an additional marking, which relates to the logo, the lot trace code information, or the environmental category of the part.

Multiple part markings will be inside parentheses. Only one part marking contained in parentheses and separated by a "~" will appear on a part. If a line is indented then it is a continuation of the previous line and the two combined represent the entire part marking for that device.

**Important Information and Disclaimer:** The information provided on this page represents TI's knowledge and belief as of the date that it is provided. TI bases its knowledge and belief on information provided by third parties, and makes no representation or warranty as to the accuracy of such information. Efforts are underway to better integrate information from third parties. TI has taken and continues to take reasonable steps to provide representative and accurate information but may not have conducted destructive testing or chemical analysis on incoming materials and chemicals. TI and TI suppliers consider certain information to be proprietary, and thus CAS numbers and other limited information may not be available for release.

In no event shall TI's liability arising out of such information exceed the total purchase price of the TI part(s) at issue in this document sold by TI to Customer on an annual basis.

## GENERIC PACKAGE VIEW

**RTQ 56**

**VQFN - 1 mm max height**

8 x 8, 0.5 mm pitch

PLASTIC QUAD FLATPACK - NO LEAD

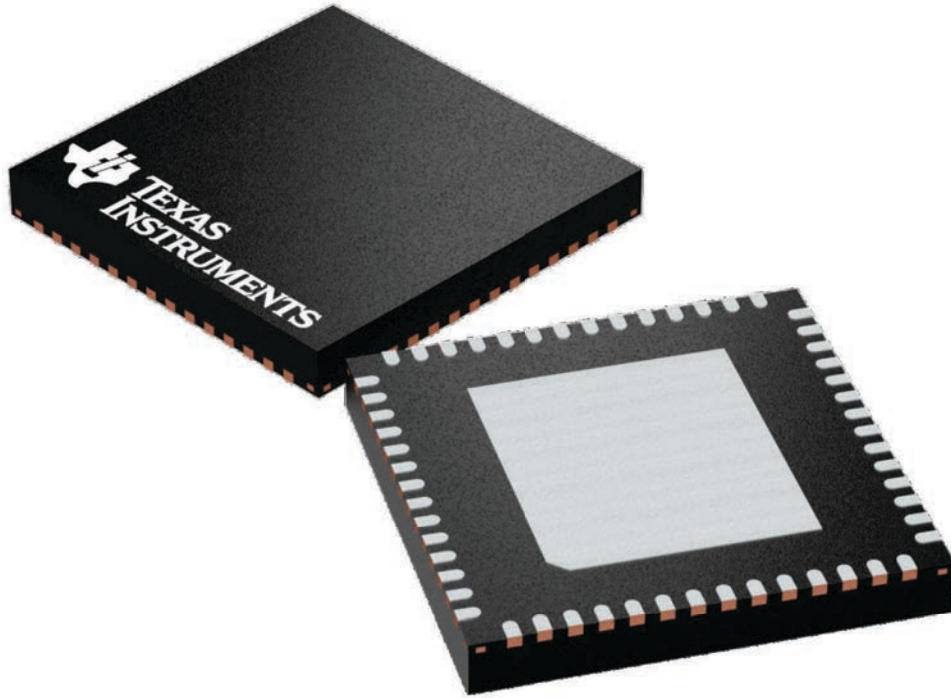

Images above are just a representation of the package family, actual package may vary.  
Refer to the product data sheet for package details.

4224653/A

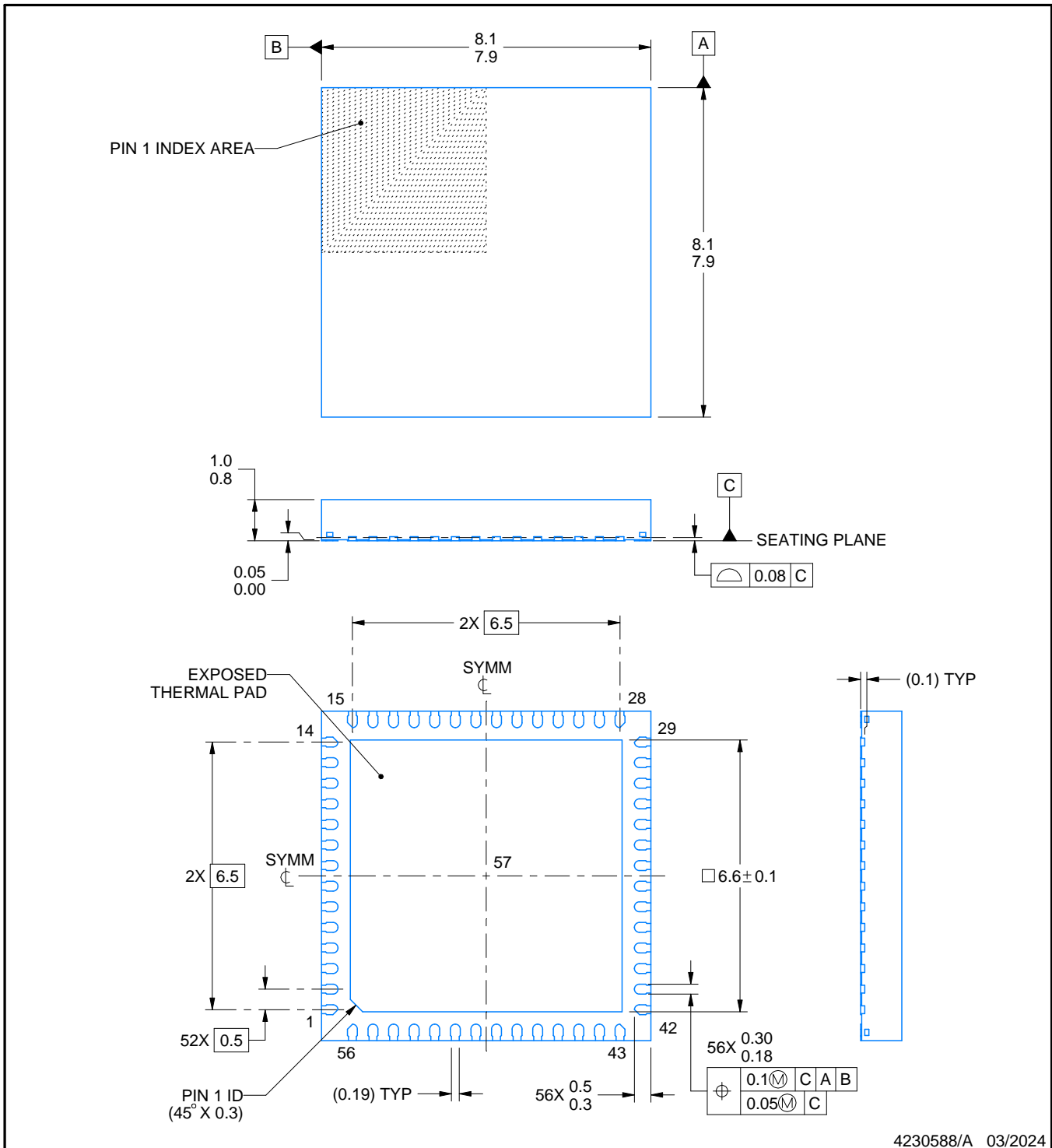
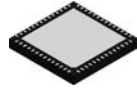

4230588/A 03/2024

NOTES:

1. All linear dimensions are in millimeters. Any dimensions in parenthesis are for reference only. Dimensioning and tolerancing per ASME Y14.5M.
2. This drawing is subject to change without notice.
3. The package thermal pad must be soldered to the printed circuit board for thermal and mechanical performance.

# EXAMPLE BOARD LAYOUT

RTQ0056L

VQFN - 1 mm max height

PLASTIC QUAD FLATPACK - NO LEAD

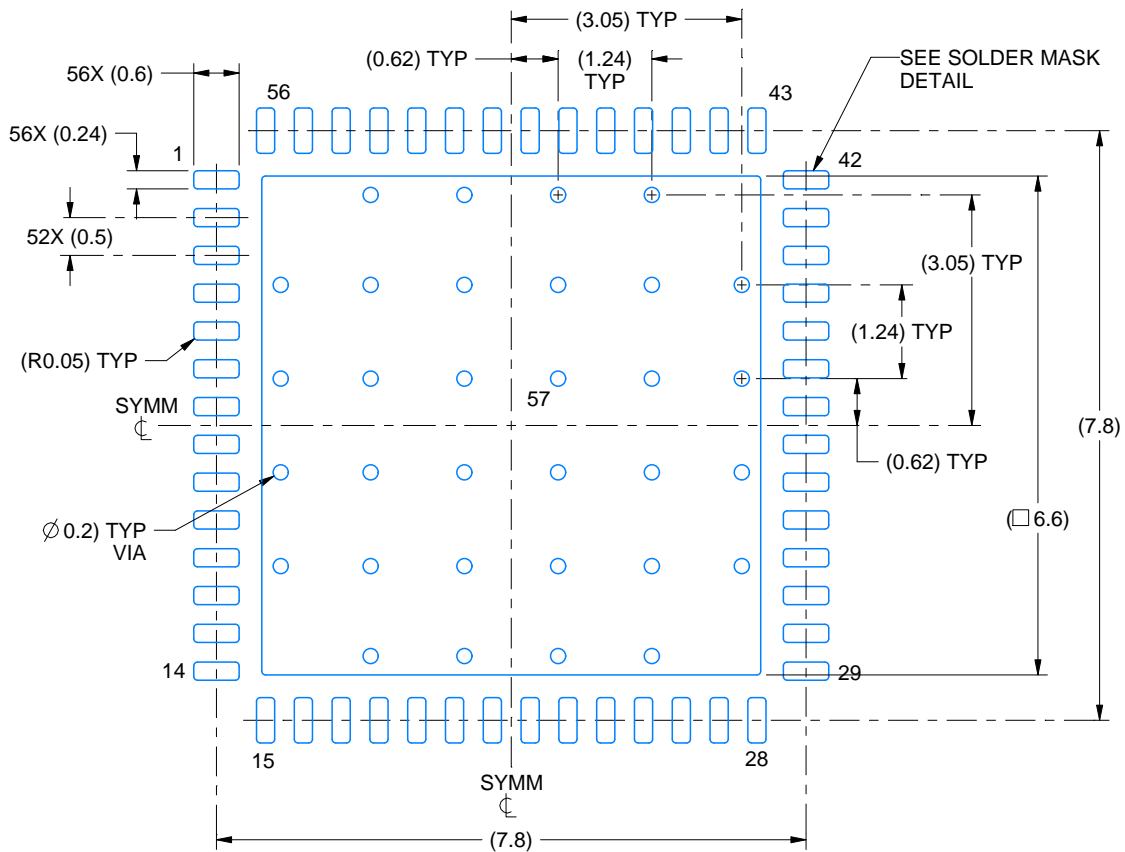

LAND PATTERN EXAMPLE  
EXPOSED METAL SHOWN  
SCALE: 10X

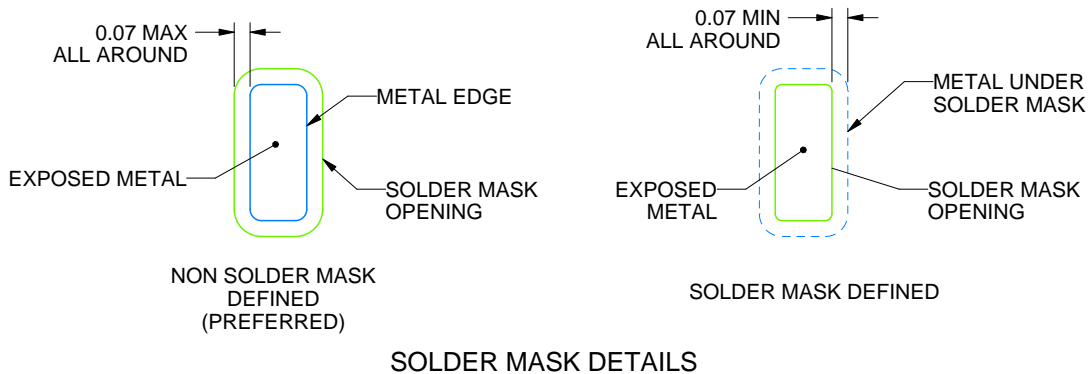

4230588/A 03/2024

NOTES: (continued)

- This package is designed to be soldered to a thermal pad on the board. For more information, see Texas Instruments literature number SLUA271 ([www.ti.com/lit/slua271](http://www.ti.com/lit/slua271)).
- Vias are optional depending on application, refer to device data sheet. If any vias are implemented, refer to their locations shown on this view. It is recommended that vias under paste be filled, plugged or tented.

# EXAMPLE STENCIL DESIGN

RTQ0056L

VQFN - 1 mm max height

PLASTIC QUAD FLATPACK - NO LEAD

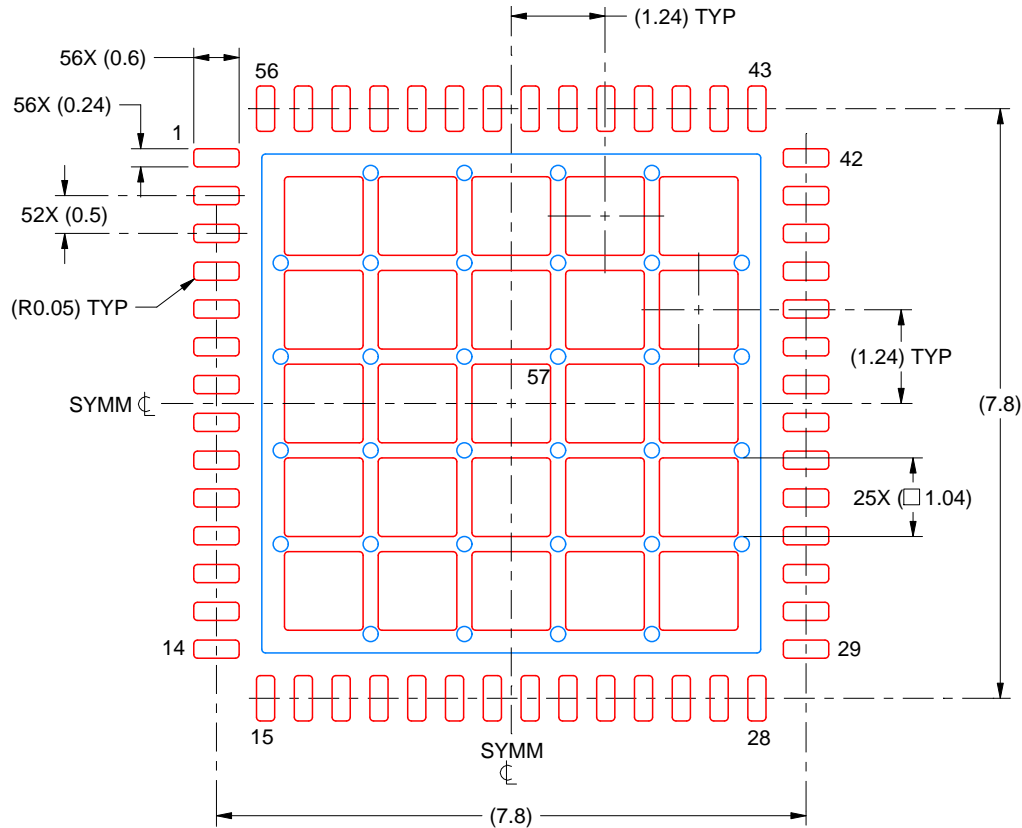

SOLDER PASTE EXAMPLE  
BASED ON 0.125 MM THICK STENCIL  
SCALE: 10X

EXPOSED PAD 57  
62% PRINTED SOLDER COVERAGE BY AREA UNDER PACKAGE

4230588/A 03/2024

NOTES: (continued)

6. Laser cutting apertures with trapezoidal walls and rounded corners may offer better paste release. IPC-7525 may have alternate design recommendations.

## 重要通知和免责声明

TI“按原样”提供技术和可靠性数据（包括数据表）、设计资源（包括参考设计）、应用或其他设计建议、网络工具、安全信息和其他资源，不保证没有瑕疵且不做任何明示或暗示的担保，包括但不限于对适销性、与某特定用途的适用性或不侵犯任何第三方知识产权的暗示担保。

这些资源可供使用 TI 产品进行设计的熟练开发人员使用。您将自行承担以下全部责任：(1) 针对您的应用选择合适的 TI 产品，(2) 设计、验证并测试您的应用，(3) 确保您的应用满足相应标准以及任何其他安全、安保法规或其他要求。

这些资源如有变更，恕不另行通知。TI 授权您仅可将这些资源用于研发本资源所述的 TI 产品的相关应用。严禁以其他方式对这些资源进行复制或展示。您无权使用任何其他 TI 知识产权或任何第三方知识产权。对于因您对这些资源的使用而对 TI 及其代表造成的任何索赔、损害、成本、损失和债务，您将全额赔偿，TI 对此概不负责。

TI 提供的产品受 [TI 销售条款](#)、[TI 通用质量指南](#) 或 [ti.com](#) 上其他适用条款或 TI 产品随附的其他适用条款的约束。TI 提供这些资源并不会扩展或以其他方式更改 TI 针对 TI 产品发布的适用的担保或担保免责声明。除非德州仪器 (TI) 明确将某产品指定为定制产品或客户特定产品，否则其产品均为按确定价格收入目录的标准通用器件。

TI 反对并拒绝您可能提出的任何其他或不同的条款。

版权所有 © 2026，德州仪器 (TI) 公司

最后更新日期：2025 年 10 月