

全差动隔离放大器

查询样品: [AMC1200-Q1](#)

特性

- 具有符合 **AEC-Q100** 的下列结果:
 - 器件温度 2 级: **-40°C 至 105°C** 的环境运行温度范围
 - 器件人体模型 (HBM) 静电放电 (ESD) 分类等级 **H2**
 - 器件充电器件模型 (CDM) ESD 分类等级 **C3B**
- 针对分流电阻器进行优化的 **±250mV** 输入电压范围
- 极低非线性: **5V** 时最大值为 **0.075%**
- 低偏移误差: 最大值 **1.5mV**
- 低噪声: 典型值 **3.1mV_{RMS}**
- 低高侧电源电流: **5V** 时最大值为 **8mA**
- 输入带宽: 最小值 **60kHz**
- 固定增益: **8** (精度 **0.5%**)
- 高共模抑制比: **108dB**
- **3.3V** 低侧工作电压
- 经认证的电流隔离:
 - 通过 **UL1577** 与 **IEC60747-5-2** 认证
 - 隔离电压: **4000V_{峰值}**
 - 工作电压: **1200V_{峰值}**
 - 瞬态抗扰度: 最小值 **10kV/μs**
- 在额定工作电压下使用寿命通常为 **10 年** (请参阅应用报告)
- 可在扩展工业温度范围内运行

应用范围

- 在下列应用中基于分流电阻器的电流感测:
 - 电机控制
 - 绿色环保能源
 - 变频器
 - 不间断电源

说明

AMC1200-Q1 是一款高精度隔离放大器, 此放大器的输出与输入电路由抗电磁干扰性能极强的二氧化硅 (SiO₂) 隔离层隔开。该隔离层经 UL1577 与 IEC60747-5-2 标准认证, 可提供高达 4000V_{峰值} 的电气隔离。当与隔离电源配合使用时, 该器件可防止共模高电压线路上的噪声电流进入本地接地并干扰或损坏敏感电路。

AMC1200-Q1 的输入针对直接连接至分流电阻器或其它低电压电平信号源进行了优化。该器件优异的性能支持准确的电流控制, 从而可实现系统级节电, 特别是在电机控制应用中, 可实现更低的转矩波纹。输出信号的共模电压可自动调节至 3V 或 5V 低侧电源。

AMC1200-Q1 经过全面认证, 适用于 -40 °C 至 105 °C 的扩展工业温度应用, 其采用表面贴装 (SMD) 型鸥翼 -8 封装。



Please be aware that an important notice concerning availability, standard warranty, and use in critical applications of Texas Instruments semiconductor products and disclaimers thereto appears at the end of this data sheet.

All trademarks are the property of their respective owners.

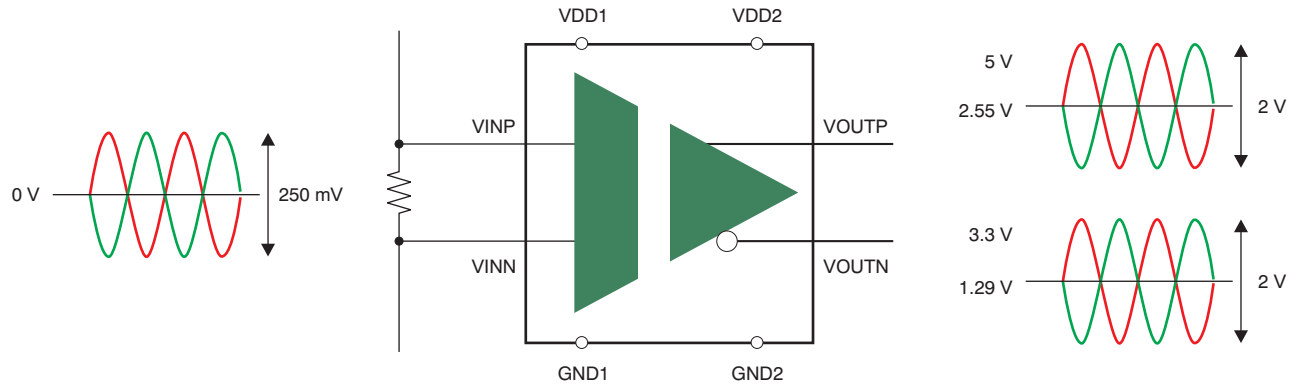



This integrated circuit can be damaged by ESD. Texas Instruments recommends that all integrated circuits be handled with appropriate precautions. Failure to observe proper handling and installation procedures can cause damage.

ESD damage can range from subtle performance degradation to complete device failure. Precision integrated circuits may be more susceptible to damage because very small parametric changes could cause the device not to meet its published specifications.

PACKAGE/ORDERING INFORMATION

For the most current package and ordering information see the Package Option Addendum at the end of this document, or visit the device product folder on www.ti.com.

ABSOLUTE MAXIMUM RATINGS⁽¹⁾

Over the operating ambient temperature range, unless otherwise noted.

		AMC1200-Q1	UNIT
Supply voltage, VDD1 to GND1 or VDD2 to GND2		-0.5 to 6	V
Analog input voltage at VINP, VINN		GND1 – 0.5 to VDD1 + 0.5	V
Input current to any pin except supply pins		±10	mA
Maximum junction temperature, T _J Max		150	°C
Electrostatic rating	Human-body model (HBM) AEC-Q100 Classification Level H2	2.5	kV
	Charged-device model (CDM) AEC-Q100 Classification Level C3B	1000	V

(1) Stresses beyond those listed under *Absolute Maximum Ratings* may cause permanent damage to the device. These are stress ratings only, and functional operation of the device at these or any other conditions beyond those indicated is not implied. Exposure to absolute-maximum-rated conditions for extended periods may affect device reliability.

THERMAL INFORMATION

THERMAL METRIC ⁽¹⁾		AMC1200-Q1	UNIT
		DUB (SOP)	
		8 PINS	
θ_{JA}	Junction-to-ambient thermal resistance	75.1	°C/W
θ_{JTop}	Junction-to-case (top) thermal resistance	61.6	°C/W
θ_{JB}	Junction-to-board thermal resistance	39.8	°C/W
ψ_{JT}	Junction-to-top characterization parameter	27.2	°C/W
ψ_{JB}	Junction-to-board characterization parameter	39.4	°C/W
θ_{JBot}	Junction-to-case (bottom) thermal resistance	N/A	°C/W

(1) 有关传统和新的热 度量的更多信息，请参阅 IC 封装热度量应用报告， [SPRA953](#)。

REGULATORY INFORMATION

VDE/IEC	UL
Certified according to IEC 60747-5-2	Recognized under 1577 component recognition program
File number: 40016131	File number: E181974

IEC 60747-5-2 INSULATION CHARACTERISTICS

Over operating free-air temperature range (unless otherwise noted).

PARAMETER	TEST CONDITIONS	VALUE	UNIT
V _{IORM} Maximum working insulation voltage		1200	V _{PEAK}
V _{PR} Input to output test voltage	Qualification test: after Input/Output Safety Test Subgroup 2/3 V _{PR} = V _{IORM} x 1.2, t = 10 s, partial discharge < 5 pC	1140	V _{PEAK}
	Qualification test: method a, after environmental tests subgroup 1, V _{PR} = V _{IORM} x 1.6, t = 10 s, partial discharge < 5 pC	1920	V _{PEAK}
	100% production test: method b1, V _{PR} = V _{IORM} x 1.875, t = 1 s, partial discharge < 5 pC	2250	V _{PEAK}
V _{IOTM} Transient overvoltage	Qualification test: t = 60 s	4000	V _{PEAK}
V _{ISO} Insulation voltage per UL	Qualification test: V _{TEST} = V _{ISO} , t = 60 s	4000	V _{PEAK}
	100% production test: V _{TEST} = 1.2 x V _{ISO} , t = 1 s	4800	V _{PEAK}
R _S Insulation resistance	V _{IO} = 500 V at T _S	> 10 ⁹	Ω
PD Pollution degree		2	°

IEC SAFETY LIMITING VALUES

Safety limiting intends to prevent potential damage to the isolation barrier upon failure of input or output (I/O) circuitry. A failure of the I/O circuitry can allow low resistance to ground or the supply and, without current limiting, dissipate sufficient power to overheat the die and damage the isolation barrier, potentially leading to secondary system failures. The safety-limiting constraint is the operating virtual junction temperature range specified in the [Absolute Maximum Ratings](#) table. The power dissipation and junction-to-air thermal impedance of the device installed in the application hardware determine the junction temperature. The assumed junction-to-air thermal resistance in the [Thermal Information](#) table is that of a device installed in the JESD51-3, *Low Effective Thermal Conductivity Test Board for Leaded Surface Mount Packages* and is conservative. The power is the recommended maximum input voltage times the current. The junction temperature is then the ambient temperature plus the power times the junction-to-air thermal resistance.

PARAMETER	TEST CONDITIONS	MIN	TYP	MAX	UNIT
I _S Safety input, output, or supply current	θ _{JA} = 246°C/W, V _{IN} = 5.5 V, T _J = 150°C, T _A = 25°C			10	mA
T _C Maximum case temperature				150	°C

IEC 61000-4-5 RATINGS

PARAMETER	TEST CONDITIONS	VALUE	UNIT
V _{IOSM} Surge immunity	1.2-µs/50-µs voltage surge and 8-µs/20-µs current surge	±6000	V

IEC 60664-1 RATINGS

PARAMETER	TEST CONDITIONS	SPECIFICATION
Basic isolation group	Material group	II
Installation classification	Rated mains voltage ≤ 150 V _{RMS}	I-IV
	Rated mains voltage ≤ 300 V _{RMS}	I-IV
	Rated mains voltage ≤ 400 V _{RMS}	I-III
	Rated mains voltage < 600 V _{RMS}	I-III

PACKAGE CHARACTERISTICS⁽¹⁾

PARAMETER		TEST CONDITIONS	MIN	TYP	MAX	UNIT
L(I01)	Minimum air gap (clearance)	Shortest terminal-to-terminal distance through air	7			mm
L(I02)	Minimum external tracking (creepage)	Shortest terminal-to-terminal distance across the package surface	7			mm
CTI	Tracking resistance (comparative tracking index)	DIN IEC 60112/VDE 0303 part 1	≥ 175			V
	Minimum internal gap (internal clearance)	Distance through the insulation	0.014			mm
R _{IO}	Isolation resistance	Input to output, V _{IO} = 500 V, all pins on each side of the barrier tied together to create a two-terminal device, T _A < 85°C		> 10 ¹²		Ω
		Input to output, V _{IO} = 500 V, 85°C ≤ T _A < T _A max		> 10 ¹¹		Ω
C _{IO}	Barrier capacitance input to output	V _I = 0.5 V _{PP} at 1 MHz		1.2		pF
C _I	Input capacitance to ground	V _I = 0.5 V _{PP} at 1 MHz		3		pF

- (1) Creepage and clearance requirements should be applied according to the specific equipment isolation standards of a specific application. Care should be taken to maintain the creepage and clearance distance of the board design to ensure that the mounting pads of the isolator on the printed circuit board (PCB) do not reduce this distance. Creepage and clearance on a PCB become equal according to the measurement techniques shown in the [Isolation Glossary](#) section. Techniques such as inserting grooves and/or ribs on the PCB are used to help increase these specifications.

ELECTRICAL CHARACTERISTICS

All minimum/maximum specifications at T_A = –40°C to 105°C and within the specified voltage range, unless otherwise noted. Typical values are at T_A = 25°C, VDD1 = 5 V, and VDD2 = 3.3 V.

PARAMETER	TEST CONDITIONS	AMC1200-Q1			UNIT	
		MIN	TYP	MAX		
INPUT						
	Maximum input voltage before clipping	V _{INP} – V _{INN}		±320	mV	
	Differential input voltage	V _{INP} – V _{INN}	–250		250	mV
V _{CM}	Common-mode operating range		–0.16		VDD1	V
V _{OS}	Input offset voltage		–1.5	±0.2	1.5	mV
TCV _{OS}	Input offset thermal drift		–10	±1.5	10	μV/K
CMRR	Common-mode rejection ratio	V _{IN} from 0 V to 5 V at 0 Hz		108		dB
		V _{IN} from 0 V to 5 V at 50 kHz		95		
C _{IN}	Input capacitance to GND1	V _{INP} or V _{INN}		3		pF
C _{IND}	Differential input capacitance			3.6		pF
R _{IN}	Differential input resistance			28		kΩ
	Small-signal bandwidth		60	100		kHz
OUTPUT						
	Nominal gain			8		
G _{ERR}	Gain error	Initial, at T _A = 25°C	–0.5%	±0.05%	0.5%	
			–1%	±0.05%	1%	
TCG _{ERR}	Gain error thermal drift			±56		ppm/K
	Nonlinearity	4.5 V ≤ VDD2 ≤ 5.5 V	–0.075%	±0.015%	0.075%	
		2.7 V ≤ VDD2 ≤ 3.6 V	–0.1%	±0.023%	0.1%	
	Nonlinearity thermal drift			2.4		ppm/K
	Output noise	V _{INP} = V _{INN} = 0 V		3.1		mV _{RMS}
PSRR	Power-supply rejection ratio	vs VDD1, 10-kHz ripple		80		dB
		vs VDD2, 10-kHz ripple		61		
	Rise/fall time	0.5-V step, 10% to 90%		3.66	6.6	μs

ELECTRICAL CHARACTERISTICS (continued)

All minimum/maximum specifications at $T_A = -40^{\circ}\text{C}$ to 105°C and within the specified voltage range, unless otherwise noted. Typical values are at $T_A = 25^{\circ}\text{C}$, $V_{DD1} = 5\text{ V}$, and $V_{DD2} = 3.3\text{ V}$.

PARAMETER	TEST CONDITIONS	AMC1200-Q1			UNIT
		MIN	TYP	MAX	
V_{IN} to V_{OUT} signal delay	0.5-V step, 50% to 10%, unfiltered output		1.6	3.3	μs
	0.5-V step, 50% to 50%, unfiltered output		3.15	5.6	
	0.5-V step, 50% to 90%, unfiltered output		5.26	9.9	
CMTI Common-mode transient immunity	$V_{CM} = 1\text{ kV}$ (T_A at 25°C)	8	15		$\text{kV}/\mu\text{s}$
Output common-mode voltage	$2.7\text{ V} \leq V_{DD2} \leq 3.6\text{ V}$	1.15	1.29	1.45	V
	$4.5\text{ V} \leq V_{DD2} \leq 5.5\text{ V}$	2.4	2.55	2.7	
Short-circuit current			20		mA
R_{OUT} Output resistance			2.5		Ω
POWER SUPPLY					
VDD1 High-side supply voltage		4.5	5	5.5	V
VDD2 Low-side supply voltage		2.7	5	5.5	V
I_{DD1} High-side supply current			5.4	8	mA
I_{DD2} Low-side supply current	$2.7\text{ V} < V_{DD2} < 3.6\text{ V}$		3.8	6	mA
	$4.5\text{ V} < V_{DD2} < 5.5\text{ V}$		4.4	7	
P_{DD1} High-side power dissipation			27	44	mW
P_{DD2} Low-side power dissipation	$2.7\text{ V} < V_{DD2} < 3.6\text{ V}$		11.4	21.6	mW
	$4.5\text{ V} < V_{DD2} < 5.5\text{ V}$		22	38.5	

PIN CONFIGURATION

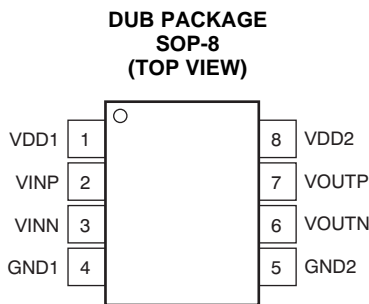

PIN DESCRIPTIONS

PIN #	PIN NAME	FUNCTION	DESCRIPTION
1	VDD1	Power	High-side power supply
2	VINP	Analog input	Noninverting analog input
3	VINN	Analog input	Inverting analog input
4	GND1	Power	High-side analog ground
5	GND2	Power	Low-side analog ground
6	VOUTN	Analog output	Inverting analog output
7	VOUTP	Analog output	Noninverting analog output
8	VDD2	Power	Low-side power supply

TYPICAL CHARACTERISTICS

At VDD1 = VDD2 = 5 V, VINP = -250 mV to 250 mV, and VINN = 0 V, unless otherwise noted.

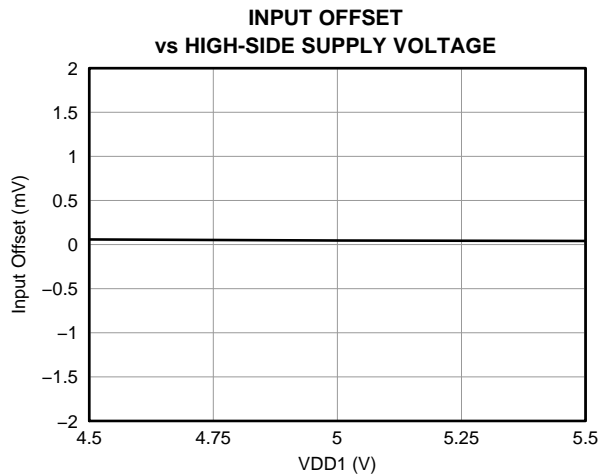

Figure 1.

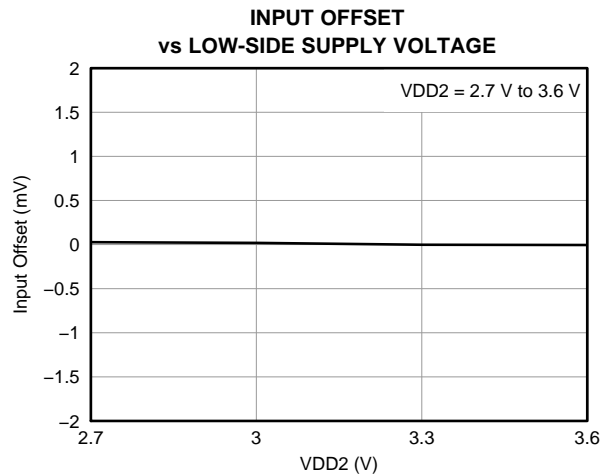

Figure 2.

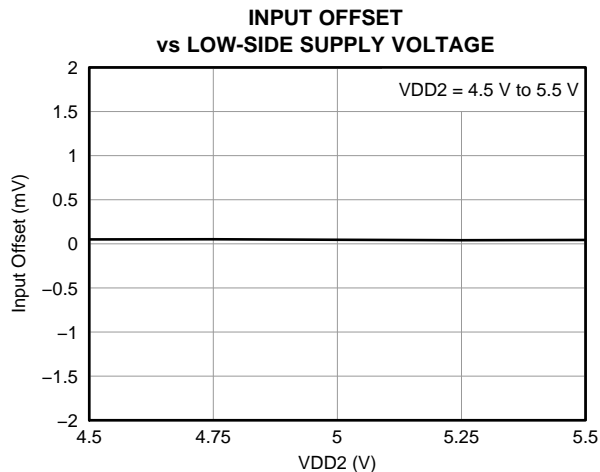

Figure 3.

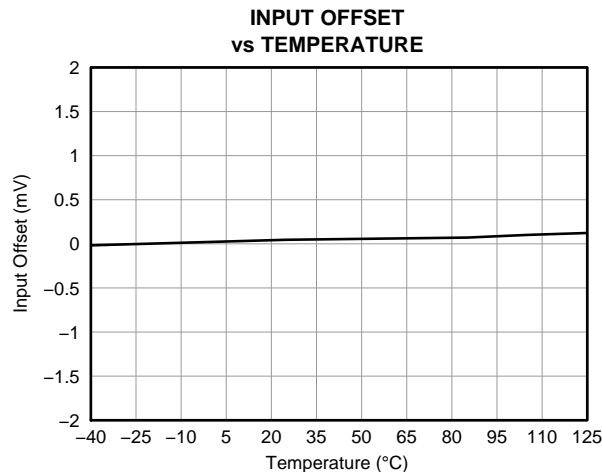

Figure 4.

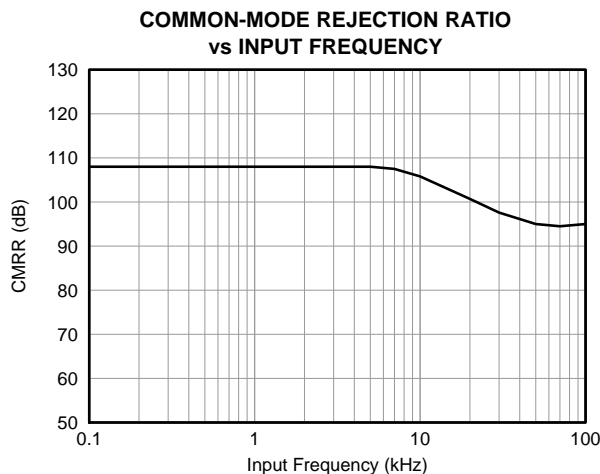

Figure 5.

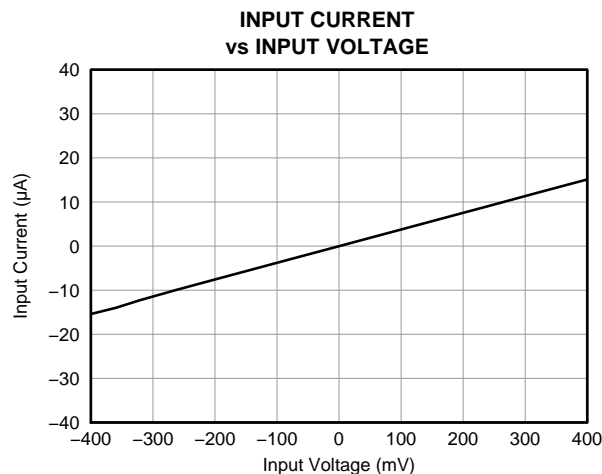

Figure 6.

TYPICAL CHARACTERISTICS (continued)

At VDD1 = VDD2 = 5 V, VINP = -250 mV to 250 mV, and VINN = 0 V, unless otherwise noted.

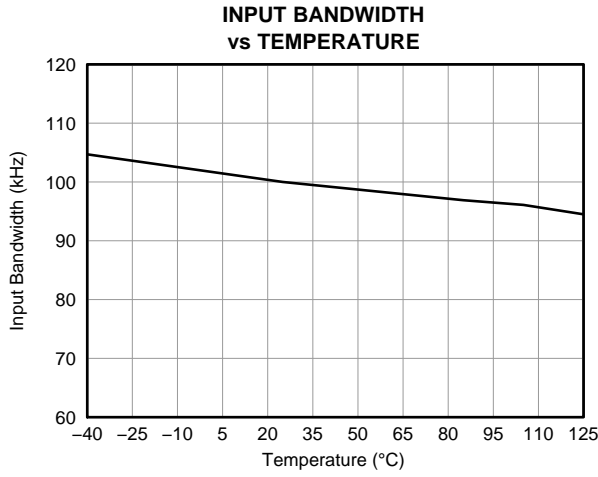

Figure 7.

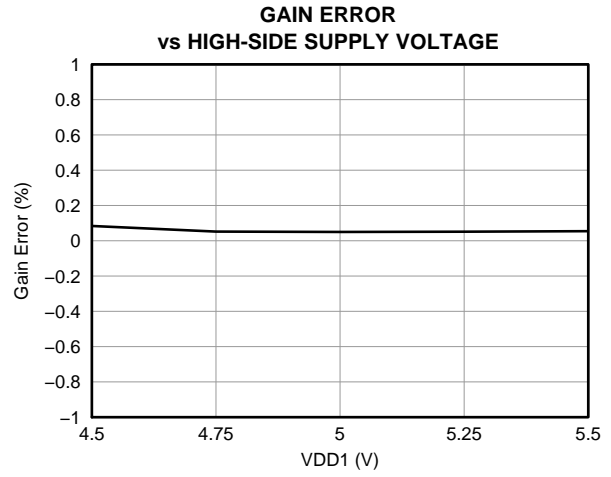

Figure 8.

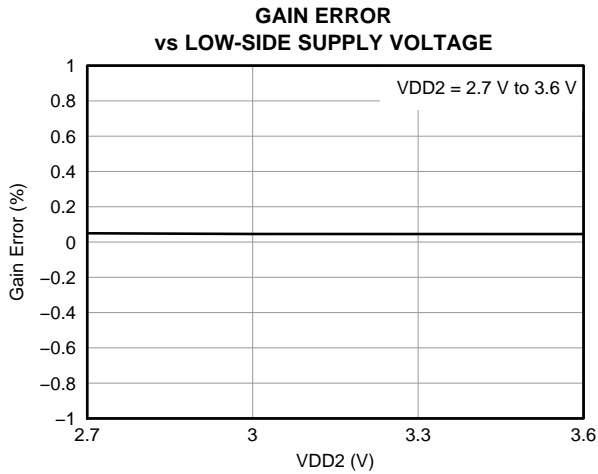

Figure 9.

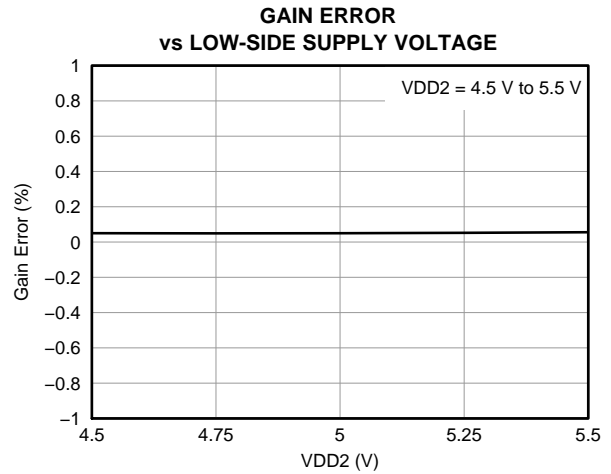

Figure 10.

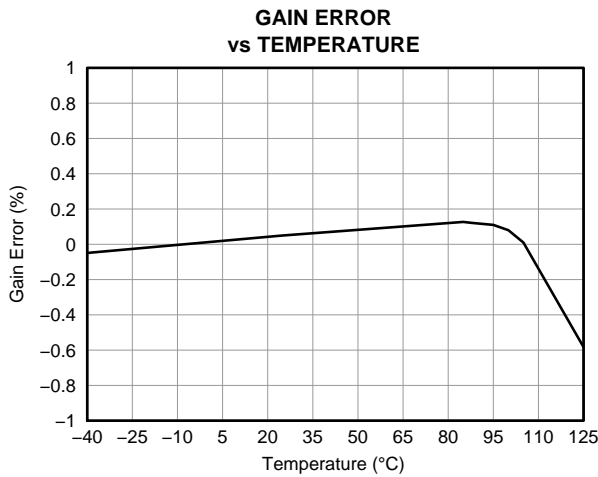

Figure 11.

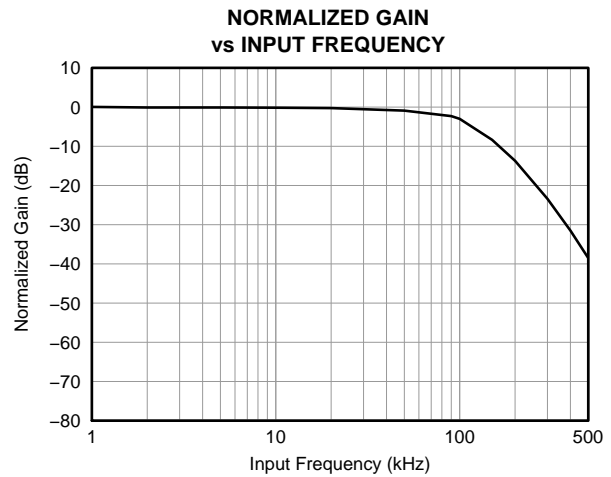

Figure 12.

TYPICAL CHARACTERISTICS (continued)

At VDD1 = VDD2 = 5 V, VINP = -250 mV to 250 mV, and VINN = 0 V, unless otherwise noted.

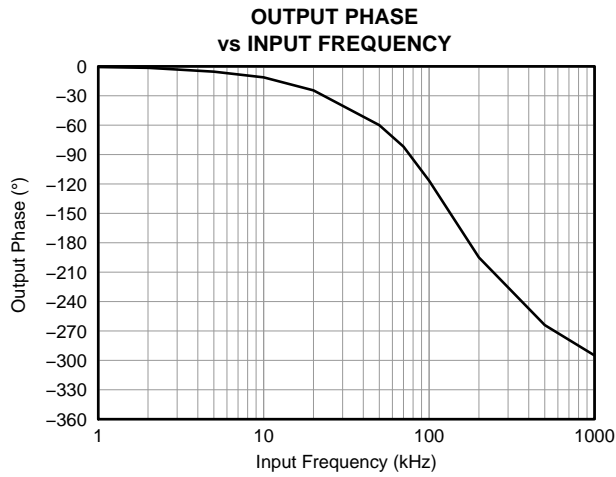

Figure 13.

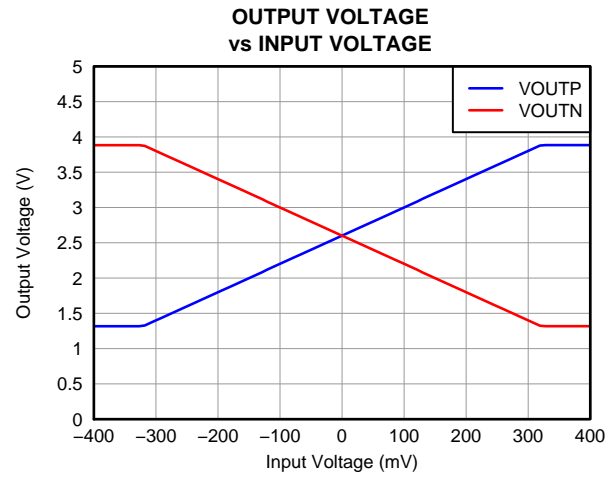

Figure 14.

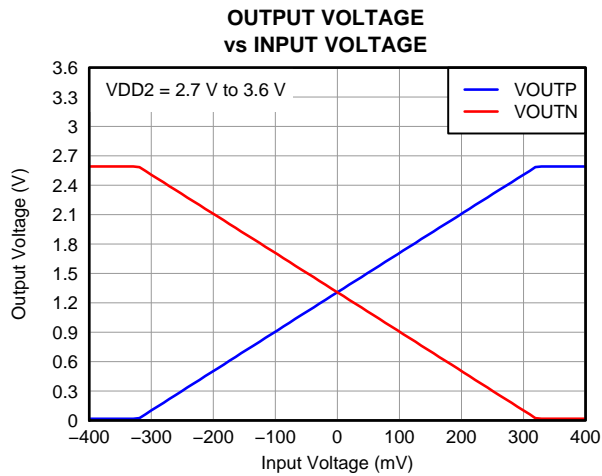

Figure 15.

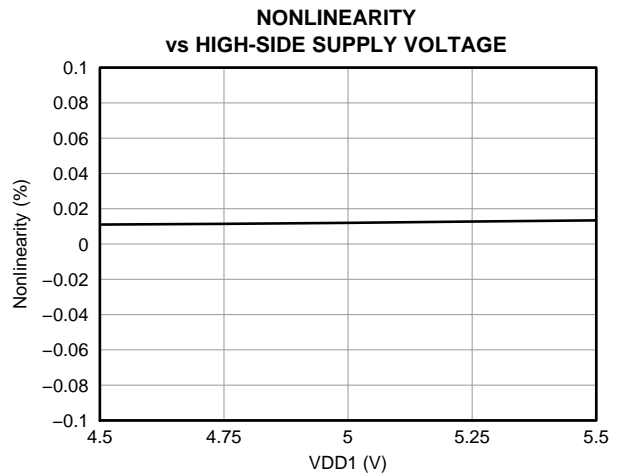

Figure 16.

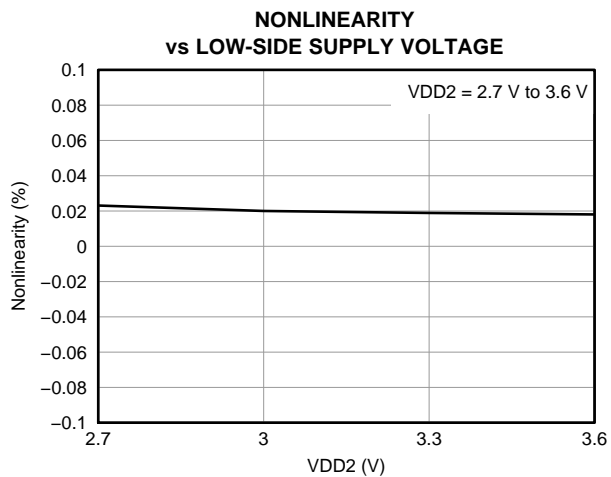

Figure 17.

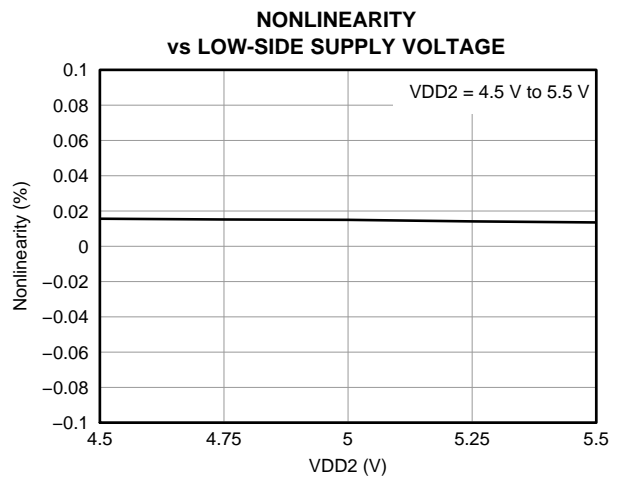

Figure 18.

TYPICAL CHARACTERISTICS (continued)

At VDD1 = VDD2 = 5 V, VINP = -250 mV to 250 mV, and VINN = 0 V, unless otherwise noted.

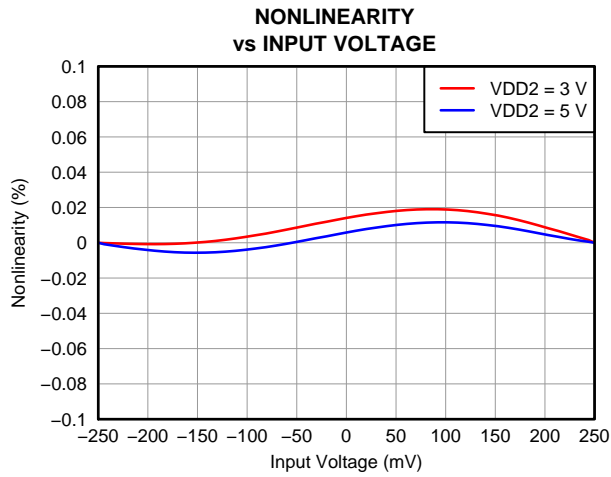

Figure 19.

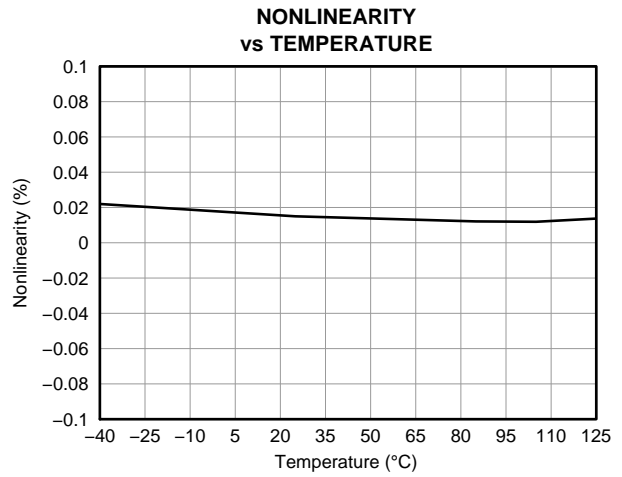

Figure 20.

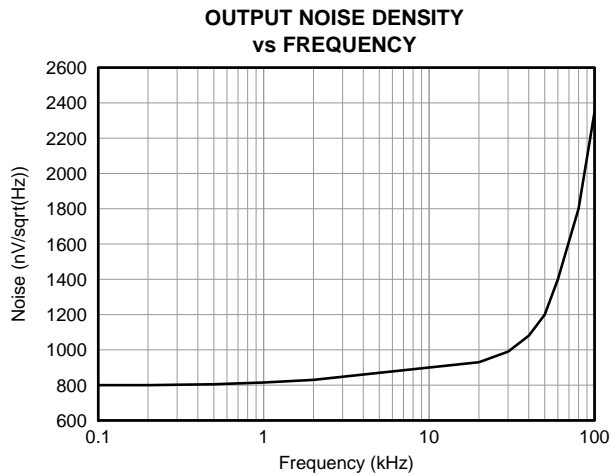

Figure 21.

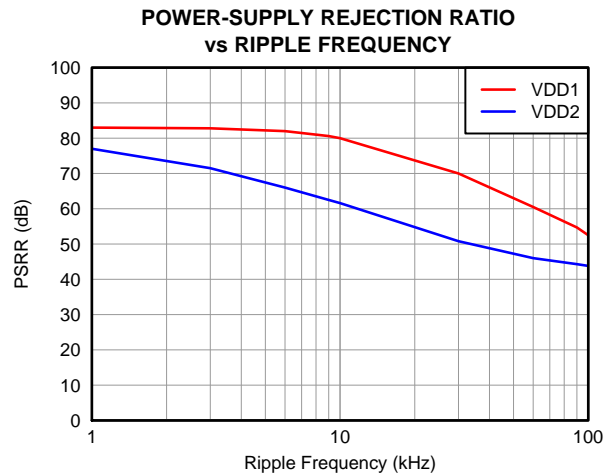

Figure 22.

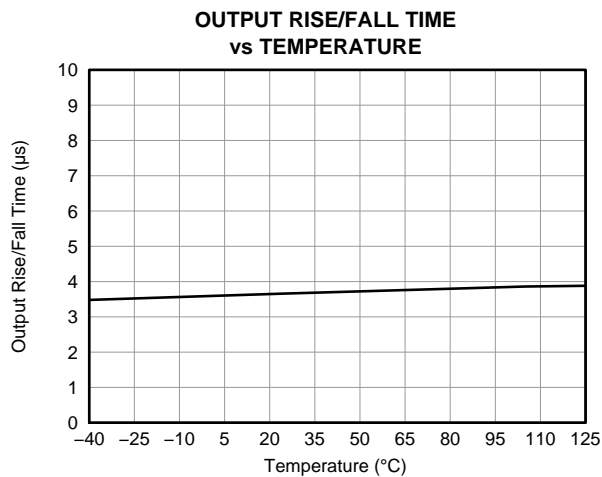

Figure 23.

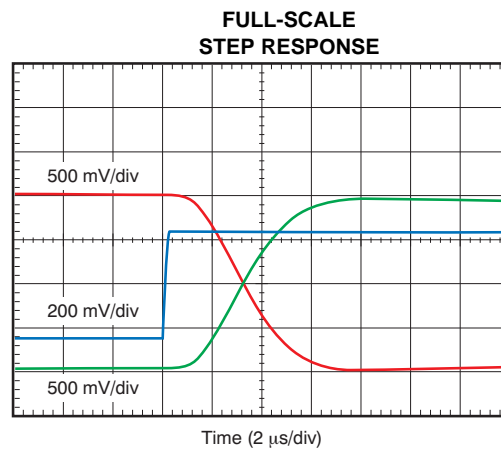

Figure 24.

TYPICAL CHARACTERISTICS (continued)

At VDD1 = VDD2 = 5 V, VINP = -250 mV to 250 mV, and VINN = 0 V, unless otherwise noted.

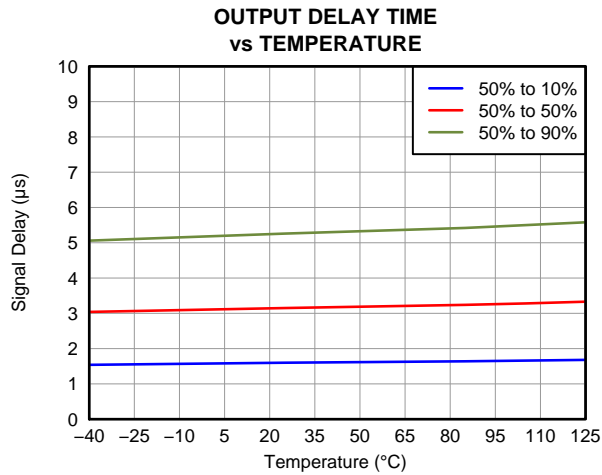

Figure 25.

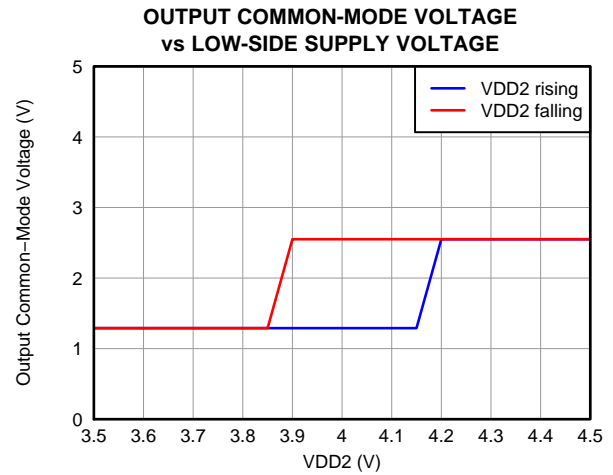

Figure 26.

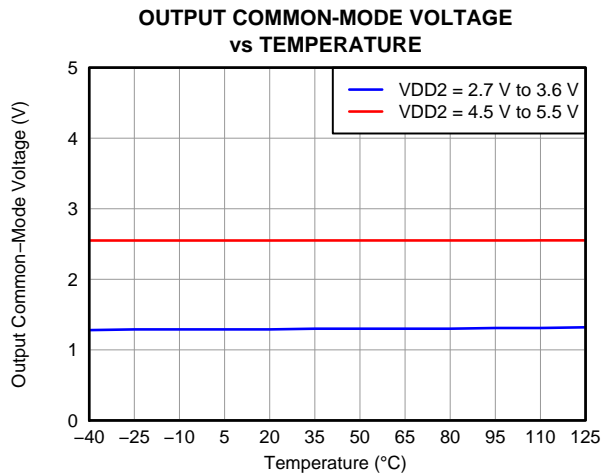

Figure 27.

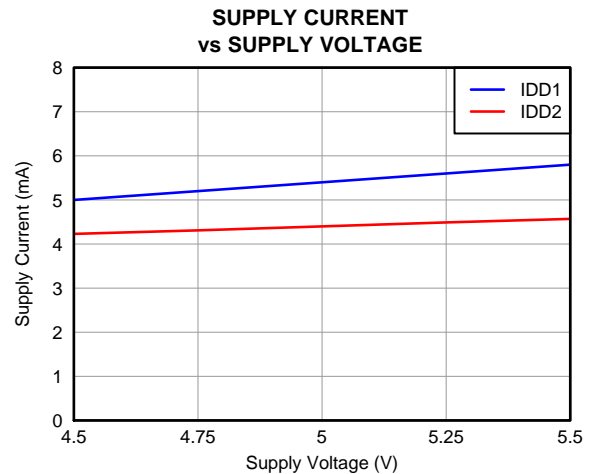

Figure 28.

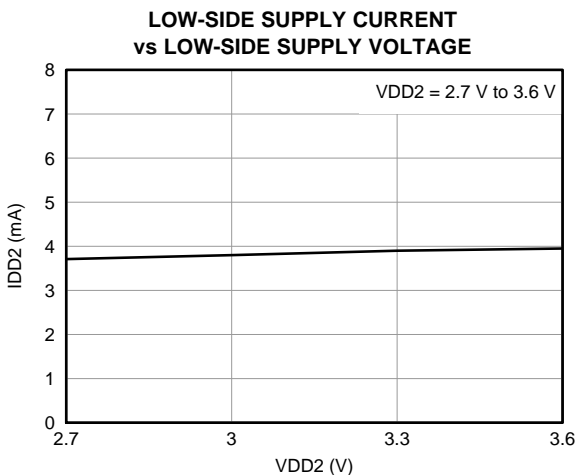

Figure 29.

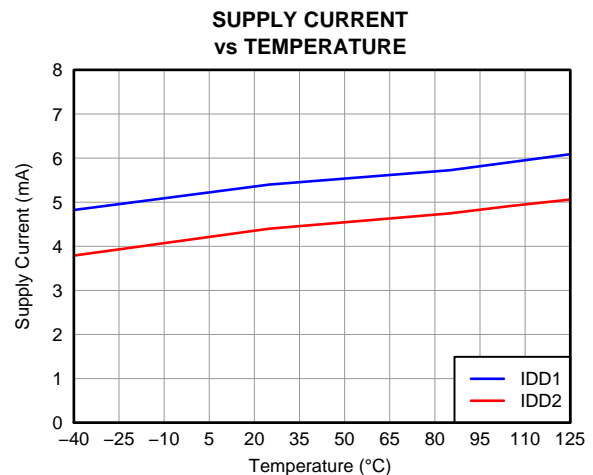

Figure 30.

THEORY OF OPERATION

INTRODUCTION

The differential analog input of the AMC1200-Q1 is a switched-capacitor circuit based on a second-order modulator stage that digitizes the input signal into a 1-bit output stream. The device compares the differential input signal ($V_{IN} = V_{INP} - V_{INN}$) against the internal reference of 2.5 V using internal capacitors that are continuously charged and discharged with a typical frequency of 10 MHz. With the S1 switches closed, C_{IND} charges to the voltage difference across V_{INP} and V_{INN} . For the discharge phase, both S1 switches open first and then both S2 switches close. C_{IND} discharges to approximately $AGND + 0.8 V$ during this phase. Figure 31 shows the simplified equivalent input circuitry.

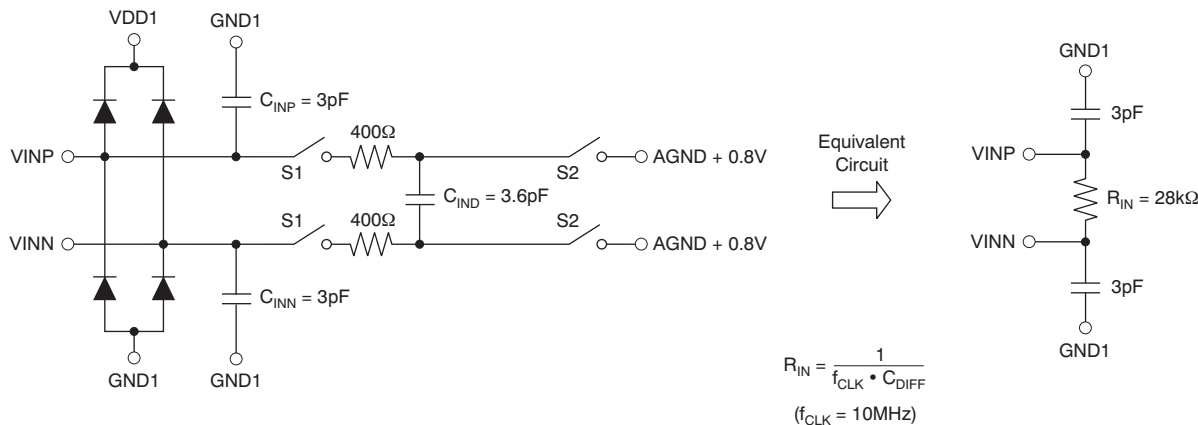

Figure 31. Equivalent Input Circuit

The analog input range is tailored to accommodate directly a voltage drop across a shunt resistor used for current sensing. However, there are two restrictions on the analog input signals, V_{INP} and V_{INN} . If the input voltage exceeds the range $AGND - 0.5 V$ to $AVDD + 0.5 V$, the input current must be limited to 10 mA to protect the implemented input protection diodes from damage. In addition, the linearity and the noise performance of the device meet specifications only when the differential analog input voltage remains within $\pm 250 mV$.

The isolated digital bit stream is processed by a third-order analog filter on the low side and presented as a differential output of the device.

The SiO_2 -based capacitive isolation barrier supports a high level of magnetic field immunity, as described in application report [SLLA181](#), *ISO72x Digital Isolator Magnetic-Field Immunity* (available for download at www.ti.com).

APPLICATION INFORMATION

MOTOR CONTROL

A typical operation of the AMC1200-Q1 in a motor-control application is shown in [Figure 32](#). Measurement of the motor phase current is done through the shunt resistor, R_{SHUNT} (in this case, a two-terminal shunt). For better performance, the differential signal is filtered using RC filters (components R_2 , R_3 , and C_2). Optionally, C_3 and C_4 can be used to reduce charge dumping from the inputs. In this case, care should be taken when choosing the quality of these capacitors; mismatch in values of these capacitors leads to a common-mode error at the input of the modulator.

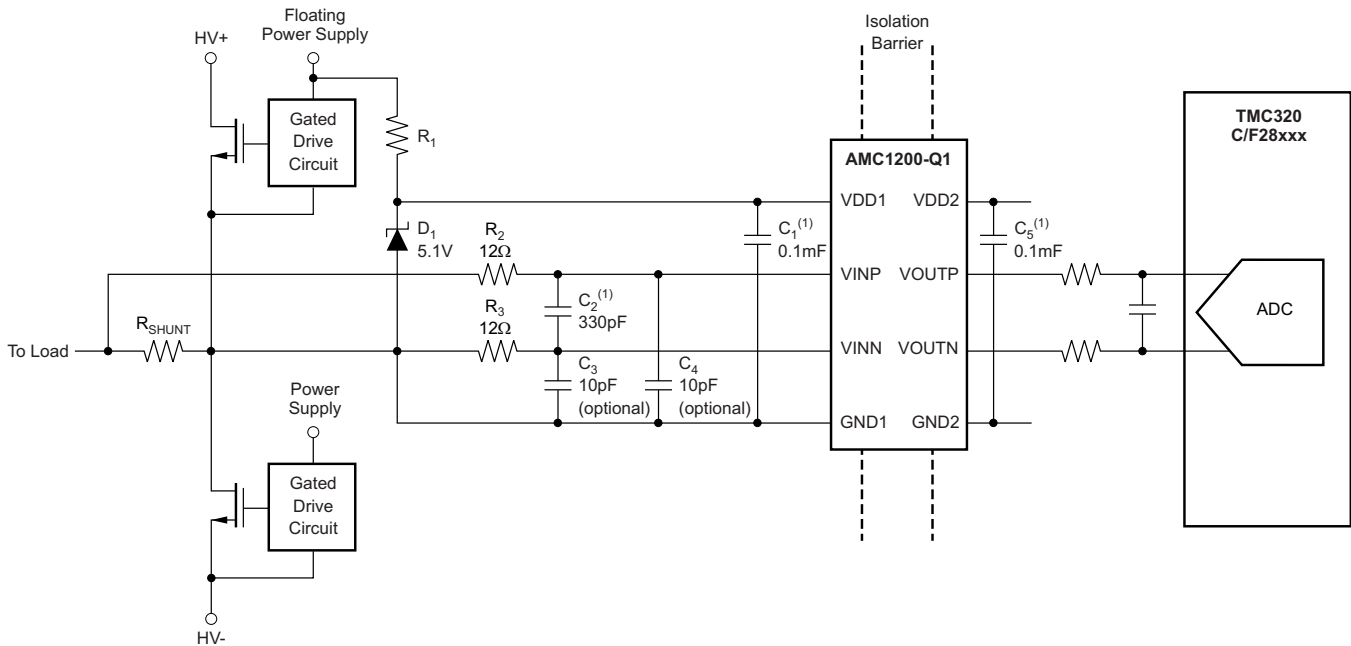

(1) Place these capacitors as close as possible to the AMC1200-Q1.

Figure 32. Typical Application Diagram for the AMC1200-Q1

The high-side power supply for the AMC1200-Q1 (VDD1) is derived from the power supply of the upper gate driver. For lowest cost, a Zener diode can be used to limit the voltage to $5\text{ V} \pm 10\%$. A decoupling capacitor of $0.1\ \mu\text{F}$ is recommended for filtering this power-supply path. This capacitor (C_1 in [Figure 32](#)) should be placed as close as possible to the VDD1 pin for best performance. If better filtering is required, an additional $1\text{-}\mu\text{F}$ to $10\text{-}\mu\text{F}$ capacitor can be used. The floating ground reference (GND1) is derived from the end of the shunt resistor that is connected to the negative input of the AMC1200-Q1 (VINN). If a four-terminal shunt is used, the inputs of AMC1200-Q1 are connected to the inner leads, whereas GND1 is connected to one of the outer leads of the shunt.

The high transient immunity of the AMC1200-Q1 ensures reliable and accurate operation even in high-noise environments such as the power stages of the motor drives.

The differential output of the AMC1200-Q1 can either directly drive an analog-to-digital converter (ADC) input or can be further filtered before being processed by the ADC.

As shown in [Figure 33](#), it is recommended to place the bypass and filter capacitors as close as possible to the AMC1200-Q1 to ensure best performance.

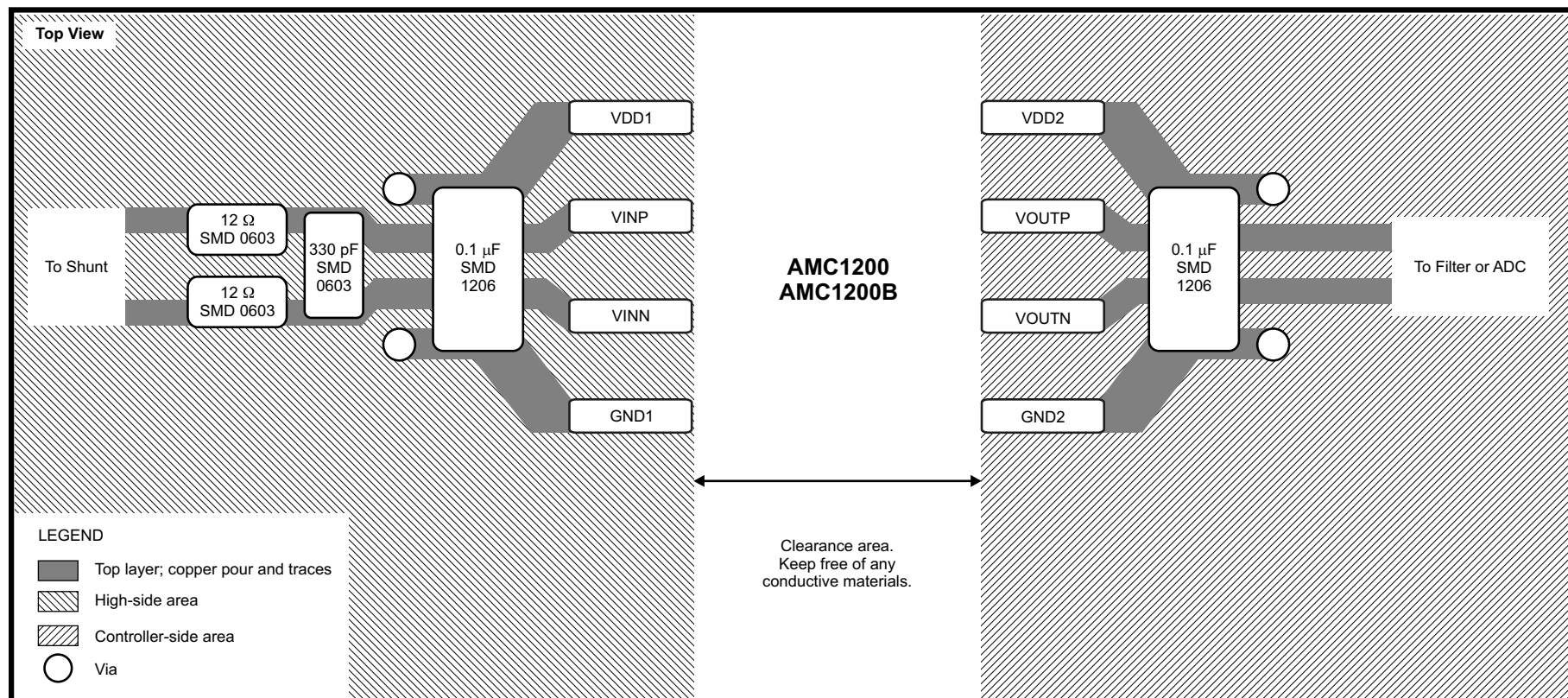

Figure 33. AMC1200-Q1 Layout Recommendation

To maintain the isolation barrier and the high CMTI of the device, the distance between the high-side ground (GND1) and the low-side ground (GND2) should be kept at maximum; that is, the entire area underneath the device should be kept free of any conducting materials.

VOLTAGE MEASUREMENT

The AMC1200-Q1 can also be used for isolated voltage measurement applications, as shown in a simplified way in Figure 34. In such applications, usually a resistor divider (R_1 and R_2 in Figure 34) is used to match the relatively small input voltage range of the AMC1200-Q1. R_2 and the input resistance R_{IN} of the AMC1200-Q1 also create a resistance divider that results in additional gain error. With the assumption that R_1 and R_{IN} have a considerably higher value than R_2 , the resulting total gain error can be estimated using Equation 1:

$$G_{ERRTOT} = G_{ERR} + \frac{R_2}{R_{IN}}$$

Where G_{ERR} = the gain error of the AMC1200-Q1.

(1)

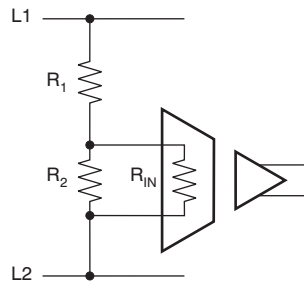
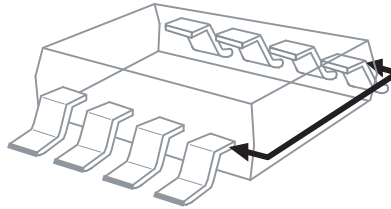

Figure 34. Voltage Measurement Application

ISOLATION GLOSSARY

Creepage Distance: The shortest path between two conductive input to output leads measured along the surface of the insulation. The shortest distance path is found around the end of the package body.



Clearance: The shortest distance between two conductive input to output leads measured through air (line of sight).

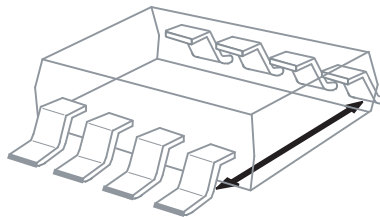

Input-to-Output Barrier Capacitance: The total capacitance between all input terminals connected together, and all output terminals connected together.

Input-to-Output Barrier Resistance: The total resistance between all input terminals connected together, and all output terminals connected together.

Primary Circuit: An internal circuit directly connected to an external supply main or other equivalent source that supplies the primary-circuit electric power.

Secondary Circuit: A circuit with no direct connection to primary power that derives its power from a separate isolated source.

Comparative Tracking Index (CTI): CTI is an index used for electrical insulating materials. It is defined as the numerical value of the voltage that causes failure by tracking during standard testing. Tracking is the process that produces a partially conducting path of localized deterioration on or through the surface of an insulating material as a result of the action of electric discharges on or close to an insulation surface. The higher CTI value of the insulating material, the smaller the minimum creepage distance.

Generally, insulation breakdown occurs either through the material, over its surface, or both. Surface failure may arise from flashover or from the progressive degradation of the insulation surface by small localized sparks. Such sparks are the result of the breaking of a surface film of conducting contaminant on the insulation. The resulting break in the leakage current produces an overvoltage at the site of the discontinuity, and an electric spark is generated. These sparks often cause carbonization on insulation material and lead to a carbon track between points of different potential. This process is known as tracking.

Insulation:

Operational insulation—Insulation needed for the correct operation of the equipment.

Basic insulation—Insulation to provide basic protection against electric shock.

Supplementary insulation—Independent insulation applied in addition to basic insulation in order to ensure protection against electric shock in the event of a failure of the basic insulation.

Double insulation—Insulation comprising both basic and supplementary insulation.

Reinforced insulation—A single insulation system that provides a degree of protection against electric shock equivalent to double insulation.

Pollution Degree:

Pollution Degree 1—No pollution, or only dry, nonconductive pollution occurs. The pollution has no influence on device performance.

Pollution Degree 2—Normally, only nonconductive pollution occurs. However, a temporary conductivity caused by condensation is to be expected.

Pollution Degree 3—Conductive pollution, or dry nonconductive pollution that becomes conductive because of condensation, occurs. Condensation is to be expected.

Pollution Degree 4—Continuous conductivity occurs as a result of conductive dust, rain, or other wet conditions.

Installation Category:

Overvoltage Category—This section is directed at insulation coordination by identifying the transient overvoltages that may occur, and by assigning four different levels as indicated in IEC 60664.

1. Signal Level: Special equipment or parts of equipment.
2. Local Level: Portable equipment, etc.
3. Distribution Level: Fixed installation.
4. Primary Supply Level: Overhead lines, cable systems.

Each category should be subject to smaller transients than the previous category.

PACKAGING INFORMATION

Orderable part number	Status (1)	Material type (2)	Package Pins	Package qty Carrier	RoHS (3)	Lead finish/ Ball material (4)	MSL rating/ Peak reflow (5)	Op temp (°C)	Part marking (6)
AMC1200STDUBRQ1	Active	Production	SOP (DUB) 8	350 LARGE T&R	Yes	NIPDAU	Level-3-260C-168 HR	-40 to 105	1200Q
AMC1200STDUBRQ1.A	Active	Production	SOP (DUB) 8	350 LARGE T&R	Yes	NIPDAU	Level-3-260C-168 HR	-40 to 105	1200Q
AMC1200STDUBRQ1.B	Active	Production	SOP (DUB) 8	350 LARGE T&R	-	Call TI	Call TI	-40 to 105	
AMC1200TDWVRQ1	Active	Production	SOIC (DWV) 8	1000 LARGE T&R	Yes	NIPDAU	Level-2-260C-1 YEAR	-40 to 105	1200Q
AMC1200TDWVRQ1.A	Active	Production	SOIC (DWV) 8	1000 LARGE T&R	Yes	NIPDAU	Level-2-260C-1 YEAR	-40 to 105	1200Q
AMC1200TDWVRQ1.B	Active	Production	SOIC (DWV) 8	1000 LARGE T&R	-	Call TI	Call TI	-40 to 105	

(1) **Status:** For more details on status, see our [product life cycle](#).

(2) **Material type:** When designated, preproduction parts are prototypes/experimental devices, and are not yet approved or released for full production. Testing and final process, including without limitation quality assurance, reliability performance testing, and/or process qualification, may not yet be complete, and this item is subject to further changes or possible discontinuation. If available for ordering, purchases will be subject to an additional waiver at checkout, and are intended for early internal evaluation purposes only. These items are sold without warranties of any kind.

(3) **RoHS values:** Yes, No, RoHS Exempt. See the [TI RoHS Statement](#) for additional information and value definition.

(4) **Lead finish/Ball material:** Parts may have multiple material finish options. Finish options are separated by a vertical ruled line. Lead finish/Ball material values may wrap to two lines if the finish value exceeds the maximum column width.

(5) **MSL rating/Peak reflow:** The moisture sensitivity level ratings and peak solder (reflow) temperatures. In the event that a part has multiple moisture sensitivity ratings, only the lowest level per JEDEC standards is shown. Refer to the shipping label for the actual reflow temperature that will be used to mount the part to the printed circuit board.

(6) **Part marking:** There may be an additional marking, which relates to the logo, the lot trace code information, or the environmental category of the part.

Multiple part markings will be inside parentheses. Only one part marking contained in parentheses and separated by a "~" will appear on a part. If a line is indented then it is a continuation of the previous line and the two combined represent the entire part marking for that device.

Important Information and Disclaimer: The information provided on this page represents TI's knowledge and belief as of the date that it is provided. TI bases its knowledge and belief on information provided by third parties, and makes no representation or warranty as to the accuracy of such information. Efforts are underway to better integrate information from third parties. TI has taken and continues to take reasonable steps to provide representative and accurate information but may not have conducted destructive testing or chemical analysis on incoming materials and chemicals. TI and TI suppliers consider certain information to be proprietary, and thus CAS numbers and other limited information may not be available for release.

In no event shall TI's liability arising out of such information exceed the total purchase price of the TI part(s) at issue in this document sold by TI to Customer on an annual basis.

OTHER QUALIFIED VERSIONS OF AMC1200-Q1 :

- Catalog : [AMC1200](#)

NOTE: Qualified Version Definitions:

- Catalog - TI's standard catalog product

GENERIC PACKAGE VIEW

DUB 8

SOP - 4.85 mm max height

SMALL OUTLINE PACKAGE

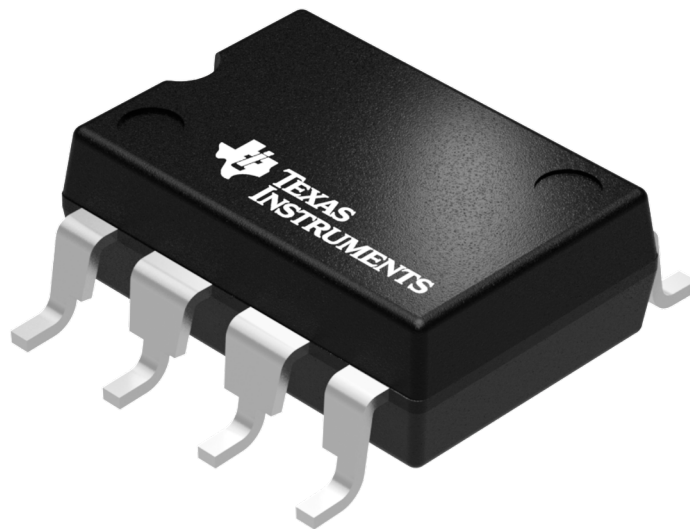

Images above are just a representation of the package family, actual package may vary.
Refer to the product data sheet for package details.

4207614/E

DUB0008A

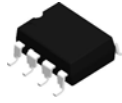

PACKAGE OUTLINE

SOP - 4.85 mm max height

SMALL OUTLINE PACKAGE

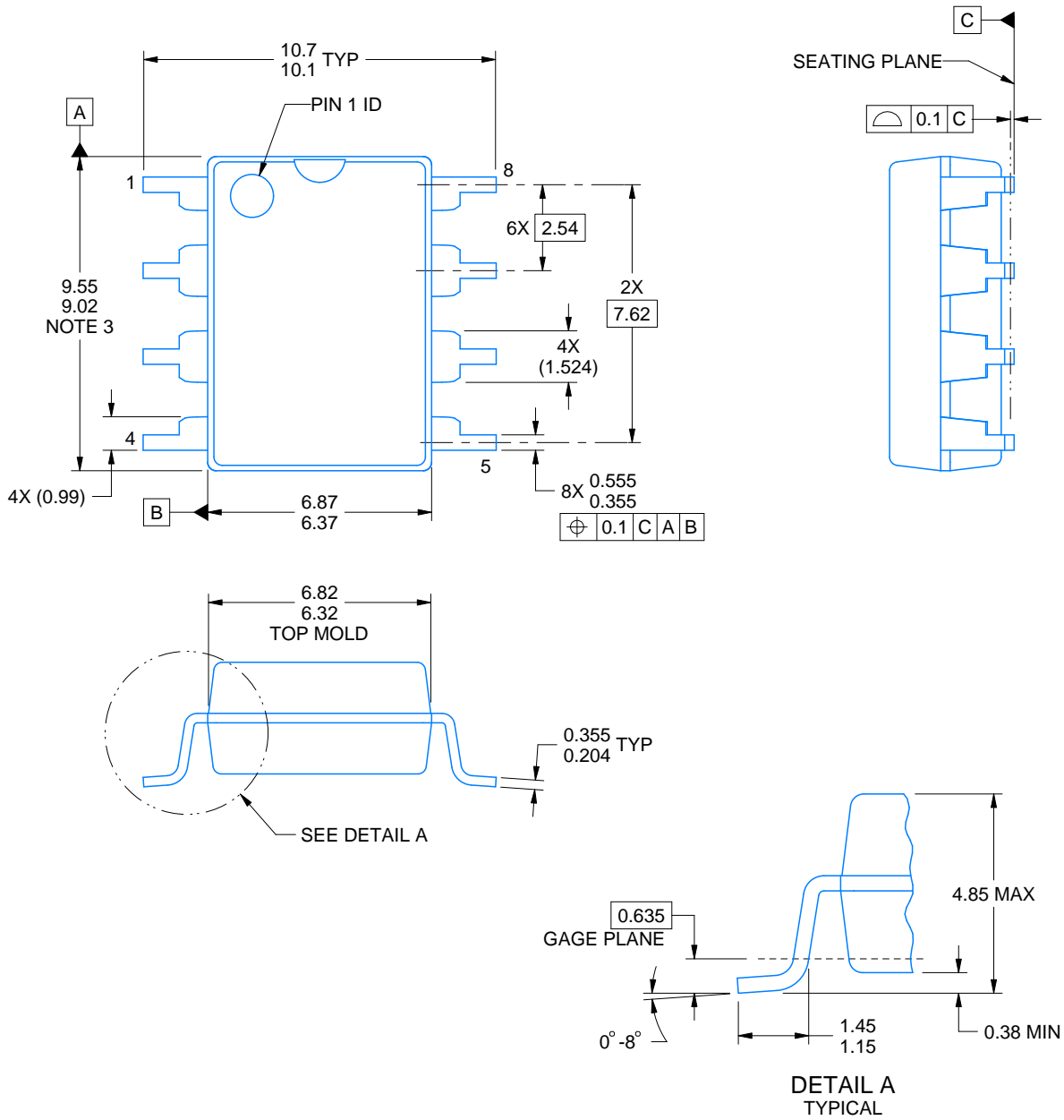

4222355/G 04/2019

NOTES:

1. All linear dimensions are in millimeters. Any dimensions in parenthesis are for reference only. Dimensioning and tolerancing per ASME Y14.5M.
2. This drawing is subject to change without notice.
3. This dimension does not include mold flash, protrusions, or gate burrs. Mold flash, protrusions, or gate burrs shall not exceed 0.254 mm per side.

EXAMPLE BOARD LAYOUT

DUB0008A

SOP - 4.85 mm max height

SMALL OUTLINE PACKAGE

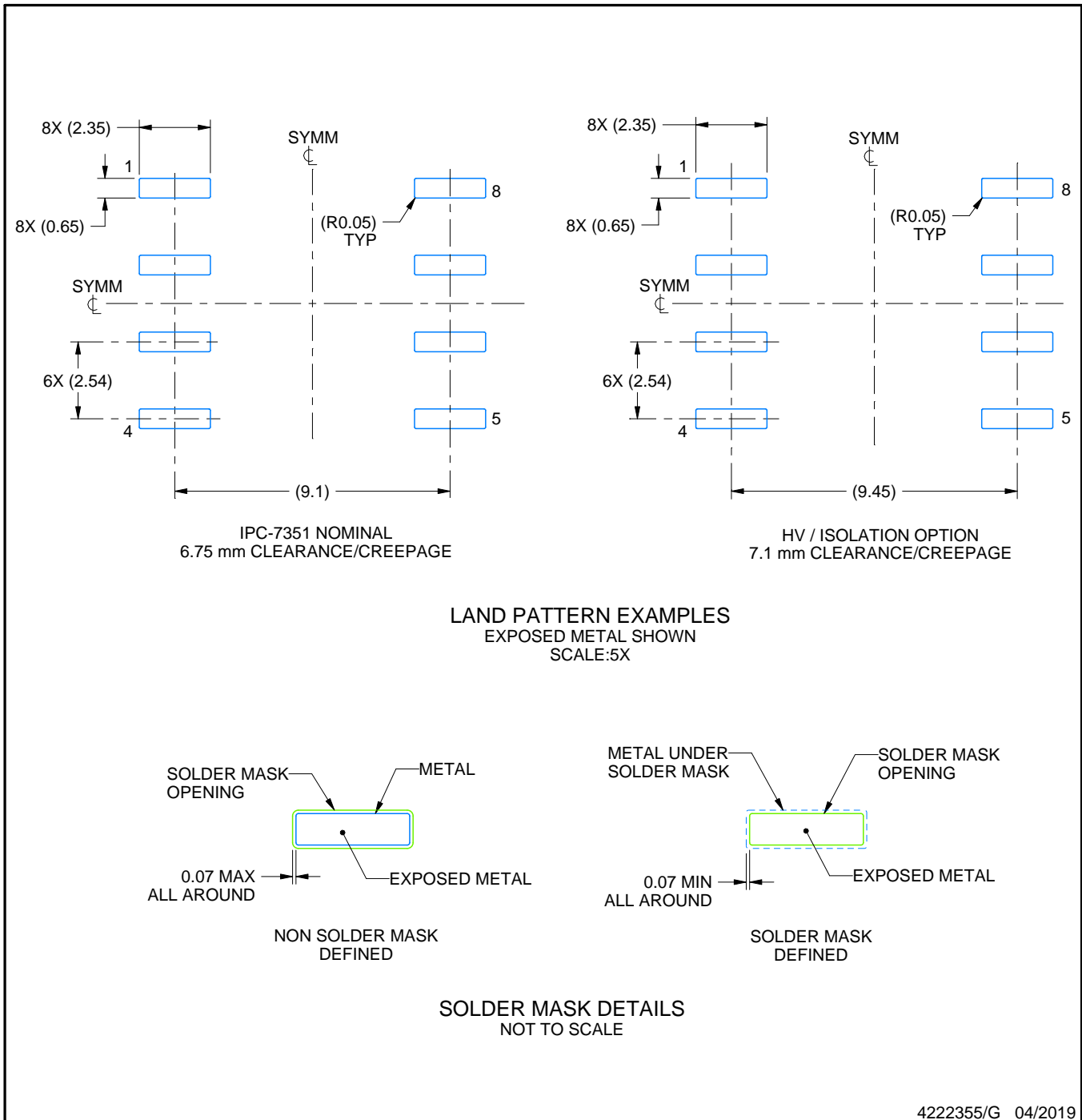

NOTES: (continued)

4. Publication IPC-7351 may have alternate designs.
5. Solder mask tolerances between and around signal pads can vary based on board fabrication site.

EXAMPLE STENCIL DESIGN

DUB0008A

SOP - 4.85 mm max height

SMALL OUTLINE PACKAGE

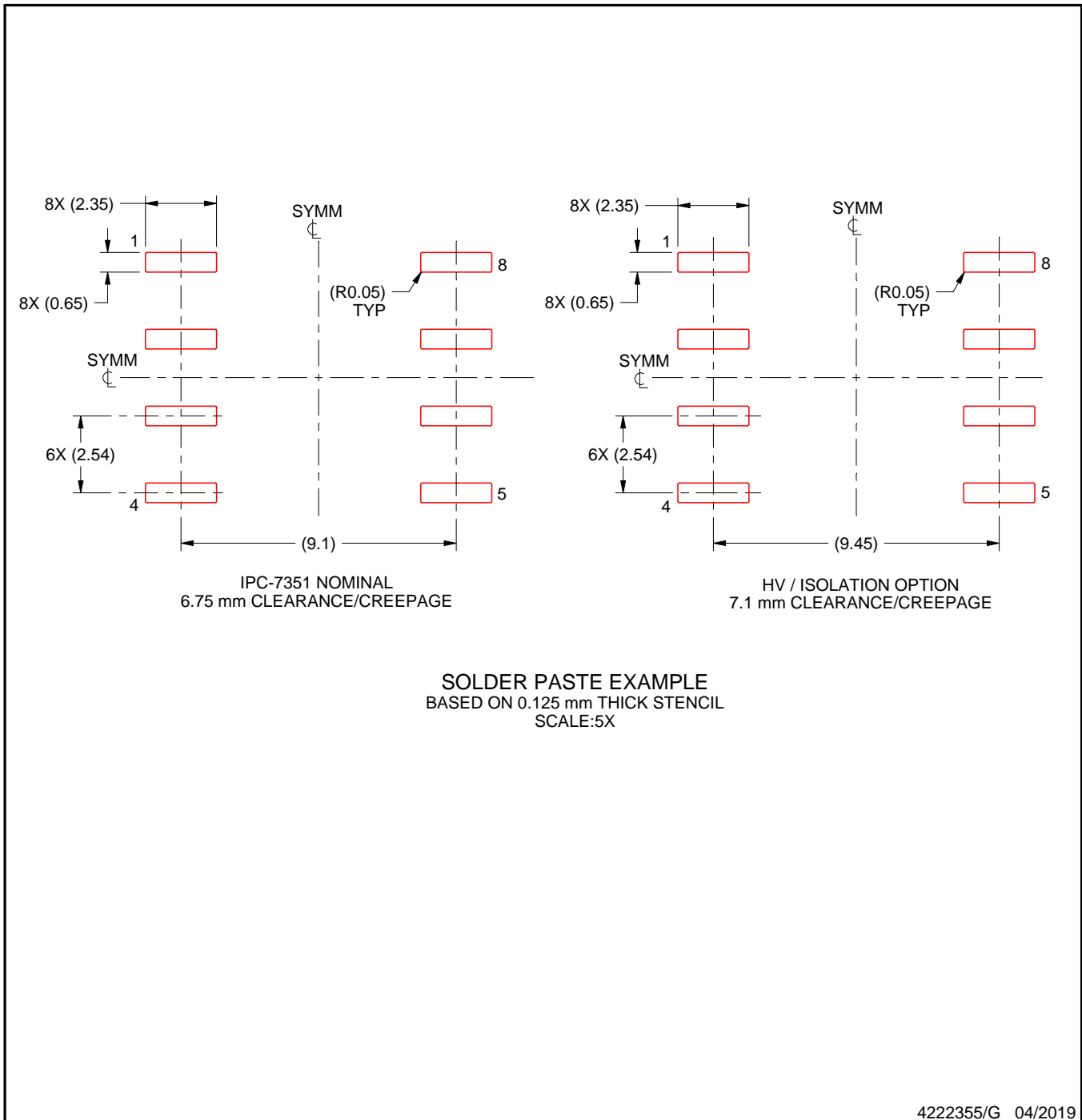

NOTES: (continued)

6. Laser cutting apertures with trapezoidal walls and rounded corners may offer better paste release. IPC-7525 may have alternate design recommendations.
7. Board assembly site may have different recommendations for stencil design.



DWV0008A

SOIC - 2.8 mm max height

SOIC

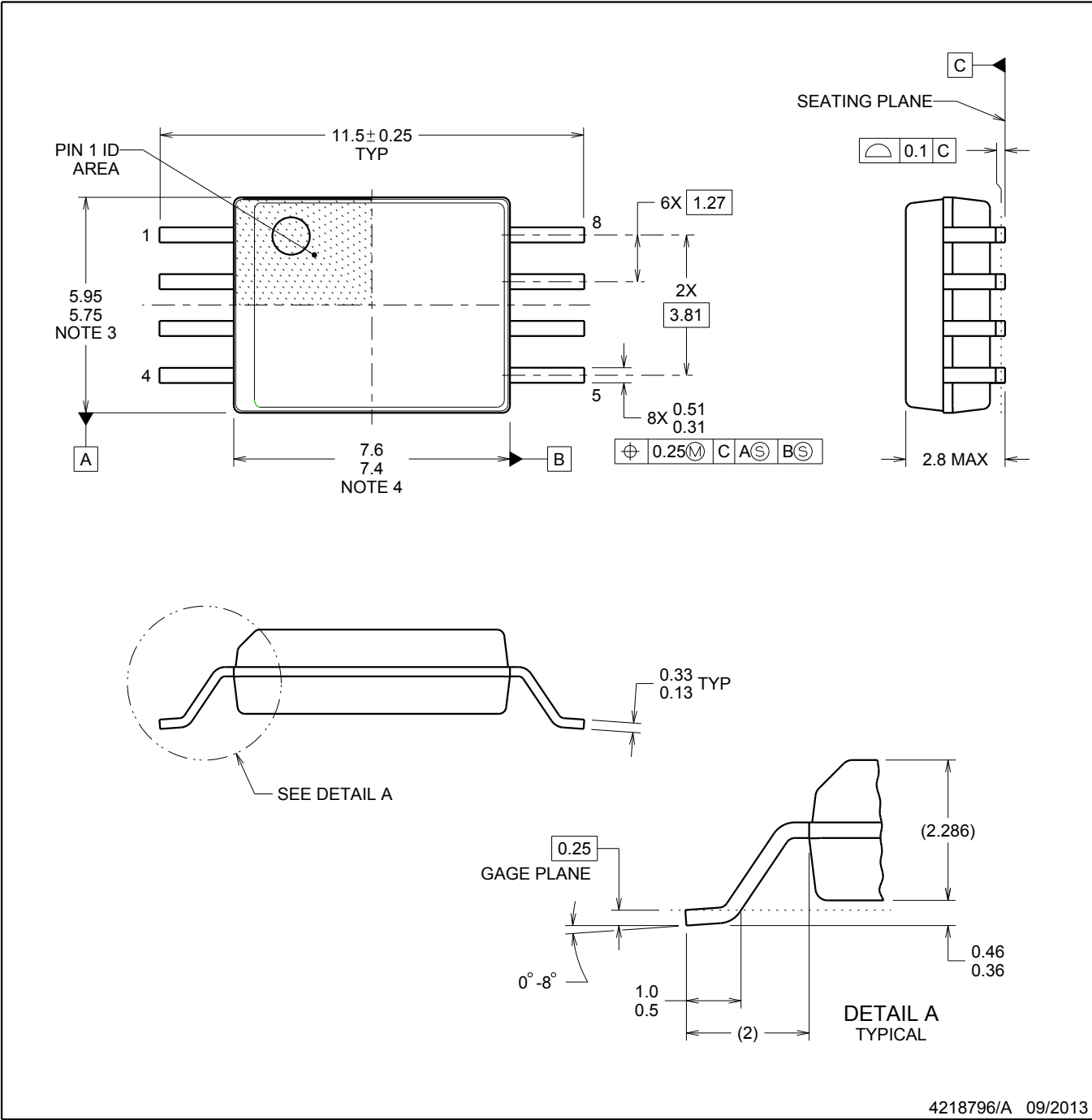

4218796/A 09/2013

NOTES:

- 1. All linear dimensions are in millimeters. Dimensions in parenthesis are for reference only. Dimensioning and tolerancing per ASME Y14.5M.
- 2. This drawing is subject to change without notice.
- 3. This dimension does not include mold flash, protrusions, or gate burrs. Mold flash, protrusions, or gate burrs shall not exceed 0.15 mm, per side.
- 4. This dimension does not include interlead flash. Interlead flash shall not exceed 0.25 mm, per side.



LAND PATTERN EXAMPLE
9.1 mm NOMINAL CLEARANCE/CREEPAGE
SCALE:6X

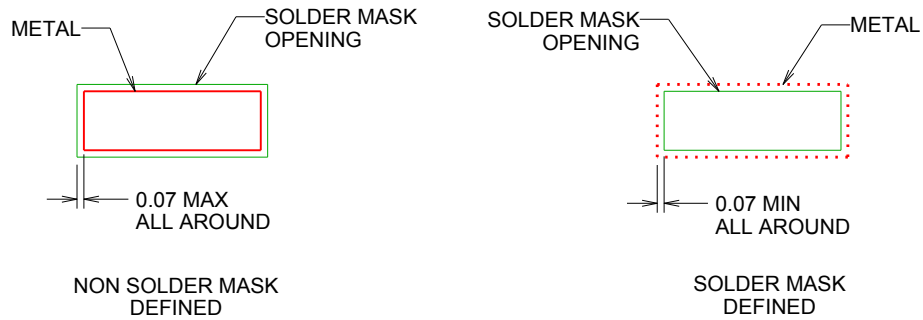

SOLDER MASK DETAILS

4218796/A 09/2013

NOTES: (continued)

- 5. Publication IPC-7351 may have alternate designs.
- 6. Solder mask tolerances between and around signal pads can vary based on board fabrication site.

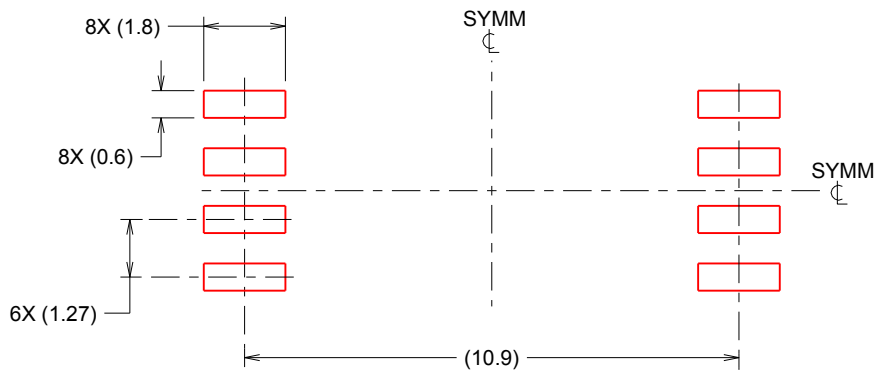

SOLDER PASTE EXAMPLE
 BASED ON 0.125 mm THICK STENCIL
 SCALE:6X

4218796/A 09/2013

NOTES: (continued)

- 7. Laser cutting apertures with trapezoidal walls and rounded corners may offer better paste release. IPC-7525 may have alternate design recommendations.
- 8. Board assembly site may have different recommendations for stencil design.

重要通知和免责声明

TI“按原样”提供技术和可靠性数据（包括数据表）、设计资源（包括参考设计）、应用或其他设计建议、网络工具、安全信息和其他资源，不保证没有瑕疵且不做任何明示或暗示的担保，包括但不限于对适销性、与某特定用途的适用性或不侵犯任何第三方知识产权的暗示担保。

这些资源可供使用 TI 产品进行设计的熟练开发人员使用。您将自行承担以下全部责任：(1) 针对您的应用选择合适的 TI 产品，(2) 设计、验证并测试您的应用，(3) 确保您的应用满足相应标准以及任何其他安全、安保法规或其他要求。

这些资源如有变更，恕不另行通知。TI 授权您仅可将这些资源用于研发本资源所述的 TI 产品的相关应用。严禁以其他方式对这些资源进行复制或展示。您无权使用任何其他 TI 知识产权或任何第三方知识产权。对于因您对这些资源的使用而对 TI 及其代表造成的任何索赔、损害、成本、损失和债务，您将全额赔偿，TI 对此概不负责。

TI 提供的产品受 [TI 销售条款](#)、[TI 通用质量指南](#) 或 [ti.com](#) 上其他适用条款或 TI 产品随附的其他适用条款的约束。TI 提供这些资源并不会扩展或以其他方式更改 TI 针对 TI 产品发布的适用的担保或担保免责声明。除非德州仪器 (TI) 明确将某产品指定为定制产品或客户特定产品，否则其产品均为按确定价格收入目录的标准通用器件。

TI 反对并拒绝您可能提出的任何其他或不同的条款。

版权所有 © 2025，德州仪器 (TI) 公司

最后更新日期：2025 年 10 月