

具有 $\pm 5V$ 输入电压的 AMC1350 精密增强型隔离放大器

1 特性

- 线性输入电压范围： $\pm 5V$
- 高输入阻抗： $1.25m\Omega$ (典型值)
- 固定增益： $0.4 V/V$
- 低直流误差：
 - 失调电压误差 $\pm 1.5mV$ (最大值)
 - 温漂： $\pm 15\mu V/^\circ C$ (最大值)
 - 增益误差： $\pm 0.2\%$ (最大值)
 - 增益漂移： $\pm 35ppm/^\circ C$ (最大值)
 - 非线性 $\pm 0.02\%$ (最大值)
- 高侧和低侧运行电压： $3.3V$ 或 $5V$
- 高 CMTI： $100kV/\mu s$ (最小值)
- 失效防护输出
- 安全相关认证：
 - $7070-V_{PK}$ 增强型隔离，符合 DIN VDE V 0884-11：2017-01
 - 符合 UL1577 标准且长达 1 分钟的 $5000V_{RMS}$ 隔离
- 可在工业级工作温度范围内正常工作： $-40^\circ C$ 至 $+125^\circ C$

2 应用

- 可用于以下应用的隔离式交流电压检测：
 - 电机驱动器
 - 变频器
 - 保护继电器
 - 电源

3 说明

AMC1350 是一款隔离式精密放大器，此放大器的输出与输入电路由抗电磁干扰性能极强的隔离栅隔开。该隔离栅经认证可提供高达 $5kV_{RMS}$ 的增强型电隔离，符合 VDE V 0884-11 和 UL1577 标准，并且可支持最高 $1.5kV_{RMS}$ 的工作电压。

该隔离栅可将系统中以不同共模电压电平运行的各器件隔开，并保护低压侧免受可能有损的电压冲击。

AMC1350 的高阻抗输入针对与高阻抗电阻分压器或具有高输出电阻的其他电压信号源的连接进行了优化。出色的精度和低温漂支持在 $-40^\circ C$ 至 $+125^\circ C$ 的工业级工作温度范围内，在直流/直流转换器、变频器、交流电机和伺服驱动器应用中进行精确的交流和直流电压检测。

器件信息(1)

器件型号	封装	封装尺寸 (标称值)
AMC1350	SOIC (8)	5.85mm × 7.50mm

(1) 如需了解所有可用封装，请参阅数据表末尾的可订购产品附录。

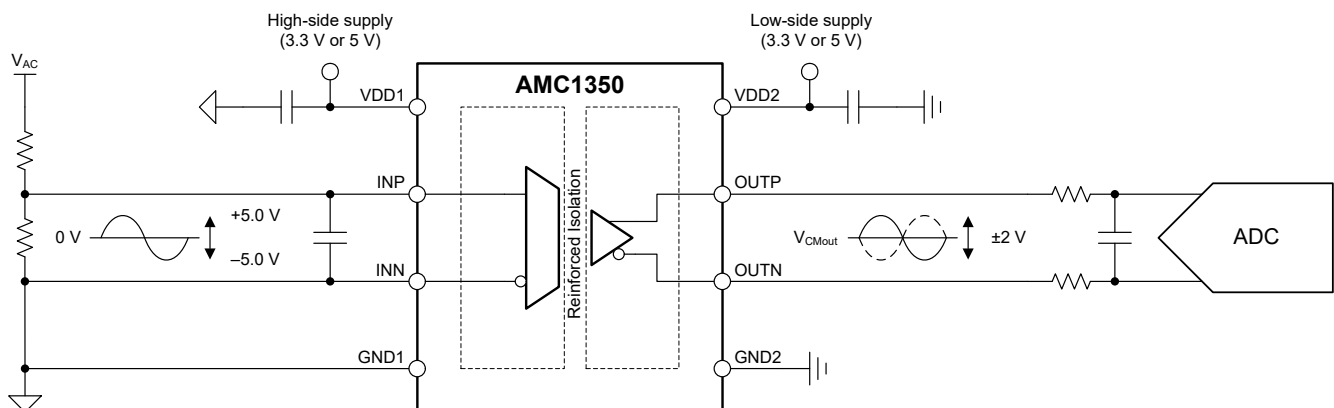

典型应用

Table of Contents

1 特性	1	7.1 Overview.....	19
2 应用	1	7.2 Functional Block Diagram.....	19
3 说明	1	7.3 Feature Description.....	19
4 Revision History	2	7.4 Device Functional Modes.....	21
5 Pin Configuration and Functions	3	8 Application and Implementation	22
6 Specifications	4	8.1 Application Information.....	22
6.1 Absolute Maximum Ratings.....	4	8.2 Typical Application.....	22
6.2 ESD Ratings.....	4	8.3 What To Do and What Not To Do.....	27
6.3 Recommended Operating Conditions.....	4	9 Power Supply Recommendations	27
6.4 Thermal Information.....	5	10 Layout	28
6.5 Power Ratings.....	5	10.1 Layout Guidelines.....	28
6.6 Insulation Specifications.....	6	10.2 Layout Example.....	28
6.7 Safety-Related Certifications.....	7	11 Device and Documentation Support	29
6.8 Safety Limiting Values.....	7	11.1 Documentation Support.....	29
6.9 Electrical Characteristics.....	8	11.2 接收文档更新通知.....	29
6.10 Switching Characteristics.....	10	11.3 支持资源.....	29
6.11 Timing Diagram.....	10	11.4 Trademarks.....	29
6.12 Insulation Characteristics Curves.....	11	11.5 Electrostatic Discharge Caution.....	29
6.13 Typical Characteristics.....	12	11.6 术语表.....	29
7 Detailed Description	19		

4 Revision History

注：以前版本的页码可能与当前版本的页码不同

Changes from Revision * (August 2021) to Revision A (December 2021)	Page
• 将文档状态从 <i>预告信息</i> 更改为 <i>量产数据</i>	1

5 Pin Configuration and Functions



图 5-1. DWV Package, 8-Pin SOIC, Top View

表 5-1. Pin Functions

PIN		TYPE	DESCRIPTION
NO.	NAME		
1	VDD1	High-side power	High-side power supply ⁽¹⁾
2	INP	Analog input	Noninverting analog input. Either INP or INN must have a DC current path to GND1 to define the common-mode input voltage. ⁽²⁾
3	INN	Analog input	Inverting analog input. Either INP or INN must have a DC current path to GND1 to define the common-mode input voltage. ⁽²⁾
4	GND1	High-side ground	High-side analog ground
5	GND2	Low-side ground	Low-side analog ground
6	OUTN	Analog output	Inverting analog output
7	OUTP	Analog output	Noninverting analog output
8	VDD2	Low-side power	Low-side power supply ⁽¹⁾

- (1) See the [Power Supply Recommendations](#) section for power-supply decoupling recommendations.
 (2) See the [Layout](#) section for details.

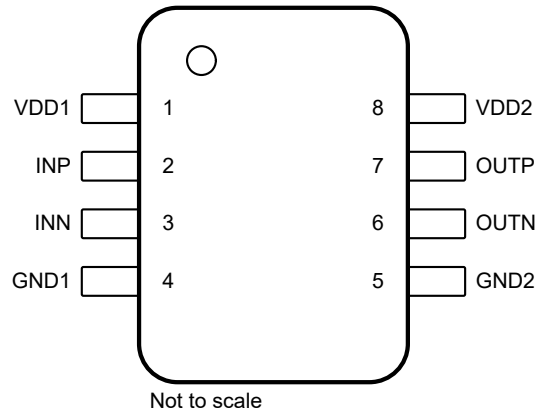
6 Specifications

6.1 Absolute Maximum Ratings

see⁽¹⁾

		MIN	MAX	UNIT
Power-supply voltage	High-side VDD1 to GND1	- 0.3	6.5	V
	Low-side VDD2 to GND2	- 0.3	6.5	
Analog input voltage	INP, INN	- 15	15	V
Analog output voltage	OUTP, OUTN	GND2 - 0.5	VDD2 + 0.5	V
Input current	Continuous, any pin except power-supply pins	- 10	10	mA
Temperature	Junction, T _J		150	°C
	Storage, T _{stg}	- 65	150	

- (1) Operation outside the *Absolute Maximum Ratings* may cause permanent device damage. *Absolute Maximum Ratings* do not imply functional operation of the device at these or any other conditions beyond those listed under *Recommended Operating Conditions*. If used outside the Recommended Operating Conditions but within the Absolute Maximum Ratings, the device may not be fully functional, and this may affect device reliability, functionality, performance, and shorten the device lifetime

6.2 ESD Ratings

			VALUE	UNIT
V _(ESD)	Electrostatic discharge	Human-body model (HBM), per ANSI/ESDA/JEDEC JS-001 ⁽¹⁾	±2000	V
		Charged-device model (CDM), per per ANSI/ESDA/JEDEC JS-002 ⁽²⁾	±1000	

- (1) JEDEC document JEP155 states that 500-V HBM allows safe manufacturing with a standard ESD control process.
 (2) JEDEC document JEP157 states that 250-V CDM allows safe manufacturing with a standard ESD control process.

6.3 Recommended Operating Conditions

over operating ambient temperature range (unless otherwise noted)

			MIN	NOM	MAX	UNIT
POWER SUPPLY						
VDD1	High-side power-supply	VDD1 to GND1	3	5	5.5	V
VDD2	Low-side power-supply	VDD2 to GND2	3	3.3	5.5	V
ANALOG INPUT						
V _{Clipping}	Input voltage before clipping output	V _{IN} = V _{INP} - V _{INN}	±6.25			V
V _{FSR}	Specified linear full-scale voltage	V _{IN} = V _{INP} - V _{INN}	- 5		5	V
V _{CM}	Operating common-mode input voltage		- 4		4	V
ANALOG OUTPUT						
C _{LOAD}	Capacitive load	On OUTP or OUTN to GND2			500	pF
		OUTP to OUTN			250	
R _{LOAD}	Resistive load	On OUTP or OUTN to GND2		10	1	kΩ
TEMPERATURE RANGE						
T _A	Operating ambient temperature		- 55		125	°C
	Specified ambient temperature		- 40		125	

6.4 Thermal Information

THERMAL METRIC ⁽¹⁾		AMC1350	UNIT
		DWV (SOIC)	
		8 PINS	
$R_{\theta JA}$	Junction-to-ambient thermal resistance	84.6	°C/W
$R_{\theta JC(top)}$	Junction-to-case (top) thermal resistance	28.3	°C/W
$R_{\theta JB}$	Junction-to-board thermal resistance	41.1	°C/W
ψ_{JT}	Junction-to-top characterization parameter	4.9	°C/W
ψ_{JB}	Junction-to-board characterization parameter	39.1	°C/W
$R_{\theta JC(bot)}$	Junction-to-case (bottom) thermal resistance	n/a	°C/W

(1) For more information about traditional and new thermal metrics, see the [Semiconductor and IC Package Thermal Metrics](#) application report.

6.5 Power Ratings

PARAMETER	TEST CONDITIONS	VALUE	UNIT
P_D	Maximum power dissipation (both sides) VDD1 = VDD2 = 5.5 V	96	mW
P_{D1}	Maximum power dissipation (high-side) VDD1 = 3.6 V	29	mW
	VDD1 = 5.5 V	51	
P_{D2}	Maximum power dissipation (low-side) VDD2 = 3.6 V	26	mW
	VDD2 = 5.5 V	45	

6.6 Insulation Specifications

over operating ambient temperature range (unless otherwise noted)

PARAMETER		TEST CONDITIONS	VALUE	UNIT
GENERAL				
CLR	External clearance ⁽¹⁾	Shortest pin-to-pin distance through air	≥ 8.5	mm
CPG	External creepage ⁽¹⁾	Shortest pin-to-pin distance across the package surface	≥ 8.5	mm
DTI	Distance through insulation	Minimum internal gap (internal clearance) of the double insulation	≥ 0.021	mm
CTI	Comparative tracking index	DIN EN 60112 (VDE 0303-11); IEC 60112	≥ 600	V
	Material group	According to IEC 60664-1	I	
	Overvoltage category per IEC 60664-1	Rated mains voltage ≤ 600 V _{RMS}	I-IV	
		Rated mains voltage ≤ 1000 V _{RMS}	I-III	
DIN VDE V 0884-11 (VDE V 0884-11): 2017-01				
V _{IORM}	Maximum repetitive peak isolation voltage	At AC voltage	2120	V _{PK}
V _{IOWM}	Maximum-rated isolation working voltage	At AC voltage (sine wave)	1500	V _{RMS}
		At DC voltage	2120	V _{DC}
V _{IOTM}	Maximum transient isolation voltage	V _{TEST} = V _{IOTM} , t = 60 s (qualification test)	7070	V _{PK}
		V _{TEST} = 1.2 × V _{IOTM} , t = 1 s (100% production test)	8480	
V _{IOSM}	Maximum surge isolation voltage ⁽²⁾	Test method per IEC 60065, 1.2/50-μs waveform, V _{TEST} = 1.6 × V _{IOSM} = 12800 V _{PK} (qualification)	8000	V _{PK}
q _{pd}	Apparent charge ⁽³⁾	Method a, after input/output safety test subgroups 2 and 3, V _{ini} = V _{IOTM} , t _{ini} = 60 s, V _{pd(m)} = 1.2 × V _{IORM} , t _m = 10 s	≤ 5	pC
		Method a, after environmental tests subgroup 1, V _{ini} = V _{IOTM} , t _{ini} = 60 s, V _{pd(m)} = 1.6 × V _{IORM} , t _m = 10 s	≤ 5	
		Method b1, at routine test (100% production) and preconditioning (type test), V _{ini} = V _{IOTM} , t _{ini} = 1 s, V _{pd(m)} = 1.875 × V _{IORM} , t _m = 1 s	≤ 5	
C _{IO}	Barrier capacitance, input to output ⁽⁴⁾	V _{IO} = 0.5 V _{PP} at 1 MHz	~1.5	pF
R _{IO}	Insulation resistance, input to output ⁽⁴⁾	V _{IO} = 500 V at T _A = 25°C	> 10 ¹²	Ω
		V _{IO} = 500 V at 100°C ≤ T _A ≤ 125°C	> 10 ¹¹	
		V _{IO} = 500 V at T _S = 150°C	> 10 ⁹	
	Pollution degree		2	
	Climatic category		55/125/21	
UL1577				
V _{ISO}	Withstand isolation voltage	V _{TEST} = V _{ISO} = 5000 V _{RMS} or 7071 V _{DC} , t = 60 s (qualification), V _{TEST} = 1.2 × V _{ISO} = 6000 V _{RMS} , t = 1 s (100% production test)	5000	V _{RMS}

- (1) Apply creepage and clearance requirements according to the specific equipment isolation standards of an application. Care must be taken to maintain the creepage and clearance distance of a board design to ensure that the mounting pads of the isolator on the printed circuit board (PCB) do not reduce this distance. Creepage and clearance on a PCB become equal in certain cases. Techniques such as inserting grooves, ribs, or both on a PCB are used to help increase these specifications.
- (2) Testing is carried out in air or oil to determine the intrinsic surge immunity of the isolation barrier.
- (3) Apparent charge is electrical discharge caused by a partial discharge (pd).
- (4) All pins on each side of the barrier are tied together, creating a two-pin device.

6.7 Safety-Related Certifications

VDE	UL
Certified according to DIN VDE V 0884-11 (VDE V 0884-11): 2017-01, DIN EN 60950-1 (VDE 0805 Teil 1): 2014-08, and DIN EN 60065 (VDE 0860): 2005-11	Recognized under 1577 component recognition
Reinforced insulation	Single protection
Certificate number: pending	File number: E181974

6.8 Safety Limiting Values

Safety limiting⁽¹⁾ intends to minimize potential damage to the isolation barrier upon failure of input or output circuitry. A failure of the I/O can allow low resistance to ground or the supply and, without current limiting, dissipate sufficient power to over-heat the die and damage the isolation barrier potentially leading to secondary system failures.

PARAMETER		TEST CONDITIONS	MIN	TYP	MAX	UNIT
I _S	Safety input, output, or supply current	R _{θJA} = 84.6°C/W, VDDX = 5.5 V, T _J = 150°C, T _A = 25°C			270	mA
		R _{θJA} = 84.6°C/W, VDDX = 3.6 V, T _J = 150°C, T _A = 25°C			410	
P _S	Safety input, output, or total power	R _{θJA} = 84.6°C/W, T _J = 150°C, T _A = 25°C			1480	mW
T _S	Maximum safety temperature				150	°C

- (1) The maximum safety temperature, T_S, has the same value as the maximum junction temperature, T_J, specified for the device. The I_S and P_S parameters represent the safety current and safety power, respectively. Do not exceed the maximum limits of I_S and P_S. These limits vary with the ambient temperature, T_A.

The junction-to-air thermal resistance, R_{θJA}, in the [Thermal Information](#) table is that of a device installed on a high-K test board for leaded surface-mount packages. Use these equations to calculate the value for each parameter:

T_J = T_A + R_{θJA} × P, where P is the power dissipated in the device.

T_{J(max)} = T_S = T_A + R_{θJA} × P_S, where T_{J(max)} is the maximum junction temperature.

P_S = I_S × VDD_{max}, where VDD_{max} is the maximum supply voltage for high-side and low-side.

6.9 Electrical Characteristics

minimum and maximum specifications apply from $T_A = -40^\circ\text{C}$ to $+125^\circ\text{C}$, $V_{DD1} = 3.0\text{ V}$ to 5.5 V , $V_{DD2} = 3.0\text{ V}$ to 5.5 V , $\text{INP} = -5\text{ V}$ to $+5\text{ V}$, and $\text{INN} = \text{GND1}$ (unless otherwise noted); typical specifications are at $T_A = 25^\circ\text{C}$, $V_{DD1} = 5\text{ V}$, and $V_{DD2} = 3.3\text{ V}$

PARAMETER		TEST CONDITIONS	MIN	TYP	MAX	UNIT
ANALOG INPUT						
V_{OS}	Offset voltage ⁽²⁾	$T_A = 25^\circ\text{C}$, $\text{INN} = \text{INP} = \text{GND1}$, $4.5\text{ V} \leq V_{DD1} \leq 5.5\text{ V}$ ⁽¹⁾	- 1.5	± 0.3	1.5	mV
		$T_A = 25^\circ\text{C}$, $\text{INN} = \text{INP} = \text{GND1}$, $3.0\text{ V} \leq V_{DD1} \leq 5.5\text{ V}$ ⁽³⁾	- 2.5	- 0.8	2.5	
ΔV_{OS}	Offset voltage long-term stability	10 years at $T_A = 55^\circ\text{C}$		0 ⁽⁷⁾		mV
TCV_{OS}	Offset voltage thermal drift ⁽⁵⁾	$\text{INN} = \text{INP} = \text{GND1}$	- 15	± 3	15	$\mu\text{V}/^\circ\text{C}$
ΔTCV_{OS}	Offset voltage thermal drift long-term stability	10 years at $T_A = 55^\circ\text{C}$, $\text{INN} = \text{INP} = \text{GND1}$		0 ⁽⁷⁾		$\text{mV}/^\circ\text{C}$
R_{IN}	Input resistance, differential		2	2.5	3	$\text{M}\Omega$
	Input resistance, single ended	$\text{INN} = \text{GND1}$	1	1.25	1.5	
ΔR_{IN}	Input resistance long-term stability	10 years at $T_A = 55^\circ\text{C}$		0 ⁽⁷⁾		ppm
TCR_{IN}	Input resistance thermal drift	$-40^\circ\text{C} \leq T_A \leq 85^\circ\text{C}$		5		$\text{ppm}/^\circ\text{C}$
C_{IN}	Single-ended input capacitance	$\text{INN} = \text{HGND}$, $f_{IN} = 275\text{ kHz}$		4		pF
C_{IND}	Differential input capacitance	$f_{IN} = 275\text{ kHz}$		2		pF
ANALOG OUTPUT						
	Nominal gain			0.40		V/V
E_G	Gain error ⁽¹⁾	$T_A = 25^\circ\text{C}$	- 0.2%	$\pm 0.05\%$	0.2%	
ΔE_G	Gain error long-term stability	10 years at $T_A = 55^\circ\text{C}$		0 ⁽⁷⁾		
TCE_G	Gain error thermal drift ^{(1) (6)}		- 35	± 10	35	$\text{ppm}/^\circ\text{C}$
ΔTCE_G	Gain error thermal drift long-term stability	10 years at $T_A = 55^\circ\text{C}$		0 ⁽⁷⁾		$\text{ppm}/^\circ\text{C}$
	Nonlinearity ⁽¹⁾		- 0.02%	$\pm 0.003\%$	0.02%	
	Nonlinearity thermal drift			0.2		$\text{ppm}/^\circ\text{C}$
THD	Total harmonic distortion ⁽⁴⁾	$V_{IN} = 10 V_{PP}$, $f_{IN} = 10\text{ kHz}$, $\text{BW} = 100\text{ kHz}$		- 87		dB
SNR	Signal-to-noise ratio	$V_{IN} = 10 V_{PP}$, $f_{IN} = 1\text{ kHz}$, $\text{BW} = 10\text{ kHz}$	81	85		dB
		$V_{IN} = 10 V_{PP}$, $f_{IN} = 10\text{ kHz}$, $\text{BW} = 100\text{ kHz}$		75		
	Output noise	$\text{INN} = \text{INP} = \text{GND1}$, $\text{BW} = 100\text{ kHz}$		250		μV_{rms}
CMRR	Common-mode rejection ratio	DC, $\text{INN} = \text{INP}$, $V_{CM\ min} \leq V_{CM} \leq V_{CM\ max}$		- 72		dB
		$f_{IN} = 10\text{ kHz}$, $\text{INN} = \text{INP} = 10 V_{PP}$		- 71		
PSRR	Power-supply rejection ratio ⁽²⁾	PSRR vs V_{DD1} , DC		- 67		dB
		PSRR vs V_{DD2} , DC		- 80		
		PSRR vs V_{DD1} with 10-kHz, 100-mV ripple		- 65		
		PSRR vs V_{DD2} with 10-kHz, 100-mV ripple		- 64		
V_{CMout}	Output common-mode voltage		1.39	1.44	1.49	V
$V_{CLIPout}$	Clipping differential output voltage	$V_{OUT} = (V_{OUTP} - V_{OUTN})$, $V_{IN} > V_{Clipping}$		2.49		V
$V_{Fail-safe}$	Fail-safe differential output voltage	V_{DD1} undervoltage or V_{DD1} missing		- 2.57	- 2.5	V
BW	Output bandwidth		275	300		kHz

6.9 Electrical Characteristics (continued)

minimum and maximum specifications apply from $T_A = -40^\circ\text{C}$ to $+125^\circ\text{C}$, $V_{DD1} = 3.0\text{ V}$ to 5.5 V , $V_{DD2} = 3.0\text{ V}$ to 5.5 V , $\text{INP} = -5\text{ V}$ to $+5\text{ V}$, and $\text{INN} = \text{GND1}$ (unless otherwise noted); typical specifications are at $T_A = 25^\circ\text{C}$, $V_{DD1} = 5\text{ V}$, and $V_{DD2} = 3.3\text{ V}$

PARAMETER		TEST CONDITIONS	MIN	TYP	MAX	UNIT
R_{OUT}	Output resistance	On OOTP or OUTN		< 0.2		Ω
	Output short-circuit current	On OOTP or OUTN, sourcing or sinking, $\text{INN} = \text{INP} = \text{GND1}$, outputs shorted to either GND or VDD2		14		mA
CMTI	Common-mode transient immunity		100	150		kV/ μs
POWER SUPPLY						
V_{DD1UV}	VDD1 undervoltage detection threshold	VDD1 rising	2.5	2.7	2.9	V
		VDD1 falling	2.4	2.6	2.8	
V_{DD2UV}	VDD2 undervoltage detection threshold	VDD2 rising	2.2	2.45	2.65	V
		VDD2 falling	1.85	2.0	2.2	
I_{DD1}	High-side supply current	$3.0\text{ V} < V_{\text{DD1}} < 3.6\text{ V}$		6.0	8.1	mA
		$4.5\text{ V} < V_{\text{DD1}} < 5.5\text{ V}$		7.0	9.3	
I_{DD2}	Low-side supply current	$3.0\text{ V} < V_{\text{DD2}} < 3.6\text{ V}$		5.3	7.2	mA
		$4.5\text{ V} < V_{\text{DD2}} < 5.5\text{ V}$		5.9	8.1	

- (1) The typical value includes one standard deviation (*sigma*) at nominal operating conditions.
- (2) This parameter is input referred.
- (3) The typical value is at $V_{\text{DD1}} = 3.3\text{ V}$.
- (4) THD is the ratio of the rms sum of the amplitudes of first five higher harmonics to the amplitude of the fundamental.
- (5) Offset error temperature drift is calculated using the box method, as described by the following equation:

$$TCV_{\text{OS}} = (V_{\text{OS,MAX}} - V_{\text{OS,MIN}}) / \text{TempRange}$$
where $V_{\text{OS,MAX}}$ and $V_{\text{OS,MIN}}$ refer to the maximum and minimum V_{OS} values measured within the temperature range (-40 to 125°C).
- (6) Gain error temperature drift is calculated using the box method, as described by the following equation:

$$TCE_G (\text{ppm}) = ((E_{\text{G,MAX}} - E_{\text{G,MIN}}) / \text{TempRange}) \times 10^4$$
where $E_{\text{G,MAX}}$ and $E_{\text{G,MIN}}$ refer to the maximum and minimum E_{G} values (in %) measured within the temperature range (-40 to 125°C).
- (7) Value is below measurement capability.

6.10 Switching Characteristics

over operating ambient temperature range (unless otherwise noted)

PARAMETER		TEST CONDITIONS	MIN	TYP	MAX	UNIT
t_r	Output signal rise time			1.3		μs
t_f	Output signal fall time			1.3		μs
	IN to OUTx signal delay (50% - 10%)	Unfiltered output		1	1.5	μs
	IN to OUTx signal delay (50% - 50%)	Unfiltered output		1.6	2.1	μs
	IN to OUTx signal delay (50% - 90%)	Unfiltered output		2.5	3	μs
t_{AS}	Analog settling time	VDD1 step to 3.0 V with VDD2 \geq 3.0 V, to V _{OUTP} and V _{OUTN} valid, 0.1% settling		500	800	μs

6.11 Timing Diagram



图 6-1. Rise, Fall, and Delay Time Definition

6.12 Insulation Characteristics Curves



图 6-2. Thermal Derating Curve for Safety-Limiting Current per VDE

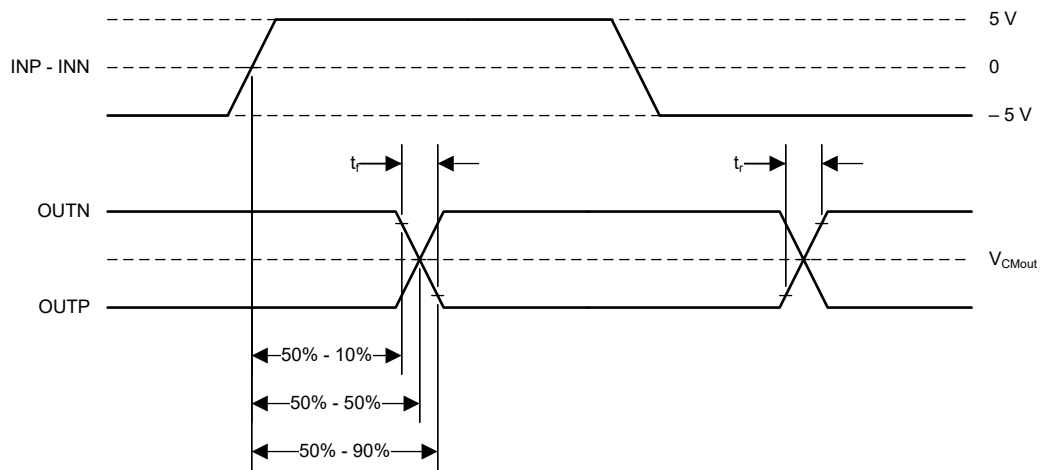

图 6-3. Thermal Derating Curve for Safety-Limiting Power per VDE

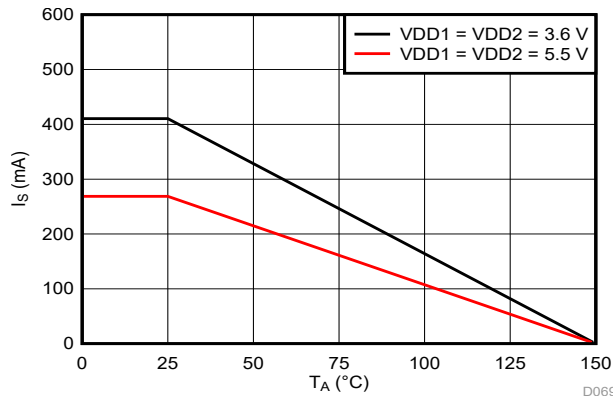

T_A up to 150°C, stress-voltage frequency = 60 Hz, isolation working voltage = 1500 V_{RMS} , operating lifetime = 135 years

图 6-4. Reinforced Isolation Capacitor Lifetime Projection

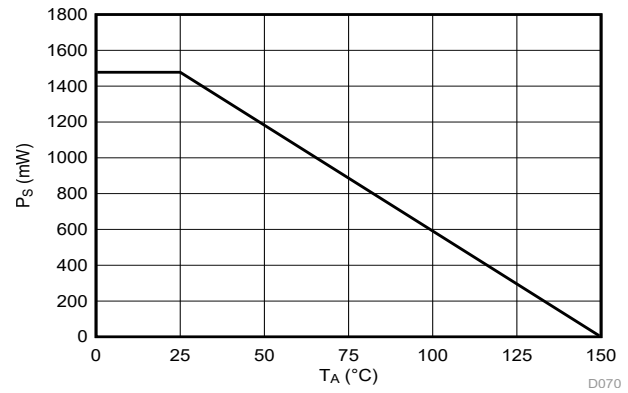
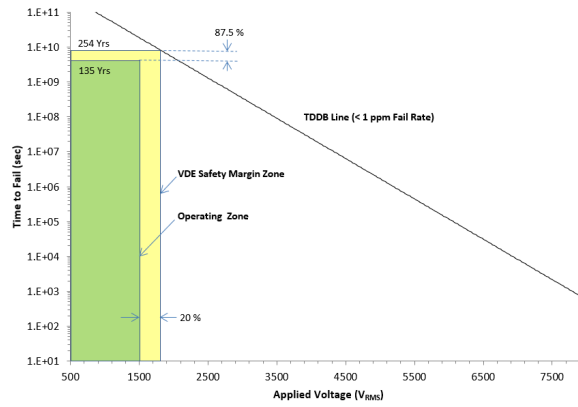
6.13 Typical Characteristics

at VDD1 = 5 V, VDD2 = 3.3 V, INN = GND1, INP = - 5 V to 5 V, and $f_{IN} = 10$ kHz (unless otherwise noted)



图 6-5. Output Voltage vs Input Voltage



Total uncalibrated output error is defined as:
 $(V_{OUT} - V_{IN} \times G) / (V_{Clipping} \times G)$ where $V_{IN} = (V_{INP} - V_{INN})$,
 G is the nominal gain of the device (0.4 V/V),
 and $V_{Clipping}$ is 6.25 V

图 6-6. Total Uncalibrated Output Error vs Input Voltage

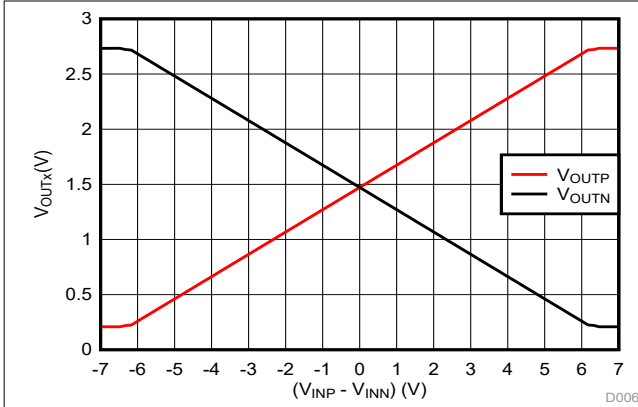
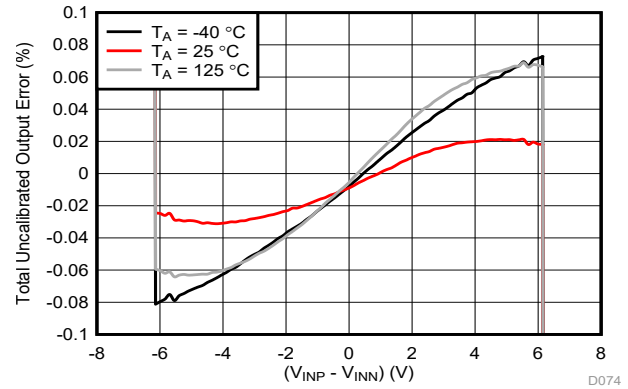

图 6-7. Input Offset Voltage vs High-Side Supply Voltage



图 6-8. Input Offset Voltage vs Low-Side Supply Voltage

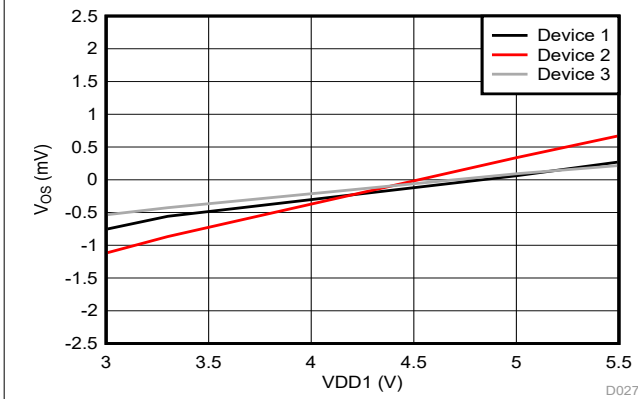

图 6-9. Input Offset Voltage vs Temperature

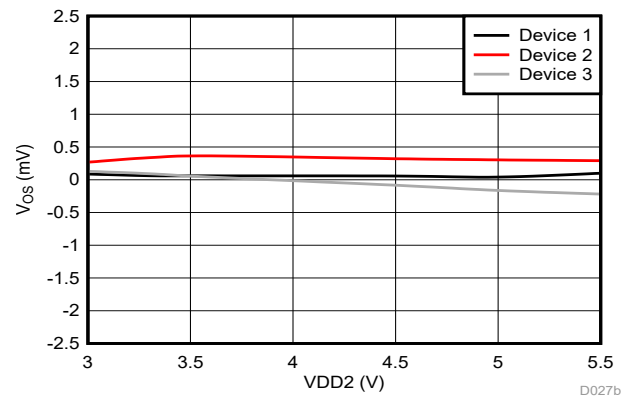

图 6-10. Differential Input Impedance vs Temperature

6.13 Typical Characteristics (continued)

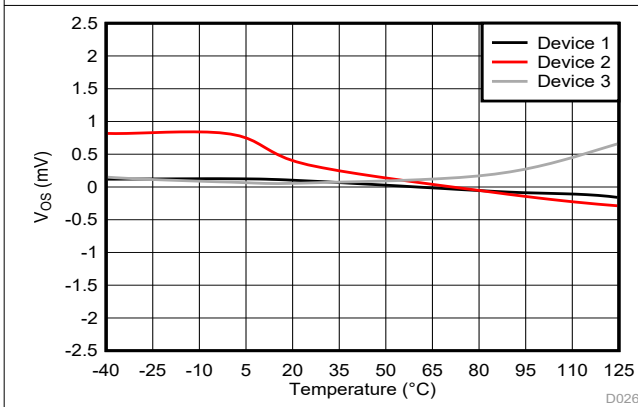
at VDD1 = 5 V, VDD2 = 3.3 V, INN = GND1, INP = -5 V to 5 V, and $f_{IN} = 10$ kHz (unless otherwise noted)

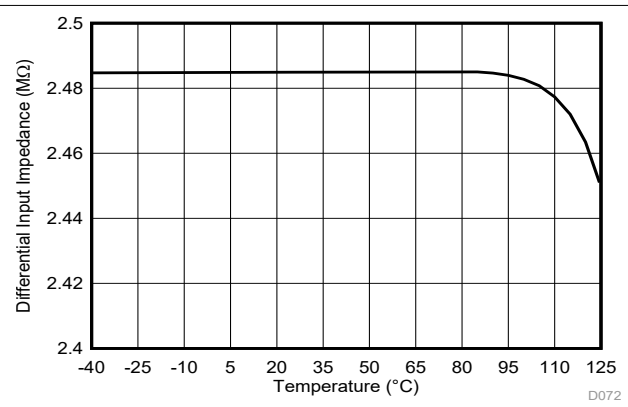

图 6-11. Single-Ended Input Impedance vs Temperature



图 6-12. Gain Error vs High-Side Supply Voltage

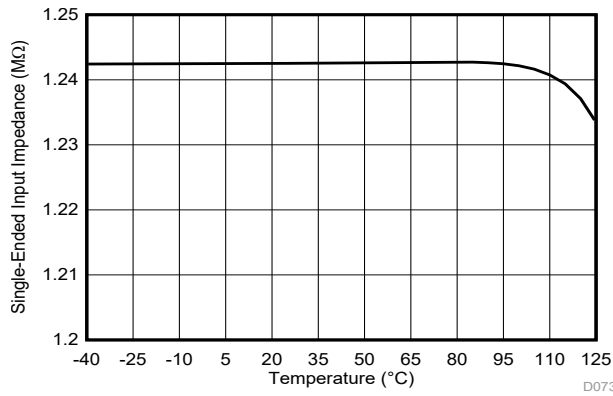

图 6-13. Gain Error vs Low-Side Supply Voltage

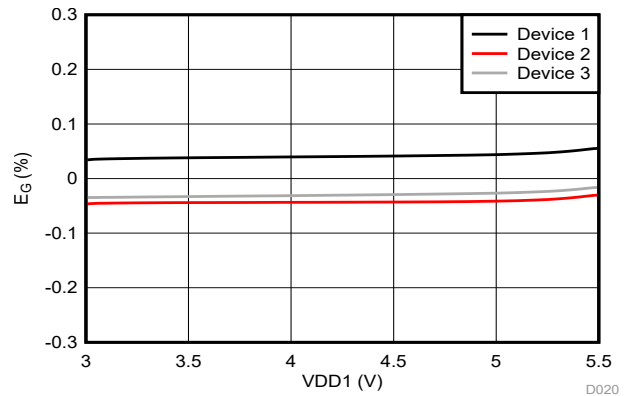

图 6-14. Gain Error vs Temperature

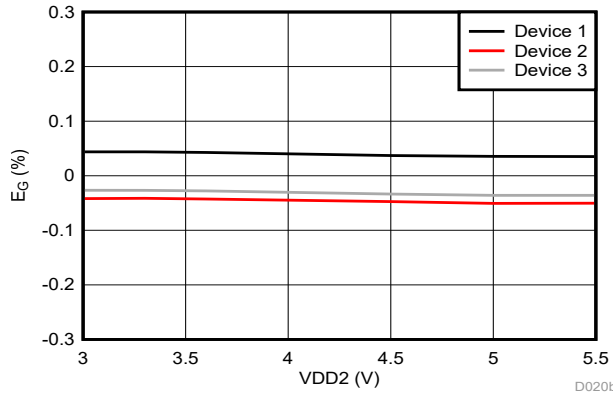

图 6-15. Nonlinearity vs Input Voltage

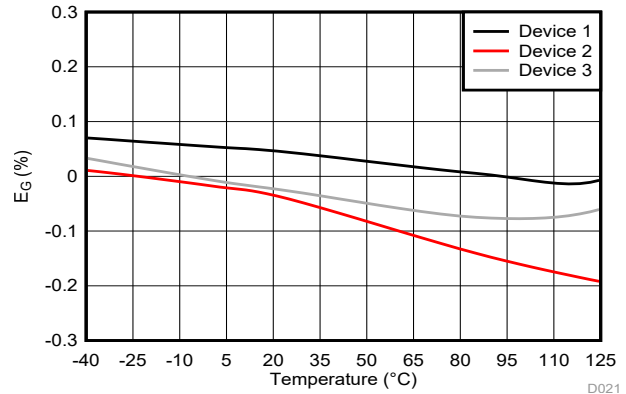

图 6-16. Nonlinearity vs High-Side Supply Voltage

6.13 Typical Characteristics (continued)

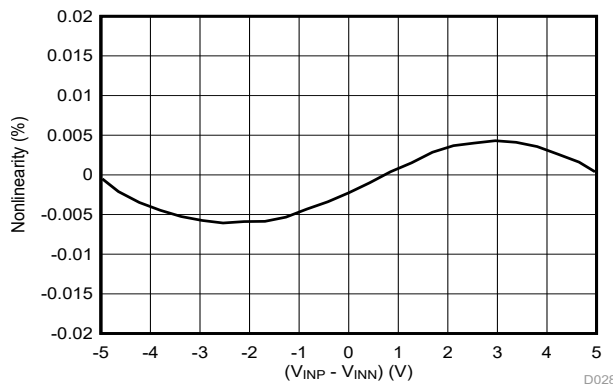
at VDD1 = 5 V, VDD2 = 3.3 V, INN = GND1, INP = - 5 V to 5 V, and $f_{IN} = 10$ kHz (unless otherwise noted)

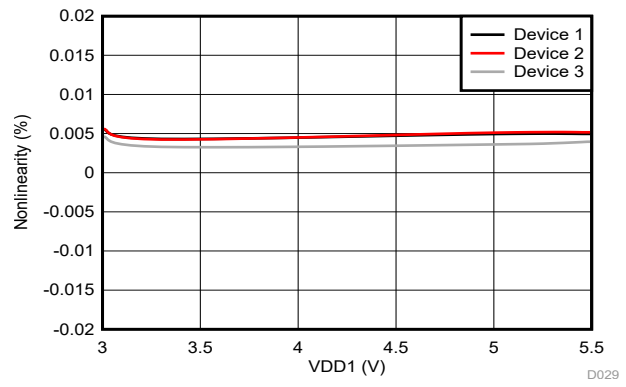

图 6-17. Nonlinearity vs Low-Side Supply Voltage



图 6-18. Nonlinearity vs Temperature

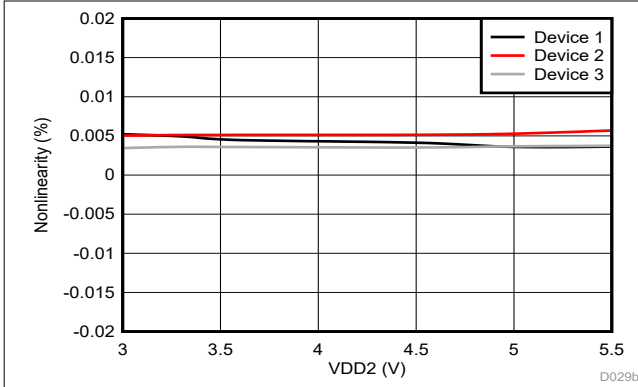

图 6-19. Total Harmonic Distortion vs Input Voltage

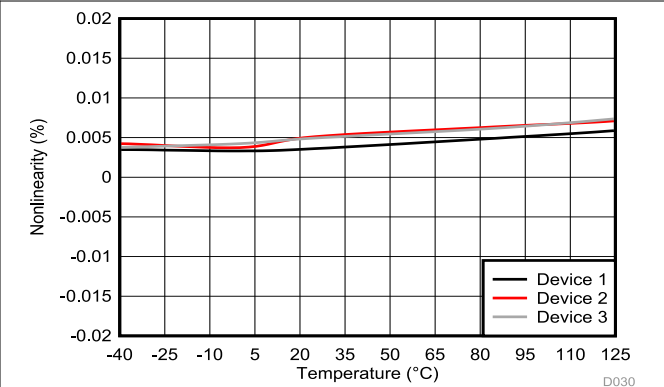

图 6-20. Total Harmonic Distortion vs High-Side Supply Voltage

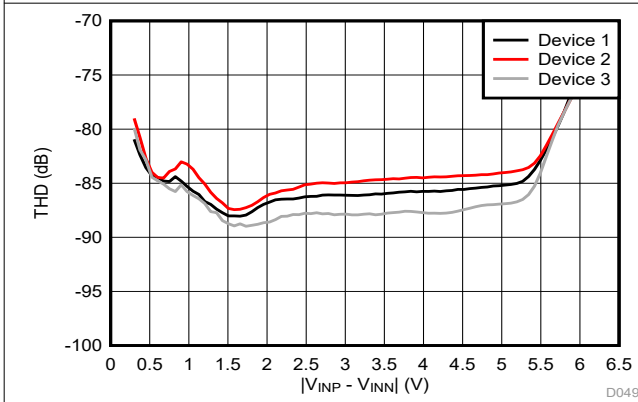

图 6-21. Total Harmonic Distortion vs Low-Side Supply Voltage

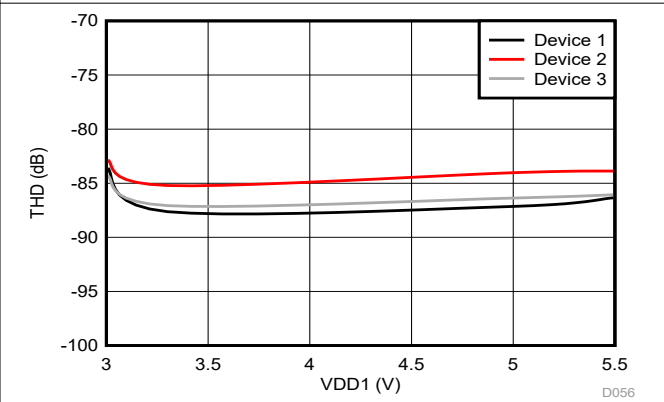

图 6-22. Total Harmonic Distortion vs Temperature

6.13 Typical Characteristics (continued)

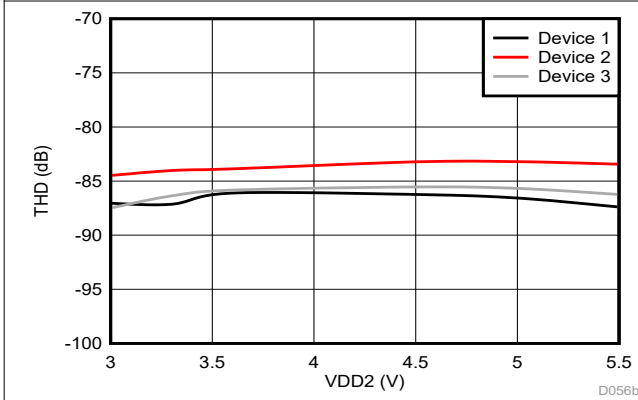
at VDD1 = 5 V, VDD2 = 3.3 V, INN = GND1, INP = - 5 V to 5 V, and $f_{IN} = 10$ kHz (unless otherwise noted)

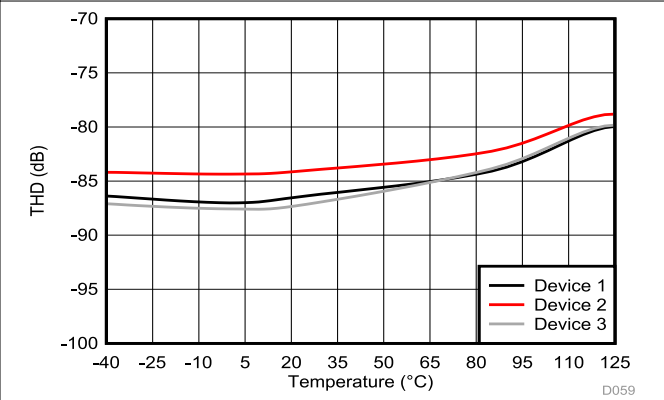

图 6-23. Signal-to-Noise Ratio vs Input Voltage



图 6-24. Signal-to-Noise Ratio vs High-Side Supply Voltage

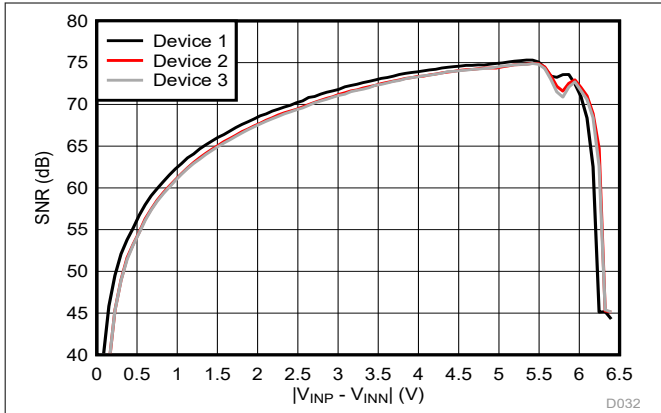

图 6-25. Signal-to-Noise Ratio vs Low-Side Supply Voltage

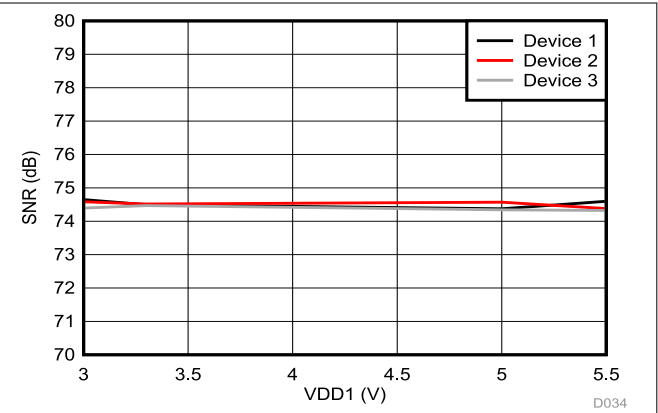

图 6-26. Signal-to-Noise Ratio vs Temperature

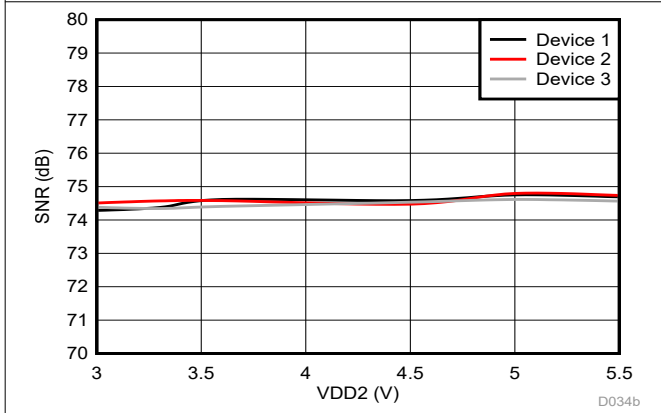

图 6-27. Input-Referred Noise Density vs Frequency

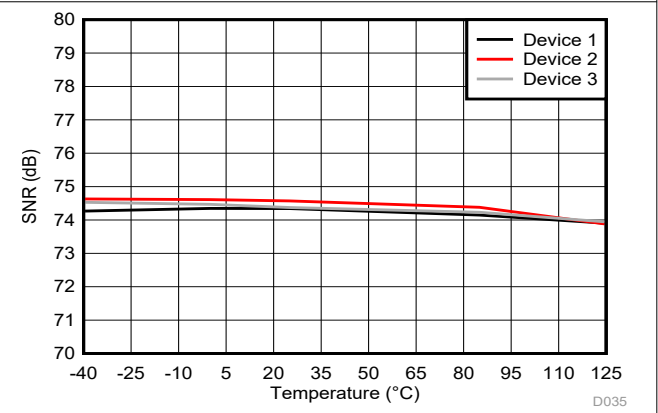

图 6-28. Common-Mode Rejection Ratio vs Supply Voltage

6.13 Typical Characteristics (continued)

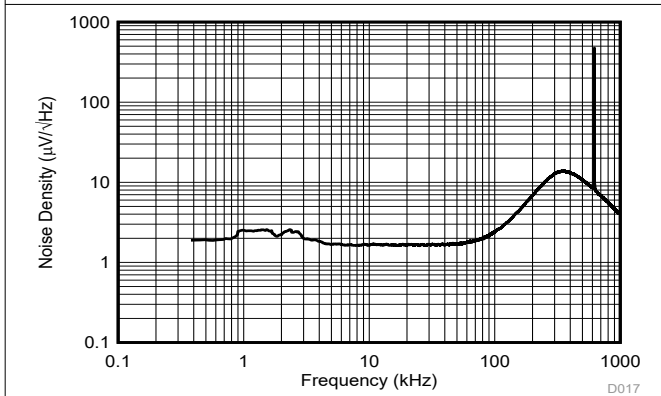
at VDD1 = 5 V, VDD2 = 3.3 V, INN = GND1, INP = -5 V to 5 V, and $f_{IN} = 10$ kHz (unless otherwise noted)

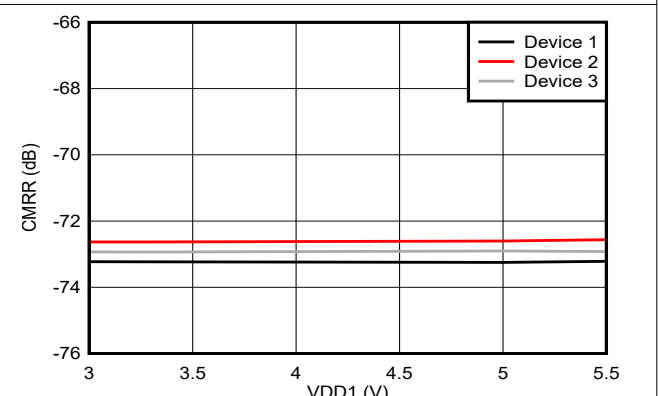

图 6-29. Common-Mode Rejection Ratio vs Input Frequency



图 6-30. Common-Mode Rejection Ratio vs Temperature

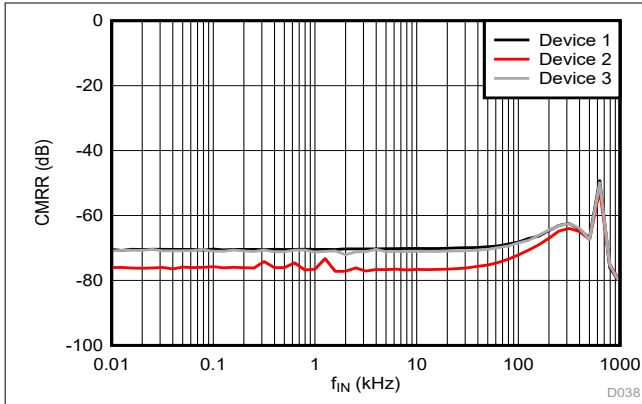

图 6-31. Power-Supply Rejection Ratio vs Ripple Frequency

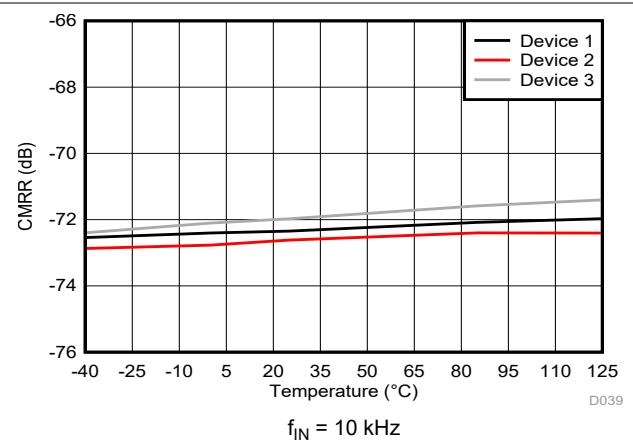

图 6-32. Power-Supply Rejection Ratio vs Temperature

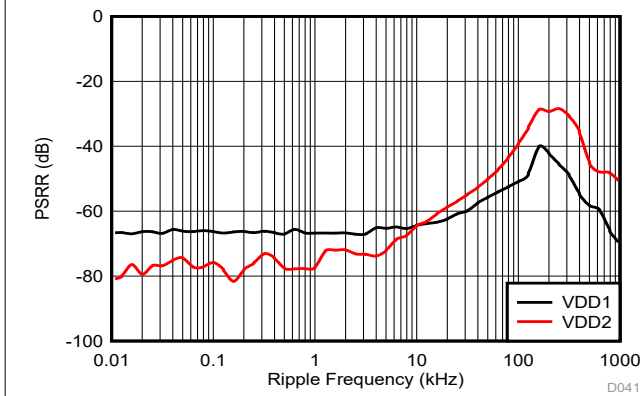

图 6-33. Common-Mode Output Voltage vs Supply Voltage

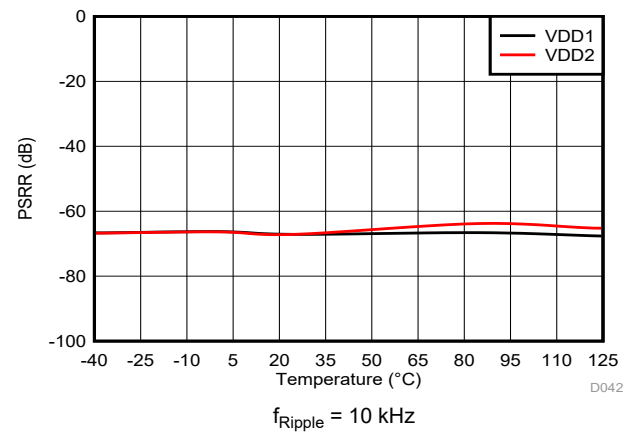

图 6-34. Common-Mode Output Voltage vs Temperature

6.13 Typical Characteristics (continued)

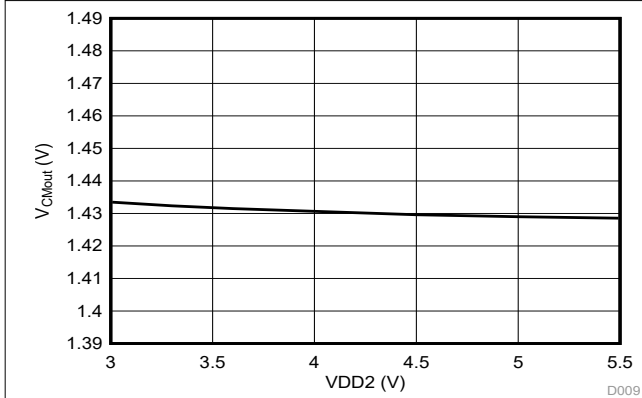
at VDD1 = 5 V, VDD2 = 3.3 V, INN = GND1, INP = -5 V to 5 V, and $f_{IN} = 10$ kHz (unless otherwise noted)

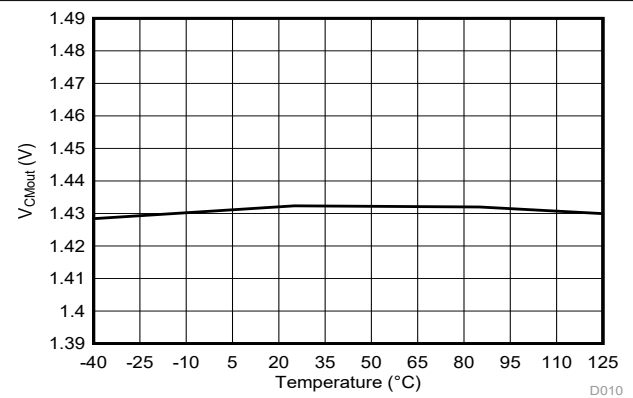

图 6-35. Normalized Gain vs Input Frequency



图 6-36. Output Phase vs Input Frequency

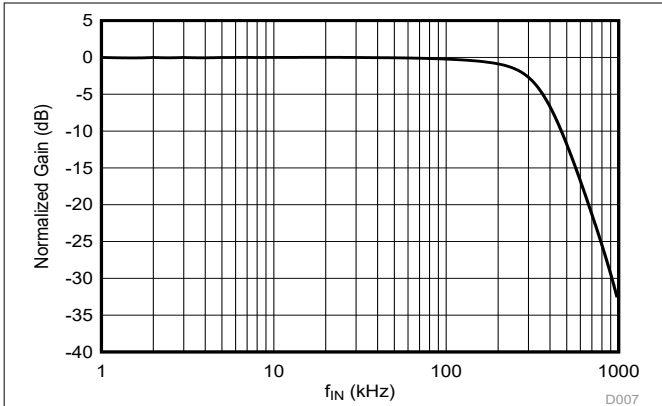

图 6-37. Bandwidth vs Supply Voltage

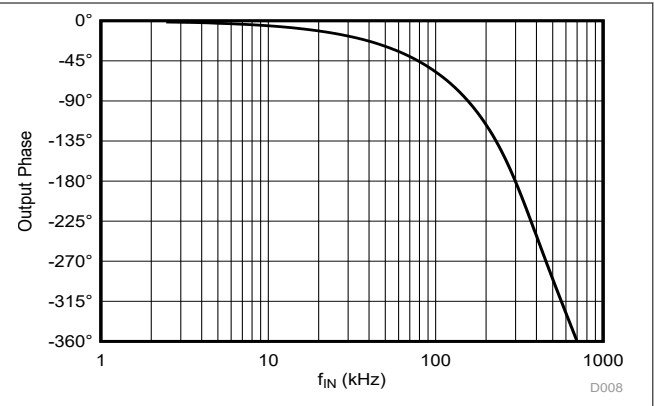

图 6-38. Bandwidth vs Temperature

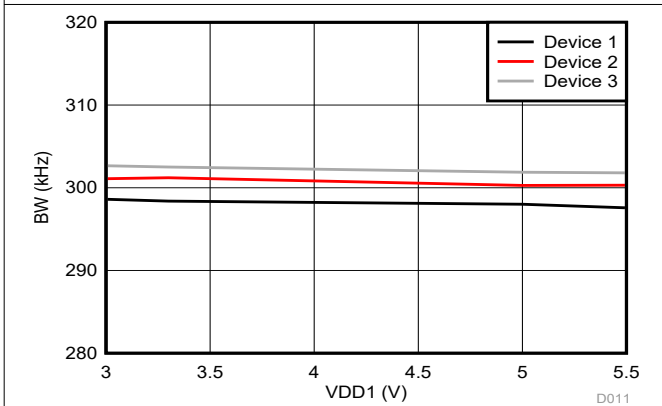

图 6-39. Supply Current vs Supply Voltage

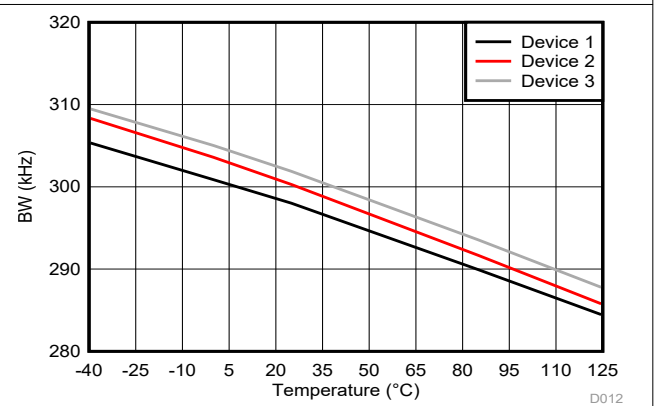

图 6-40. Supply Current vs Temperature

6.13 Typical Characteristics (continued)

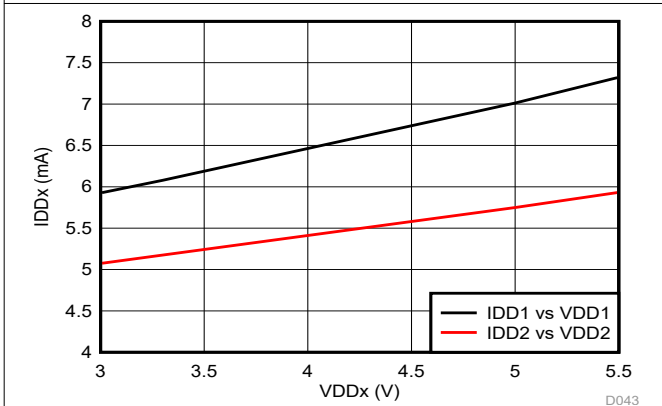
at VDD1 = 5 V, VDD2 = 3.3 V, INN = GND1, INP = - 5 V to 5 V, and $f_{IN} = 10$ kHz (unless otherwise noted)

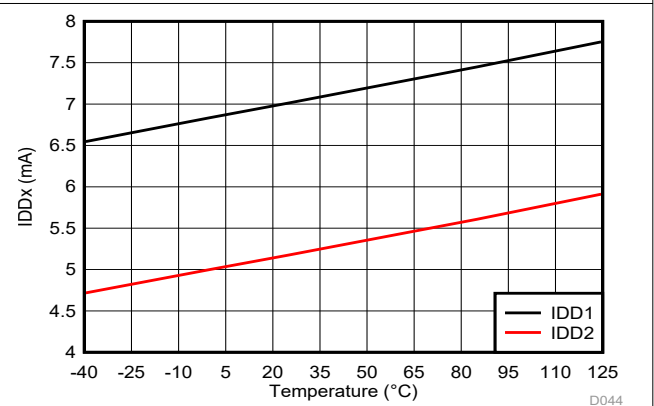

图 6-41. Output Rise and Fall Time vs Supply Voltage



图 6-42. Output Rise and Fall Time vs Temperature

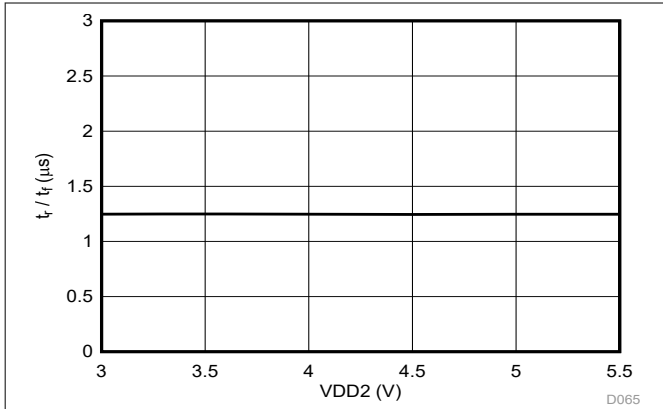

图 6-43. Input to Output Signal Delay vs Supply Voltage

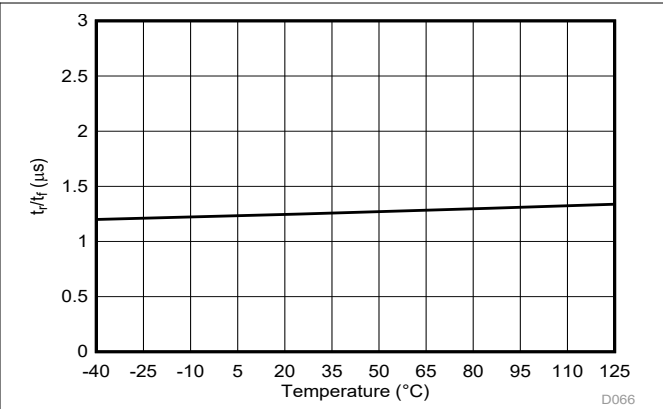

图 6-44. Input to Output Signal Delay vs Temperature

7 Detailed Description

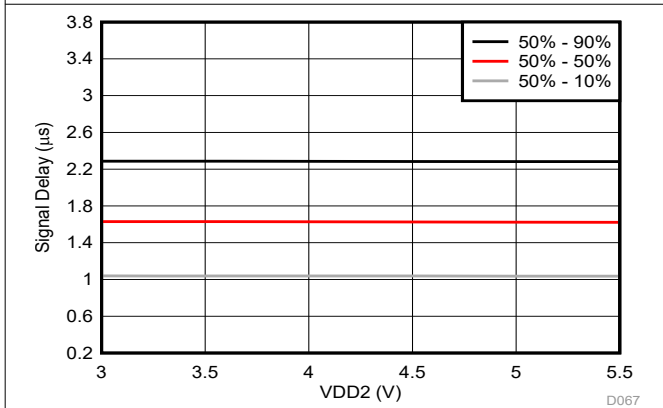
7.1 Overview

The AMC1350 is a fully differential, precision, isolated amplifier with high input impedance. The input stage of the device consists of a fully differential amplifier that drives a second-order, delta-sigma ($\Delta\Sigma$) modulator. The modulator converts the analog input signal into a digital bitstream that is transferred across the isolation barrier that separates the high-side from the low-side. On the low-side, the received bitstream is processed by a fourth-order analog filter that outputs a differential signal at the OUTP and OUTN pins proportional to the input signal.

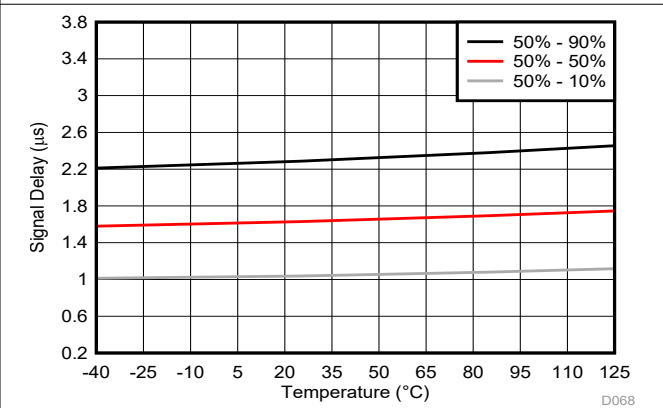
The SiO₂-based, capacitive isolation barrier supports a high level of magnetic field immunity, as described in the [ISO72x Digital Isolator Magnetic-Field Immunity application report](#). The digital modulation used in the AMC1350 to transmit data across the isolation barrier, and the isolation barrier characteristics itself, result in high reliability and common-mode transient immunity.

7.2 Functional Block Diagram

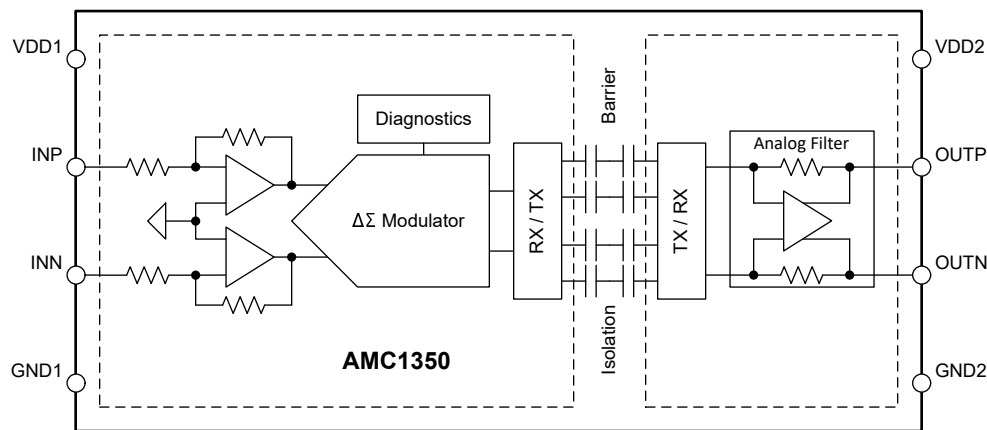

7.3 Feature Description

7.3.1 Analog Input

The single-ended, high-impedance input stage of the AMC1350 feeds a second-order, switched-capacitor, feed-forward $\Delta\Sigma$ modulator. The modulator converts the analog signal into a bitstream that is transferred across the isolation barrier, as described in the [Isolation Channel Signal Transmission](#) section.

There are two restrictions on the analog input signals INP and INN. First, if the input voltages V_{INP} or V_{INN} exceed the range specified in the [Absolute Maximum Ratings](#) table, the input currents must be limited to the absolute maximum value because the electrostatic discharge (ESD) protection turns on. In addition, the linearity and parametric performance of the device are ensured only when the analog input voltage remains within the linear full-scale range (V_{FSR}) and within the common-mode input voltage range (V_{CM}) as specified in the [Recommended Operating Conditions](#) table.

7.3.2 Isolation Channel Signal Transmission

The AMC1350 uses an on-off keying (OOK) modulation scheme, as shown in [图 7-1](#), to transmit the modulator output bitstream across the SiO₂-based isolation barrier. The transmit driver (TX) shown in the [Functional Block Diagram](#) transmits an internally-generated, high-frequency carrier across the isolation barrier to represent a digital *one* and does not send a signal to represent a digital *zero*. The nominal frequency of the carrier used inside the AMC1350 is 480 MHz.

The receiver (RX) on the other side of the isolation barrier recovers and demodulates the signal and provides the input to the fourth-order analog filter. The AMC1350 transmission channel is optimized to achieve the highest level of common-mode transient immunity (CMTI) and lowest level of radiated emissions caused by the high-frequency carrier and RX/TX buffer switching.



图 7-1. OOK-Based Modulation Scheme

7.3.3 Analog Output

The AMC1350 offers a differential analog output on the OOUTP and OOUTN pins. For differential input voltages ($V_{INP} - V_{INN}$) in the range from -5 V to $+5\text{ V}$, the device provides a linear response with a nominal gain of 0.4 V/V . For example, for a differential input voltage of 5 V , the differential output voltage ($V_{OOUTP} - V_{OOUTN}$) is 2 V . At zero input (INP shorted to INN), both pins output the same common-mode output voltage V_{CMout} , as specified in the [Electrical Characteristics](#) table. For absolute differential input voltages greater than 5 V but less than 5.75 V , the differential output voltage continues to increase in magnitude but with reduced linearity performance. The outputs saturate at a differential output voltage of $V_{CLIPout}$, as shown in [Figure 7-2](#), if the differential input voltage exceeds the $V_{Clipping}$ value.

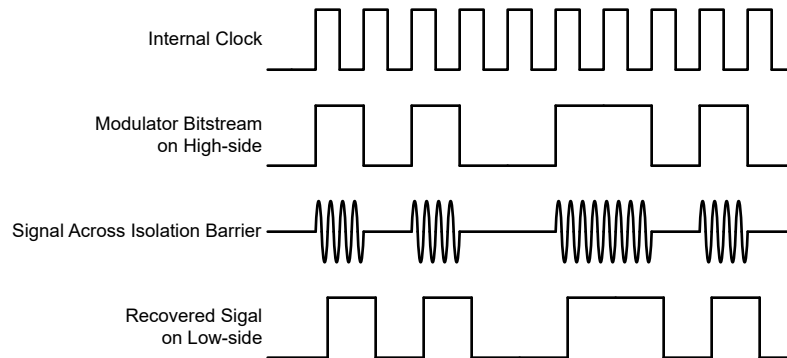

图 7-2. Output Behavior of the AMC1350

The AMC1350 output offers a fail-safe feature that simplifies diagnostics on a system level. [Figure 7-2](#) shows the fail-safe condition, in which the AMC1350 outputs a negative differential output voltage that does not occur under normal operating conditions. The fail-safe output is active in two cases:

- When the high-side supply VDD1 of the AMC1350 device is missing
- When the high-side supply VDD1 falls below the undervoltage threshold $VDD1_{UV}$

Use the maximum $V_{Fail-safe}$ voltage specified in the [Electrical Characteristics](#) table as a reference value for fail-safe detection on a system level.

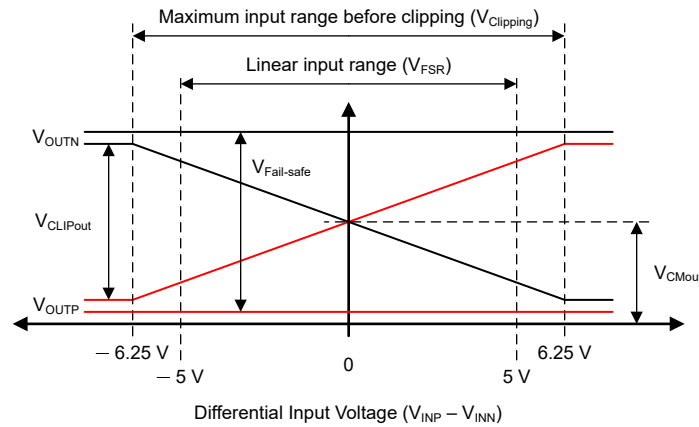
7.4 Device Functional Modes

The AMC1350 is operational when the power supplies VDD1 and VDD2 are applied as specified in the [Recommended Operating Conditions](#) table.

8 Application and Implementation

备注

Information in the following applications sections is not part of the TI component specification, and TI does not warrant its accuracy or completeness. TI's customers are responsible for determining suitability of components for their purposes, as well as validating and testing their design implementation to confirm system functionality.

8.1 Application Information

The high input impedance, low input bias current, bipolar input voltage range, excellent accuracy, and low temperature drift make the AMC1350 a high-performance solution for industrial applications where isolated AC or DC voltage sensing is required.

8.2 Typical Application

Isolated amplifiers are widely used for voltage measurements in high-voltage applications that must be isolated from a low-voltage domain. Typical applications are AC line voltage measurements, either line-to-neutral or line-to-line in grid-connected equipment.

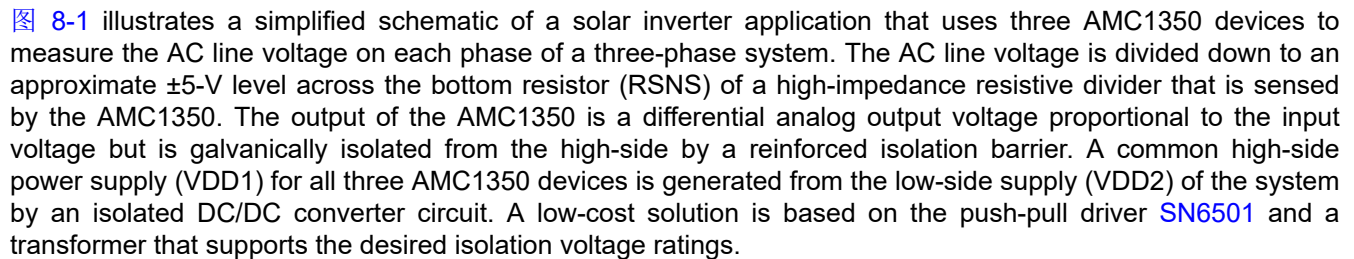
 **图 8-1** illustrates a simplified schematic of a solar inverter application that uses three AMC1350 devices to measure the AC line voltage on each phase of a three-phase system. The AC line voltage is divided down to an approximate ± 5 -V level across the bottom resistor (RSNS) of a high-impedance resistive divider that is sensed by the AMC1350. The output of the AMC1350 is a differential analog output voltage proportional to the input voltage but is galvanically isolated from the high-side by a reinforced isolation barrier. A common high-side power supply (VDD1) for all three AMC1350 devices is generated from the low-side supply (VDD2) of the system by an isolated DC/DC converter circuit. A low-cost solution is based on the push-pull driver [SN6501](#) and a transformer that supports the desired isolation voltage ratings.

The high-impedance input, high input voltage range, and the high common-mode transient immunity (CMTI) of the AMC1350 ensure reliable and accurate operation even in high-noise environments.



图 8-1. Using the AMC1350 for AC Line-Voltage Sensing in a Solar Inverter Application

8.2.1 Design Requirements

表 8-1 lists the parameters for this typical application.

表 8-1. Design Requirements

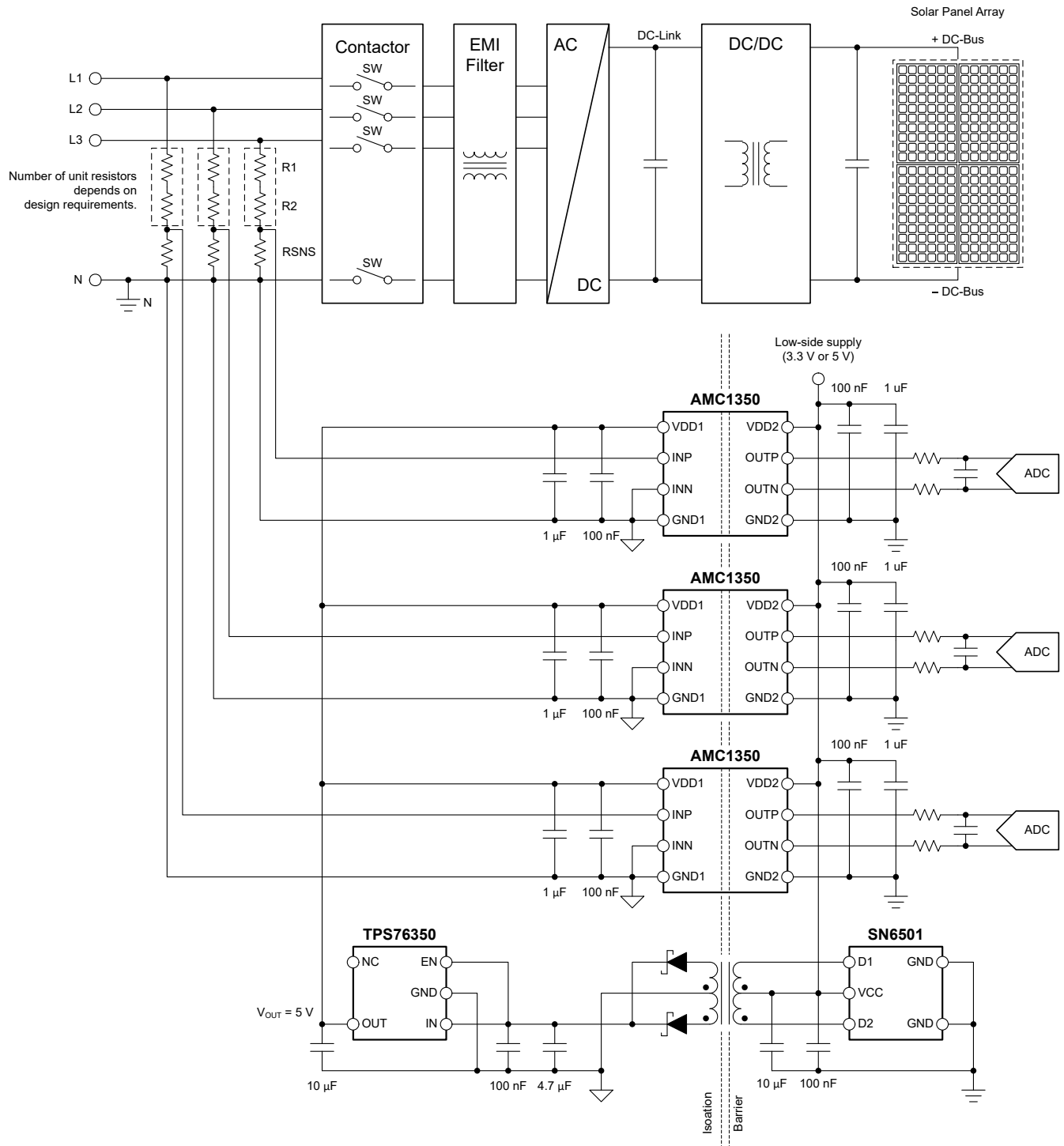
PARAMETER	120-V _{RMS} LINE VOLTAGE	230-V _{RMS} LINE VOLTAGE
System input voltage	120 V ±10%, 60 Hz	230 V ±10%, 50 Hz
High-side supply voltage	3.3 V or 5 V	3.3 V or 5 V
Low-side supply voltage	3.3 V or 5 V	3.3 V or 5 V
Maximum resistor operating voltage	75 V	75 V
Voltage drop across the sense resistor (RSNS) for a linear response	±5 V (maximum)	±5 V (maximum)
Current through the resistive divider, I _{CROSS}	100 μA	100 μA

8.2.2 Detailed Design Procedure

This discussion covers the 230-V_{RMS} example. The procedure for calculating the resistive divider for the 120-V_{RMS} use case is identical.

The 100-μA, cross-current requirement at peak input voltage (360 V) determines that the total impedance of the resistive divider is 3.6 MΩ. The impedance of the resistive divider is dominated by the top resistors (shown exemplary as R1 and R2 in 图 8-1) and the voltage drop across RSNS can be neglected for a short time. The maximum allowed voltage drop per unit resistor is specified as 75 V; therefore, the total minimum number of unit resistors in the top portion of the resistive divider is 360 V / 75 V = 5. The calculated unit value is 3.6 MΩ / 5 = 720 kΩ and the next closest value from the E96 series is 715 kΩ.

The *effective* sense resistor value RSNS_{EFF} is the parallel combination of the external resistor RSNS and the input impedance of the AMC1350, R_{IN}. RSNS_{EFF} is sized such that the voltage drop across the impedance at maximum input voltage (360 V) equals the linear full-scale input voltage (V_{FSR}) of the AMC1350 (that is, +5 V). RSNS_{EFF} is calculated as $RSNS_{EFF} = V_{FSR} / (V_{Peak} - V_{FSR}) \times R_{TOP}$ where R_{TOP} is the total value of the top resistor string (5 × 715 kΩ = 3575 kΩ). The resulting value for RSNS_{EFF} is 9.96 kΩ. In a final step, RSNS is calculated as $RSNS = R_{IN} \times RSNS_{EFF} / (R_{IN} - RSNS_{EFF})$. With R_{IN} = 1.25 MΩ (typical), RSNS equals 52.47 kΩ and the next closest value from the E96 series is 52.3 kΩ.

表 8-2 summarizes the design of the resistive divider.

表 8-2. Resistor Value Examples

PARAMETER	120-V _{RMS} LINE VOLTAGE	230-V _{RMS} LINE VOLTAGE
Peak voltage	190 V	360 V
Unit resistor value, R _{TOP}	634 kΩ	715 kΩ
Number of unit resistors in R _{TOP}	3	5
Sense resistor value, RSNS	53.6 kΩ	52.3 kΩ
Total resistance value (R _{TOP} + RSNS)	1953.4 kΩ	3625.2 kΩ
Resulting current through resistive divider, I _{CROSS}	97.3 μA	99.3 μA
Resulting full-scale voltage drop across sense resistor RSNS	4.993 V	4.982 V
Peak power dissipated in R _{TOP} unit resistor	6 mW	7.1 mW
Total peak power dissipated in resistive divider	18.5 mW	35.7 mW

8.2.2.1 Input Filter Design

Placing an RC filter in front of the isolated amplifier improves signal-to-noise performance of the signal path. In practice, however, the impedance of the resistor divider is so high that adding a filter capacitor on the INN or INP pin limits the signal bandwidth to an unacceptable low limit, such that the filter capacitor is omitted. When used, design the input filter such that:

- The cutoff frequency of the filter is at least one order of magnitude lower than the sampling frequency (20 MHz) of the internal $\Delta \Sigma$ modulator
- The input bias current does not generate significant voltage drop across the DC impedance of the input filter

Most voltage-sensing applications use high-impedance resistor dividers in front of the isolated amplifier to scale down the input voltage. In that case, no additional resistor is needed and a single capacitor (as shown in [图 8-2](#)) is sufficient to filter the input signal.



图 8-2. Input Filter

8.2.2.2 Differential to Single-Ended Output Conversion

[图 8-3](#) shows an example of a TLV6001-based signal conversion and filter circuit for systems using single-ended input ADCs to convert the analog output voltage into digital. With $R1 = R2 = R3 = R4$, the output voltage equals $(V_{OUTP} - V_{OUTN}) + V_{REF}$. Tailor the bandwidth of this filter stage to the bandwidth requirement of the system and use NP0-type capacitors for best performance. For most applications, $R1 = R2 = R3 = R4 = 3.3 \text{ k}\Omega$ and $C1 = C2 = 330 \text{ pF}$ yields good performance.

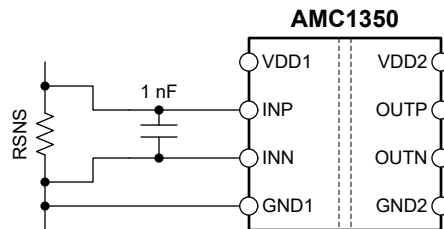

图 8-3. Connecting the AMC1350 Output to a Single-Ended Input ADC

For more information on the general procedure to design the filtering and driving stages of SAR ADCs, see the [18-Bit, 1MSPS Data Acquisition Block \(DAQ\) Optimized for Lowest Distortion and Noise](#) and [18-Bit Data Acquisition Block \(DAQ\) Optimized for Lowest Power](#) reference guides, available for download at www.ti.com.

8.2.3 Application Curve

One important aspect of system design is the effective detection of an overvoltage condition to protect switching devices and passive components from damage. To power off the system quickly in the event of an overvoltage condition, a low delay caused by the isolated amplifier is required. 图 8-4 shows the typical full-scale step response of the AMC1350.

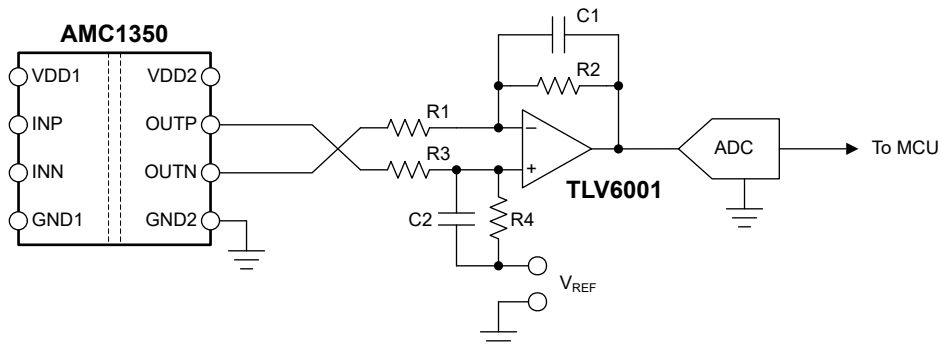

图 8-4. Step Response of the AMC1350

8.3 What To Do and What Not To Do

Do not leave the inputs of the AMC1350 unconnected (floating) when the device is powered up. If the device inputs are left floating, the input bias current may drive the inputs to a positive or negative value that exceeds the operating common-mode input voltage and the device output is undetermined.

Connect the high-side ground (GND1) to INN, either by a hard short or through a resistive path. A DC current path between INN and GND1 is required to define the input common-mode voltage. Take care not to exceed the input common-mode range as specified in the [Recommended Operating Conditions](#) table. For best accuracy, route the ground connection as a separate trace that connects directly to the sense resistor rather than shorting GND1 to INN directly at the input to the device. See the [Layout](#) section for more details.

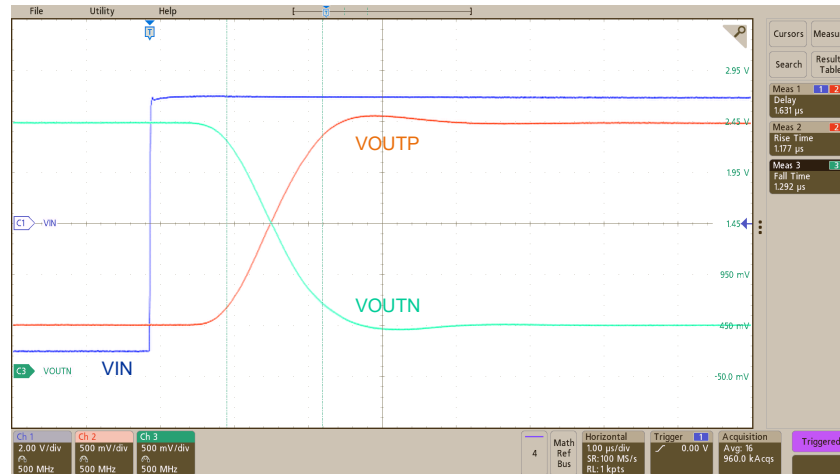
Do not connect protection diodes to the inputs (INP or INN) of the AMC1350. Diode leakage current can introduce significant measurement error especially at high temperatures. The input pin is protected against high voltages by its ESD protection circuit and the high impedance of the external resistive divider.

9 Power Supply Recommendations

In a typical application, the high-side power supply (VDD1) for the AMC1350 is generated from the low-side supply (VDD2) by an isolated DC/DC converter. A low-cost solution is based on the push-pull driver [SN6501](#) and a transformer that supports the desired isolation voltage ratings.

The AMC1350 does not require any specific power-up sequencing. The high-side power supply (VDD1) is decoupled with a low-ESR, 100-nF capacitor (C1) parallel to a low-ESR, 1- μ F capacitor (C2). The low-side power supply (VDD2) is equally decoupled with a low-ESR, 100-nF capacitor (C3) parallel to a low-ESR, 1- μ F capacitor (C4). Place all four capacitors (C1, C2, C3, and C4) as close to the device as possible. [Figure 9-1](#) shows a decoupling diagram for the AMC1350.





图 9-1. Decoupling of the AMC1350

Capacitors must provide adequate effective capacitance under the applicable DC bias conditions they experience in the application. Multilayer ceramic capacitors (MLCC) typically exhibit only a fraction of their nominal capacitance under real-world conditions and this factor must be taken into consideration when selecting these capacitors. This problem is especially acute in low-profile capacitors, in which the dielectric field strength is higher than in taller components. Reputable capacitor manufacturers provide capacitance versus DC bias curves that greatly simplify component selection.

10 Layout

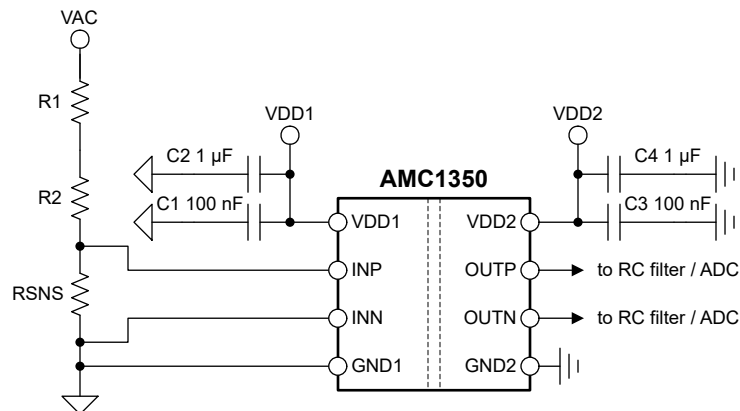
10.1 Layout Guidelines

 10-1 shows a layout recommendation with the critical placement of the decoupling capacitors (as close as possible to the AMC1350 supply pins) and placement of the other components required by the device. For best performance, place the sense resistor close to the device input pin (IN).

10.2 Layout Example

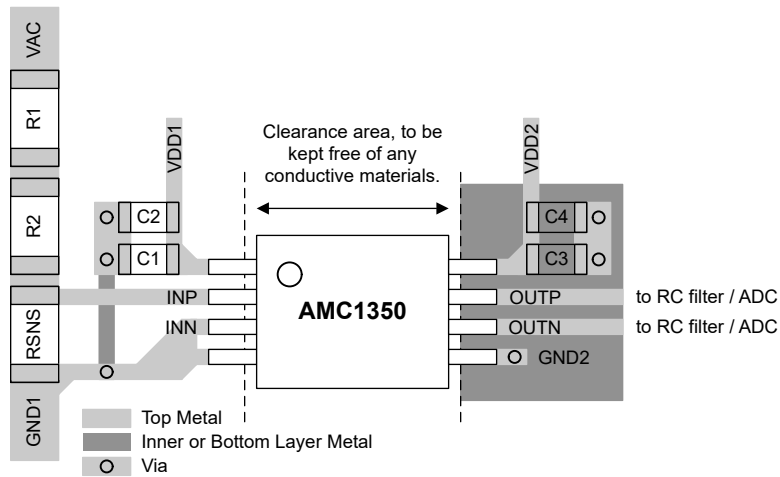

 10-1. Recommended Layout of the AMC1350

11 Device and Documentation Support

11.1 Documentation Support

11.1.1 Related Documentation

For related documentation, see the following:

- Texas Instruments, [Isolation Glossary application report](#)
- Texas Instruments, [Semiconductor and IC Package Thermal Metrics application report](#)
- Texas Instruments, [ISO72x Digital Isolator Magnetic-Field Immunity application report](#)
- Texas Instruments, [TLV600x Low-Power, Rail-to-Rail In/Out, 1-MHz Operational Amplifier for Cost-Sensitive Systems data sheet](#)
- Texas Instruments, [TPS763 Low-Power, 150-mA, Low-Dropout Linear Regulator data sheet](#)
- Texas Instrument, [SN6501 Transformer Driver for Isolated Power Supplies data sheet](#)
- Texas Instruments, [18-Bit, 1-MSPS Data Acquisition Block \(DAQ\) Optimized for Lowest Distortion and Noise reference guide](#)
- Texas Instruments, [18-Bit, 1-MSPS Data Acquisition Block \(DAQ\) Optimized for Lowest Power reference guide](#)
- Texas Instruments, [Isolated Amplifier Voltage Sensing Excel Calculator design tool](#)
- Texas Instruments, [Best in Class Radiated Emissions EMI Performance with the AMC1300B-Q1 Isolated Amplifier technical white paper](#)

11.2 接收文档更新通知

要接收文档更新通知，请导航至 ti.com 上的器件产品文件夹。点击 [订阅更新](#) 进行注册，即可每周接收产品信息更改摘要。有关更改的详细信息，请查看任何已修订文档中包含的修订历史记录。

11.3 支持资源

TI E2E™ 支持论坛是工程师的重要参考资料，可直接从专家获得快速、经过验证的解答和设计帮助。搜索现有解答或提出自己的问题可获得所需的快速设计帮助。

链接的内容由各个贡献者“按原样”提供。这些内容并不构成 TI 技术规范，并且不一定反映 TI 的观点；请参阅 TI 的《使用条款》。

11.4 Trademarks

TI E2E™ is a trademark of Texas Instruments.

所有商标均为其各自所有者的财产。

11.5 Electrostatic Discharge Caution



This integrated circuit can be damaged by ESD. Texas Instruments recommends that all integrated circuits be handled with appropriate precautions. Failure to observe proper handling and installation procedures can cause damage.

ESD damage can range from subtle performance degradation to complete device failure. Precision integrated circuits may be more susceptible to damage because very small parametric changes could cause the device not to meet its published specifications.

11.6 术语表

[TI 术语表](#) 本术语表列出并解释了术语、首字母缩略词和定义。

Mechanical, Packaging, and Orderable Information

The following pages include mechanical, packaging, and orderable information. This information is the most current data available for the designated devices. This data is subject to change without notice and revision of this document. For browser-based versions of this data sheet, refer to the left-hand navigation.

PACKAGING INFORMATION

Orderable Device	Status (1)	Package Type	Package Drawing	Pins	Package Qty	Eco Plan (2)	Lead finish/ Ball material (6)	MSL Peak Temp (3)	Op Temp (°C)	Device Marking (4/5)	Samples
AMC1350DWV	ACTIVE	SOIC	DWV	8	64	RoHS & Green	NIPDAU	Level-3-260C-168 HR	-40 to 125	AMC1350	Samples
AMC1350DWVR	ACTIVE	SOIC	DWV	8	1000	RoHS & Green	NIPDAU	Level-3-260C-168 HR	-40 to 125	AMC1350	Samples

(1) The marketing status values are defined as follows:

ACTIVE: Product device recommended for new designs.

LIFEBUY: TI has announced that the device will be discontinued, and a lifetime-buy period is in effect.

NRND: Not recommended for new designs. Device is in production to support existing customers, but TI does not recommend using this part in a new design.

PREVIEW: Device has been announced but is not in production. Samples may or may not be available.

OBSOLETE: TI has discontinued the production of the device.

(2) **RoHS:** TI defines "RoHS" to mean semiconductor products that are compliant with the current EU RoHS requirements for all 10 RoHS substances, including the requirement that RoHS substance do not exceed 0.1% by weight in homogeneous materials. Where designed to be soldered at high temperatures, "RoHS" products are suitable for use in specified lead-free processes. TI may reference these types of products as "Pb-Free".

RoHS Exempt: TI defines "RoHS Exempt" to mean products that contain lead but are compliant with EU RoHS pursuant to a specific EU RoHS exemption.

Green: TI defines "Green" to mean the content of Chlorine (Cl) and Bromine (Br) based flame retardants meet JS709B low halogen requirements of <=1000ppm threshold. Antimony trioxide based flame retardants must also meet the <=1000ppm threshold requirement.

(3) MSL, Peak Temp. - The Moisture Sensitivity Level rating according to the JEDEC industry standard classifications, and peak solder temperature.

(4) There may be additional marking, which relates to the logo, the lot trace code information, or the environmental category on the device.

(5) Multiple Device Markings will be inside parentheses. Only one Device Marking contained in parentheses and separated by a "~" will appear on a device. If a line is indented then it is a continuation of the previous line and the two combined represent the entire Device Marking for that device.

(6) Lead finish/Ball material - Orderable Devices may have multiple material finish options. Finish options are separated by a vertical ruled line. Lead finish/Ball material values may wrap to two lines if the finish value exceeds the maximum column width.

Important Information and Disclaimer:The information provided on this page represents TI's knowledge and belief as of the date that it is provided. TI bases its knowledge and belief on information provided by third parties, and makes no representation or warranty as to the accuracy of such information. Efforts are underway to better integrate information from third parties. TI has taken and continues to take reasonable steps to provide representative and accurate information but may not have conducted destructive testing or chemical analysis on incoming materials and chemicals. TI and TI suppliers consider certain information to be proprietary, and thus CAS numbers and other limited information may not be available for release.

In no event shall TI's liability arising out of such information exceed the total purchase price of the TI part(s) at issue in this document sold by TI to Customer on an annual basis.

TAPE AND REEL INFORMATION

QUADRANT ASSIGNMENTS FOR PIN 1 ORIENTATION IN TAPE

*All dimensions are nominal

Device	Package Type	Package Drawing	Pins	SPQ	Reel Diameter (mm)	Reel Width W1 (mm)	A0 (mm)	B0 (mm)	K0 (mm)	P1 (mm)	W (mm)	Pin1 Quadrant
AMC1350DWVR	SOIC	DWV	8	1000	330.0	16.4	12.05	6.15	3.3	16.0	16.0	Q1

TAPE AND REEL BOX DIMENSIONS

*All dimensions are nominal

Device	Package Type	Package Drawing	Pins	SPQ	Length (mm)	Width (mm)	Height (mm)
AMC1350DWVR	SOIC	DWV	8	1000	350.0	350.0	43.0

TUBE

*All dimensions are nominal

Device	Package Name	Package Type	Pins	SPQ	L (mm)	W (mm)	T (μm)	B (mm)
AMC1350DWV	DWV	SOIC	8	64	505.46	13.94	4826	6.6

PACKAGE OUTLINE

DWV0008A



SOIC - 2.8 mm max height

SOIC

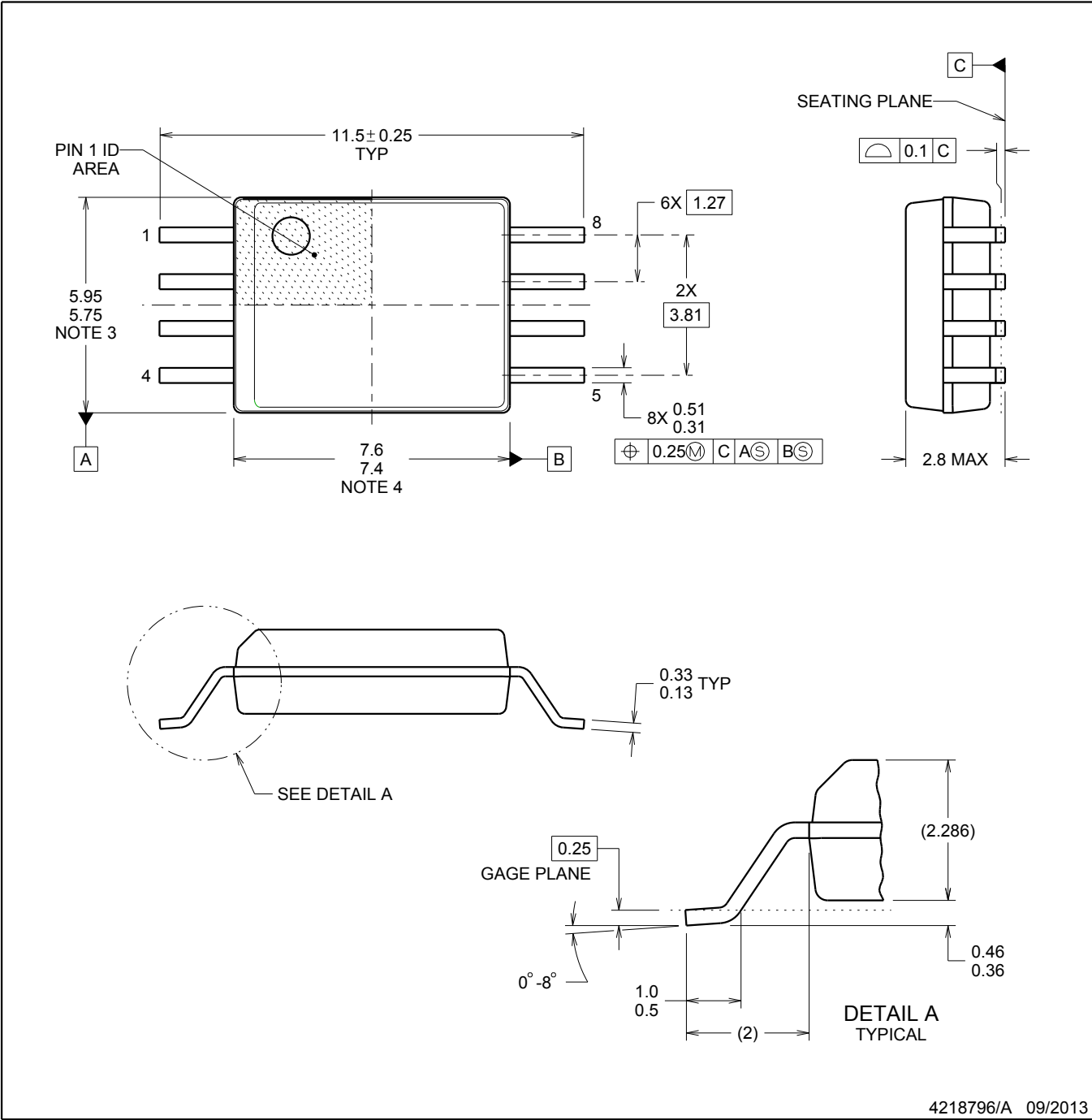

4218796/A 09/2013

NOTES:

1. All linear dimensions are in millimeters. Dimensions in parenthesis are for reference only. Dimensioning and tolerancing per ASME Y14.5M.
2. This drawing is subject to change without notice.
3. This dimension does not include mold flash, protrusions, or gate burrs. Mold flash, protrusions, or gate burrs shall not exceed 0.15 mm, per side.
4. This dimension does not include interlead flash. Interlead flash shall not exceed 0.25 mm, per side.

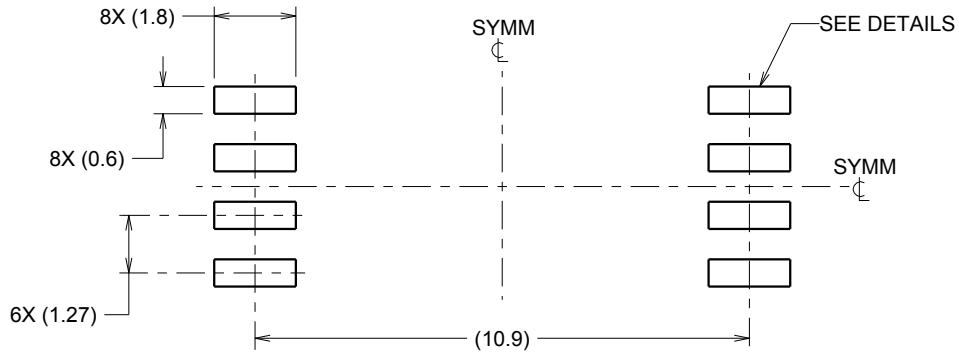

LAND PATTERN EXAMPLE
9.1 mm NOMINAL CLEARANCE/CREEPAGE
SCALE:6X

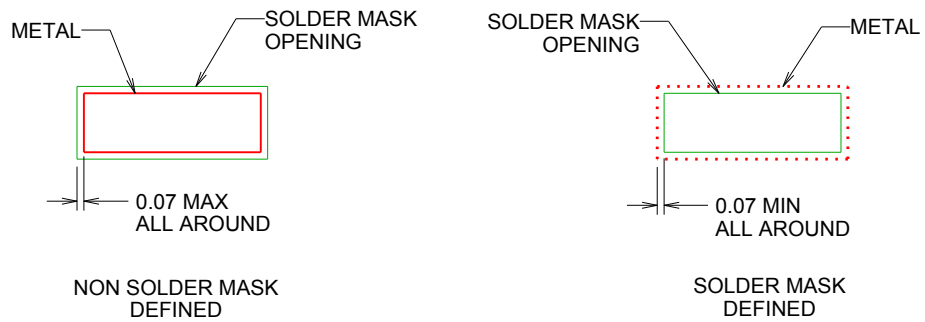

SOLDER MASK DETAILS

4218796/A 09/2013

NOTES: (continued)

- 5. Publication IPC-7351 may have alternate designs.
- 6. Solder mask tolerances between and around signal pads can vary based on board fabrication site.

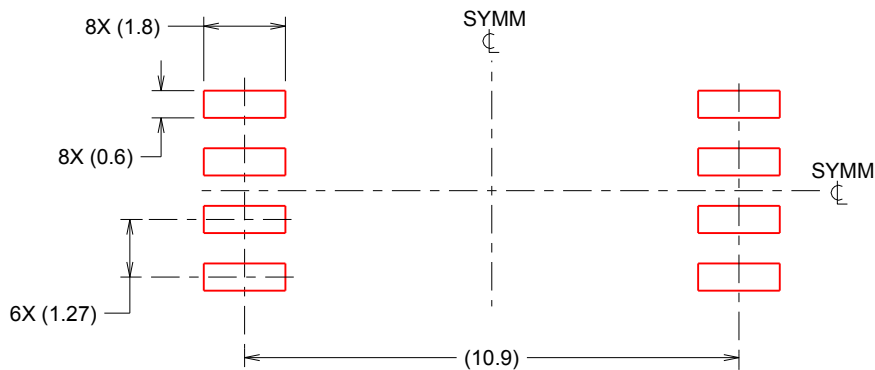

SOLDER PASTE EXAMPLE
 BASED ON 0.125 mm THICK STENCIL
 SCALE:6X

4218796/A 09/2013

NOTES: (continued)

- 7. Laser cutting apertures with trapezoidal walls and rounded corners may offer better paste release. IPC-7525 may have alternate design recommendations.
- 8. Board assembly site may have different recommendations for stencil design.

重要声明和免责声明

TI“按原样”提供技术和可靠性数据（包括数据表）、设计资源（包括参考设计）、应用或其他设计建议、网络工具、安全信息和其他资源，不保证没有瑕疵且不做任何明示或暗示的担保，包括但不限于对适销性、某特定用途方面的适用性或不侵犯任何第三方知识产权的暗示担保。

这些资源可供使用 TI 产品进行设计的熟练开发人员使用。您将自行承担以下全部责任：(1) 针对您的应用选择合适的 TI 产品，(2) 设计、验证并测试您的应用，(3) 确保您的应用满足相应标准以及任何其他功能安全、信息安全、监管或其他要求。

这些资源如有变更，恕不另行通知。TI 授权您仅可将这些资源用于研发本资源所述的 TI 产品的应用。严禁对这些资源进行其他复制或展示。您无权使用任何其他 TI 知识产权或任何第三方知识产权。您应全额赔偿因在这些资源的使用中对 TI 及其代表造成的任何索赔、损害、成本、损失和债务，TI 对此概不负责。

TI 提供的产品受 [TI 的销售条款](#) 或 [ti.com](#) 上其他适用条款/TI 产品随附的其他适用条款的约束。TI 提供这些资源并不会扩展或以其他方式更改 TI 针对 TI 产品发布的适用的担保或担保免责声明。

TI 反对并拒绝您可能提出的任何其他或不同的条款。

邮寄地址：Texas Instruments, Post Office Box 655303, Dallas, Texas 75265

Copyright © 2023，德州仪器 (TI) 公司