

# 具有 20mA 终止电流和 1A 升压运行的 BQ25618/619 I<sup>2</sup>C 控制型 1.5A 单节电池充电器

## 具有 1.2A 升压运行和输入电压浪涌保护的

### 1 特性

- 单芯片解决方案，、可以通过适配器或电池为可穿戴附件充电
- 高效率、1.5MHz 同步开关模式降压充电器
  - 0.5A 时充电效率为 95.5%，1A 时充电效率为 94.5%
  - $\pm 0.5\%$  充电电压调节 (10mV 阶跃)
  - 充电电压、电流和温度阈值的 I<sup>2</sup>C 可编程 JEITA 曲线
  - 高精度低终止电流 20mA $\pm$ 10mA
  - 2.5 x 2.0 x 1.0mm<sup>3</sup> 的小电感器尺寸
- 升压模式操作，输出电压范围为 4.6V 至 5.15V
  - 在 1A 输出下具有 94% 的升压效率
  - 集成控制功能，可实现充电模式与升压模式间的切换
  - PMID\_GOOD 引脚控制外部 PMOS FET，用于针对故障情况提供保护
- 单个输入，支持 USB 输入以及高电压适配器或无线电源
  - 支持 4V 至 13.5V 输入电压范围，绝对最大输入电压额定值为 22V
  - 通过 I<sup>2</sup>C (100mA 至 3.2A, 100mA/阶跃) 实现可编程输入电流限制 (IINDPM)
  - 通过高达 5.4V 的输入电压限制 (VINDPM) 进行最大功率跟踪
  - 通过 VINDPM 阈值自动跟踪电池电压
- 窄 VDC (NVDC) 电源路径管理
  - 无需电池或使用深度放电的电池即可使系统瞬时启动
- 灵活的 I<sup>2</sup>C 配置和自主充电，可实现出色的系统性能
- 高集成度，包括所有 MOSFET、电流检测和环路补偿
- 低 R<sub>DS(on)</sub> 19.5m $\Omega$  BATFET，可更大程度地降低充电损耗和延长电池运行时间
  - 提供用于运输模式的 BATFET 控制，以及使用和不使用适配器的完全系统复位功能
- 运输模式下具有 7 $\mu$ A 低电池漏电流
- 在系统待机时具有 9.5 $\mu$ A 的低电池漏电流
- 高精度电池充电曲线
  - $\pm 5\%$  充电电流调节
  - $\pm 7.5\%$  输入电流调节
  - 远程电池检测，可更快地进行充电
  - 用于电池完全充电的可编程充电完成计时器
- 安全相关认证：

- 经 IEC 62368-1 CB 认证

### 2 应用

- 消费类可穿戴设备、智能手表
- 个人护理和健身
- 耳麦/耳机
- 耳塞 (真正无线或 TWS) 充电盒
- 助听器充电盒

### 3 说明

BQ25618/619 将充电、升压转换器和电压保护功能集成在单个器件中。该器件为开关充电器提供了业界超低的终止电流，从而以最大电池容量为可穿戴设备充电。BQ25618/619 具有出色的低静态电流，可在运输模式下将电池泄漏降低至 6 $\mu$ A，从而节约电池电量，将器件的货架期延长一倍。BQ25619 采用 4mm x 4mm QFN 封装，以便于布局。BQ25618 采用 2.0mm x 2.4mm WCSP 封装，适用于空间受限的设计。

#### 封装信息

器件型号	封装 <sup>(1)</sup>	封装尺寸 <sup>(2)</sup>	封装尺寸 (标称值)
BQ25618	YFF (DSBGA, 30)	2.20mm x 2.60mm	2.00mm x 2.40mm
BQ25619	RTW (WQFN, 24)	4.00mm x 4.00mm	4.00mm x 4.00mm

(1) 有关所有可用封装，请参阅节 13。

(2) 封装尺寸 (长 x 宽) 为标称值，并包括引脚 (如适用)。

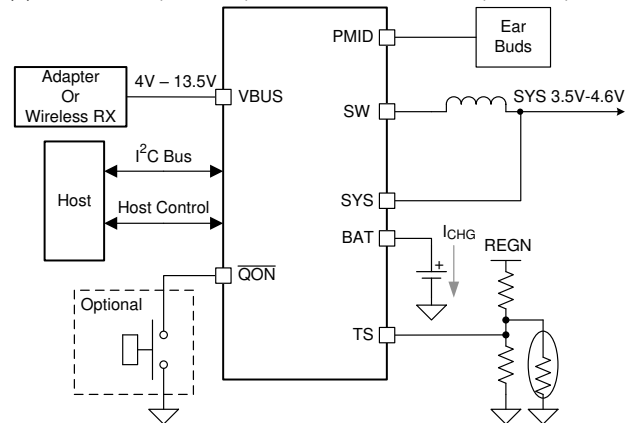

简化版应用



## Table of Contents

<b>1 特性</b> .....	1	7.5 Register Maps.....	33
<b>2 应用</b> .....	1	<b>8 Application and Implementation</b> .....	47
<b>3 说明</b> .....	1	8.1 Application Information.....	47
<b>4 说明 (续)</b> .....	3	8.2 Typical Application.....	47
<b>5 Pin Configuration and Functions</b> .....	4	<b>9 Power Supply Recommendations</b> .....	51
<b>6 Specifications</b> .....	7	<b>10 Layout</b> .....	52
6.1 Absolute Maximum Ratings.....	7	10.1 Layout Guidelines.....	52
6.2 ESD Ratings.....	7	10.2 Layout Example.....	52
6.3 Recommended Operating Conditions.....	7	<b>11 Device and Documentation Support</b> .....	54
6.4 Thermal Information.....	8	11.1 Device Support.....	54
6.5 Thermal Information.....	8	11.2 Documentation Support.....	54
6.6 Electrical Characteristics.....	8	11.3 接收文档更新通知.....	54
6.7 Timing Requirements.....	13	11.4 支持资源.....	54
6.8 Typical Characteristics.....	14	11.5 Trademarks.....	54
<b>7 Detailed Description</b> .....	16	11.6 静电放电警告.....	54
7.1 Overview.....	16	11.7 术语表.....	54
7.2 Functional Block Diagram.....	16	<b>12 Revision History</b> .....	54
7.3 Feature Description.....	17	<b>13 Mechanical, Packaging, and Orderable Information</b> .....	56
7.4 Device Functional Modes.....	31		

## 4 说明 (续)

BQ25619/618 是一款高度集成的 1.5A 开关模式电池充电管理和系统电源路径管理器件，适用于锂离子和锂聚合物电池。它可为可穿戴设备、耳机充电盒等各种应用提供快速充电功能和高输入电压。其低阻抗电源路径对开关模式运行效率进行了优化，缩短了电池充电时间并延长了放电阶段的电池运行时间。其输入电压和电流调节、低终止电流和电池远程检测可以为电池提供最大的充电功率。该解决方案在系统和电池之间高度集成输入反向阻断 FET (RBFET, Q1)、高侧开关 FET (HSFET, Q2)、低侧开关 FET (LSFET, Q3) 以及电池 FET (BATFET, Q4)。它还集成了自举二极管以进行高侧栅极驱动，从而简化系统设计。具有充电和系统设置的 I<sup>2</sup>C 串行接口使该器件成为一个真正灵活的解决方案。

该器件支持多种输入源，包括标准 USB 主机端口、USB 充电端口、兼容 USB 的高电压适配器和无线电源。该器件符合 USB 2.0 和 USB 3.0 电源规格，具有输入电流和电压调节功能。该器件从系统检测电路 (如 USB PHY 器件) 获取结果。

该器件通过单个电感器将降压充电器和升压稳压器集成到一个解决方案中。升压模式在 PMID 引脚上提供 5V (可调 4.6V/4.75V/5V/5.15V) 的电压。升压模式用于节省 BOM，可通过控制 PMID\_GOOD 来为另一个电池充电。PMID\_GOOD 引脚用于驱动外部 PMOS FET，将升压输出 PMID 与所连附件断开。

在应用适配器时，电源路径管理将系统电压调节至稍高于电池电压的水平，但不会降至最小系统电压 3.5V 以下 (可编程)。借助于这个特性，即使在电池电量完全耗尽或者电池被拆除时，系统也能保持运行。当达到输入电流限值或电压限值时，电源路径管理系统会自动减小充电电流。随着系统负载持续增加，电池开始放电，直到满足系统电源需求。该补充模式可防止输入源过载。

此器件无需软件控制即可启动并完成一个充电周期。它感应电池电压并通过三个阶段为电池充电：预充电、恒定电流和恒定电压。在充电周期结束时，当充电电流低于预设限值并且电池电压高于再充电阈值时，充电器自动终止。如果充满电的电池降至再充电阈值以下，则充电器自动开启另一个充电周期。

此充电器提供针对电池充电和系统运行的多种安全特性，其中包括电池负温度系数热敏电阻监视、充电安全性计时器以及过压和过流保护。当结温超过 110°C 时，热调节会减小充电电流。状态寄存器报告充电状态和任何故障状况。通过 I<sup>2</sup>C，VBUS\_GD 位指示电源是否正常，在发生故障时 INT 输出会立即通知主机。

该器件还提供用于 BATFET 使能和复位控制的 QON 引脚，用来退出低功耗运输模式或完全系统复位功能。

BQ25619 器件采用 24 引脚 4mm × 4mm × 0.75mm 薄型 WQFN 封装，BQ25618 采用 30 焊球 2.0mm × 2.4mm WCSP 封装。

## 5 Pin Configuration and Functions



图 5-1. BQ25618 YFF Package 30-Pin WCSP Top View



图 5-2. BQ25619 RTW Package 24-Pin WQFN Top View

**表 5-1. Pin Functions**

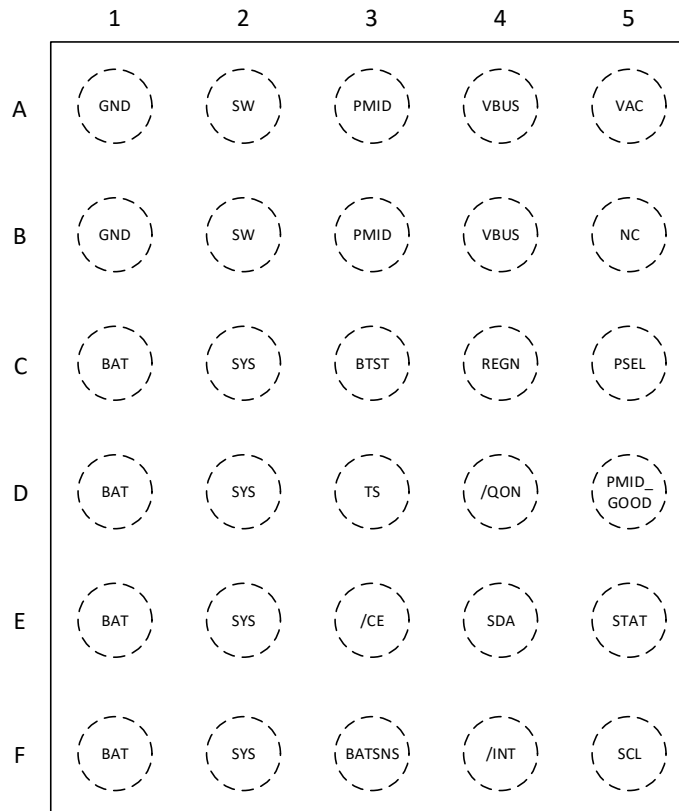
NAME	PIN		TYPE <sup>(1)</sup>	DESCRIPTION
	BQ25618 NO.	BQ25619 NO.		
BAT	C1, D1, E1, F1	13	P	Battery connection point to the positive terminal of the battery pack. The internal current sensing resistor is connected between SYS and BAT. Connect a 10 $\mu$ F closely to the BAT pin.
		14		
BATSNS	F3	10	AIO	Battery voltage sensing pin for charge voltage regulation. In order to minimize the parasitic trace resistance during charging, BATSNS pin is connected to the positive terminal of battery pack as close as possible. If BATSNS pin is open or short to ground, BATSNS_STAT bit is set to 1 and charger regulates the battery voltage through BAT pin.
BTST	C3	21	P	PWM high-side driver positive supply. Internally, the BTST is connected to the cathode of the boot-strap diode. Connect the 0.047- $\mu$ F bootstrap capacitor from SW to BTST.
CE	E3	9	DI	Charge enable pin. When this pin is driven LOW, battery charging is enabled.
GND	A1, B1	17	P	Ground
		18		
INT	F4	7	DO	Open-drain interrupt output. Connect the $\overline{\text{INT}}$ to a logic rail through a 10-k $\Omega$ resistor. The INT pin sends an active low, 256- $\mu$ s pulse to the host to report charger device status and fault.
NC	B5	8		Not connected
PMID	A3, B3	23	DO	Boost mode output. Connected to the drain of the reverse blocking MOSFET (RBFET) and the drain of HSFET. Consider the total input capacitance, put 1 $\mu$ F on VBUS to GND, and the rest capacitance on PMID to GND (typical 2x4.7 $\mu$ F plus 1 nF).
PMID_GOOD	D5	3	DO	Open drain active high PMID good indicator. Connect to the pullup rail REGN through 10-k $\Omega$ resistor. HIGH indicates PMID voltage is below 5.2 V and the current through Q1 is below 110% of input current limit. This signal can be used to drive external PMOS FET to disconnect the PMID under charging load when Boost mode output voltage is too high or output current is too high.
PSEL	C5	2	DI	Power source selection input. HIGH indicates 500-mA input current limit. LOW indicates 2.4-A input current limit. Once the device gets into Host mode, the host can program a different input current limit to the IINDPDM register.
QON	D4	12	DI	BATFET enable/reset control input. When the BATFET is in Ship mode, a logic LOW of $t_{\text{SHIPMODE}}$ duration turns on BATFET to exit Ship mode. When the BATFET is not in Ship mode, a logic LOW of $t_{\text{QON\_RST}}$ (minimum 8 s) duration resets SYS (system power) by turning BATFET off for $t_{\text{BATFET\_RST}}$ (minimum 250 ms) and then re-enables BATFET to provide full system power reset. The host chooses the BATFET reset function with VBUS unplug or not through I <sup>2</sup> C bit BATFET_RST_WVBUS. The pin is pulled up to $V_{\text{BAT}}$ through 200 k $\Omega$ to maintain default HIGH logic during Ship mode. It has an internal clamp to 6.5 V.
REGN	C4	22	P	PWM low-side driver positive supply output. Internally, REGN is connected to the anode of the bootstrap diode. Connect a 4.7- $\mu$ F (10-V rating) ceramic capacitor from REGN to analog GND. The capacitor should be placed close to the IC.
SCL	F5	5	DI	I <sup>2</sup> C interface clock. Connect SCL to the logic rail through a 10-k $\Omega$ resistor.
SDA	E4	6	DIO	I <sup>2</sup> C interface data. Connect SDA to the logic rail through a 10-k $\Omega$ resistor.
STAT	E5	4	DO	Open-drain interrupt output. Connect the STAT pin to a logic rail via 10-k $\Omega$ resistor. The STAT pin indicates charger status. Charge in progress: LOW Charge complete or charger in Sleep mode: HIGH Charge suspend (fault response): Blink at 1 Hz
SW	A2, B2	19	P	Switching node connecting to output inductor. Internally SW is connected to the source of the n-channel HSFET and the drain of the n-channel LSFET. Connect the 0.047- $\mu$ F bootstrap capacitor from SW to BTST.
		20		
SYS	C2, D2, E2, F2	15	P	Converter output connection point. The internal current sensing resistor is connected between SYS and BAT. Connect a 10 $\mu$ F (min) closely to the SYS pin.
		16		
TS	D3	11	AI	Battery temperature qualification voltage input. Connect a negative temperature coefficient thermistor (NTC). Program temperature window with a resistor divider from REGN to TS to GND. Charge and Boost mode suspend when TS pin voltage is out of range. When TS pin is not used, connect a 10-k $\Omega$ resistor from REGN to TS and a 10-k $\Omega$ resistor from TS to GND or set TS_IGNORE to HIGH to ignore TS pin. It is recommended to use a 103AT-2 thermistor.
VAC	A5	1	AI	Input voltage sensing. This pin must be tied to VBUS.

表 5-1. Pin Functions (续)

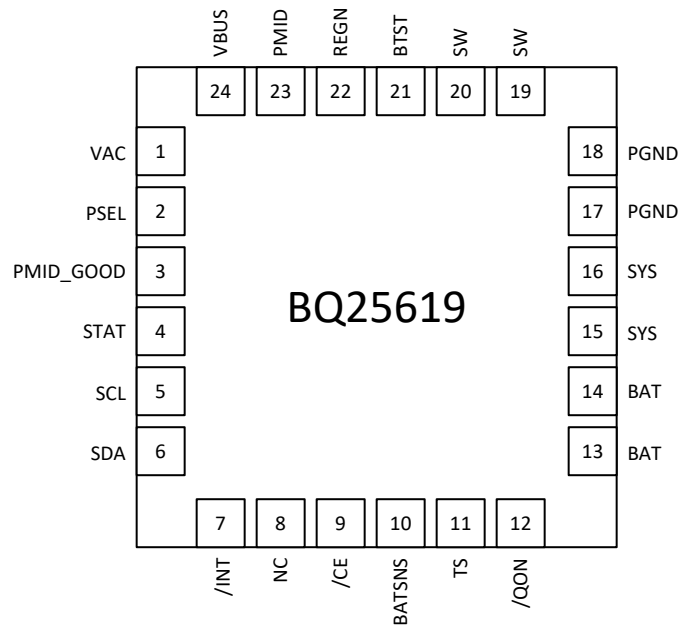
PIN			TYPE <sup>(1)</sup>	DESCRIPTION
NAME	BQ25618 NO.	BQ25619 NO.		
VBUS	A4, B4	24	P	Charger input voltage. The internal n-channel reverse block MOSFET (RBFET) is connected between VBUS and PMID with VBUS on source. Place a 1- $\mu$ F ceramic capacitor from VBUS to GND and place it as close as possible to IC.
Thermal Pad	—	—	P	Ground reference for the device that is also the thermal pad used to conduct heat from the device. This connection serves two purposes. The first purpose is to provide an electrical ground connection for the device. The second purpose is to provide a low thermal-impedance path from the device die to the PCB. This pad should be tied externally to a ground plane.

(1) AI = Analog input, AO = Analog Output, AIO = Analog input Output, DI = Digital input, DO = Digital Output, DIO = Digital input Output, P = Power

## 6 Specifications

### 6.1 Absolute Maximum Ratings

over operating free-air temperature range (unless otherwise noted)<sup>(1)</sup>

		MIN	MAX	UNIT
Voltage	VAC (converter not switching)	- 2	22	V
Voltage	VBUS (converter not switching)	-2	22	V
Voltage	PMID (converter not switching)	- 0.3	22	V
Voltage	SW	- 0.3	16	V
Voltage	BAT, SYS (converter not switching)	- 0.3	7	V
Voltage	BTST	- 0.3	22	V
Voltage	BATSNS (converter not switching)	- 0.3	7	V
Voltage	PSEL, STAT, SCL, SDA, INT, PMID_GOOD, CE, TS, QON	- 0.3	7	V
Output Sink Current	SDA, STAT, INT, PMID_GOOD		6	mA
T <sub>J</sub>	Junction temperature	- 40	150	°C
T <sub>stg</sub>	Storage temperature	- 55	150	°C

- (1) Stresses beyond those listed under *Absolute Maximum Rating* may cause permanent damage to the device. These are stress ratings only, which do not imply functional operation of the device at these or any other conditions beyond those indicated under *Recommended Operating Condition*. Exposure to absolute-maximum-rated conditions for extended periods may affect device reliability.

### 6.2 ESD Ratings

			VALUE	UNIT
V <sub>(ESD)</sub>	Electrostatic discharge	Human body model (HBM), per ANSI/ESDA/JEDEC JS-001, all pins <sup>(1)</sup>	±2000	V
		Charged device model (CDM), per JEDEC specification JESD22-C101, all pins <sup>(2)</sup>	±250	

- (1) JEDEC document JEP155 states that 500-V HBM allows safe manufacturing with a standard ESD control process.  
(2) JEDEC document JEP157 states that 250-V CDM allows safe manufacturing with a standard ESD control process.

### 6.3 Recommended Operating Conditions

over operating free-air temperature range (unless otherwise noted)

		MIN	NOM	MAX	UNIT
V <sub>VBUS</sub>	Input voltage	4		13.5	V
V <sub>BAT</sub>	Battery voltage			4.52	V
I <sub>VBUS</sub>	Input current			3.2	A
I <sub>SW</sub>	Output current (SW)			1.8	A
I <sub>BAT</sub>	Fast charging current			1.5	A
I <sub>BAT</sub>	RMS discharge current			5	A
T <sub>A</sub>	Ambient temperature	- 40		85	°C
L	Inductance		1	2.2	μH
C <sub>VBUS</sub>	VBUS capacitance		1		μF
C <sub>PMID</sub>	PMID capacitance		10		μF
C <sub>SYS</sub>	SYS capacitance		10		μF
C <sub>BAT</sub>	BAT capacitance		10		μF
C <sub>REGN</sub>	REGN capacitance		4.7		μF

## 6.4 Thermal Information

THERMAL METRIC <sup>(1)</sup>		BQ25618	UNIT
		YFF (DSBGA)	
		30 Balls	
$R_{\theta JA}$	Junction-to-ambient thermal resistance (JEDEC <sup>(1)</sup> )	58.8	°C/W
$R_{\theta JC(top)}$	Junction-to-case (top) thermal resistance	0.2	°C/W
$R_{\theta JB}$	Junction-to-board thermal resistance	8.3	°C/W
$\Psi_{JT}$	Junction-to-top characterization parameter	1.4	°C/W
$\Psi_{JB}$	Junction-to-board characterization parameter	8.3	°C/W
$R_{\theta JC(bot)}$	Junction-to-case (bottom) thermal resistance	N/A	°C/W

(1) For more information about traditional and new thermal metrics, see the [Semiconductor and IC Package Thermal Metrics](#) application report.

## 6.5 Thermal Information

THERMAL METRIC <sup>(1)</sup>		BQ25619	UNIT
		RTW (WQFN)	
		24 Pins	
$R_{\theta JA}$	Junction-to-ambient thermal resistance (JEDEC <sup>(1)</sup> )	35.6	°C/W
$R_{\theta JC(top)}$	Junction-to-case (top) thermal resistance	22.7	°C/W
$R_{\theta JB}$	Junction-to-board thermal resistance	11.9	°C/W
$\Psi_{JT}$	Junction-to-top characterization parameter	0.2	°C/W
$\Psi_{JB}$	Junction-to-board characterization parameter	12	°C/W
$R_{\theta JC(bot)}$	Junction-to-case (bottom) thermal resistance	2.6	°C/W

(1) For more information about traditional and new thermal metrics, see the [Semiconductor and IC Package Thermal Metrics](#) application report.

## 6.6 Electrical Characteristics

$V_{VBUS\_UVLOZ} < V_{VBUS} < V_{VBUS\_OV}$  and  $V_{VBUS} > V_{BAT} + V_{SLEEP}$ ,  $T_J = -40^{\circ}\text{C}$  to  $+125^{\circ}\text{C}$ , and  $T_J = 25^{\circ}\text{C}$  for typical values (unless otherwise noted)

PARAMETER	TEST CONDITIONS	MIN	TYP	MAX	UNIT
<b>QUIESCENT CURRENTS</b>					
$I_{Q\_BAT}$	Quiescent battery current (BATSNS, BAT, SYS, SW)		9.5	15	$\mu\text{A}$
$I_{SHIP\_BAT}$	Shipmode battery current (BATSNS, BAT, SYS, SW)		7	9.5	$\mu\text{A}$
$I_{VBUS}$	Input current (VBUS) in buck mode when converter is switching		2.3		mA
$I_{HIZ\_VBUS}$	Quiescent input current in HIZ	VAC/VBUS = 5V, HIZ mode, no battery	37	50	$\mu\text{A}$
		VAC/VBUS = 12V, HIZ mode, no battery	68	90	$\mu\text{A}$
$I_{BST}$	Quiescent battery current (BATSNS, BAT, SYS, SW) in boost mode when converter is switching		2.4		mA
<b>VBUS / VBAT SUPPLY</b>					
$V_{VBUS\_OP}$	VBUS operating range	4		13.5	V
$V_{VBUS\_UVLOZ}$	VBUS rising for active I2C, no battery		3.3	3.7	V
$V_{VBUS\_UVLO}$	VBUS falling to turnoff I2C, no battery		3	3.3	V



## 6.6 Electrical Characteristics (续)

$V_{VBUS\_UVLOZ} < V_{VBUS} < V_{VBUS\_OV}$  and  $V_{VBUS} > V_{BAT} + V_{SLEEP}$ ,  $T_J = -40^{\circ}\text{C}$  to  $+125^{\circ}\text{C}$ , and  $T_J = 25^{\circ}\text{C}$  for typical values (unless otherwise noted)

PARAMETER		TEST CONDITIONS	MIN	TYP	MAX	UNIT
$V_{VBUS\_PRESENT}$	VBUS to enable REGN	VBUS rising		3.65	3.9	V
$V_{VBUS\_PRESENTZ}$	VBUS to disable REGN	VBUS falling		3.15	3.4	V
$V_{SLEEP}$	Enter Sleep mode threshold	VBUS falling, $V_{BUS} - V_{BAT}$ , $V_{BAT} = 4\text{V}$	15	60	110	mV
$V_{SLEEPZ}$	Exit Sleep mode threshold	VBUS rising, $V_{BUS} - V_{BAT}$ , $V_{BAT} = 4\text{V}$	115	220	340	mV
$V_{ACOV}$	VAC overvoltage rising threshold to turn of switching	VAC rising, OVP[1:0]=00	5.45	5.85	6.07	V
		VAC rising, OVP[1:0]=01	6.1	6.4	6.75	V
		VAC rising, OVP[1:0]=10	10.45	11	11.55	V
		VAC rising, OVP[1:0]=11 (default)	13.5	14.2	14.85	V
	VAC overvoltage falling threshold to resume switching	VAC falling, OVP[1:0]=00	5.2	5.6	5.8	V
		VAC falling, OVP[1:0]=01	5.8	6.2	6.45	V
		VAC falling, OVP[1:0]=10	10	10.7	11.1	V
		VAC falling, OVP[1:0]=11 (default)	13	13.9	14.5	V
$V_{BAT\_UVLOZ}$	BAT voltage for active I2C, no VBUS	VBAT rising	2.5			V
$V_{BAT\_DPLZ}$	BAT depletion rising threshold to turn on BATFET	VBAT rising	2.35		2.8	V
$V_{BAT\_DPL}$	BAT depletion falling threshold to turn off BATFET	VBAT falling	2.18		2.62	V
$V_{POORSRC}$	Bad adapter detection threshold	VBUS falling	3.75	3.9	4.0	V
<b>POWER PATH MANAGEMENT</b>						
$V_{SYS\_MIN}$	Typical minimum system regulation voltage	$V_{BAT}=3.2\text{V} < \text{SYS\_MIN} = 3.5\text{V}$ , $\text{ISYS} = 0\text{A}$	3.5	3.65		V
$V_{SYS\_OVP}$	System overvoltage threshold	$V_{REG} = 4.35\text{V}$ , Charge disabled, $\text{ISYS} = 0\text{A}$		4.7		V
$R_{ON\_RBFET}$	Blocking FET on-resistance (BQ25618)			35		m $\Omega$
$R_{ON\_RBFET}$	Blocking FET on-resistance (BQ25619)			45		m $\Omega$
$R_{ON\_HSFET}$	High-side switching FET on-resistance (BQ25618)			55		m $\Omega$
$R_{ON\_HSFET}$	High-side switching FET on-resistance (BQ25619)			62		m $\Omega$
$R_{ON\_LSFET}$	Low-side switching FET on-resistance (BQ25618)			60		m $\Omega$
$R_{ON\_LSFET}$	Low-side switching FET on-resistance (BQ25619)			71		m $\Omega$
$V_{BATFET\_FWD}$	BATFET forward voltage in supplement mode	BAT discharge current 10mA, converter running		30		mV
<b>BATTERY CHARGER</b>						
$V_{REG\_RANGE}$	Typical charge voltage regulation range		3.5		4.52	V
$V_{REG\_STEP}$	Typical charge voltage step	$4.3\text{V} < V_{REG} < 4.52\text{V}$		10		mV
$V_{REG\_ACC}$	Charge voltage accuracy	$V_{REG} = 4.2\text{V}$ , $T_J = -40^{\circ}\text{C} - 85^{\circ}\text{C}$	4.183	4.2	4.2168	V
$V_{REG\_ACC}$	Charge voltage accuracy	$V_{REG} = 4.35\text{V}$ , $T_J = -40^{\circ}\text{C} - 85^{\circ}\text{C}$	4.333	4.35	4.367	V
$V_{REG\_ACC}$	Charge voltage accuracy	$V_{REG} = 4.45\text{V}$ , $T_J = -40^{\circ}\text{C} - 85^{\circ}\text{C}$	4.432	4.45	4.468	V

## 6.6 Electrical Characteristics (续)

$V_{VBUS\_UVLOZ} < V_{VBUS} < V_{VBUS\_OV}$  and  $V_{VBUS} > V_{BAT} + V_{SLEEP}$ ,  $T_J = -40^{\circ}\text{C}$  to  $+125^{\circ}\text{C}$ , and  $T_J = 25^{\circ}\text{C}$  for typical values (unless otherwise noted)

PARAMETER		TEST CONDITIONS	MIN	TYP	MAX	UNIT
$I_{CHG\_RANGE}$	Typical charge current regulation range		0		1.5	A
$I_{CHG\_STEP}$	Typical charge current regulation step			20		mA
$I_{CHG\_ACC}$	Fast charge current regulation accuracy	$I_{CHG} = 0.24\text{A}$ , $V_{BAT} = 3.1\text{V}$ or $3.8\text{V}$ , $T_J = -40^{\circ}\text{C} - 85^{\circ}\text{C}$	0.216	0.24	0.264	A
		$I_{CHG} = 0.72\text{A}$ , $V_{BAT} = 3.1\text{V}$ or $3.8\text{V}$ , $T_J = -40^{\circ}\text{C} - 85^{\circ}\text{C}$	0.684	0.72	0.756	A
		$I_{CHG} = 1.50\text{A}$ , $V_{BAT} = 3.1\text{V}$ or $3.8\text{V}$ , $T_J = -40^{\circ}\text{C} - 85^{\circ}\text{C}$	1.425	1.5	1.575	A
$I_{PRECHG\_RANGE}$	Typical pre-charge current range		20		260	mA
$I_{PRECHG\_STEP}$	Typical pre-charge current step			20		mA
$I_{PRECHG\_ACC}$	Precharge current accuracy	$V_{BAT} = 2.6\text{V}$ , $I_{PRECHG} = 40\text{mA}$	28	40	52	mA
		$V_{BAT} = 2.6\text{V}$ , $I_{PRECHG} = 120\text{mA}$	84	120	156	mA
$I_{TERM\_RANGE}$	Typical termination current range		20		260	mA
$I_{TERM\_STEP}$	Typical termination current step			20		mA
$I_{TERM\_ACC}$	Termination current accuracy	$I_{TERM}=40\text{mA}$ , $I_{CHG}>260\text{mA}$ , $V_{REG}=4.35\text{V}$ , $T_J = 0^{\circ}\text{C} - 85^{\circ}\text{C}$	30	40	50	mA
		$I_{TERM}=20\text{mA}$ , $I_{CHG}<260\text{mA}$ , $V_{REG}=4.35\text{V}$ , $T_J = 0^{\circ}\text{C} - 85^{\circ}\text{C}$	10	20	30	mA
$V_{BAT\_SHORTZ}$	Battery short voltage rising threshold to start pre-charge	$V_{BAT}$ rising	2.13	2.25	2.35	V
$V_{BAT\_SHORT}$	Battery short voltage falling threshold to stop pre-charge	$V_{BAT}$ falling	1.85	2	2.15	V
$I_{BAT\_SHORT}$	Battery short trickle charging current	$V_{BAT} < V_{BAT\_SHORTZ}$	15	25	30	mA
$V_{BATLOWV}$	Battery LOWV rising threshold to start fast-charge	$V_{BAT}$ rising	3	3.12	3.24	V
	Battery LOWV falling threshold to stop fast-charge	$V_{BAT}$ falling	2.7	2.8	2.9	V
$V_{RECHG}$	Battery recharge threshold	$V_{RECHG}=0$ , $V_{BAT}$ falling (default)	90	120	150	mV
		$V_{RECHG}=1$ , $V_{BAT}$ falling	185	210	245	mV
$I_{SYS\_LOAD}$	System discharge load current during SYSOVP			30		mA
$R_{ON\_BATFET}$	Battery FET on-resistance	$T_J = -40^{\circ}\text{C} - 85^{\circ}\text{C}$		19.5	26	$\text{m}\Omega$
		$T_J = -40^{\circ}\text{C} - 125^{\circ}\text{C}$		19.5	30	$\text{m}\Omega$
<b>BATTERY OVERVOLTAGE PROTECTION</b>						
$V_{BAT\_OVP}$	Battery overvoltage rising threshold	$V_{BAT}$ rising, as percentage of $V_{REG}$	103	104	105	%
	Battery overvoltage falling threshold	$V_{BAT}$ falling, as percentage of $V_{REG}$	101	102	103	%
<b>INPUT VOLTAGE / CURRENT REGULATION</b>						
$V_{INDPM\_RANGE}$	Typical input voltage regulation range		3.9		5.4	V
$V_{INDPM\_STEP}$	Typical input voltage regulation step			100		mV
$V_{INDPM\_ACC}$	Typical input voltage regulation accuracy		4.365	4.5	4.635	V
$V_{INDPM\_TRACK}$	$V_{INDPM}$ threshold to track battery voltage	$V_{BAT} = 4.35\text{V}$ , $V_{INDPM\_BAT\_TRACK} = V_{BAT}+200\text{mV}$	4.45	4.55	4.74	V
$I_{INDPM\_RANGE}$	Typical input current regulation range		0.1		3.2	A
$I_{INDPM\_STEP}$	Typical input current regulation step			100		mA
$I_{INDPM\_ACC}$	Input current regulation accuracy	$I_{INDPM} = 500\text{mA}$ ( $T_J=-40^{\circ}\text{C} - 85^{\circ}\text{C}$ )	450	465	500	mA

## 6.6 Electrical Characteristics (续)

$V_{VBUS\_UVLOZ} < V_{VBUS} < V_{VBUS\_OV}$  and  $V_{VBUS} > V_{BAT} + V_{SLEEP}$ ,  $T_J = -40^{\circ}\text{C}$  to  $+125^{\circ}\text{C}$ , and  $T_J = 25^{\circ}\text{C}$  for typical values (unless otherwise noted)

PARAMETER		TEST CONDITIONS	MIN	TYP	MAX	UNIT
$I_{INDPM\_ACC}$	Input current regulation accuracy	$I_{INDPM} = 900\text{mA}$ ( $T_J = -40^{\circ}\text{C}$ - $85^{\circ}\text{C}$ )	750	835	900	mA
$I_{INDPM\_ACC}$	Input current regulation accuracy	$I_{INDPM} = 1500\text{mA}$ ( $T_J = -40^{\circ}\text{C}$ - $85^{\circ}\text{C}$ )	1300	1390	1500	mA
<b>THERMAL REGULATION AND THERMAL SHUTDOWN</b>						
$T_{REG}$	Junction temperature regulation accuracy	$T_{REG} = 90^{\circ}\text{C}$		90		$^{\circ}\text{C}$
		$T_{REG} = 110^{\circ}\text{C}$		110		$^{\circ}\text{C}$
$T_{SHUT}$	Thermal Shutdown Rising threshold	Temperature Increasing		150		$^{\circ}\text{C}$
	Thermal Shutdown Falling threshold	Temperature Decreasing		130		$^{\circ}\text{C}$
<b>CHARGE MODE THERMISTOR COMPARATOR (JEITA 616J or HOT/COLD 616)</b>						
$V_{T1\_RISE\%}$	TS pin voltage rising threshold, Charge suspended above this voltage.	As Percentage to REGN ( $0^{\circ}\text{C}$ w/ 103AT)	72.4	73.3	74.2	%
$V_{T1\_FALL\%}$	TS pin voltage falling threshold. Charge re-enabled to 20% of ICHG and VREG below this voltage.	As Percentage to REGN	71.5	72	72.5	%
$V_{T2\_RISE\%}$	TS pin voltage rising threshold, Charge back to 20% of ICHG and VREG above this voltage.	As Percentage to REGN, JEITA_T2= $5^{\circ}\text{C}$ w/ 103AT	70.25	70.75	71.25	%
		As Percentage to REGN, JEITA_T2= $10^{\circ}\text{C}$ w/ 103AT	67.75	68.25	68.75	%
		As Percentage to REGN, JEITA_T2= $15^{\circ}\text{C}$ w/ 103AT	64.75	65.25	65.75	%
		As Percentage to REGN, JEITA_T2= $20^{\circ}\text{C}$ w/ 103AT	61.75	62.25	62.75	%
$V_{T2\_FALL\%}$	TS pin voltage falling threshold. Charge back to ICHG and VREG below this voltage.	As Percentage to REGN, JEITA_T2= $5^{\circ}\text{C}$ w/ 103AT	68.7	69.2	69.7	%
		As Percentage to REGN, JEITA_T2= $10^{\circ}\text{C}$ w/ 103AT	66.45	66.95	67.45	%
		As Percentage to REGN, JEITA_T2= $15^{\circ}\text{C}$ w/ 103AT	63.7	64.2	64.7	%
		As Percentage to REGN, JEITA_T2= $20^{\circ}\text{C}$ w/ 103AT	60.7	61.2	61.7	%
$V_{T3\_FALL\%}$	TS pin voltage falling threshold. Charge to ICHG and 4.1V below this voltage.	As Percentage to REGN, JEITA_T3= $40^{\circ}\text{C}$ w/ 103AT	47.75	48.25	48.75	%
		As Percentage to REGN, JEITA_T3= $45^{\circ}\text{C}$ w/ 103AT	44.25	44.75	45.25	%
		As Percentage to REGN, JEITA_T3= $50^{\circ}\text{C}$ w/ 103AT	40.2	40.7	41.2	%
		As Percentage to REGN, JEITA_T3= $55^{\circ}\text{C}$ w/ 103AT	37.2	37.7	38.2	%
$V_{T3\_RISE\%}$	TS pin voltage rising threshold. Charge back to ICHG and VREG above this voltage.	As Percentage to REGN, JEITA_T3= $40^{\circ}\text{C}$ w/ 103AT	48.8	49.3	49.8	%
		As Percentage to REGN, JEITA_T3= $45^{\circ}\text{C}$ w/ 103AT	45.3	45.8	46.3	%
		As Percentage to REGN, JEITA_T3= $50^{\circ}\text{C}$ w/ 103AT	41.3	41.8	42.3	%
		As Percentage to REGN, JEITA_T3= $55^{\circ}\text{C}$ w/ 103AT	38.5	39	39.5	%
$V_{T5\_FALL\%}$	TS pin voltage falling threshold, charge suspended below this voltage.	As Percentage to REGN ( $60^{\circ}\text{C}$ w/ 103AT)	33.7	34.2	35.1	%

## 6.6 Electrical Characteristics (续)

$V_{VBUS\_UVLOZ} < V_{VBUS} < V_{VBUS\_OV}$  and  $V_{VBUS} > V_{BAT} + V_{SLEEP}$ ,  $T_J = -40^{\circ}\text{C}$  to  $+125^{\circ}\text{C}$ , and  $T_J = 25^{\circ}\text{C}$  for typical values (unless otherwise noted)

PARAMETER		TEST CONDITIONS	MIN	TYP	MAX	UNIT
$V_{T5\_RISE\%}$	TS pin voltage rising threshold. Charge back to ICHG and 4.1V above this voltage.	As Percentage to REGN	35	35.5	36	%
<b>BOOST MODE THERMISTOR COMPARATOR (HOT/COLD)</b>						
$V_{BCOLD\_RISE\%}$	TS pin voltage rising threshold, boost mode is suspended above this voltage.	As Percentage to REGN ( - 19.5°C w/ 103AT)	79.5	80	80.5	%
$V_{BCOLD\_FALL\%}$	TS pin voltage falling threshold	As Percentage to REGN (0°C w/ 103AT)		72		%
$V_{BHOT\_FALL\%}$	TS pin voltage threshold. boost mode is suspended below this voltage.	As Percentage to REGN, (64°C w/ 103AT)	30.2	31.2	32.2	%
$V_{BHOT\_RISE\%}$	TS pin voltage rising threshold	As Percentage to REGN, (55°C w/ 103AT), REG0C[1:0]=11		39		%
<b>SWITCHING CONVERTER</b>						
$F_{SW}$	PWM switching frequency	Oscillator frequency	1.32	1.5	1.68	MHz
$D_{MAX}$	Maximum PWM Duty Cycle			97		%
<b>BOOST MODE CONVERTER</b>						
$V_{BATLOWV\_OTG}$	Battery voltage exiting boost mode	$V_{VBAT}$ falling	2.6	2.8	2.9	V
	Battery voltage entering boost mode	$V_{VBAT}$ rising	2.9	3.0	3.15	V
$V_{BST\_BAT}$	Battery voltage exiting boost mode	BAT falling $V_{VBAT}$	2.4	2.5	2.6	V
$V_{BST\_RANGE}$	Typical boost mode voltage regulation range		4.6		5.15	V
$V_{BST\_ACC}$	Boost mode voltage regulation accuracy	$I_{VBUS} = 0\text{A}$ , $BOOST\_V = 5\text{V}$	4.85	5	5.15	V
$I_{SYS\_OCP\_Q4}$	Boost mode battery discharge current clamp on BATFET Q4		5	6		A
$V_{BST\_OVP}$	Boost mode overvoltage threshold on PMID		5.55	5.8	6.15	V
<b>REGN LDO</b>						
$V_{REGN}$	REGN LDO output voltage	$V_{VBUS} = 5\text{V}$ , $I_{REGN} = 20\text{mA}$	4.58	4.7	4.8	V
		$V_{VBUS} = 9\text{V}$ , $I_{REGN} = 20\text{mA}$	5.6	6	6.5	V
$I_{REGN}$	REGN LDO current limit	$V_{VBUS} = 5\text{V}$ , $V_{REGN} = 3.8\text{V}$	50			mA
<b>I2C INTERFACE (SCL, SDA)</b>						
$V_{IH}$	Input high threshold level, SDA and SCL	Pull up rail 1.8V	1.3			V
$V_{IL}$	Input low threshold level	Pull up rail 1.8V			0.4	V
$V_{OL}$	Output low threshold level	Sink current = 5mA			0.4	V
$I_{BIAS}$	High-level leakage current	Pull up rail 1.8V			1	μA
$V_{IH\_SDA}$	Input high threshold level, SDA	Pull up rail 1.8V	1.3			V
$V_{IL\_SDA}$	Input low threshold level	Pull up rail 1.8V			0.4	V
$V_{OL\_SDA}$	Output low threshold level	Sink current = 5mA			0.4	V
$I_{BIAS\_SDA}$	High-level leakage current	Pull up rail 1.8V			1	μA
$V_{IH\_SCL}$	Input high threshold level, SDA	Pull up rail 1.8V	1.3			V
$V_{IL\_SCL}$	Input low threshold level	Pull up rail 1.8V			0.4	V
$V_{OL\_SCL}$	Output low threshold level	Sink current = 5mA			0.4	V
$I_{BIAS\_SCL}$	High-level leakage current	Pull up rail 1.8V			1	μA

## 6.6 Electrical Characteristics (续)

$V_{VBUS\_UVLOZ} < V_{VBUS} < V_{VBUS\_OV}$  and  $V_{VBUS} > V_{BAT} + V_{SLEEP}$ ,  $T_J = -40^{\circ}\text{C}$  to  $+125^{\circ}\text{C}$ , and  $T_J = 25^{\circ}\text{C}$  for typical values (unless otherwise noted)

PARAMETER		TEST CONDITIONS	MIN	TYP	MAX	UNIT
<b>LOGIC INPUT PIN</b>						
$V_{IH}$	Input high threshold level (/CE, PSEL)		1.3			V
$V_{IL}$	Input low threshold level (/CE, PSEL)				0.4	V
$I_{IN\_BIAS}$	High-level leakage current (/CE, PSEL)	Pull up rail 1.8V			1	$\mu\text{A}$
<b>LOGIC OUTPUT PIN</b>						
$V_{OL}$	Output low threshold level (/INT, STAT, PMID_GOOD)	Sink current = 5mA			0.4	V
$I_{OUT\_BIAS}$	High-level leakage current (/INT, STAT, PMID_GOOD)	Pull up rail 1.8V			1	$\mu\text{A}$

## 6.7 Timing Requirements

		MIN	NOM	MAX	UNIT
<b>VBUS / VBAT POWER UP</b>					
$t_{VBUS\_OV}$	VBUS OVP Reaction-time		130		ns
$t_{POORSRC}$	Bad adapter detection duration		30		ms
$t_{POORSRC\_RETRY}$	Bad adapter detection retry wait time		2		s
<b>BATTERY CHARGER</b>					
$t_{TERM\_DGL}$	Deglitch time for charge termination		30		ms
$t_{RECHG\_DGL}$	Deglitch time for recharge threshold		30		ms
$t_{TOP\_OFF}$	Typical top-off timer accuracy TOP_OFF_TIMER[1:0]=10	24	30	36	min
$t_{SAFETY}$	Charge safety timer accuracy, CHG_TIMER = 20hr	17	20	24	hr
$t_{SAFETY}$	Charge safety timer accuracy, CHG_TIMER = 10hr	8	10	12	hr
<b>QON Timing</b>					
$t_{SHIPMODE}$	$\overline{QON}$ low time to turn on BATFET and exit shipmode ( $-10^{\circ}\text{C} \leq T_J \leq 60^{\circ}\text{C}$ )	0.9		1.3	s
$t_{QON\_RST}$	$\overline{QON}$ low time before BATFET full system reset ( $-10^{\circ}\text{C} \leq T_J \leq 60^{\circ}\text{C}$ )	8		12	s
$t_{BATFET\_RST}$	BATFET off time during full system reset ( $-10^{\circ}\text{C} \leq T_J \leq 60^{\circ}\text{C}$ )	250		400	ms
$t_{BATFET\_DLY}$	Delay time before BATFET turn off in ship mode ( $-10^{\circ}\text{C} \leq T_J \leq 60^{\circ}\text{C}$ )	10		15	s
<b>I2C INTERFACE</b>					
$f_{SCL}$	SCL clock frequency			400	kHz
<b>DIGITAL CLOCK AND WATCHDOG</b>					
$f_{LPDIG}$	Digital low-power clock (REGN LDO is disabled)		30		kHz
$f_{DIG}$	Digital power clock		500		kHz
$t_{LP\_WDT}$	Watchdog Reset time		160		s
$t_{WDT}$	Watchdog Reset time (WATCHDOG REG05[5:4] = 160s)		160		s

## 6.8 Typical Characteristics

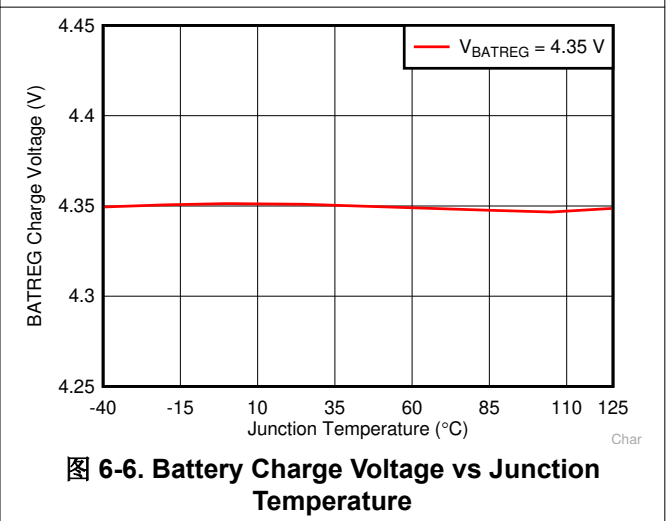
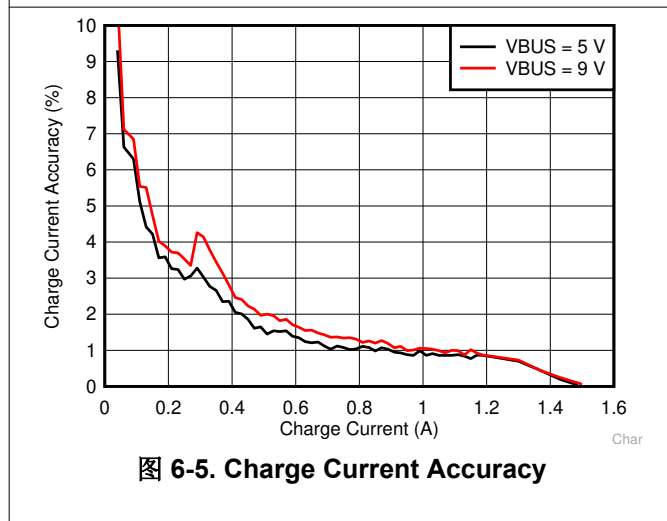
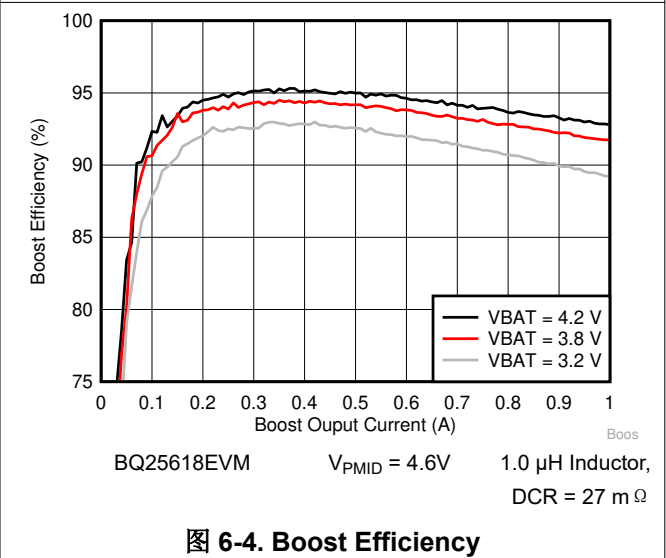
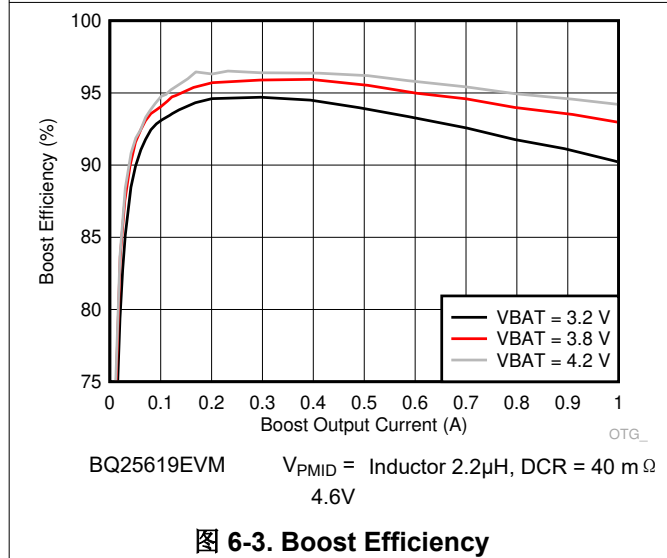
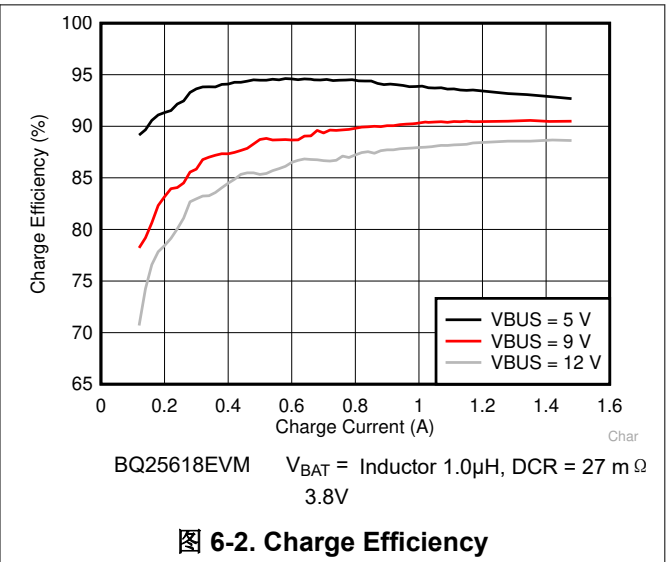
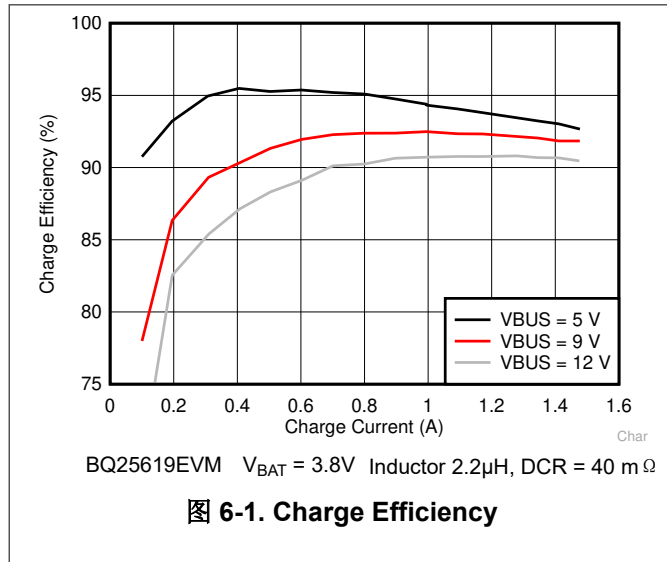



图 6-7. Charge Current vs Junction Temperature



图 6-8. VINDPM vs Junction Temperature

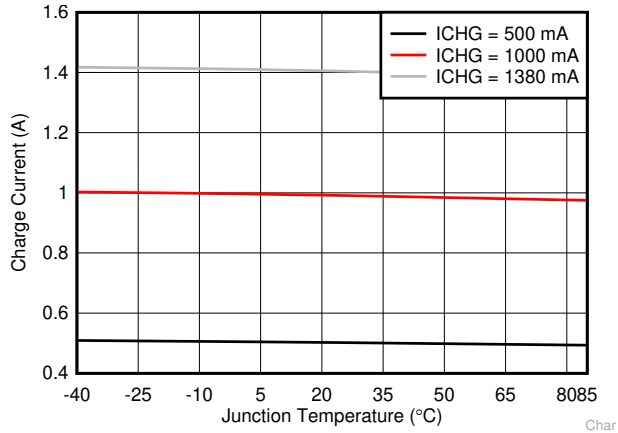

图 6-9. SYSMIN Voltage vs Junction Temperature (VSYS set at 3.5 V)

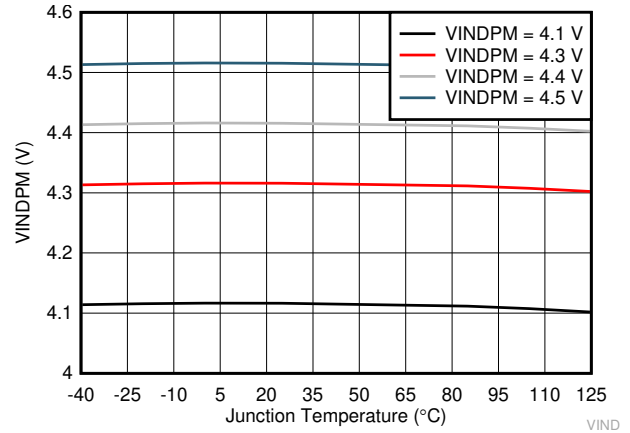

图 6-10. Input Current Limit vs Junction Temperature

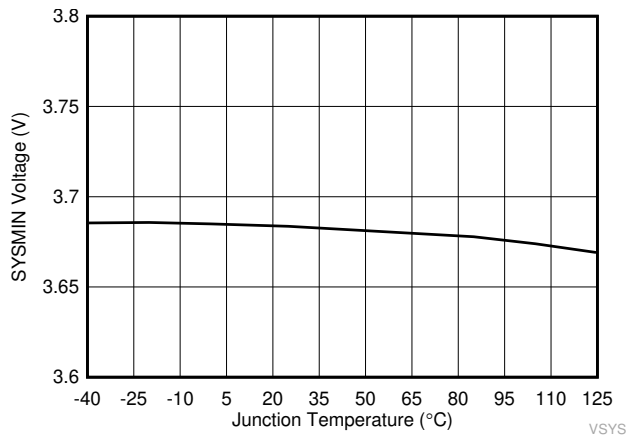

图 6-11. Boost Output Voltage vs Junction Temperature

## 7 Detailed Description

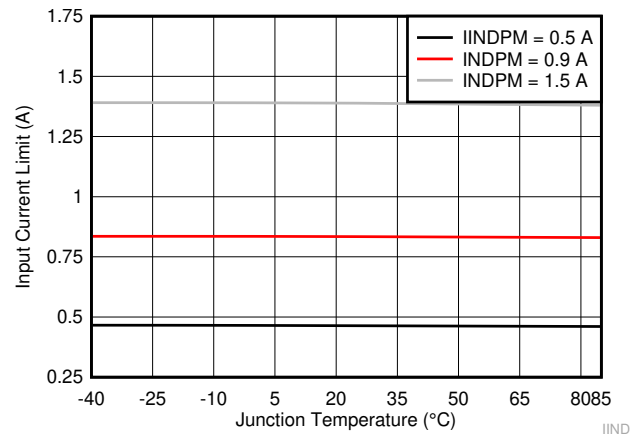
### 7.1 Overview

The BQ25619/618 device is a highly integrated 1.5-A switch-mode battery charger for single cell Li-ion and Li-polymer battery. It includes an input reverse-blocking FET (RBFET, Q1), high-side switching FET (HSFET, Q2), low-side switching FET (LSFET, Q3), and battery FET (BATFET, Q4), and bootstrap diode for the high-side gate drive.

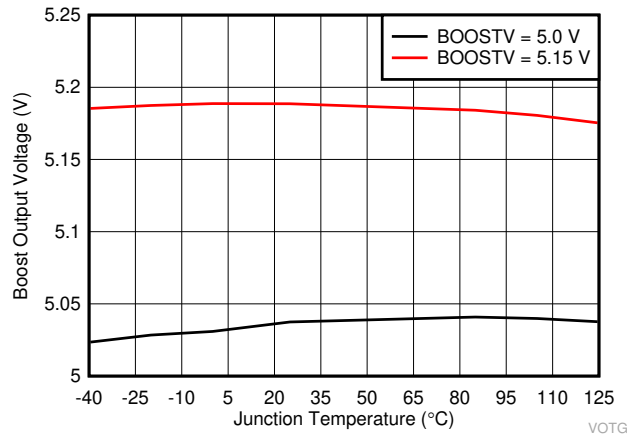
### 7.2 Functional Block Diagram

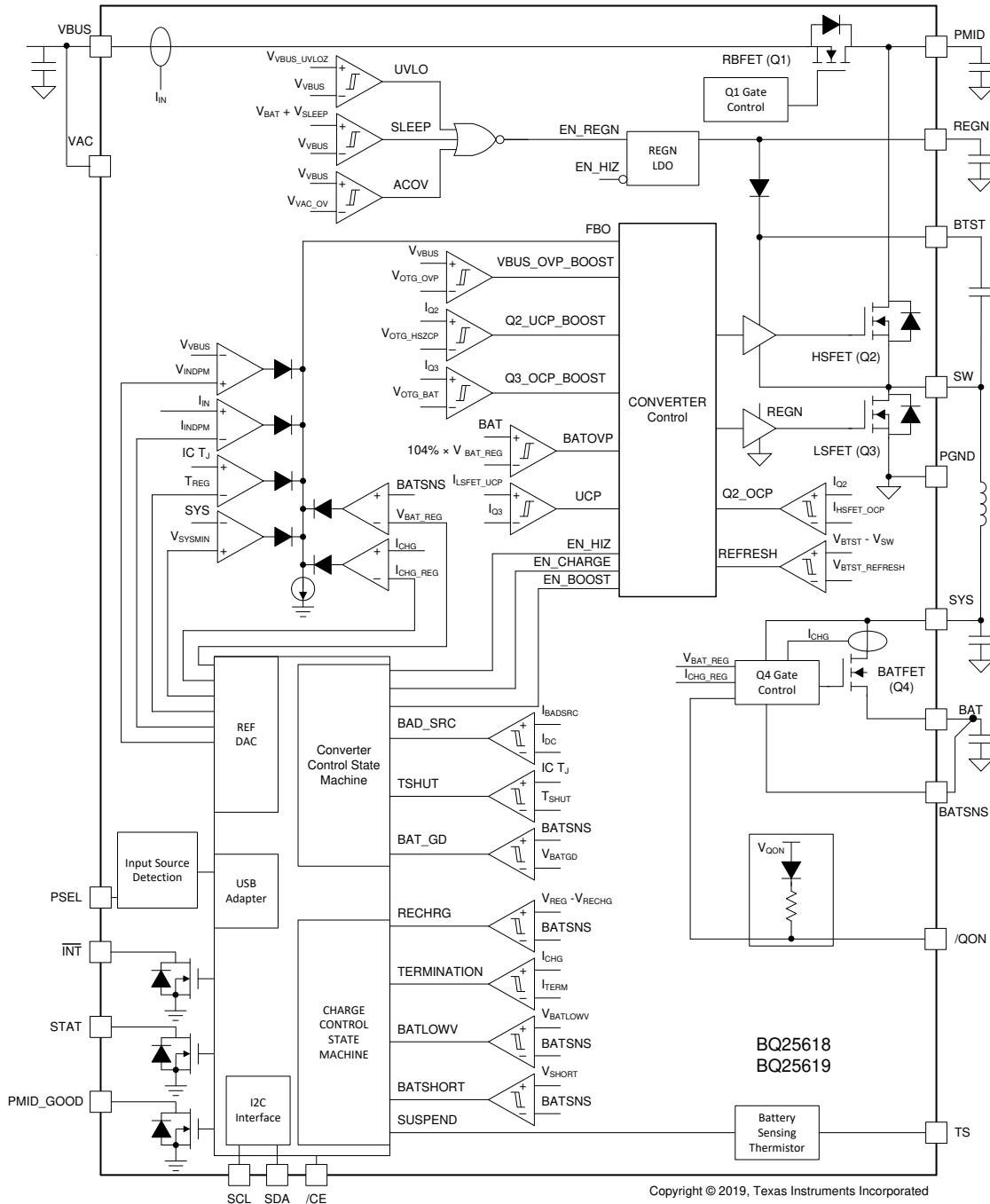



## 7.3 Feature Description

### 7.3.1 Power-On-Reset (POR)

The device powers internal bias circuits from the higher voltage of V<sub>BUS</sub> and BAT. When V<sub>BUS</sub> rises above V<sub>BUS\_UVLOZ</sub> or V<sub>BAT</sub> rises above V<sub>BAT\_UVLOZ</sub>, the sleep comparator, battery depletion comparator, and BATFET driver are active. The I<sup>2</sup>C interface is ready for communication and all registers are reset to default values. The host can access all registers after POR.

### 7.3.2 Device Power Up From Battery Without Input Source

If only the battery is present and the voltage is above depletion threshold (V<sub>BAT\_DPLZ</sub>), the BATFET turns on and connects the battery to the system. The REGN stays off to minimize the quiescent current. The low R<sub>DS(on)</sub> of BATFET and the low quiescent current on BAT minimize the conduction loss and maximize the battery run time.

The device always monitors the discharge current through the BATFET. When the system is overloaded or shorted (I<sub>BAT</sub> > I<sub>SYS\_OCP\_Q4</sub>), the device turns off BATFET immediately.

With I<sup>2</sup>C, when the BATFET turns off due to overcurrent, the device sets the BATFET\_DIS bit to indicate the BATFET is disabled until the input source plugs in again or one of the methods described in [节 7.3.7.2](#) is applied to re-enable BATFET.

### 7.3.3 Power Up From Input Source

When an input source is plugged in, the device checks the input source voltage to turn on the REGN LDO and all the bias circuits. It detects and sets the input current limit before the buck converter is started. The power-up sequence from input source is as listed:

1. Power Up REGN LDO, see [节 7.3.3.1](#)
2. Poor Source Qualification, see [节 7.3.3.2](#)
3. Input Source Type Detection is based on PSEL to set default input current limit (IINDPM threshold), see [节 7.3.3.3](#)
4. Input Voltage Limit Threshold Setting (VINDPM threshold), see [节 7.3.3.4](#)
5. Power Up Converter, see [节 7.3.3.5](#)

#### 7.3.3.1 Power Up REGN LDO

The REGN LDO supplies internal bias circuits as well as the HSFET and LSFET gate drive. It also provides the bias rail to TS external resistors. The pull-up rail of STAT can be connected to REGN as well. The REGN LDO is enabled when all the below conditions are valid:

- V<sub>BUS</sub> > V<sub>BUS\_UVLOZ</sub>
- In buck mode, V<sub>BUS</sub> > V<sub>BAT</sub> + V<sub>SLEEPZ</sub>
- In boost mode, V<sub>BUS</sub> < V<sub>BAT</sub> + V<sub>SLEEPZ</sub>
- After 220-ms delay is completed

During high impedance mode when EN\_HIZ bit is 1, REGN LDO turns off. The battery powers up the system.

#### 7.3.3.2 Poor Source Qualification

After the REGN LDO powers up, the device starts to check current capability of the input source. The first step is poor source detection.

- V<sub>BUS</sub> voltage above V<sub>POORSRC</sub> when pulling I<sub>BADSRC</sub> (typical 30 mA)

With I<sup>2</sup>C, once the input source passes poor source detection, the status register bit V<sub>BUS\_GD</sub> is set to 1 and the  $\overline{\text{INT}}$  pin is pulsed to signal to the host.

If the device fails the poor source detection, it repeats poor source qualification every 2 seconds.

### 7.3.3.3 Input Source Type Detection (IINDPM Threshold)

After poor source detection, the device runs input source detection through the PSEL pin. The PSEL pin sets input current limit 0.5 A (HIGH) or 2.4 A (LOW). After input source type detection is completed, the PMID\_GOOD pin is asserted to HIGH and the PG\_STAT bit goes to 1.

With I<sup>2</sup>C, after input source type detection is completed, an  $\overline{\text{INT}}$  pulse is asserted to the host. In addition, the following register bits are updated:

1. Input Current Limit (IINDPM) register is updated from detection result
2. VBUS\_STAT bit is updated to indicate USB or other input source
3. PG\_STAT bit is updated to indicate good adapter plugs in

The host can overwrite the IINDPM register to change the input current limit if needed.

#### 7.3.3.3.1 PSEL Pins Sets Input Current Limit

The device with the PSEL pin directly takes the USB PHY device output to decide whether the input is a USB host or charging port. When the device operates in host-control mode, the host needs the INDET\_EN bit set to 1 to update the IINDPM register. When the device is in default mode, the PSEL value updates IINDPM in real time.

表 7-1. Input Current Limit Setting from PSEL

INPUT DETECTION	PSEL PIN	INPUT CURRENT LIMIT (ILIM)	VBUS_STAT
USB SDP	HIGH	500 mA	001
Adapter	LOW	2.4 A	011

### 7.3.3.4 Input Voltage Limit Threshold Setting (VINDPM Threshold)

The device has two modes to set the VINDPM threshold.

- Fixed VINDPM threshold. VINDPM is in default set at 4.5 V (programmable from 3.9 V to 5.4 V).
- VINDPM threshold tracks the battery voltage to optimize the converter headroom between input and output. When it is enabled in REG07[1:0], the actual input voltage limit is the higher of the VINDPM setting in register and  $V_{\text{BAT}} + \text{offset voltage in VINDPM\_BAT\_TRACK}[1:0]$ .

### 7.3.3.5 Power Up Converter in Buck Mode

After the input current limit is set, the converter is enabled and the HSFET and LSFET start switching. The system voltage is powered from the converter instead of the battery. If battery charging is disabled, the BATFET turns off. Otherwise, the BATFET stays on to charge the battery.

The device provides soft start when the system rail is ramping up. When the system rail is below  $V_{\text{BAT\_SHORT}}$ , the input current is limited to the lower of 200 mA or IINDPM register setting. The system load should be appropriately planned not to exceed the 200-mA IINDPM limit. After the system rises above  $V_{\text{BAT\_SHORTZ}}$ , the device input current limit is the value set by the IINDPM register.

As a battery charger, the device deploys a highly efficient 1.5-MHz step-down switching regulator. The fixed frequency oscillator keeps tight control of the switching frequency under all conditions of input voltage, battery voltage, charge current, and temperature simplifying output filter design.

The converter supports PFM operation by default for fast transient response during system voltage regulation and better light load efficiency. The PFM\_DIS bit disables PFM operation if system voltage is not in regulation.

### 7.3.3.6 HIZ Mode with Adapter Present

By setting the EN\_HIZ bit to 1 with adapter, the device enters a high impedance state (HIZ). In HIZ mode, the system is powered from the battery even with good adapter present. The device is in the low input quiescent current state with Q1 RBFET, REGN LDO, and the bias circuits off.

### 7.3.4 Boost Mode Operation From Battery

The device supports boost converter operation to deliver power from the battery to other portable devices through a USB port. The output voltage is regulated at 5 V (programmable 4.6/4.75/5.0/5.15 V) and output current is up to 1 A. The user needs to have at least 350 mV between  $V_{BAT}$  and Boost mode regulation voltage ( $V_{BST}$ ) to power up Boost mode reliably. For example, the BOOSTV[1:0] setting is recommended to be 4.75 V or higher if the battery voltage is 4.4 V.

Boost operation is enabled if the conditions below are valid:

1. Register setting: BATFET\_DIS = 0, CHG\_COFNIG = 0 and BST\_CONFIG = 1
2. BAT above  $V_{BST\_BAT}$  set by MIN\_VBAT\_SEL bit,
3. VBUS less than  $V_{BAT} + V_{SLEEP}$  (in sleep mode) before converter starts.
4. Voltage at TS (thermistor) pin, as a percentage of  $V_{REGN}$ , is within acceptable range ( $V_{BHOT\_RISE\%} < V_{TS\%} < V_{BCOLD\_FALL\%}$ )

During Boost mode, the status register VBUS\_STAT bits are set to 111.

The converter supports PFM operation at light load in Boost mode. The PFM\_DIS bit can be used to disable PFM operation in boost configuration.

The BQ25619/618 keeps the Q1 FET off during Boost mode. During adapter plug-in or removal, the charger automatically transitions between charging mode and Boost mode by setting the BST\_CONFIG bit and CHG\_CONFIG bit both to 1. When the adapter plugs in and the conditions to start a new charge cycle are valid, the device is in charging mode. If the adapter is removed and the boost enable conditions are valid, the device transits to Boost mode to power the accessories connected to PMID automatically.

### 7.3.5 Power Path Management

The device accommodates a wide range of input sources such as USB, wall adapter, or car charger. The device provides automatic power path selection to supply the system (SYS) from the input source (VBUS), battery (BAT), or both.

#### 7.3.5.1 Narrow VDC Architecture

When the battery is below the minimum system voltage setting, the BATFET operates in linear mode (LDO mode), and the system is typically 180 mV above the minimum system voltage setting. As the battery voltage rises above the minimum system voltage, the BATFET is fully on and the voltage difference between the system and battery is the  $V_{DS}$  of the BATFET.

When battery charging is disabled and above the minimum system voltage setting or charging is terminated, the system is always regulated at typically 50 mV above the battery voltage. The status register VSYS\_STAT bit goes to 1 when the system is in minimum system voltage regulation.



图 7-1. System Voltage vs Battery Voltage

### 7.3.5.2 Dynamic Power Management

To meet the maximum current limit in the USB specification and avoid overloading the adapter, the device features Dynamic Power Management (DPM), which continuously monitors the input current and input voltage. When input source is overloaded, either the current exceeds the input current limit (IINDPM) or the voltage falls below the input voltage limit (VINDPM). The device then reduces the charge current until the input current falls below the input current limit or the input voltage rises above the input voltage limit.

When the charge current is reduced to zero, but the input source is still overloaded, the system voltage starts to drop. Once the system voltage falls below the battery voltage, the device automatically enters the supplement mode where the BATFET turns on and the battery starts discharging so that the system is supported from both the input source and battery.

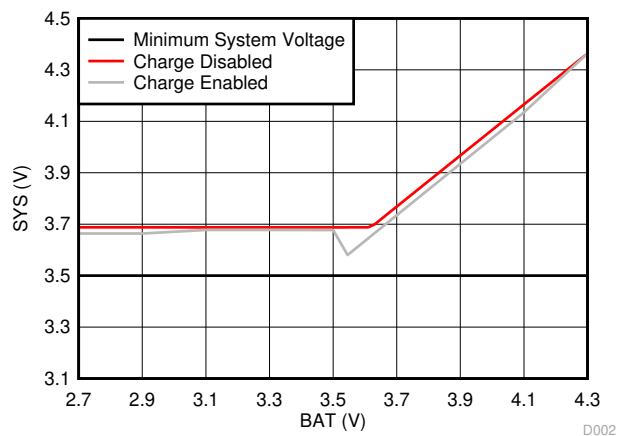
During DPM mode, the status register bits VINDPM\_STAT or IINDPM\_STAT go to 1.

### 7.3.5.3 Supplement Mode

When the system voltage falls below the battery voltage, the BATFET turns on and the BATFET gate is regulated so that the minimum BATFET  $V_{DS}$  stays at 30 mV when the current is low. This prevents oscillation from entering and exiting the supplement mode.

As the discharge current increases, the BATFET gate is regulated with a higher voltage to reduce  $R_{DS(on)}$  until the BATFET is in full conduction. At this point onwards, the BATFET  $V_{DS}$  linearly increases with discharge current. 图 7-2 shows the V-I curve of the BATFET gate regulation operation. The BATFET turns off to exit supplement mode when the battery is below battery depletion threshold.



图 7-2. BAFET V-I Curve

### 7.3.6 Battery Charging Management

The device charges a 1-cell Li-ion battery with up to 1.5-A charge current for a high capacity tablet battery. The 19.5-m $\Omega$  BATFET improves charging efficiency and minimizes the voltage drop during discharging.

#### 7.3.6.1 Autonomous Charging Cycle

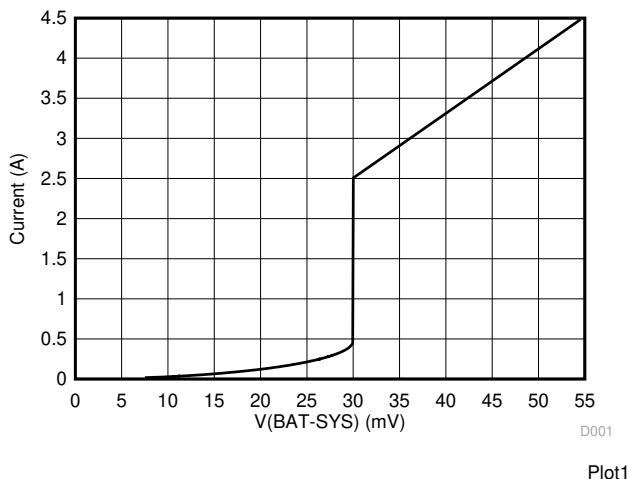
When battery charging is enabled (CHG\_CONFIG bit = 1 and  $\overline{CE}$  pin is LOW), the device autonomously completes a charging cycle without host involvement. The device default charging parameters are listed in 表 7-2. The host configures the power path and charging parameters by writing to the corresponding registers through I<sup>2</sup>C.

表 7-2. Charging Parameter Default Settings

DEFAULT MODE	BQ25619/618
Charging voltage	4.20 V
Charging current	340 mA

**表 7-2. Charging Parameter Default Settings (续)**

DEFAULT MODE	BQ25619/618
Pre-charge current	40 mA
Termination current	60 mA
Temperature profile	JEITA
Safety timer	10 hours

A new charge cycle starts when the following conditions are valid:

- Converter starts
- Battery charging is enabled (CHG\_CONFIG bit = 1 and  $I_{CHG}$  register is not 0 mA and  $\overline{CE}$  is low)
- No thermistor fault on TS. (TS pin can be ignored by setting TS\_IGNORE bit to 1)
- No safety timer fault
- BATFET is not forced to turn off (BATFET\_DIS bit = 0)

The device automatically terminates the charging cycle when the charging current is below the termination threshold, the battery voltage is above the recharge threshold, and the device is not in DPM mode or thermal regulation. When a fully charged battery is discharged below recharge threshold (selectable through VRECHG bit), the device automatically starts a new charging cycle. After the charge is done, a toggle of the  $\overline{CE}$  pin or CHG\_CONFIG bit initiates a new charging cycle. Adapter removal and replug will also restart a charging cycle.

The STAT output indicates charging status: charging (LOW), charging complete or charge disable (HIGH), or charging fault (blinking). The status register (CHRG\_STAT) indicates the different charging phases: 00-charging disable, 01-precharge, 10-fast charge (CC) and constant voltage (CV), 11-charging done. Once a charging cycle is completed, an INT pulse is asserted to notify the host.

### 7.3.6.2 Battery Charging Profile

The device charges the battery in five phases: battery short, preconditioning, constant current, constant voltage, and top-off trickle charging (optional). At the beginning of a charging cycle, the device checks the battery voltage and regulates current and voltage accordingly.

Resistance between charger output and battery cell terminal such as board routing, connector, MOSFETs, and sense resistor can force the charging process to move from constant current to constant voltage too early and increase charge time. To speed up the charging cycle, the device provides the BATSNS pin to extend the constant current charge time to deliver maximum power to battery. The BATSNS pin is connected directly to the battery cell terminal to remotely sense battery cell voltage. BATSNS is by default enabled and can be disabled through the BATSNS\_DIS bit. If BATSNS is connected to GND or left floating, the charger regulates the BAT pin instead.

**表 7-3. Charging Current Setting**

$V_{BAT}$	CHARGING CURRENT	DEFAULT SETTING	CHRG_STAT
< 2.2 V	$I_{BAT\_SHORT}$	25 mA	01
2.2 V to 3 V	$I_{PRECHG}$	40 mA	01
> 3 V	$I_{CHG}$	340 mA	10



图 7-3. Battery Charging Profile

### 7.3.6.3 Charging Termination

The device terminates a charge cycle when the battery voltage is above the recharge threshold, and the current is below termination current. After the charging cycle has completed, the BATFET turns off. STAT is asserted HIGH to indicate charging is done. The converter keeps running to power the system, and BATFET can turn on again to engage 节 7.3.5.3.

If the device is in IINDPM/VINDPM regulation, or thermal regulation, the actual charging current will be less than the termination value. In this case, termination is temporarily disabled.

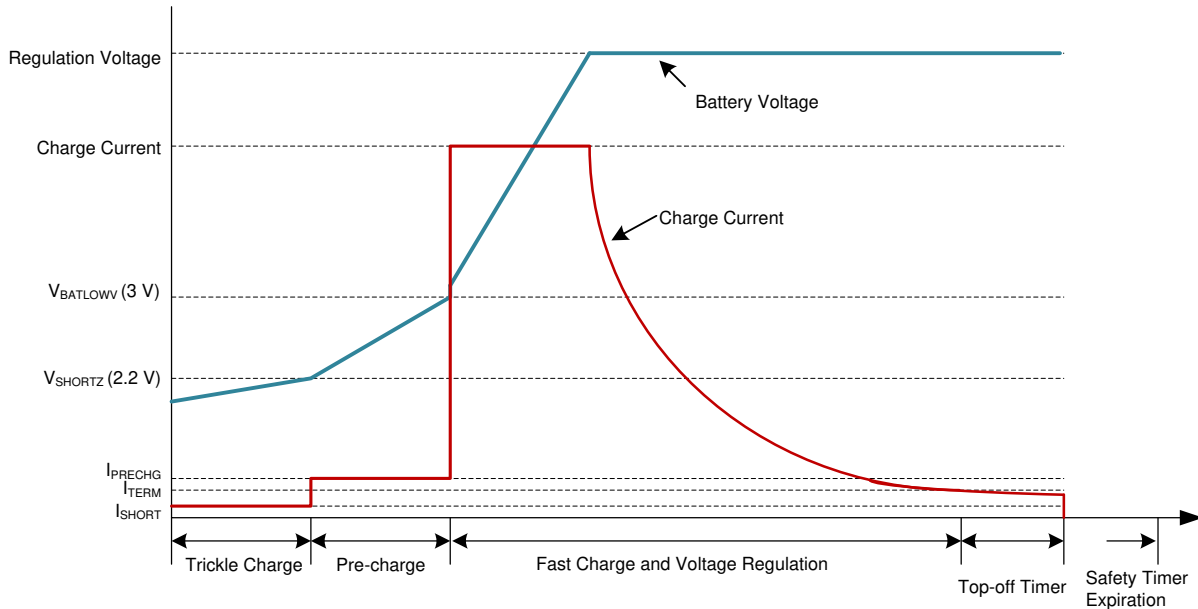
When termination occurs, the STAT pin goes HIGH. The status register CHRG\_STAT is set to 11, and an  $\overline{\text{INT}}$  pulse is asserted to the host. Termination can be disabled by writing 0 to the EN\_TERM bit prior to charge termination.

Termination current is set in REG03[3:0]. For a small capacity battery, the termination current can be set as low as 20 mA for full charge. Due to the termination current accuracy, the actual termination current may be higher than the termination target. In order to compensate for termination accuracy, a programmable top-off timer can be applied after termination is detected. The top-off timer will follow safety timer constraints, such that if the safety timer is suspended, so will the top-off timer. Similarly, if the safety timer is doubled, so will the termination top-off timer. The TOPOFF\_ACTIVE bit reports whether the top-off timer is active or not. The host can read CHRG\_STAT and TOPOFF\_ACTIVE to find out the termination status. The STAT pin stays HIGH during a top-off timer counting cycle.

Top-off timer settings are read in once termination is detected by the charger. Programming a top-off timer value (01, 10, 11) after termination has no effect unless a recharge cycle is initiated. The top-off timer immediately stops if it is disabled (00). An  $\overline{\text{INT}}$  is asserted to the host when entering a top-off timer segment as well as when the top-off timer expires.

### 7.3.6.4 Thermistor Qualification

The device provides a single thermistor input for battery temperature monitoring.

### 7.3.6.4.1 JEITA Guideline Compliance During Charging Mode

To improve the safety of charging Li-ion batteries, the JEITA guideline was released on April 20, 2007. The guideline emphasized the importance of avoiding a high charge current and high charge voltage at certain low and high temperature ranges.

To initiate a charge cycle, the voltage on TS pin, as a percentage of  $V_{REGN}$ , must be within the  $V_{T1\_FALL\%}$  to  $V_{T5\_RISE\%}$  thresholds. If the TS voltage percentage exceeds the T1-T5 range, the controller suspends charging, a TS fault is reported and waits until the battery temperature is within the T1-T5 range.

At cool temperature (T1-T2), the charge current is reduced to a programmable fast charge current (0%, 20% default, 50%, 100% of  $I_{CHG}$ , by JEITA\_ISET). At warm temperature (T3-T5), the charge voltage is reduced to 4.1 V or kept at  $V_{REG}$  (JEITA\_VSET), and the charge current can be reduced to a programmable level (0%, 20%, 50%, 100% default). Battery termination is disabled in T3-T5. The charger provides more flexible settings on a T2 and T3 threshold as well to program the temperature profile beyond JEITA. When T1 is set to 0°C and T5 is set to 60°C, T2 can be programmed to 5.5°C/10°C (default)/15°C/20°C, and T3 can be programmed to 40°C/45.5°C (default)/50.5°C/54.5°C.

When the charger does not need to monitor the NTC, the host sets the TS\_IGNORE bit to 1 to ignore the TS pin condition during charging and Boost mode. If the TS\_IGNORE bit is set to 1, the TS pin is ignored and the charger ignores the TS pin input. In this case, the NTC\_FAULT bits are 000 to report normal TS status.



图 7-4. JEITA Profile

方程式 1 through 方程式 2 describe how to calculate resistor divider values on the TS pin.



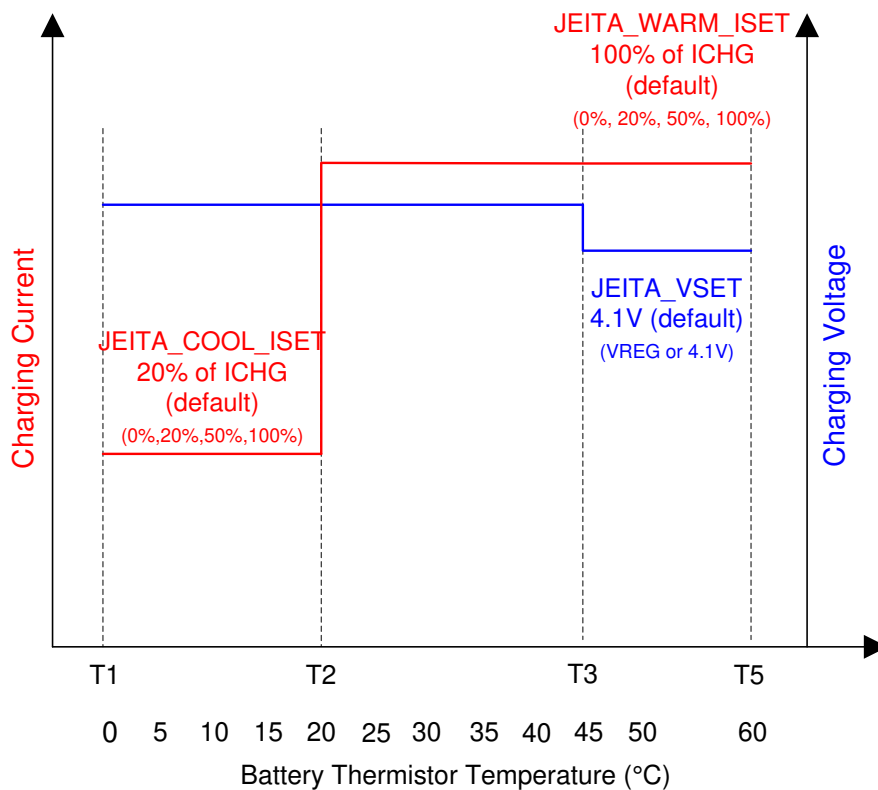

图 7-5. TS Pin Resistor Network

$$RT1 = \frac{\frac{1}{V_{T1\%}} - 1}{\frac{1}{R_{T2}} + \frac{1}{R_{NTC,T1}}} \quad (1)$$

$$RT2 = \frac{R_{NTC,T1} \times R_{NTC,T5} \times \left( \frac{1}{V_{T5\%}} - \frac{1}{V_{T1\%}} \right)}{R_{NTC,T1} \times \left( \frac{1}{V_{T1\%}} - 1 \right) - R_{NTC,T5} \times \left( \frac{1}{V_{T5\%}} - 1 \right)} \quad (2)$$

In the equations above,  $R_{NTC, T1}$  is the NTC thermistor resistance value at temperature T1 and  $R_{NTC, T5}$  is the NTC thermistor resistance value at temperature T5. Selecting a 0°C to 60°C range for a Li-ion or Li-polymer battery then:

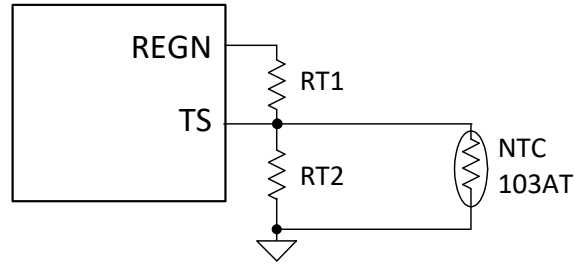
- $R_{NTC,T1} = 27.28 \text{ k}\Omega$  (0°C)
- $R_{NTC,T5} = 3.02 \text{ k}\Omega$  (60°C)
- $RT1 = 5.3 \text{ k}\Omega$
- $RT2 = 31.14 \text{ k}\Omega$

#### 7.3.6.4.2 Boost Mode Thermistor Monitor During Battery Discharge Mode

For battery protection during Boost mode, the device monitors battery temperature to be within the  $V_{BCOLD}$  and  $V_{BHOT}$  thresholds. When  $RT1$  is  $5.3 \text{ k}\Omega$  and  $RT2$  is  $31.14 \text{ k}\Omega$ ,  $T_{BCOLD}$  default is  $-19.5^\circ\text{C}$  and  $T_{BHOT}$  default is  $64^\circ\text{C}$ . When the temperature is outside of the temperature thresholds, Boost mode is suspended. In addition, the  $VBUS\_STAT$  bits are set to 000 and  $NTC\_FAULT$  is reported. Once the temperature returns within the thresholds, Boost mode is recovered and  $NTC\_FAULT$  is cleared.

#### 7.3.6.5 Charging Safety Timer

The device has a built-in safety timer to prevent an extended charging cycle due to abnormal battery conditions. The safety timer is 2 hours when the battery is below the  $V_{BATLOWV}$  threshold and 10 hours (10/20 hours in  $REG05[2]$ ) when the battery is higher than the  $V_{BATLOWV}$  threshold. When the safety timer expires, the  $STAT$  pin is blinking at 1 Hz to report a safety timer expiration fault.

The user can program the fast charge safety timer through I<sup>2</sup>C ( $CHG\_TIMER$  bit  $REG05[2]$ ). When the safety timer expires, the fault register  $CHRG\_FAULT$  bits ( $REG09[5:4]$ ) are set to 11 and an  $\overline{INT}$  is asserted to the host. The safety timer (both fast charge and precharge) can be disabled through I<sup>2</sup>C by setting the  $EN\_TIMER$  bit.

During IINDPM/VINDPM regulation, thermal regulation, or JEITA cool/warm when fast charge current is reduced, the safety timer counts at a half clock rate, because the actual charge current is likely below the setting. For example, if the charger is in input current regulation ( $IINDPM\_STAT = 1$ ) throughout the whole charging cycle, and the safety time is set to 10 hours, the safety timer will expire in 20 hours. This half clock rate feature can be disabled by writing 0 to the  $TMR2X\_EN$  bit.



During faults of BAT\_FAULT, NTC\_FAULT that lead to charging suspend, the safety timer is suspended as well. Once the fault goes away, the timer resumes. If the user stops the current charging cycle, and starts it again, the timer gets reset (toggle of CE pin or CHG\_CONFIG bit).

### 7.3.7 Ship Mode and QON Pin

#### 7.3.7.1 BATFET Disable (Enter Ship Mode)

To extend battery life and minimize power when the system is powered off during system idle, shipping, or storage, the device turns off BATFET so that the system voltage is floating to minimize the battery leakage current. When the host sets the BATFET\_DIS bit, the charger can turn off the BATFET immediately or delay by  $t_{\text{BATFET\_DLY}}$  as configured by the BATFET\_DLY bit. To set the device into ship mode with the adapter present, the host has to first set BATFET\_RST\_VBUS to 1 and then BATFET\_DIS to 1. The charger will turn off the BATFET (no charging, no supplement) while the adapter is still attached. When the adapter is removed, the charger will enter ship mode.

#### 7.3.7.2 BATFET Enable (Exit Ship Mode)

When the BATFET is disabled (in ship mode) as indicated by setting BATFET\_DIS, one of the following events can enable the BATFET to restore system power:

1. Plug in adapter
2. Clear BATFET\_DIS bit
3. Set REG\_RST bit to reset all registers including BATFET\_DIS bit to default (0)
4. A logic high to low transition on QON pin with  $t_{\text{SHIPMODE}}$  deglitch time to enable BATFET to exit ship mode. EN\_HIZ bit is set to 1 (regardless of adapter present or not). Host has to set EN\_HIZ bit to 0 before boost mode enable. Once adapter plugs in, EN\_HIZ will be cleared.

#### 7.3.7.3 BATFET Full System Reset

The BATFET functions as a load switch between the battery and system when an input source is not plugged in. When BATFET\_RST\_EN = 1 and BATFET\_DIS = 0, the BATFET full system reset function is enabled. By changing the state of BATFET from on to off, systems connected to SYS can be effectively forced to have a power-on-reset. After the reset is complete, the device is in the POR state, and all registers are in POR default settings. The QON pin supports a push-button interface to reset system power without the host by changing the state of BATFET. Internally, it is pulled up to the  $V_{\text{QON}}$  voltage through a 200-k $\Omega$  resistor.

When the QON pin is driven to logic low for  $t_{\text{QON\_RST}}$ , the BATFET reset process starts. The BATFET is turned off for  $t_{\text{BATFET\_RST}}$  and then it is re-enabled to reset system power. This function can be disabled by setting the BATFET\_RST\_EN bit to 0.

The BATFET full system reset functions either with or without an adapter present. If BATFET\_RST\_WVBUS = 1, the system reset function starts after  $t_{\text{QON\_RST}}$  when the QON pin is pushed to LOW. Once the reset process starts, the device first goes into HIZ mode to turn off the converter, and then power cycles BATFET. If BATFET\_RST\_WVBUS = 0, the system reset function does not start until  $t_{\text{QON\_RST}}$  after the QON pin is pushed to LOW and the adapter is removed.

After the BATFET full system reset is complete, the device powers up again if EN\_HIZ is not set to 1 before the system reset.



图 7-6. QON Timing

### 7.3.8 Status Outputs (STAT, INT, PMID\_GOOD)

#### 7.3.8.1 Power Good Indicator (PG\_STAT Bit)

The PG\_STAT bit goes to 1 to indicate a good input source when:

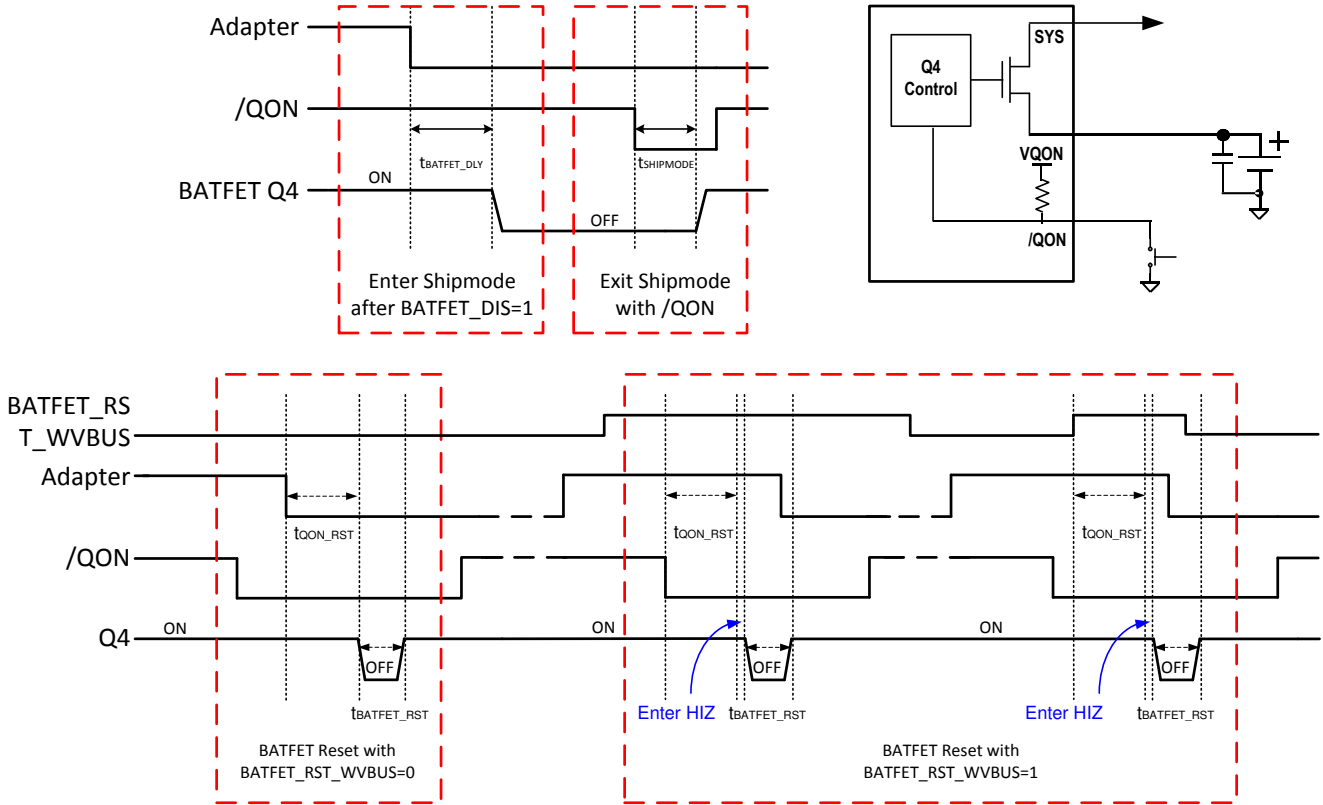
- $V_{VBUS}$  above  $V_{VBUS\_UVLO}$
- $V_{VBUS}$  above battery (not in sleep)
- $V_{VBUS}$  below  $V_{ACOV}$  threshold
- $V_{VBUS}$  above  $V_{POORSRC}$  (typical 3.8 V) when  $I_{BADSRC}$  (typical 30 mA) current is applied (not a poor source)
- Completed [节 7.3.3.3](#)

#### 7.3.8.2 Charging Status Indicator (STAT)

The device indicates the charging state on the open drain STAT pin. The STAT pin can drive an LED.

表 7-4. STAT Pin State

CHARGING STATE	STAT INDICATOR
Charging in progress (including recharge)	LOW
Charging termination (top off timer may be running)	HIGH
Sleep mode, charge disable, Boost mode	HIGH
Charge suspend (input overvoltage, TS fault, safety timer fault, or system overvoltage)	Blinking at 1 Hz

#### 7.3.8.3 Interrupt to Host (INT)

In some applications, the host does not always monitor charger operation. The INT pulse notifies the host on device operation. The following events generate a 256- $\mu$ s INT pulse.

- Good input source detected:
  - $V_{VBUS}$  above battery (not in sleep)

- $V_{VBUS}$  below  $V_{ACOV}$  threshold
- $V_{VBUS}$  above  $V_{POORSRC}$  (typical 3.8 V) when  $I_{BADSRC}$  (typical 30 mA) current is applied (not a poor source)
- Input adapter removed
- USB/adapter source identified during 节 7.3.3.3.
- Charge complete
- Any FAULT event in REG09
- VINDPM / IINDPM event detected (REG0A[1:0], maskable)
- Top-off timer starts and expires

REG09[7:0] and REG0A[6:4] report charger operation faults and status change to the host. When a fault/status change occurs, the charger sends out an  $\overline{INT}$  pulse and keeps the state in REG09[7:0]/REG0A[6:4] until the host reads the registers. Before the host reads REG09[7:0]/REG0A[6:4] and all the ones are cleared, the charger does not send any  $\overline{INT}$  upon new fault/status change. To read the current status, the host has to read REG09/REG0A two times consecutively. The first read reports the pre-existing register status and the second read reports the current register status.

#### 7.3.8.4 PMID Voltage Indicator (PMID\_GOOD)

In the BQ25619/618, the accessory devices can be connected to the charger PMID pin to get power either from the adapter through the Q1 direct path or from battery Boost mode. An optional external PMOS FET can be placed between the charger PMID pin and accessory input to disconnect the power path during overcurrent and overvoltage conditions. PMID\_GOOD is used to drive an external PMOS FET through an inverter. PMID\_GOOD HIGH turns on an inverter to pull the PMOS FET gate low to turn on the PMOS FET, and PMID\_GOOD LOW turns off the PMOS FET.

Upon adapter plug-in, PMID\_GOOD goes from LOW to HIGH when VBUS rises above the battery but below  $V_{ACOV}$ , and passes poor source detection. During the operation, PMID\_GOOD goes from HIGH to LOW if Q1 current exceeds 115% of the IINDPM threshold, ( $I_{BLK\_OCP}$ ), or adapter voltage rises above 5.8 V ( $V_{BST\_OVP}$ ).

The high-voltage adapter over  $V_{BST\_OVP}$  keeps charging the battery if all conditions are valid. The external PMOS FET stays off to protect the accessory from an overvoltage fault.

When the adapter is removed, PMID\_GOOD goes LOW before battery Boost mode starts.

In battery Boost mode, the device regulates PMID voltage between 4.6 V to 5.15 V as a stable power supply to the accessory devices. PMID\_GOOD goes from LOW to HIGH when PMID voltage rises above 3.8 V ( $V_{POORSRC}$ ). Similar to the adapter present scenario, the PMID valid voltage range is between  $V_{POORSRC}$  and  $V_{BST\_OVP}$ . Once PMID voltage is out of this range, PMID\_GOOD goes LOW to disconnect the accessory device from PMID. During Boost mode, all of the conditions to exit Boost mode will drive PMID\_GOOD from HIGH to LOW, including Boost mode disable in register, ACOV, TS fault, battery depleted ( $V_{BAT\_DPL}$ ), BATFET overcurrent, ( $I_{SYS\_OCP\_Q4}$ ), etc.

### 7.3.9 Protections

#### 7.3.9.1 Voltage and Current Monitoring in Buck Mode

##### 7.3.9.1.1 Input Overvoltage Protection (ACOV)

The input voltage is sensed via the VAC pin. The default OVP threshold is 14.2 V, and can be programmed at 5.7 V/6.4 V/11 V/14.2 V via OVP[1:0] register bits. ACOV event immediately stops converter switching whether in buck or Boost mode. The device automatically resumes normal operation once the input voltage drops back below the OVP threshold. During ACOV, REGN LDO is on, and the device does not enter HIZ mode.

During ACOV, the fault register CHRG\_FAULT bits are set to 01. An  $\overline{INT}$  pulse is asserted to the host.

##### 7.3.9.1.2 System Overvoltage Protection (YSOV)

The charger device clamps the system voltage during a load transient so that the components connected to the system are not damaged due to high voltage. The  $V_{SYS\_OVP}$  threshold is about 300 mV above battery regulation voltage when battery charging is terminated. Upon SYSOV, the converter stops switching immediately to clamp the overshoot. The charger pulls 30-mA  $I_{SYS\_LOAD}$  discharge current to bring down the system voltage.

### 7.3.9.2 Voltage and Current Monitoring in Boost Mode

#### 7.3.9.2.1 Boost Mode Overvoltage Protection

When PMID voltage rises above the regulation target and exceeds  $V_{BST\_OVP}$ , the device stops switching immediately and the device exits Boost mode and PMID\_GOOD is pulled low as well. The BST\_CONFIG bit is set to 0. During Boost mode overvoltage, the fault register bit BOOST\_FAULT is set to 1 to indicate a fault in boost operation. An  $\overline{INT}$  is asserted to the host.

#### 7.3.9.2.2 PMID Overcurrent Protection

The BQ25619/618 closely monitors the battery discharge current through BATFET (Q4) to ensure safe Boost mode operation. During an overcurrent condition when boost input current exceeds  $I_{SYS\_OCP\_Q4}$ , the device latches off in 100  $\mu$ s. When an overcurrent condition is detected, the fault register bit BOOST\_FAULT is set high to indicate a fault in boost operation. An  $\overline{INT}$  is asserted to the host.

### 7.3.9.3 Thermal Regulation and Thermal Shutdown

#### 7.3.9.3.1 Thermal Protection in Buck Mode

Besides the battery temperature monitor on the TS pin, the device monitors the internal junction temperature  $T_J$  to avoid overheating the chip and limits the IC junction temperature in buck mode. When the internal junction temperature exceeds the thermal regulation limit (110°C), the device lowers down the charge current. During thermal regulation, the actual charging current is usually below the programmed battery charging current. Therefore, termination is disabled, the safety timer runs at half the clock rate, and the status register THERM\_STAT bit goes high.

Additionally, the device has thermal shutdown to turn off the converter and the BATFET when the IC surface temperature exceeds  $T_{SHUT}$  150°C. The BATFET and converter are enabled to recover when IC temperature is 130°C. The fault register CHRГ\_FAULT is set to 10 during thermal shutdown and an  $\overline{INT}$  is asserted to the host.

#### 7.3.9.3.2 Thermal Protection in Boost Mode

Besides the battery temperature monitor on the TS pin, the device monitors the internal junction temperature to provide thermal shutdown during Boost mode. When the IC junction temperature exceeds  $T_{SHUT}$  150°C, Boost mode is disabled by setting the BST\_CONFIG bit low. When the IC junction temperature is below 145°C, the host can re-enable Boost mode.

### 7.3.9.4 Battery Protection

#### 7.3.9.4.1 Battery Overvoltage Protection (BATOVP)

The battery overvoltage limit is clamped at 4% above battery regulation voltage. When battery overvoltage occurs, the charger device immediately stops switching. The fault register BAT\_FAULT bit goes high and an  $\overline{INT}$  is asserted to the host.

#### 7.3.9.4.2 Battery Overdischarge Protection

When the battery is discharged below  $V_{BAT\_DPL\_FALL}$ , the BATFET latches off to protect the battery from overdischarge. To recover from overdischarge latch-off, an input source plug-in is required at VAC/VBUS.

#### 7.3.9.4.3 System Overcurrent Protection

$I_{SYS\_OCP\_Q4}$  sets the battery discharge current limit. Once  $I_{BAT} > I_{SYS\_OCP\_Q4}$ , the charger latches off Q4 and puts the device into Ship mode. All methods to exit Ship mode are valid to bring the part out of Q4 latch-off.

### 7.3.10 Serial Interface

The device uses an I<sup>2</sup>C compatible interface for flexible charging parameter programming and instantaneous device status reporting. I<sup>2</sup>C™ is a bi-directional 2-wire serial interface developed by Philips Semiconductor (now NXP Semiconductors). Only two bus lines are required: a serial data line (SDA) and a serial clock line (SCL). Devices can be considered as masters or slaves when performing data transfers. A master is the device which initiates a data transfer on the bus and generates the clock signals to permit that transfer. At that time, any device addressed is considered a slave.

The device operates as a slave device with address 6AH, receiving control inputs from the master device like a microcontroller or a digital signal processor through REG00 to REG0C. A register read beyond REG0C returns 0xFF. The I<sup>2</sup>C interface supports both standard mode (up to 100 kbits), and fast mode (up to 400 kbits), connecting to the positive supply voltage via a current source or pullup resistor. When the bus is free, both lines are HIGH. The SDA and SCL pins are open drain.

### 7.3.10.1 Data Validity

The data on the SDA line must be stable during the HIGH period of the clock. The HIGH or LOW state of the data line can only change when the clock signal on the SCL line is LOW. One clock pulse is generated for each data bit transferred.

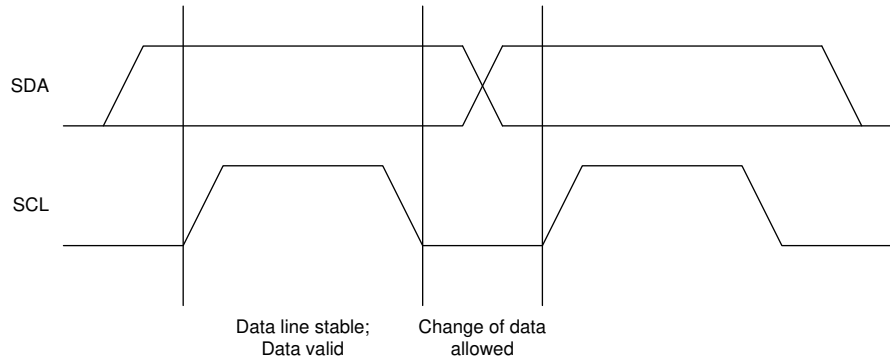

**图 7-7. Bit Transfer on the I<sup>2</sup>C Bus**

### 7.3.10.2 START and STOP Conditions

All transactions begin with a START (S) and can be terminated by a STOP (P). A HIGH to LOW transition on the SDA line while SCL is HIGH defines a START condition. A LOW to HIGH transition on the SDA line when the SCL is HIGH defines a STOP condition. START and STOP conditions are always generated by the master. The bus is considered busy after the START condition, and free after the STOP condition.

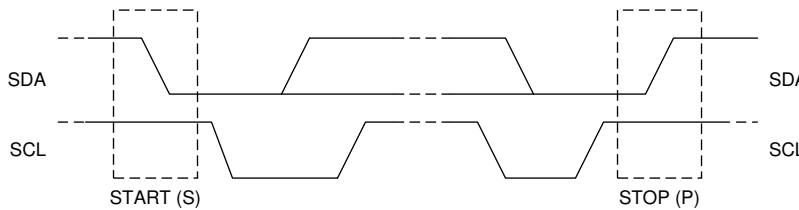

**图 7-8. TS START and STOP conditions**

### 7.3.10.3 Byte Format

Every byte on the SDA line must be 8 bits long. The number of bytes to be transmitted per transfer is unrestricted. Each byte has to be followed by an Acknowledge bit. Data is transferred with the Most Significant Bit (MSB) first. If a slave cannot receive or transmit another complete byte of data until it has performed some other function, it can hold the clock line SCL low to force the master into a wait state (clock stretching). Data transfer then continues when the slave is ready for another byte of data and release the clock line SCL.



图 7-9. Data Transfer on the I<sup>2</sup>C Bus

**7.3.10.4 Acknowledge (ACK) and Not Acknowledge (NACK)**

The acknowledge takes place after every byte. The acknowledge bit allows the receiver to signal the transmitter that the byte was successfully received and another byte may be sent. All clock pulses, including the acknowledge ninth clock pulse, are generated by the master. The transmitter releases the SDA line during the acknowledge clock pulse so the receiver can pull the SDA line LOW and it remains stable LOW during the HIGH period of this clock pulse.

When SDA remains HIGH during the ninth clock pulse, this is the Not Acknowledge signal. The master can then generate either a STOP to abort the transfer or a repeated START to start a new transfer.

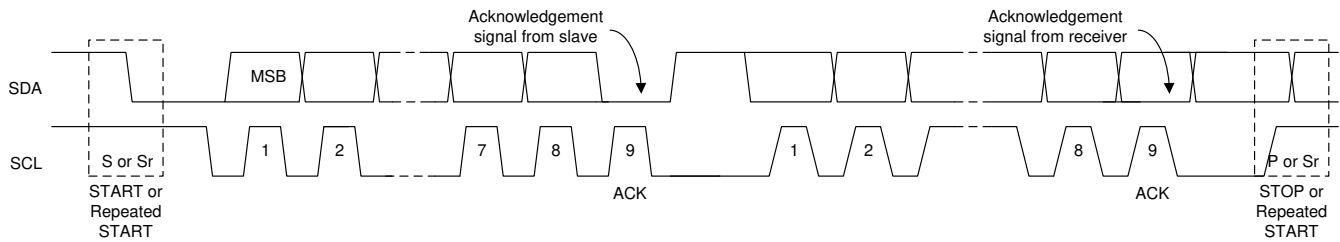
**7.3.10.5 Slave Address and Data Direction Bit**

After the START, a slave address is sent. This address is 7 bits long followed by the eighth bit as a data direction bit (bit R/W). A zero indicates a transmission (WRITE) and a one indicates a request for data (READ).



图 7-10. Complete Data Transfer

**7.3.10.6 Single Read and Write**

If the register address is not defined, the charger IC sends back NACK and goes back to the idle state.

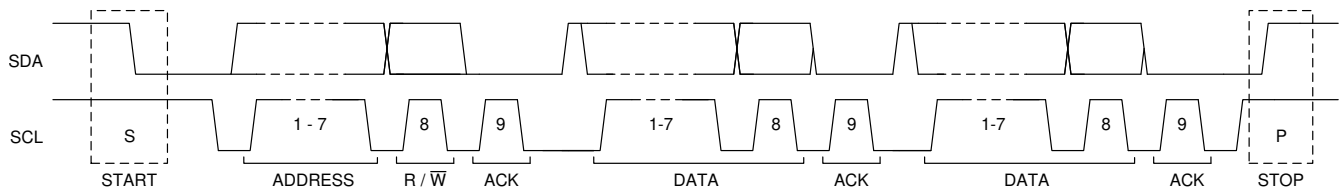

图 7-11. Single Write



图 7-12. Single Read

**7.3.10.7 Multi-Read and Multi-Write**

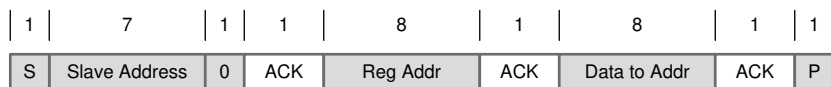
The charger device supports multi-read and multi-write on REG00 through REG0C.

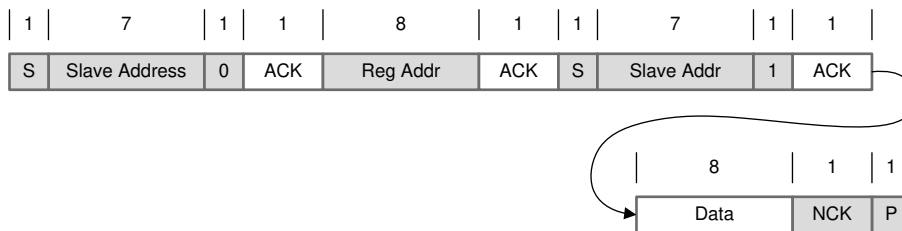

图 7-13. Multi-Write



图 7-14. Multi-Read

REG09[7:0]/REG0A[6:4] are fault/status change registers. They keep all of the fault/status information from the last read until the host issues a new read. For example, if a Charge Safety Timer Expiration fault occurs but recovers later, the fault register REG09 reports the fault when it is read the first time, but returns to normal when it is read the second time. In order to get the fault information at present, the host has to read REG09/REG0A for the second time.

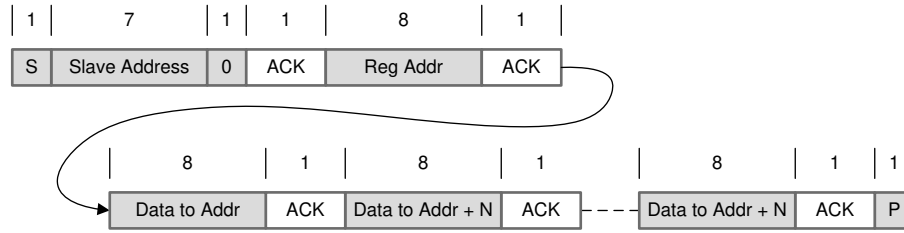
## 7.4 Device Functional Modes

### 7.4.1 Host Mode and Default Mode

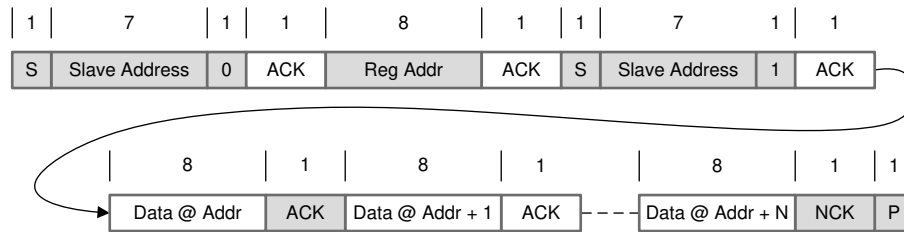
The device is a host controlled charger, but it can operate in default mode without host management. In default mode, the device can be used as an autonomous charger with no host or while the host is in sleep mode. When the charger is in default mode, the WATCHDOG\_FAULT bit is HIGH. When the charger is in host mode, the WATCHDOG\_FAULT bit is LOW.

After power-on-reset, the device starts in default mode with watchdog timer expired, or default mode. All registers are in the default settings.

In default mode, the device keeps charging the battery with the 10-hour fast charging safety timer. At the end of the 10-hour, charging is stopped and the buck converter continues to operate to supply system load. Any write command to the device transitions the charger from default mode to host mode. All device parameters can be programmed by the host. To keep the device in host mode, the host has to reset the watchdog timer by writing a 1 to the WD\_RST bit before the watchdog timer expires (WATCHDOG\_FAULT bit is set), or disable the watchdog timer by setting the WATCHDOG bits = 00.

All device parameters can be programmed by the host. To keep the device in host mode, the host has to reset the watchdog timer by writing a 1 to the WD\_RST bit before the watchdog timer expires (WATCHDOG\_FAULT bit is set), or disable the watchdog timer by setting the WATCHDOG bits = 00.



图 7-15. Watchdog Timer Flow Chart



## 7.5 Register Maps

I<sup>2</sup>C Slave Address: 6AH

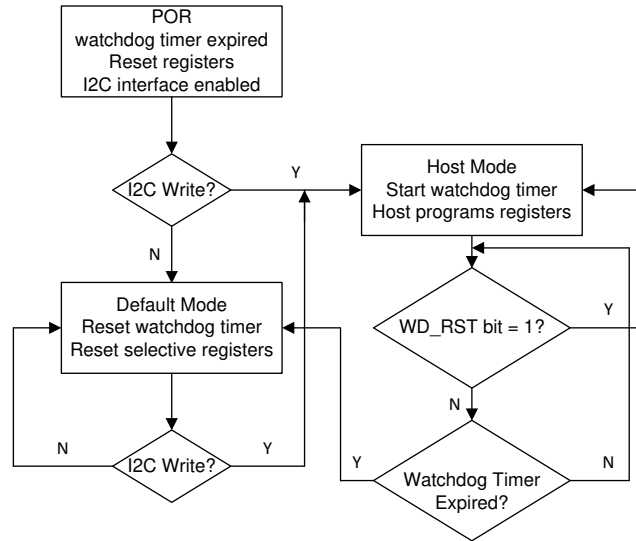
Default I<sup>2</sup>C Slave Address: 0x6A (1101 010B + R/  $\bar{W}$ )

**表 7-5. I<sup>2</sup>C Registers**

Address	Access Type	Acronym	Register Name	Section
00h	R/W	REG00	Input Current Limit	<a href="#">Go</a>
01h	R/W	REG01	Charger Control 0	<a href="#">Go</a>
02h	R/W	REG02	Charge Current Limit	<a href="#">Go</a>
03h	R/W	REG03	Precharge and Termination Current Limit	<a href="#">Go</a>
04h	R/W	REG04	Battery Voltage Limit	<a href="#">Go</a>
05h	R/W	REG05	Charger Control 1	<a href="#">Go</a>
06h	R/W	REG06	Charger Control 2	<a href="#">Go</a>
07h	R/W	REG07	Charger Control 3	<a href="#">Go</a>
08h	R	REG08	Charger Status 0	<a href="#">Go</a>
09h	R	REG09	Charger Status 1	<a href="#">Go</a>
0Ah	R	REG0A	Charger Status 2	<a href="#">Go</a>
0Bh	R	REG0B	Part Information	<a href="#">Go</a>
0Ch	R/W	REG0C	Charger Control 4	<a href="#">Go</a>

Complex bit access types are encoded to fit into small table cells. [表 7-6](#) shows the codes that are used for access types in this section.

**表 7-6. I<sup>2</sup>C Access Type Codes**

Access Type	Code	Description
Read Type		
R	R	Read
Write Type		
W	W	Write
Reset Value		
-n		Value after reset
-X		Undefined value

### 7.5.1 Input Current Limit Register (Address = 00h) [Reset = 17h]

图 7-16. REG00 Register

7	6	5	4	3	2	1	0
0	0	0	1	0	1	1	1
R/W	R/W	R/W	R/W	R/W	R/W	R/W	R/W

LEGEND: R/W = Read/Write; R = Read only; -n = value after reset

表 7-7. REG00 Field Descriptions

Bit	Field	POR	Type	Reset	Description
7	EN_HIZ	0	R/W	by REG_RST by Watchdog	HIZ mode enable in buck mode. 0 - Disable (default) 1 - Enable
6	TS_IGNORE	0	R/W	by REG_RST	When charger does not monitor the NTC, host sets this bit to 1 to ignore the TS pin condition during charging and boost mode. 0 - Include TS pin into charge and boost mode enable conditions. (default) 1 - Ignore TS pin. Always consider TS is good to allow charging and boost mode. NTC_FAULT bits are 000 to report normal status.
5	BATSNS_DIS	0	R/W	by REG_RST	Select either BATSNS pin or BAT pin to regulate battery voltage. 0 - Enable BATSNS in battery CV regulation. If the device fails BATSNS open/short detection (BATSNS_STAT = 1). Battery voltage is regulated through BAT pin. (default) 1 - Disable BATSNS. Use BAT pin in battery CV regulation.
4	IINDPM[4]	1	R/W	by REG_RST	1600 mA
3	IINDPM[3]	0	R/W	by REG_RST	800 mA
2	IINDPM[2]	1	R/W	by REG_RST	400 mA
1	IINDPM[1]	1	R/W	by REG_RST	200 mA
0	IINDPM[0]	1	R/W	by REG_RST	100 mA

Input current limit setting (maximum limit, not typical)  
Offset: 100 mA  
Range: 100 mA (000000) - 3.2 A (11111)  
Default: 2400 mA (10111)  
IINDPM bits are changed automatically after 节 7.3.3.3 is completed  
PSEL HIGH = 500 mA  
PSEL LOW = 2.4 A  
Host can reprogram IINDPM register bits after input source detection is completed.

LEGEND: R/W = Read/Write; R = Read only

### 7.5.2 Charger Control 0 Register (Address = 01h) [Reset = 1Ah]

图 7-17. REG01 Register

7	6	5	4	3	2	1	0
0	0	0	1	1	0	1	0
R/W	R/W	R/W	R/W	R/W	R/W	R/W	R/W

LEGEND: R/W = Read/Write; R = Read only; -n = value after reset

表 7-8. REG01 Field Descriptions

Bit	Field	POR	Type	Reset	Description
7	PFM_DIS	0	R/W	by REG_RST	PFM disable in both buck and boost mode. 0 - PFM enable (default) 1 - PFM disable
6	WD_RST	0	R/W	by REG_RST by Watchdog	I <sup>2</sup> C Watchdog timer reset. Back to 0 after watchdog timer reset 0 - Normal (default) 1 - Reset
5	BST_CONFIG	0	R/W	by REG_RST by Watchdog	Boost mode enable. In charging case application, based on adapter plug-in or removal, the charger will automatically transit between charging mode and boost mode by setting BST_CONFIG bit and CHG_CONFIG bit both to 1. 0 - Boost mode disable (default) 1 - Boost mode enable
4	CHG_CONFIG	1	R/W	by REG_RST by Watchdog	Battery charging buck mode enable. Charging is enabled when $\overline{CE}$ pin is pulled low, CHG_CONFIG bit is 1 and charge current is not zero. 0 - Charge Disable 1 - Charge Enable (default)
3	SYS_MIN[2]	1	R/W	by REG_RST	System minimum voltage setting. 000 - 2.6 V 001 - 2.8 V 010 - 3 V 011 - 3.2 V 100 - 3.4 V 101 - 3.5 V (default) 110 - 3.6 V 111 - 3.7 V
2	SYS_MIN[1]	0	R/W	by REG_RST	
1	SYS_MIN[0]	1	R/W	by REG_RST	
0	MIN_VBAT_SEL	0	R/W	by REG_RST	Minimum battery voltage when exiting boost mode. The rising threshold allows the device to start boost mode if other conditions are valid. 0 - 2.8 V V <sub>BAT</sub> falling, 3 V rising (default) 1 - 2.5 V V <sub>BAT</sub> falling, 2.8 V rising

LEGEND: R/W = Read/Write; R = Read only

### 7.5.3 Charge Current Limit Register (Address = 02h) [Reset = 91h]

图 7-18. REG02 Register

7	6	5	4	3	2	1	0
1	0	0	1	0	0	0	1
R/W	R/W	R/W	R/W	R/W	R/W	R/W	R/W

LEGEND: R/W = Read/Write; R = Read only; -n = value after reset

表 7-9. REG02 Field Descriptions

Bit	Field	POR	Type	Reset	Description
7	Reserved	1	R/W		
6	Q1_FULLON	0	R/W	by REG_RST	In buck mode, charger will fully turn on Q1 RBFET according to this bit setting when IINDPM is below 700 mA. When IINDPM is over 700 mA, Q1 is always fully on. 0 - Partially turn on Q1 for better regulation accuracy when IINDPM is below 700 mA. (default) 1 - Fully turn on Q1 for better efficiency when IINDPM is below 700 mA.
5	ICHG[5]	0	R/W	by REG_RST by Watchdog	640 mA
4	ICHG[4]	1	R/W	by REG_RST by Watchdog	320 mA
3	ICHG[3]	0	R/W	by REG_RST by Watchdog	160 mA
2	ICHG[2]	0	R/W	by REG_RST by Watchdog	80 mA
1	ICHG[1]	0	R/W	by REG_RST by Watchdog	40 mA
0	ICHG[0]	1	R/W	by REG_RST by Watchdog	20 mA

Fast charge current setting  
Default: 340 mA (010001)  
Range: 0 mA (0000001) - 1180 mA (111011), 20 mA/step  
111100: 1290 mA  
111101: 1360 mA  
111110: 1430 mA  
111111: 1500 mA  
ICHG 0 mA disables charge.

LEGEND: R/W = Read/Write; R = Read only

### 7.5.4 Precharge and Termination Current Limit Register (Address = 03h) [Reset = 12h]

图 7-19. REG03 Register

7	6	5	4	3	2	1	0
0	0	0	1	0	0	1	0
R/W	R/W	R/W	R/W	R/W	R/W	R/W	R/W

LEGEND: R/W = Read/Write; R = Read only; -n = value after reset

表 7-10. REG03 Field Descriptions

Bit	Field	POR	Type	Reset	Description
7	IPRECHG[3]	0	R/W	by REG_RST by Watchdog	160 mA
6	IPRECHG[2]	0	R/W	by REG_RST by Watchdog	80 mA
5	IPRECHG[1]	0	R/W	by REG_RST by Watchdog	40 mA
4	IPRECHG[0]	1	R/W	by REG_RST by Watchdog	20 mA
3	ITERM[3]	0	R/W	by REG_RST by Watchdog	160 mA
2	ITERM[2]	0	R/W	by REG_RST by Watchdog	80 mA
1	ITERM[1]	1	R/W	by REG_RST by Watchdog	40 mA
0	ITERM[0]	0	R/W	by REG_RST by Watchdog	20 mA

LEGEND: R/W = Read/Write; R = Read only

### 7.5.5 Battery Voltage Limit Register (Address = 04h) [Reset = 40h]

图 7-20. REG04 Register

7	6	5	4	3	2	1	0
0	1	0	0	0	0	0	0
R/W	R/W	R/W	R/W	R/W	R/W	R/W	R/W

LEGEND: R/W = Read/Write; R = Read only; -n = value after reset

表 7-11. REG04 Field Descriptions

Bit	Field	POR	Type	Reset	Description
7	VBATREG[4]	0	R/W	by REG_RST by Watchdog	Battery voltage setting, also called $V_{REG}$ . Default: 4.200 V (01000)
6	VBATREG[3]	1	R/W	by REG_RST by Watchdog	00000 - 3.504 V 00001 - 3.600 V 00010 - 3.696 V
5	VBATREG[2]	0	R/W	by REG_RST by Watchdog	00011 - 3.800 V 00100 - 3.904 V
4	VBATREG[1]	0	R/W	by REG_RST by Watchdog	00101 - 4.000 V 00110 - 4.100 V 00111 - 4.150 V
3	VBATREG[0]	0	R/W	by REG_RST by Watchdog	01000 - 4.200 V 01001 - 11111 - 4.300 V - 4.520 V, 10 mV/step 01110 4.350 V, 10011 4.400 V, 11000 4.450 V, 11101 4.500 V
2	TOPOFF_TIMER[1]	0	R/W	by REG_RST by Watchdog	Top-off timer setting. 00 - Disabled (default) 01 - 15 minutes
1	TOPOFF_TIMER[0]	0	R/W	by REG_RST by Watchdog	10 - 30 minutes 11 - 45 minutes
0	VRECHG	0	R/W	by REG_RST by Watchdog	Battery recharge threshold setting. 0 - 120 mV (default) 1 - 210 mV

LEGEND: R/W = Read/Write; R = Read only

### 7.5.6 Charger Control 1 Register (Address = 05h) [Reset = 9Eh]

图 7-21. REG05 Register

7	6	5	4	3	2	1	0
1	0	0	1	1	1	1	0
R/W	R/W	R/W	R/W	R/W	R/W	R/W	R/W

LEGEND: R/W = Read/Write; R = Read only; -n = value after reset

表 7-12. REG05 Field Descriptions

Bit	Field	POR	Type	Reset	Description
7	EN_TERM	1	R/W	by REG_RST by Watchdog	Battery charging termination enable. 0 - Disable 1 - Enable (default)
6	Reserved	0	R/W	by REG_RST by Watchdog	Reserved
5	WATCHDOG[1]	0	R/W	by REG_RST by Watchdog	Watchdog timer setting. 00 - Disable timer 01 - 40 s (default) 10 - 80 s 11 - 160 s
4	WATCHDOG[0]	1	R/W	by REG_RST by Watchdog	
3	EN_TIMER	1	R/W	by REG_RST by Watchdog	Battery charging safety timer enable, including both fast charge and precharge timers. Precharge timer is 2 hours. Fast charge timer is set by REG05[2] 0 - Disable 1 - Enable timer (default)
2	CHG_TIMER	1	R/W	by REG_RST by Watchdog	Battery fast charging safety timer setting. 0 - 20 hrs 1 - 10 hrs (default)
1	TREG	1	R/W	by REG_RST by Watchdog	Thermal regulation threshold: 0 - 90°C 1 - 110°C (default)
0	JEITA_VSET (45C-60C)	0	R/W	by REG_RST by Watchdog	Battery voltage setting during JEITA warm (T3 - T5, typically 45C - 60C) 0 - Set charge voltage to 4.1 V (max) (default) 1 - Set charge voltage to V <sub>REG</sub>

LEGEND: R/W = Read/Write; R = Read only

### 7.5.7 Charger Control 2 Register (Address = 06h) [Reset = E6h]

图 7-22. REG06 Register

7	6	5	4	3	2	1	0
1	1	1	0	0	1	1	0
R/W	R/W	R/W	R/W	R/W	R/W	R/W	R/W

LEGEND: R/W = Read/Write; R = Read only; -n = value after reset

表 7-13. REG06 Field Descriptions

Bit	Field	POR	Type	Reset	Description
7	OVP[1]	1	R/W	by REG_RST	$V_{ACOV}$ threshold during buck mode and boost mode.
6	OVP[0]	1	R/W	by REG_RST	00 - 5.85 V 01 - 6.4 V (5-V input) 10 - 11 V (9-V input) 11 - 14.2 V (12-V input) (default)
5	BOOSTV[1]	1	R/W	by REG_RST	Boost regulation voltage setting
4	BOOSTV[0]	0	R/W	by REG_RST	00 - 4.6 V 01 - 4.75 V 10 - 5.0 V (default) 11 - 5.15 V
3	VINDPM[3]	0	R/W	by REG_RST	800 mV
2	VINDPM[2]	1	R/W	by REG_RST	400 mV
1	VINDPM[1]	1	R/W	by REG_RST	200 mV
0	VINDPM[0]	0	R/W	by REG_RST	100 mV
					VINDPM threshold setting Default: 4.5 V (0110) Range: 3.9 V (0000) - 5.4 V (1111) Offset: 3.9 V

LEGEND: R/W = Read/Write; R = Read only



### 7.5.8 Charger Control 3 Register (Address = 07h) [Reset = 4Ch]

图 7-23. REG07 Register

7	6	5	4	3	2	1	0
0	1	0	0	1	1	0	0
R/W	R/W	R/W	R/W	R/W	R/W	R/W	R/W

LEGEND: R/W = Read/Write; R = Read only; -n = value after reset

表 7-14. REG07 Field Descriptions

Bit	Field	POR	Type	Reset	Description
7	IINDET_EN	0	R/W	by REG_RST by Watchdog	Force input source type detection. After the detection is complete, this bit returns to 0. 0 - Not in input current limit detection. (default) 1 - Force input current limit detection when adapter is present.
6	TMR2X_EN	1	R/W	by REG_RST by Watchdog	Safety timer is slowed by 2X during input DPM, JEITA cool/warm or thermal regulation. 0 - Disable. Safety timer duration is set by REG05[2]. 1 - Safety timer slowed by 2X during input DPM (both V and I) or JEITA cool/warm (except I <sub>CHG</sub> =100%), or thermal regulation. (default)
5	BATFET_DIS	0	R/W	by REG_RST	BATFET Q4 ON/OFF control. Set this bit to 1 to enter ship mode. To reset the device with adapter present, the host shall set BATFET_RST_WVBUS to 1 and then BATFET_DIS to 1. 0 - Turn on Q4. (default) 1 - Turn off Q4 after t <sub>BATFET_DLY</sub> delay time (REG07[3])
4	BATFET_RST_WVBUS	0	R/W	by REG_RST	Start BATFET full system reset with or without adapter present. 0 - Start BATFET full system reset after adapter is removed from VBUS. (default) 1 - Start BATFET full system reset when adapter is present on VBUS.
3	BATFET_DLY	1	R/W	by REG_RST	Delay from BATFET_DIS (REG07[5]) set to 1 to BATFET turn off during ship mode. 0 - Turn off BATFET immediately when BATFET_DIS bit is set. 1 - Turn off BATFET after t <sub>BATFET_DLY</sub> (typ 10 s) when BATFET_DIS bit is set. (default)
2	BATFET_RST_EN	1	R/W	by REG_RST by Watchdog	Enable BATFET full system reset. The time to start of BATFET full system reset is based on the setting of BATFET_RST_WVBUS bit. 0 - Disable BATFET reset function 1 - Enable BATFET reset function when REG07[5] is also 1. (default)
1	VINDPM_BAT_TRACK[1]	0	R/W	by REG_RST	Sets VINDPM to track BAT voltage. Actual VINDPM is higher of register value and V <sub>BAT</sub> + VINDPM_BAT_TRACK. 00 - Disable function (VINDPM set by register) (default) 01 - V <sub>BAT</sub> + 200 mV 10 - V <sub>BAT</sub> + 250 mV 11 - V <sub>BAT</sub> + 300 mV
0	VINDPM_BAT_TRACK[0]	0	R/W	by REG_RST	

LEGEND: R/W = Read/Write; R = Read only

### 7.5.9 Charger Status 0 Register (Address = 08h)

图 7-24. REG08

7	6	5	4	3	2	1	0
x	x	x	x	x	x	x	x
R	R	R	R	R	R	R	R

LEGEND: R/W = Read/Write; R = Read only; -n = value after reset

表 7-15. REG08 Field Descriptions

Bit	Field	POR	Type	Reset	Description
7	VBUS_STAT[2]	x	R	NA	VBUS Status register 000 - No input 001 - USB host SDP (500 mA) → PSEL pin HIGH 011 - Adapter 2.4 A → PSEL pin LOW 111 - Boost mode Software current limit is reported in IINDPM register
6	VBUS_STAT[1]	x	R	NA	
5	VBUS_STAT[0]	x	R	NA	
4	CHRG_STAT[1]	x	R	NA	Charging status: 00 - Not charging 01 - Precharge or trickle charge ( $< V_{BATLOWV}$ ) 10 - Fast charging 11 - Charge termination
3	CHRG_STAT[0]	x	R	NA	
2	PG_STAT	x	R	NA	Power Good status: 0 - Power Not Good 1 - Power Good
1	THERM_STAT	x	R	NA	0 - Not in thermal regulation 1 - In thermal regulation
0	VSYS_STAT	x	R	NA	0 - Not in SYS_MIN regulation ( $V_{BAT} > V_{SYS\_MIN}$ ) 1 - In SYS_MIN regulation ( $V_{BAT} < V_{SYS\_MIN}$ )

LEGEND: R/W = Read/Write; R = Read only

### 7.5.10 Charger Status 1 Register (Address = 09h)

图 7-25. REG09 Register

7	6	5	4	3	2	1	0
1	x	x	x	x	x	x	x
R	R	R	R	R	R	R	R

LEGEND: R/W = Read/Write; R = Read only; -n = value after reset

表 7-16. REG09 Field Descriptions

Bit	Field	POR	Type	Reset	Description
7	WATCHDOG_FAULT	1	R	NA	0 - Normal, device is in host mode, 1 - Watchdog timer expiration, device is in default mode.
6	BOOST_FAULT	x	R	NA	0 - Normal 1 - Fault detected in boost mode (any conditions that are not valid for boost operation), including VBUS overloaded (BST_OVP) or battery is too low (BST_BAT)
5	CHRG_FAULT[1]	x	R	NA	00 - Normal
4	CHRG_FAULT[0]	x	R	NA	01 - Input fault 10 - Thermal shutdown 11 - Charge safety timer expiration
3	BAT_FAULT	x	R	NA	0 - Normal, 1 - Battery overvoltage.
2	NTC_FAULT[2]	x	R	NA	TS fault in buck mode
1	NTC_FAULT[1]	x	R	NA	000 - Normal 010 - Warm 011 - Cool 101 - Cold 110 - Hot
0	NTC_FAULT[0]	x	R	NA	TS fault in boost mode 000 - Normal 101 - Cold 110 - Hot

LEGEND: R/W = Read/Write; R = Read only

### 7.5.11 Charger Status 2 Register (Address = 0Ah)

图 7-26. REG0A Register

7	6	5	4	3	2	1	0
x	x	x	x	x	x	0	0
R	R	R	R	R	R	R/W	R/W

LEGEND: R/W = Read/Write; R = Read only; -n = value after reset

表 7-17. REG0A Field Descriptions

Bit	Field	POR	Type	Reset	Description
7	VBUS_GD	x	R	NA	0 - VBUS does not pass poor source detection 1 - VBUS passes poor source detection
6	VINDPM_STAT	x	R	NA	0 - Not in VINDPM 1 - In VINDPM
5	IINDPM_STAT	x	R	NA	0 - Not in IINDPM 1 - In IINDPM
4	BATSNS_STAT	x	R	NA	0 - BATSNS pin is in good connection. Regulation battery voltage through BATSNS pin. 1 - BATSNS pin is open/short. Regulate battery voltage through BAT pin.
3	TOPOFF_ACTIVE	x	R	NA	0 - Top off timer not counting. 1 - Top off timer counting
2	ACOV_STAT	x	R	NA	0 - Not in ACOV 1 - In ACOV
1	VINDPM_INT_MASK	0	R/W	by REG_RST	Allow or block $\overline{\text{INT}}$ pulse assertion to host during VINDPM. 0 - $\overline{\text{INT}}$ is asserted to host during VINDPM (default). 1 - No $\overline{\text{INT}}$ pulse asserted to host during VINDPM.
0	IINDPM_INT_MASK	0	R/W	by REG_RST	Allow or block $\overline{\text{INT}}$ pulse assertion to host during IINDPM. 0 - $\overline{\text{INT}}$ is asserted to host during IINDPM (default). 1 - No $\overline{\text{INT}}$ pulse asserted to host during IINDPM.

LEGEND: R/W = Read/Write; R = Read only

**7.5.12 Part Information Register (Address = 0Bh)**

**图 7-27. REG0B Register**

7	6	5	4	3	2	1	0
0	0	1	0	1	1	0	0
R/W	R	R	R	R	R	R	R

LEGEND: R/W = Read/Write; R = Read only; -n = value after reset

**表 7-18. REG0B Field Descriptions**

Bit	Field	POR	Type	Reset	Description
7	REG_RST	0	R/W	NA	Register reset 0 - Keep current register setting (default). 1 - Reset to default register value and reset safety timer. This bit returns to 0 after register reset is completed.
6	PN[3]	0	R	NA	Reserved
5	PN[2]	1	R	NA	
4	PN[1]	0	R	NA	
3	PN[0]	1	R	NA	
2	Reserved	1	R	NA	Reserved
1	Reserved	0	R	NA	Reserved
0	Reserved	0	R	NA	

LEGEND: R/W = Read/Write; R = Read only

### 7.5.13 Charger Control 4 Register (Address = 0Ch) [Reset = 75h]

图 7-28. REG0C

7	6	5	4	3	2	1	0
0	1	1	1	0	1	0	1
R/W	R/W	R/W	R/W	R/W	R/W	R/W	R/W

LEGEND: R/W = Read/Write; R = Read only; -n = value after reset

表 7-19. REG0C Field Descriptions

Bit	Field	POR	Type	Reset	Description
7	JEITA_COOL_ISET [1]	0	R/W	by REG_RST by Watchdog	Fast charge current setting during cool temperature range (T1 - T2), as percentage of I <sub>CHG</sub> in REG02[5:0].
6	JEITA_COOL_ISET [0]	1	R/W	by REG_RST by Watchdog	00 - No Charge 01 - 20% of I <sub>CHG</sub> (default) 10 - 50% of I <sub>CHG</sub> 11 - 100% of I <sub>CHG</sub> (safety timer does not become 2X)
5	JEITA_WARM_ISET [1]	1	R/W	by REG_RST by Watchdog	Fast charge current setting during warm temperature range (T3 - T5), as percentage of I <sub>CHG</sub> in REG02[5:0].
4	JEITA_WARM_ISET [0]	1	R/W	by REG_RST by Watchdog	00 - No Charge 01 - 20% of I <sub>CHG</sub> 10 - 50% of I <sub>CHG</sub> 11 - 100% of I <sub>CHG</sub> (safety timer does not become 2X) (default)
3	JEITA_VT2 [1]	0	R/W	by REG_RST by Watchdog	00 - VT2% = 70.75% (5.5°C) 01 - VT2% = 68.25% (10°C) (default)
2	JEITA_VT2 [0]	1	R/W	by REG_RST by Watchdog	10 - VT2% = 65.25% (15°C) 11 - VT2% = 62.25% (20°C)
1	JEITA_VT3 [1]	0	R/W	by REG_RST by Watchdog	00 - VT3% = 48.25% (40°C) 01 - VT3% = 44.75% (44.5°C) (default)
0	JEITA_VT3 [0]	1	R/W	by REG_RST by Watchdog	10 - VT3% = 40.75% (50.5°C) 11 - VT3% = 37.75% (54.5°C)

LEGEND: R/W = Read/Write; R = Read only

## 8 Application and Implementation

### 备注

以下应用部分中的信息不属于 TI 器件规格的范围，TI 不担保其准确性和完整性。TI 的客户应负责确定器件是否适用于其应用。客户应验证并测试其设计，以确保系统功能。

### 8.1 Application Information

A typical application consists of the device configured as an I<sup>2</sup>C controlled power path management device and a single cell battery charger for Li-ion and Li-polymer batteries used in a wide range of smart phones and other portable devices. It integrates an input reverse-block FET (RBFET, Q1), high-side switching FET (HSFET, Q2), low-side switching FET (LSFET, Q3), and battery FET (BATFET Q4) between the system and battery. The device also integrates a bootstrap diode for the high-side gate drive.

### 8.2 Typical Application



图 8-1. BQ25619 Application Diagram with Optional PMOS

See the [BQ25618 BMS024 Evaluation Module User's Guide](#) and [BQ25619 BMS025 Evaluation Module EVM User's Guide](#) for complete schematic and component placement with trace and via locations.

## 8.2.1 Design Requirements

For this design example, use the parameters shown in the table below.

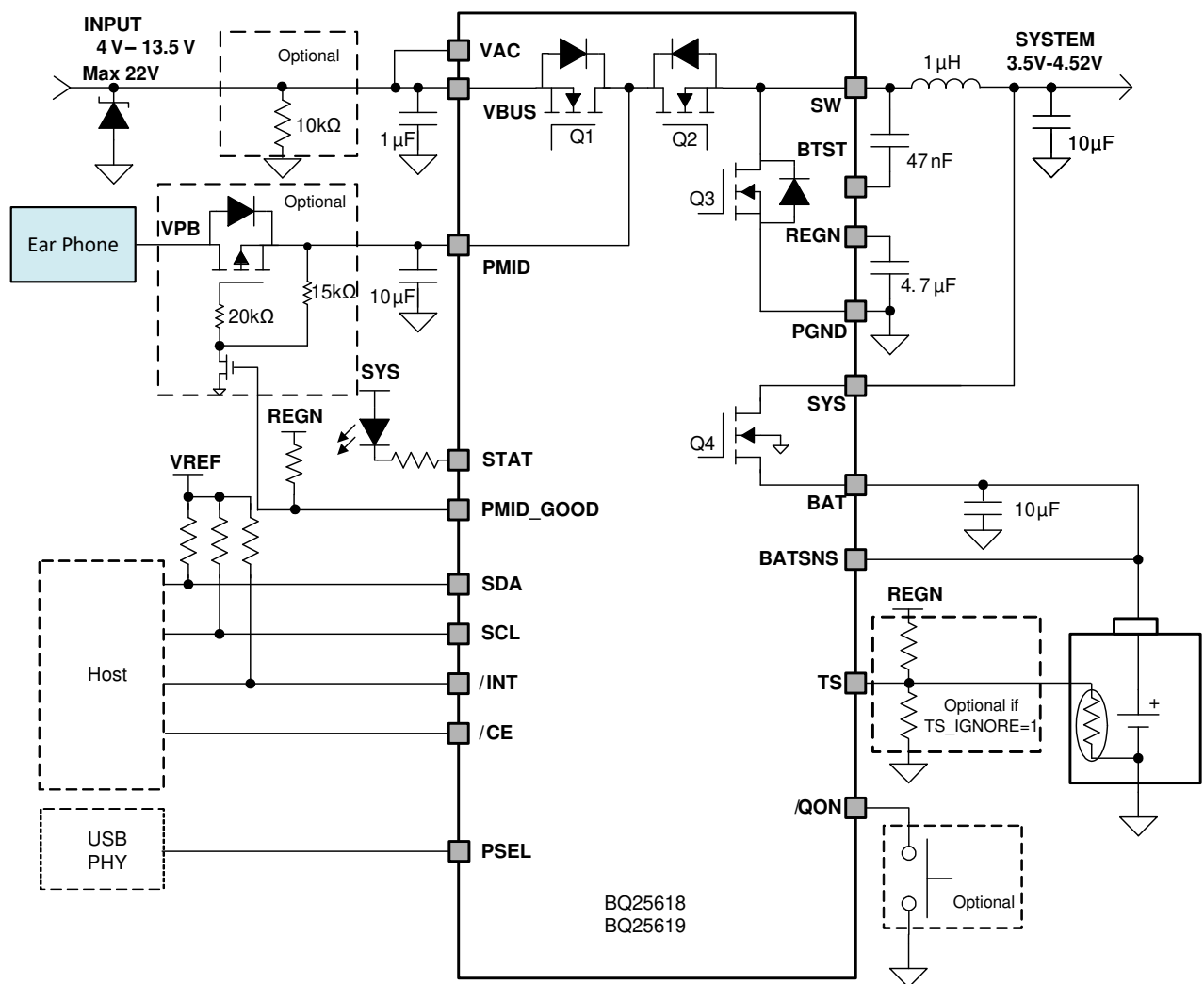
表 8-1. Design Parameters

PARAMETER	VALUE
V <sub>VBUS</sub> voltage range	4 V to 13.5 V
Input current limit (REG00[4:0] )	2.4 A
Fast charge current limit (REG02[5:0] )	1.024 A
Minimum system voltage (REG01[3:1])	3.5 V
Battery regulation voltage (REG04[7:3] )	4.2 V

## 8.2.2 Detailed Design Procedure

### 8.2.2.1 Inductor Selection

The 1.5-MHz switching frequency allows the use of small inductor and capacitor values to maintain an inductor saturation current higher than the charging current (I<sub>CHG</sub>) plus half the ripple current (I<sub>RIPPLE</sub>):

$$I_{SAT} \geq I_{CHG} + (1/2) I_{RIPPLE} \quad (3)$$

The inductor ripple current depends on the input voltage (V<sub>VBUS</sub>), the duty cycle (D = V<sub>BAT</sub>/V<sub>VBUS</sub>), the switching frequency (f<sub>S</sub>) and the inductance (L).

$$I_{RIPPLE} = \frac{V_{IN} \times D \times (1 - D)}{f_S \times L} \quad (4)$$

The maximum inductor ripple current occurs when the duty cycle (D) is 0.5 or approximately 0.5. Usually inductor ripple is designed in the range between 20% and 40% maximum charging current as a trade-off between inductor size and efficiency for a practical design.

For compact solution size and efficiency at high current, a 1-μH inductor is recommended. To achieve better light load efficiency during boost mode (output current below 500 mA), the device also supports a 2.2-μH inductor with a 10-μF (min) cap on the system.

### 8.2.2.2 Input Capacitor and Resistor

Design the input capacitance to provide enough ripple current rating to absorb the input switching ripple current. Worst case RMS ripple current is half of the charging current when the duty cycle is 0.5. If the converter does not operate at 50% duty cycle, then the worst case capacitor RMS current I<sub>CIN</sub> occurs where the duty cycle is closest to 50% and can be estimated using [方程式 5](#).

$$I_{CIN} = I_{CHG} \times \sqrt{D \times (1 - D)} \quad (5)$$

A low ESR ceramic capacitor such as X7R or X5R is preferred for the input decoupling capacitor and should be placed as close as possible to the drain of the high-side MOSFET and source of the low-side MOSFET. The voltage rating of the capacitor must be higher than the normal input voltage level. A 25-V or higher rated capacitor is preferred for a 12-V input voltage. Minimum capacitance of 10 μF is suggested for typical of 1.5-A charging current.

During high current output over 700 mA in boost mode, a 10-kΩ pull-down resistor on VBUS is recommended to keep VBUS low in case Q1 RBFET leakage gets high.

### 8.2.2.3 Output Capacitor

Ensure that the output capacitance has enough ripple current rating to absorb the output switching ripple current. [方程式 6](#) shows the output capacitor RMS current I<sub>COU</sub>T calculation.



$$I_{\text{COUT}} = \frac{I_{\text{RIPPLE}}}{2 \times \sqrt{3}} \approx 0.29 \times I_{\text{RIPPLE}} \quad (6)$$

The output capacitor voltage ripple can be calculated as follows:

$$\Delta V_{\text{O}} = \frac{V_{\text{OUT}}}{8LCfs^2} \left( 1 - \frac{V_{\text{OUT}}}{V_{\text{IN}}} \right) \quad (7)$$

At certain input and output voltages and switching frequency, the voltage ripple can be reduced by increasing the output filter LC.

The charger device has internal loop compensation optimized for >10-μF ceramic output capacitance. The preferred ceramic capacitor is 10-V rating, X7R or X5R.

### 8.2.3 Application Curves



图 8-2. VBUS Plugged In and Unplugged with Boost Mode Disabled



图 8-3. VBUS Plugged In with Boost Mode Enabled

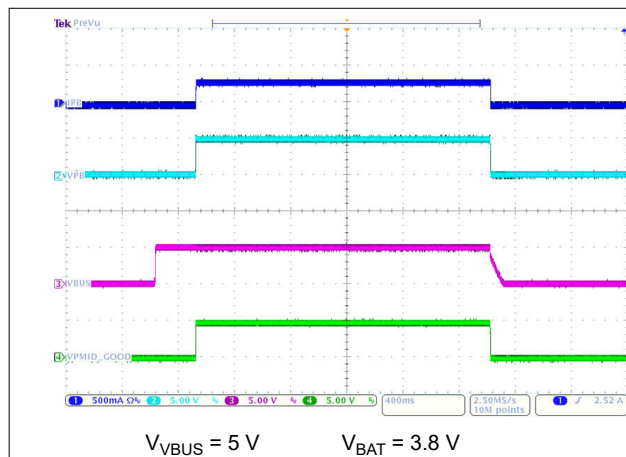

图 8-4. VBUS Unplugged with Boost Mode Enabled

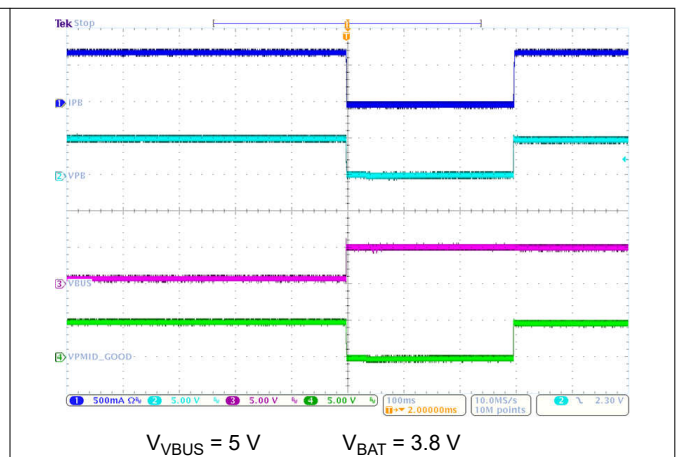

图 8-5. Power Up with Charge Disabled

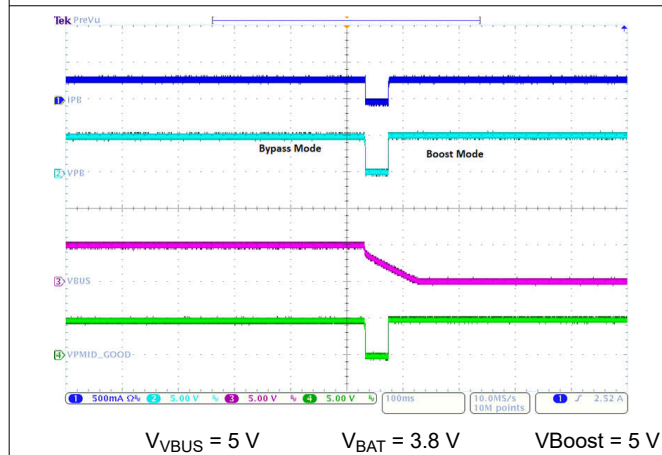

$I_{CHG} = 1.5\text{ A}$        $V_{VBUS} = 5\text{ V}$        $V_{BAT} = 3.2\text{ V}$

**图 8-6. Power Up with Charge Enabled**

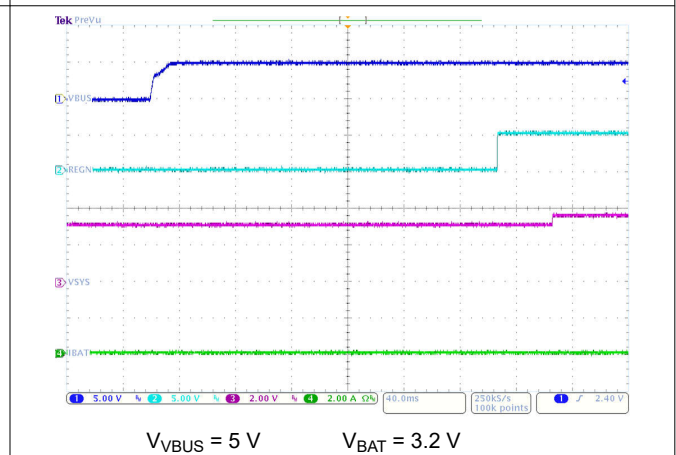
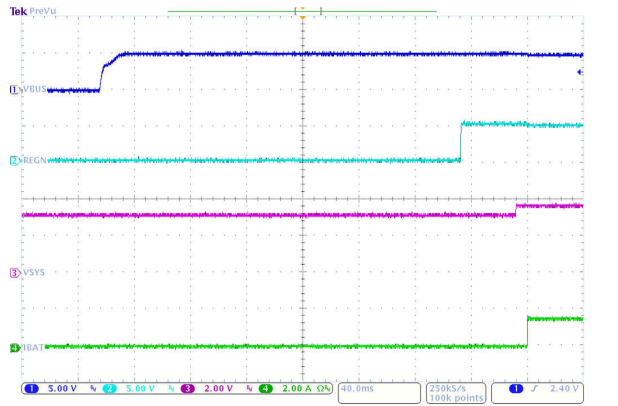
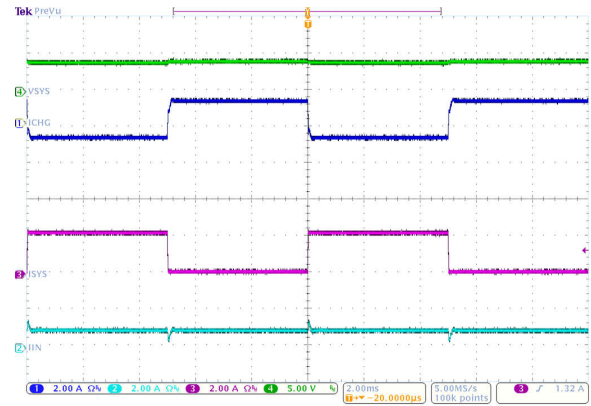

$I_{SYS} = 0 - 2\text{ A}$        $V_{VBUS} = 5\text{ V}$        $I_{INDPM} = 1\text{ A}$   
 $I_{CHG} = 1.5\text{ A}$        $V_{BAT} = 3.7\text{ V}$

**图 8-7. System Load Transient Response**

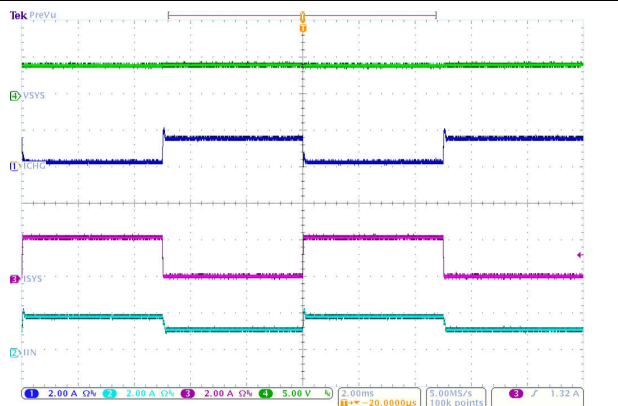

$I_{SYS} = 0 - 2\text{ A}$        $V_{VBUS} = 5\text{ V}$        $I_{INDPM} = 2\text{ A}$   
 $I_{CHG} = 1\text{ A}$        $V_{BAT} = 3.7\text{ V}$

**图 8-8. System Load Transient Response**

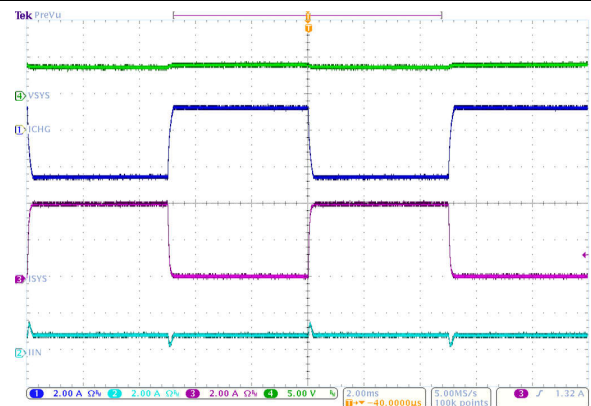

$I_{SYS} = 0 - 4\text{ A}$        $V_{VBUS} = 5\text{ V}$        $I_{INDPM} = 1\text{ A}$   
 $I_{CHG} = 1.5\text{ A}$        $V_{BAT} = 3.7\text{ V}$

**图 8-9. System Load Transient Response**

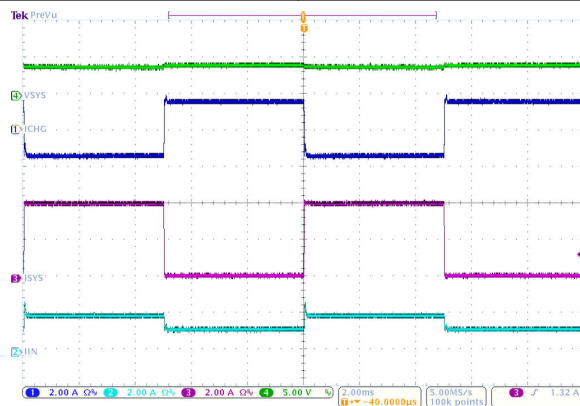

$I_{SYS} = 0 - 4\text{ A}$        $V_{VBUS} = 5\text{ V}$        $I_{INDPM} = 2\text{ A}$   
 $I_{CHG} = 1.5\text{ A}$        $V_{BAT} = 3.7\text{ V}$

**图 8-10. System Load Transient Response**

## 9 Power Supply Recommendations

In order to provide an output voltage on SYS, the battery charger requires a power supply between 4 V and 13.5 V input with at least a 100-mA current rating connected to VBUS and a single-cell Li-ion battery with battery voltage greater than  $V_{\text{BAT\_UVLOZ}}$  connected to BAT. The source current rating needs to be at least 3 A in order for the buck converter of the charger to provide maximum output power to SYS.

## 10 Layout

### 10.1 Layout Guidelines

The switching node rise and fall times should be minimized for minimum switching loss. Proper layout of the components to minimize the high frequency current path loop (see [图 10-1](#)) is important to prevent electrical and magnetic field radiation and high frequency resonant problems. Follow this specific order carefully to achieve the proper layout.

1. Place an input capacitor as close as possible to the PMID pin and GND pin connections and use the shortest copper trace connection or GND plane. Add a 1-nF small size (such as 0402 or 0201) decoupling cap for the high frequency noise filter and EMI improvement.
2. Place the inductor input pin as close as possible to SW pin. Minimize the copper area of this trace to lower electrical and magnetic field radiation but make the trace wide enough to carry the charging current. Do not use multiple layers in parallel for this connection. Minimize parasitic capacitance from this area to any other trace or plane.
3. Put the output capacitor near to the inductor and the device. Ground connections need to be tied to the IC ground with a short copper trace connection or GND plane.
4. Route the analog ground separately from power ground. Connect the analog ground and connect power ground separately. Connect the analog ground and power ground together using the thermal pad as the single ground connection point. Or use a 0- $\Omega$  resistor to tie the analog ground to power ground.
5. Use a single ground connection to tie the charger power ground to the charger analog ground just beneath the device. Use ground copper pour but avoid power pins to reduce inductive and capacitive noise coupling.
6. Place the decoupling capacitors next to the IC pins and make the trace connection as short as possible.
7. It is critical that the exposed thermal pad on the backside of the device package be soldered to the PCB ground. Ensure that there are sufficient thermal vias directly under the IC, connecting to the ground plane on the other layers.
8. Ensure that the number and sizes of vias allow enough copper for a given current path.

See the [BQ25618 BMS024 Evaluation Module User's Guide](#) and [BQ25619 BMS025 Evaluation Module EVM User's Guide](#) for the recommended component placement with trace and via locations. For the VQFN information, refer to [Quad Flatpack No-Lead Logic Packages Application Report](#) and [QFN and SON PCB Attachment Application Report](#).

### 10.2 Layout Example



图 10-1. High Frequency Current Path



图 10-2. Layout Example

## 11 Device and Documentation Support

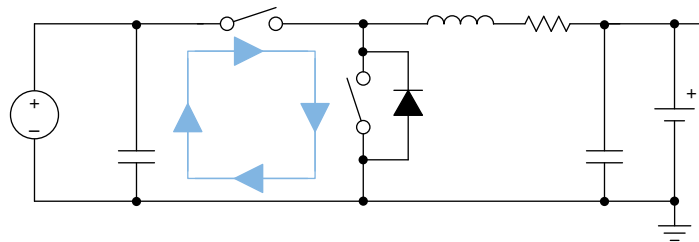
### 11.1 Device Support

#### 11.1.1 第三方产品免责声明

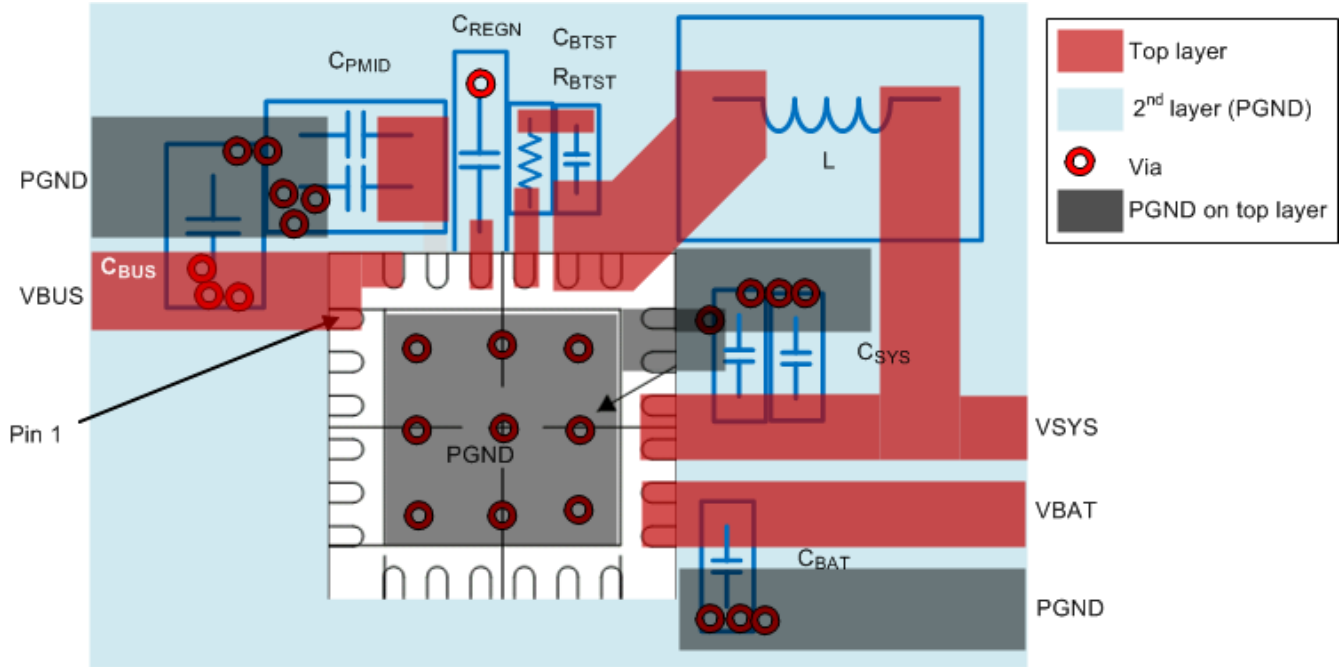
TI 发布的与第三方产品或服务有关的信息，不能构成与此类产品或服务或保修的适用性有关的认可，不能构成此类产品或服务单独或与任何 TI 产品或服务一起的表示或认可。

### 11.2 Documentation Support

#### 11.2.1 Related Documentation

For related documentation see the following:

- [BQ25619 BMS025 Evaluation Module User's Guide](#)
- [BQ25618 BMS024 Evaluation Module User's Guide](#)

### 11.3 接收文档更新通知

要接收文档更新通知，请导航至 [ti.com](http://ti.com) 上的器件产品文件夹。点击 [通知](#) 进行注册，即可每周接收产品信息更改摘要。有关更改的详细信息，请查看任何已修订文档中包含的修订历史记录。

### 11.4 支持资源

[TI E2E™ 中文支持论坛](#) 是工程师的重要参考资料，可直接从专家处获得快速、经过验证的解答和设计帮助。搜索现有解答或提出自己的问题，获得所需的快速设计帮助。

链接的内容由各个贡献者“按原样”提供。这些内容并不构成 TI 技术规范，并且不一定反映 TI 的观点；请参阅 TI 的 [使用条款](#)。

### 11.5 Trademarks

TI E2E™ is a trademark of Texas Instruments.

所有商标均为其各自所有者的财产。

### 11.6 静电放电警告



静电放电 (ESD) 会损坏这个集成电路。德州仪器 (TI) 建议通过适当的预防措施处理所有集成电路。如果不遵守正确的处理和安装程序，可能会损坏集成电路。

ESD 的损坏小至导致微小的性能降级，大至整个器件故障。精密的集成电路可能更容易受到损坏，这是因为非常细微的参数更改都可能会导致器件与其发布的规格不相符。

### 11.7 术语表

[TI 术语表](#) 本术语表列出并解释了术语、首字母缩略词和定义。

## 12 Revision History

注：以前版本的页码可能与当前版本的页码不同

Changes from Revision E (May 2024) to Revision F (February 2025)	Page
• 已在 <a href="#">特性</a> 中将充电电流调节更新为 +/-5%.....	1
• Updated fast charge current regulation to +/-5% in <a href="#">Electrical Characteristics</a> .....	8

---

**Changes from Revision D (December 2021) to Revision E (July 2024) Page**

- Changed BAT, SYS (converter not switching) MAX value from 17V to 7V in [Absolute Maximum Ratings](#) ..... 7
  - Changed I<sub>Q\_BAT</sub> and I<sub>SHIP\_BAT</sub> test conditions in [Electrical Characteristics](#) ..... 8
- 

---

**Changes from Revision C (June 2021) to Revision D (December 2021) Page**

- Deleted t<sub>SU\_STA</sub>, t<sub>HD\_DAT</sub>, t<sub>rDA</sub>, and t<sub>fDA</sub> from Timing Requirements..... 13
- 

---

**Changes from Revision B (September 2019) to Revision C (June 2021) Page**

- 添加了“安全相关认证：经 IEC 62368-1 CB 认证”..... 1
  - Changed REG2 ICHG[5:0] 111100: 1430 mA to 111110: 1430 mA and 111100: 1500 mA to 111111: 1500 mA..... 33
- 

---

**Changes from Revision A (July 2019) to Revision B (September 2019) Page**

- 添加了 BQ25618..... 1
- 

---

**Changes from Revision \* (June 2019) to Revision A (July 2019) Page**

- 将“预告信息”更改为“量产数据” ..... 1
-

## 13 Mechanical, Packaging, and Orderable Information

The following pages include mechanical, packaging, and orderable information. This information is the most current data available for the designated devices. This data is subject to change without notice and revision of this document. For browser-based versions of this data sheet, refer to the left-hand navigation.



**PACKAGING INFORMATION**

Orderable Device	Status (1)	Package Type	Package Drawing	Pins	Package Qty	Eco Plan (2)	Lead finish/ Ball material (6)	MSL Peak Temp (3)	Op Temp (°C)	Device Marking (4/5)	Samples
BQ25618YFFR	ACTIVE	DSBGA	YFF	30	3000	RoHS & Green	SNAGCU	Level-1-260C-UNLIM	-40 to 85	BQ25618	<a href="#">Samples</a>
BQ25618YFFT	ACTIVE	DSBGA	YFF	30	250	RoHS & Green	SNAGCU	Level-1-260C-UNLIM	-40 to 85	BQ25618	<a href="#">Samples</a>
BQ25619RTWR	ACTIVE	WQFN	RTW	24	3000	RoHS & Green	NIPDAU	Level-1-260C-UNLIM	-40 to 85	BQ25619	<a href="#">Samples</a>
BQ25619RTWT	ACTIVE	WQFN	RTW	24	250	RoHS & Green	NIPDAU	Level-1-260C-UNLIM	-40 to 85	BQ25619	<a href="#">Samples</a>

(1) The marketing status values are defined as follows:

**ACTIVE:** Product device recommended for new designs.

**LIFEBUY:** TI has announced that the device will be discontinued, and a lifetime-buy period is in effect.

**NRND:** Not recommended for new designs. Device is in production to support existing customers, but TI does not recommend using this part in a new design.

**PREVIEW:** Device has been announced but is not in production. Samples may or may not be available.

**OBSELETE:** TI has discontinued the production of the device.

(2) **RoHS:** TI defines "RoHS" to mean semiconductor products that are compliant with the current EU RoHS requirements for all 10 RoHS substances, including the requirement that RoHS substance do not exceed 0.1% by weight in homogeneous materials. Where designed to be soldered at high temperatures, "RoHS" products are suitable for use in specified lead-free processes. TI may reference these types of products as "Pb-Free".

**RoHS Exempt:** TI defines "RoHS Exempt" to mean products that contain lead but are compliant with EU RoHS pursuant to a specific EU RoHS exemption.

**Green:** TI defines "Green" to mean the content of Chlorine (Cl) and Bromine (Br) based flame retardants meet JS709B low halogen requirements of <=1000ppm threshold. Antimony trioxide based flame retardants must also meet the <=1000ppm threshold requirement.

(3) MSL, Peak Temp. - The Moisture Sensitivity Level rating according to the JEDEC industry standard classifications, and peak solder temperature.

(4) There may be additional marking, which relates to the logo, the lot trace code information, or the environmental category on the device.

(5) Multiple Device Markings will be inside parentheses. Only one Device Marking contained in parentheses and separated by a "-" will appear on a device. If a line is indented then it is a continuation of the previous line and the two combined represent the entire Device Marking for that device.

(6) Lead finish/Ball material - Orderable Devices may have multiple material finish options. Finish options are separated by a vertical ruled line. Lead finish/Ball material values may wrap to two lines if the finish value exceeds the maximum column width.

**Important Information and Disclaimer:**The information provided on this page represents TI's knowledge and belief as of the date that it is provided. TI bases its knowledge and belief on information provided by third parties, and makes no representation or warranty as to the accuracy of such information. Efforts are underway to better integrate information from third parties. TI has taken and

continues to take reasonable steps to provide representative and accurate information but may not have conducted destructive testing or chemical analysis on incoming materials and chemicals. TI and TI suppliers consider certain information to be proprietary, and thus CAS numbers and other limited information may not be available for release.

In no event shall TI's liability arising out of such information exceed the total purchase price of the TI part(s) at issue in this document sold by TI to Customer on an annual basis.

**TAPE AND REEL INFORMATION**

**QUADRANT ASSIGNMENTS FOR PIN 1 ORIENTATION IN TAPE**

\*All dimensions are nominal

Device	Package Type	Package Drawing	Pins	SPQ	Reel Diameter (mm)	Reel Width W1 (mm)	A0 (mm)	B0 (mm)	K0 (mm)	P1 (mm)	W (mm)	Pin1 Quadrant
BQ25618YFFR	DSBGA	YFF	30	3000	180.0	8.4	2.09	2.59	0.78	4.0	8.0	Q1
BQ25618YFFT	DSBGA	YFF	30	250	180.0	8.4	2.09	2.59	0.78	4.0	8.0	Q1
BQ25619RTWR	WQFN	RTW	24	3000	330.0	12.4	4.25	4.25	1.15	8.0	12.0	Q2
BQ25619RTWT	WQFN	RTW	24	250	180.0	12.4	4.25	4.25	1.15	8.0	12.0	Q2

## TAPE AND REEL BOX DIMENSIONS



\*All dimensions are nominal

Device	Package Type	Package Drawing	Pins	SPQ	Length (mm)	Width (mm)	Height (mm)
BQ25618YFFR	DSBGA	YFF	30	3000	182.0	182.0	20.0
BQ25618YFFT	DSBGA	YFF	30	250	182.0	182.0	20.0
BQ25619RTWR	WQFN	RTW	24	3000	367.0	367.0	35.0
BQ25619RTWT	WQFN	RTW	24	250	210.0	185.0	35.0

YFF0030

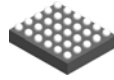

PACKAGE OUTLINE

DSBGA - 0.625 mm max height

DIE SIZE BALL GRID ARRAY

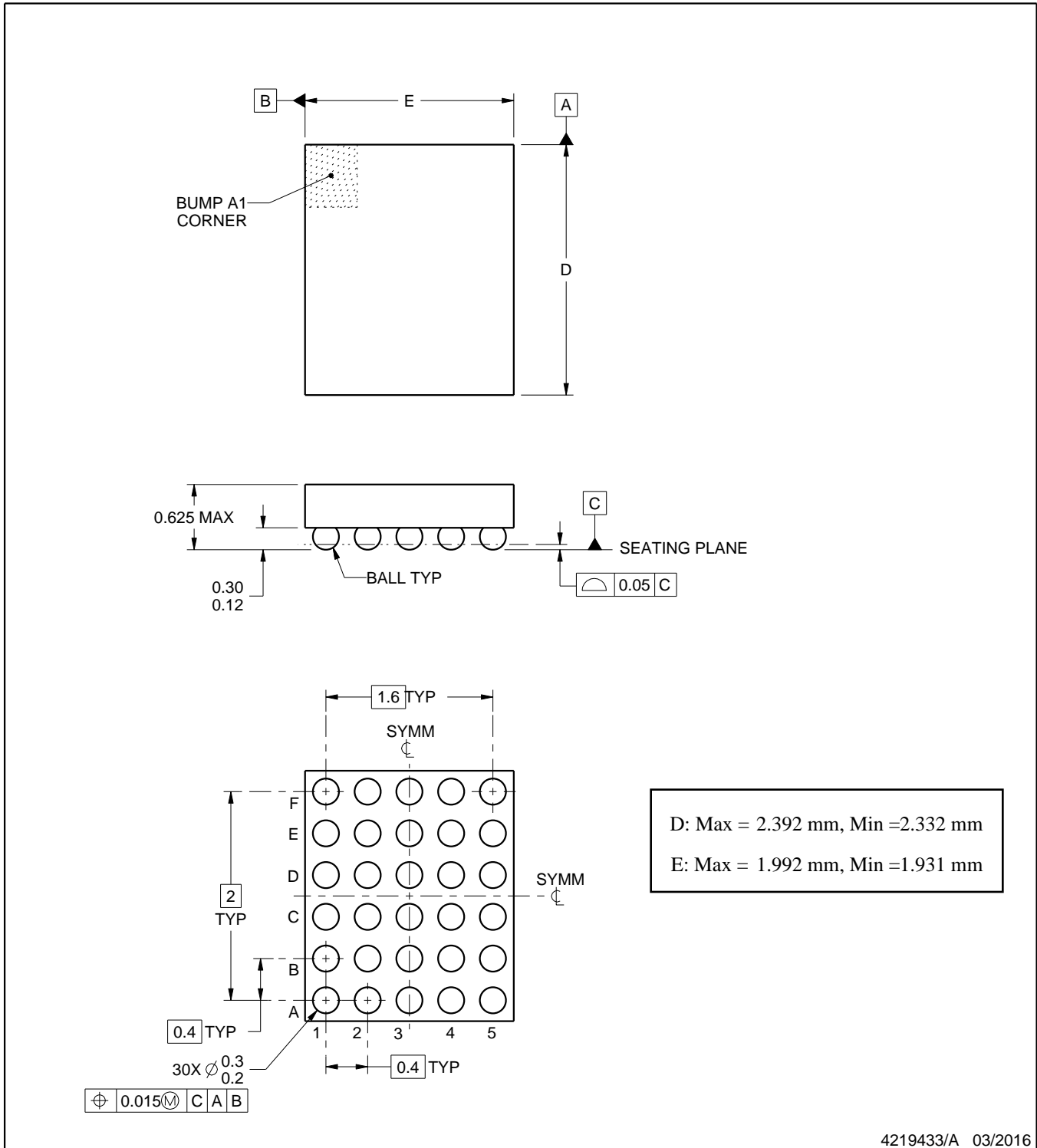

4219433/A 03/2016

NOTES:

1. All linear dimensions are in millimeters. Any dimensions in parenthesis are for reference only. Dimensioning and tolerancing per ASME Y14.5M.
2. This drawing is subject to change without notice.

# EXAMPLE BOARD LAYOUT

YFF0030

DSBGA - 0.625 mm max height

DIE SIZE BALL GRID ARRAY

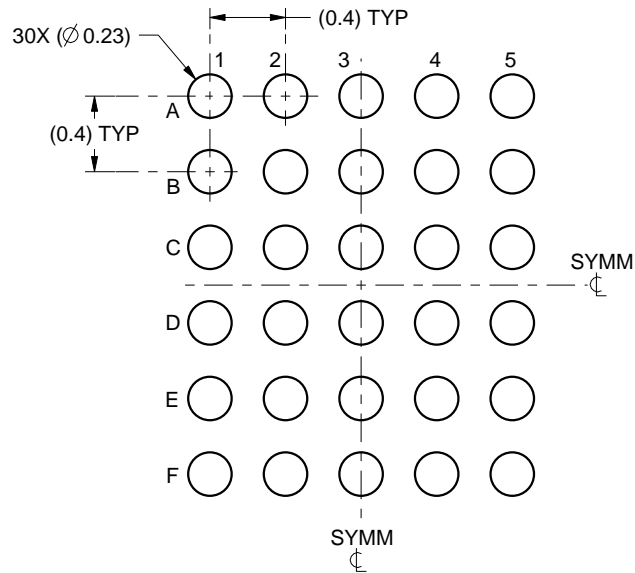

LAND PATTERN EXAMPLE  
SCALE:25X

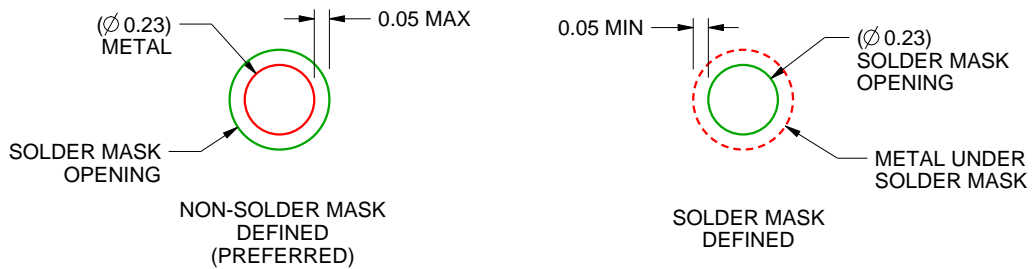

SOLDER MASK DETAILS  
NOT TO SCALE

4219433/A 03/2016

NOTES: (continued)

3. Final dimensions may vary due to manufacturing tolerance considerations and also routing constraints. For more information, see Texas Instruments literature number SNVA009 ([www.ti.com/lit/snva009](http://www.ti.com/lit/snva009)).

# EXAMPLE STENCIL DESIGN

YFF0030

DSBGA - 0.625 mm max height

DIE SIZE BALL GRID ARRAY

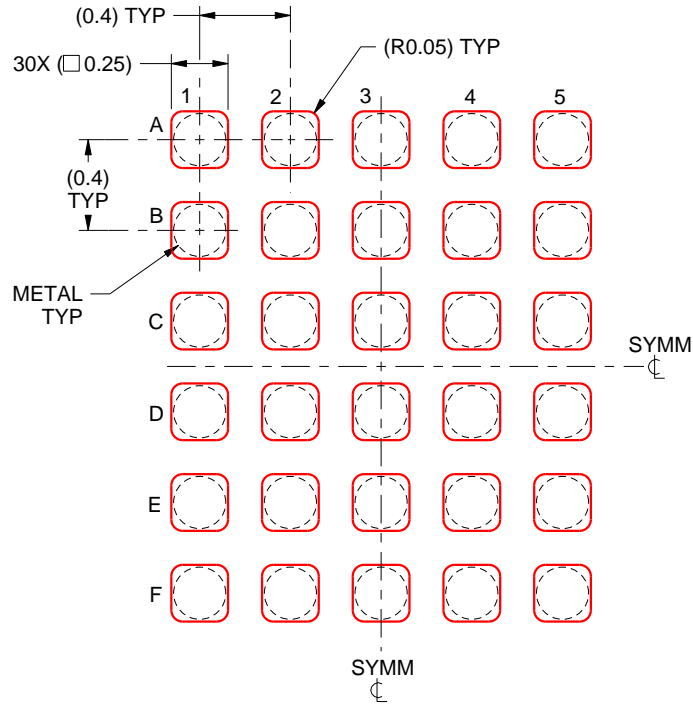

SOLDER PASTE EXAMPLE  
BASED ON 0.1 mm THICK STENCIL  
SCALE:30X

4219433/A 03/2016

NOTES: (continued)

4. Laser cutting apertures with trapezoidal walls and rounded corners may offer better paste release.

## GENERIC PACKAGE VIEW

**RTW 24**

**WQFN - 0.8 mm max height**

4 x 4, 0.5 mm pitch

PLASTIC QUAD FLATPACK - NO LEAD

This image is a representation of the package family, actual package may vary.  
Refer to the product data sheet for package details.

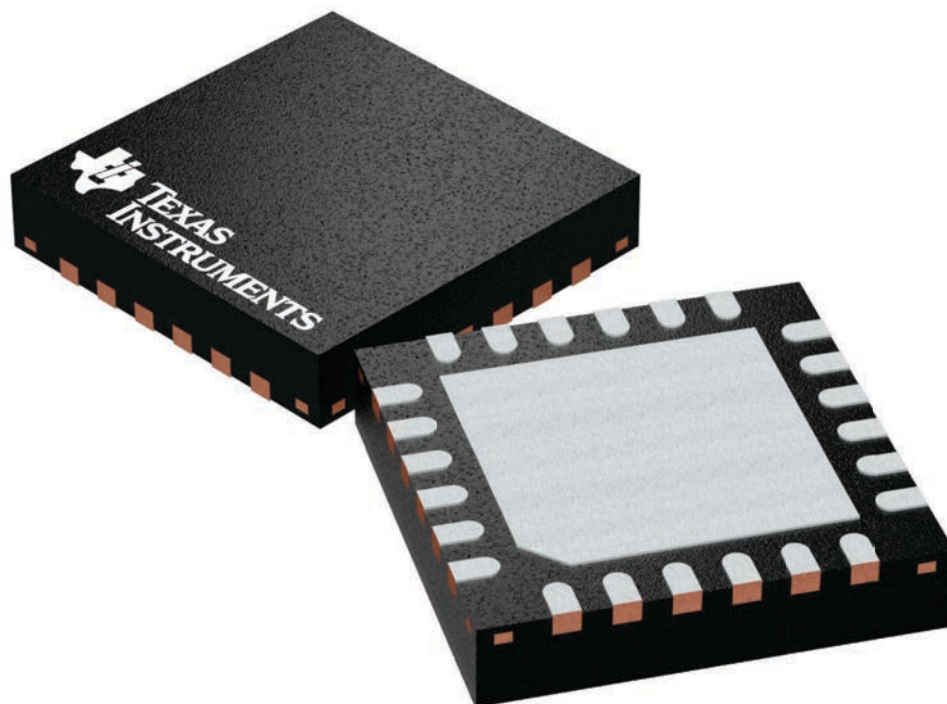

4224801/A



RTW (S-PWQFN-N24)

PLASTIC QUAD FLATPACK NO-LEAD

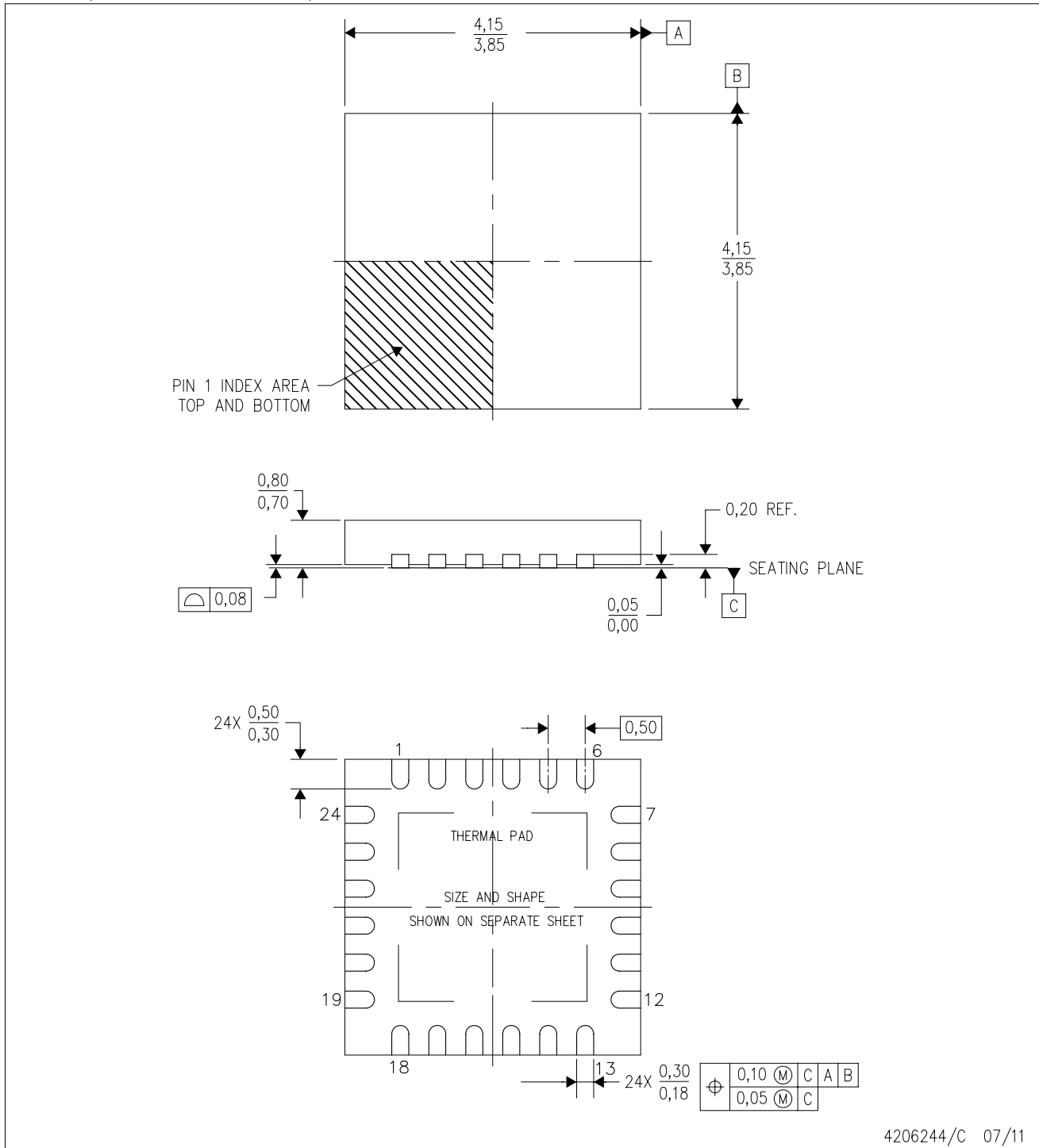

4206244/C 07/11

- NOTES:
- All linear dimensions are in millimeters. Dimensioning and tolerancing per ASME Y14.5M-1994.
  - This drawing is subject to change without notice.
  - Quad Flatpack, No-Leads (QFN) package configuration.
  - The package thermal pad must be soldered to the board for thermal and mechanical performance.
  - See the additional figure in the Product Data Sheet for details regarding the exposed thermal pad features and dimensions.
  - Falls within JEDEC MO-220.

THERMAL INFORMATION

This package incorporates an exposed thermal pad that is designed to be attached directly to an external heatsink. The thermal pad must be soldered directly to the printed circuit board (PCB). After soldering, the PCB can be used as a heatsink. In addition, through the use of thermal vias, the thermal pad can be attached directly to the appropriate copper plane shown in the electrical schematic for the device, or alternatively, can be attached to a special heatsink structure designed into the PCB. This design optimizes the heat transfer from the integrated circuit (IC).

For information on the Quad Flatpack No-Lead (QFN) package and its advantages, refer to Application Report, QFN/SON PCB Attachment, Texas Instruments Literature No. SLUA271. This document is available at [www.ti.com](http://www.ti.com).

The exposed thermal pad dimensions for this package are shown in the following illustration.

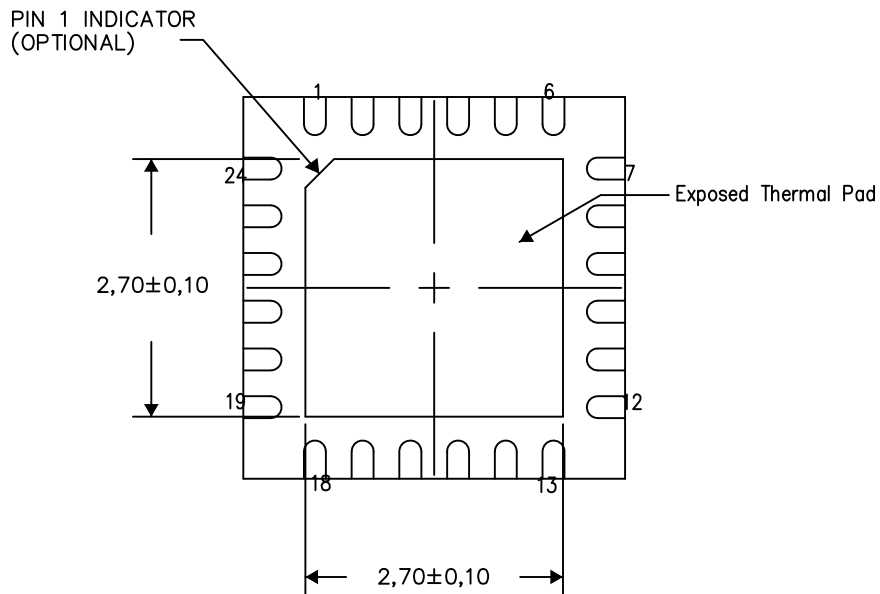

Bottom View

Exposed Thermal Pad Dimensions

4206249-5/P 05/15

NOTES: A. All linear dimensions are in millimeters

RTW (S-PWQFN-N24)

PLASTIC QUAD FLATPACK NO-LEAD

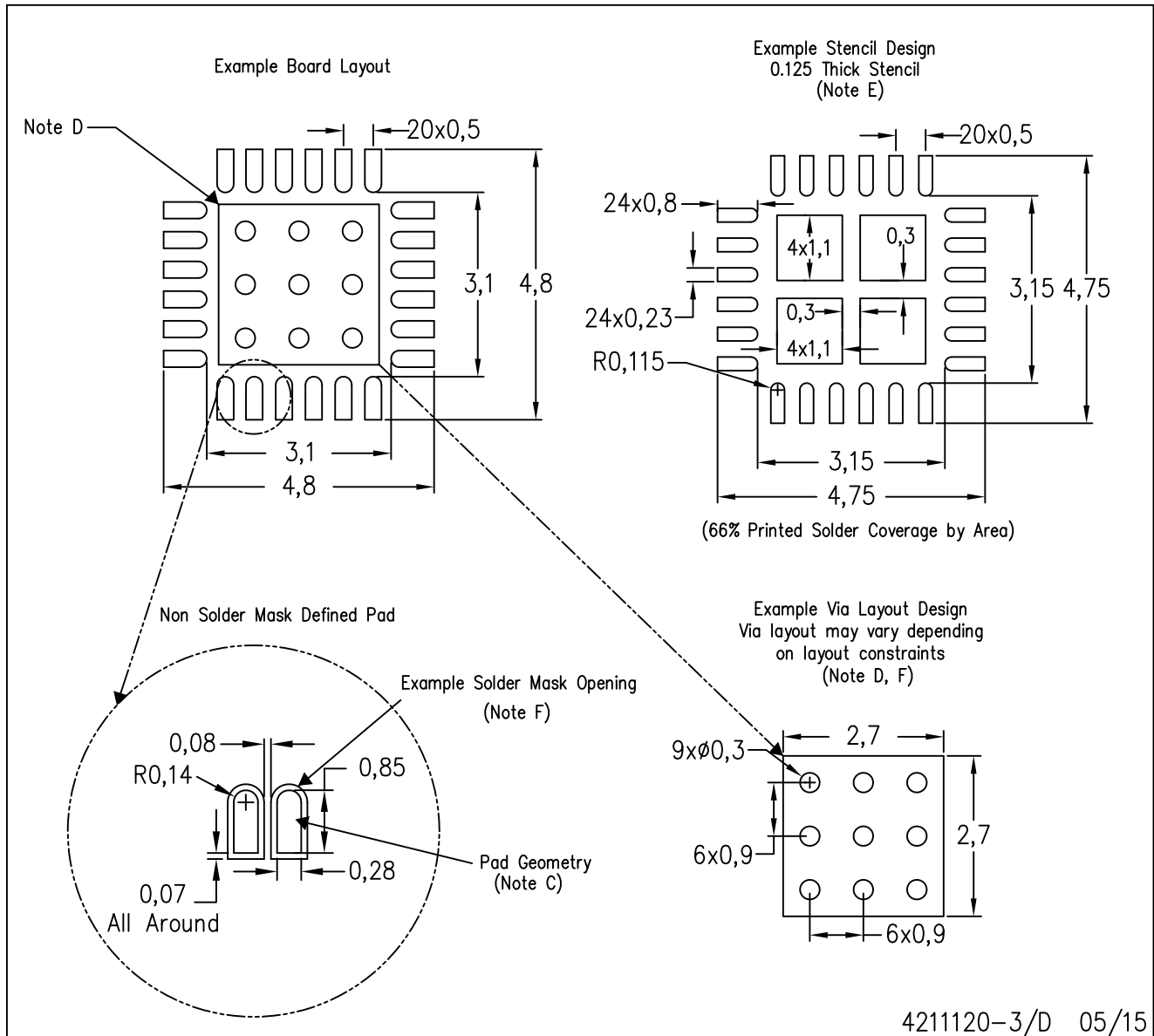

- NOTES:
- All linear dimensions are in millimeters.
  - This drawing is subject to change without notice.
  - Publication IPC-7351 is recommended for alternate designs.
  - This package is designed to be soldered to a thermal pad on the board. Refer to Application Note, Quad Flat-Pack Packages, Texas Instruments Literature No. SLUA271, and also the Product Data Sheets for specific thermal information, via requirements, and recommended board layout. These documents are available at [www.ti.com](http://www.ti.com) <<http://www.ti.com>>.
  - Laser cutting apertures with trapezoidal walls and also rounding corners will offer better paste release. Customers should contact their board assembly site for stencil design recommendations. Refer to IPC 7525 for stencil design considerations.
  - Customers should contact their board fabrication site for recommended solder mask tolerances and via tenting recommendations for vias placed in the thermal pad.

## 重要通知和免责声明

TI“按原样”提供技术和可靠性数据（包括数据表）、设计资源（包括参考设计）、应用或其他设计建议、网络工具、安全信息和其他资源，不保证没有瑕疵且不做任何明示或暗示的担保，包括但不限于对适销性、某特定用途方面的适用性或不侵犯任何第三方知识产权的暗示担保。

这些资源可供使用 TI 产品进行设计的熟练开发人员使用。您将自行承担以下全部责任：(1) 针对您的应用选择合适的 TI 产品，(2) 设计、验证并测试您的应用，(3) 确保您的应用满足相应标准以及任何其他功能安全、信息安全、监管或其他要求。

这些资源如有变更，恕不另行通知。TI 授权您仅可将这些资源用于研发本资源所述的 TI 产品的相关应用。严禁以其他方式对这些资源进行复制或展示。您无权使用任何其他 TI 知识产权或任何第三方知识产权。您应全额赔偿因在这些资源的使用中对 TI 及其代表造成的任何索赔、损害、成本、损失和债务，TI 对此概不负责。

TI 提供的产品受 [TI 的销售条款](#) 或 [ti.com](#) 上其他适用条款/TI 产品随附的其他适用条款的约束。TI 提供这些资源并不会扩展或以其他方式更改 TI 针对 TI 产品发布的适用的担保或担保免责声明。

TI 反对并拒绝您可能提出的任何其他或不同的条款。

邮寄地址：Texas Instruments, Post Office Box 655303, Dallas, Texas 75265  
版权所有 © 2025，德州仪器 (TI) 公司