

CSD17571Q2 30V N 沟道 NexFET™ 功率金属氧化物半导体场效应晶体管 (MOSFET)

1 特性

- 低 Q_g 和 Q_{gd}
- 低热阻
- 雪崩级
- 无铅引脚镀层
- 符合 RoHS 环保标准
- 无卤素
- 小外形尺寸无引线 (SON) 2mm x 2mm 塑料封装

2 应用范围

- 针对负载开关应用进行了优化
- 存储、平板电脑和手持设备
- 针对控制场效应晶体管 (FET) 应用进行了优化

3 说明

这款 30V、20mΩ、SON 2mm x 2mm NexFET™ 功率 MOSFET 旨在以最大程度降低功率转换和负载管理应用中的损耗，同时提供出色的封装散热性能。

顶视图

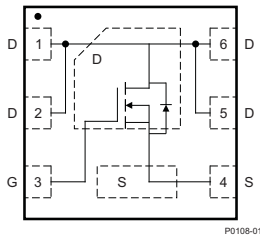

$R_{DS(on)}$ 与 V_{GS} 间的关系

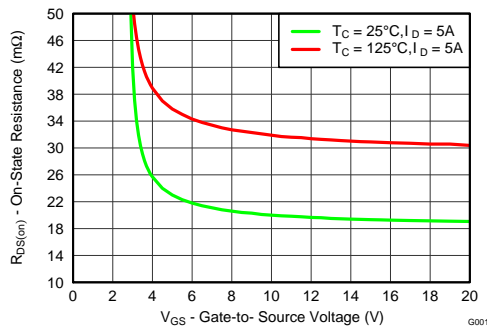

产品概要

$T_A = 25^\circ\text{C}$		典型值		单位
V_{DS}	漏源电压	30		V
Q_g	栅极电荷总量 (4.5V)	2.4		nC
Q_{gd}	栅极电荷 (栅极到漏极)	0.6		nC
$R_{DS(on)}$	漏源导通电阻	$V_{GS} = 4.5\text{V}$	24	mΩ
		$V_{GS} = 10\text{V}$	20	mΩ
$V_{GS(th)}$	阈值电压	1.6		V

订购信息⁽¹⁾

器件	介质	数量	封装	出货
CSD17571Q2	7 英寸卷带	3000	SON 2mm x 2mm 塑料封装	卷带封装

(1) 要了解所有可用封装，请见数据表末尾的可订购产品附录。

绝对最大额定值

$T_A = 25^\circ\text{C}$		值	单位
V_{DS}	漏源电压	30	V
V_{GS}	栅源电压	± 20	V
I_D	持续漏极电流 (受封装限制)	22	A
	持续漏极电流 ⁽¹⁾	7.6	A
I_{DM}	脉冲漏极电流, $T_A = 25^\circ\text{C}$ 时测得 ⁽²⁾	39	A
P_D	功率耗散 ⁽¹⁾	2.5	W
T_J, T_{stg}	运行结温和 储存温度范围	-55 至 150	$^\circ\text{C}$
E_{AS}	雪崩能量, 单一脉冲 $I_D = 12\text{A}, L = 0.1\text{mH}, R_G = 25\Omega$	7.2	mJ

(1) $R_{\theta JA} = 50$ ，这是在厚度为 0.060" 的环氧树脂 (FR4) 印刷电路板 (PCB) 上 1 in² (2 盎司) 铜焊盘上测得的典型值

(2) 脉冲持续时间 10μs，占空比 ≤ 2%

栅极电荷

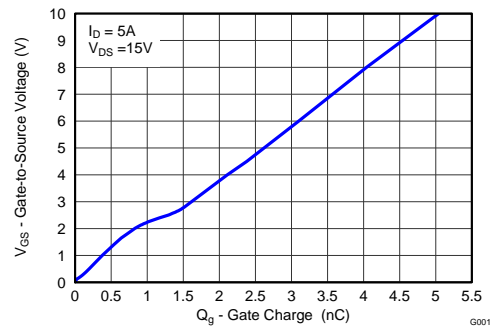

目录

1 特性 1 2 应用范围 1 3 说明 1 4 修订历史记录 2 5 Specifications 3 5.1 Electrical Characteristics 3 5.2 Thermal Information 3	5.3 Typical MOSFET Characteristics 4 6 器件和文档支持 7 6.1 商标 7 6.2 静电放电警告 7 6.3 术语表 7 7 机械、封装和可订购信息 8 7.1 Q2 封装尺寸 8 7.2 Q2 卷带信息 10
---	--

4 修订历史记录

Changes from Original (October 2013) to Revision A	Page
• Updated Figure #8	6

5 Specifications

5.1 Electrical Characteristics

 $T_A = 25^\circ\text{C}$

PARAMETER		TEST CONDITIONS	MIN	TYP	MAX	UNIT
STATIC CHARACTERISTICS						
V_{DSS}	Drain-to-Source Voltage	$V_{GS} = 0\text{ V}, I_D = 250\ \mu\text{A}$	30			V
I_{DSS}	Drain-to-Source Leakage Current	$V_{GS} = 0\text{ V}, V_{DS} = 24\text{ V}$			1	μA
I_{GSS}	Gate-to-Source Leakage Current	$V_{DS} = 0\text{ V}, V_{GS} = 20\text{ V}$			100	nA
$V_{GS(th)}$	Gate-to-Source Threshold Voltage	$V_{DS} = V_{GS}, I_{DS} = 250\ \mu\text{A}$	1.3	1.6	2	V
$R_{DS(on)}$	Drain-to-Source On-Resistance	$V_{GS} = 4.5\text{ V}, I_{DS} = 5\text{ A}$		24	29	m Ω
		$V_{GS} = 10\text{ V}, I_{DS} = 5\text{ A}$		20	24	m Ω
g_{fs}	Transconductance	$V_{DS} = 15\text{ V}, I_{DS} = 5\text{ A}$		43		S
DYNAMIC CHARACTERISTICS						
C_{ISS}	Input Capacitance	$V_{GS} = 0\text{ V}, V_{DS} = 15\text{ V}, f = 1\text{ MHz}$		360	468	pF
C_{OSS}	Output Capacitance			101	131	pF
C_{RSS}	Reverse Transfer Capacitance			9	12	pF
R_g	Series Gate Resistance		3.8	7.6		Ω
Q_g	Gate Charge Total (4.5 V)	$V_{DS} = 15\text{ V}, I_{DS} = 5\text{ A}$		2.4	3.1	nC
Q_{gd}	Gate Charge – Gate-to-Drain			0.6		nC
Q_{gs}	Gate Charge Gate-to-Source			0.9		nC
$Q_{g(th)}$	Gate Charge at V_{th}			0.6		nC
Q_{OSS}	Output Charge	$V_{DS} = 15\text{ V}, V_{GS} = 0\text{ V}$		3.4		nC
$t_{d(on)}$	Turn On Delay Time	$V_{DS} = 15\text{ V}, V_{GS} = 4.5\text{ V}, I_{DS} = 5\text{ A}$ $R_G = 2\ \Omega$		5.3		ns
t_r	Rise Time			19		ns
$t_{d(off)}$	Turn Off Delay Time			8		ns
t_f	Fall Time			2.6		ns
DIODE CHARACTERISTICS						
V_{SD}	Diode Forward Voltage	$I_{DS} = 5\text{ A}, V_{GS} = 0\text{ V}$		0.8	1	V
Q_{rr}	Reverse Recovery Charge	$V_{DD} = 15\text{ V}, I_F = 5\text{ A}, di/dt = 300\text{ A}/\mu\text{s}$		2.3		nC
t_{rr}	Reverse Recovery Time			11		ns

5.2 Thermal Information

 $T_A = 25^\circ\text{C}$ unless otherwise specified

THERMAL METRIC		MIN	TYP	MAX	UNIT
$R_{\theta JC}$	Junction-to-Case Thermal Resistance ⁽¹⁾			6.2	$^\circ\text{C}/\text{W}$
$R_{\theta JA}$	Junction-to-Ambient Thermal Resistance ⁽¹⁾⁽²⁾			65	

- (1) $R_{\theta JC}$ is determined with the device mounted on a 1 inch² (6.45 cm²), 2 oz. (0.071 mm thick) Cu pad on a 1.5 inches x 1.5 inches (3.81 cm x 3.81 cm), 0.06 inch (1.52 mm) thick FR4 PCB. $R_{\theta JC}$ is specified by design, whereas $R_{\theta JA}$ is determined by the user's board design.
- (2) Device mounted on FR4 material with 1 inch² (6.45 cm²), 2 oz. (0.071 mm thick) Cu.

CSD17571Q2

ZHCSBT4A – OCTOBER 2013 – REVISED JANUARY 2015

www.ti.com.cn

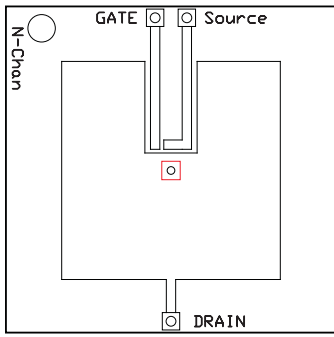

Max $R_{\theta JA} = 65$ when mounted on 1 inch² (6.45 cm²) of 2 oz. (0.071 mm thick) Cu.

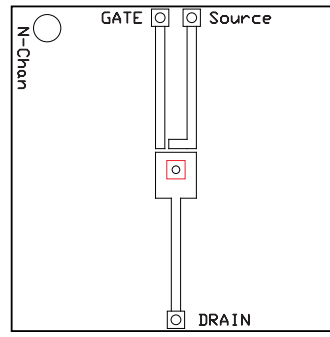

Max $R_{\theta JA} = 235$ when mounted on minimum pad area of 2 oz. (0.071 mm thick) Cu.

5.3 Typical MOSFET Characteristics

$T_A = 25^\circ\text{C}$ unless otherwise specified

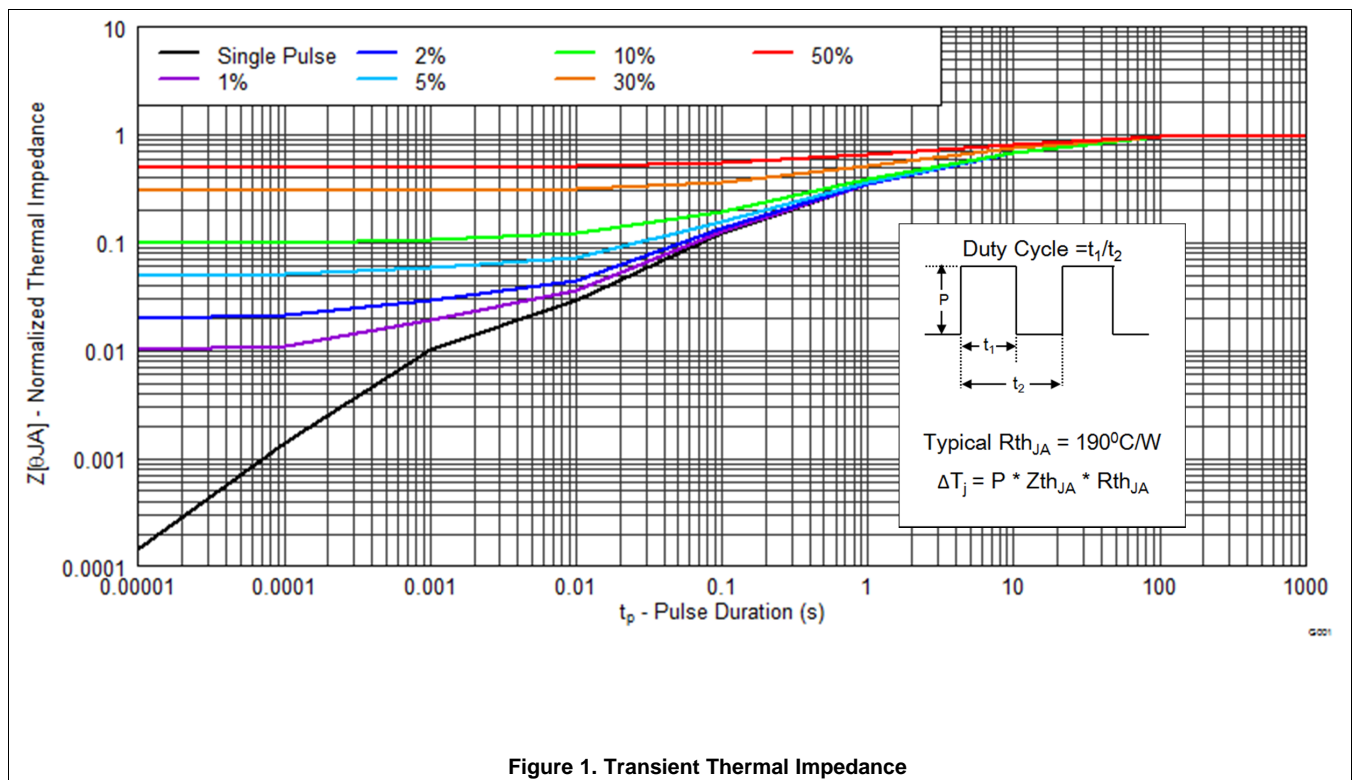

Figure 1. Transient Thermal Impedance

Typical MOSFET Characteristics (continued)

T_A = 25°C unless otherwise specified

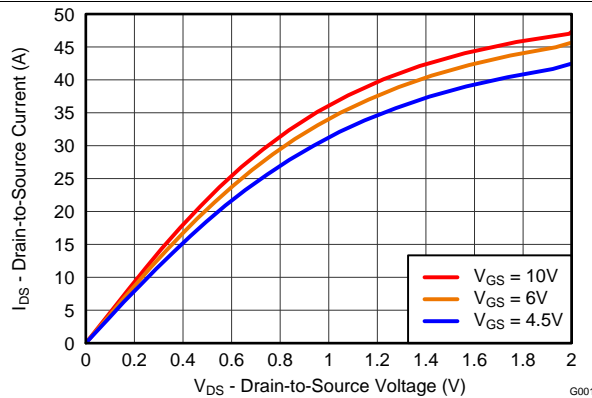

Figure 2. Saturation Characteristics

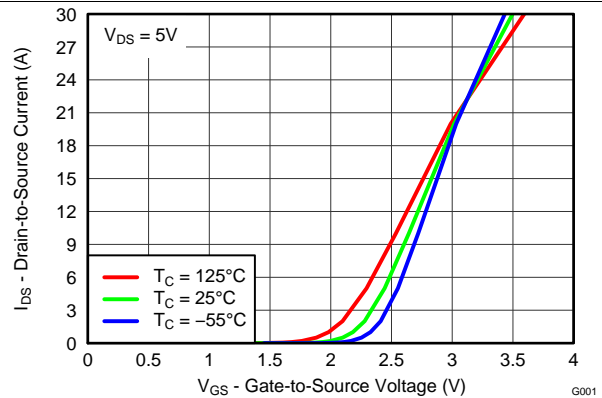

Figure 3. Transfer Characteristics

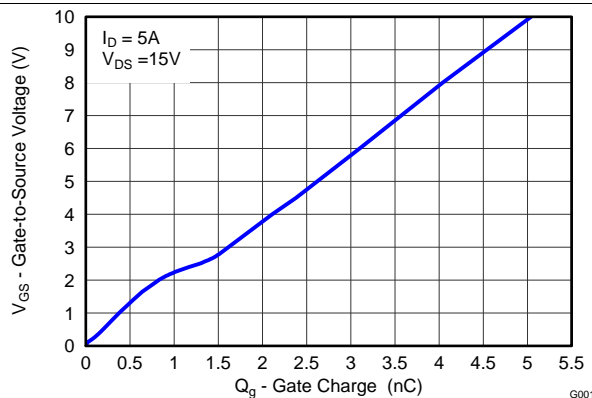

Figure 4. Gate Charge

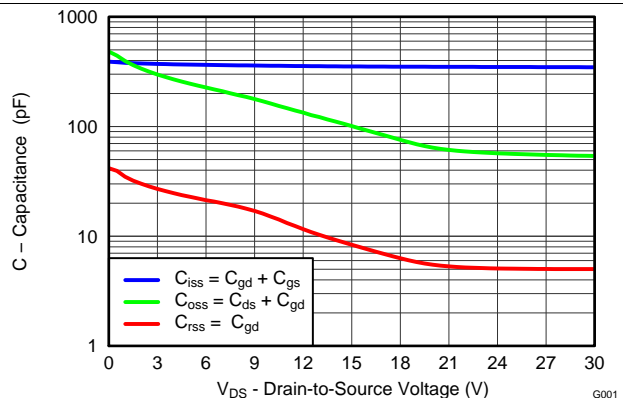

Figure 5. Capacitance

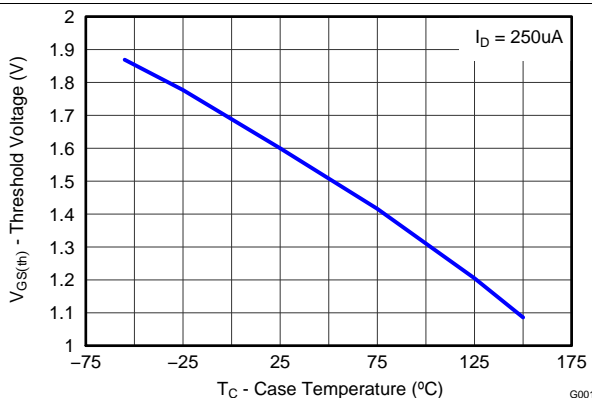

Figure 6. Threshold Voltage vs Temperature

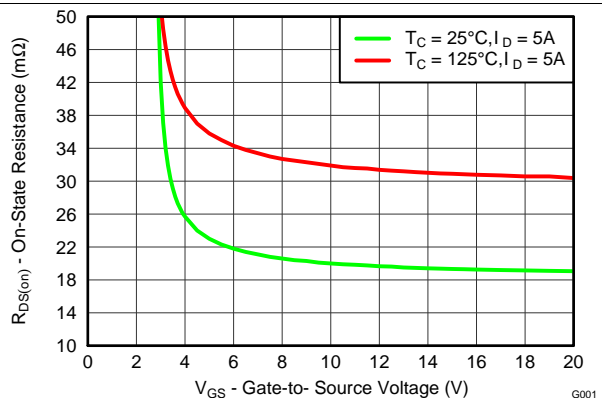

Figure 7. On-State Resistance vs Gate-to-Source Voltage

Typical MOSFET Characteristics (continued)

T_A = 25°C unless otherwise specified

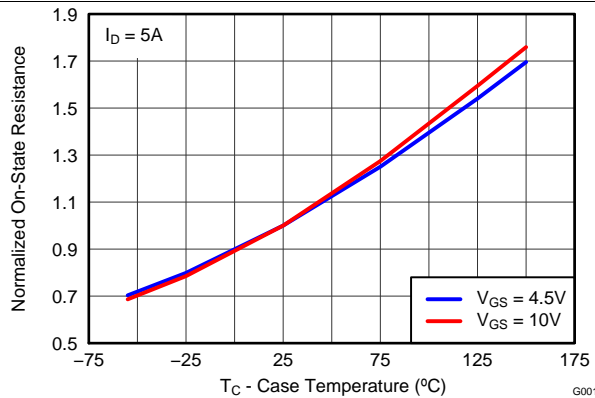

Figure 8. Normalized On-State Resistance vs Temperature

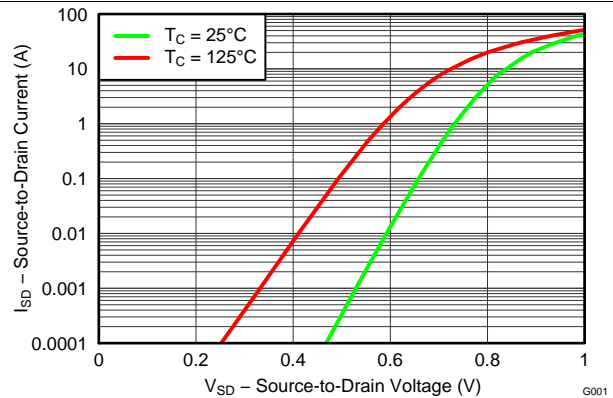

Figure 9. Typical Diode Forward Voltage

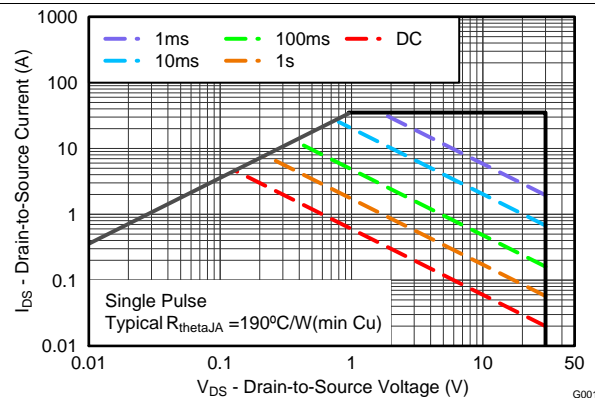

Figure 10. Maximum Safe Operating Area

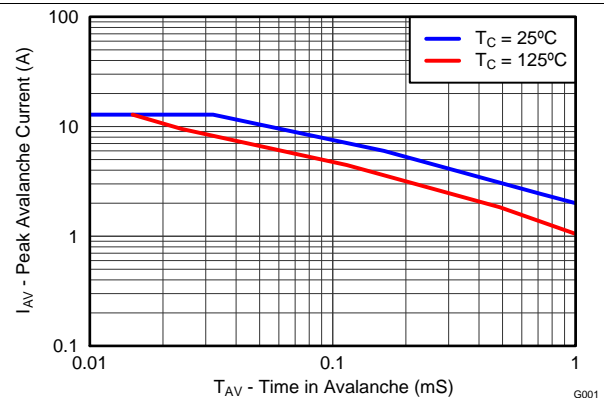

Figure 11. Single Pulse Unclamped Inductive Switching

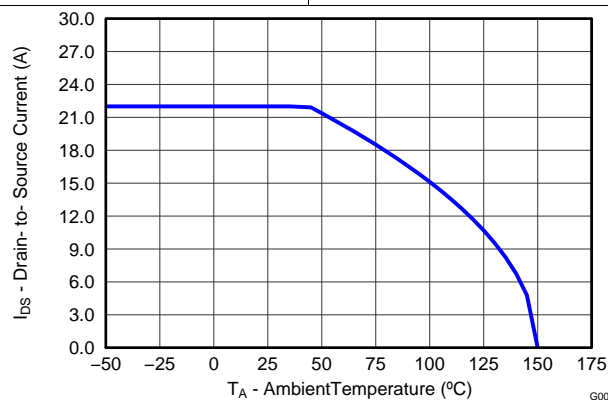

Figure 12. Maximum Drain Current vs Temperature

6 器件和文档支持

6.1 商标

NexFET is a trademark of Texas Instruments.
All other trademarks are the property of their respective owners.

6.2 静电放电警告



这些装置包含有限的内置 ESD 保护。存储或装卸时，应将导线一起截短或将装置放置于导电泡棉中，以防止 MOS 门极遭受静电损伤。

6.3 术语表

[SLYZ022](#) — *TI* 术语表。

这份术语表列出并解释术语、首字母缩略词和定义。

7 机械、封装和可订购信息

以下页中包括机械、封装和可订购信息。 这些信息是针对指定器件可提供的最新数据。 这些数据会在无通知且不
对本文档进行修订的情况下发生改变。 欲获得该数据表的浏览器版本，请查阅左侧的导航栏。

7.1 Q2 封装尺寸

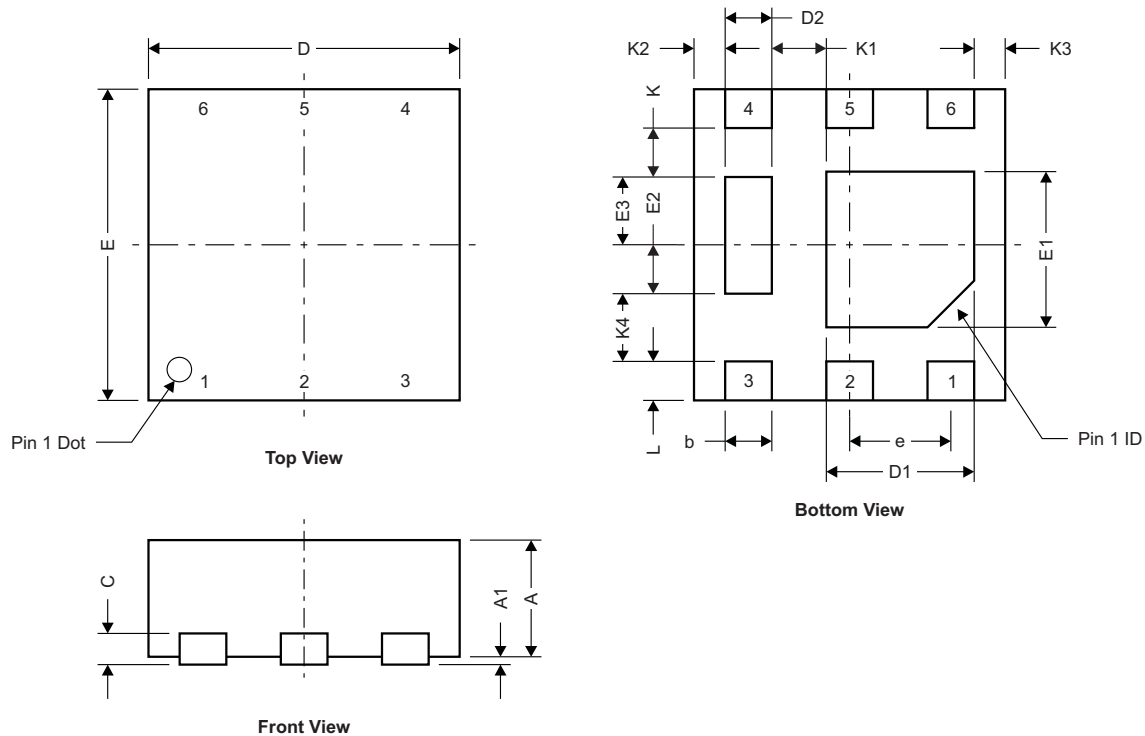

M0165-01

DIM	毫米			英寸		
	最小值	标称值	最大值	最小值	标称值	最大值
A	0.700	0.750	0.800	0.028	0.030	0.032
A1	0.000		0.050	0.000		0.002
b	0.250	0.300	0.350	0.010	0.012	0.014
C		0.203 典型值			0.008 典型值	
D		2.000 典型值			0.080 典型值	
D1	0.900	0.950	1.000	0.036	0.038	0.040
D2		0.300 典型值			0.012 典型值	
E		2.000 典型值			0.080 典型值	
E1	0.900	1.000	1.100	0.036	0.040	0.044
E2		0.280 典型值			0.0112 典型值	
E3		0.470 典型值			0.0188 典型值	
e		0.650 BSC			0.026 典型值	
K		0.280 典型值			0.0112 典型值	
K1		0.350 典型值			0.014 典型值	
K2		0.200 典型值			0.008 典型值	
K3		0.200 典型值			0.008 典型值	
K4		0.470 典型值			0.0188 典型值	
L	0.200	0.25	0.300	0.008	0.010	0.012

7.1.1 建议 PCB 布局

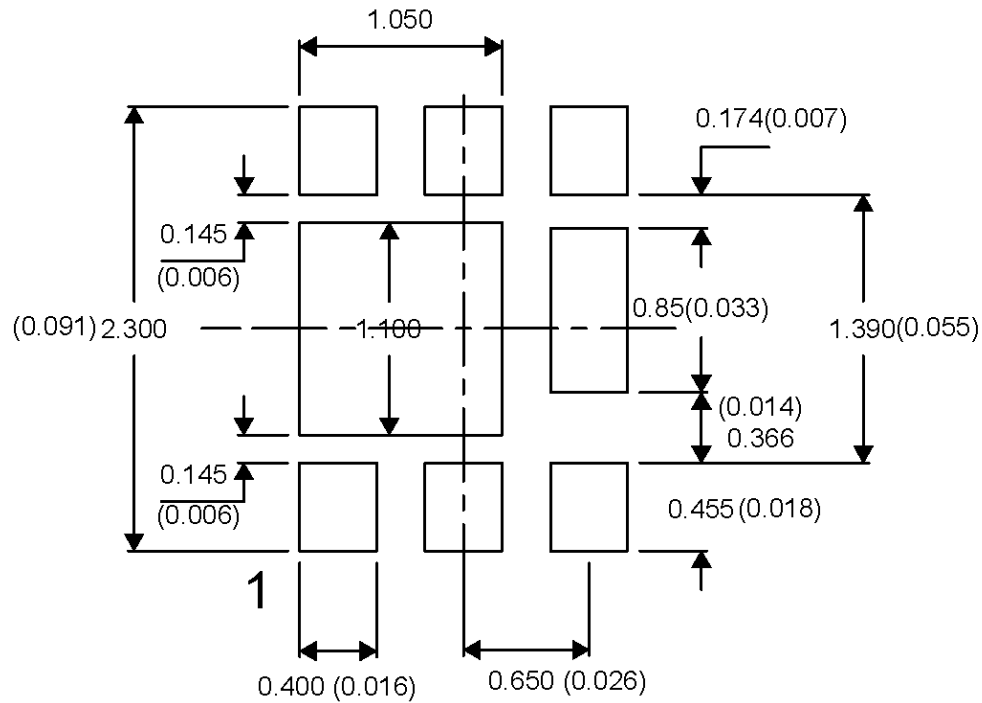

要获得与印刷电路板 (PCB) 设计相关的建议电路布局布线, 请参见《应用说明》[SLPA005](#) - 通过 PCB 布局布线技巧来减少振铃。

7.1.2 建议模板布局

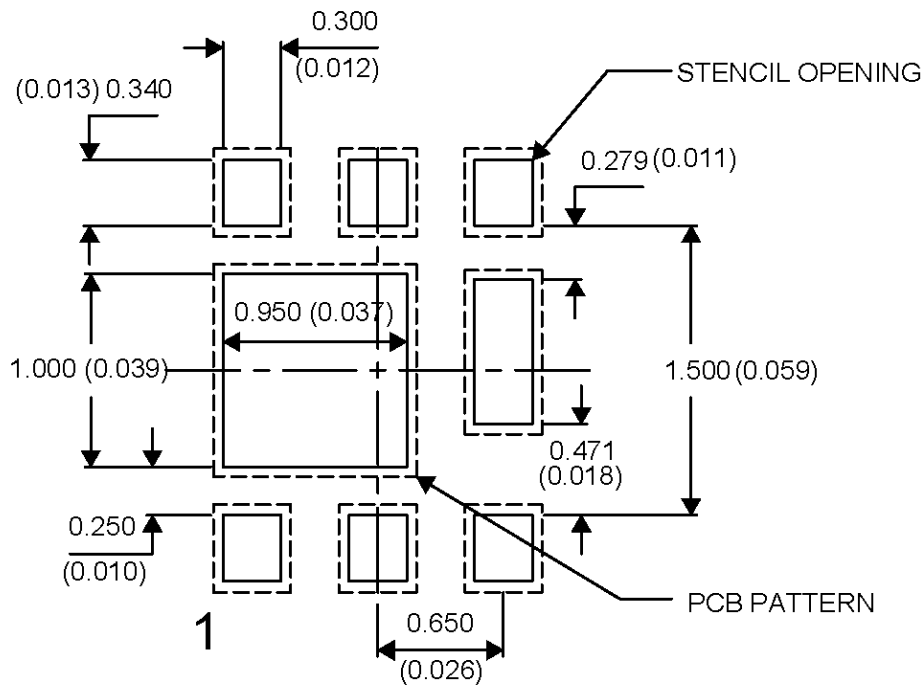

Note: 全部尺寸单位为 mm, 除非另外注明。

7.2 Q2 卷带信息

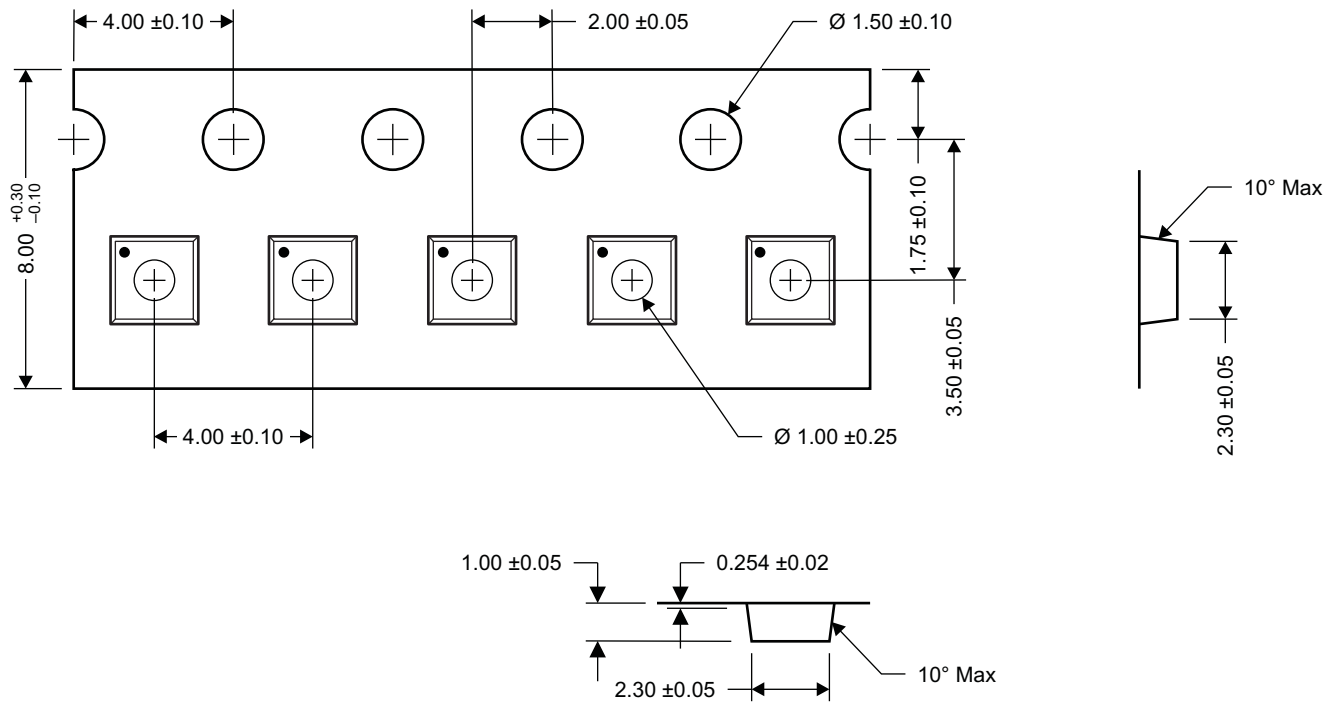

- Notes:
1. 测自链齿孔中心线到孔眼中心线
 2. 10 个链齿孔的累积容差为 ± 0.20
 3. 其他材料可用
 4. 卷带的 SR 典型值最大为 10^9 OHM/SQ
 5. 全部尺寸单位为 mm，除非另外注明。

M0168-01

PACKAGING INFORMATION

Orderable Device	Status (1)	Package Type	Package Drawing	Pins	Package Qty	Eco Plan (2)	Lead finish/ Ball material (6)	MSL Peak Temp (3)	Op Temp (°C)	Device Marking (4/5)	Samples
CSD17571Q2	ACTIVE	WSON	DQK	6	3000	RoHS & Green	NIPDAU	Level-1-260C-UNLIM	-55 to 150	1751	Samples

(1) The marketing status values are defined as follows:

ACTIVE: Product device recommended for new designs.

LIFEBUY: TI has announced that the device will be discontinued, and a lifetime-buy period is in effect.

NRND: Not recommended for new designs. Device is in production to support existing customers, but TI does not recommend using this part in a new design.

PREVIEW: Device has been announced but is not in production. Samples may or may not be available.

OBSOLETE: TI has discontinued the production of the device.

(2) **RoHS:** TI defines "RoHS" to mean semiconductor products that are compliant with the current EU RoHS requirements for all 10 RoHS substances, including the requirement that RoHS substance do not exceed 0.1% by weight in homogeneous materials. Where designed to be soldered at high temperatures, "RoHS" products are suitable for use in specified lead-free processes. TI may reference these types of products as "Pb-Free".

RoHS Exempt: TI defines "RoHS Exempt" to mean products that contain lead but are compliant with EU RoHS pursuant to a specific EU RoHS exemption.

Green: TI defines "Green" to mean the content of Chlorine (Cl) and Bromine (Br) based flame retardants meet JS709B low halogen requirements of <=1000ppm threshold. Antimony trioxide based flame retardants must also meet the <=1000ppm threshold requirement.

(3) MSL, Peak Temp. - The Moisture Sensitivity Level rating according to the JEDEC industry standard classifications, and peak solder temperature.

(4) There may be additional marking, which relates to the logo, the lot trace code information, or the environmental category on the device.

(5) Multiple Device Markings will be inside parentheses. Only one Device Marking contained in parentheses and separated by a "~" will appear on a device. If a line is indented then it is a continuation of the previous line and the two combined represent the entire Device Marking for that device.

(6) Lead finish/Ball material - Orderable Devices may have multiple material finish options. Finish options are separated by a vertical ruled line. Lead finish/Ball material values may wrap to two lines if the finish value exceeds the maximum column width.

Important Information and Disclaimer:The information provided on this page represents TI's knowledge and belief as of the date that it is provided. TI bases its knowledge and belief on information provided by third parties, and makes no representation or warranty as to the accuracy of such information. Efforts are underway to better integrate information from third parties. TI has taken and continues to take reasonable steps to provide representative and accurate information but may not have conducted destructive testing or chemical analysis on incoming materials and chemicals. TI and TI suppliers consider certain information to be proprietary, and thus CAS numbers and other limited information may not be available for release.

In no event shall TI's liability arising out of such information exceed the total purchase price of the TI part(s) at issue in this document sold by TI to Customer on an annual basis.

TAPE AND REEL INFORMATION

QUADRANT ASSIGNMENTS FOR PIN 1 ORIENTATION IN TAPE

*All dimensions are nominal

Device	Package Type	Package Drawing	Pins	SPQ	Reel Diameter (mm)	Reel Width W1 (mm)	A0 (mm)	B0 (mm)	K0 (mm)	P1 (mm)	W (mm)	Pin1 Quadrant
CSD17571Q2	WSO	DQK	6	3000	180.0	9.5	2.3	2.3	1.0	4.0	8.0	Q1

TAPE AND REEL BOX DIMENSIONS

*All dimensions are nominal

Device	Package Type	Package Drawing	Pins	SPQ	Length (mm)	Width (mm)	Height (mm)
CSD17571Q2	WSON	DQK	6	3000	189.0	185.0	36.0

GENERIC PACKAGE VIEW

DQK 6

WSON - 0.8 mm max height

2 x 2, 0.65 mm pitch

PLASTIC SMALL OUTLINE - NO LEAD

This image is a representation of the package family, actual package may vary.
Refer to the product data sheet for package details.

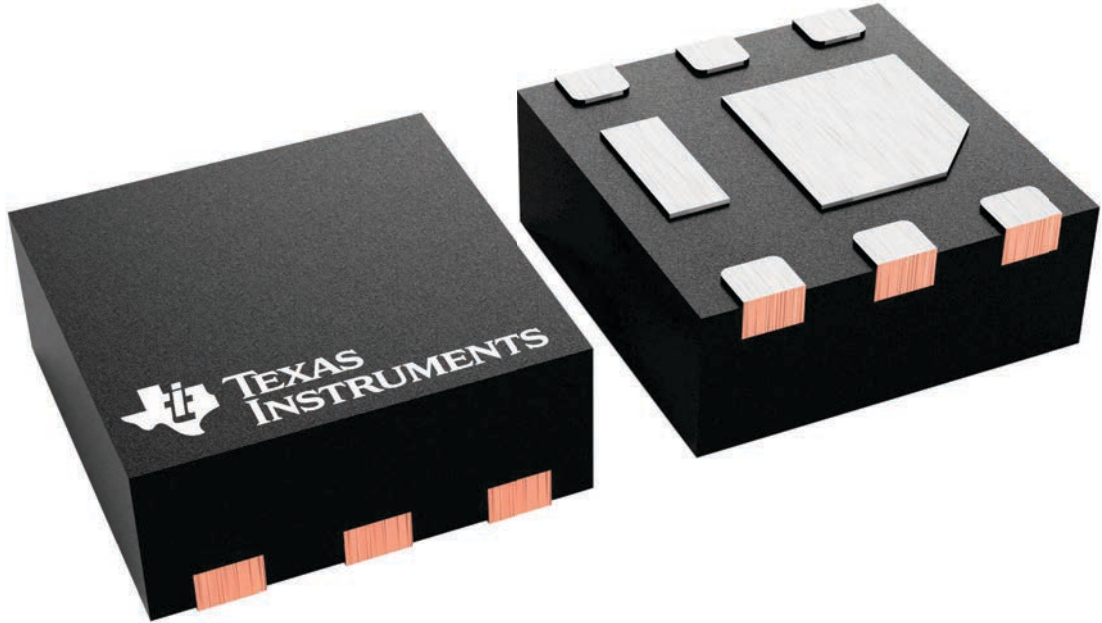

4229807/A

DQK (S-PWSON-N6)

PLASTIC SMALL OUTLINE NO-LEAD

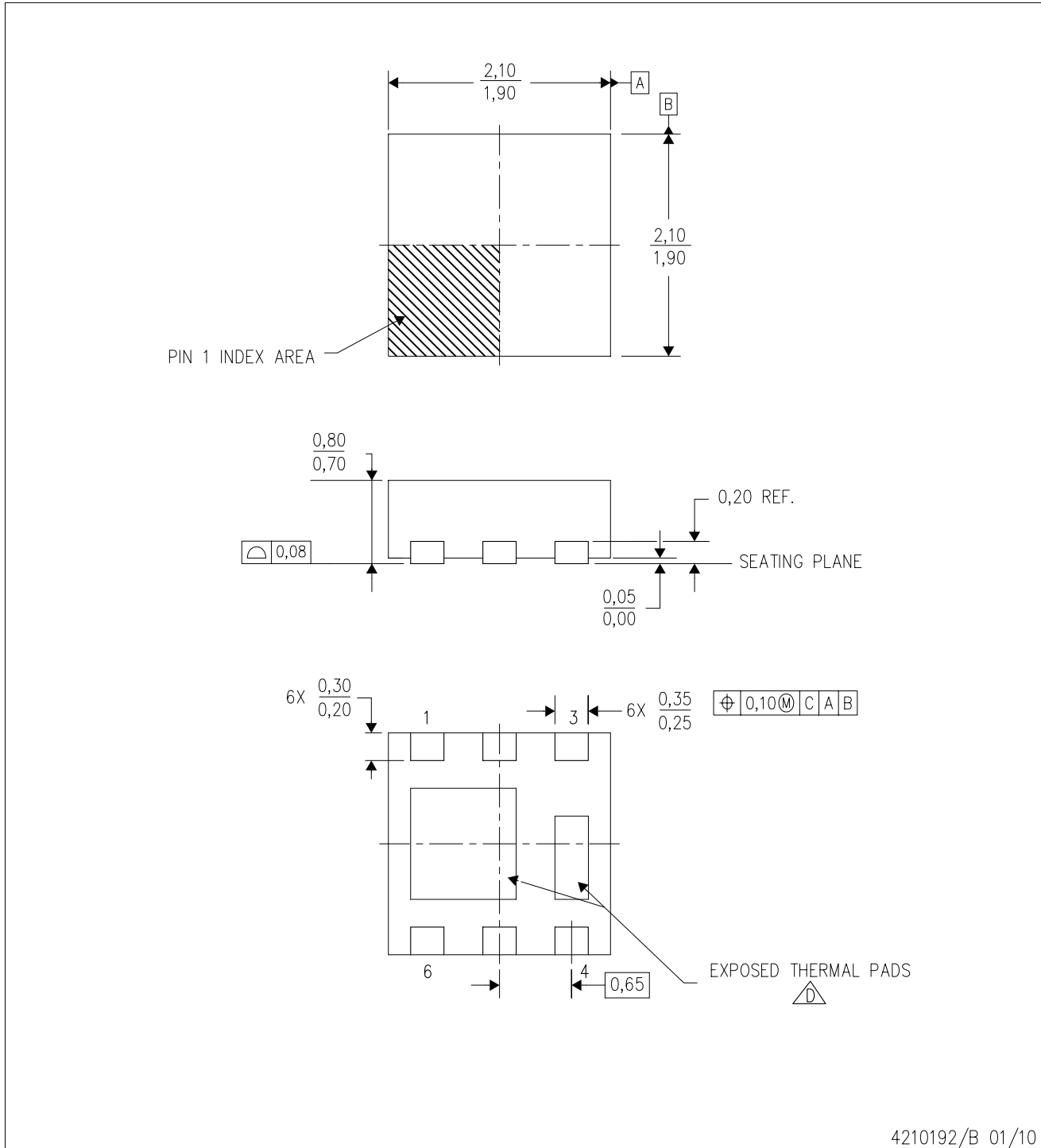

- NOTES:
- A. All linear dimensions are in millimeters. Dimensioning and tolerancing per ASME Y14.5M-1994.
 - B. This drawing is subject to change without notice.
 - C. Small Outline No-Lead (SON) package configuration.
 -  D. The package thermal pads must be soldered to the board for thermal and mechanical performance.

THERMAL INFORMATION

This package incorporates an exposed thermal pad that is designed to be attached directly to an external heatsink. The thermal pad must be soldered directly to the printed circuit board (PCB). After soldering, the PCB can be used as a heatsink. In addition, through the use of thermal vias, the thermal pad can be attached directly to the appropriate copper plane shown in the electrical schematic for the device, or alternatively, can be attached to a special heatsink structure designed into the PCB. This design optimizes the heat transfer from the integrated circuit (IC).

For information on the Quad Flatpack No-Lead (QFN) package and its advantages, refer to Application Report, Quad Flatpack No-Lead Logic Packages, Texas Instruments Literature No. SCBA017. This document is available at www.ti.com.

The exposed thermal pad dimensions for this package are shown in the following illustration.

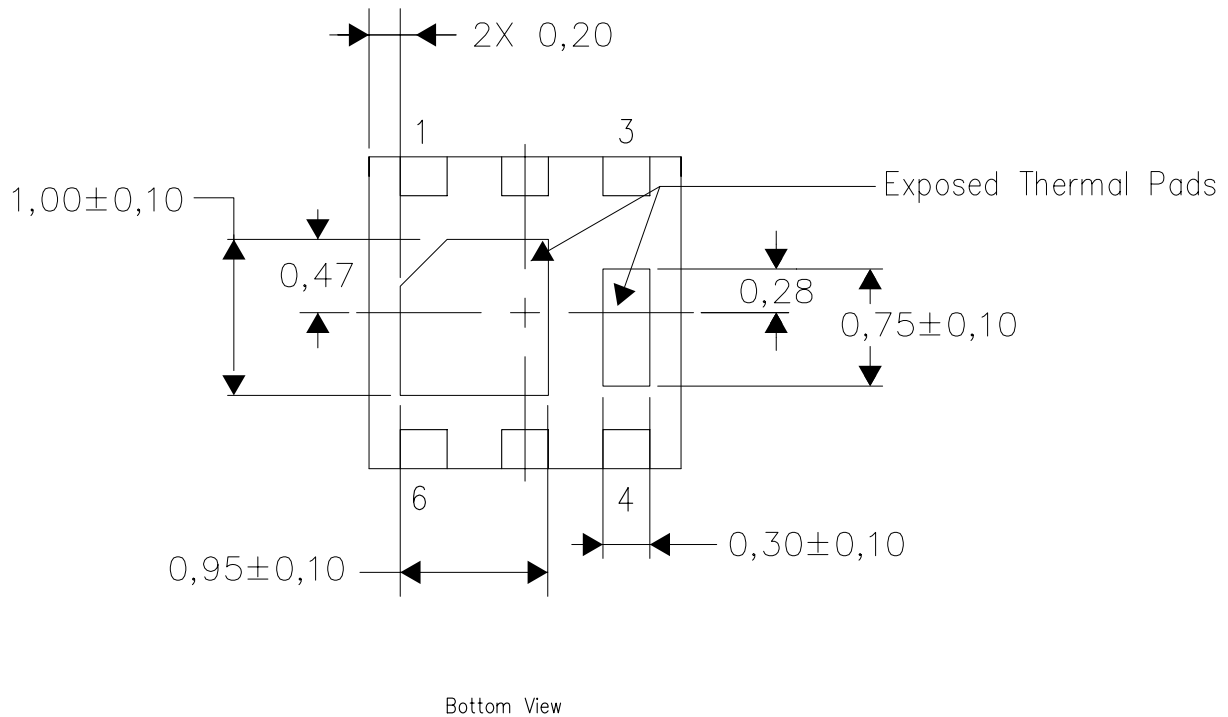

NOTE: All linear dimensions are in millimeters

Exposed Thermal Pad Dimensions

重要声明和免责声明

TI“按原样”提供技术和可靠性数据（包括数据表）、设计资源（包括参考设计）、应用或其他设计建议、网络工具、安全信息和其他资源，不保证没有瑕疵且不做任何明示或暗示的担保，包括但不限于对适销性、某特定用途方面的适用性或不侵犯任何第三方知识产权的暗示担保。

这些资源可供使用 TI 产品进行设计的熟练开发人员使用。您将自行承担以下全部责任：(1) 针对您的应用选择合适的 TI 产品，(2) 设计、验证并测试您的应用，(3) 确保您的应用满足相应标准以及任何其他功能安全、信息安全、监管或其他要求。

这些资源如有变更，恕不另行通知。TI 授权您仅可将这些资源用于研发本资源所述的 TI 产品的应用。严禁对这些资源进行其他复制或展示。您无权使用任何其他 TI 知识产权或任何第三方知识产权。您应全额赔偿因在这些资源的使用中对 TI 及其代表造成的任何索赔、损害、成本、损失和债务，TI 对此概不负责。

TI 提供的产品受 [TI 的销售条款](#) 或 [ti.com](#) 上其他适用条款/TI 产品随附的其他适用条款的约束。TI 提供这些资源并不会扩展或以其他方式更改 TI 针对 TI 产品发布的适用的担保或担保免责声明。

TI 反对并拒绝您可能提出的任何其他或不同的条款。

邮寄地址：Texas Instruments, Post Office Box 655303, Dallas, Texas 75265

Copyright © 2024，德州仪器 (TI) 公司