

# CSD19531Q5A 100V N 通道 NexFET™ 功率金属氧化物半导体场效应晶体管 (MOSFET)

## 1 特性

- 超低  $Q_g$  和  $Q_{gd}$
- 低热阻
- 雪崩额定值
- 无铅端子镀层
- 符合 RoHS 环保标准
- 无卤素
- 小外形尺寸无引线 (SON) 5mm x 6mm 塑料封装

## 2 应用范围

- 初级侧电信应用
- 次级侧同步整流器
- 电机控制

## 3 说明

这款 100V, 5.3mΩ, SON 5mm x 6mm NexFET™ 功率 MOSFET 被设计成在功率转换应用中大大降低损耗。

顶视图

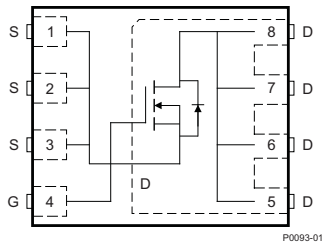

### 产品概要

| $T_A = 25^\circ\text{C}$ |              | 典型值                   |     | 单位 |
|--------------------------|--------------|-----------------------|-----|----|
| $V_{DS}$                 | 漏源电压         | 100                   |     | V  |
| $Q_g$                    | 栅极电荷总量 (10V) | 37                    |     | nC |
| $Q_{gd}$                 | 栅漏栅极电荷       | 6.6                   |     | nC |
| $R_{DS(on)}$             | 漏源导通电阻       | $V_{GS} = 6\text{V}$  | 6.0 | mΩ |
|                          |              | $V_{GS} = 10\text{V}$ | 5.3 | mΩ |
| $V_{GS(th)}$             | 阈值电压         | 2.7                   |     | V  |

### 订购信息

| 器件           | 介质      | 数量   | 封装                 | 出货   |
|--------------|---------|------|--------------------|------|
| CSD19531Q5A  | 13 英寸卷带 | 2500 | SON 5mm x 6mm 塑料封装 | 卷带封装 |
| CSD19531Q5AT | 7 英寸卷带  | 250  |                    |      |

(1) 要了解所有可用封装, 请见数据表末尾的可订购产品附录。

### 最大绝对额定值

| $T_A = 25^\circ\text{C}$ |  | 值         | 单位               |
|--------------------------|--|-----------|------------------|
| $V_{DS}$                 | 漏源电压   | 100       | V                |
| $V_{GS}$                 | 栅源电压   | $\pm 20$  | V                |
| $I_D$                    | 持续漏极电流 (受封装限制)   | 100       | A                |
|                          | 持续漏极电流 (受芯片限制), $T_C = 25^\circ\text{C}$ 时测得                       | 110       |                  |
|                          | 持续漏极电流 <sup>(1)</sup>  | 16        |                  |
| $I_{DM}$                 | 脉冲漏极电流 <sup>(2)</sup>  | 337       | A                |
| $P_D$                    | 功率耗散 <sup>(1)</sup>  | 3.3       | W                |
|                          | 功率耗散, $T_C = 25^\circ\text{C}$                                     | 125       |                  |
| $T_J, T_{stg}$           | 运行结温和 储存温度范围   | -55 至 150 | $^\circ\text{C}$ |
| $E_{AS}$                 | 雪崩能量, 单一脉冲<br>$I_D = 60\text{A}, L = 0.1\text{mH}, R_G = 25\Omega$ | 180       | mJ               |

(1)  $R_{\theta JA} = 40^\circ\text{C/W}$ , 这是在一个厚度 0.06 英寸环氧树脂 (FR4) 印刷电路板 (PCB) 上的 1 英寸<sup>2</sup>, 2 盎司的铜过渡垫片上测得的典型值。

(2) 最大  $R_{\theta JC} = 1.0^\circ\text{C/W}$ , 持续时间  $\leq 100\mu\text{s}$ , 占空比  $\leq 1\%$

### $R_{DS(on)}$ 与 $V_{GS}$ 间的关系

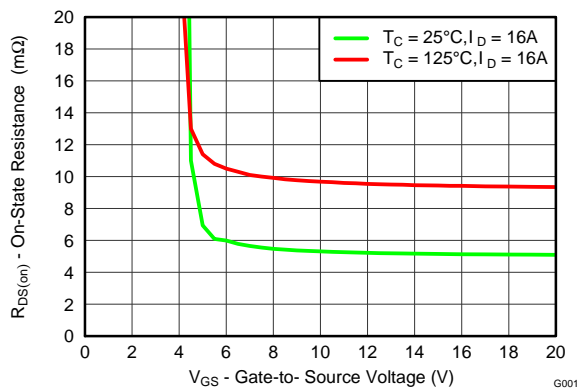

### 栅极电荷

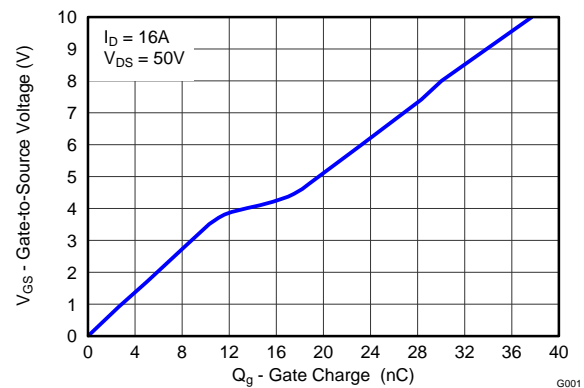

## 目录

|  |  |
|--|--|
| <b>1 特性</b> ..... 1<br><b>2 应用范围</b> ..... 1<br><b>3 说明</b> ..... 1<br><b>4 修订历史记录</b> ..... 2<br><b>5 Specifications</b> ..... 3<br>5.1 Electrical Characteristics..... 3<br>5.2 Thermal Characteristics ..... 3<br>5.3 Typical MOSFET Characteristics..... 4 | <b>6 器件和文档支持</b> ..... 7<br>6.1 Trademarks ..... 7<br>6.2 Electrostatic Discharge Caution..... 7<br>6.3 Glossary ..... 7<br><b>7 机械封装和可订购信息</b> ..... 8<br>7.1 Q5A 封装尺寸..... 9<br>7.2 建议印刷电路板 (PCB) 布局..... 10<br>7.3 建议模板开口..... 11<br>7.4 Q5A 卷带信息..... 11 |
|--|--|

## 4 修订历史记录

NOTE: Page numbers for previous revisions may differ from page numbers in the current version.

| Changes from Revision A (January 2014) to Revision B  | Page |
|---|------|
| • 已添加外壳温度保持在 25°C 时的最大功耗耗散一行 .....  | 1    |
| • Changed <a href="#">Figure 1</a> from a normalized $R_{\theta JA}$ curve to a normalized $R_{\theta JC}$ curve..... | 4    |
| • Updated the safe operating area in <a href="#">Figure 10</a> .....  | 6    |

| Changes from Original (September 2013) to Revision A  | Page |
|---|------|
| • 已在说明中添加更多信息 .....   | 1    |
| • 已添加小卷带订购信息.....   | 1    |
| • 已从绝对最大额定值表内的持续漏极电流（受封装限制）中删除 $T_C = 25^\circ\text{C}$ 条件.....   | 1    |
| • 已将脉冲漏极电流增加为 337A .....  | 1    |
| • 已更新脉冲漏极电流条件 .....   | 1    |
| • Changed Typ $R_{th JA} = 99^\circ\text{C/W}$ to $R_{th JA} = 100^\circ\text{C/W}$ in <a href="#">Figure 1</a> ..... | 4    |

## 5 Specifications

### 5.1 Electrical Characteristics

( $T_A = 25^\circ\text{C}$  unless otherwise stated)

| PARAMETER                      |                                  | TEST CONDITIONS   | MIN | TYP  | MAX  | UNIT          |
|--------------------------------|----------------------------------|---|-----|------|------|---------------|
| <b>STATIC CHARACTERISTICS</b>  |                                  |   |     |      |      |               |
| $V_{DSS}$                      | Drain-to-Source Voltage          | $V_{GS} = 0\text{ V}, I_D = 250\ \mu\text{A}$                                       | 100 |      |      | V             |
| $I_{DSS}$                      | Drain-to-Source Leakage Current  | $V_{GS} = 0\text{ V}, V_{DS} = 80\text{ V}$   |     |      | 1    | $\mu\text{A}$ |
| $I_{GSS}$                      | Gate-to-Source Leakage Current   | $V_{DS} = 0\text{ V}, V_{GS} = 20\text{ V}$   |     |      | 100  | nA            |
| $V_{GS(th)}$                   | Gate-to-Source Threshold Voltage | $V_{DS} = V_{GS}, I_D = 250\ \mu\text{A}$   | 2.2 | 2.7  | 3.3  | V             |
| $R_{DS(on)}$                   | Drain-to-Source On Resistance    | $V_{GS} = 6\text{ V}, I_D = 16\text{ A}$  |     | 6.0  | 7.8  | m $\Omega$    |
|                                |                                  | $V_{GS} = 10\text{ V}, I_D = 16\text{ A}$   |     | 5.3  | 6.4  | m $\Omega$    |
| $g_{fs}$                       | Transconductance                 | $V_{DS} = 10\text{ V}, I_D = 16\text{ A}$   |     | 82   |      | S             |
| <b>DYNAMIC CHARACTERISTICS</b> |                                  |   |     |      |      |               |
| $C_{iss}$                      | Input Capacitance                | $V_{GS} = 0\text{ V}, V_{DS} = 50\text{ V}, f = 1\text{ MHz}$                       |     | 2980 | 3870 | pF            |
| $C_{oss}$                      | Output Capacitance               |   |     | 560  | 728  | pF            |
| $C_{rss}$                      | Reverse Transfer Capacitance     |   |     | 13.0 | 16.9 | pF            |
| $R_G$                          | Series Gate Resistance           |   |     | 1.3  | 2.6  | $\Omega$      |
| $Q_g$                          | Gate Charge Total (10 V)         | $V_{DS} = 50\text{ V}, I_D = 16\text{ A}$   |     | 37   | 48   | nC            |
| $Q_{gd}$                       | Gate Charge Gate to Drain        |   |     | 6.6  |      | nC            |
| $Q_{gs}$                       | Gate Charge Gate to Source       |   |     | 10.5 |      | nC            |
| $Q_{g(th)}$                    | Gate Charge at $V_{th}$          |   |     | 7.3  |      | nC            |
| $Q_{oss}$                      | Output Charge                    | $V_{DS} = 50\text{ V}, V_{GS} = 0\text{ V}$   |     | 97   |      | nC            |
| $t_{d(on)}$                    | Turn On Delay Time               | $V_{DS} = 50\text{ V}, V_{GS} = 10\text{ V}, I_{DS} = 16\text{ A}, R_G = 0\ \Omega$ |     | 6.0  |      | ns            |
| $t_r$                          | Rise Time                        |   |     | 5.8  |      | ns            |
| $t_{d(off)}$                   | Turn Off Delay Time              |   |     | 18.4 |      | ns            |
| $t_f$                          | Fall Time                        |   |     | 5.2  |      | ns            |
| <b>DIODE CHARACTERISTICS</b>   |                                  |   |     |      |      |               |
| $V_{SD}$                       | Diode Forward Voltage            | $I_{SD} = 16\text{ A}, V_{GS} = 0\text{ V}$   |     | 0.8  | 1    | V             |
| $Q_{rr}$                       | Reverse Recovery Charge          | $V_{DS} = 50\text{ V}, I_F = 16\text{ A}, di/dt = 300\text{ A}/\mu\text{s}$         |     | 226  |      | nC            |
| $t_{rr}$                       | Reverse Recovery Time            |   |     | 148  |      | ns            |

### 5.2 Thermal Characteristics

( $T_A = 25^\circ\text{C}$  unless otherwise stated)

| THERMAL METRIC  |  | MIN | TYP | MAX | UNIT                      |
|-----------------|--|-----|-----|-----|---------------------------|
| $R_{\theta JC}$ | Junction-to-Case Thermal Resistance <sup>(1)</sup>       |     |     | 1   | $^\circ\text{C}/\text{W}$ |
| $R_{\theta JA}$ | Junction-to-Ambient Thermal Resistance <sup>(1)(2)</sup> |     |     | 50  |                           |

- (1)  $R_{\theta JC}$  is determined with the device mounted on a 1-inch<sup>2</sup> (6.45-cm<sup>2</sup>), 2-oz. (0.071-mm thick) Cu pad on a 1.5-inch x 1.5-inch (3.81-cm x 3.81-cm), 0.06-inch (1.52-mm) thick FR4 PCB.  $R_{\theta JC}$  is specified by design, whereas  $R_{\theta JA}$  is determined by the user's board design.
- (2) Device mounted on FR4 material with 1-inch<sup>2</sup> (6.45-cm<sup>2</sup>), 2-oz. (0.071-mm thick) Cu.

CSD19531Q5A

ZHCSBK7B – SEPTEMBER 2013 – REVISED MAY 2014

www.ti.com.cn



M0137-01

Max  $R_{\theta JA} = 50^{\circ}\text{C/W}$   
when mounted on  
1 inch<sup>2</sup> (6.45 cm<sup>2</sup>) of  
2-oz. (0.071-mm thick)  
Cu.



M0137-02

Max  $R_{\theta JA} = 115^{\circ}\text{C/W}$   
when mounted on a  
minimum pad area of  
2-oz. (0.071-mm thick)  
Cu.

5.3 Typical MOSFET Characteristics

( $T_A = 25^{\circ}\text{C}$  unless otherwise stated)

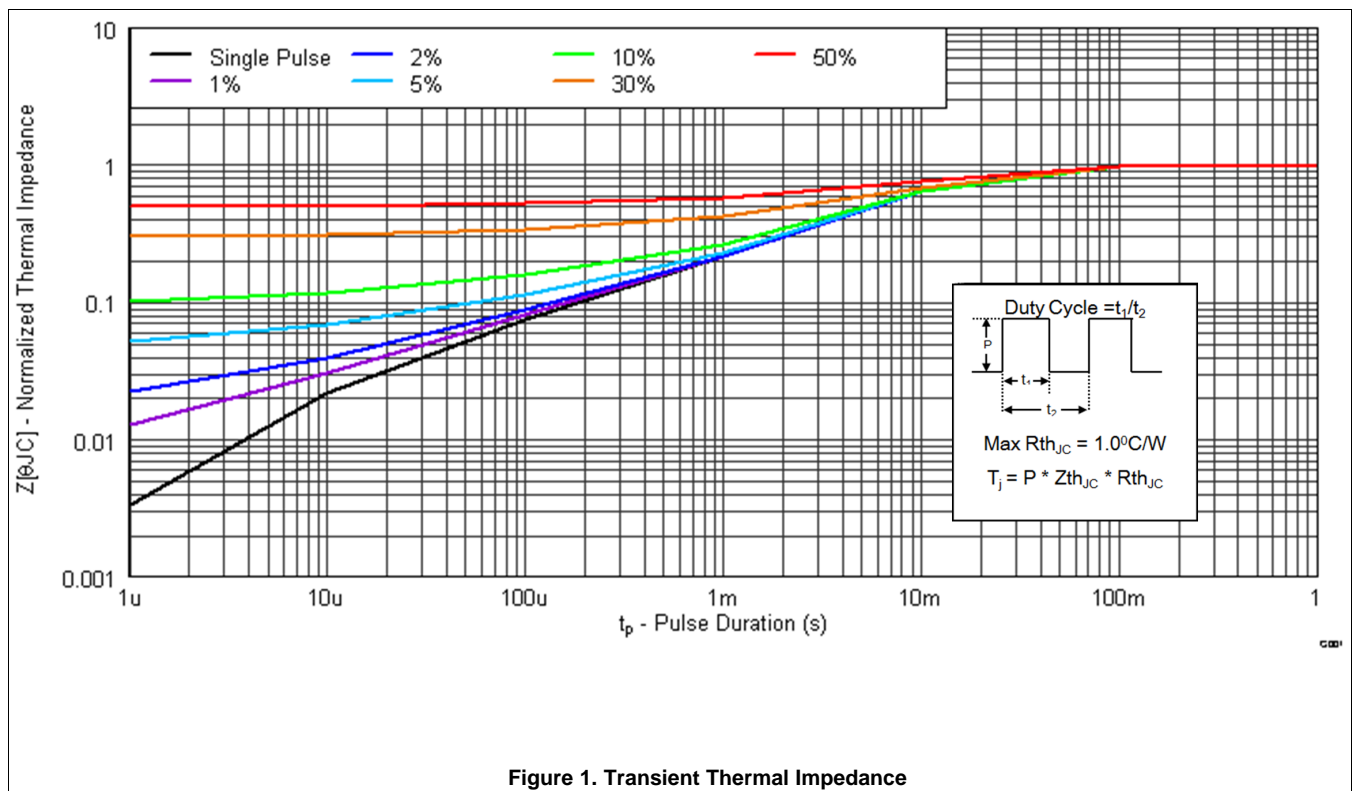

Typical MOSFET Characteristics (continued)

( $T_A = 25^\circ\text{C}$  unless otherwise stated)

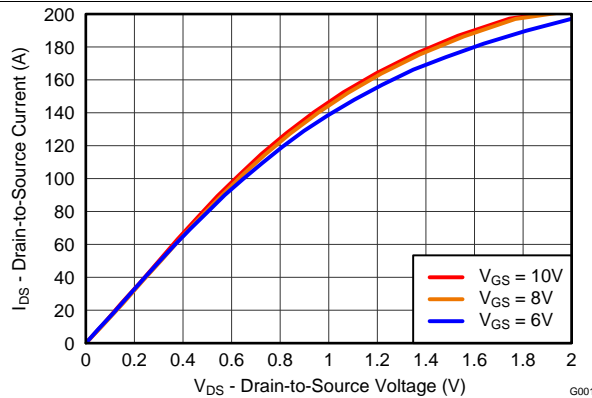

Figure 2. Saturation Characteristics

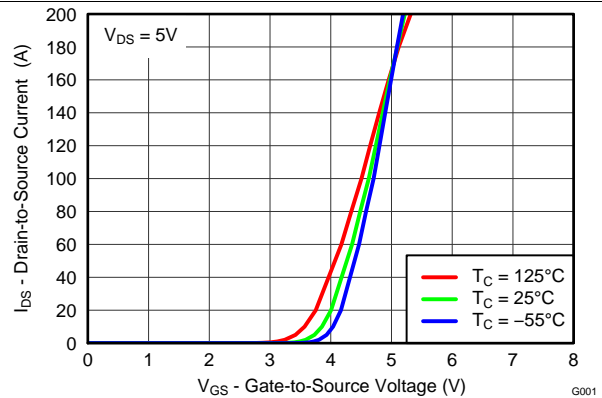

Figure 3. Transfer Characteristics

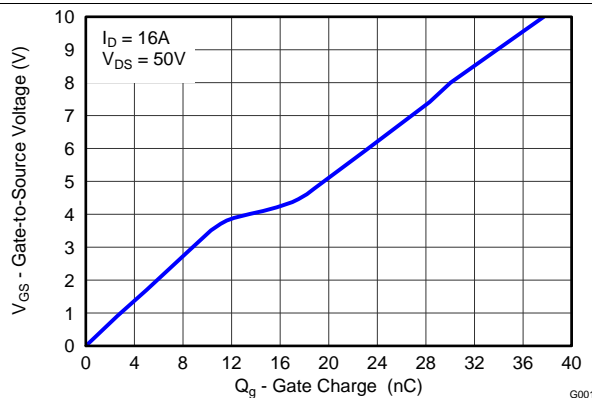

Figure 4. Gate Charge

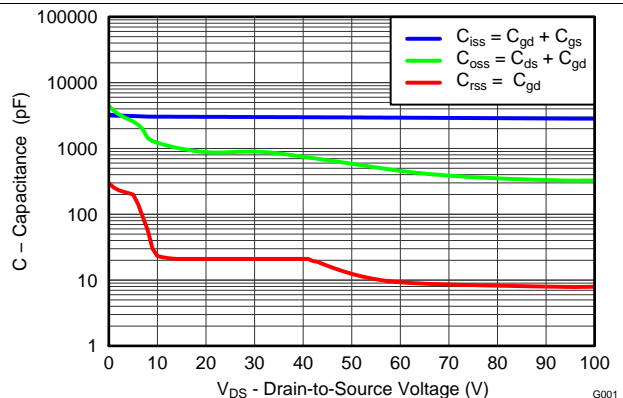

Figure 5. Capacitance

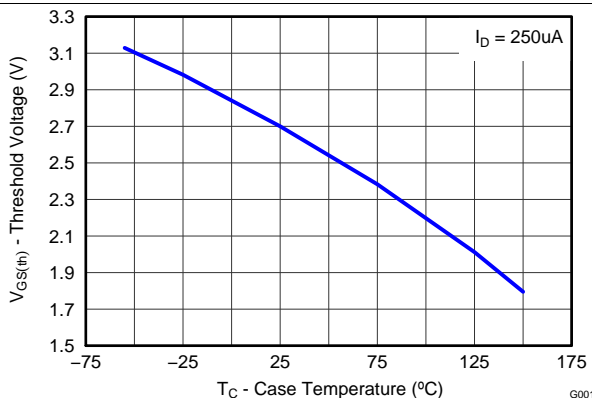

Figure 6. Threshold Voltage vs Temperature

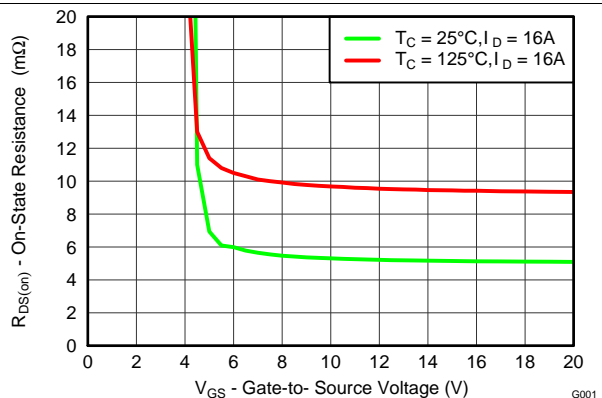

Figure 7. On-State Resistance vs Gate-To-Source Voltage

Typical MOSFET Characteristics (continued)

( $T_A = 25^\circ\text{C}$  unless otherwise stated)

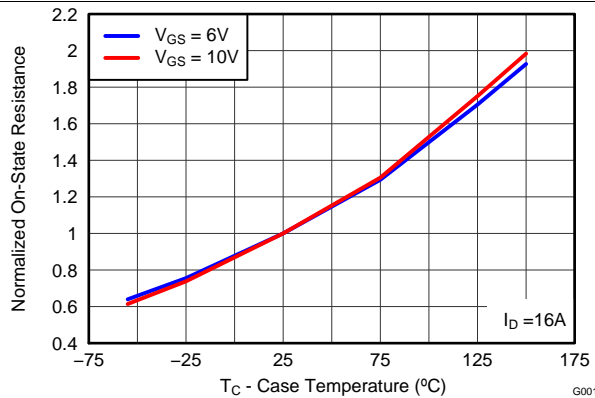

Figure 8. Normalized On-State Resistance vs Temperature

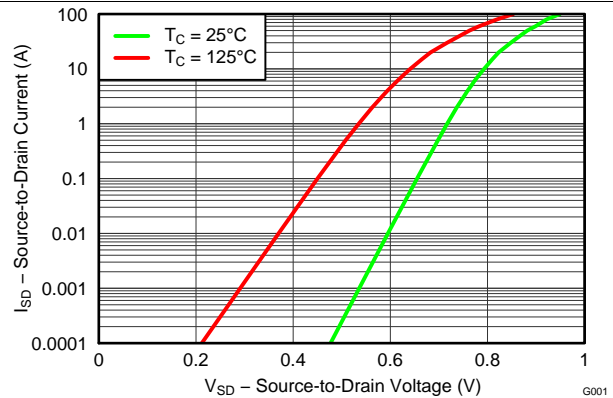

Figure 9. Typical Diode Forward Voltage

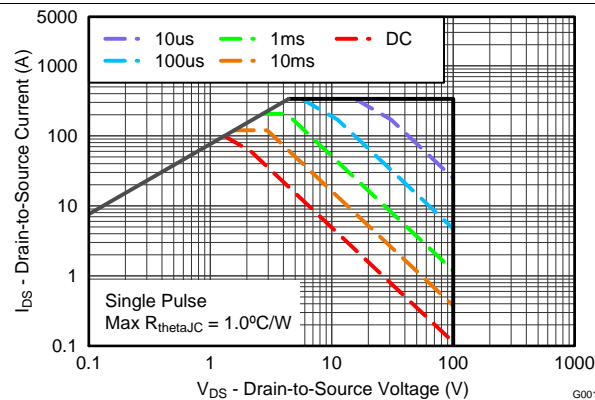

Figure 10. Maximum Safe Operating Area

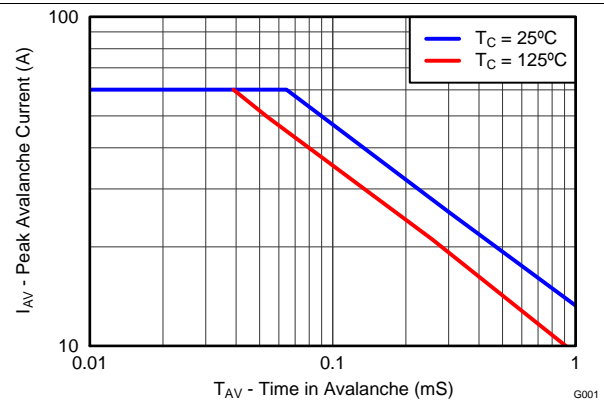

Figure 11. Single Pulse Unclamped Inductive Switching

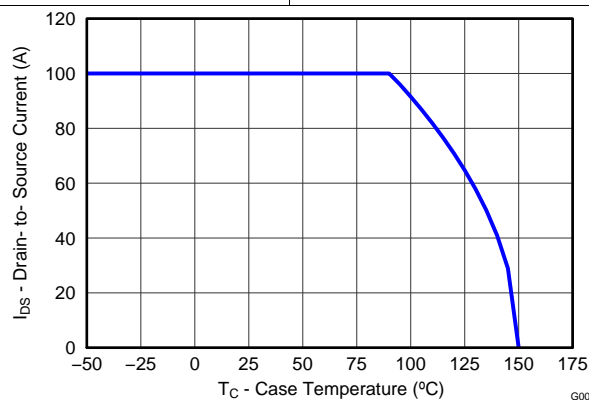

Figure 12. Maximum Drain Current vs Temperature

## 6 器件和文档支持

### 6.1 Trademarks

NexFET is a trademark of Texas Instruments.

### 6.2 Electrostatic Discharge Caution



These devices have limited built-in ESD protection. The leads should be shorted together or the device placed in conductive foam during storage or handling to prevent electrostatic damage to the MOS gates.

### 6.3 Glossary

[SLYZ022](#) — *TI Glossary*.

This glossary lists and explains terms, acronyms and definitions.

## 7 机械封装和可订购信息

以下页中包括机械封装和可订购信息。 这些信息是针对指定器件可提供的最新数据。 这些数据会在无通知且不对本文档进行修订的情况下发生改变。 欲获得该数据表的浏览器版本，请查阅左侧的导航栏。



7.1 Q5A 封装尺寸

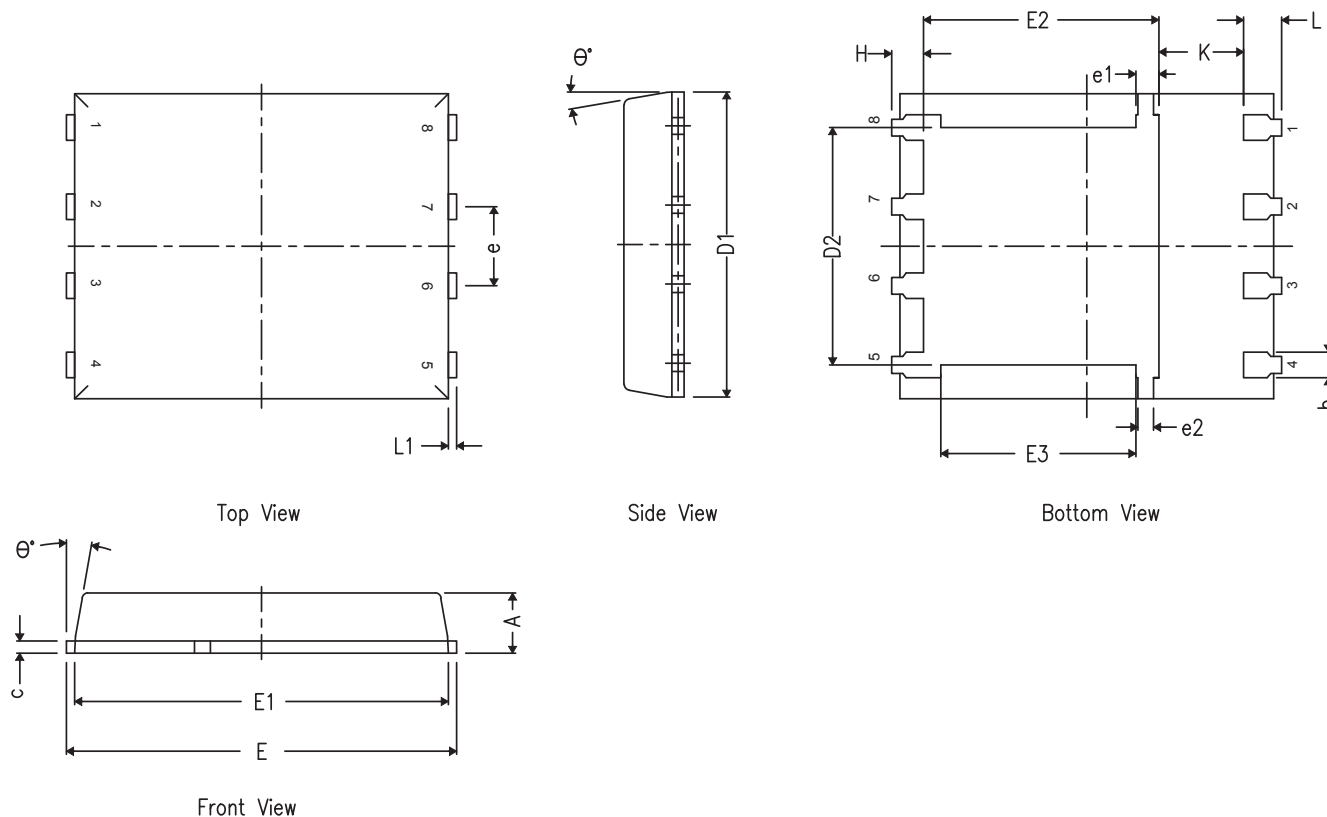

| DIM      | 毫米   |      |      |
|----------|------|------|------|
|          | 最小值  | 标称值  | 最大值  |
| A        | 0.90 | 1.00 | 1.10 |
| b        | 0.33 | 0.41 | 0.51 |
| c        | 0.20 | 0.25 | 0.34 |
| D1       | 4.80 | 4.90 | 5.00 |
| D2       | 3.61 | 3.81 | 4.02 |
| E        | 5.90 | 6.00 | 6.10 |
| E1       | 5.70 | 5.75 | 5.80 |
| E2       | 3.38 | 3.58 | 3.78 |
| E3       | 3.03 | 3.13 | 3.23 |
| e        | 1.17 | 1.27 | 1.37 |
| e1       | 0.27 | 0.37 | 0.47 |
| e2       | 0.15 | 0.25 | 0.35 |
| H        | 0.41 | 0.56 | 0.71 |
| K        | 1.10 | -    | -    |
| L        | 0.51 | 0.61 | 0.71 |
| L1       | 0.06 | 0.13 | 0.20 |
| $\theta$ | 0°   | -    | 12°  |

## 7.2 建议印刷电路板 (PCB) 布局

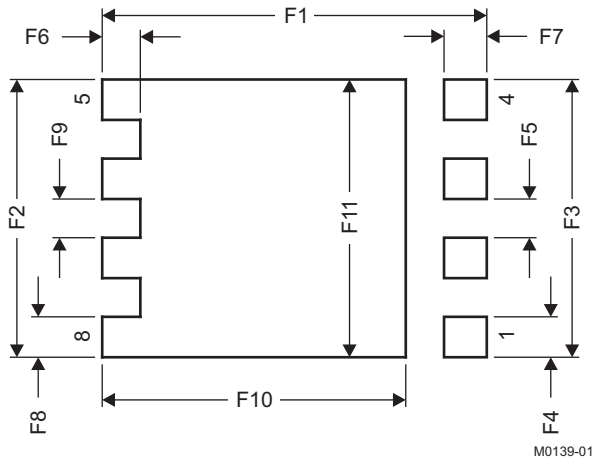

| DIM | 毫米    |       | 英寸    |       |
|-----|-------|-------|-------|-------|
|     | 最小值   | 最大值   | 最小值   | 最大值   |
| F1  | 6.205 | 6.305 | 0.244 | 0.248 |
| F2  | 4.46  | 4.56  | 0.176 | 0.18  |
| F3  | 4.46  | 4.56  | 0.176 | 0.18  |
| F4  | 0.65  | 0.7   | 0.026 | 0.028 |
| F5  | 0.62  | 0.67  | 0.024 | 0.026 |
| F6  | 0.63  | 0.68  | 0.025 | 0.027 |
| F7  | 0.7   | 0.8   | 0.028 | 0.031 |
| F8  | 0.65  | 0.7   | 0.026 | 0.028 |
| F9  | 0.62  | 0.67  | 0.024 | 0.026 |
| F10 | 4.9   | 5     | 0.193 | 0.197 |
| F11 | 4.46  | 4.56  | 0.176 | 0.18  |

要获得与印刷电路板 (PCB) 设计相关的建议电路布局布线, 请参见《应用说明》[SLPA005](#) - 通过 PCB 布局布线技巧来减少振铃。

7.3 建议模板开口

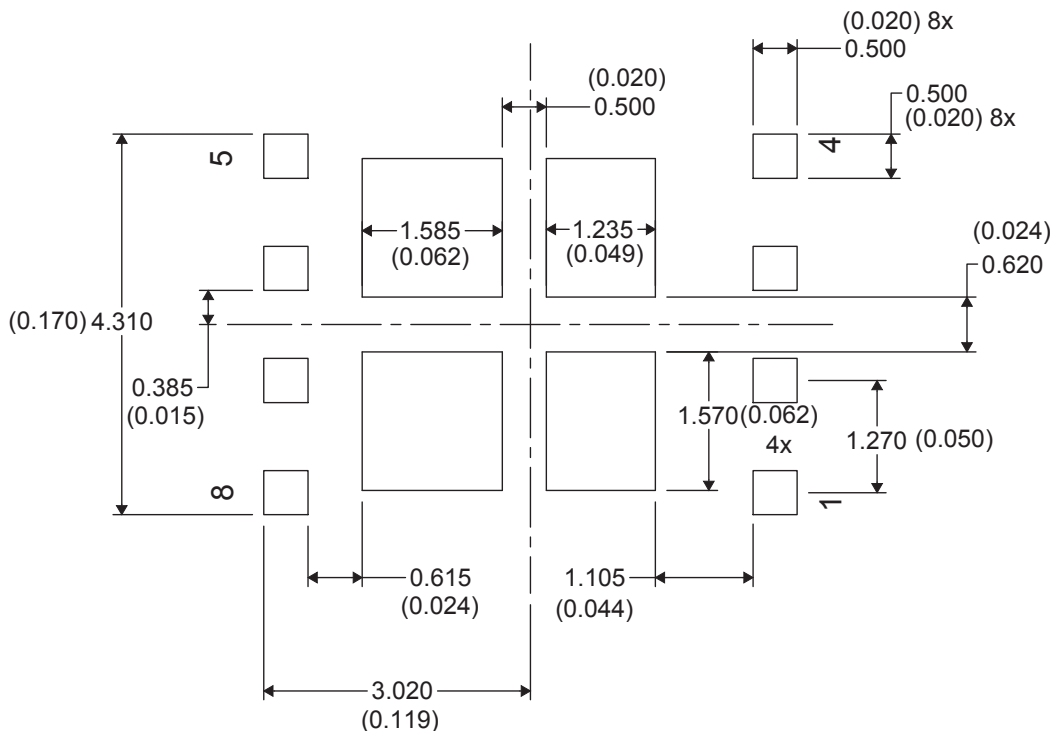

7.4 Q5A 卷带信息

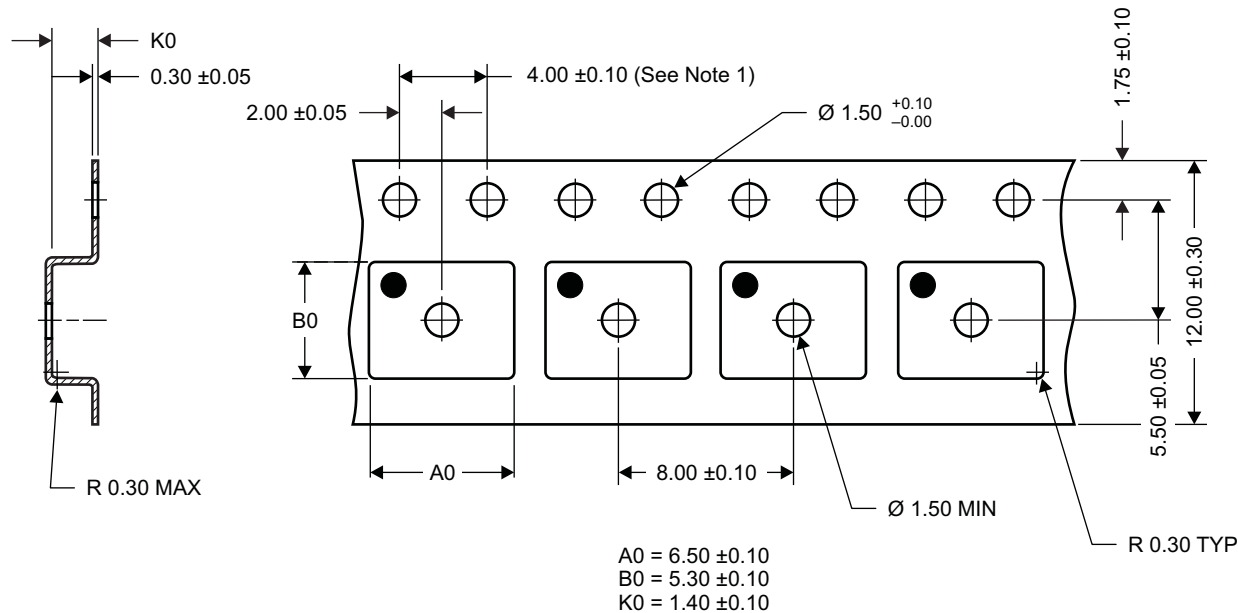

M0138-01



谨记:

1. 10 链轮孔距累积容差  $\pm 0.2$
2. 每 100mm 长度的翘曲不能超过 1mm, 在 250mm 长度上不累积 (Camber not to exceed 1 mm in 100 mm, noncumulative over 250 mm)
3. 材料: 黑色抗静电聚苯乙烯
4. 全部尺寸单位为 mm (除非另外注明)。

**Q5A 卷带信息 (continued)**

5. 高于 (pocket) 底部 0.3mm 的平面上测得的 A0 和 B0。

**PACKAGING INFORMATION**

| Orderable Device | Status<br>(1) | Package Type | Package Drawing | Pins | Package Qty | Eco Plan<br>(2)        | Lead finish/<br>Ball material<br>(6) | MSL Peak Temp<br>(3) | Op Temp (°C) | Device Marking<br>(4/5) | Samples   |
|------------------|---------------|--------------|-----------------|------|-------------|------------------------|--------------------------------------|----------------------|--------------|-------------------------|---|
| CSD19531Q5A      | ACTIVE        | VSONP        | DQJ             | 8    | 2500        | RoHS-Exempt<br>& Green | SN                                   | Level-1-260C-UNLIM   | -55 to 150   | CSD19531                |  |
| CSD19531Q5AT     | ACTIVE        | VSONP        | DQJ             | 8    | 250         | RoHS-Exempt<br>& Green | SN                                   | Level-1-260C-UNLIM   | -55 to 150   | CSD19531                |  |

(1) The marketing status values are defined as follows:

**ACTIVE:** Product device recommended for new designs.

**LIFEBUY:** TI has announced that the device will be discontinued, and a lifetime-buy period is in effect.

**NRND:** Not recommended for new designs. Device is in production to support existing customers, but TI does not recommend using this part in a new design.

**PREVIEW:** Device has been announced but is not in production. Samples may or may not be available.

**OBSOLETE:** TI has discontinued the production of the device.

(2) **RoHS:** TI defines "RoHS" to mean semiconductor products that are compliant with the current EU RoHS requirements for all 10 RoHS substances, including the requirement that RoHS substance do not exceed 0.1% by weight in homogeneous materials. Where designed to be soldered at high temperatures, "RoHS" products are suitable for use in specified lead-free processes. TI may reference these types of products as "Pb-Free".

**RoHS Exempt:** TI defines "RoHS Exempt" to mean products that contain lead but are compliant with EU RoHS pursuant to a specific EU RoHS exemption.

**Green:** TI defines "Green" to mean the content of Chlorine (Cl) and Bromine (Br) based flame retardants meet JS709B low halogen requirements of <=1000ppm threshold. Antimony trioxide based flame retardants must also meet the <=1000ppm threshold requirement.

(3) MSL, Peak Temp. - The Moisture Sensitivity Level rating according to the JEDEC industry standard classifications, and peak solder temperature.

(4) There may be additional marking, which relates to the logo, the lot trace code information, or the environmental category on the device.

(5) Multiple Device Markings will be inside parentheses. Only one Device Marking contained in parentheses and separated by a "~" will appear on a device. If a line is indented then it is a continuation of the previous line and the two combined represent the entire Device Marking for that device.

(6) Lead finish/Ball material - Orderable Devices may have multiple material finish options. Finish options are separated by a vertical ruled line. Lead finish/Ball material values may wrap to two lines if the finish value exceeds the maximum column width.

**Important Information and Disclaimer:**The information provided on this page represents TI's knowledge and belief as of the date that it is provided. TI bases its knowledge and belief on information provided by third parties, and makes no representation or warranty as to the accuracy of such information. Efforts are underway to better integrate information from third parties. TI has taken and continues to take reasonable steps to provide representative and accurate information but may not have conducted destructive testing or chemical analysis on incoming materials and chemicals. TI and TI suppliers consider certain information to be proprietary, and thus CAS numbers and other limited information may not be available for release.

In no event shall TI's liability arising out of such information exceed the total purchase price of the TI part(s) at issue in this document sold by TI to Customer on an annual basis.



**TAPE AND REEL INFORMATION**

**QUADRANT ASSIGNMENTS FOR PIN 1 ORIENTATION IN TAPE**

\*All dimensions are nominal

| Device       | Package Type | Package Drawing | Pins | SPQ  | Reel Diameter (mm) | Reel Width W1 (mm) | A0 (mm) | B0 (mm) | K0 (mm) | P1 (mm) | W (mm) | Pin1 Quadrant |
|--------------|--------------|-----------------|------|------|--------------------|--------------------|---------|---------|---------|---------|--------|---------------|
| CSD19531Q5A  | VSONP        | DQJ             | 8    | 2500 | 330.0              | 12.4               | 6.3     | 5.3     | 1.2     | 8.0     | 12.0   | Q1            |
| CSD19531Q5AT | VSONP        | DQJ             | 8    | 250  | 180.0              | 12.4               | 6.3     | 5.3     | 1.2     | 8.0     | 12.0   | Q1            |

**TAPE AND REEL BOX DIMENSIONS**

\*All dimensions are nominal

| Device       | Package Type | Package Drawing | Pins | SPQ  | Length (mm) | Width (mm) | Height (mm) |
|--------------|--------------|-----------------|------|------|-------------|------------|-------------|
| CSD19531Q5A  | VSONP        | DQJ             | 8    | 2500 | 340.0       | 340.0      | 38.0        |
| CSD19531Q5AT | VSONP        | DQJ             | 8    | 250  | 190.0       | 190.0      | 30.0        |



# PACKAGE OUTLINE

DQJ0008A

VSONP - 1.1 mm max height

PLASTIC SMALL OUTLINE - NO LEAD

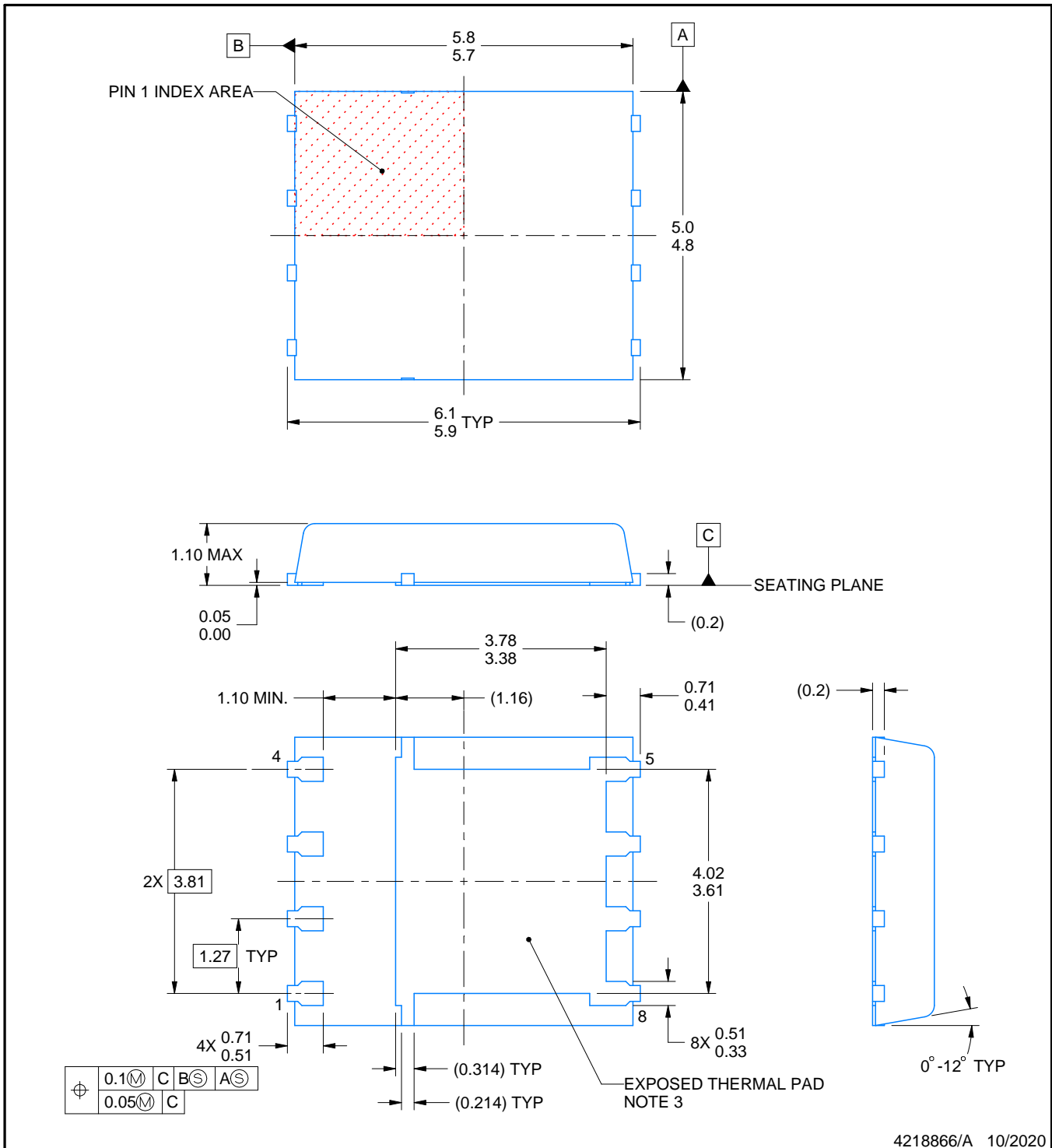

**NOTES:**

1. All linear dimensions are in millimeters. Any dimensions in parenthesis are for reference only. Dimensioning and tolerancing per ASME Y14.5M.
2. This drawing is subject to change without notice.
3. The package thermal pad must be soldered to the printed circuit board for thermal and mechanical performance.
4. Metalized features are supplier options and may not be on the package.
5. All dimensions do not include mold flash or protrusions.

# EXAMPLE BOARD LAYOUT

DQJ0008A

VSONP - 1.1 mm max height

PLASTIC SMALL OUTLINE - NO LEAD

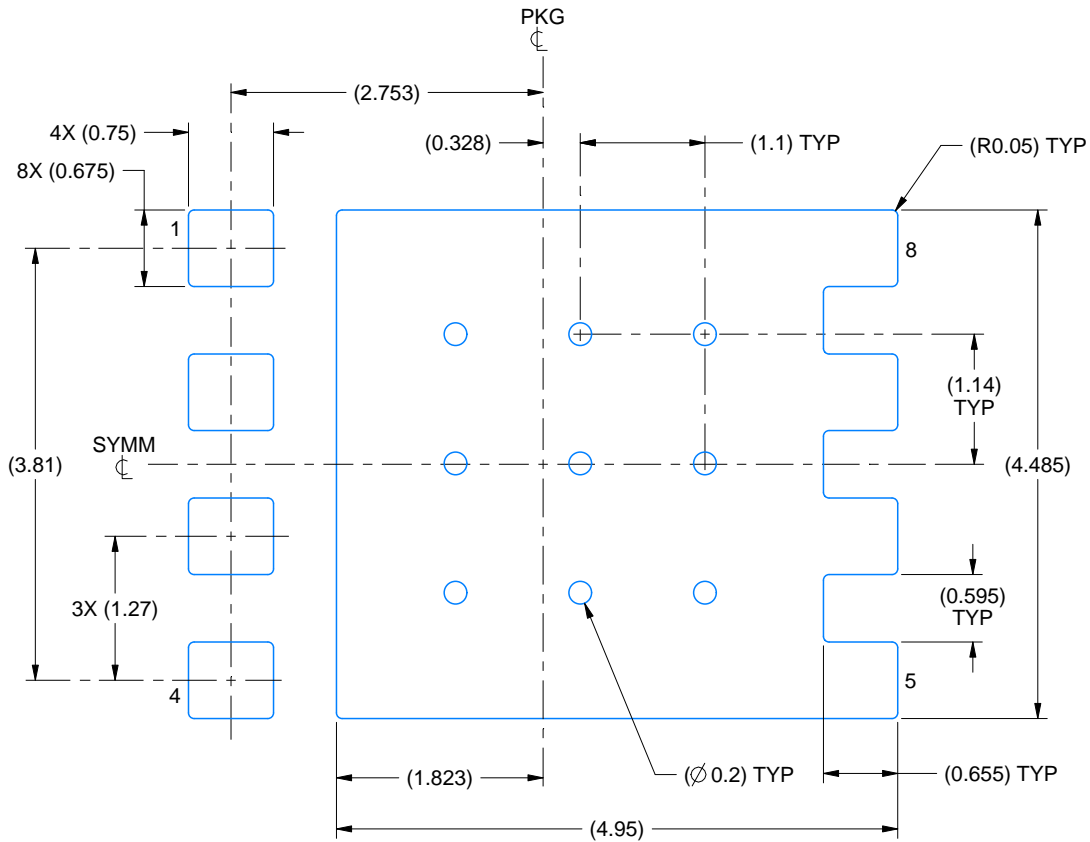

LAND PATTERN EXAMPLE  
SOLDER MASK DEFINED  
SCALE: 15X

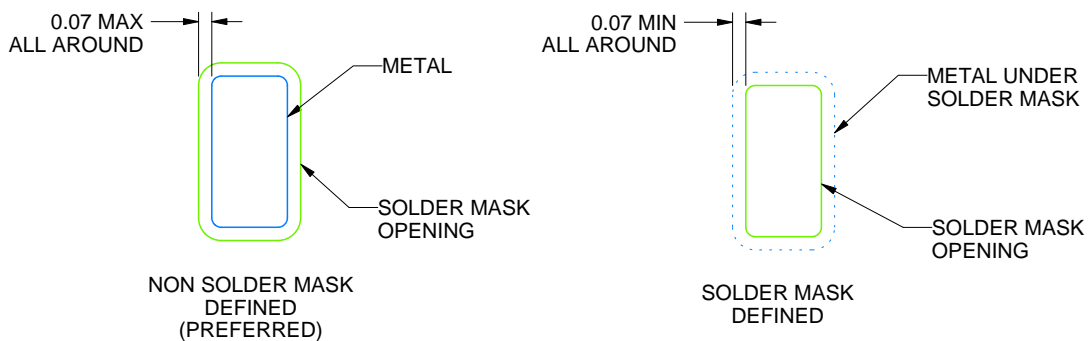

SOLDER MASK DETAILS

4218866/A 10/2020

NOTES: (continued)

6. This package is designed to be soldered to a thermal pad on the board. For more information, see Texas Instruments literature number SLUA271 ([www.ti.com/lit/slua271](http://www.ti.com/lit/slua271)).
7. Vias are optional depending on application, refer to device data sheet. If some or all are implemented, recommended via locations are shown.

# EXAMPLE STENCIL DESIGN

DQJ0008A

VSONP - 1.1 mm max height

PLASTIC SMALL OUTLINE - NO LEAD

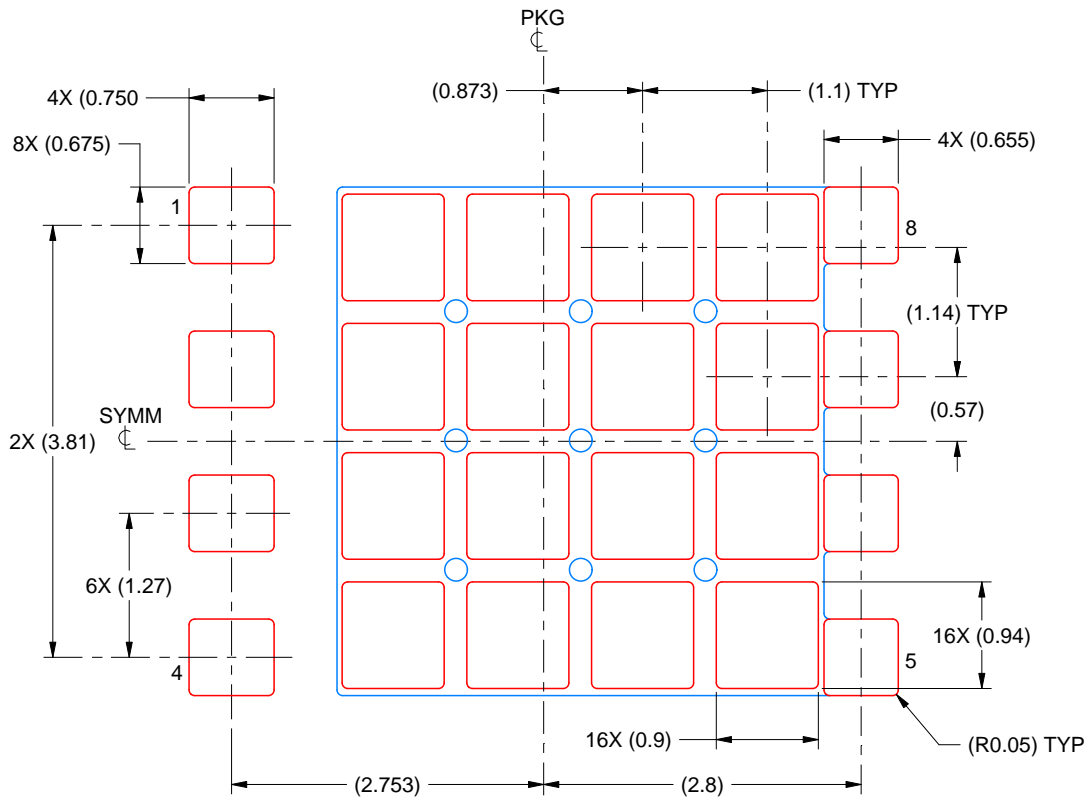

SOLDER PASTE EXAMPLE  
BASED ON 0.125 mm THICK STENCIL

EXPOSED PAD:  
70% PRINTED SOLDER COVERAGE BY AREA UNDER PACKAGE  
SCALE: 15X

4218866/A 10/2020

NOTES: (continued)

8. Laser cutting apertures with trapezoidal walls and rounded corners may offer better paste release. IPC-7525 may have alternate design recommendations.

## 重要声明和免责声明

TI“按原样”提供技术和可靠性数据（包括数据表）、设计资源（包括参考设计）、应用或其他设计建议、网络工具、安全信息和其他资源，不保证没有瑕疵且不做任何明示或暗示的担保，包括但不限于对适销性、某特定用途方面的适用性或不侵犯任何第三方知识产权的暗示担保。

这些资源可供使用 TI 产品进行设计的熟练开发人员使用。您将自行承担以下全部责任：(1) 针对您的应用选择合适的 TI 产品，(2) 设计、验证并测试您的应用，(3) 确保您的应用满足相应标准以及任何其他功能安全、信息安全、监管或其他要求。

这些资源如有变更，恕不另行通知。TI 授权您仅可将这些资源用于研发本资源所述的 TI 产品的应用。严禁对这些资源进行其他复制或展示。您无权使用任何其他 TI 知识产权或任何第三方知识产权。您应全额赔偿因在这些资源的使用中对 TI 及其代表造成的任何索赔、损害、成本、损失和债务，TI 对此概不负责。

TI 提供的产品受 [TI 的销售条款](#) 或 [ti.com](#) 上其他适用条款/TI 产品随附的其他适用条款的约束。TI 提供这些资源并不会扩展或以其他方式更改 TI 针对 TI 产品发布的适用的担保或担保免责声明。

TI 反对并拒绝您可能提出的任何其他或不同的条款。

邮寄地址：Texas Instruments, Post Office Box 655303, Dallas, Texas 75265

Copyright © 2023，德州仪器 (TI) 公司