

CSD87381P 同步降压 NexFET™ 电源块 II

1 特性

- 半桥电源块
- 10A 电流下的系统效率达 90%
- 工作电流高达 15A
- 高密度 - 3mm x 2.5mm 接合栅格阵列封装 (LGA) 尺寸
- 双侧冷却能力
- 超薄 - 最大厚度为 0.48mm
- 针对 5V 栅极驱动进行了优化
- 低开关损耗
- 低电感封装
- 符合 RoHS 环保标准
- 无卤素
- 无铅

2 应用范围

- 同步降压转换器
 - 高电流、低占空比应用
- 多相位同步降压转换器
- 负载点 (POL) 直流 - 直流转换器

3 说明

此 CSD87381P NexFET™ 电源块 II 是针对同步降压应用的高度优化设计，能够在 3mm x 2.5mm 的小外形尺寸封装内提供大电流和高效率。针对 5V 栅极驱动应用进行了优化，这款产品可提供高效且灵活的解决方案，在与外部控制器/驱动器的任一 5V 栅极驱动器配套使用时，可提供一个高密度电源。

器件信息(1)

器件	介质	数量	封装	出货
CSD87381P	13 英寸卷带	2500	3mm x 2.5mm LGA	卷带封装
CSD87381PT	7 英寸卷带	250		

(1) 要了解所有可用封装，请见数据表末尾的可订购产品附录。

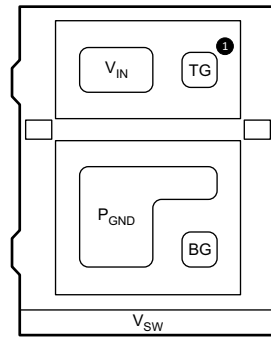

典型电路

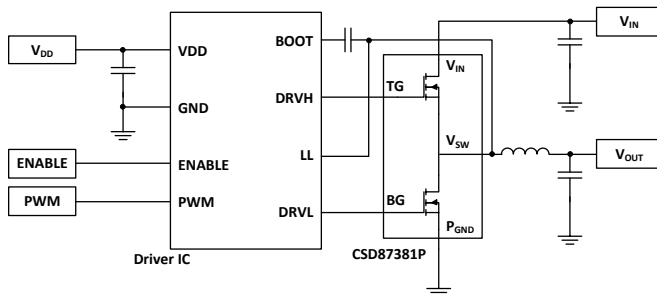

典型电源块效率与功率损耗

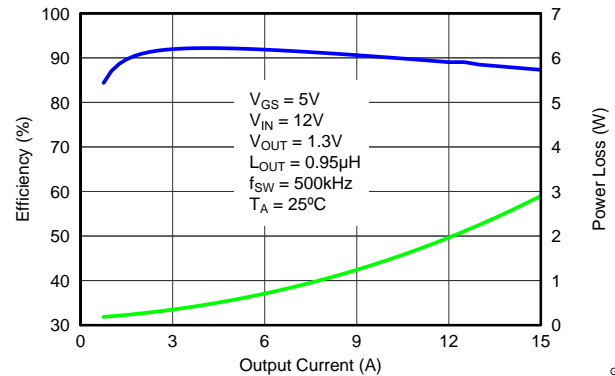

G001



目录

1 特性	1	7 Layout	14
2 应用范围	1	7.1 Layout Guidelines	14
3 说明	1	7.2 Layout Example	14
4 修订历史记录	2	8 器件和文档支持	15
5 Specifications	3	8.1 商标	15
5.1 Absolute Maximum Ratings	3	8.2 静电放电警告	15
5.2 Recommended Operating Conditions	3	8.3 术语表	15
5.3 Power Block Performance	3	9 机械、封装和可订购信息	16
5.4 Thermal Information	4	9.1 CSD87381P 封装尺寸	16
5.5 Electrical Characteristics	4	9.2 焊盘布局建议	17
5.6 Typical Power Block Characteristics	5	9.3 模板建议 (100µm)	18
5.7 Typical Power Block MOSFET Characteristics	7	9.4 模板建议 (125µm)	18
6 Application and Implementation	10	9.5 引脚图	19
6.1 Application Information	10	9.6 CSD87381P 压纹载带尺寸	19

4 修订历史记录

NOTE: Page numbers for previous revisions may differ from page numbers in the current version.

Changes from Revision E (June 2014) to Revision F	Page
• Changed capacitance units to read pF in Figure 15	8
• Changed capacitance units to read pF in Figure 16	8

Changes from Revision D (May 2014) to Revision E	Page
• 将“无铅引脚镀层”特性更改成了“无铅”	1

Changes from Revision C (January 2014) to Revision D	Page
• 更新了数据表以反映新标准	1
• 已更正器件尺寸	1

Changes from Revision B (May 2013) to Revision C	Page
• 更新了标题	1
• 已添加小卷带信息	1
• Added unit to test condition in Electrical Characteristics	4
• Added a link for Figure 29 in Electrical Performance	14

Changes from Revision A (March 2013) to Revision B	Page
• Changed $R_{\theta JC-PCB}$ To: $R_{\theta JC}$ in the Thermal Information table	4
• Changed Figure 15	7

Changes from Original (March 2013) to Revision A	Page
• 更改了产品预览器件	1

5 Specifications

5.1 Absolute Maximum Ratings

 $T_A = 25^\circ\text{C}$ (unless otherwise noted) ⁽¹⁾

		MIN	MAX	UNIT
Voltage	V_{IN} to P_{GND}	-0.8	30	V
	V_{SW} to P_{GND}		30	
	V_{SW} to P_{GND} (10 ns)		32	
	T_G to V_{SW}	-8	10	
	B_G to P_{GND}	-8	10	
I_{DM}	Pulsed Current Rating ⁽²⁾		40	A
P_D	Power Dissipation ⁽³⁾		4	W
E_{AS}	Avalanche Energy	Sync FET, $I_D = 27$, $L = 0.1$ mH	36	mJ
		Control FET, $I_D = 20$, $L = 0.1$ mH	20	
T_J	Operating Junction	-55	150	$^\circ\text{C}$
T_{stg}	Storage Temperature Range	-55	150	$^\circ\text{C}$

(1) Stresses beyond those listed under *Absolute Maximum Ratings* may cause permanent damage to the device. These are stress ratings only, and functional operation of the device at these or any other conditions beyond those indicated is not implied. Exposure to absolute-maximum-rated conditions for extended periods may affect device reliability.

(2) Pulse Duration ≤ 50 μs , duty cycle ≤ 0.01

(3) Device mounted on FR4 material with 1 inch² (6.45 cm²) Cu

5.2 Recommended Operating Conditions

 $T_A = 25^\circ$ (unless otherwise noted)

		MIN	MAX	UNIT	
V_{GS}	Gate Drive Voltage	4.5	8	V	
V_{IN}	Input Supply Voltage		24	V	
f_{SW}	Switching Frequency	$C_{BST} = 0.1$ μF (min)	200	1500	kHz
Operating Current	No Airflow		15	A	
	With Airflow (200 LFM)		20		
	With Airflow + Heat Sink		25		
T_J	Operating Temperature		125	$^\circ\text{C}$	

5.3 Power Block Performance

 $T_A = 25^\circ$ (unless otherwise noted)

PARAMETER	CONDITIONS	MIN	TYP	MAX	UNIT
P_{LOSS}	Power Loss ⁽¹⁾		1		W
I_{QVIN}	V_{IN} Quiescent Current		10		μA

(1) Measurement made with six 10 μF (TDK C3216X5R1C106KT or equivalent) ceramic capacitors placed across V_{IN} to P_{GND} pins and using a high current 5 V driver IC.

5.4 Thermal Information

 $T_A = 25^\circ\text{C}$ (unless otherwise stated)

THERMAL METRIC		MIN	TYP	MAX	UNIT
$R_{\theta JA}$	Junction-to-ambient thermal resistance (min Cu) ⁽¹⁾			184	°C/W
	Junction-to-ambient thermal resistance (max Cu) ⁽²⁾⁽¹⁾			84	
$R_{\theta JC}$	Junction-to-case thermal resistance (top of package) ⁽¹⁾			4.9	
	Junction-to-case thermal resistance (P_{GND} pin) ⁽¹⁾			1.65	

(1) $R_{\theta JC}$ is determined with the device mounted on a 1 inch² (6.45 cm²), 2 oz. (0.071 mm thick) Cu pad on a 1.5 inches × 1.5 inches (3.81 cm × 3.81 cm), 0.06 inch (1.52 mm) thick FR4 board. $R_{\theta JC}$ is specified by design while $R_{\theta JA}$ is determined by the user's board design.

(2) Device mounted on FR4 material with 1 inch² (6.45 cm²) Cu.

5.5 Electrical Characteristics

 $T_A = 25^\circ\text{C}$ (unless otherwise stated)

PARAMETER	TEST CONDITIONS	Q1 Control FET			Q2 Sync FET			UNIT	
		MIN	TYP	MAX	MIN	TYP	MAX		
STATIC CHARACTERISTICS									
BV_{DSS}	Drain-to-Source Voltage	$V_{GS} = 0\text{ V}, I_{DS} = 250\ \mu\text{A}$	30			30		V	
I_{DSS}	Drain-to-Source Leakage Current	$V_{GS} = 0\text{ V}, V_{DS} = 24\text{ V}$					1	μA	
I_{GSS}	Gate-to-Source Leakage Current	$V_{DS} = 0\text{ V}, V_{GS} = 10\text{ V}$			100		100	nA	
$V_{GS(th)}$	Gate-to-Source Threshold Voltage	$V_{DS} = V_{GS}, I_{DS} = 250\ \mu\text{A}$	1.1		1.9	1		1.7	V
$R_{DS(on)}$	Drain-to-Source On-Resistance	$V_{GS} = 4.5\text{ V}, I_{DS} = 8\text{ A}$		15.7	18.9		7	8.4	m Ω
		$V_{GS} = 8\text{ V}, I_{DS} = 8\text{ A}$		13.6	16.3		6.3	7.6	
g_{fs}	Transconductance	$V_{DS} = 10\text{ V}, I_{DS} = 8\text{ A}$		40			89	S	
DYNAMIC CHARACTERISTICS									
C_{ISS}	Input Capacitance ⁽¹⁾	$V_{GS} = 0\text{ V}, V_{DS} = 15\text{ V}, f = 1\text{ MHz}$		434	564		1020	1320	pF
C_{OSS}	Output Capacitance ⁽¹⁾			225	293		308	400	pF
C_{RSS}	Reverse Transfer Capacitance ⁽¹⁾			9.1	11.8		40	52	pF
R_G	Series Gate Resistance ⁽¹⁾		5	6.4		1.25	2.5	Ω	
Q_g	Gate Charge Total (4.5 V) ⁽¹⁾	$V_{DS} = 15\text{ V}, I_{DS} = 8\text{ A}$		3.9	5		8.9	11.5	nC
Q_{gd}	Gate Charge – Gate-to-Drain			0.9			2.5		nC
Q_{gs}	Gate Charge – Gate-to-Source			1.2			2		nC
$Q_{g(th)}$	Gate Charge at V_{th}			0.7			1.3		nC
Q_{OSS}	Output Charge	$V_{DD} = 12\text{ V}, V_{GS} = 0\text{ V}$		4.9			8.5		nC
$t_{d(on)}$	Turn On Delay Time			6.7			7.9		ns
t_r	Rise Time	$V_{DS} = 15\text{ V}, V_{GS} = 4.5\text{ V}, I_{DS} = 8\text{ A}, R_G = 2\ \Omega$		19.3			16.3		ns
$t_{d(off)}$	Turn Off Delay Time			10.6			16.8		ns
t_f	Fall Time			3			2.9		ns
DIODE CHARACTERISTICS									
V_{SD}	Diode Forward Voltage	$I_{DS} = 8\text{ A}, V_{GS} = 0\text{ V}$		0.85			0.79		V
Q_{rr}	Reverse Recovery Charge	$V_{dd} = 15\text{ V}, I_F = 8\text{ A}, di/dt = 300\text{ A}/\mu\text{s}$		8			16		nC
t_{rr}	Reverse Recovery Time			13			17		ns

(1) Specified by design

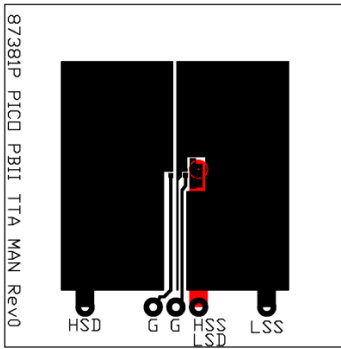

Max $R_{\theta JA} = 84^{\circ}\text{C/W}$ when mounted on 1 inch² (6.45 cm²) of 2 oz. (0.071 mm thick) Cu.

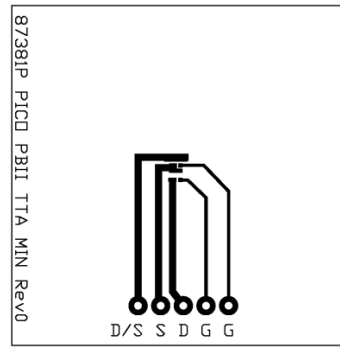

Max $R_{\theta JA} = 184^{\circ}\text{C/W}$ when mounted on minimum pad area of 2 oz. (0.071 mm thick) Cu.

5.6 Typical Power Block Characteristics

$T_J = 125^{\circ}\text{C}$, unless stated otherwise. For Figure 3 and Figure 4, the Typical Power Block System Characteristic curves are based on measurements made on a PCB design with dimensions of 4 inches (W) × 3.5 inches (L) × 0.062 inch (H) and 6 copper layers of 1 oz. copper thickness. See [Application and Implementation](#) for detailed explanation.

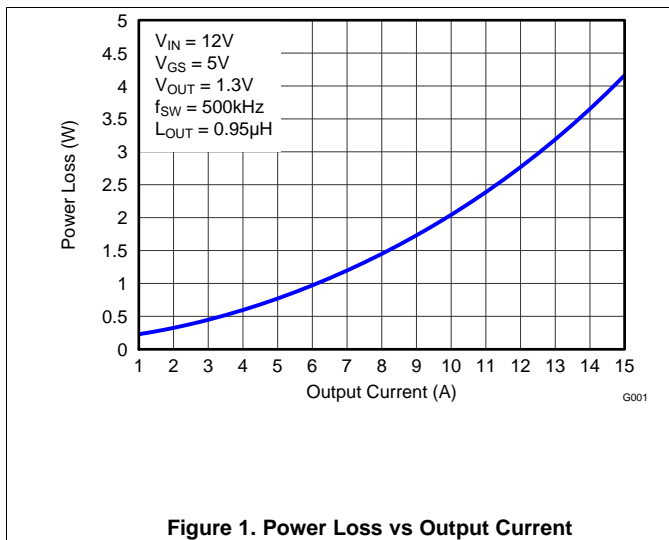

Figure 1. Power Loss vs Output Current

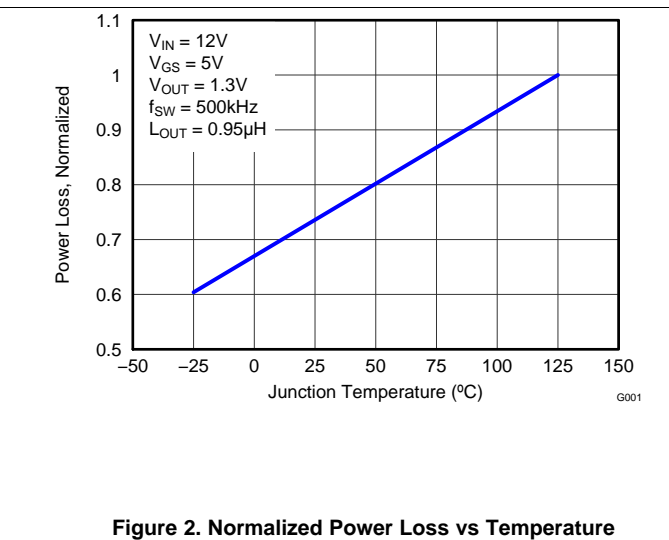

Figure 2. Normalized Power Loss vs Temperature

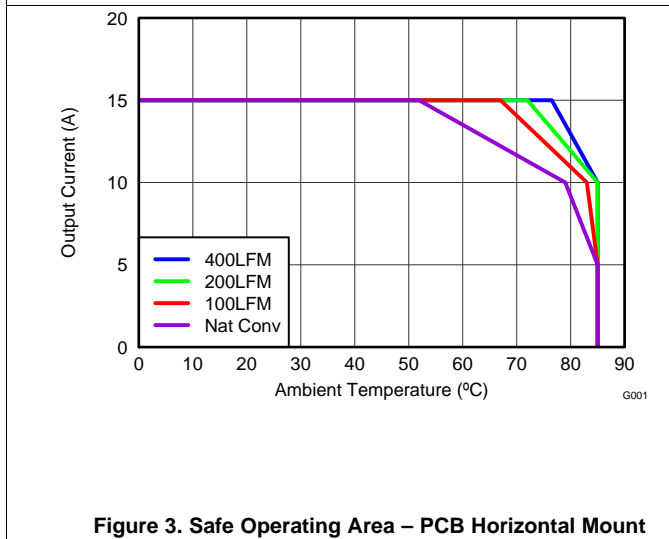

Figure 3. Safe Operating Area – PCB Horizontal Mount

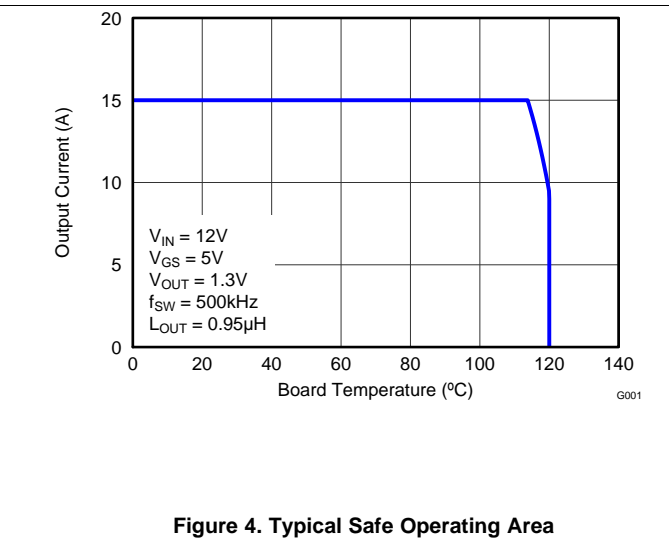

Figure 4. Typical Safe Operating Area

Typical Power Block Characteristics (continued)

$T_J = 125^\circ\text{C}$, unless stated otherwise. For Figure 3 and Figure 4, the Typical Power Block System Characteristic curves are based on measurements made on a PCB design with dimensions of 4 inches (W) x 3.5 inches (L) x 0.062 inch (H) and 6 copper layers of 1 oz. copper thickness. See [Application and Implementation](#) for detailed explanation.

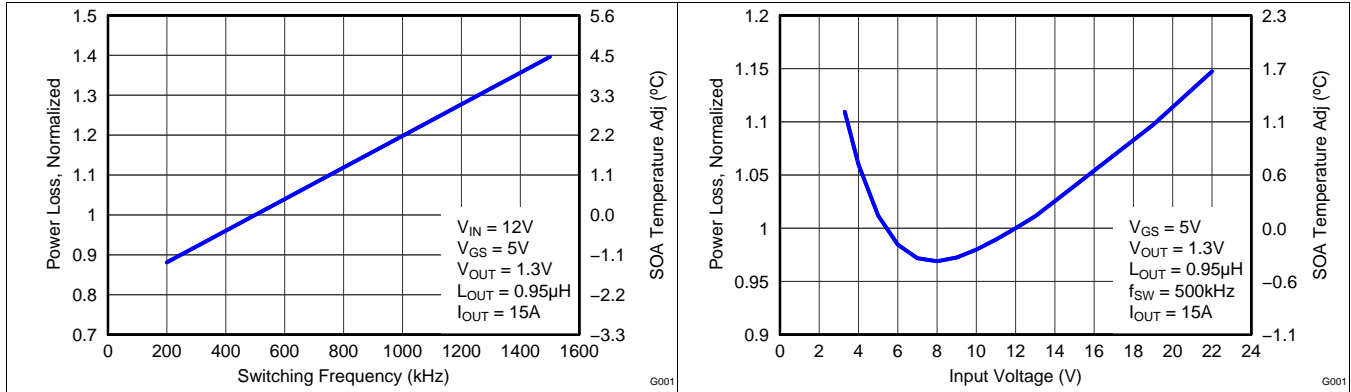

Figure 5. Normalized Power Loss vs Switching Frequency

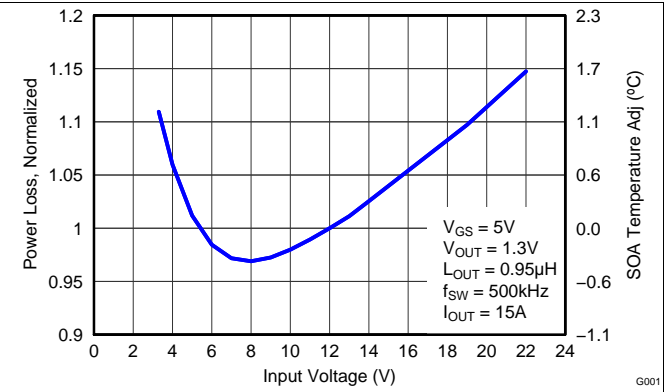

Figure 6. Normalized Power Loss vs Input Voltage

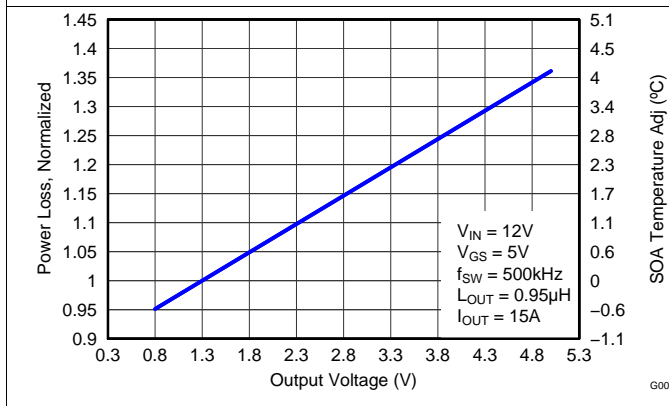

Figure 7. Normalized Power Loss vs Output Voltage

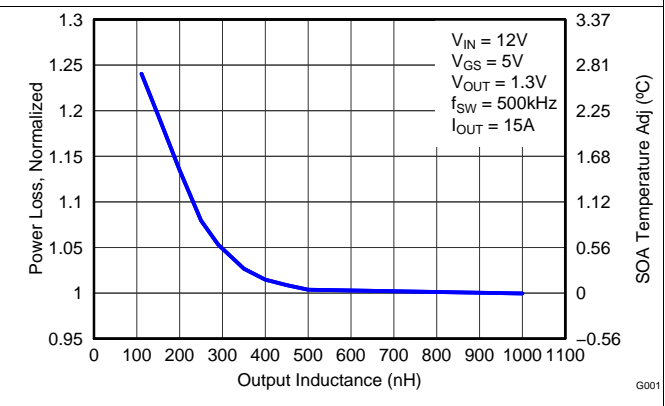
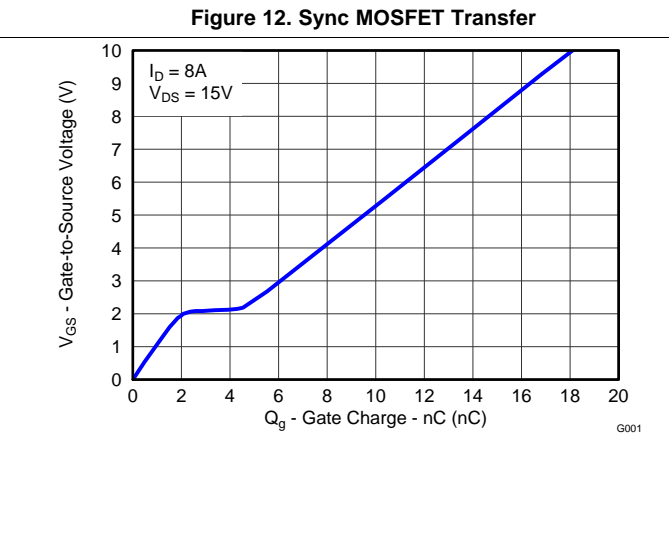
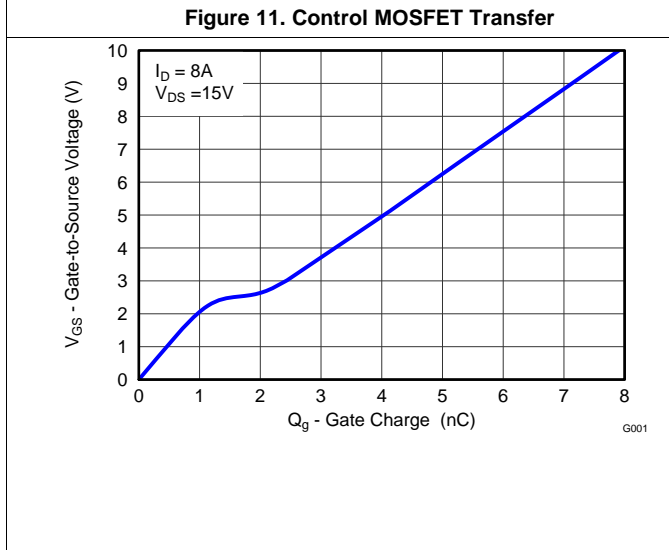
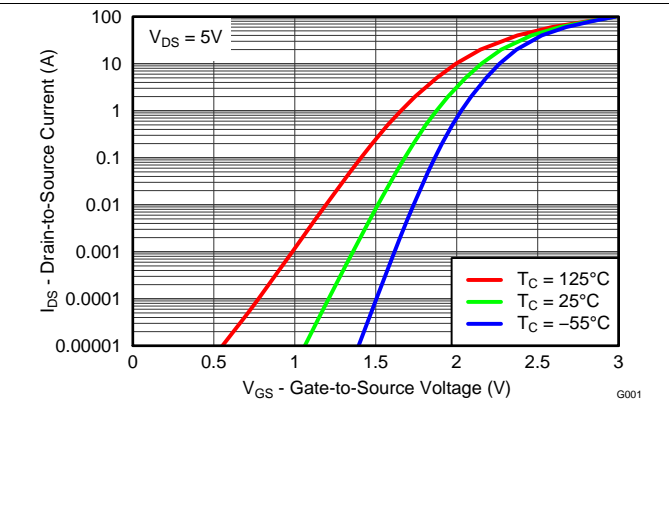
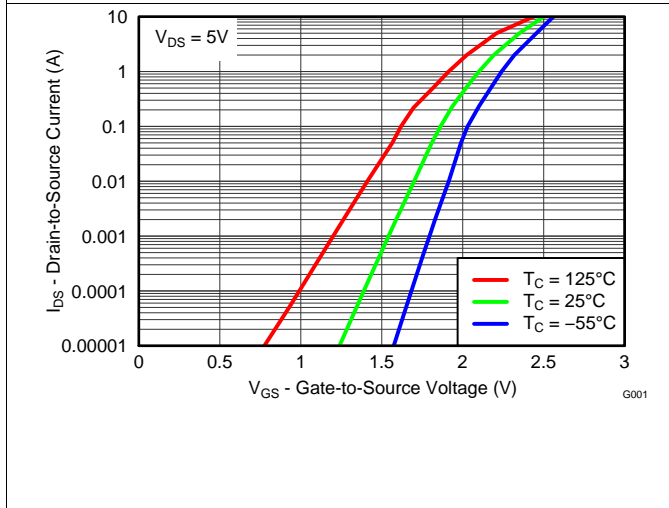
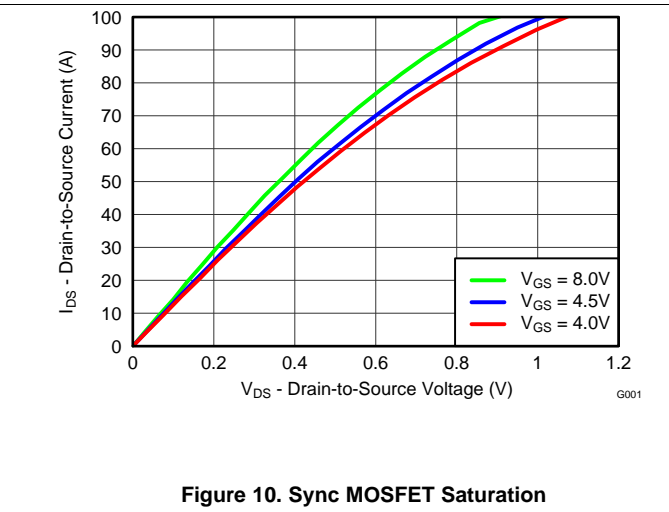
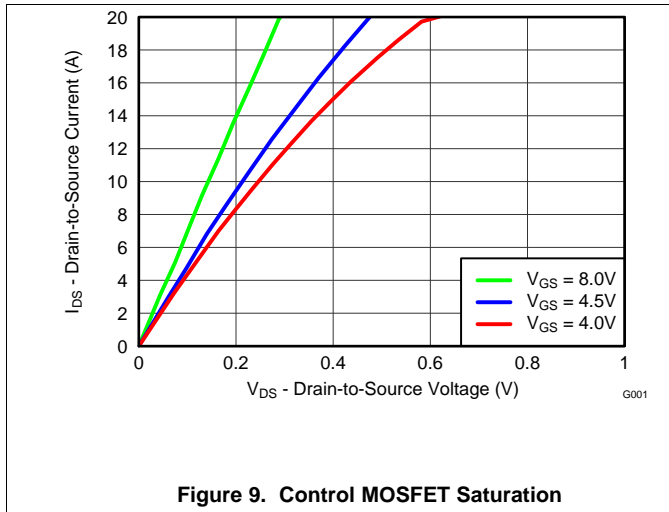

Figure 8. Normalized Power Loss vs Output Inductance

5.7 Typical Power Block MOSFET Characteristics

T_A = 25°C, unless stated otherwise.



Typical Power Block MOSFET Characteristics (continued)

$T_A = 25^\circ\text{C}$, unless stated otherwise.

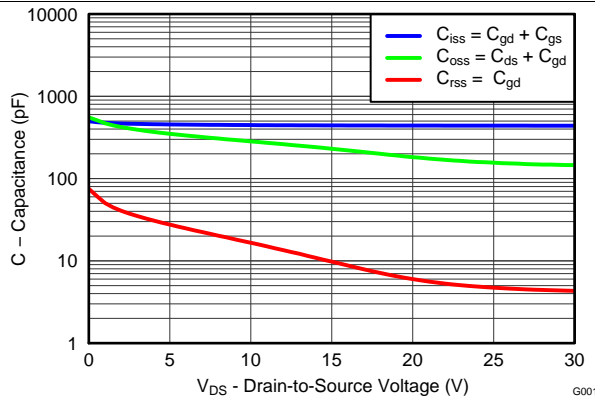

Figure 15. Control MOSFET Capacitance

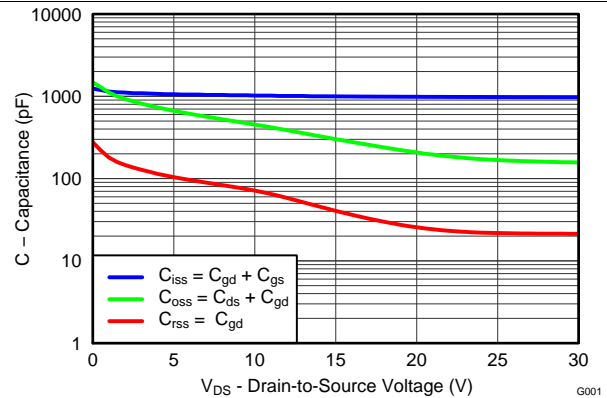

Figure 16. Sync MOSFET Capacitance

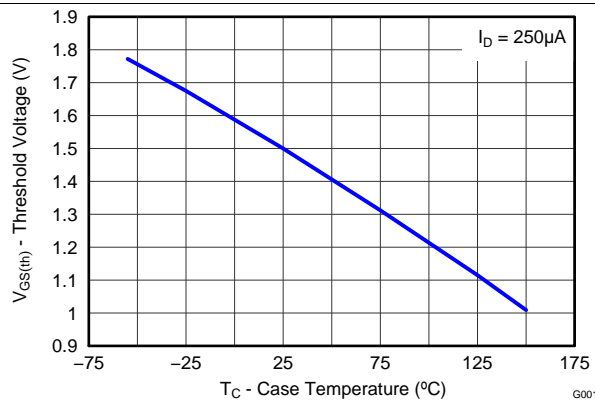

Figure 17. Control MOSFET $V_{GS(th)}$

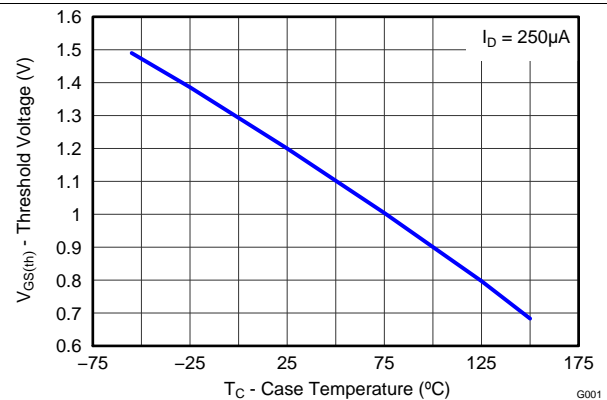

Figure 18. Sync MOSFET $V_{GS(th)}$

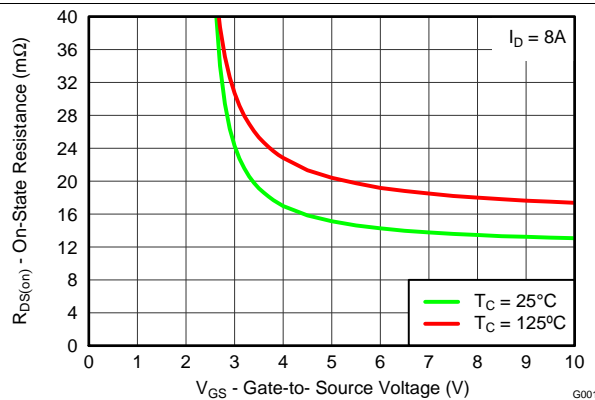

Figure 19. Control MOSFET $R_{DS(on)}$ vs V_{GS}

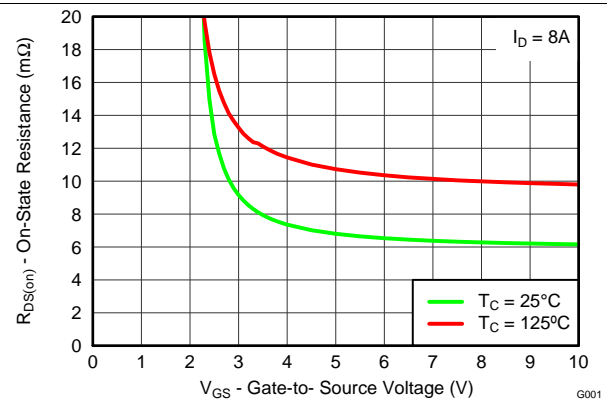

Figure 20. Sync MOSFET $R_{DS(on)}$ vs V_{GS}

Typical Power Block MOSFET Characteristics (continued)

T_A = 25°C, unless stated otherwise.

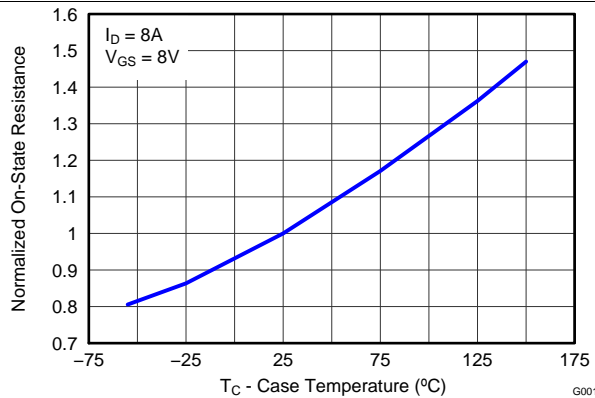

Figure 21. Control MOSFET Normalized R_{DS(on)}

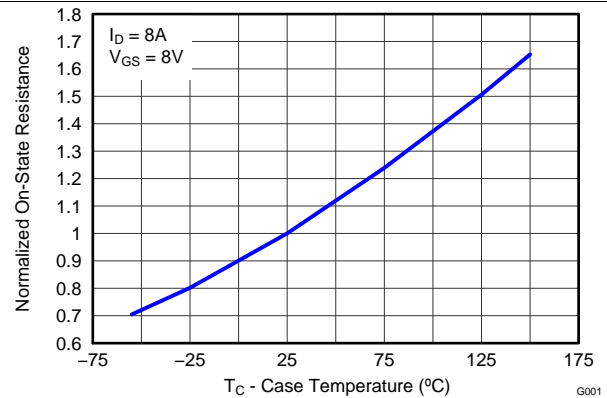

Figure 22. Sync MOSFET Normalized R_{DS(on)}

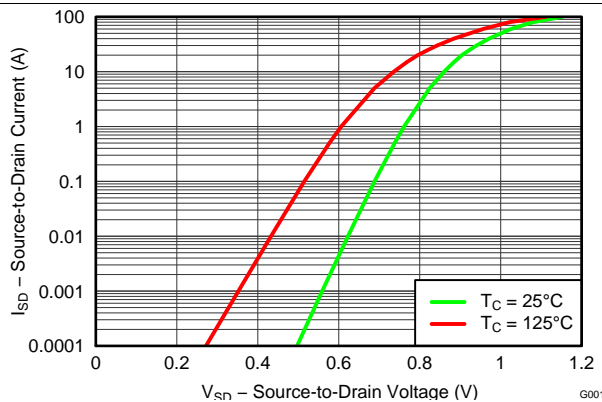

Figure 23. Control MOSFET Body Diode

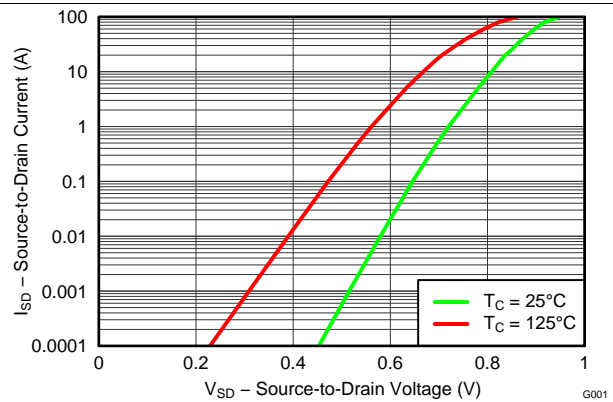

Figure 24. Sync MOSFET Body Diode

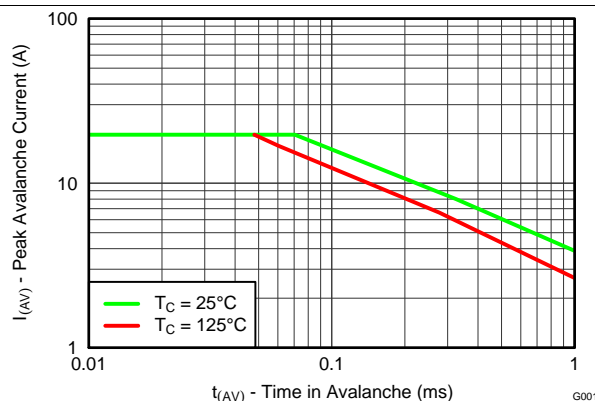

Figure 25. Control MOSFET Unclamped Inductive Switching

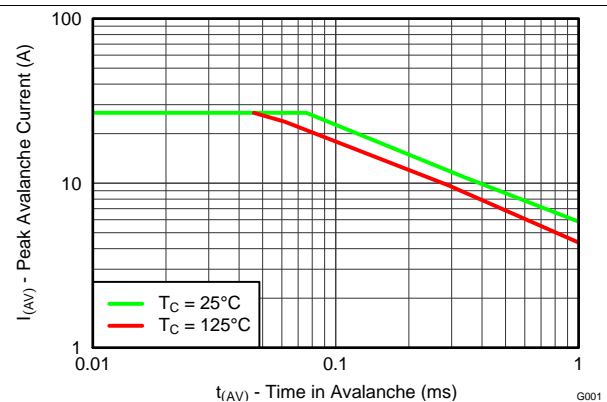

Figure 26. Sync MOSFET Unclamped Inductive Switching

6 Application and Implementation

NOTE

Information in the following applications sections is not part of the TI component specification, and TI does not warrant its accuracy or completeness. TI's customers are responsible for determining suitability of components for their purposes. Customers should validate and test their design implementation to confirm system functionality.

6.1 Application Information

The CSD87381P NexFET power block is an optimized design for synchronous buck applications using 5 V gate drive. The control FET and sync FET silicon are parametrically tuned to yield the lowest power loss and highest system efficiency. As a result, a new rating method is needed, which is tailored towards a more systems-centric environment. System-level performance curves such as Power Loss, Safe Operating Area, and normalized graphs allow engineers to predict the product performance in the actual application.

6.1.1 Power Loss Curves

MOSFET-centric parameters such as $R_{DS(ON)}$ and Q_{gd} are needed to estimate the loss generated by the devices. In an effort to simplify the design process for engineers, TI has provided measured power loss performance curves. [Figure 1](#) plots the power loss of the CSD87381P as a function of load current. This curve is measured by configuring and running the CSD87381P as it would be in the final application (see [Figure 27](#)). The measured power loss is the CSD87381P loss and consists of both input conversion loss and gate drive loss. [Equation 1](#) is used to generate the power loss curve.

$$(V_{IN} \times I_{IN}) + (V_{DD} \times I_{DD}) - (V_{SW_AVG} \times I_{OUT}) = \text{Power Loss} \quad (1)$$

The power loss curve in [Figure 1](#) is measured at the maximum recommended junction temperatures of 125°C under isothermal test conditions.

6.1.2 Safe Operating Curves (SOA)

The SOA curves in the CSD87381P data sheet provides guidance on the temperature boundaries within an operating system by incorporating the thermal resistance and system power loss. [Figure 3](#) to [Figure 4](#) outline the temperature and airflow conditions required for a given load current. The area under the curve dictates the safe operating area. All the curves are based on measurements made on a PCB design with dimensions of 4 inches (W) × 3.5 inches (L) × 0.062 inch (T) and 6 copper layers of 1 oz. copper thickness.

6.1.3 Normalized Curves

The normalized curves in the CSD87381P data sheet provide guidance on the power loss and SOA adjustments based on their application-specific needs. These curves show how the power loss and SOA boundaries adjust for a given set of systems conditions. The primary y-axis is the normalized change in power loss, and the secondary y-axis is the change in system temperature required in order to comply with the SOA curve. The change in power loss is a multiplier for the power loss curve, and the change in temperature is subtracted from the SOA curve.

Application Information (continued)

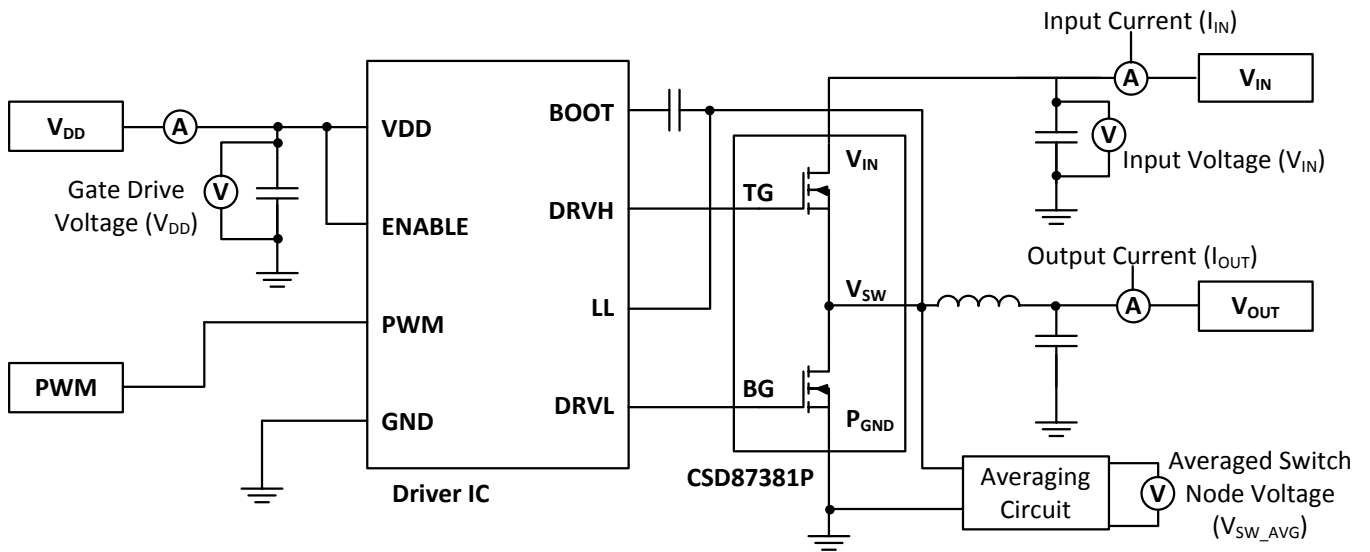

Figure 27. Typical Application

Application Information (continued)

6.1.4 Calculating Power Loss and SOA

The user can estimate product loss and SOA boundaries by arithmetic means (see [Design Example](#)). Though the power loss and SOA curves in this data sheet are taken for a specific set of test conditions, the following procedure outlines the steps the user should take to predict product performance for any set of system conditions.

6.1.4.1 Design Example

Operating Conditions:

- Output Current = 8 A
- Input Voltage = 4 V
- Output Voltage = 1 V
- Switching Frequency = 800 kHz
- Inductor = 0.2 μ H

6.1.4.2 Calculating Power Loss

- Power Loss at 8 A = 1.44 W ([Figure 1](#))
- Normalized Power Loss for input voltage \approx 1.06 ([Figure 6](#))
- Normalized Power Loss for output voltage \approx 0.97 ([Figure 7](#))
- Normalized Power Loss for switching frequency \approx 1.11 ([Figure 5](#))
- Normalized Power Loss for output inductor \approx 1.13 ([Figure 8](#))
- **Final calculated power loss = 1.44 W \times 1.06 \times 0.97 \times 1.11 \times 1.13 \approx 1.86 W**

6.1.4.3 Calculating SOA Adjustments

- SOA adjustment for input voltage \approx 0.7°C ([Figure 6](#))
- SOA adjustment for output voltage \approx -0.3°C ([Figure 7](#))
- SOA adjustment for switching frequency \approx 1.03°C ([Figure 5](#))
- SOA adjustment for output inductor \approx 1.5°C ([Figure 8](#))
- **Final calculated SOA adjustment = 0.7 + (-0.3) + 1.3 + 1.5 \approx 2.2°C**

In the previous design example, the estimated power loss of the CSD87381P would increase to 1.86 W. In addition, the maximum allowable board or ambient temperature, or both, would have to decrease by 2.2°C. [Figure 28](#) graphically shows how the SOA curve would be adjusted accordingly.

1. Start by drawing a horizontal line from the application current to the SOA curve.
2. Draw a vertical line from the SOA curve intercept down to the board or ambient temperature.
3. Adjust the SOA board or ambient temperature by subtracting the temperature adjustment value.

Application Information (continued)

In the design example, the SOA temperature adjustment yields a reduction in allowable board or ambient temperature of 2.2°C. In the event the adjustment value is a negative number, subtracting the negative number would yield an increase in allowable board or ambient temperature.

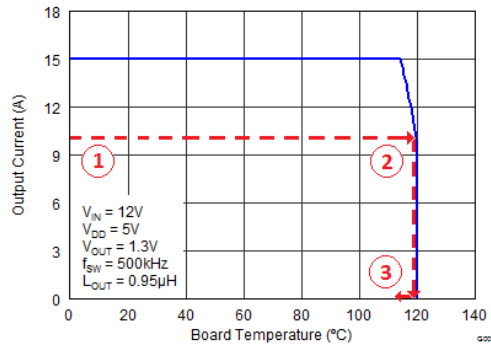

Figure 28. Power Block SOA

7 Layout

7.1 Layout Guidelines

7.1.1 Recommended PCB Design Overview

There are two key system-level parameters that can be addressed with a proper PCB design: electrical and thermal performance. Properly optimizing the PCB layout yields maximum performance in both areas. The following provides a brief description on how to address each parameter.

7.1.2 Electrical Performance

The CSD87381P has the ability to switch voltages at rates greater than 10 kV/μs. Take care with the PCB layout design and placement of the input capacitors, inductor, and output capacitors.

- The placement of the input capacitors relative to VIN and PGND pins of CSD87381P device should have the highest priority during the component placement routine. It is critical to minimize these node lengths. As such, ceramic input capacitors need to be placed as close as possible to the VIN and PGND pins (see Figure 29). The example in Figure 29 uses 1 x 10 nF 0402 25 V and 4 x 10 μF 1206 25 V ceramic capacitors (TDK part number C3216X5R1C106KT or equivalent). Notice there are ceramic capacitors on both sides of the board with an appropriate amount of vias interconnecting both layers. In terms of priority of placement next to the power stage, C21, C5, C8, C19, and C18 should follow in order.
- The switching node of the output inductor should be placed relatively close to the Power Block II CSD87381P VSW pins. Minimizing the VSW node length between these two components will reduce the PCB conduction losses and actually reduce the switching noise level. See Figure 29. ⁽¹⁾

7.1.3 Thermal Performance

The CSD87381P has the ability to utilize the PGND planes as the primary thermal path. As such, the use of thermal vias is an effective way to pull away heat from the device and into the system board. Concerns of solder voids and manufacturability problems can be addressed by the use of three basic tactics to minimize the amount of solder attach that wicks down the via barrel:

- Intentionally space out the vias from each other to avoid a cluster of holes in a given area.
- Use the smallest drill size allowed in your design. The example in Figure 29 uses vias with a 10 mil drill hole and a 16 mil capture pad.
- Tent the opposite side of the via with solder-mask.

The number and drill size of the thermal vias should align with the end user's PCB design rules and manufacturing capabilities.

7.2 Layout Example

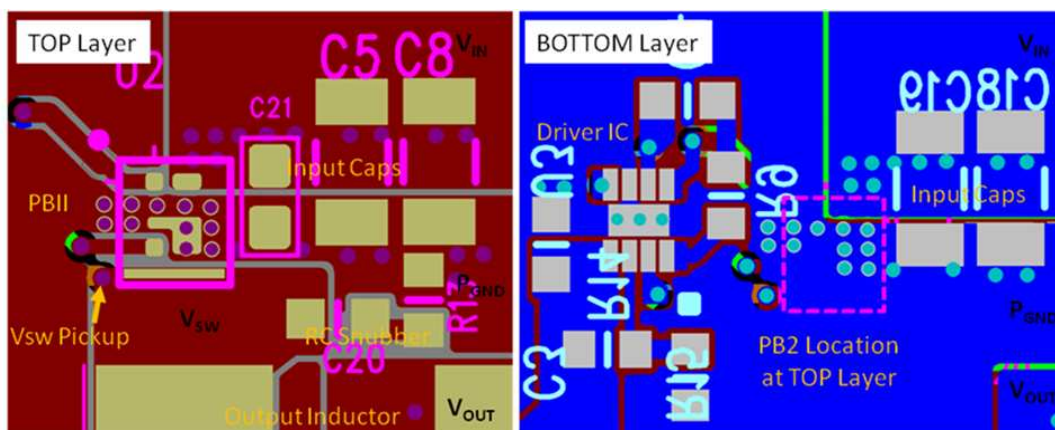

Figure 29. Recommended PCB Layout (Top Down View)

(1) Keong W. Kam, David Pommerenke, "EMI Analysis Methods for Synchronous Buck Converter EMI Root Cause Analysis", University of Missouri – Rolla

8 器件和文档支持

8.1 商标

NexFET is a trademark of Texas Instruments.
All other trademarks are the property of their respective owners.

8.2 静电放电警告



这些装置包含有限的内置 ESD 保护。存储或装卸时，应将导线一起截短或将装置放置于导电泡棉中，以防止 MOS 门极遭受静电损伤。

8.3 术语表

[SLYZ022](#) — *TI* 术语表。

这份术语表列出并解释术语、首字母缩略词和定义。

9 机械、封装和可订购信息

以下页中包括机械、封装和可订购信息。 这些信息是针对指定器件可提供的最新数据。 这些数据会在无通知且不对本文档进行修订的情况下发生改变。 欲获得该数据表的浏览器版本，请查阅左侧的导航栏。

9.1 CSD87381P 封装尺寸

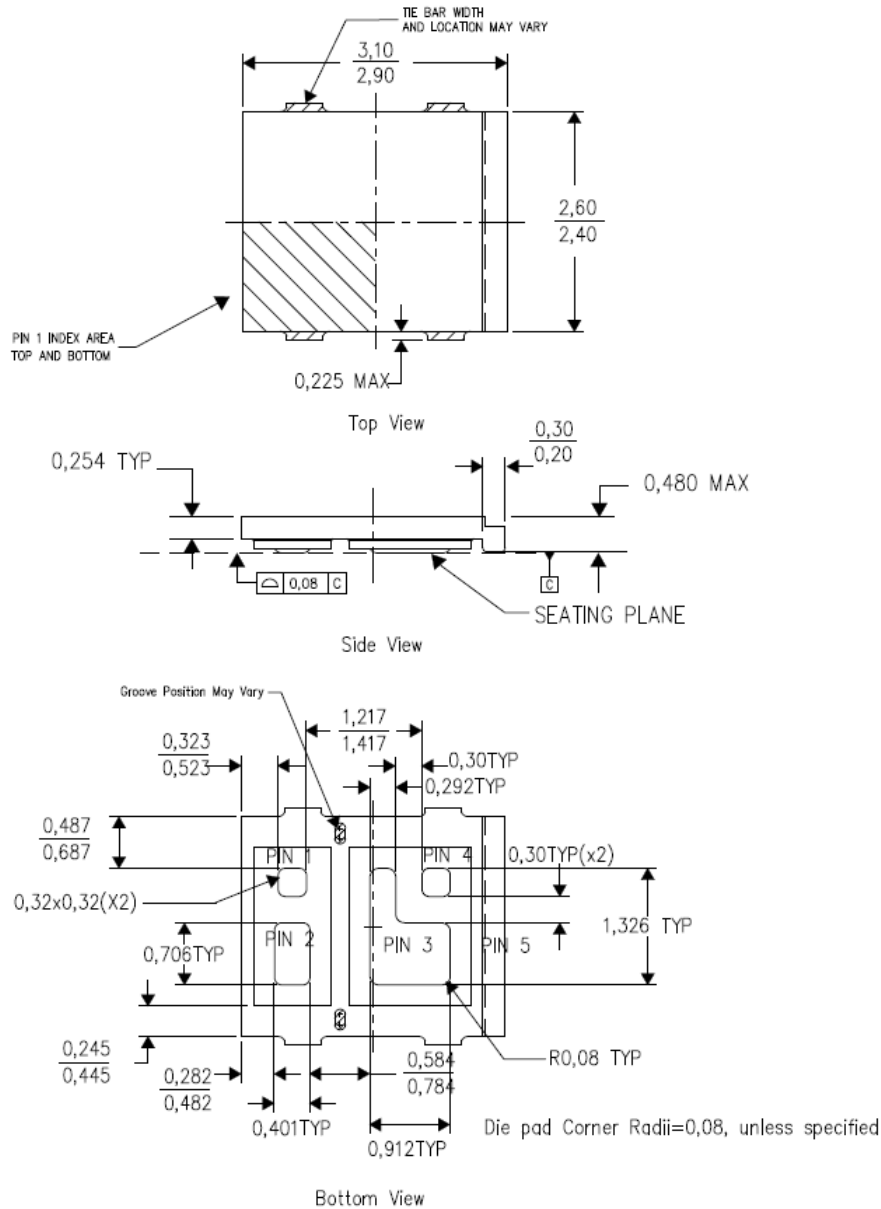

引脚配置

位置	名称
引脚 1	TG
引脚 2	V _{IN}
引脚 3	P _{GND}
引脚 4	BG
引脚 5	V _{SW}

9.2 焊盘布局建议

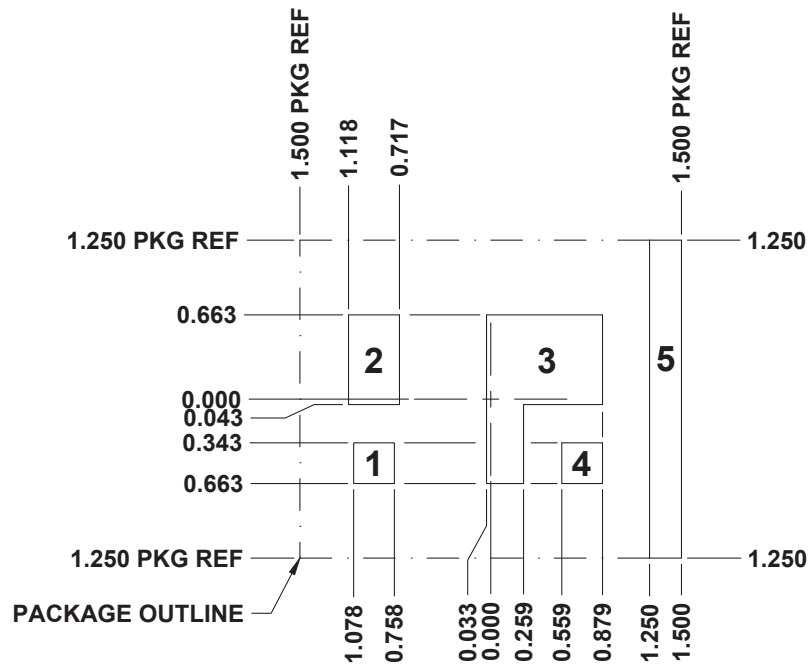

9.3 模板建议 (100µm)

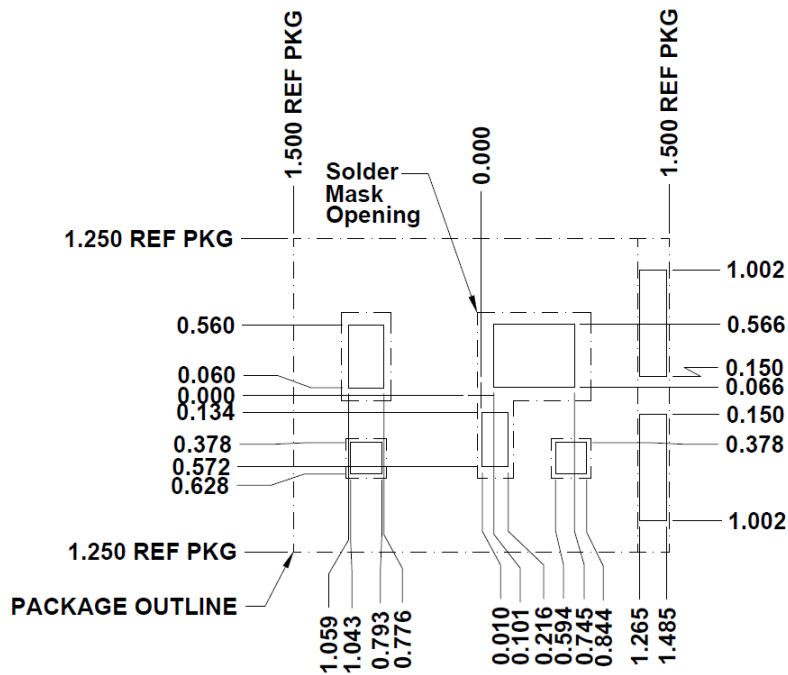

9.4 模板建议 (125µm)

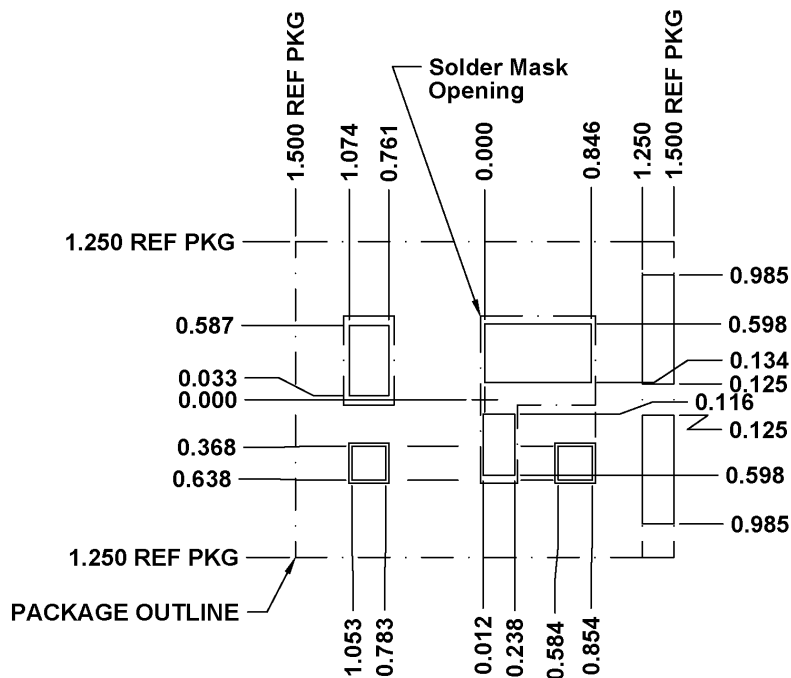

要获得与印刷电路板 (PCB) 设计相关的建议电路布局布线, 请参见《应用说明》[SLPA005](#) - 通过 PCB 布局布线技巧来减少振铃。

9.5 引脚图

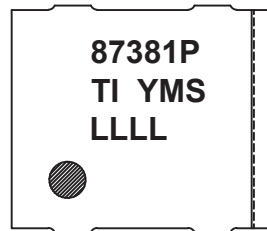

9.6 CSD87381P 压纹载带尺寸

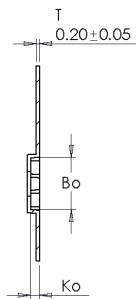

SECTION Y-Y
SCALE 3.5 : 1

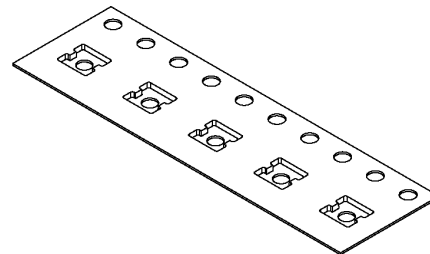
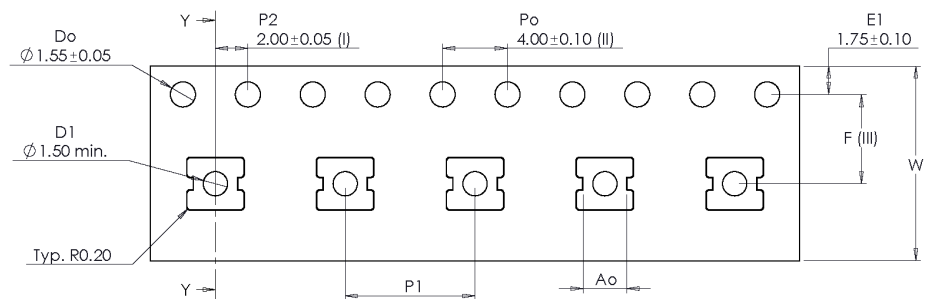

Ao	2.70	+/- 0.05
Bo	3.20	+/- 0.05
Ko	0.55	+/- 0.05
F	5.50	+/- 0.05
P1	8.00	+/- 0.10
W	12.00	+/- 0.30

Forming format : Press Form - 17
Estimated max. length : 278 meter/22B3 reel

- (I) Measured from centreline of sprocket hole to centreline of pocket.
- (II) Cumulative tolerance of 10 sprocket holes is ± 0.20 .
- (III) Measured from centreline of sprocket hole to centreline of pocket.
- (IV) Other material available.

ALL DIMENSIONS IN MILLIMETRES UNLESS OTHERWISE STATED.

(1) 引脚 1 位于载带封装左上象限内（最靠近载带齿孔的位置）。

PACKAGING INFORMATION

Orderable Device	Status (1)	Package Type	Package Drawing	Pins	Package Qty	Eco Plan (2)	Lead finish/ Ball material (6)	MSL Peak Temp (3)	Op Temp (°C)	Device Marking (4/5)	Samples
CSD87381P	ACTIVE	PTAB	MPC	5	2500	RoHS & Green	NIPDAU	Level-1-260C-UNLIM	-55 to 150	87381P	Samples
CSD87381PT	ACTIVE	PTAB	MPC	5	250	RoHS & Green	NIPDAU	Level-1-260C-UNLIM	-55 to 150	87381P	Samples

(1) The marketing status values are defined as follows:

ACTIVE: Product device recommended for new designs.

LIFEBUY: TI has announced that the device will be discontinued, and a lifetime-buy period is in effect.

NRND: Not recommended for new designs. Device is in production to support existing customers, but TI does not recommend using this part in a new design.

PREVIEW: Device has been announced but is not in production. Samples may or may not be available.

OBSOLETE: TI has discontinued the production of the device.

(2) **RoHS:** TI defines "RoHS" to mean semiconductor products that are compliant with the current EU RoHS requirements for all 10 RoHS substances, including the requirement that RoHS substance do not exceed 0.1% by weight in homogeneous materials. Where designed to be soldered at high temperatures, "RoHS" products are suitable for use in specified lead-free processes. TI may reference these types of products as "Pb-Free".

RoHS Exempt: TI defines "RoHS Exempt" to mean products that contain lead but are compliant with EU RoHS pursuant to a specific EU RoHS exemption.

Green: TI defines "Green" to mean the content of Chlorine (Cl) and Bromine (Br) based flame retardants meet JS709B low halogen requirements of <=1000ppm threshold. Antimony trioxide based flame retardants must also meet the <=1000ppm threshold requirement.

(3) MSL, Peak Temp. - The Moisture Sensitivity Level rating according to the JEDEC industry standard classifications, and peak solder temperature.

(4) There may be additional marking, which relates to the logo, the lot trace code information, or the environmental category on the device.

(5) Multiple Device Markings will be inside parentheses. Only one Device Marking contained in parentheses and separated by a "~" will appear on a device. If a line is indented then it is a continuation of the previous line and the two combined represent the entire Device Marking for that device.

(6) Lead finish/Ball material - Orderable Devices may have multiple material finish options. Finish options are separated by a vertical ruled line. Lead finish/Ball material values may wrap to two lines if the finish value exceeds the maximum column width.

Important Information and Disclaimer:The information provided on this page represents TI's knowledge and belief as of the date that it is provided. TI bases its knowledge and belief on information provided by third parties, and makes no representation or warranty as to the accuracy of such information. Efforts are underway to better integrate information from third parties. TI has taken and continues to take reasonable steps to provide representative and accurate information but may not have conducted destructive testing or chemical analysis on incoming materials and chemicals. TI and TI suppliers consider certain information to be proprietary, and thus CAS numbers and other limited information may not be available for release.

In no event shall TI's liability arising out of such information exceed the total purchase price of the TI part(s) at issue in this document sold by TI to Customer on an annual basis.

TAPE AND REEL INFORMATION

QUADRANT ASSIGNMENTS FOR PIN 1 ORIENTATION IN TAPE



*All dimensions are nominal

Device	Package Type	Package Drawing	Pins	SPQ	Reel Diameter (mm)	Reel Width W1 (mm)	A0 (mm)	B0 (mm)	K0 (mm)	P1 (mm)	W (mm)	Pin1 Quadrant
CSD87381P	PTAB	MPC	5	2500	330.0	12.4	2.7	3.2	0.55	8.0	12.0	Q1
CSD87381PT	PTAB	MPC	5	250	180.0	12.4	2.7	3.2	0.55	8.0	12.0	Q1

TAPE AND REEL BOX DIMENSIONS

*All dimensions are nominal

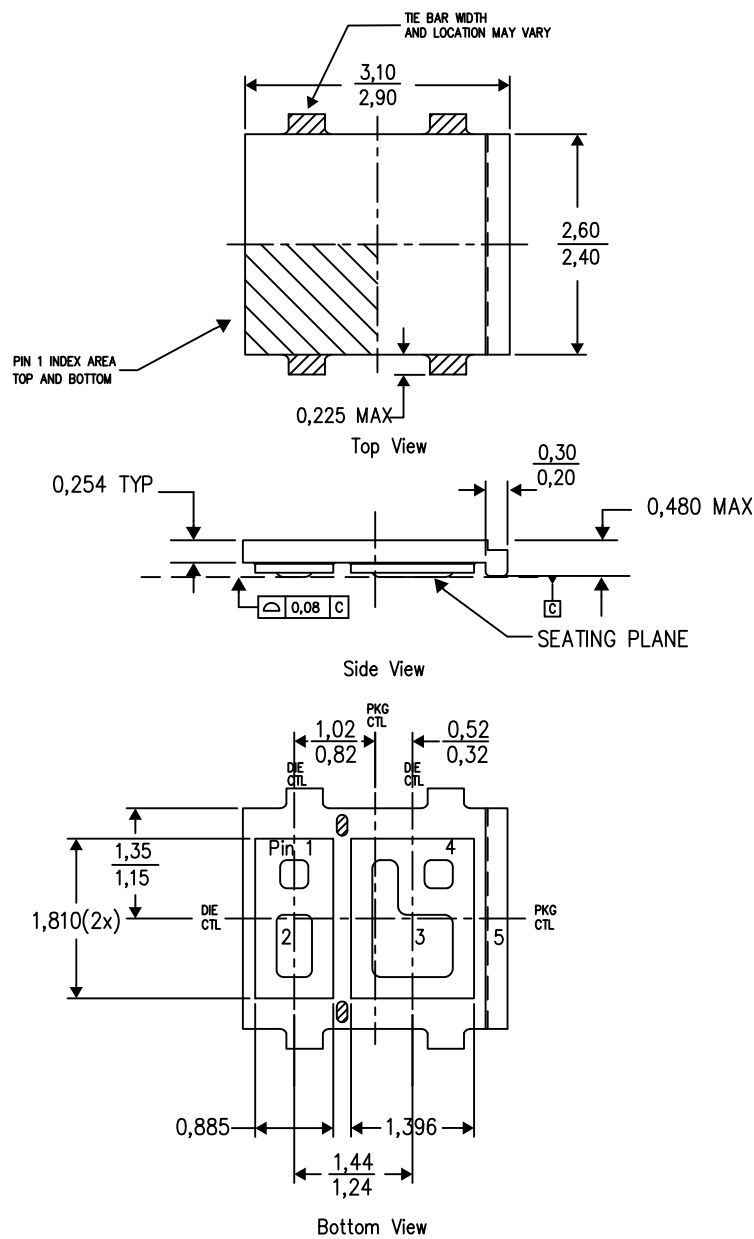
Device	Package Type	Package Drawing	Pins	SPQ	Length (mm)	Width (mm)	Height (mm)
CSD87381P	PTAB	MPC	5	2500	346.0	346.0	33.0
CSD87381PT	PTAB	MPC	5	250	182.0	182.0	20.0



4214705/E 07/13

- NOTES: A. All linear dimensions are in millimeters.
 B. This drawing is subject to change without notice.

重要声明和免责声明

TI“按原样”提供技术和可靠性数据（包括数据表）、设计资源（包括参考设计）、应用或其他设计建议、网络工具、安全信息和其他资源，不保证没有瑕疵且不做任何明示或暗示的担保，包括但不限于对适销性、某特定用途方面的适用性或不侵犯任何第三方知识产权的暗示担保。

这些资源可供使用 TI 产品进行设计的熟练开发人员使用。您将自行承担以下全部责任：(1) 针对您的应用选择合适的 TI 产品，(2) 设计、验证并测试您的应用，(3) 确保您的应用满足相应标准以及任何其他功能安全、信息安全、监管或其他要求。

这些资源如有变更，恕不另行通知。TI 授权您仅可将这些资源用于研发本资源所述的 TI 产品的应用。严禁对这些资源进行其他复制或展示。您无权使用任何其他 TI 知识产权或任何第三方知识产权。您应全额赔偿因在这些资源的使用中对 TI 及其代表造成的任何索赔、损害、成本、损失和债务，TI 对此概不负责。

TI 提供的产品受 [TI 的销售条款](#) 或 [ti.com](#) 上其他适用条款/TI 产品随附的其他适用条款的约束。TI 提供这些资源并不会扩展或以其他方式更改 TI 针对 TI 产品发布的适用的担保或担保免责声明。

TI 反对并拒绝您可能提出的任何其他或不同的条款。

邮寄地址：Texas Instruments, Post Office Box 655303, Dallas, Texas 75265

Copyright © 2023，德州仪器 (TI) 公司