

# CSD87501L 30V 双路共漏极 N 沟道 NexFET™ 功率金属氧化物半导体场效应晶体管 (MOSFET)

## 1 特性

- 低导通电阻
- 3.37mm × 1.47mm 的小尺寸
- 超薄 – 高 0.2mm
- 无铅
- 符合 RoHS
- 无卤素
- 栅极 ESD 保护

## 2 应用

- 电池管理
- 电池保护
- USB Type-C/PD

## 3 说明

此 30V、6.6mΩ、3.37mm × 1.47mm LGA 双路 NexFET™ 功率 MOSFET 旨在以小外形封装最大程度地降低电阻和栅极电荷。该器件具有小尺寸和共漏极配置，非常适用于多节电池组应用和小型手持设备。

俯视图

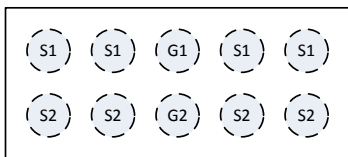

配置

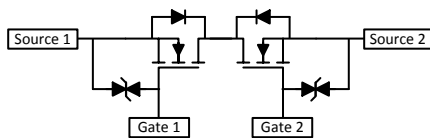

$R_{S1S2(on)}$  与  $V_{GS}$  间的关系

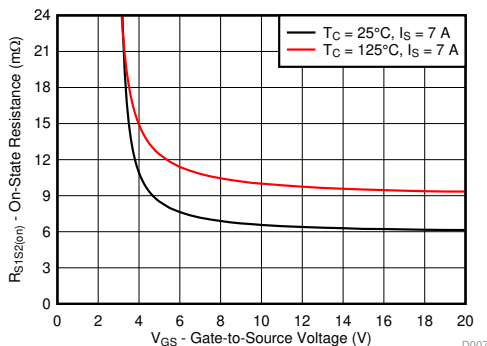

栅极电荷

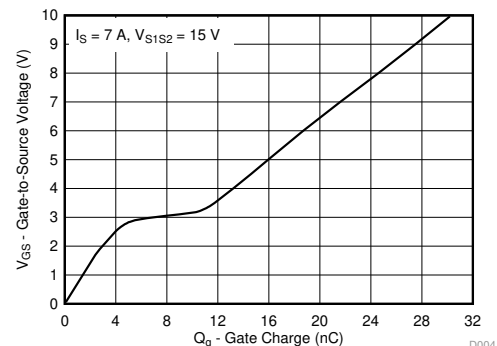

产品概要

$T_A = 25^\circ\text{C}$		典型值		单位
$V_{S1S2}$	源源电压	30		V
$Q_g$	总栅极电荷 (4.5V)	15		nC
$Q_{gd}$	栅极电荷 (栅极到漏极)	6.0		nC
$R_{S1S2(on)}$	源源导通电阻	$V_{GS} = 4.5\text{V}$	9.3	mΩ
		$V_{GS} = 10\text{V}$	6.6	
$V_{GS(th)}$	阈值电压	1.8		V

器件信息(1)

器件	介质	数量	封装	配送
CSD87501L	7 英寸卷带	3000	3.37mm × 1.47mm 基板栅格阵列 封装	卷带 封装
CSD87501LT	7 英寸卷带	250		

(1) 如需了解所有可用封装，请参阅数据表末尾的可订购产品附录。

绝对最大额定值

$T_A = 25^\circ\text{C}$		值	单位
$V_{S1S2}$	源源电压	30	V
$V_{GS}$	栅源电压	±20	V
$I_S$	持续源极电流 <sup>(1)</sup>	14	A
$I_{SM}$	脉冲源极电流 <sup>(2)</sup>	72	A
$P_D$	功率耗散	2.5	W
$V_{(ESD)}$	人体放电模型 (HBM)	2	kV
$T_J$ 、 $T_{stg}$	工作结温、 贮存温度	-55 至 150	°C

(1)  $R_{\theta JA} = 50^\circ\text{C/W}$ ，这是在 0.06 英寸厚 FR4 PCB 上的 1 平方英寸、2oz 铜焊盘上测得的典型值。

(2)  $R_{\theta JA} = 135^\circ\text{C/W}$  (覆铜面积最小时的典型值)，脉冲持续时间  $\leq 100\mu\text{s}$ ，占空比  $\leq 1\%$ 。



## 目录

<b>1</b>	特性 .....	<b>1</b>	<b>6.1</b>	接收文档更新通知 .....	<b>7</b>
<b>2</b>	应用 .....	<b>1</b>	<b>6.2</b>	社区资源 .....	<b>7</b>
<b>3</b>	说明 .....	<b>1</b>	<b>6.3</b>	商标 .....	<b>7</b>
<b>4</b>	修订历史记录 .....	<b>2</b>	<b>6.4</b>	静电放电警告 .....	<b>7</b>
<b>5</b>	<b>Specifications</b> .....	<b>3</b>	<b>6.5</b>	Glossary .....	<b>7</b>
	5.1 Electrical Characteristics .....	<b>3</b>	<b>7</b>	<b>机械、封装和可订购信息</b> .....	<b>8</b>
	5.2 Thermal Information .....	<b>3</b>	<b>7.1</b>	封装尺寸 .....	<b>8</b>
	5.3 Typical MOSFET Characteristics .....	<b>4</b>	<b>7.2</b>	推荐的 PCB 布局 .....	<b>9</b>
<b>6</b>	器件和文档支持 .....	<b>7</b>	<b>7.3</b>	推荐的模板布局 .....	<b>9</b>

## 4 修订历史记录

<b>Changes from Revision A (April 2015) to Revision B</b>		<b>Page</b>
• 已添加 添加了接收文档更新通知 部分和社区资源 部分 .....		<b>7</b>
• 已添加 在机械、封装和可订购信息 部分添加了“引脚配置”表 .....		<b>8</b>

<b>Changes from Original (February 2015) to Revision A</b>		<b>Page</b>
• Extended Y axis in <a href="#">Figure 9</a> down to 0.01 A .....		<b>4</b>

## 5 Specifications

### 5.1 Electrical Characteristics

 $T_A = 25^\circ\text{C}$  unless otherwise stated

PARAMETER		TEST CONDITIONS	MIN	TYP	MAX	UNIT
<b>STATIC CHARACTERISTICS</b>						
$V_{S1S2}$	Source-to-source voltage	$V_{GS} = 0\text{ V}, I_S = 250\ \mu\text{A}$	30			V
$I_{S1S2}$	Source-to-source leakage current	$V_{GS} = 0\text{ V}, V_{S1S2} = 24\text{ V}$			1	$\mu\text{A}$
$I_{GSS}$	Gate-to-source leakage current	$V_{S1S2} = 0\text{ V}, V_{GS} = 20\text{ V}$			10	$\mu\text{A}$
$V_{GS(th)}$	Gate-to-source threshold voltage	$V_{S1S2} = V_{GS}, I_S = 250\ \mu\text{A}$	1.3	1.8	2.3	V
$R_{S1S2(on)}$	Source-to-source on-resistance	$V_{GS} = 4.5\text{ V}, I_S = 7\text{ A}$		9.3	11.0	m $\Omega$
		$V_{GS} = 10\text{ V}, I_S = 7\text{ A}$		6.6	7.8	
$g_{fs}$	Transconductance	$V_{S1S2} = 3\text{ V}, I_S = 7\text{ A}$		48		S
<b>DYNAMIC CHARACTERISTICS<sup>(1)</sup></b>						
$C_{iss}$	Input capacitance	$V_{GS} = 0\text{ V}, V_{S1S2} = 15\text{ V}, f = 1\text{ MHz}$		1620	2110	pF
$C_{oss}$	Output capacitance			189	246	pF
$C_{rss}$	Reverse transfer capacitance			152	198	pF
$R_G$	Series gate resistance			300	450	$\Omega$
$Q_g$	Gate charge total (4.5 V)	$V_{S1S2} = 15\text{ V}, I_S = 7\text{ A}$		15	20	nC
$Q_g$	Gate charge total (10 V)			31	40	nC
$Q_{gd}$	Gate charge gate-to-drain			6.0		nC
$Q_{gs}$	Gate charge gate-to-source			5.0		nC
$Q_{g(th)}$	Gate charge at $V_{th}$			2.5		nC
$Q_{oss}$	Output charge		$V_{S1S2} = 15\text{ V}, V_{GS} = 0\text{ V}$		7.6	
$t_{d(on)}$	Turn on delay time	$V_{S1S2} = 15\text{ V}, V_{GS} = 10\text{ V}, I_{S1S2} = 7\text{ A}, R_G = 0\ \Omega$		164		ns
$t_r$	Rise time			260		ns
$t_{d(off)}$	Turn off delay time			709		ns
$t_f$	Fall time			712		ns

(1) Dynamic characteristics values specified are per single FET.

### 5.2 Thermal Information

 $T_A = 25^\circ\text{C}$  unless otherwise stated

THERMAL METRIC		MIN	TYP	MAX	UNIT
$R_{\theta JA}$	Junction-to-ambient thermal resistance <sup>(1)</sup>		135		$^\circ\text{C/W}$
	Junction-to-ambient thermal resistance <sup>(2)</sup>		50		

(1) Device mounted on FR4 material with minimum Cu mounting area.

(2) Device mounted on FR4 material with 1-in<sup>2</sup> (6.45-cm<sup>2</sup>), 2-oz (0.071-mm thick) Cu.

### 5.3 Typical MOSFET Characteristics

$T_A = 25^\circ\text{C}$  unless otherwise stated

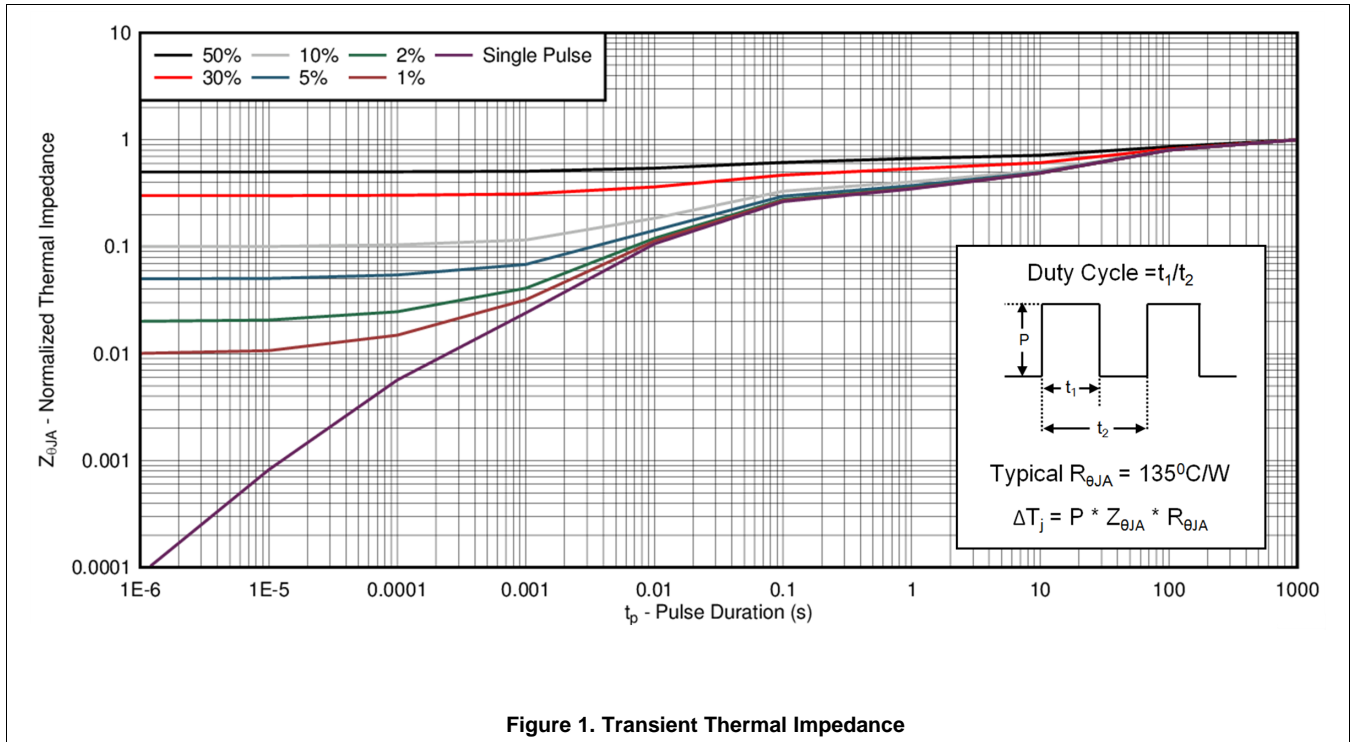

Figure 1. Transient Thermal Impedance

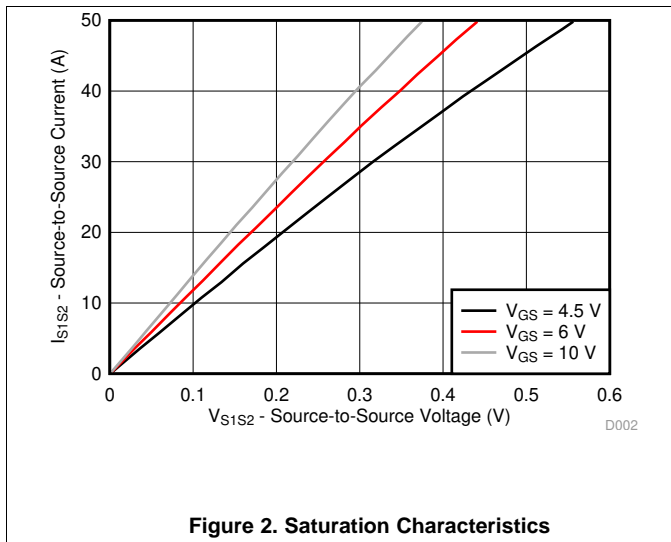

Figure 2. Saturation Characteristics

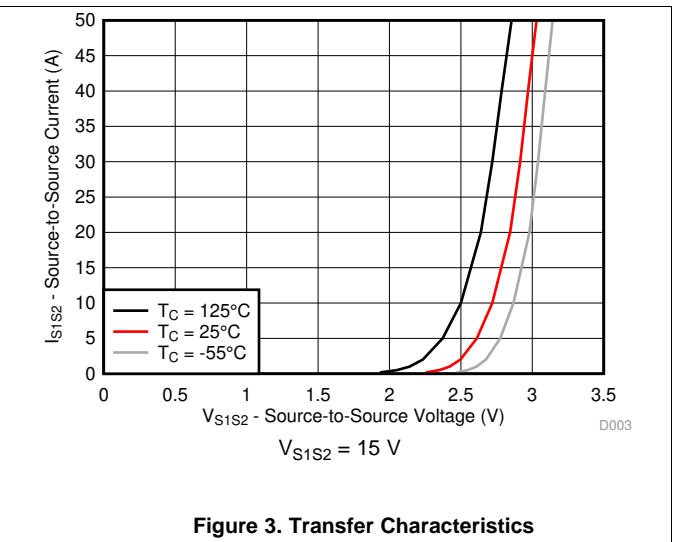

Figure 3. Transfer Characteristics

Typical MOSFET Characteristics (continued)

T<sub>A</sub> = 25°C unless otherwise stated

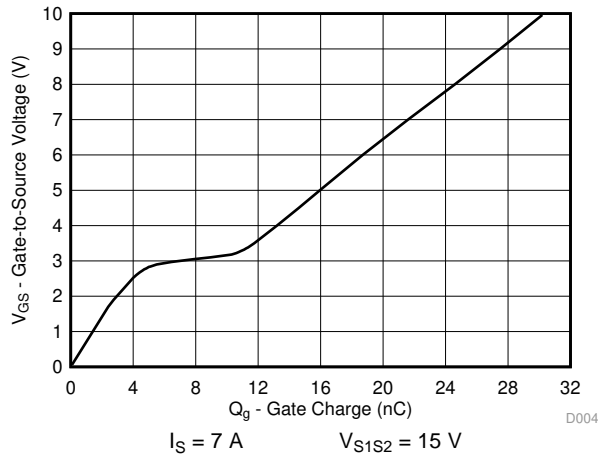

Figure 4. Gate Charge

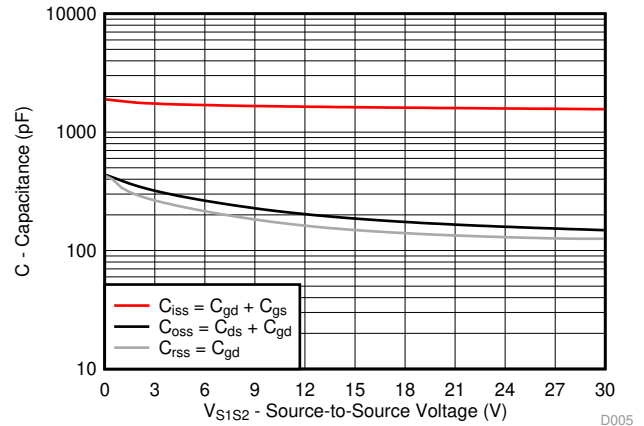

Figure 5. Capacitance

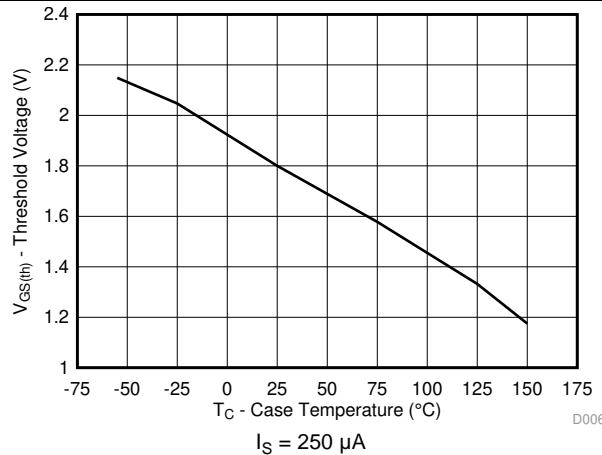

Figure 6. Threshold Voltage vs Temperature

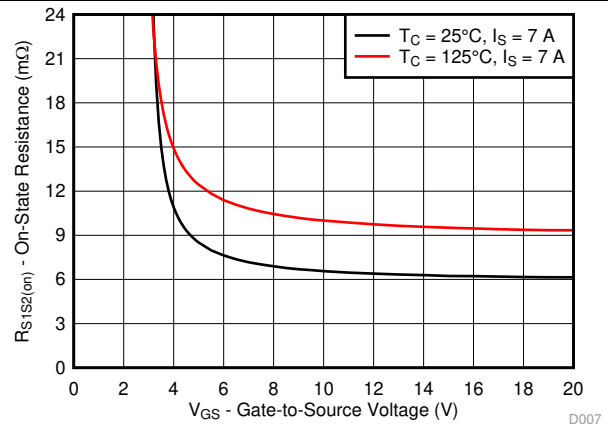

Figure 7. On-State Source-to-Source Resistance vs Gate-to-Source Voltage

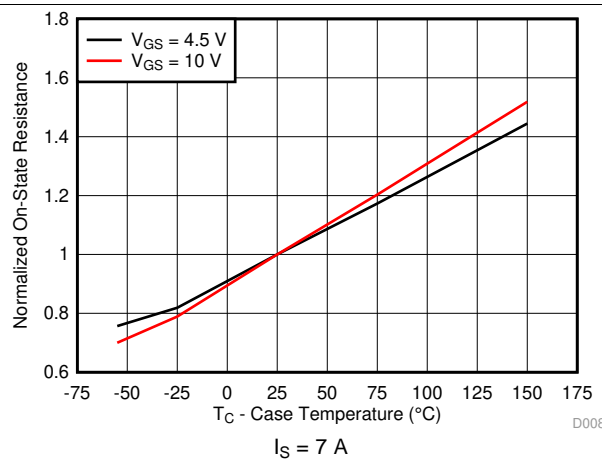

Figure 8. Normalized On-State Resistance vs Temperature

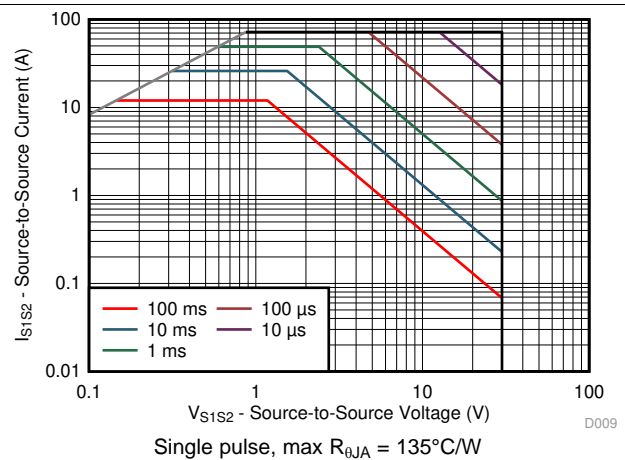
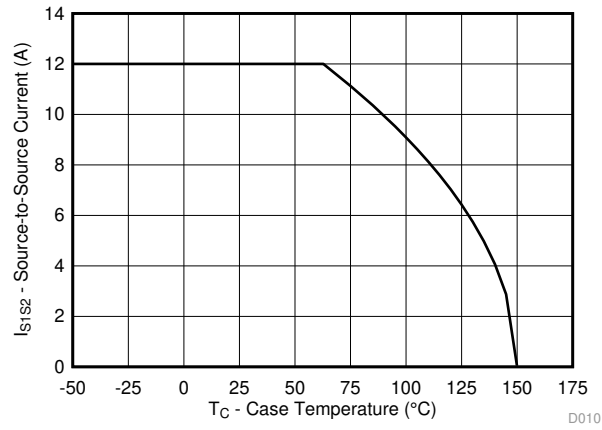

Figure 9. Maximum Safe Operating Area

**Typical MOSFET Characteristics (continued)**

$T_A = 25^\circ\text{C}$  unless otherwise stated



**Figure 10. Maximum Source Current vs Temperature**

## 6 器件和文档支持

### 6.1 接收文档更新通知

要接收文档更新通知，请导航至 [TI.com.cn](http://TI.com.cn) 上的器件产品文件夹。单击右上角的 [通知我](#) 进行注册，即可每周接收产品信息更改摘要。有关更改的详细信息，请查看任何已修订文档中包含的修订历史记录。

### 6.2 社区资源

The following links connect to TI community resources. Linked contents are provided "AS IS" by the respective contributors. They do not constitute TI specifications and do not necessarily reflect TI's views; see TI's [Terms of Use](#).

**TI E2E™ Online Community** *TI's Engineer-to-Engineer (E2E) Community*. Created to foster collaboration among engineers. At [e2e.ti.com](http://e2e.ti.com), you can ask questions, share knowledge, explore ideas and help solve problems with fellow engineers.

**Design Support** *TI's Design Support* Quickly find helpful E2E forums along with design support tools and contact information for technical support.

### 6.3 商标

NexFET, E2E are trademarks of Texas Instruments.  
All other trademarks are the property of their respective owners.

### 6.4 静电放电警告



这些装置包含有限的内置 ESD 保护。存储或装卸时，应将导线一起截短或将装置放置于导电泡棉中，以防止 MOS 门极遭受静电损伤。

### 6.5 Glossary

[SLYZ022](#) — *TI Glossary*.

This glossary lists and explains terms, acronyms, and definitions.

## 7 机械、封装和可订购信息

以下页面包含机械、封装和可订购信息。这些信息是指定器件的最新可用数据。数据如有变更，恕不另行通知，且不会对此文档进行修订。如欲获取此数据表的浏览器版本，请参阅左侧的导航。

### 7.1 封装尺寸

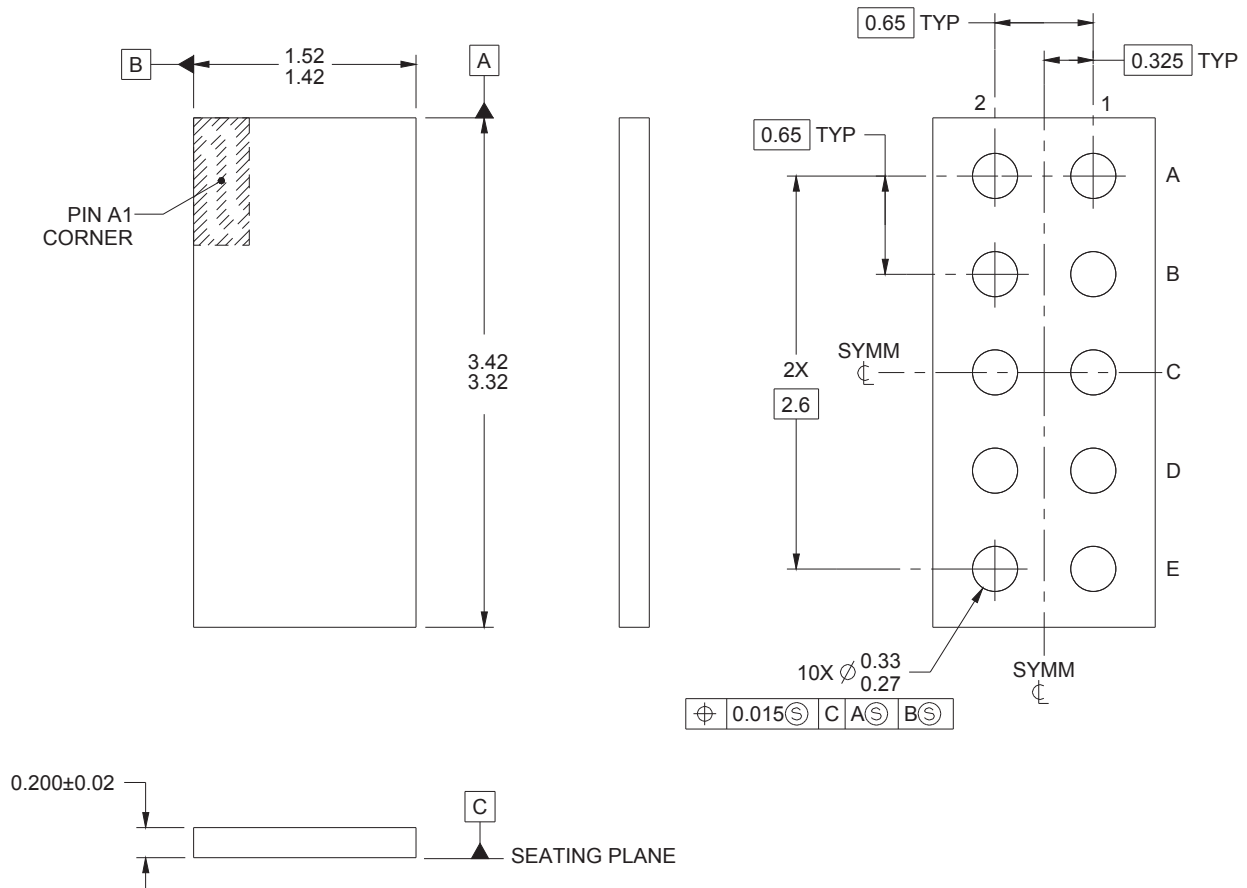

所有尺寸均以毫米为单位。

表 1. 引脚配置

位置	名称
A1、B1、D1、E1	源极 1
C1	栅极 1
A2、B2、D2、E2	源极 2
C2	栅极 2



## 7.2 推荐的 PCB 布局

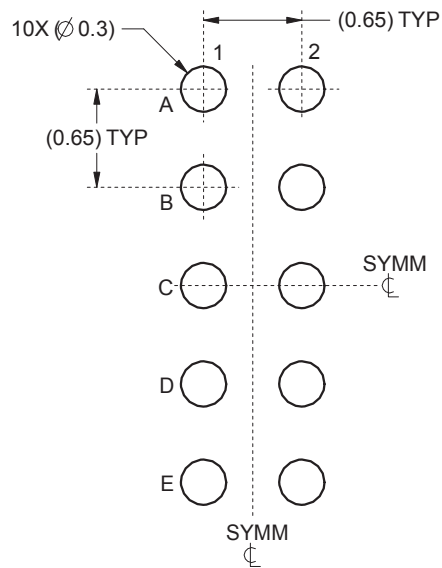

## 7.3 推荐的模板布局

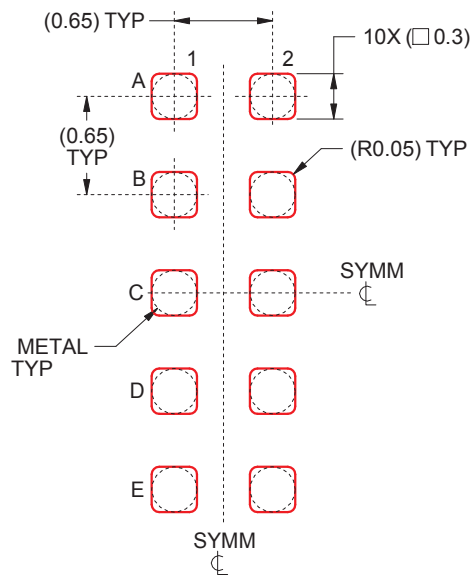

所有尺寸均以毫米为单位（除非另外注明）。

**PACKAGING INFORMATION**

Orderable Device	Status (1)	Package Type	Package Drawing	Pins	Package Qty	Eco Plan (2)	Lead finish/ Ball material (6)	MSL Peak Temp (3)	Op Temp (°C)	Device Marking (4/5)	Samples
CSD87501L	ACTIVE	PICOSTAR	YJG	10	3000	RoHS & Green	NIAU   SNAGCU	Level-1-260C-UNLIM		CSD87501	Samples
CSD87501LT	ACTIVE	PICOSTAR	YJG	10	250	RoHS & Green	NIAU   SNAGCU	Level-1-260C-UNLIM	-55 to 150	CSD87501	Samples

(1) The marketing status values are defined as follows:

**ACTIVE:** Product device recommended for new designs.

**LIFEBUY:** TI has announced that the device will be discontinued, and a lifetime-buy period is in effect.

**NRND:** Not recommended for new designs. Device is in production to support existing customers, but TI does not recommend using this part in a new design.

**PREVIEW:** Device has been announced but is not in production. Samples may or may not be available.

**OBSOLETE:** TI has discontinued the production of the device.

(2) **RoHS:** TI defines "RoHS" to mean semiconductor products that are compliant with the current EU RoHS requirements for all 10 RoHS substances, including the requirement that RoHS substance do not exceed 0.1% by weight in homogeneous materials. Where designed to be soldered at high temperatures, "RoHS" products are suitable for use in specified lead-free processes. TI may reference these types of products as "Pb-Free".

**RoHS Exempt:** TI defines "RoHS Exempt" to mean products that contain lead but are compliant with EU RoHS pursuant to a specific EU RoHS exemption.

**Green:** TI defines "Green" to mean the content of Chlorine (Cl) and Bromine (Br) based flame retardants meet JS709B low halogen requirements of <=1000ppm threshold. Antimony trioxide based flame retardants must also meet the <=1000ppm threshold requirement.

(3) MSL, Peak Temp. - The Moisture Sensitivity Level rating according to the JEDEC industry standard classifications, and peak solder temperature.

(4) There may be additional marking, which relates to the logo, the lot trace code information, or the environmental category on the device.

(5) Multiple Device Markings will be inside parentheses. Only one Device Marking contained in parentheses and separated by a "~" will appear on a device. If a line is indented then it is a continuation of the previous line and the two combined represent the entire Device Marking for that device.

(6) Lead finish/Ball material - Orderable Devices may have multiple material finish options. Finish options are separated by a vertical ruled line. Lead finish/Ball material values may wrap to two lines if the finish value exceeds the maximum column width.

**Important Information and Disclaimer:**The information provided on this page represents TI's knowledge and belief as of the date that it is provided. TI bases its knowledge and belief on information provided by third parties, and makes no representation or warranty as to the accuracy of such information. Efforts are underway to better integrate information from third parties. TI has taken and continues to take reasonable steps to provide representative and accurate information but may not have conducted destructive testing or chemical analysis on incoming materials and chemicals. TI and TI suppliers consider certain information to be proprietary, and thus CAS numbers and other limited information may not be available for release.

In no event shall TI's liability arising out of such information exceed the total purchase price of the TI part(s) at issue in this document sold by TI to Customer on an annual basis.



**TAPE AND REEL INFORMATION**

**QUADRANT ASSIGNMENTS FOR PIN 1 ORIENTATION IN TAPE**

\*All dimensions are nominal

Device	Package Type	Package Drawing	Pins	SPQ	Reel Diameter (mm)	Reel Width W1 (mm)	A0 (mm)	B0 (mm)	K0 (mm)	P1 (mm)	W (mm)	Pin1 Quadrant
CSD87501L	PICOSTAR	YJG	10	3000	330.0	12.4	1.62	3.62	0.37	8.0	12.0	Q1
CSD87501LT	PICOSTAR	YJG	10	250	330.0	12.4	1.62	3.62	0.37	8.0	12.0	Q1

**TAPE AND REEL BOX DIMENSIONS**

\*All dimensions are nominal

Device	Package Type	Package Drawing	Pins	SPQ	Length (mm)	Width (mm)	Height (mm)
CSD87501L	PICOSTAR	YJG	10	3000	335.0	335.0	25.0
CSD87501LT	PICOSTAR	YJG	10	250	335.0	335.0	25.0

## 重要声明和免责声明

TI“按原样”提供技术和可靠性数据（包括数据表）、设计资源（包括参考设计）、应用或其他设计建议、网络工具、安全信息和其他资源，不保证没有瑕疵且不做任何明示或暗示的担保，包括但不限于对适销性、某特定用途方面的适用性或不侵犯任何第三方知识产权的暗示担保。

这些资源可供使用 TI 产品进行设计的熟练开发人员使用。您将自行承担以下全部责任：(1) 针对您的应用选择合适的 TI 产品，(2) 设计、验证并测试您的应用，(3) 确保您的应用满足相应标准以及任何其他功能安全、信息安全、监管或其他要求。

这些资源如有变更，恕不另行通知。TI 授权您仅可将这些资源用于研发本资源所述的 TI 产品的应用。严禁对这些资源进行其他复制或展示。您无权使用任何其他 TI 知识产权或任何第三方知识产权。您应全额赔偿因在这些资源的使用中对 TI 及其代表造成的任何索赔、损害、成本、损失和债务，TI 对此概不负责。

TI 提供的产品受 [TI 的销售条款](#) 或 [ti.com](#) 上其他适用条款/TI 产品随附的其他适用条款的约束。TI 提供这些资源并不会扩展或以其他方式更改 TI 针对 TI 产品发布的适用的担保或担保免责声明。

TI 反对并拒绝您可能提出的任何其他或不同的条款。

邮寄地址：Texas Instruments, Post Office Box 655303, Dallas, Texas 75265  
Copyright © 2024，德州仪器 (TI) 公司