

DRV5057 具有 PWM 输出的线性霍尔效应传感器

1 特性

- PWM 输出线性霍尔效应磁传感器
- 由 3.3V 和 5V 电源供电
- 2kHz 时钟输出，静态占空比为 50%
- 磁性灵敏度选项 ($V_{CC} = 5V$ 时)：
 - A1/Z1：2%D/mT， $\pm 21mT$ 范围
 - A2/Z2：1%D/mT， $\pm 42mT$ 范围
 - A3/Z3：0.5%D/mT， $\pm 84mT$ 范围
 - A4/Z4：0.25%D/mT， $\pm 168mT$ 范围
- 开漏输出，具有 20mA 灌电流能力
- 磁体温度漂移补偿（针对 A1/A2/A3/A4 版本提供，针对 Z1/Z2/Z3/Z4 版本不提供）
- 行业标准封装：
 - 表面贴装 SOT-23
 - 穿孔 TO-92

2 应用

- 精确位置检测
- 工业自动化和机器人
- 家用电器
- 游戏手柄、踏板、键盘、触发器
- 高度找平、倾斜和重量测量
- 流体流速测量
- 医疗设备
- 绝对值角度编码
- 电流检测

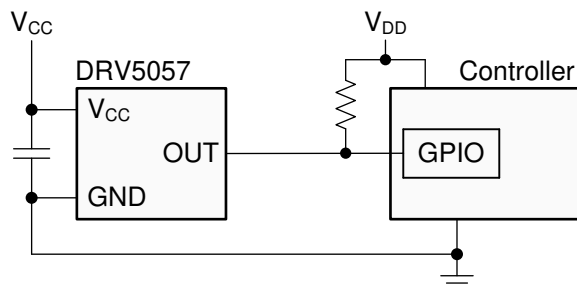

典型原理图

3 说明

DRV5057 是一款线性霍尔效应传感器，可按比例响应磁通量密度。该器件可用于在各种应用中进行精确的位置检测。

该器件由 3.3V 或 5V 电源供电。当不存在磁场时，输出产生占空比为 50% 的时钟。输出占空比会随施加的磁通量密度呈线性变化，四个灵敏度选项可以根据所需的感应范围最大限度扩大输出动态范围。南北磁极产生唯一的输出。典型的脉宽调制 (PWM) 载波频率为 2kHz。

它可检测垂直于封装顶部的磁通量，而且两个封装选项提供不同的检测方向。

由于 PWM 信号基于边沿到边沿定时，因此当存在电压噪声或接地电势失配时，可保持信号完整性。该信号适合嘈杂环境中的远距离传输，始终存在的时钟使得系统控制器能够确认具备良好的互连。此外，该器件具有磁体温度补偿功能，可抵消磁体漂移，在 $-40^{\circ}C$ 至 $+125^{\circ}C$ 的宽温度范围内实现线性性能。还提供了无磁体漂移温度补偿的器件选项。

器件信息

器件型号	封装 ⁽¹⁾	封装尺寸 (标称值)
DRV5057	SOT-23 (3)	2.92mm × 1.30mm
	TO-92 (3)	4.00mm × 3.15mm

(1) 如需了解所有可用封装，请参阅数据表末尾的封装选项附录。

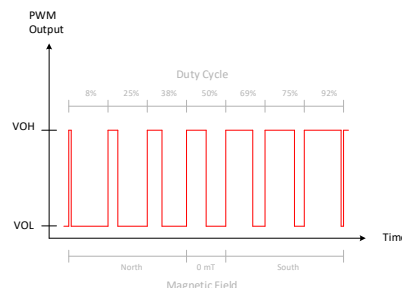

磁响应



Table of Contents

1 特性	1	7.4 Device Functional Modes.....	13
2 应用	1	8 Application and Implementation	14
3 说明	1	8.1 Application Information.....	14
4 Revision History	2	8.2 Typical Applications.....	15
5 Pin Configuration and Functions	3	8.3 What to Do and What Not to Do.....	23
Pin Functions.....	3	9 Power Supply Recommendations	24
6 Specifications	3	10 Layout	24
6.1 Absolute Maximum Ratings.....	3	10.1 Layout Guidelines.....	24
6.2 ESD Ratings.....	4	10.2 Layout Examples	24
6.3 Recommended Operating Conditions.....	4	11 Device and Documentation Support	25
6.4 Thermal Information.....	4	11.1 Documentation Support.....	25
6.5 Electrical Characteristics.....	4	11.2 接收文档更新通知.....	25
6.6 Magnetic Characteristics.....	4	11.3 支持资源.....	25
6.7 Typical Characteristics.....	6	11.4 Trademarks.....	25
7 Detailed Description	10	11.5 静电放电警告.....	25
7.1 Overview.....	10	11.6 术语表.....	25
7.2 Functional Block Diagram.....	10	12 Mechanical, Packaging, and Orderable Information	25
7.3 Feature Description.....	10		

4 Revision History

Changes from Revision * (November 2018) to Revision A (August 2020)	Page
• 更新了整个文档中的表格、图和交叉参考的编号格式.....	1
• 添加了零 TC 灵敏度选项.....	1
• Added Zero TC information to 节 6.6	4
• Fixed labels for some of the plots for graphs for DRV5057 A1/A2/A3/A4 devices and added Zero TC characteristics plots for DRV5057 Z1/Z2/Z3/Z4 devices in 节 6.7	6
• Updated 节 7.3.4 section for Zero TC options.....	12

5 Pin Configuration and Functions



图 5-1. DBZ Package 3-Pin SOT-23 Top View



图 5-2. LPG Package 3-Pin TO-92 Top View

Pin Functions

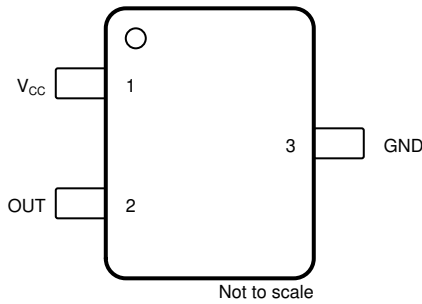
NAME	PIN		TYPE	DESCRIPTION
	SOT-23	TO-92		
GND	3	2	Ground	Ground reference
OUT	2	3	Output	Analog output
V _{CC}	1	1	Power	Power supply. Connect this pin to a ceramic capacitor to ground with a value of at least 0.01 μ F.

6 Specifications

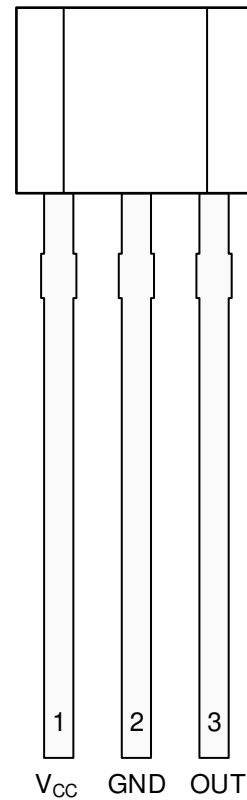
6.1 Absolute Maximum Ratings

over operating free-air temperature range (unless otherwise noted)⁽¹⁾

				MIN	MAX	UNIT
V _{CC}	Power supply voltage	V _{CC}		- 0.3	7	V
	Output voltage	OUT		- 0.3	6	V
	Output current	OUT			30	mA
B	Magnetic flux density			Unlimited		T
T _J	Operating junction temperature			- 40	150	°C
T _{stg}	Storage temperature			- 65	150	°C

(1) Stresses beyond those listed under *Absolute Maximum Ratings* may cause permanent damage to the device. These are stress ratings only, which do not imply functional operation of the device at these or any other conditions beyond those indicated under *Recommended Operating Conditions*. Exposure to absolute-maximum-rated conditions for extended periods may affect device reliability.

6.2 ESD Ratings

			VALUE	UNIT
V _(ESD)	Electrostatic discharge	Human-body model (HBM), per ANSI/ESDA/JEDEC JS-001 ⁽¹⁾	±3000	V
		Charged-device model (CDM), per JEDEC specification JESD22-C101 ⁽²⁾	±750	

(1) JEDEC document JEP155 states that 500-V HBM allows safe manufacturing with a standard ESD control process.

(2) JEDEC document JEP157 states that 250-V CDM allows safe manufacturing with a standard ESD control process.

6.3 Recommended Operating Conditions

over operating free-air temperature range (unless otherwise noted)

		MIN	MAX	UNIT
V _{CC}	Power-supply voltage ⁽¹⁾	3	3.63	V
		4.5	5.5	
V _O	Output pullup voltage	0	5.5	V
I _O	Output continuous current	0	20	mA
T _A	Operating ambient temperature ⁽²⁾	-40	125	°C

(1) There are two isolated operating V_{CC} ranges. For more information see the [§ 7.3.3](#) section.

(2) Power dissipation and thermal limits must be observed.

6.4 Thermal Information

THERMAL METRIC ⁽¹⁾		DRV5057		UNIT
		SOT-23 (DBZ)	TO-92 (LPG)	
		3 PINS	3 PINS	
R _{θJA}	Junction-to-ambient thermal resistance	170	121	°C/W
R _{θJC(top)}	Junction-to-case (top) thermal resistance	66	67	°C/W
R _{θJB}	Junction-to-board thermal resistance	49	97	°C/W
Ψ _{JT}	Junction-to-top characterization parameter	1.7	7.6	°C/W
Ψ _{JB}	Junction-to-board characterization parameter	48	97	°C/W

(1) For more information about traditional and new thermal metrics, see the [Semiconductor and IC Package Thermal Metrics application report](#).

6.5 Electrical Characteristics

for V_{CC} = 3 V to 3.63 V and 4.5 V to 5.5 V, over operating free-air temperature range (unless otherwise noted)

PARAMETER		TEST CONDITIONS	MIN	TYP	MAX	UNIT
I _{CC}	Operating supply current			6	10	mA
t _{ON}	Power-on time (see Fig 7-4) ⁽²⁾	B ⁽¹⁾ = 0 mT, no load on OUT		0.6	0.9	ms
f _{PWM}	PWM carrier frequency		1.8	2.0	2.2	kHz
D _J	Duty cycle peak-to-peak jitter	From change in B to change in OUT		±0.1		%D ⁽¹⁾
I _{OZ}	High-impedance output leakage current	V _{CC} = 5 V			100	nA
V _{OL}	Low-level output voltage	I _{OUT} = 20 mA		0.15	0.4	V

(1) This unit is a percentage of duty cycle.

(2) t_{ON} is the time from when V_{CC} goes above 3 V until the first rising edge of the first valid pulse.

6.6 Magnetic Characteristics

for V_{CC} = 3 V to 3.63 V and 4.5 V to 5.5 V, over operating free-air temperature range (unless otherwise noted)

PARAMETER		TEST CONDITIONS	MIN	TYP	MAX	UNIT
D _L	Linear duty cycle range		8		92	%D ⁽¹⁾

for $V_{CC} = 3\text{ V to }3.63\text{ V and }4.5\text{ V to }5.5\text{ V}$, over operating free-air temperature range (unless otherwise noted)

PARAMETER		TEST CONDITIONS	MIN	TYP	MAX	UNIT	
D_{CL}	Clamped-low duty cycle	$B^{(1)} < -250\text{ mT}$	5.3	6	6.7	%D	
D_{CH}	Clamped-high duty cycle	$B > 250\text{ mT}$	93.3	94	94.7		
D_Q	Quiescent duty cycle ⁽²⁾	$B = 0\text{ mT}$, $T_A = 25^\circ\text{C}$, $V_{CC} = 3.3\text{ V or }5\text{ V}$	46	50	54		
$V_{Q\Delta L}$	Quiescent duty cycle lifetime drift	High-temperature operating stress for 1000 hours	< 0.5			%	
S	Sensitivity ⁽⁵⁾	$V_{CC} = 5\text{ V}$, $T_A = 25^\circ\text{C}$	DRV5057A1/Z1	1.88	2	2.12	%D/mT
			DRV5057A2/Z2	0.94	1	1.06	
			DRV5057A3/Z3	0.47	0.5	0.53	
			DRV5057A4/Z4	0.23	0.25	0.27	
		$V_{CC} = 3.3\text{ V}$, $T_A = 25^\circ\text{C}$	DRV5057A1/Z1	1.13	1.2	1.27	
			DRV5057A2/Z2	0.56	0.6	0.64	
			DRV5057A3/Z3	0.28	0.3	0.32	
			DRV5057A4/Z4	0.138	0.15	0.162	
B_L	Linear magnetic flux density sensing range ^{(2) (3) (5)}	$V_{CC} = 5\text{ V}$, $T_A = 25^\circ\text{C}$	DRV5057A1/Z1	± 21		mT	
			DRV5057A2/Z2	± 42			
			DRV5057A3/Z3	± 84			
			DRV5057A4/Z4	± 168			
S_{TC}	Sensitivity temperature compensation for magnets ⁽⁴⁾	DRV5057A1, DRV5057A2, DRV5057A3, DRV5057A4	0.12		%/°C		
S_{TCz}	Sensitivity temperature compensation for magnets ^{(4) (5)}	DRV5057Z1, DRV5057Z2, DRV5057Z3, DRV5057Z4	0		%/°C		
S_{LE}	Sensitivity linearity error ⁽²⁾	Output duty cycle is within D_L	± 1		%		
R_{SE}	Sensitivity error over operating VCC range	Output duty cycle is within D_L	± 1		%		
$S_{\Delta L}$	Quiescent error over operating VCC range		< 0.5		%		

- (1) B is the applied magnetic flux density.
- (2) See the [# 7.3.2](#) section.
- (3) B_L describes the minimum linear sensing range at 25°C taking into account the maximum V_Q and sensitivity tolerances.
- (4) S_{TC} describes the rate the device increases Sensitivity with temperature. For more information, see the [# 7.3.4](#) section and [图 6-7 to 图 6-20](#).
- (5) Product Preview data only for DRV5055Z1 - DRV5055Z4 device options.

6.7 Typical Characteristics

for $T_A = 25^\circ\text{C}$ (unless otherwise noted)

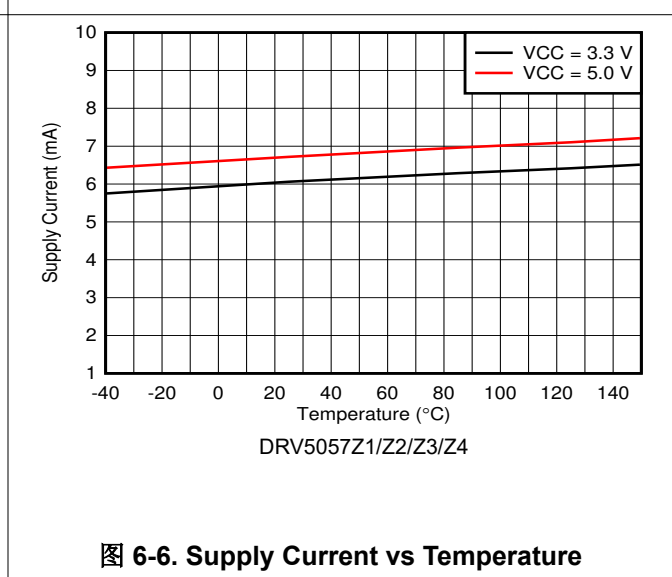
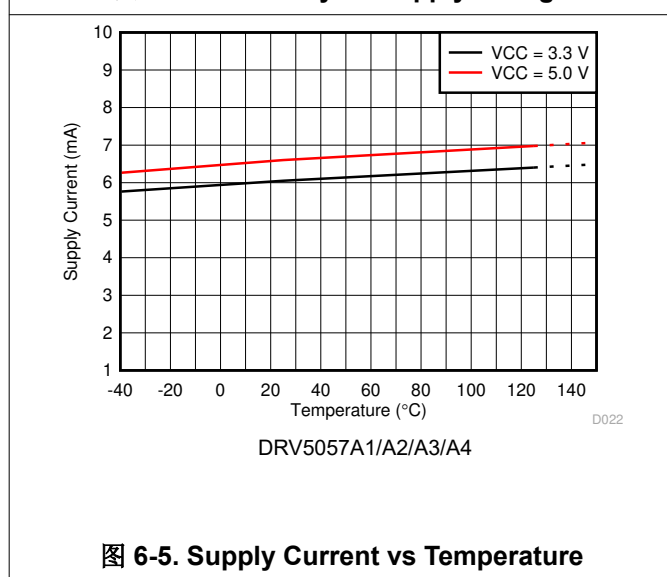
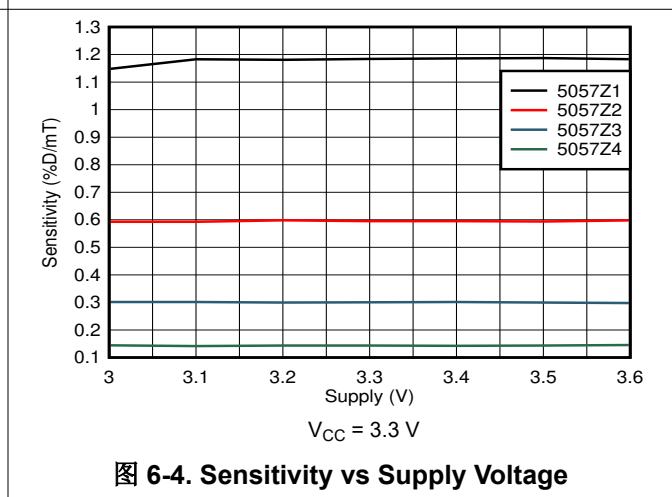
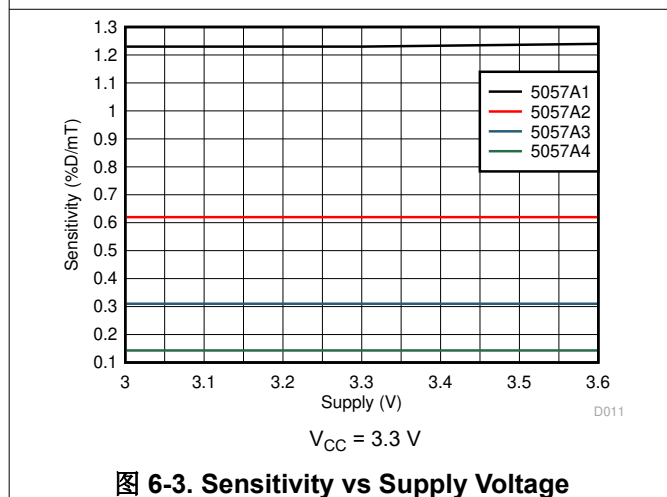
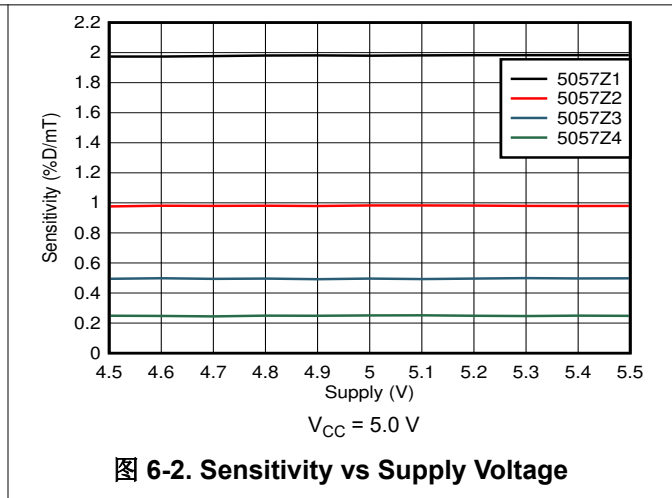
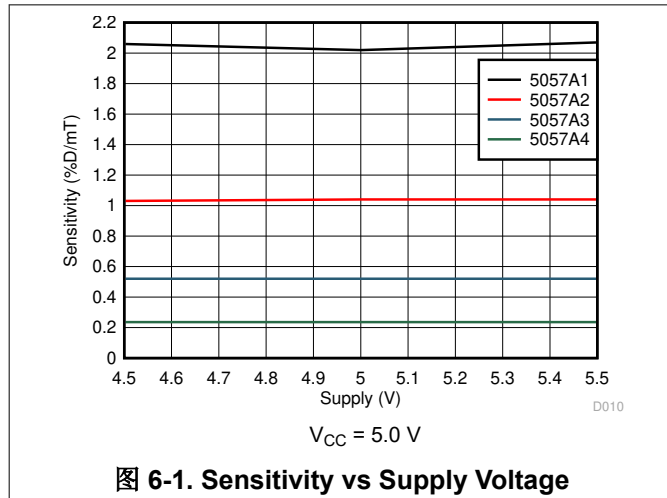



图 6-7. Sensitivity vs Temperature



图 6-8. Sensitivity vs Temperature

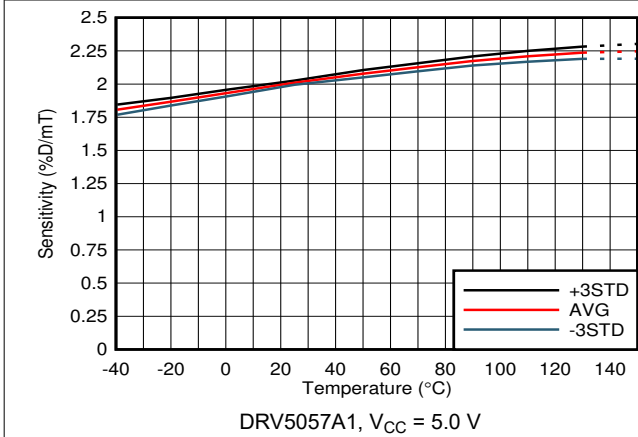

图 6-9. Sensitivity vs Temperature

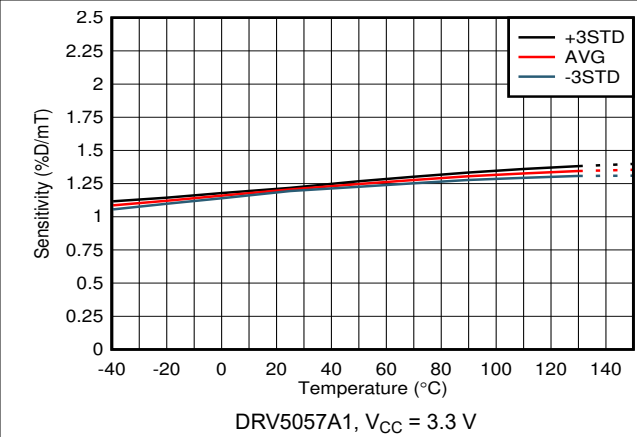

图 6-10. Sensitivity vs Temperature

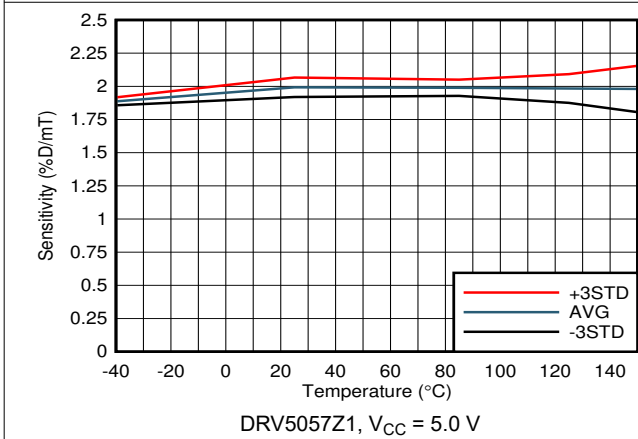

图 6-11. Sensitivity vs Temperature

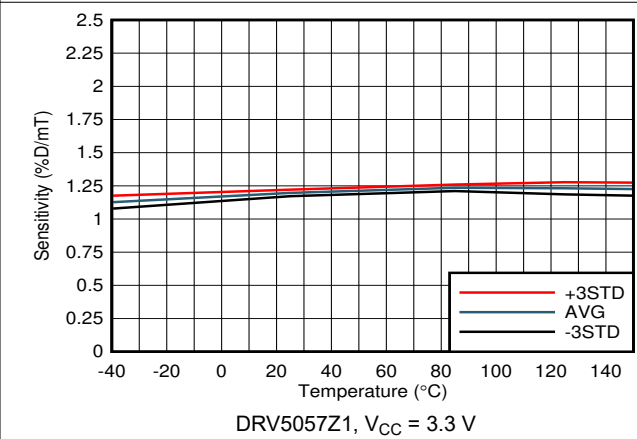

图 6-12. Sensitivity vs Temperature

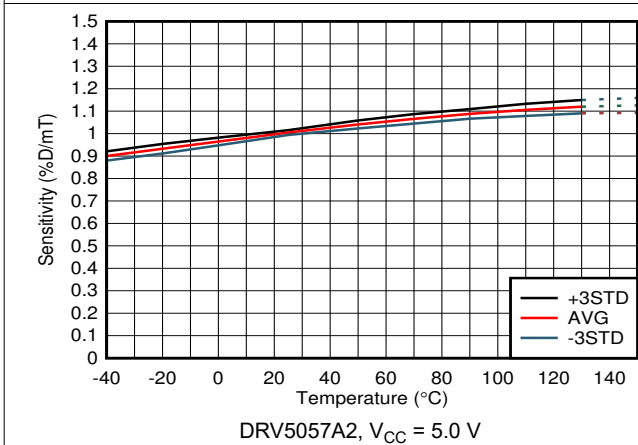

DRV5057Z2, $V_{CC} = 5.0\text{ V}$

图 6-13. Sensitivity vs Temperature

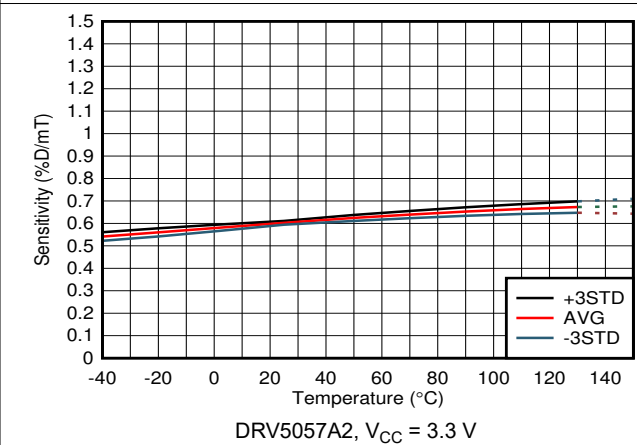
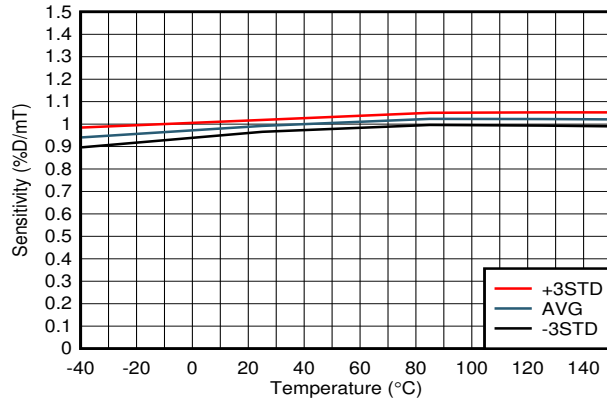
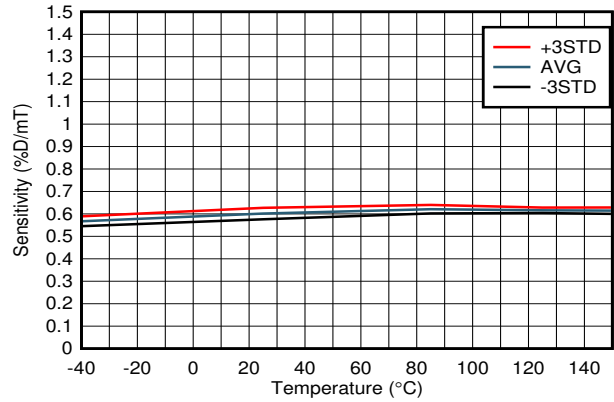

DRV5057Z2, $V_{CC} = 3.3\text{ V}$

图 6-14. Sensitivity vs Temperature

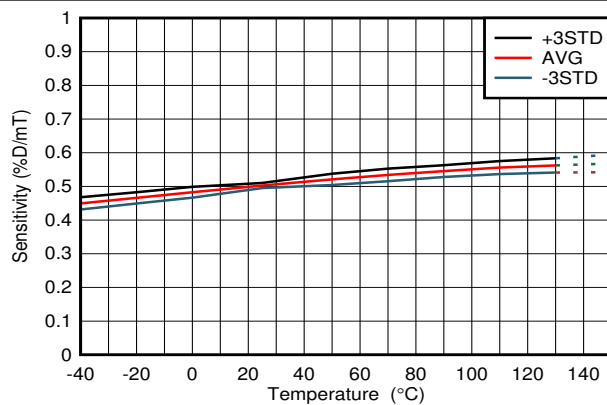

DRV5057A3, $V_{CC} = 5.0\text{ V}$

图 6-15. Sensitivity vs Temperature

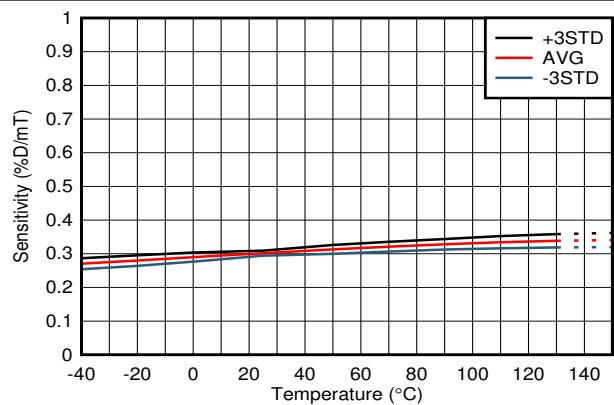

DRV5057A3, $V_{CC} = 3.3\text{ V}$

图 6-16. Sensitivity vs Temperature

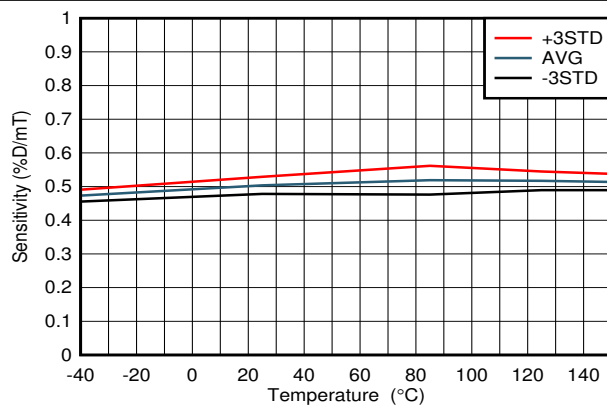

DRV5057Z3, $V_{CC} = 5.0\text{ V}$

图 6-17. Sensitivity vs Temperature

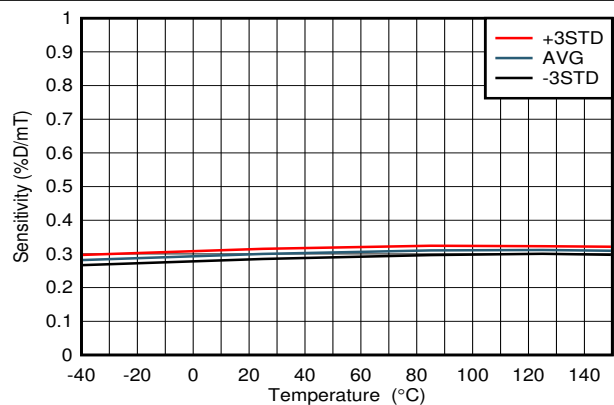

DRV5057Z3, $V_{CC} = 3.3\text{ V}$

图 6-18. Sensitivity vs Temperature



图 6-19. Sensitivity vs Temperature

DRV5057A4, $V_{CC} = 5.0\text{ V}$

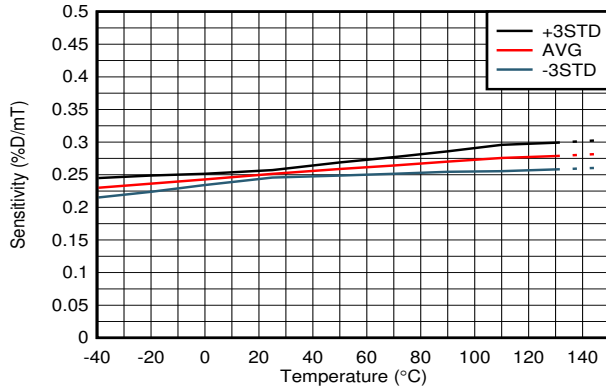

图 6-20. Sensitivity vs Temperature

DRV5057A4, $V_{CC} = 3.3\text{ V}$

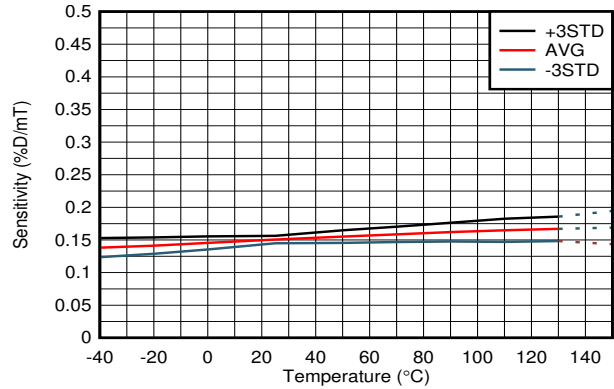

图 6-21. Sensitivity vs Temperature

DRV5057Z4, $V_{CC} = 5.0\text{ V}$

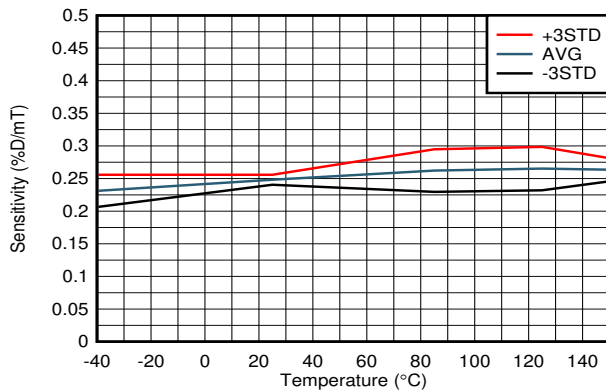

图 6-22. Sensitivity vs Temperature

DRV5057Z4, $V_{CC} = 3.3\text{ V}$

7 Detailed Description

7.1 Overview

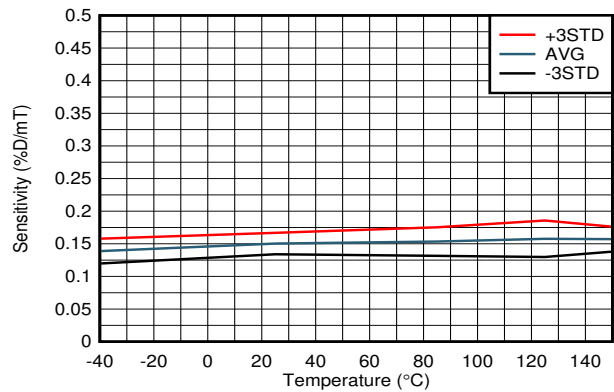
The DRV5057 is a 3-pin pulse-width modulation (PWM) output Hall effect sensor with fully integrated signal conditioning, temperature compensation circuits, mechanical stress cancellation, and amplifiers. The device operates from 3.3-V and 5-V ($\pm 10\%$) power supplies, measures magnetic flux density, and outputs a pulse-width modulated, 2-kHz digital signal.

7.2 Functional Block Diagram

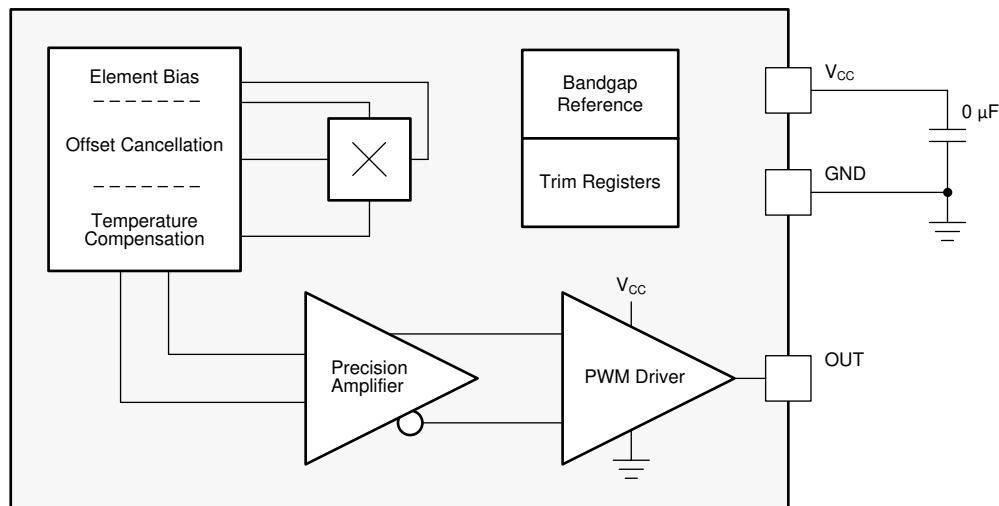

7.3 Feature Description

7.3.1 Magnetic Flux Direction

As shown in [图 7-1](#), the DRV5057 is sensitive to the magnetic field component that is perpendicular to the top of the package.



图 7-1. Direction of Sensitivity

Magnetic flux that travels from the bottom to the top of the package is considered positive in this document. This condition exists when a south magnetic pole is near the top (marked-side) of the package. Magnetic flux that travels from the top to the bottom of the package results in negative millitesla values. 图 7-2 shows flux direction.

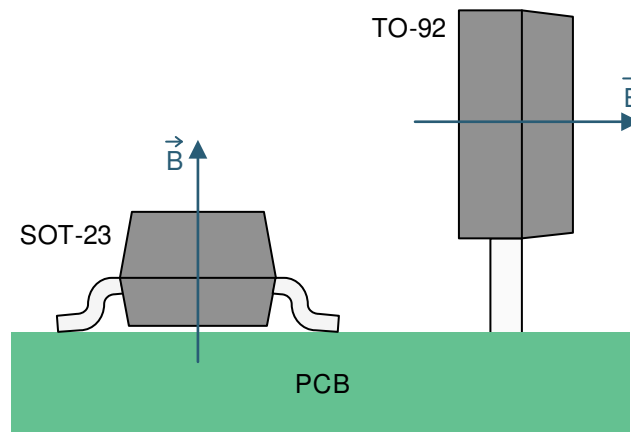

图 7-2. Flux Direction for Positive B

7.3.2 Sensitivity Linearity

The device produces a pulse-width modulated digital signal output. As shown in 图 7-3, the duty-cycle of the PWM output signal is proportional to the magnetic field detected by the Hall element of the device. If there is no magnetic field present, the duty cycle is 50%. The DRV5057 can detect both magnetic north and south poles. The output duty cycle maintains a linear relationship with the input magnetic field from 8% to 92%.

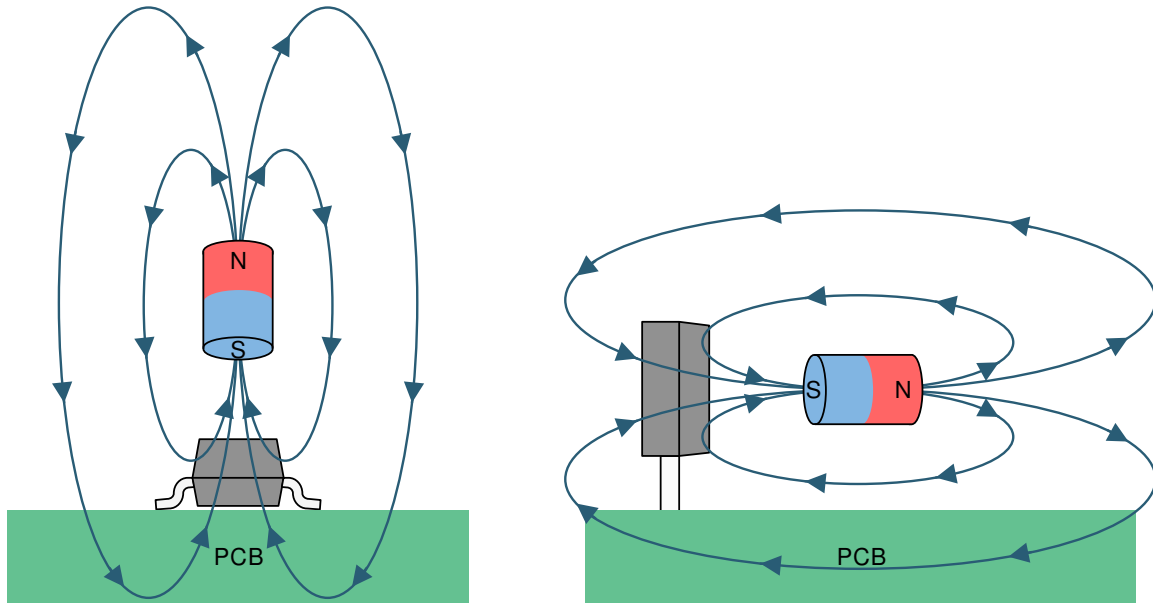

图 7-3. Magnetic Response

7.3.3 Operating V_{CC} Ranges

The DRV5057 has two recommended operating V_{CC} ranges: 3 V to 3.63 V and 4.5 V to 5.5 V. When V_{CC} is in the middle region between 3.63 V to 4.5 V, the device continues to function but sensitivity is less known because there is a crossover threshold near 4 V that adjusts device characteristics.

7.3.4 Sensitivity Temperature Compensation for Magnets

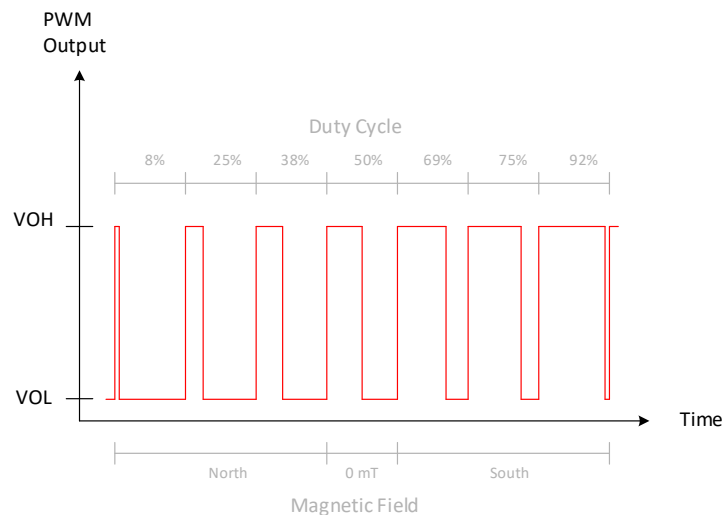
Magnets generally produce weaker fields as temperature increases. The DRV5057A1 - DRV5057A4 device options have a temperature compensation feature that is designed to directly compensate the average drift of neodymium (NdFeB) magnets and partially compensate ferrite magnets. The residual induction (B_r) of a magnet typically reduces by 0.12%/°C for NdFeB, and 0.20%/°C for ferrite. When the operating temperature of a system is reduced, temperature drift errors are also reduced. The DRV5057Z1 - DRV5057Z4 devices options do not compensate for the drift external magnets

7.3.5 Power-On Time

After the V_{CC} voltage is applied, the DRV5057 requires a short initialization time before the output is set. The parameter t_{ON} describes the time from when V_{CC} crosses 3 V until OUT is within 5% of V_Q , with 0 mT applied and no load attached to OUT. 图 7-4 shows this timing diagram.



图 7-4. t_{ON} Definition

7.3.6 Hall Element Location

图 7-5 shows the location of the sensing element inside each package option.

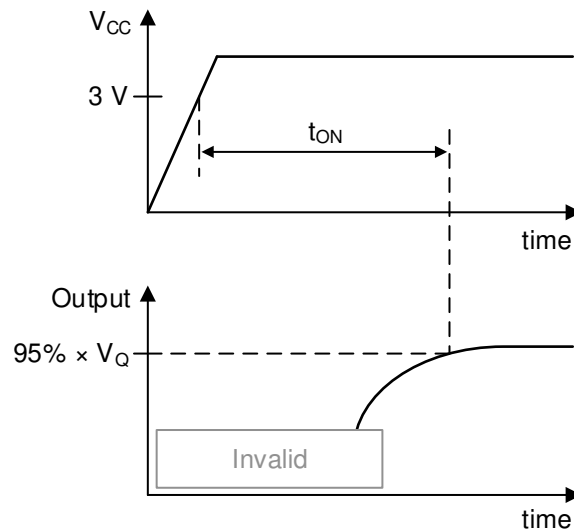

图 7-5. Hall Element Location

7.4 Device Functional Modes

The DRV5057 has one mode of operation that applies when the *Recommended Operating Conditions* are met.

8 Application and Implementation

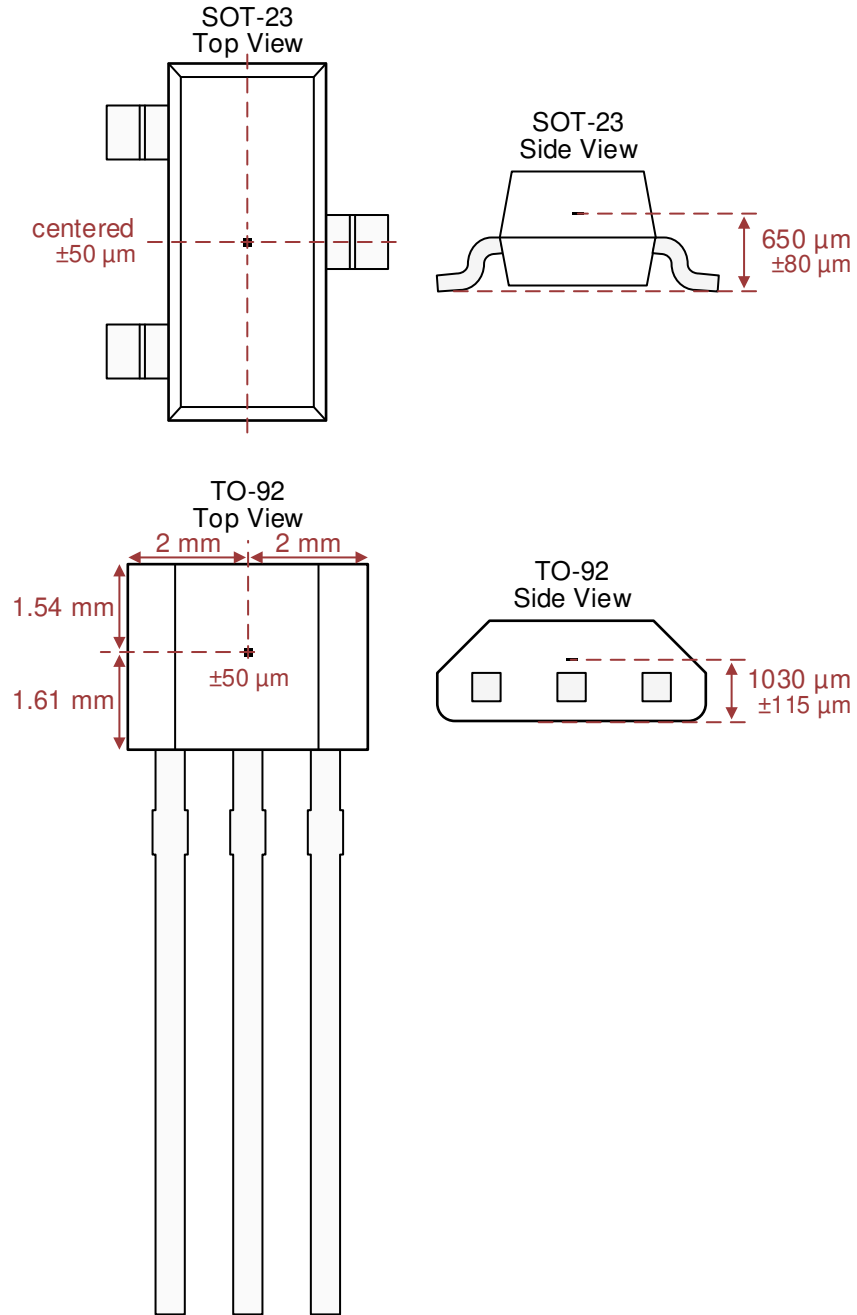
备注

以下应用部分的信息不属于 TI 组件规范，TI 不担保其准确性和完整性。客户应负责确定 TI 组件是否适用于其应用。客户应验证并测试其设计，以确保系统功能。

8.1 Application Information

8.1.1 Selecting the Sensitivity Option

Select the highest DRV5057 sensitivity option that can measure the required range of magnetic flux density so that the output voltage swing is maximized.

Larger-sized magnets and farther sensing distances can generally enable better positional accuracy than very small magnets at close distances, because magnetic flux density increases exponentially with the proximity to a magnet. TI created an online tool to help with simple magnet calculations on the [DRV5057 product folder](#).

8.1.2 Decoding a PWM

A PWM output helps system designers drive signals for long distances in noisy environments, with the ability to retrieve the signal accurately. A decoder is employed at the load to retrieve the analog magnetic signal. Two different methods of decoding are discussed in this section.

8.1.2.1 Decoding a PWM (Digital)

8.1.2.1.1 Capture and Compare Timer Interrupt

Many microcontrollers have a capture and compare timer mode that can simplify the PWM decoding process. Use the timer in capture and compare mode with an interrupt that triggers on both the rising and falling edges of the signal to obtain both the relative high (on) and low (off) time of the PWM. Make sure that the timer period is significantly faster than the period of the PWM, based on the desired resolution. Calculate the percent duty cycle (%D) of the PWM with [方程式 1](#) by using the relative on and off time of the signal.

$$\%D = \frac{\text{OnTime}}{\text{OnTime} + \text{OffTime}} \times 100 \quad (1)$$

8.1.2.1.2 Oversampling and Counting With a Timer Interrupt

If a capture and compare timer is not available, a standard timer interrupt and a counter can be used. Configure the timer interrupt to be significantly faster than the period of the PWM, based on the desired resolution. Count how many times the timer interrupts while the signal is high (OnTime), then count how many times the timer interrupts while the signal is low (OffTime). Then use [方程式 1](#) to calculate the duty cycle.

8.1.2.1.3 Accuracy and Resolution

The accuracy and resolution for the methods described in the [节 8.1.2.1.1](#) and [节 8.1.2.1.2](#) sections depends significantly on the timer sampling frequency. [方程式 2](#) calculates the least significant bit of the duty cycle (%D_{LSB}) based on the chosen timer sampling frequency.

$$\%D_{\text{LSB}} = \frac{\text{PWM}_{\text{frequency}}}{\text{TIMER}_{\text{frequency}}} \times 100 \quad (2)$$

For example, with a 2-kHz PWM and a 400-kHz sampling frequency, the %D_{LSB} is:

$$(2 \text{ kHz} / 400 \text{ kHz}) \times 100 = 0.5\%D_{\text{LSB}}$$

If the sampling frequency is increased to 2-MHz, the %D_{LSB} is improved to be:

$$(2 \text{ MHz} / 400 \text{ kHz}) \times 100 = 0.1\%D_{\text{LSB}}$$

However, accuracy and resolution are still subject to noise and sensitivity.

8.1.2.2 Decoding a PWM (Analog)

If an analog signal is needed at the end of a large travel distance, first use a microcontroller to digitally decode the PWM, then use a DAC to produce the analog signal. If an analog signal is needed after a short signal travel distance, use an analog output device, such as the [DRV5055](#).

If an analog signal is needed at the end of a large travel distance and a microcontroller is unavailable, use a low-pass filter to convert the PWM signal into an analog voltage, as shown in [图 8-1](#). When using this method, note the following:

- A ripple appears at the analog voltage output, causing a decrease in accuracy. The ripple intensity and frequency depend on the values chosen for R and C in the filter.
- The minimum and maximum voltages of the PWM must be known to calculate the magnetic field strength from the analog voltage. Thus, if the signal is traveling a large distance, then the minimum and maximum values must be either measured or buffered back to a known value.



图 8-1. Low-Pass RC Filter

8.2 Typical Applications

The DRV557-Q1 is a very robust linear position sensor for applications such as throttle positions, brakes, and clutch pedals. In linear position applications, depending on the mechanical placement and design limitations, two common types of magnet orientations are selected: full-swing and half-swing.

8.2.1 Full-Swing Orientation Example

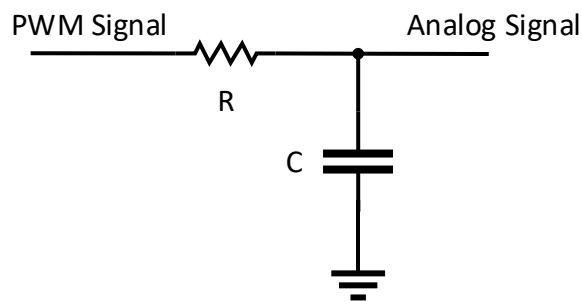
In the full-swing orientation, a magnet travels in parallel to the DRV5057-Q1 surface. In this case, the magnetic range extends from south polarity to north polarity, and allows the DRV5057-Q1 to use the full linear magnetic flux density sensing range.



图 8-2. Full-Swing Orientation Example

8.2.1.1 Design Requirements

Use the parameters listed in 表 8-1 for this design example.

表 8-1. Design Parameters

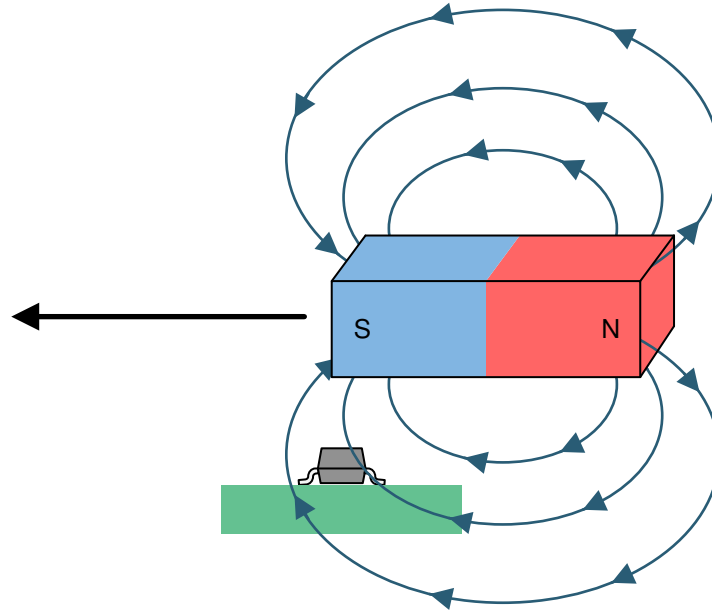
DESIGN PARAMETER	EXAMPLE VALUE
Device	DRV5057
V_{CC}	5 V
Magnet	Cylinder: 4.7625-mm diameter, 12.7-mm thick, neodymium N52, $B_r = 1480$ mT
Travel distance	10 mm
Desired accuracy	< 0.1 mm

8.2.1.2 Detailed Design Procedure

Linear Hall effect sensors provide flexibility in mechanical design because many possible magnet orientations and movements produce a usable response from the sensor. 图 8-2 illustrates one of the most common orientations that uses the full north to south range of the sensor and causes a close-to-linear change in magnetic flux density as the magnet moves across the sensor. 图 8-3 illustrates the close-to-linear change in magnetic field present at the sensor as the magnet moves a given distance across the sensor. The usable linear region is close to but less than the length (thickness) of the magnet.

When designing a linear magnetic sensing system, always consider these three variables: the magnet, sensing distance, and the range of the sensor. Select the DRV5057 with the highest sensitivity possible based on the system distance requirements without railing the sensor PWM output. To determine the magnetic flux density the sensor receives at the various positions of the magnet, use a magnetic field calculator or simulation software, referring to magnet specifications, and testing.

Determine if the desired accuracy is met by comparing the maximum allowed duty cycle least significant bit ($\%D_{LSBmax}$) with the noise level (PWM jitter) of the device. 方程式 3 calculates the $\%D_{LSBmax}$ by taking into account the used length of the linear region (travel distance), the desired resolution, and the output PWM swing (within the linear duty cycle range).

$$\%D_{LSBmax} = \frac{\%D_{swing}}{Travel\ Distance} \times Resolution \quad (3)$$

Thus, with this example (and a linear duty cycle range of 8%D to 92%D), using 方程式 3 gives $(92 - 8) / (10) \times 0.1 = 0.84\%D_{LSBmax}$. This value is larger than the 0.1%D jitter, and therefore the desired accuracy can be achieved by using 方程式 2 to select a $\%D_{LSB}$ that is equal to or less than 0.84. Then, simply calibrate the magnet position to align the sensor output along the movement path.

8.2.1.3 Application Curve

图 8-3 shows the magnetic field present at the sensor as the magnet passes by as described in 图 8-2. The change in distance from the trough to the peak is approximately the length (thickness) of the magnet. B changes based on the strength of the magnet and how close the magnet is to the sensor.



图 8-3. Magnetic Field vs Distance

8.2.2 Half-Swing Orientation Example

In the half-swing orientation, a magnet travels perpendicular to the DRV5057-Q1 surface. In this case, the magnetic range extends only to either the south or north pole, using only half of the DRV5057-Q1 linear magnetic flux density sensing range.

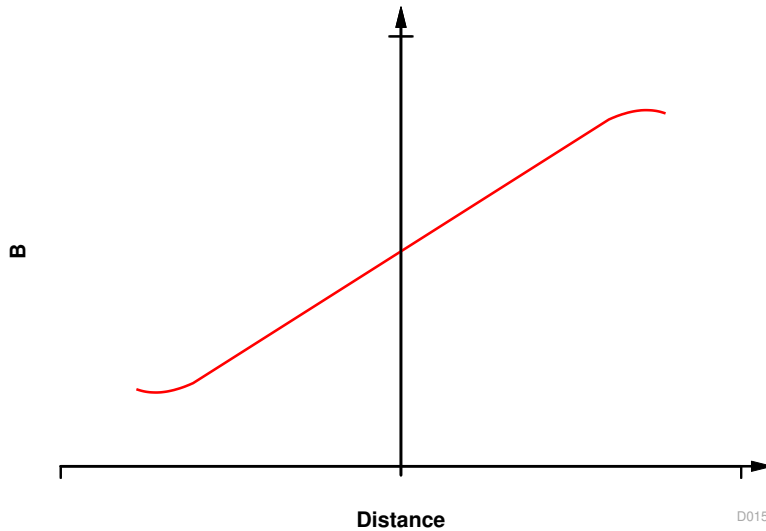

图 8-4. Half-Swing Orientation Example

8.2.2.1 Design Requirements

Use the parameters listed in 表 8-2 for this design example.

表 8-2. Design Parameters

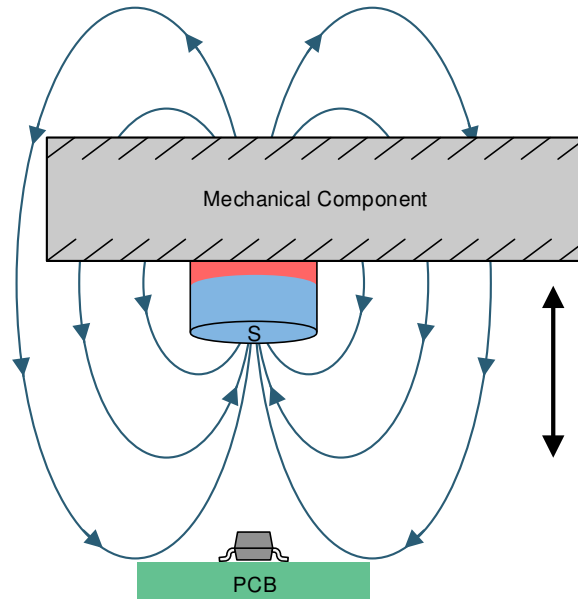
DESIGN PARAMETER	EXAMPLE VALUE
Device	DRV5057
V_{CC}	5 V
Magnet	Cylinder: 4.7625 mm diameter, 12.7 mm thick, Neodymium N52, $B_r = 1480$ mT
Travel distance	5 mm
Desired accuracy	< 0.1 mm

8.2.2.2 Detailed Design Procedure

As illustrated in 图 8-4, this design example consists of a mechanical component that moves back and forth, an embedded magnet with the south pole facing the printed-circuit board, and a DRV5057. The DRV5057 outputs a PWM that describes the precise position of the component. The component must not contain ferromagnetic materials such as iron, nickel, and cobalt because these materials change the magnetic flux density at the sensor.

When designing a linear magnetic sensing system, always consider these three variables: the magnet, sensing distance, and the range of the sensor. Select the DRV5057 with the highest sensitivity possible based on the system distance requirements without railing the sensor PWM output. To determine the magnetic flux density the sensor receives at the various positions of the magnet, use a magnetic field calculator or simulation software, referring to magnet specifications, and testing.

Magnets are made from various ferromagnetic materials that have tradeoffs in cost, drift with temperature, absolute maximum temperature ratings, remanence or residual induction (B_r), and coercivity (H_c). The B_r and the

dimensions of a magnet determine the magnetic flux density (B) produced in 3-dimensional space. For simple magnet shapes, such as rectangular blocks and cylinders, there are simple equations that solve B at a given distance centered with the magnet. 图 8-5 shows diagrams for 方程式 4 and 方程式 5.



图 8-5. Rectangular Block and Cylinder Magnets

Use 方程式 4 for the rectangular block shown in 图 8-5:

$$\vec{B} = \frac{B_r}{\pi} \left(\arctan\left(\frac{WL}{2D\sqrt{4D^2 + W^2 + L^2}}\right) - \arctan\left(\frac{WL}{2(D+T)\sqrt{4(D+T)^2 + W^2 + L^2}}\right) \right) \quad (4)$$

Use 方程式 5 for the cylinder illustrated in 图 8-5:

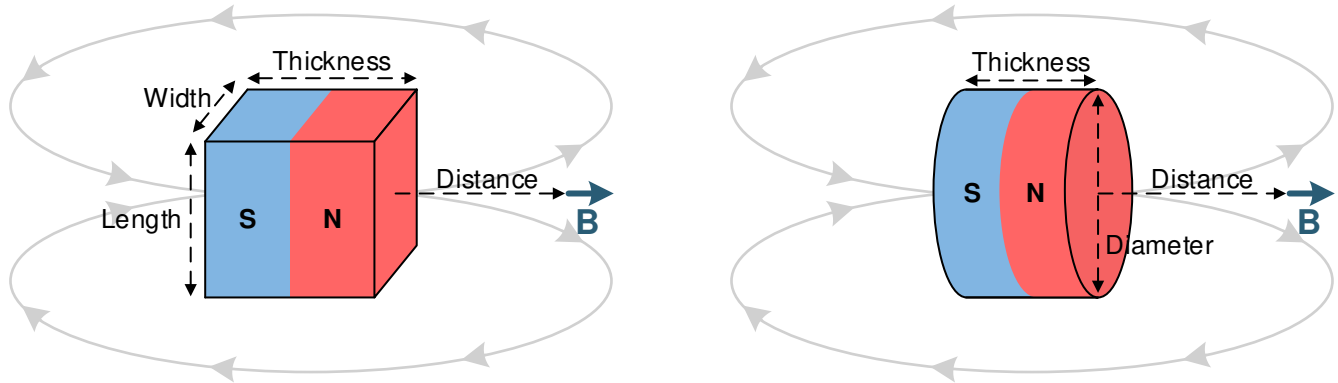
$$\vec{B} = \frac{B_r}{2} \left(\frac{D+T}{\sqrt{(0.5C)^2 + (D+T)^2}} - \frac{D}{\sqrt{(0.5C)^2 + D^2}} \right) \quad (5)$$

where:

- W is width
- L is length
- T is thickness (the direction of magnetization)
- D is distance
- C is diameter

This example uses a cylinder magnet; therefore, 方程式 5 can be used to create a lookup table for the distances from a specific magnet based on a magnetic field strength. 图 8-6 shows a magnetic field from 0 mm to 16 mm with the magnet defined in 表 8-2 as C = 4.7625 mm, T = 12.7 mm, and B_r = 1480 mT.



图 8-6. Magnetic Field vs Distance

In this setup, each gain version of the sensor produces the corresponding duty cycle shown in [图 8-7](#) for 0 mm to 16 mm.

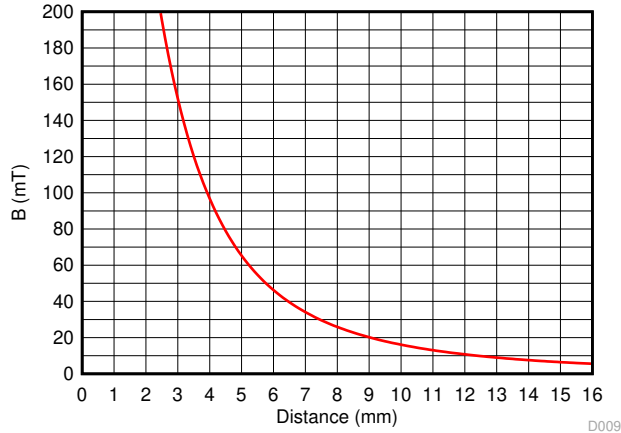

图 8-7. %D vs South Pole Distance (All Gains)

With a desired 5-mm movement swing, select the DRV5057 with the largest possible sensitivity that fits the system requirements for the magnet distance to the sensor. Assume that for this example, because of mechanical restrictions, the magnet at the nearest point to the sensor must be selected to be within 5 mm to 8 mm. The largest sensitivity option (A1) does not work in this situation because the device output is railed at the farthest allowed distance of 8 mm. The A2 version is not railed at this point, and is therefore the sensor selected for this example. Choose the closest point of the magnet to the sensor to be a distance that allows the magnet to get as close to the sensor as possible without railing but stays within the selectable 5-mm to 8-mm allowed range. Because the A2 version rails at approximately 6 mm, choose a closest distance of 6.5 mm to allow for a little bit of margin. With this choice, [图 8-8](#) shows the %D response at the sensor across the full movement range.

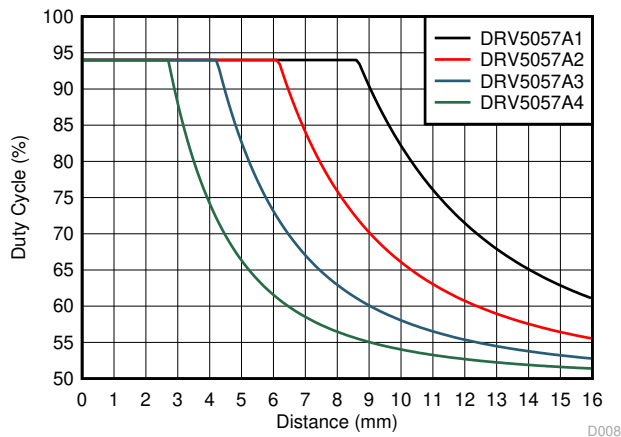

图 8-8. %D vs South Pole Distance (Gain A2)

The magnetic field strength is calculated using [方程式 6](#), where a negative number represents the opposite pole (in this example a south pole is over the sensor, causing the results to be a positive number).

$$B = \frac{(\%D - 50)}{\text{Gain}} \quad (6)$$

For example, if the A2 version of the DRV5057 measured a duty cycle of $\%D = 74.6\%$ using [方程式 1](#), then the magnetic field strength present at the sensor is $(74.6 - 50) / 1 = 24.6$ mT.

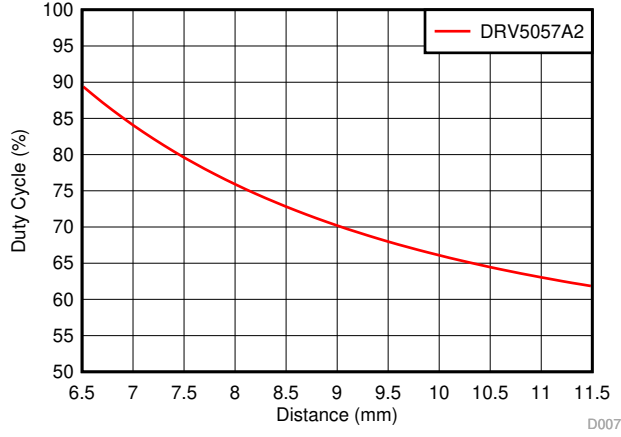
Using the lookup table that was used to create the plot in [图 8-6](#), the distance from the magnet at 24.6 mT is $D \approx 8.2$ mm.

For more accurate results, the lookup table can be calibrated along the movement path of the magnet. Additionally, instead of using the calibrated lookup table for each measurement, consider using a best-fit polynomial equation from the curve for the desired movement range to calculate D in terms of B.

The curve in [图 8-8](#) is not linear; therefore, the achievable accuracy varies for each position along the movement path. The location with the worst accuracy is where there is the smallest change in output for a given amount of movement, which in this example is where the magnet is farthest from the sensor (at 11.5 mm). Determine if the desired accuracy is met by checking if the needed $\%D_{LSB}$ at this location for the specified accuracy is greater than the noise level (PWM jitter) of $0.1\%D$. Thus, with a desired accuracy of 0.1 mm, the needed $\%D_{LSB}$ is the change in $\%D$ between 11.4 mm and 11.5 mm. Using the lookup table to find B and then solving for $\%D$ in [方程式 6](#), at 11.5 mm, $B = 11.815$ mT (which equates to $61.815\%D$), and at 11.4 mm $B = 12.048$ mT (which equates to $62.048\%D$). The difference in $\%D$ between these two points is $62.048 - 61.815 = 0.223\%D_{LSB}$. This value is larger than the $0.1\%D$ jitter, so the desired accuracy can be met as long as a $\%D_{LSB}$ is selected that is equal to or less than 0.223 using [方程式 2](#).

8.3 What to Do and What Not to Do

The Hall element is sensitive to magnetic fields that are perpendicular to the top of the package. Therefore, to correctly detect the magnetic field, make sure to use the correct magnet orientation for the sensor. [图 8-9](#) shows correct and incorrect orientation.



图 8-9. Correct and Incorrect Magnet Orientation

9 Power Supply Recommendations

Use a decoupling capacitor placed close to the device to provide local energy with minimal inductance. Use a ceramic capacitor with a value of at least 0.01 μF .

10 Layout

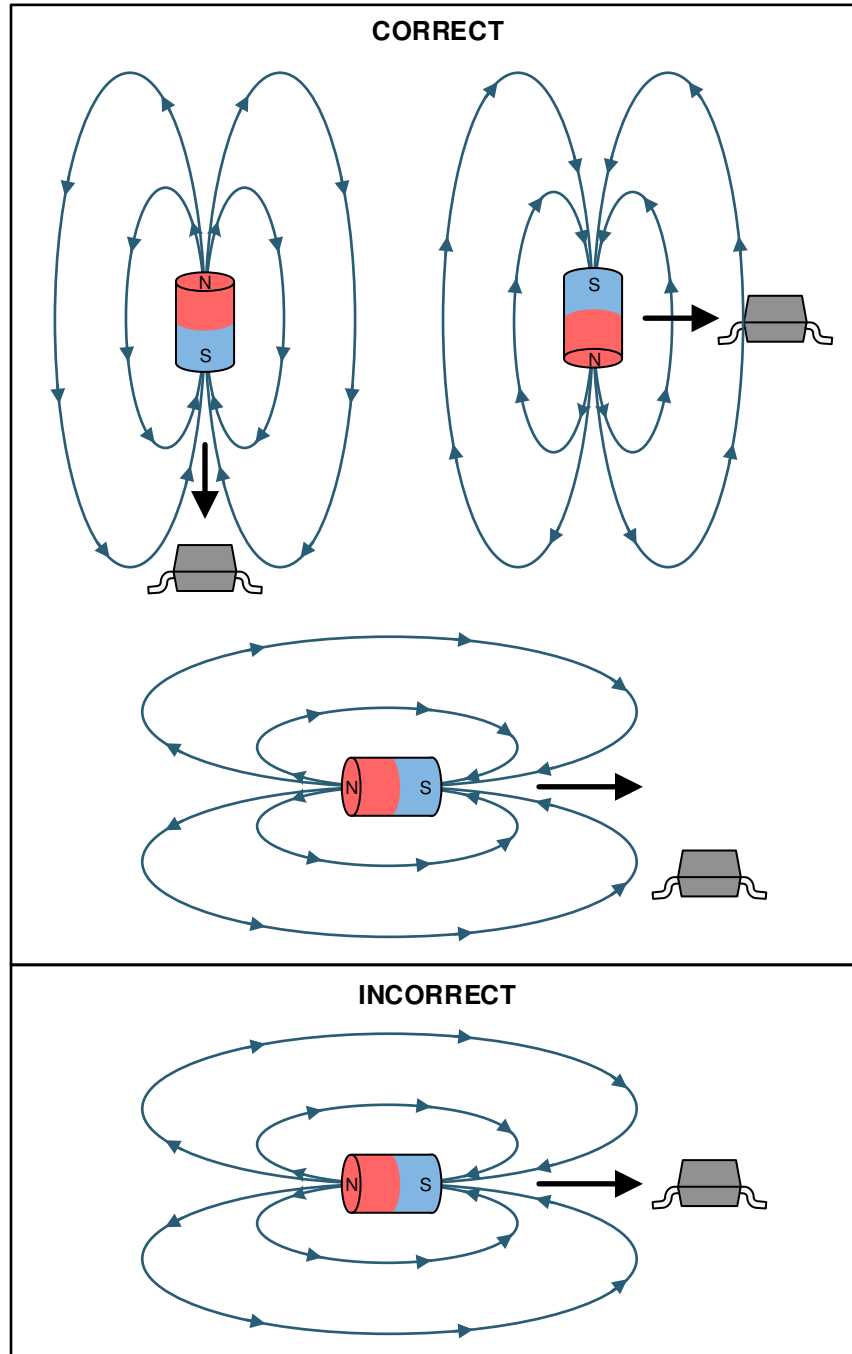
10.1 Layout Guidelines

Magnetic fields pass through most nonferromagnetic materials with no significant disturbance. Embedding Hall effect sensors within plastic or aluminum enclosures and sensing magnets on the outside is common practice. Magnetic fields also easily pass through most printed-circuit boards, which makes placing the magnet on the opposite side possible.

10.2 Layout Examples



图 10-1. Layout Examples

11 Device and Documentation Support

11.1 Documentation Support

11.1.1 Related Documentation

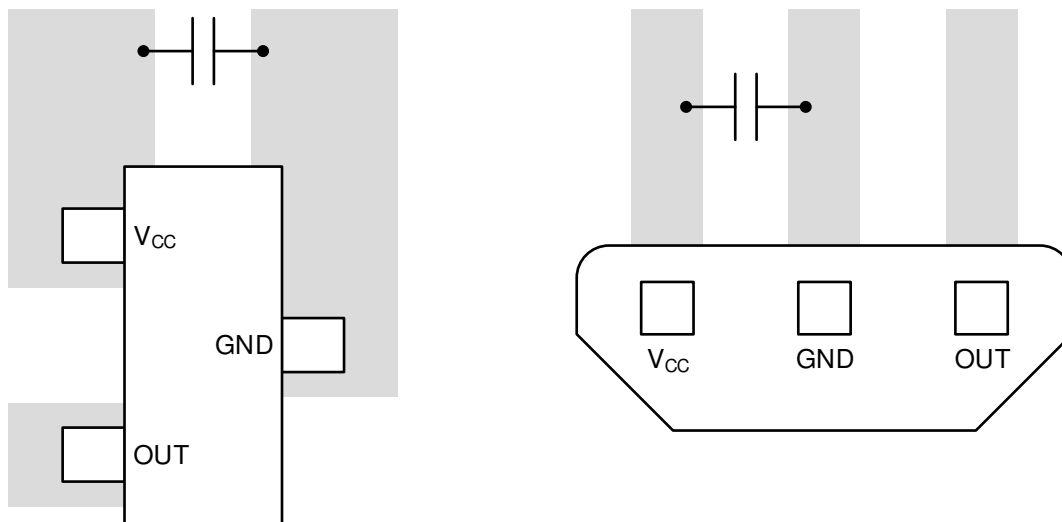
For related documentation see the following:

- Texas Instruments, [Using Linear Hall Effect Sensors to Measure Angle tech note](#)
- Texas Instruments, [Incremental Rotary Encoder Design Considerations tech note](#)
- Texas Instruments, [DRV5055 Ratiometric Linear Hall Effect Sensor data sheet](#)

11.2 接收文档更新通知

要接收文档更新通知，请导航至 ti.com 上的器件产品文件夹。点击 [订阅更新](#) 进行注册，即可每周接收产品信息更改摘要。有关更改的详细信息，请查看任何已修订文档中包含的修订历史记录。

11.3 支持资源

[TI E2E™ 中文支持论坛](#) 是工程师的重要参考资料，可直接从专家处获得快速、经过验证的解答和设计帮助。搜索现有解答或提出自己的问题，获得所需的快速设计帮助。

链接的内容由各个贡献者“按原样”提供。这些内容并不构成 TI 技术规范，并且不一定反映 TI 的观点；请参阅 TI 的 [使用条款](#)。

11.4 Trademarks

TI E2E™ is a trademark of Texas Instruments.

所有商标均为其各自所有者的财产。

11.5 静电放电警告



静电放电 (ESD) 会损坏这个集成电路。德州仪器 (TI) 建议通过适当的预防措施处理所有集成电路。如果不遵守正确的处理和安装程序，可能会损坏集成电路。

ESD 的损坏小至导致微小的性能降级，大至整个器件故障。精密的集成电路可能更容易受到损坏，这是因为非常细微的参数更改都可能会导致器件与其发布的规格不相符。

11.6 术语表

[TI 术语表](#) 本术语表列出并解释了术语、首字母缩略词和定义。

12 Mechanical, Packaging, and Orderable Information

The following pages include mechanical, packaging, and orderable information. This information is the most current data available for the designated devices. This data is subject to change without notice and revision of this document. For browser-based versions of this data sheet, refer to the left-hand navigation.

PACKAGING INFORMATION

Orderable Device	Status (1)	Package Type	Package Drawing	Pins	Package Qty	Eco Plan (2)	Lead finish/ Ball material (6)	MSL Peak Temp (3)	Op Temp (°C)	Device Marking (4/5)	Samples
DRV5057A1QDBZR	ACTIVE	SOT-23	DBZ	3	3000	RoHS & Green	SN	Level-2-260C-1 YEAR	-40 to 125	57A1	Samples
DRV5057A1QDBZT	OBSOLETE	SOT-23	DBZ	3		TBD	Call TI	Call TI	-40 to 125	57A1	
DRV5057A1QLPG	ACTIVE	TO-92	LPG	3	1000	RoHS & Green	SN	N / A for Pkg Type	-40 to 125	57A1	Samples
DRV5057A1QLPGM	ACTIVE	TO-92	LPG	3	3000	RoHS & Green	SN	N / A for Pkg Type	-40 to 125	57A1	Samples
DRV5057A2QDBZR	ACTIVE	SOT-23	DBZ	3	3000	RoHS & Green	SN	Level-2-260C-1 YEAR	-40 to 125	57A2	Samples
DRV5057A2QLPG	ACTIVE	TO-92	LPG	3	1000	RoHS & Green	SN	N / A for Pkg Type	-40 to 125	57A2	Samples
DRV5057A2QLPGM	ACTIVE	TO-92	LPG	3	3000	RoHS & Green	SN	N / A for Pkg Type	-40 to 125	57A2	Samples
DRV5057A3QDBZR	ACTIVE	SOT-23	DBZ	3	3000	RoHS & Green	SN	Level-2-260C-1 YEAR	-40 to 125	57A3	Samples
DRV5057A3QDBZT	OBSOLETE	SOT-23	DBZ	3		TBD	Call TI	Call TI	-40 to 125	57A3	
DRV5057A3QLPG	ACTIVE	TO-92	LPG	3	1000	RoHS & Green	SN	N / A for Pkg Type	-40 to 125	57A3	Samples
DRV5057A3QLPGM	ACTIVE	TO-92	LPG	3	3000	RoHS & Green	SN	N / A for Pkg Type	-40 to 125	57A3	Samples
DRV5057A4QDBZR	ACTIVE	SOT-23	DBZ	3	3000	RoHS & Green	SN	Level-2-260C-1 YEAR	-40 to 125	57A4	Samples
DRV5057A4QDBZT	OBSOLETE	SOT-23	DBZ	3		TBD	Call TI	Call TI	-40 to 125	57A4	
DRV5057A4QLPG	ACTIVE	TO-92	LPG	3	1000	RoHS & Green	SN	N / A for Pkg Type	-40 to 125	57A4	Samples
DRV5057A4QLPGM	ACTIVE	TO-92	LPG	3	3000	RoHS & Green	SN	N / A for Pkg Type	-40 to 125	57A4	Samples
DRV5057Z1QDBZR	ACTIVE	SOT-23	DBZ	3	3000	RoHS & Green	SN	Level-2-260C-1 YEAR	-40 to 125	57Z1	Samples
DRV5057Z2QDBZR	ACTIVE	SOT-23	DBZ	3	3000	RoHS & Green	SN	Level-2-260C-1 YEAR	-40 to 125	57Z2	Samples
DRV5057Z2QDBZT	OBSOLETE	SOT-23	DBZ	3		TBD	Call TI	Call TI	-40 to 125	57Z2	
DRV5057Z3QDBZR	ACTIVE	SOT-23	DBZ	3	3000	RoHS & Green	SN	Level-2-260C-1 YEAR	-40 to 125	57Z3	Samples
DRV5057Z3QDBZT	OBSOLETE	SOT-23	DBZ	3		TBD	Call TI	Call TI	-40 to 125	57Z3	
DRV5057Z4QDBZR	ACTIVE	SOT-23	DBZ	3	3000	RoHS & Green	SN	Level-2-260C-1 YEAR	-40 to 125	57Z4	Samples
DRV5057Z4QDBZT	OBSOLETE	SOT-23	DBZ	3		TBD	Call TI	Call TI	-40 to 125	57Z4	

(1) The marketing status values are defined as follows:

ACTIVE: Product device recommended for new designs.

LIFEBUY: TI has announced that the device will be discontinued, and a lifetime-buy period is in effect.

NRND: Not recommended for new designs. Device is in production to support existing customers, but TI does not recommend using this part in a new design.

PREVIEW: Device has been announced but is not in production. Samples may or may not be available.

OBSOLETE: TI has discontinued the production of the device.

(2) **RoHS:** TI defines "RoHS" to mean semiconductor products that are compliant with the current EU RoHS requirements for all 10 RoHS substances, including the requirement that RoHS substance do not exceed 0.1% by weight in homogeneous materials. Where designed to be soldered at high temperatures, "RoHS" products are suitable for use in specified lead-free processes. TI may reference these types of products as "Pb-Free".

RoHS Exempt: TI defines "RoHS Exempt" to mean products that contain lead but are compliant with EU RoHS pursuant to a specific EU RoHS exemption.

Green: TI defines "Green" to mean the content of Chlorine (Cl) and Bromine (Br) based flame retardants meet JS709B low halogen requirements of ≤ 1000 ppm threshold. Antimony trioxide based flame retardants must also meet the ≤ 1000 ppm threshold requirement.

(3) MSL, Peak Temp. - The Moisture Sensitivity Level rating according to the JEDEC industry standard classifications, and peak solder temperature.

(4) There may be additional marking, which relates to the logo, the lot trace code information, or the environmental category on the device.

(5) Multiple Device Markings will be inside parentheses. Only one Device Marking contained in parentheses and separated by a "~" will appear on a device. If a line is indented then it is a continuation of the previous line and the two combined represent the entire Device Marking for that device.

(6) Lead finish/Ball material - Orderable Devices may have multiple material finish options. Finish options are separated by a vertical ruled line. Lead finish/Ball material values may wrap to two lines if the finish value exceeds the maximum column width.

Important Information and Disclaimer: The information provided on this page represents TI's knowledge and belief as of the date that it is provided. TI bases its knowledge and belief on information provided by third parties, and makes no representation or warranty as to the accuracy of such information. Efforts are underway to better integrate information from third parties. TI has taken and continues to take reasonable steps to provide representative and accurate information but may not have conducted destructive testing or chemical analysis on incoming materials and chemicals. TI and TI suppliers consider certain information to be proprietary, and thus CAS numbers and other limited information may not be available for release.

In no event shall TI's liability arising out of such information exceed the total purchase price of the TI part(s) at issue in this document sold by TI to Customer on an annual basis.

OTHER QUALIFIED VERSIONS OF DRV5057 :

- Automotive : [DRV5057-Q1](#)

NOTE: Qualified Version Definitions:

- Automotive - Q100 devices qualified for high-reliability automotive applications targeting zero defects

TAPE AND REEL INFORMATION

QUADRANT ASSIGNMENTS FOR PIN 1 ORIENTATION IN TAPE

*All dimensions are nominal

Device	Package Type	Package Drawing	Pins	SPQ	Reel Diameter (mm)	Reel Width W1 (mm)	A0 (mm)	B0 (mm)	K0 (mm)	P1 (mm)	W (mm)	Pin1 Quadrant
DRV5057A1QDBZR	SOT-23	DBZ	3	3000	180.0	8.4	3.2	2.85	1.3	4.0	8.0	Q3
DRV5057A2QDBZR	SOT-23	DBZ	3	3000	180.0	8.4	3.2	2.85	1.3	4.0	8.0	Q3
DRV5057A3QDBZR	SOT-23	DBZ	3	3000	180.0	8.4	3.2	2.85	1.3	4.0	8.0	Q3
DRV5057A4QDBZR	SOT-23	DBZ	3	3000	180.0	8.4	3.2	2.85	1.3	4.0	8.0	Q3
DRV5057Z1QDBZR	SOT-23	DBZ	3	3000	180.0	8.4	3.2	2.85	1.3	4.0	8.0	Q3
DRV5057Z2QDBZR	SOT-23	DBZ	3	3000	180.0	8.4	3.2	2.85	1.3	4.0	8.0	Q3
DRV5057Z3QDBZR	SOT-23	DBZ	3	3000	180.0	8.4	3.2	2.85	1.3	4.0	8.0	Q3
DRV5057Z4QDBZR	SOT-23	DBZ	3	3000	180.0	8.4	3.2	2.85	1.3	4.0	8.0	Q3

TAPE AND REEL BOX DIMENSIONS

*All dimensions are nominal

Device	Package Type	Package Drawing	Pins	SPQ	Length (mm)	Width (mm)	Height (mm)
DRV5057A1QDBZR	SOT-23	DBZ	3	3000	210.0	185.0	35.0
DRV5057A2QDBZR	SOT-23	DBZ	3	3000	210.0	185.0	35.0
DRV5057A3QDBZR	SOT-23	DBZ	3	3000	210.0	185.0	35.0
DRV5057A4QDBZR	SOT-23	DBZ	3	3000	210.0	185.0	35.0
DRV5057Z1QDBZR	SOT-23	DBZ	3	3000	210.0	185.0	35.0
DRV5057Z2QDBZR	SOT-23	DBZ	3	3000	210.0	185.0	35.0
DRV5057Z3QDBZR	SOT-23	DBZ	3	3000	210.0	185.0	35.0
DRV5057Z4QDBZR	SOT-23	DBZ	3	3000	210.0	185.0	35.0

LPG0003A



PACKAGE OUTLINE

TO-92 - 5.05 mm max height

TRANSISTOR OUTLINE

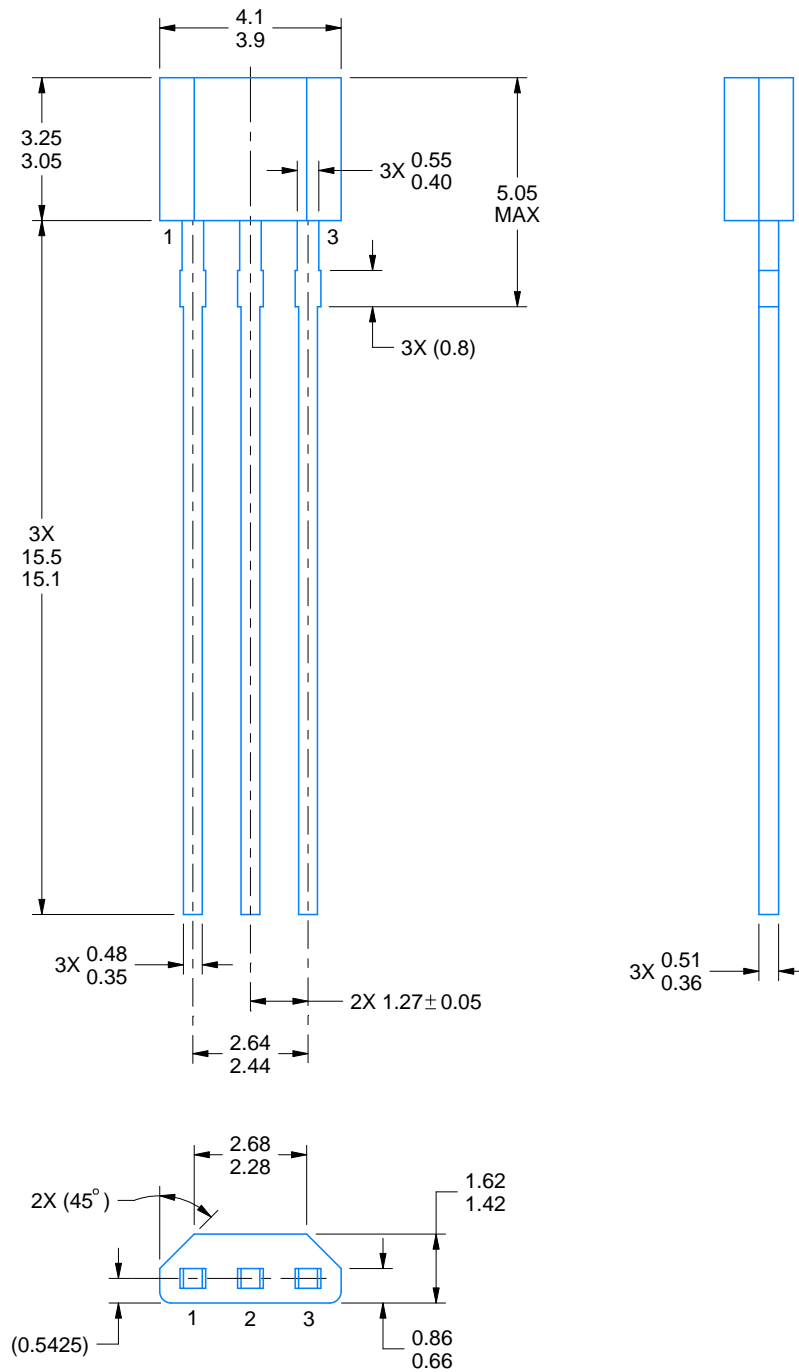

4221343/C 01/2018

NOTES:

1. All linear dimensions are in millimeters. Any dimensions in parenthesis are for reference only. Dimensioning and tolerancing per ASME Y14.5M.
2. This drawing is subject to change without notice.

EXAMPLE BOARD LAYOUT

LPG0003A

TO-92 - 5.05 mm max height

TRANSISTOR OUTLINE

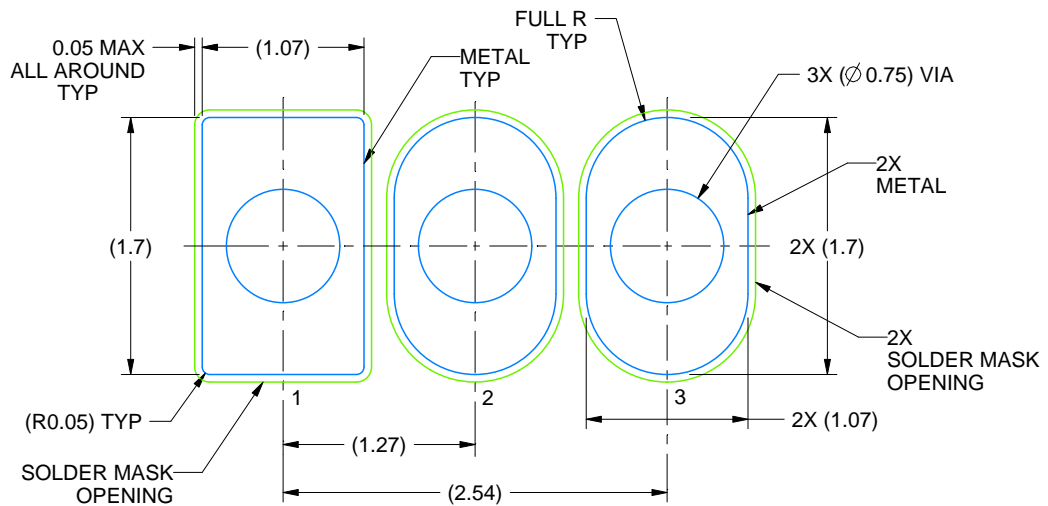

LAND PATTERN EXAMPLE
NON-SOLDER MASK DEFINED
SCALE:20X

4221343/C 01/2018

TAPE SPECIFICATIONS

LPG0003A

TO-92 - 5.05 mm max height

TRANSISTOR OUTLINE

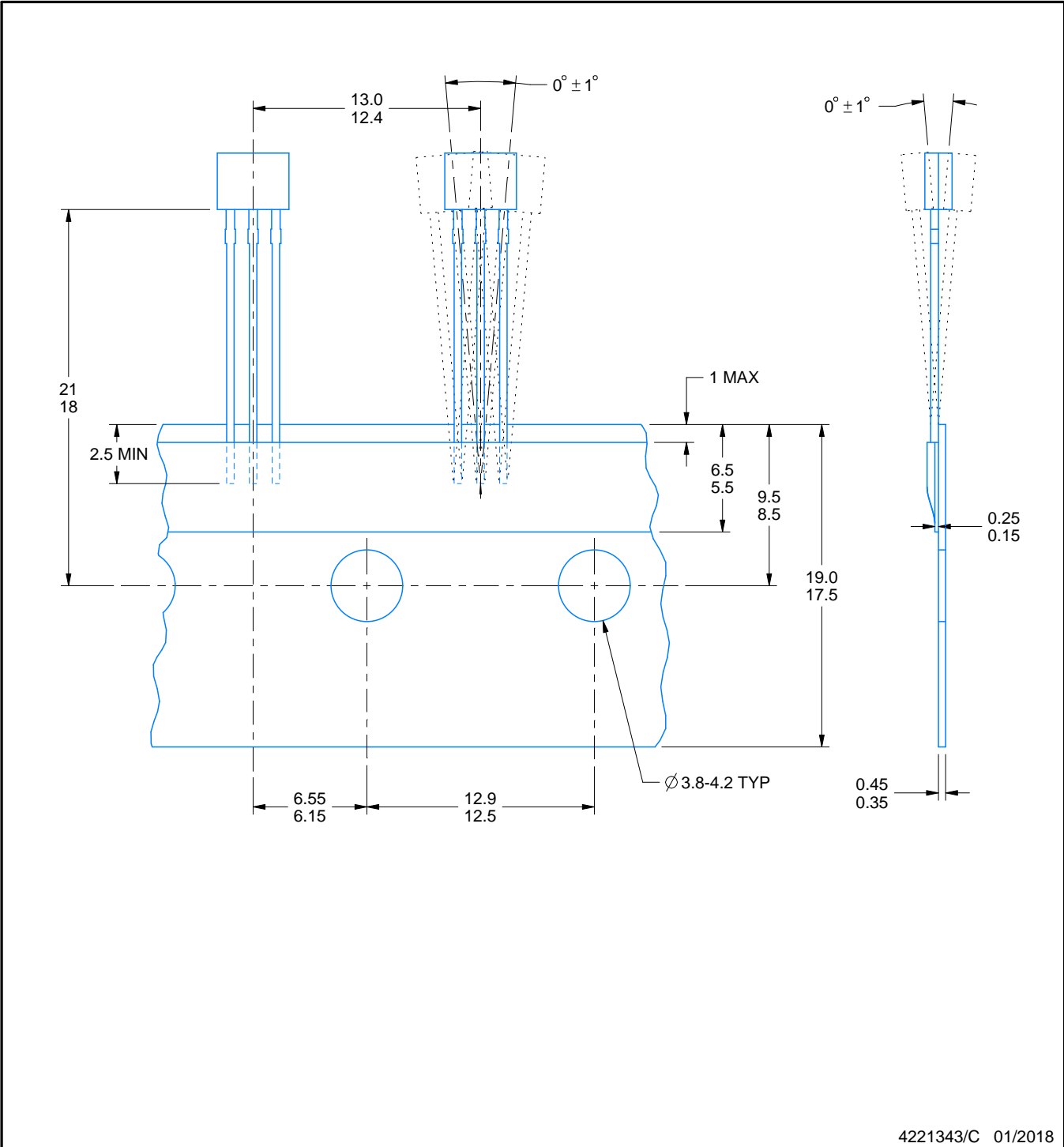

DBZ0003A



PACKAGE OUTLINE

SOT-23 - 1.12 mm max height

SMALL OUTLINE TRANSISTOR

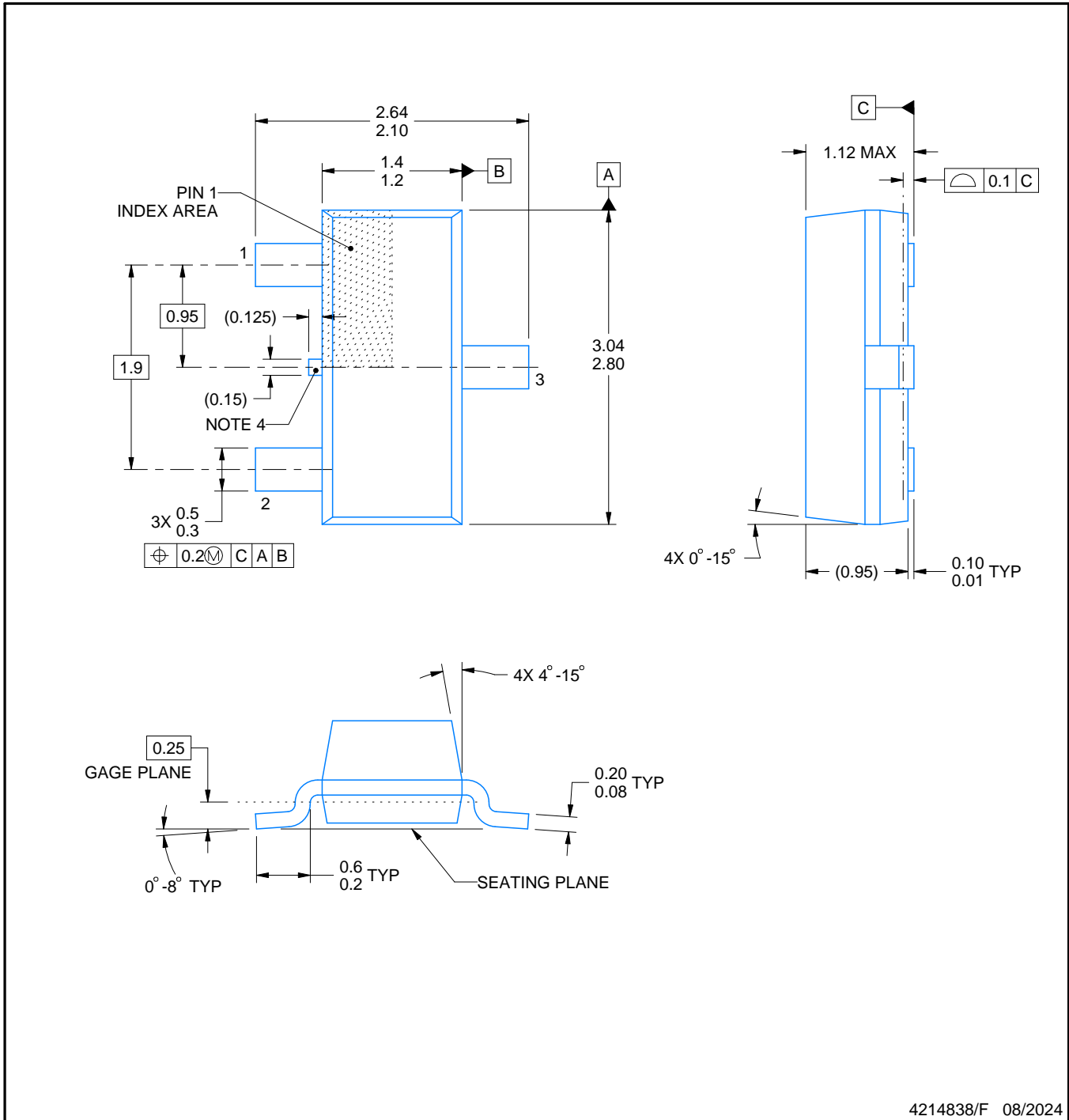

4214838/F 08/2024

NOTES:

1. All linear dimensions are in millimeters. Any dimensions in parenthesis are for reference only. Dimensioning and tolerancing per ASME Y14.5M.
2. This drawing is subject to change without notice.
3. Reference JEDEC registration TO-236, except minimum foot length.
4. Support pin may differ or may not be present.
5. Body dimensions do not include mold flash, protrusions, or gate burrs. Mold flash, protrusions, or gate burrs shall not exceed 0.25mm per side

EXAMPLE BOARD LAYOUT

DBZ0003A

SOT-23 - 1.12 mm max height

SMALL OUTLINE TRANSISTOR



LAND PATTERN EXAMPLE
SCALE:15X



SOLDER MASK DETAILS

4214838/F 08/2024

NOTES: (continued)

5. Publication IPC-7351 may have alternate designs.
6. Solder mask tolerances between and around signal pads can vary based on board fabrication site.

EXAMPLE STENCIL DESIGN

DBZ0003A

SOT-23 - 1.12 mm max height

SMALL OUTLINE TRANSISTOR



SOLDER PASTE EXAMPLE
BASED ON 0.125 THICK STENCIL
SCALE:15X

4214838/F 08/2024

NOTES: (continued)

7. Laser cutting apertures with trapezoidal walls and rounded corners may offer better paste release. IPC-7525 may have alternate design recommendations.
8. Board assembly site may have different recommendations for stencil design.

重要声明和免责声明

TI“按原样”提供技术和可靠性数据（包括数据表）、设计资源（包括参考设计）、应用或其他设计建议、网络工具、安全信息和其他资源，不保证没有瑕疵且不做任何明示或暗示的担保，包括但不限于对适销性、某特定用途方面的适用性或不侵犯任何第三方知识产权的暗示担保。

这些资源可供使用 TI 产品进行设计的熟练开发人员使用。您将自行承担以下全部责任：(1) 针对您的应用选择合适的 TI 产品，(2) 设计、验证并测试您的应用，(3) 确保您的应用满足相应标准以及任何其他功能安全、信息安全、监管或其他要求。

这些资源如有变更，恕不另行通知。TI 授权您仅可将这些资源用于研发本资源所述的 TI 产品的应用。严禁对这些资源进行其他复制或展示。您无权使用任何其他 TI 知识产权或任何第三方知识产权。您应全额赔偿因在这些资源的使用中对 TI 及其代表造成的任何索赔、损害、成本、损失和债务，TI 对此概不负责。

TI 提供的产品受 [TI 的销售条款](#) 或 [ti.com](#) 上其他适用条款/TI 产品随附的其他适用条款的约束。TI 提供这些资源并不会扩展或以其他方式更改 TI 针对 TI 产品发布的适用的担保或担保免责声明。

TI 反对并拒绝您可能提出的任何其他或不同的条款。

邮寄地址：Texas Instruments, Post Office Box 655303, Dallas, Texas 75265

Copyright © 2024，德州仪器 (TI) 公司