

DS90LV028A-Q1 汽车类 LVDS 双路差动线路接收器

1 特性

- 符合面向汽车应用的 AEC-Q100 标准
 - 温度等级 2 : -40°C 至 +105°C
- >400Mbps (200MHz) 的开关速率
- 50ps 差分延迟 (典型值)
- 0.1ns 通道间延迟 (典型值)
- 2.5ns 最大传播延迟
- 3.3V 电源设计
- 直通引脚排列
- 在断电模式下, LVDS 输入端具有高阻抗
- 低功耗设计 (3.3V 静态条件下为 18mW)
- LVDS 输入可接受 LVDS/CML/LVPECL 信号
- 符合 ANSI/TIA/EIA-644 标准

2 应用

- 电子销售终端 (EPOS) 应用
- 汽车信息娱乐系统与仪表盘
- 汽车音响主机

3 说明

DS90LV028A-Q1 是一款双路 CMOS 差分线路接收器, 专为需要超低功率损耗、低噪声和高数据速率的应用而设计。该器件旨在利用低电压差动信号 (LVDS) 技术支持超过 400Mbps (200MHz) 的数据速率。

DS90LV028A-Q1 可接受低电压 (350mV 典型值) 差分输入信号, 并将其转换为 3V CMOS 输出电平。DS90LV028A-Q1 采用了直通式设计, 可简化 PCB 布局。

DS90LV028A-Q1 和配套的 LVDS 线路驱动器 DS90LV027AQ 为高速点对点接口应用提供了高功率 PECL/ECL 器件的全新替代方案。

器件信息⁽¹⁾

器件型号	封装	封装尺寸 (标称值)
DS90LV028A-Q1	WSON (DQF 8)	2.00mm x 2.00mm

(1) 如需了解所有可用封装, 请参阅数据表末尾的可订购产品附录。

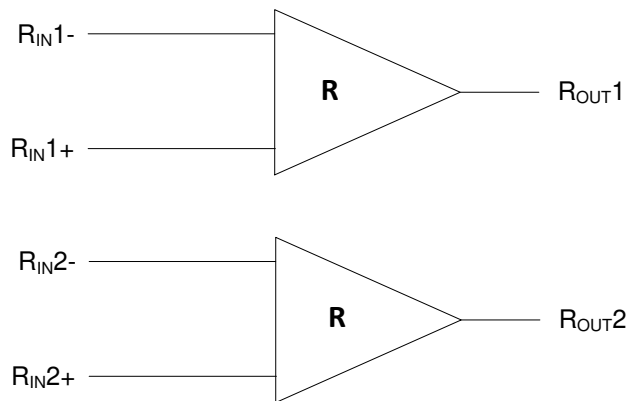

功能图



Table of Contents

1 特性	1	8.2 Functional Block Diagram.....	10
2 应用	1	8.3 Feature Description.....	10
3 说明	1	8.4 Device Functional Modes.....	10
4 Revision History	2	9 Application and Implementation	11
5 Pin Configuration and Functions	3	9.1 Application Information.....	11
Pin Functions.....	3	9.2 Typical Application.....	11
6 Specifications	4	10 Power Supply Recommendations	13
6.1 Absolute Maximum Ratings.....	4	11 Layout	14
6.2 ESD and Latch-Up Ratings.....	4	11.1 Layout Guidelines.....	14
6.3 Recommended Operating Conditions.....	4	11.2 Layout Examples.....	14
6.4 Thermal Information.....	4	12 Device and Documentation Support	15
6.5 Electrical Characteristics.....	5	12.1 支持资源.....	15
6.6 Switching Characteristics.....	5	12.2 Trademarks.....	15
6.7 Typical Performance Curves.....	6	12.3 静电放电警告.....	15
7 Parameter Measurement Information	9	12.4 术语表.....	15
8 Detailed Description	10	13 Mechanical, Packaging, and Orderable Information	16
8.1 Overview.....	10		

4 Revision History

注：以前版本的页码可能与当前版本的页码不同

DATE	REVISION	NOTES
August 2020	*	Initial Release

5 Pin Configuration and Functions



图 5-1. DQF Package WSON 8 Pin Top View

Pin Functions

Pin Number	Name	Description
1	R_{IN1-}	Inverting receiver input pin
4	R_{IN2-}	
2	R_{IN1+}	Non-inverting receiver input pin
3	R_{IN2+}	
6	R_{OUT2}	Receiver output pin
7	R_{OUT1}	
8	V_{CC}	Power supply pin, +3.3V +/- 0.3V
5	GND	Ground pin

6 Specifications

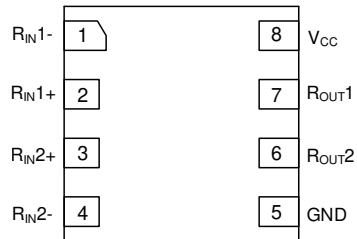
6.1 Absolute Maximum Ratings

		MIN	MAX	UNIT
Supply Voltage (V_{CC})		-0.3	4	V
Input Voltage (R_{IN+} , R_{IN-})		-0.3	3.9	V
Output Voltage (R_{OUT})		-0.3	$V_{CC}+0.3$	V
Lead Temperature Range Soldering	(4 sec.)		260	°C
Maximum Junction Temperature			125	°C
Storage temperature, T_{stg}		-65	150	°C

6.2 ESD and Latch-Up Ratings

			VALUE	UNIT
$V_{(ESD)}$	Electrostatic discharge	Human-body model (HBM), per ANSI/ESDA/JEDEC JS-001 ⁽¹⁾	±4000	V
		Charged-device model (CDM), per JEDEC specification JESD22-C101 ⁽²⁾	±1250	
I-Test+	Positive I-Test Latch-Up	Positive I-Test Latchup, per AEC Q100-004 at maximum ambient temperature (all signal pins)	+100	mA
I-Test-	Negative I-Test Latch-Up	Negative I-Test Latchup, per AEC Q100-004 at maximum ambient temperature (all signal pins except pin 3)	-100	mA
		Negative I-Test Latchup, per AEC Q100-004 at maximum ambient temperature (pin 3)	-70	mA

(1) JEDEC document JEP155 states that 500-V HBM allows safe manufacturing with a standard ESD control process.

(2) JEDEC document JEP157 states that 250-V CDM allows safe manufacturing with a standard ESD control process.

6.3 Recommended Operating Conditions

	Min	Typ	Max	Units
Supply Voltage (V_{CC})	+3.0	+3.3	+3.6	V
Receiver Input Voltage	+0.5		+2.1	V
Operating Free Air Temperature (T_A)	-40	25	105	°C

6.4 Thermal Information

THERMAL METRIC ⁽¹⁾		DS90LV028A-Q1	UNIT
		DQF (WSON)	
		8 PINS	
$R_{\theta JA}$	Junction-to-ambient thermal resistance	104.0	°C/W
$R_{\theta JC(bot)}$	Junction-to-case (bottom) thermal resistance	33.3	°C/W
$R_{\theta JB}$	Junction-to-board thermal resistance	27.6	°C/W
ψ_{JT}	Junction-to-top characterization parameter	0.3	°C/W
ψ_{JB}	Junction-to-board characterization parameter	27.4	°C/W

(1) For more information about traditional and new thermal metrics, see the [Semiconductor and IC Package Thermal Metrics](#) application report.

6.5 Electrical Characteristics

Over Supply Voltage and Operating Temperature ranges, unless otherwise specified. ⁽¹⁾ ⁽²⁾

Symbol	Parameter	Conditions	Pin	Min	Typ	Max	Units
V _{TH}	Differential Input High Threshold	V _{CM} ⁽¹⁾ = +1.2 V, 0.5 + (V _{ID} /2) V, 2.1 - (V _{ID} /2) ⁽²⁾	R _{IN+} , R _{IN-}			+100	mV
V _{TL}	Differential Input Low Threshold			-100			mV
I _{IN}	Input Current	V _{IN} = +2.8V	V _{CC} = 3.6V or 0V	-10	±1	+10	µA
		V _{IN} = 0V		-10	±1	+10	µA
		V _{IN} = +3.6V		-20		+20	µA
V _{OH}	Output High Voltage	I _{OH} = -0.4 mA, V _{ID} ⁽²⁾ = +200 mV	R _{OUT}	2.7	3.1		V
V _{OL}	Output Low Voltage	I _{OL} = 2 mA, V _{ID} ⁽²⁾ = -200 mV			0.3	0.5	V
I _{OS}	Output Short Circuit Current	V _{OUT} = 0V ⁽³⁾		-100	-50	-15	mA
V _{CL}	Input Clamp Voltage	I _{CL} = -18 mA		-1.5	-0.8		V
I _{CC}	No Load Supply Current	V _{ID} ⁽²⁾ = +200 mV or -200mV	V _{CC}		5.4	9	mA

(1) V_{CM} is input common mode voltage $|(V_{RIN+} + V_{RIN-})/2|$

(2) V_{ID} is input differential voltage $(V_{RIN+} - V_{RIN-})$

6.6 Switching Characteristics

Over Supply Voltage and Operating Temperature ranges, unless otherwise specified. ⁽²⁾ ⁽⁴⁾ ⁽⁵⁾

Symbol	Parameter	Conditions	Min	Typ	Max	Units
t _{PHLD}	Differential Propagation Delay High to Low	C _L = 15 pF	1.0	1.6	2.5	ns
t _{PLHD}	Differential Propagation Delay Low to High	V _{ID} = 200 mV	1.0	1.7	2.5	ns
t _{SKD1}	Differential Pulse Skew t _{PHLD} - t _{PLHD} ⁽⁶⁾	(图 7-1 and 图 7-2)	0	50	650	ps
t _{SKD2}	Differential Channel-to-Channel Skew-same device ⁽⁷⁾		0	0.1	0.5	ns
t _{SKD3}	Differential Part to Part Skew ⁽⁸⁾		0		1.0	ns
t _{SKD4}	Differential Part to Part Skew ⁽⁹⁾		0		1.5	ns
t _{TLH}	Rise Time			325	800	ps
t _{THL}	Fall Time			225	800	ps
f _{MAX}	Maximum Operating Frequency ⁽¹⁰⁾			250		MHz

(1) Current into device pins is defined as positive. Current out of device pins is defined as negative. All voltages are referenced to ground unless otherwise specified (such as V_{ID}).

(2) All typicals are given for: V_{CC} = +3.3V and T_A = +25°C.

(3) Output short circuit current (I_{OS}) is specified as magnitude only, minus sign indicates direction only. Only one output should be shorted at a time, do not exceed maximum junction temperature specification.

(4) C_L includes probe and jig capacitance.

(5) Generator waveform for all tests unless otherwise specified: f = 1 MHz, Z_O = 50 Ω, t_r and t_f (0% to 100%) ≤ 3 ns for R_{IN}.

(6) t_{SKD1} is the magnitude difference in differential propagation delay time between the positive-going-edge and the negative-going-edge of the same channel.

(7) t_{SKD2} is the differential channel-to-channel skew of any event on the same device. This specification applies to devices having multiple receivers within the integrated circuit.

(8) t_{SKD3}, part to part skew, is the differential channel-to-channel skew of any event between devices. This specification applies to devices at the same V_{CC} and within 5°C of each other within the operating temperature range.

(9) t_{SKD4}, part to part skew, is the differential channel-to-channel skew of any event between devices. This specification applies to devices over the recommended operating temperature and voltage ranges, and across process distribution. t_{SKD4} is defined as |Max - Min| differential propagation delay.

(10) f_{MAX} generator input conditions: t_r = t_f < 1 ns (0% to 100%), 50% duty cycle, differential (1.05V to 1.35 peak to peak). Output criteria: 60%/40% duty cycle, V_{OL} (max 0.4V), V_{OH} (min 2.7V), load = 15 pF (stray plus probes).

6.7 Typical Performance Curves



图 6-1. Output High Voltage vs Power Supply Voltage



图 6-2. Output Low Voltage vs Power Supply Voltage

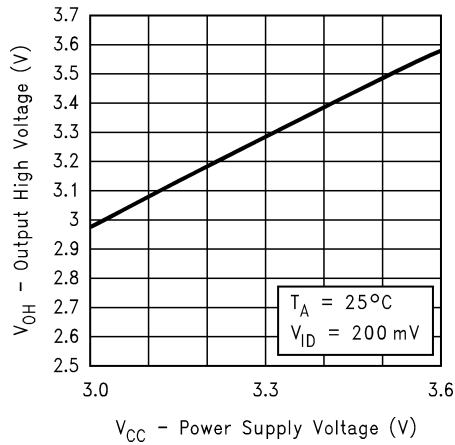

图 6-3. Output Short Circuit Current vs Power Supply Voltage

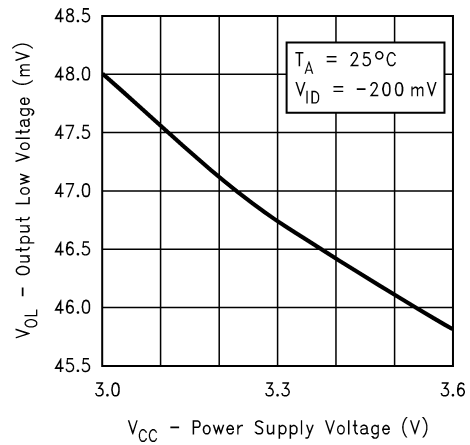

图 6-4. Differential Transition Voltage vs Power Supply Voltage

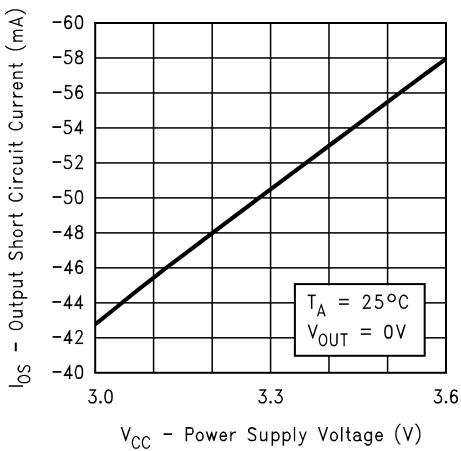

图 6-5. Differential Propagation Delay vs Power Supply Voltage

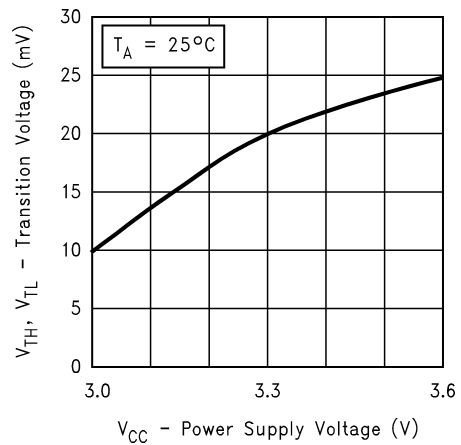

图 6-6. Differential Propagation Delay vs Differential Input Voltage

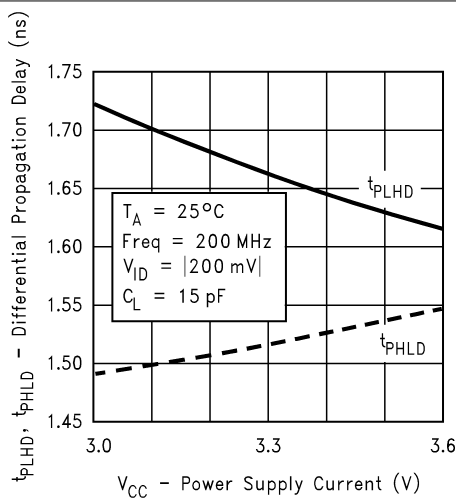

图 6-7. Differential Propagation Delay vs Common-Mode Voltage

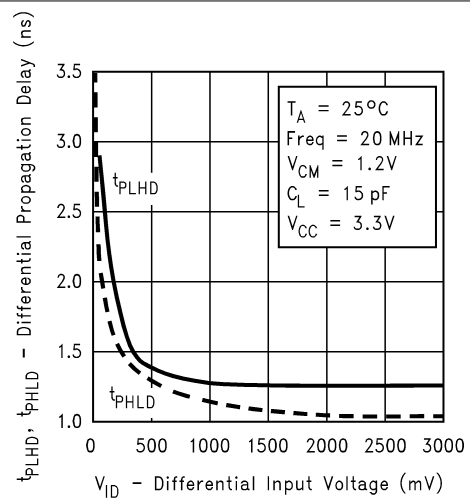

图 6-8. Transition Time vs Power Supply Voltage

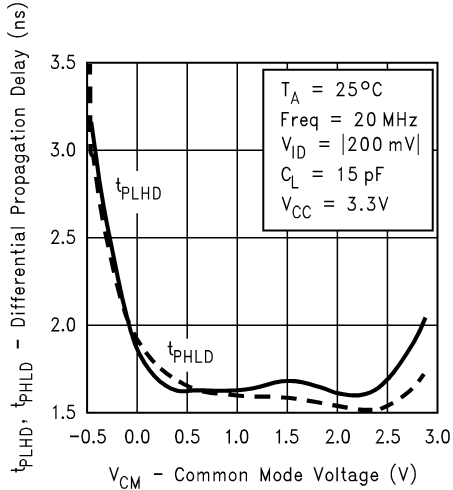

图 6-9. Differential Skew vs Power Supply Voltage

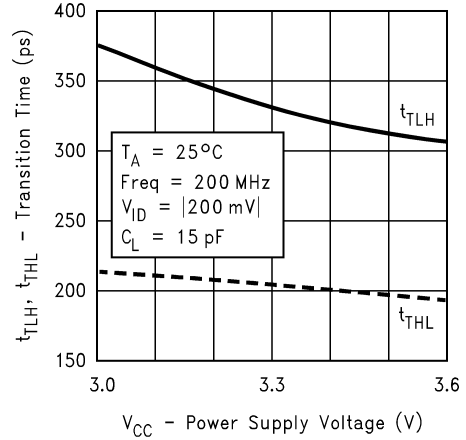

图 6-10. Differential Propagation Delay vs Load

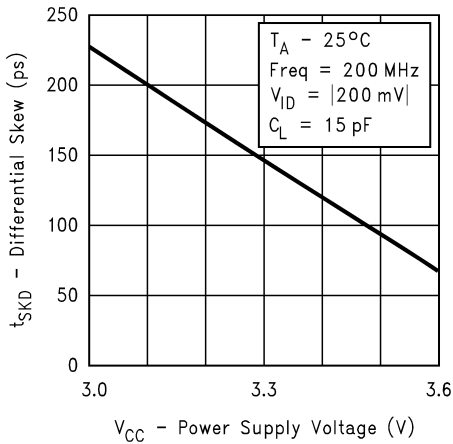

图 6-11. Differential Propagation Delay vs Load

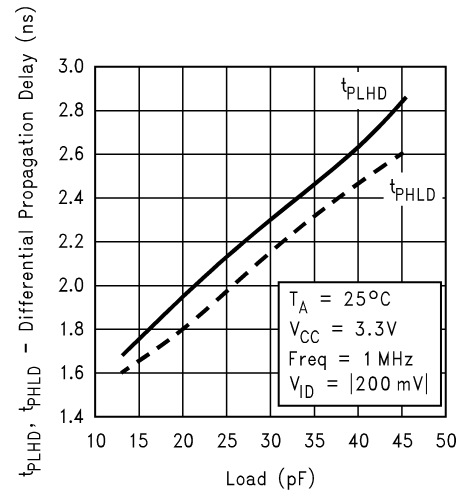

图 6-12. Transition Time vs Load

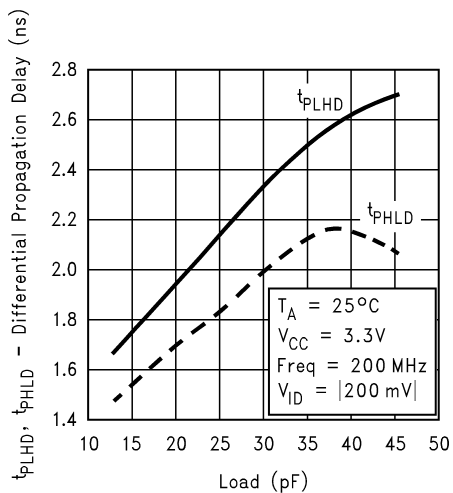

6-13. Transition Time vs Load

7 Parameter Measurement Information

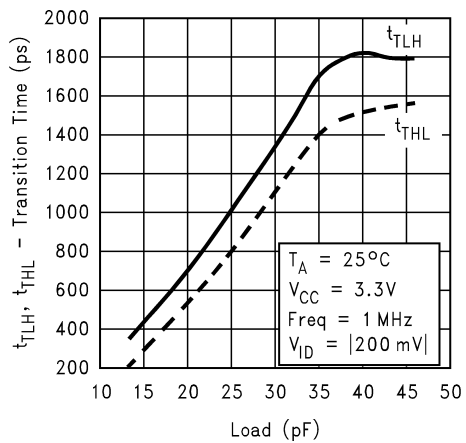
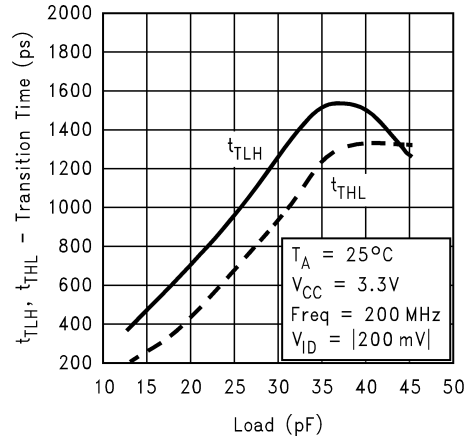

图 7-1. Receiver Propagation Delay and Transition Time Test Circuit



图 7-2. Receiver Propagation Delay and Transition Time Waveforms

8 Detailed Description

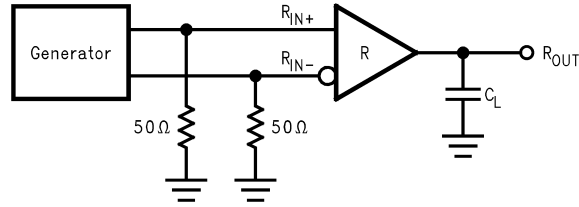
8.1 Overview

LVDS drivers and receivers are intended to be primarily used in a simple point-to-point configuration as is shown in [图 9-1](#). This configuration provides a clean signaling environment for the fast edge rates of the drivers. The receiver is connected to the source through a impedance controlled 100 Ω differential PCB traces. A termination resistor of 100 Ω should be used, and is located as close to the receiver input pins as possible. The termination resistor converts the driver output (current mode) into a voltage that is detected by the receiver.

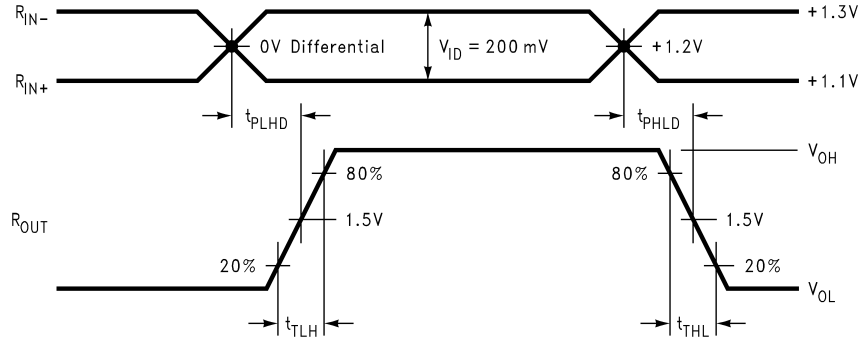
8.2 Functional Block Diagram

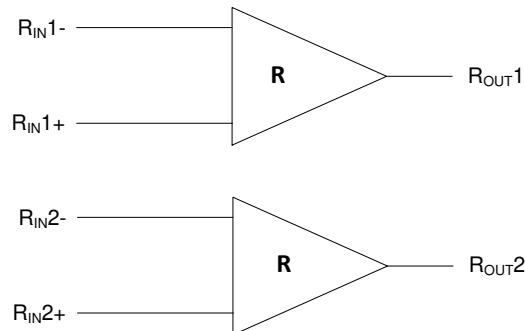

8.3 Feature Description

The DS90LV028A-Q1 differential line receiver is capable of detecting signals as low as 100 mV, over a common-mode range of $0.5 + (V_{ID}/2)$ V to $2.1 - (V_{ID}/2)$ V. This is related to the driver offset voltage which is typically +1.2V. The driven signal is centered around this voltage and may shift ± 0.5 V around this center point. The ± 0.5 V shifting may be the result of a ground potential difference between the driver's ground reference and the receiver's ground reference, the common-mode effects of coupled noise, or a combination of the two. The AC parameters of both receiver input pins are optimized for a recommended operating input voltage range of +0.5V to +2.1V (measured from each pin to ground). The device will operate for receiver input voltages up to V_{CC} , but exceeding V_{CC} will turn on the ESD protection circuitry which will clamp the bus voltages.

8.4 Device Functional Modes

表 8-1. Truth Table

INPUTS	OUTPUT
$[R_{IN+}] - [R_{IN-}]$	R_{OUT}
$V_{ID} \geq 0.1V$	H
$V_{ID} \leq -0.1V$	L
$-0.1V \leq V_{ID} \leq 0.1V$? ⁽¹⁾

(1) ? indicates state is indeterminate

9 Application and Implementation

备注

Information in the following applications sections is not part of the TI component specification, and TI does not warrant its accuracy or completeness. TI's customers are responsible for determining suitability of components for their purposes. Customers should validate and test their design implementation to confirm system functionality.

9.1 Application Information

General application guidelines and hints for LVDS drivers and receivers may be found in the [LVDS application notes and design guides](#).

9.2 Typical Application



图 9-1. Balanced System Point-to-Point Application

9.2.1 Design Requirements

When using LVDS devices, it is important to remember to specify controlled impedance PCB traces. All components of the transmission media must have a matched differential impedance of 100 Ω . They must not introduce major impedance discontinuities.

9.2.2 Detailed Design Procedure

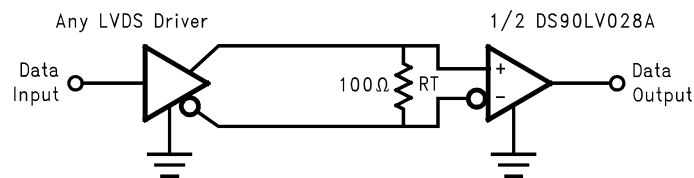
9.2.2.1 Power Decoupling Recommendations

Bypass capacitors must be used on power pins. Use high frequency ceramic (surface mount is recommended) 0.1 μ F and 0.01 μ F capacitors in parallel at the power supply pin with the smallest value capacitor closest to the device supply pin. Additional scattered capacitors over the printed circuit board will improve decoupling. Multiple vias should be used to connect the decoupling capacitors to the power planes. A 10 μ F (35 V) or greater solid tantalum capacitor should be connected at the power entry point on the printed circuit board between the supply and ground.

9.2.2.2 Termination

Use a termination resistor which best matches the differential impedance or your transmission line. The resistor should be between 90 Ω and 110 Ω . Remember that the current mode outputs need the termination resistor to generate the differential voltage. LVDS will not work correctly without resistor termination. Typically, connecting a single resistor across the pair at the receiver end will suffice.

Surface mount 1% resistors are the best. PCB stubs, component lead, and the distance from the termination to the receiver inputs should be minimized. The distance between the termination resistor and the receiver should be < 10 mm (12 mm MAX).

9.2.2.3 Input Failsafe Biasing

External pull up and pull down resistors may be used to provide enough of an offset to enable an input failsafe under open-circuit conditions. This configuration ties the positive LVDS input pin to VDD thru a pull up resistor and the negative LVDS input pin is tied to GND by a pull down resistor. The pull up and pull down resistors should be in the 5 k Ω to 15 k Ω range to minimize loading and waveform distortion to the driver. The common-mode bias point ideally should be set to approximately 1.2 V to be compatible with the internal circuitry. Please refer to application note AN-1194, "Failsafe Biasing of LVDS Interfaces" ([SNLA051](#)) for more information.

9.2.2.4 Probing LVDS Transmission Lines

Always use high impedance ($> 100\text{ k}\Omega$), low capacitance ($< 2\text{ pF}$) scope probes with a wide bandwidth (1 GHz) scope. Improper probing will give deceiving results.

9.2.3 Application Curves



图 9-2. Power Supply Current vs Frequency

10 Power Supply Recommendations

Bypass capacitors must be used on power pins. TI recommends using high-frequency, ceramic, 0.1- μ F and 0.01- μ F capacitors in parallel at the power supply pin with the smallest value capacitor closest to the device supply pin. Additional scattered capacitors over the printed-circuit board improves decoupling. Multiple vias must be used to connect the decoupling capacitors to the power planes. A 10- μ F bulk capacitor, 35-V (or greater) solid tantalum capacitor must be connected at the power entry point on the printed-circuit board between the supply and ground.

11 Layout

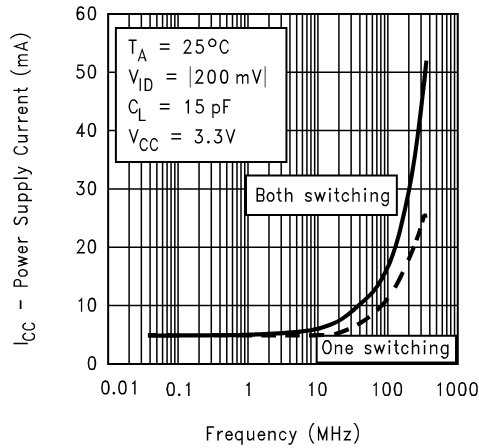
11.1 Layout Guidelines

11.1.1 Differential Traces

Use controlled impedance traces which match the differential impedance of your transmission trace and termination resistor. Run the differential pair trace lines as close together as possible as soon as they leave the IC (stubs should be < 10mm long). This will help eliminate reflections and ensure noise is coupled as common-mode. In fact, we have seen that differential signals which are 1mm apart radiate far less noise than traces 3mm apart since magnetic field cancellation is much better with the closer traces. In addition, noise induced on the differential lines is much more likely to appear as common-mode which is rejected by the receiver.

Match electrical lengths between traces to reduce skew. Skew between the signals of a pair means a phase difference between signals which destroys the magnetic field cancellation benefits of differential signals and EMI will result! (Note that the velocity of propagation, $v = c/E_r$ where c (the speed of light) = 0.2997 mm/ps or 0.0118 in/ps). Do not rely solely on the autoroute function for differential traces. Carefully review dimensions to match differential impedance and provide isolation for the differential lines. Minimize the number of vias and other discontinuities on the line.

Avoid 90° turns (these cause impedance discontinuities). Use arcs or 45° bevels.

Within a pair of traces, the distance between the two traces should be minimized to maintain common-mode rejection of the receivers. On the printed circuit board, this distance should remain constant to avoid discontinuities in differential impedance. Minor violations at connection points are allowable.

11.1.2 PC Board Considerations

Use at least 4 PCB board layers (top to bottom): LVDS signals, ground, power, TTL signals.

Isolate TTL signals from LVDS signals, otherwise the TTL signals may couple onto the LVDS lines. It is best to put TTL and LVDS signals on different layers which are isolated by a power/ground plane(s).

11.2 Layout Examples



图 11-1. WSON Thermal Land Pad and Pin Pads



图 11-2. Simplified DS90LV027A and DS90LV028A Layout

12 Device and Documentation Support

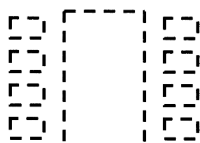
12.1 支持资源

TI E2E™ 中文支持论坛是工程师的重要参考资料，可直接从专家处获得快速、经过验证的解答和设计帮助。搜索现有解答或提出自己的问题，获得所需的快速设计帮助。

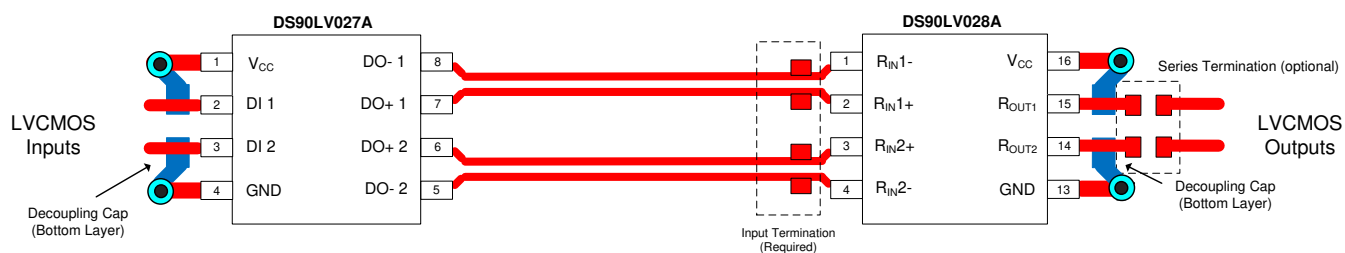
链接的内容由各个贡献者“按原样”提供。这些内容并不构成 TI 技术规范，并且不一定反映 TI 的观点；请参阅 TI 的使用条款。

12.2 Trademarks

TI E2E™ is a trademark of Texas Instruments.

所有商标均为其各自所有者的财产。

12.3 静电放电警告



静电放电 (ESD) 会损坏这个集成电路。德州仪器 (TI) 建议通过适当的预防措施处理所有集成电路。如果不遵守正确的处理和安装程序，可能会损坏集成电路。

ESD 的损坏小至导致微小的性能降级，大至整个器件故障。精密的集成电路可能更容易受到损坏，这是因为非常细微的参数更改都可能会导致器件与其发布的规格不相符。

12.4 术语表

TI 术语表 本术语表列出并解释了术语、首字母缩略词和定义。

13 Mechanical, Packaging, and Orderable Information

The following pages include mechanical, packaging, and orderable information. This information is the most current data available for the designated devices. This data is subject to change without notice and revision of this document. For browser-based versions of this data sheet, refer to the left-hand navigation.

PACKAGING INFORMATION

Orderable Device	Status (1)	Package Type	Package Drawing	Pins	Package Qty	Eco Plan (2)	Lead finish/ Ball material (6)	MSL Peak Temp (3)	Op Temp (°C)	Device Marking (4/5)	Samples
DS90LV028AQDQFRQ1	ACTIVE	WSON	DQF	8	3000	RoHS & Green	NIPDAUAG	Level-1-260C-UNLIM	-40 to 105	D28Q	Samples
DS90LV028AQDQFTQ1	ACTIVE	WSON	DQF	8	250	RoHS & Green	NIPDAUAG	Level-1-260C-UNLIM	-40 to 105	D28Q	Samples

(1) The marketing status values are defined as follows:

ACTIVE: Product device recommended for new designs.

LIFEBUY: TI has announced that the device will be discontinued, and a lifetime-buy period is in effect.

NRND: Not recommended for new designs. Device is in production to support existing customers, but TI does not recommend using this part in a new design.

PREVIEW: Device has been announced but is not in production. Samples may or may not be available.

OBSOLETE: TI has discontinued the production of the device.

(2) **RoHS:** TI defines "RoHS" to mean semiconductor products that are compliant with the current EU RoHS requirements for all 10 RoHS substances, including the requirement that RoHS substance do not exceed 0.1% by weight in homogeneous materials. Where designed to be soldered at high temperatures, "RoHS" products are suitable for use in specified lead-free processes. TI may reference these types of products as "Pb-Free".

RoHS Exempt: TI defines "RoHS Exempt" to mean products that contain lead but are compliant with EU RoHS pursuant to a specific EU RoHS exemption.

Green: TI defines "Green" to mean the content of Chlorine (Cl) and Bromine (Br) based flame retardants meet JS709B low halogen requirements of <=1000ppm threshold. Antimony trioxide based flame retardants must also meet the <=1000ppm threshold requirement.

(3) MSL, Peak Temp. - The Moisture Sensitivity Level rating according to the JEDEC industry standard classifications, and peak solder temperature.

(4) There may be additional marking, which relates to the logo, the lot trace code information, or the environmental category on the device.

(5) Multiple Device Markings will be inside parentheses. Only one Device Marking contained in parentheses and separated by a "~" will appear on a device. If a line is indented then it is a continuation of the previous line and the two combined represent the entire Device Marking for that device.

(6) Lead finish/Ball material - Orderable Devices may have multiple material finish options. Finish options are separated by a vertical ruled line. Lead finish/Ball material values may wrap to two lines if the finish value exceeds the maximum column width.

Important Information and Disclaimer:The information provided on this page represents TI's knowledge and belief as of the date that it is provided. TI bases its knowledge and belief on information provided by third parties, and makes no representation or warranty as to the accuracy of such information. Efforts are underway to better integrate information from third parties. TI has taken and continues to take reasonable steps to provide representative and accurate information but may not have conducted destructive testing or chemical analysis on incoming materials and chemicals. TI and TI suppliers consider certain information to be proprietary, and thus CAS numbers and other limited information may not be available for release.

In no event shall TI's liability arising out of such information exceed the total purchase price of the TI part(s) at issue in this document sold by TI to Customer on an annual basis.

OTHER QUALIFIED VERSIONS OF DS90LV028A-Q1 :

- Catalog : [DS90LV028A](#)

NOTE: Qualified Version Definitions:

- Catalog - TI's standard catalog product

TAPE AND REEL INFORMATION

QUADRANT ASSIGNMENTS FOR PIN 1 ORIENTATION IN TAPE

*All dimensions are nominal

Device	Package Type	Package Drawing	Pins	SPQ	Reel Diameter (mm)	Reel Width W1 (mm)	A0 (mm)	B0 (mm)	K0 (mm)	P1 (mm)	W (mm)	Pin1 Quadrant
DS90LV028AQDQFRQ1	WSON	DQF	8	3000	178.0	8.4	2.25	2.25	1.0	4.0	8.0	Q1
DS90LV028AQDQFTQ1	WSON	DQF	8	250	178.0	8.4	2.25	2.25	1.0	4.0	8.0	Q1

TAPE AND REEL BOX DIMENSIONS

*All dimensions are nominal

Device	Package Type	Package Drawing	Pins	SPQ	Length (mm)	Width (mm)	Height (mm)
DS90LV028AQDQFRQ1	WSON	DQF	8	3000	205.0	200.0	33.0
DS90LV028AQDQFTQ1	WSON	DQF	8	250	205.0	200.0	33.0

EXAMPLE BOARD LAYOUT

DQF0008A

WSON - 0.8 mm max height

PLASTIC SMALL OUTLINE - NO LEAD

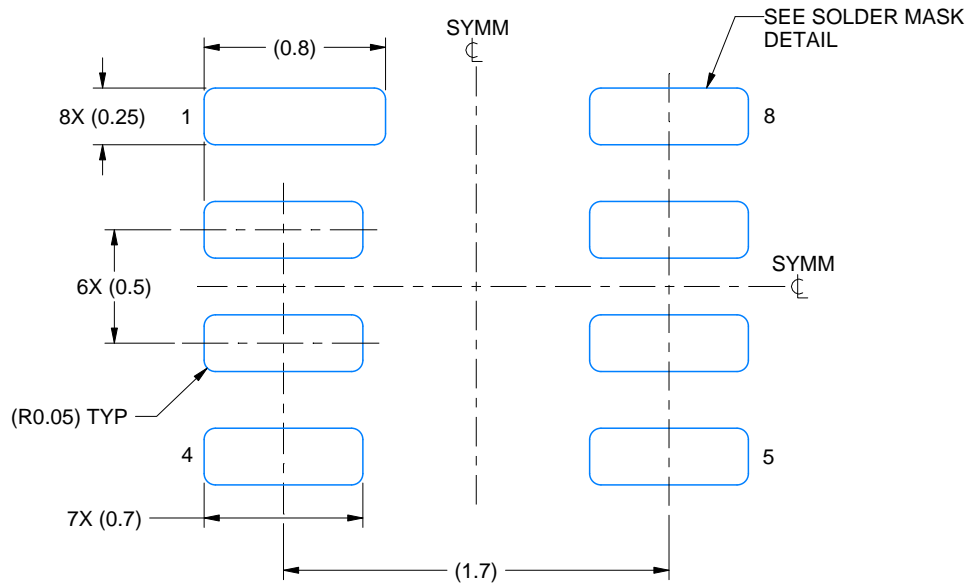

LAND PATTERN EXAMPLE
EXPOSED METAL SHOWN
SCALE: 30X

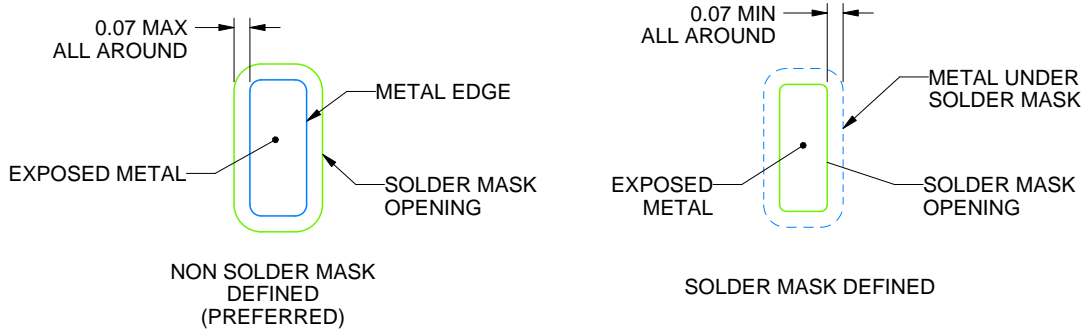

SOLDER MASK DETAILS

4220563/A 03/2021

NOTES: (continued)

3. This package is designed to be soldered to a thermal pad on the board. For more information, see Texas Instruments literature number SLUA271 (www.ti.com/lit/slua271).

EXAMPLE STENCIL DESIGN

DQF0008A

WSON - 0.8 mm max height

PLASTIC SMALL OUTLINE - NO LEAD

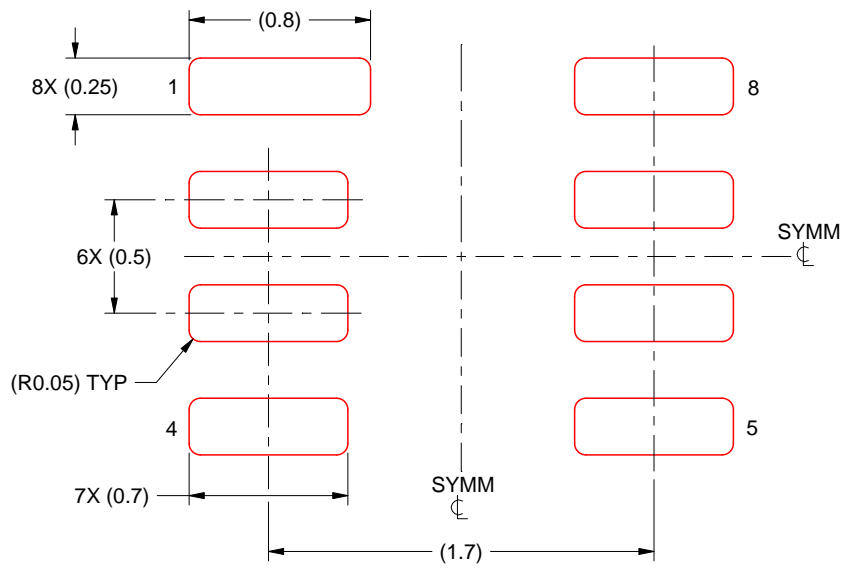

SOLDER PASTE EXAMPLE
BASED ON 0.125 MM THICK STENCIL
SCALE: 30X

4220563/A 03/2021

NOTES: (continued)

4. Laser cutting apertures with trapezoidal walls and rounded corners may offer better paste release. IPC-7525 may have alternate design recommendations.

重要声明和免责声明

TI“按原样”提供技术和可靠性数据（包括数据表）、设计资源（包括参考设计）、应用或其他设计建议、网络工具、安全信息和其他资源，不保证没有瑕疵且不做任何明示或暗示的担保，包括但不限于对适销性、某特定用途方面的适用性或不侵犯任何第三方知识产权的暗示担保。

这些资源可供使用 TI 产品进行设计的熟练开发人员使用。您将自行承担以下全部责任：(1) 针对您的应用选择合适的 TI 产品，(2) 设计、验证并测试您的应用，(3) 确保您的应用满足相应标准以及任何其他功能安全、信息安全、监管或其他要求。

这些资源如有变更，恕不另行通知。TI 授权您仅可将这些资源用于研发本资源所述的 TI 产品的应用。严禁对这些资源进行其他复制或展示。您无权使用任何其他 TI 知识产权或任何第三方知识产权。您应全额赔偿因在这些资源的使用中对 TI 及其代表造成的任何索赔、损害、成本、损失和债务，TI 对此概不负责。

TI 提供的产品受 [TI 的销售条款](#) 或 [ti.com](#) 上其他适用条款/TI 产品随附的其他适用条款的约束。TI 提供这些资源并不会扩展或以其他方式更改 TI 针对 TI 产品发布的适用的担保或担保免责声明。

TI 反对并拒绝您可能提出的任何其他或不同的条款。

邮寄地址：Texas Instruments, Post Office Box 655303, Dallas, Texas 75265

Copyright © 2023，德州仪器 (TI) 公司