

## LM95071-Q1 SPI/MICROWIRE 13 位带符号温度传感器

### 1 特性

- 符合面向汽车应用的 AEC-Q100 标准
  - 器件温度等级 0:  $-40^{\circ}\text{C}$  至  $+150^{\circ}\text{C}$ ,  $T_A$
- 小型 SOT-23 封装节省空间
- 关断模式可在两次读取温度期间节省能量
- 在  $-40^{\circ}\text{C}$  至  $+150^{\circ}\text{C}$  整个温度范围内正常工作
- SPI 和 MICROWIRE 总线接口
- 主要规格
  - 电源电压: 2.4V 至 5.5V
  - 电源电流
    - 工作电流: 280 $\mu\text{A}$  (典型值)
    - 关断电流: 6 $\mu\text{A}$  (典型值)
  - 温度精度
    - $0^{\circ}\text{C}$  至  $70^{\circ}\text{C}$   $\pm 1^{\circ}\text{C}$  (最大值)
    - $-40^{\circ}\text{C}$  至  $150^{\circ}\text{C}$   $\pm 2^{\circ}\text{C}$  (最大值)
  - 温度分辨率 0.03125 $^{\circ}\text{C}$

### 2 应用

- 汽车
- 系统热管理
- 便携式电子设备
- 个人计算机
- 磁盘驱动器
- 办公电子设备
- 电子测试设备

### 3 说明

LM95071-Q1 是一款低功耗、高分辨率数字温度传感器，具有 SPI 和 MICROWIRE 兼容接口，采用 5 引脚 Q1-23 封装。主机可随时查询 LM95071-Q1 以读取温度。它的工作电流低，非常适合低功耗至关重要的系统。

LM95071-Q1 具有 13 位带符号温度分辨率 (0.03125 $^{\circ}\text{C}/\text{LSB}$ )，工作温度范围为  $-40^{\circ}\text{C}$  至  $+150^{\circ}\text{C}$ 。

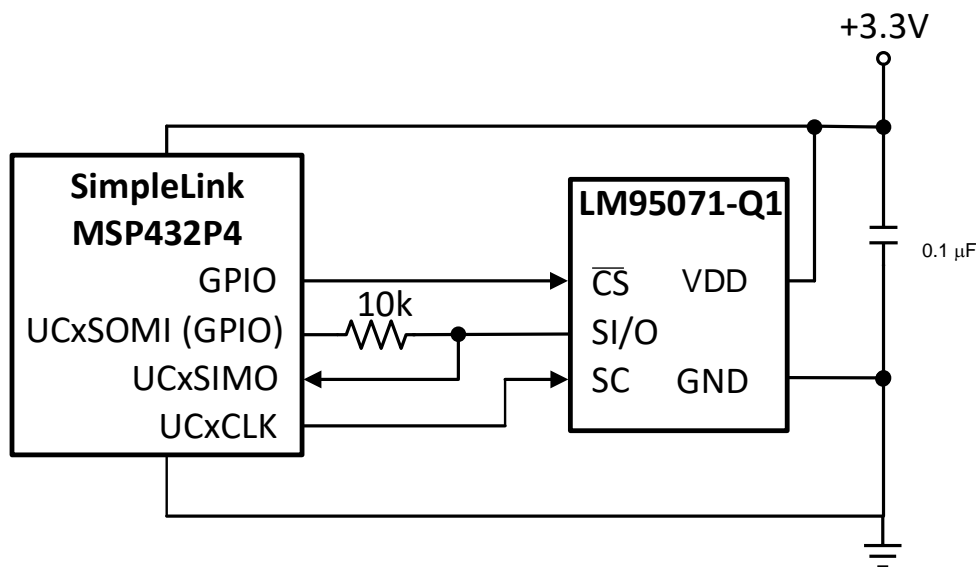
LM95071-Q1 的电源电压范围为 2.4V 至 5.5V，转换速率快、电源电流低以及 SPI 接口简单，因此广泛适用于各种应用。

#### 器件信息(1)

器件型号	封装	封装尺寸 (标称值)
LM95071-Q1	SOT-23 (5)	2.90mm x 1.60mm

(1) 如需了解所有可用封装，请参阅数据表末尾的可订购产品附录。

#### 温度监控器应用



## 目录

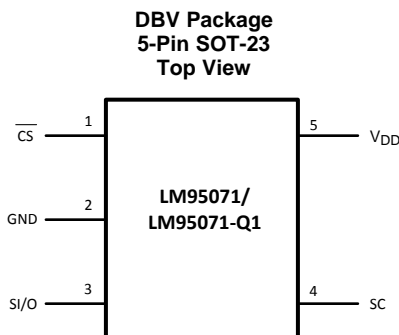
<b>1</b>	特性 .....	1	6.9	Typical Characteristics .....	7
<b>2</b>	应用 .....	1	<b>7</b>	<b>Parameter Measurement Information .....</b>	<b>8</b>
<b>3</b>	说明 .....	1	<b>8</b>	<b>Detailed Description .....</b>	<b>9</b>
<b>4</b>	修订历史记录 .....	2	8.1	Overview .....	9
<b>5</b>	<b>Pin Configuration and Functions .....</b>	<b>3</b>	8.2	Functional Block Diagram .....	9
<b>6</b>	<b>Specifications .....</b>	<b>3</b>	8.3	Feature Description .....	9
6.1	Absolute Maximum Ratings .....	3	8.4	Device Functional Modes .....	10
6.2	ESD Ratings .....	3	8.5	Programming .....	10
6.3	Recommended Operating Ratings .....	4	8.6	Register Maps .....	12
6.4	Thermal Information .....	4	<b>9</b>	<b>器件和文档支持 .....</b>	<b>14</b>
6.5	Temperature-to-Digital Converter Characteristics .....	4	9.1	接收文档更新通知 .....	14
6.6	Logic Electrical Characteristics - Digital DC Characteristics .....	4	9.2	社区资源 .....	14
6.7	Logic Electrical Characteristics - Serial Bus Digital Switching Characteristics .....	5	9.3	商标 .....	14
6.8	Timing Diagrams .....	5	9.4	静电放电警告 .....	14
			9.5	术语表 .....	14
			<b>10</b>	<b>机械、封装和可订购信息 .....</b>	<b>14</b>

## 4 修订历史记录

注：之前版本的页码可能与当前版本有所不同。

日期	版本	注释
2018 年 12 月	*	初始发行版。将 SNIS137 中的汽车器件移到了单独的数据表中，将 AEC-Q100 资质水平添加到数据表中，将数据表布局更新为最新 SDS 格式，更改了第一页的重要图形，更改了“温度-数字转换器特征”表注以澄清转换间隔，并用热性能信息表替换了热工特性表，以及更新了热阻值

## 5 Pin Configuration and Functions



### Pin Function

PIN		DESCRIPTION
NO.	NAME	
1	$\overline{CS}$	Chip Select input. This pin receives an active-low signal from the controller to select the device.
2	GND	Ground. This is the power and signal ground return.
3	SI/O	Serial Input/Output. This serial, bidirectional, data bus pin transmits and receives signals to and from the controller. Schmitt trigger input in the input mode.
4	SC	Serial bus clock. This serial clock signal comes from the controller. Schmitt trigger input.
5	$V_{DD}$	Positive Supply Voltage. Supply a DC voltage from 2.4V to 5.5V to this pin and bypass with a 0.1- $\mu$ F ceramic capacitor to ground.

## 6 Specifications

### 6.1 Absolute Maximum Ratings <sup>(1)(2)(3)</sup>

	MIN	MAX	UNIT
Supply voltage	-0.3	6	V
Voltage at any pin	-0.3	$V_{DD} + 0.3$	V
Input current at any pin <sup>(4)</sup>		5	mA
Storage temperature, $T_{stg}$	-65	150	$^{\circ}$ C

- (1) Absolute Maximum Ratings indicate limits beyond which damage to the device may occur. DC and AC electrical specifications do not apply when operating the device beyond its rated operating conditions.
- (2) Soldering process must comply with Reflow Temperature Profile specifications. Refer to <http://www.ti.com/packaging>.
- (3) Reflow temperature profiles are different for lead-free and non-lead-free packages.
- (4) When the input voltage ( $V_I$ ) at any pin exceeds the power supplies ( $V_I < GND$  or  $V_I > V_{DD}$ ) the current at that pin should be limited to 5 mA.

### 6.2 ESD Ratings

		VALUE	UNIT
$V_{(ESD)}$	Electrostatic discharge	Human-body model (HBM), per AEC Q100-002 <sup>(1)</sup> HBM ESD Classification Level 2	$\pm 2000$
		Charged-device model (CDM), per AEC Q100-011 CDM ESD Classification Level C2	$\pm 200$

- (1) AEC Q100-002 indicates that HBM stressing shall be in accordance with the ANSI/ESDA/JEDEC JS-001 specification.

### 6.3 Recommended Operating Ratings

	MIN	MAX	UNIT
Specified temperature <sup>(1)</sup> , T <sub>MIN</sub> to T <sub>MAX</sub>	-40	150	°C
Supply voltage (V <sub>DD</sub> )	2.4	5.5	V

- (1) The life expectancy of the of the LM95071-Q1 will be reduced when operating at elevated temperatures. of the LM95071-Q1  $\theta_{JA}$  (thermal resistance, junction-to-ambient) when attached to a printed-circuit board with 2-oz. foil is summarized in the table below.

### 6.4 Thermal Information

THERMAL METRIC <sup>(1)</sup>		LM95071-Q1	
		DBV (SOT-23)	
		5 PINS	
			UNIT
R <sub>θJA</sub>	Junction-to-ambient thermal resistance	167.2	°C/W
R <sub>θJC(top)</sub>	Junction-to-case (top) thermal resistance	118.8	°C/W
R <sub>θJB</sub>	Junction-to-board thermal resistance	30.7	°C/W
Ψ <sub>JT</sub>	Junction-to-top characterization parameter	14.4	°C/W
Ψ <sub>JB</sub>	Junction-to-board characterization parameter	30.1	°C/W
R <sub>θJC(bot)</sub>	Junction-to-case (bottom) thermal resistance	n/a	°C/W

- (1) For more information about traditional and new thermal metrics, see the [Semiconductor and IC Package Thermal Metrics](#) application report.

### 6.5 Temperature-to-Digital Converter Characteristics

Unless otherwise noted, these specifications apply for V<sub>DD</sub> = 3.3 V. All limits T<sub>A</sub> = T<sub>J</sub> = +25°C, unless otherwise noted.

PARAMETER	TEST CONDITIONS		MIN <sup>(1)</sup>	TYP <sup>(2)</sup>	MAX <sup>(1)</sup>	UNIT
Temperature error <sup>(3)</sup>	V <sub>DD</sub> = 3.0V to 3.6V; T <sub>A</sub> = 0°C to +70°C, T <sub>A</sub> = T <sub>J</sub> = T <sub>MIN</sub> to T <sub>MAX</sub>				±1.0	°C
	V <sub>DD</sub> = 3.0V to 3.6V; T <sub>A</sub> = -40°C to +150°C, T <sub>A</sub> = T <sub>J</sub> = T <sub>MIN</sub> to T <sub>MAX</sub>				±2.0	°C
Line regulation	V <sub>DD</sub> = 3.6V to 5.5V; T <sub>A</sub> = 0°C to +70°C				+0.3	°C/V
	V <sub>DD</sub> = 3.0V to 2.4V; T <sub>A</sub> = 0°C to +70°C				-0.6	
Resolution				14 0.03125		Bits °C
Temperature conversion time	See <sup>(4)</sup>	T <sub>A</sub> = T <sub>J</sub> = +25°C		130		ms
		T <sub>A</sub> = T <sub>J</sub> = T <sub>MIN</sub> to T <sub>MAX</sub>			228	
Quiescent current	Operating, serial bus inactive	T <sub>A</sub> = T <sub>J</sub> = +25°C		280		μA
		T <sub>A</sub> = T <sub>J</sub> = T <sub>MIN</sub> to T <sub>MAX</sub>			520	
	Shutdown	T <sub>A</sub> = T <sub>J</sub> = +25°C		6		μA
		T <sub>A</sub> = T <sub>J</sub> = T <sub>MIN</sub> to T <sub>MAX</sub>			28	

- (1) Limits are guaranteed to TI's AOQL (Average Outgoing Quality Level).  
 (2) Typicals are at T<sub>A</sub> = 25°C and represent most likely parametric norm.  
 (3) The of the LM95071-Q1 will operate properly over the V<sub>DD</sub> supply voltage range of 2.4V to 5.5V.  
 (4) Following a power on reset, the user must allow at least 228 ms before making the first read transaction to ensure a first valid temperature read. After the first read, in order to ensure an accurate temperature result, the time interval between any two consecutive temperature reads must be greater than the maximum conversion time of 228 ms.

### 6.6 Logic Electrical Characteristics - Digital DC Characteristics

Unless otherwise noted, these specifications apply for V<sub>DD</sub> = 2.4 V to 5.5 V<sup>(1)</sup>.

PARAMETER	TEST CONDITIONS	MIN <sup>(2)</sup>	TYP <sup>(3)</sup>	MAX <sup>(2)</sup>	UNIT
V <sub>IN(1)</sub> Logical "1" Input Voltage	T <sub>A</sub> = T <sub>J</sub> = T <sub>MIN</sub> to T <sub>MAX</sub>	0.7 × V <sub>DD</sub>		V <sub>DD</sub> + 0.3	V
V <sub>IN(0)</sub> Logical "0" Input Voltage	T <sub>A</sub> = T <sub>J</sub> = T <sub>MIN</sub> to T <sub>MAX</sub>	-0.3		0.3 × V <sub>DD</sub>	V

- (1) The of the LM95071-Q1 will operate properly over the V<sub>DD</sub> supply voltage range of 2.4V to 5.5V.  
 (2) Limits are guaranteed to TI's AOQL (Average Outgoing Quality Level).  
 (3) Typicals are at T<sub>A</sub> = 25°C and represent most likely parametric norm.

### Logic Electrical Characteristics - Digital DC Characteristics (continued)

Unless otherwise noted, these specifications apply for  $V_{DD} = 2.4\text{ V to }5.5\text{ V}^{(1)}$ .

PARAMETER	TEST CONDITIONS		MIN <sup>(2)</sup>	TYP <sup>(3)</sup>	MAX <sup>(2)</sup>	UNIT
Input Hysteresis Voltage	$V_{DD} = 3\text{ V to }3.6\text{ V}$	$T_A = T_J = +25^\circ\text{C}$	0.4		V	
		$T_A = T_J = T_{MIN}\text{ to }T_{MAX}$	0.33			
$I_{IN(1)}$ Logical "1" Input Current	$V_{IN} = V_{DD}$	$T_A = T_J = +25^\circ\text{C}$	0.005		$\mu\text{A}$	
		$T_A = T_J = T_{MIN}\text{ to }T_{MAX}$	3			
$I_{IN(0)}$ Logical "0" Input Current	$V_{IN} = 0\text{ V}$	$T_A = T_J = +25^\circ\text{C}$	-0.005		$\mu\text{A}$	
		$T_A = T_J = T_{MIN}\text{ to }T_{MAX}$	-3			
$C_{IN}$ All Digital Inputs	$T_A = T_J = +25^\circ\text{C}$		20		$\text{pF}$	
$V_{OH}$ High Level Output Voltage	$I_{OH} = -400\ \mu\text{A}, T_A = T_J = T_{MIN}\text{ to }T_{MAX}$		2.25		V	
$V_{OL}$ Low Level Output Voltage	$I_{OL} = +1.6\ \text{mA}, T_A = T_J = T_{MIN}\text{ to }T_{MAX}$		0.4		V	
$I_{O\_TRI-STATE}$ TRI-STATE Output Leakage Current	$V_O = \text{GND}$ $V_O = V_{DD}, T_A = T_J = T_{MIN}\text{ to }T_{MAX}$		-1		+1	$\mu\text{A}$

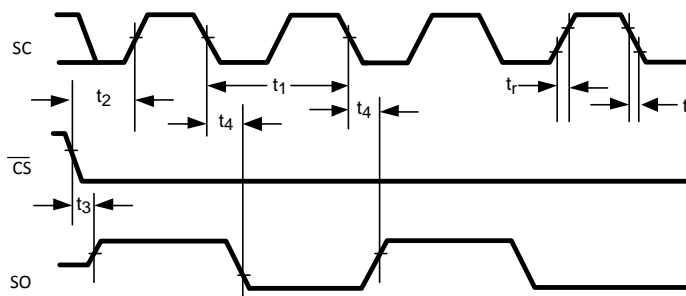
### 6.7 Logic Electrical Characteristics - Serial Bus Digital Switching Characteristics

Unless otherwise noted, these specifications apply for  $V_{DD} = 2.4\text{ V to }5.5\text{ V}^{(1)}$ ;  $C_L$  (load capacitance) on output lines = 100 pF unless otherwise specified.

		MIN <sup>(2)</sup>	TYP <sup>(3)</sup>	MAX <sup>(2)</sup>	UNIT
$t_1$ SC (Clock) Period		$T_A = T_J = T_{MIN}\text{ to }T_{MAX}$		0.16	$\mu\text{s}$
		$T_A = T_J = +25^\circ\text{C}$		DC	
$t_2$ $\overline{CS}$ Low to SC (Clock) High Set-Up Time	$T_A = T_J = T_{MIN}\text{ to }T_{MAX}$	100			ns
$t_3$ $\overline{CS}$ Low to Data Out (SO) Delay	$T_A = T_J = T_{MIN}\text{ to }T_{MAX}$			70	ns
$t_4$ SC (Clock) Low to Data Out (SO) Delay	$T_A = T_J = T_{MIN}\text{ to }T_{MAX}$			70	ns
$t_5$ $\overline{CS}$ High to Data Out (SO) TRI-STATE	$T_A = T_J = T_{MIN}\text{ to }T_{MAX}$			200	ns
$t_6$ SC (Clock) High to Data In (SI) Hold Time	$T_A = T_J = T_{MIN}\text{ to }T_{MAX}$	50			ns
$t_7$ Data In (SI) Set-Up Time to SC (Clock) High	$T_A = T_J = T_{MIN}\text{ to }T_{MAX}$	30			ns
$t_8$ SC (Clock) High to $\overline{CS}$ High Hold Time	$T_A = T_J = T_{MIN}\text{ to }T_{MAX}$	50			ns

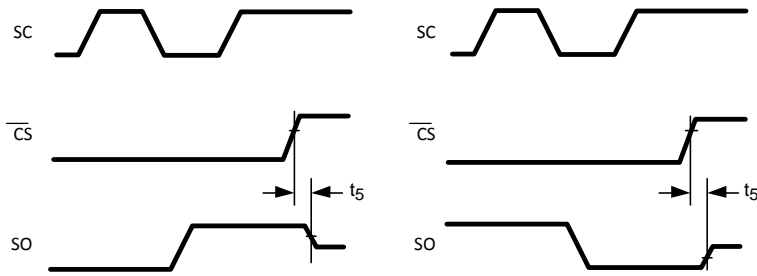
- (1) The of the LM95071-Q1 will operate properly over the  $V_{DD}$  supply voltage range of 2.4V to 5.5V.
- (2) Limits are guaranteed to TI's AOQL (Average Outgoing Quality Level).
- (3) Typicals are at  $T_A = 25^\circ\text{C}$  and represent most likely parametric norm.

### 6.8 Timing Diagrams

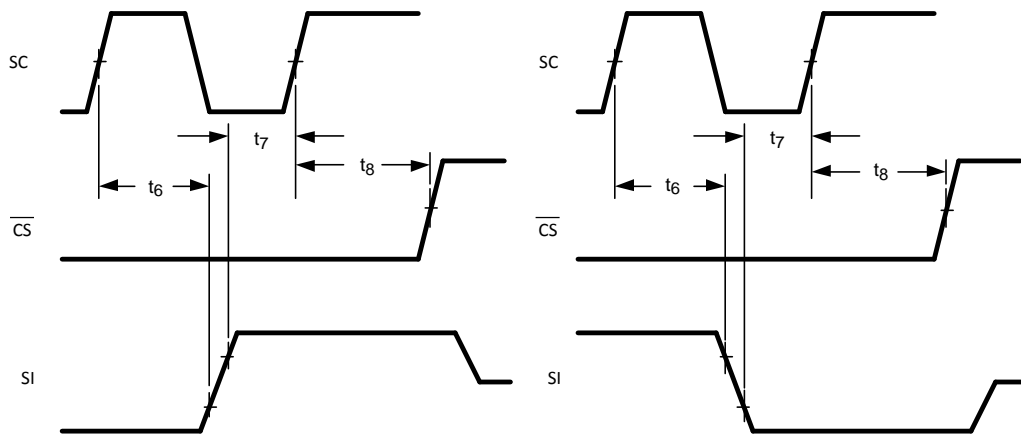


**Figure 1. Data Output Timing Diagram**

**Timing Diagrams (continued)**

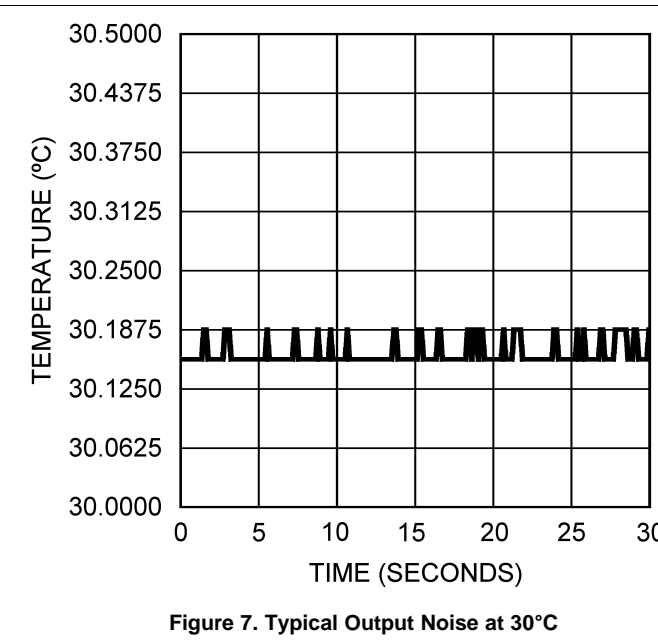
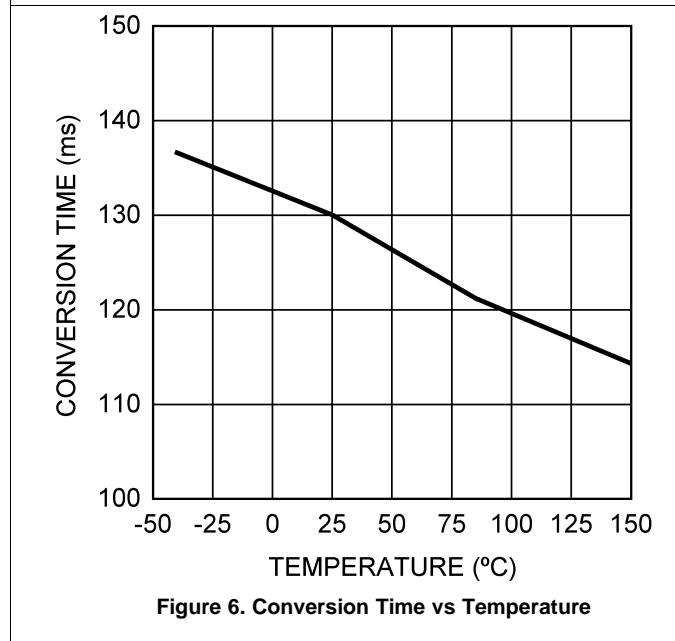
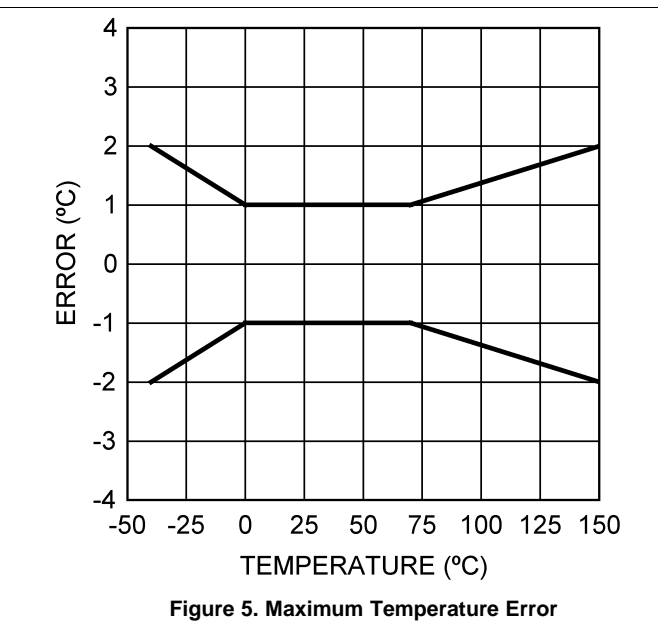
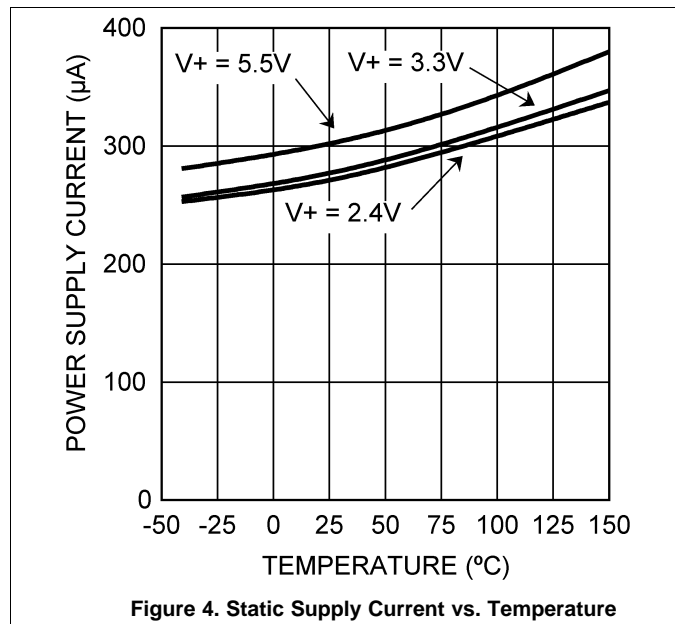


**Figure 2. TRI-STATE Data Output Timing Diagram**



**Figure 3. Data Input Timing Diagram**

### 6.9 Typical Characteristics



## 7 Parameter Measurement Information

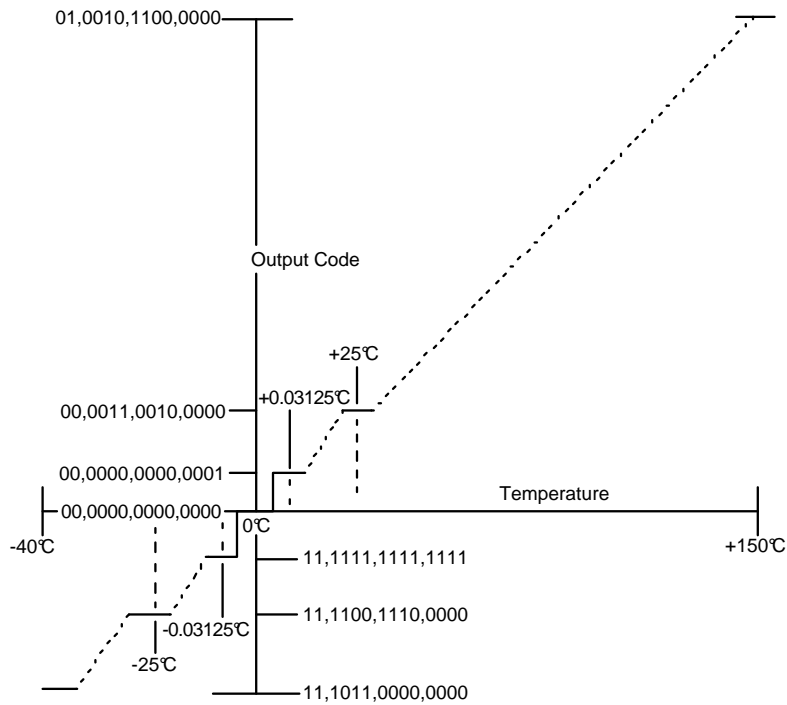


Figure 8. Temperature-to-Digital Transfer Function (Non-Linear Scale for Clarity)

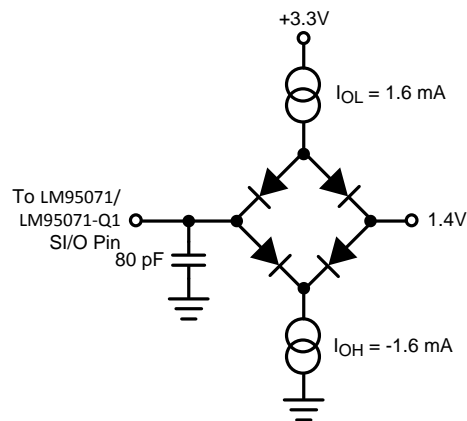


Figure 9. TRI-STATE Test Circuit

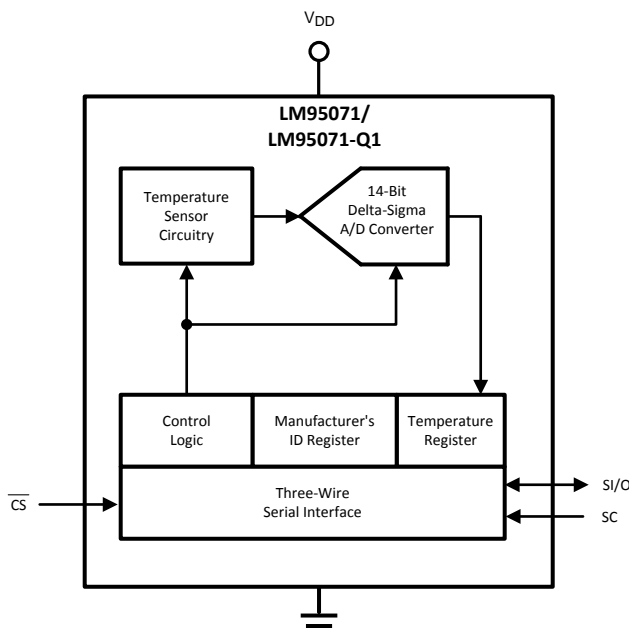


## 8 Detailed Description

### 8.1 Overview

The LM95071-Q1 temperature sensor incorporates a temperature sensor and 13-bit-plus-sign  $\Delta\Sigma$  ADC (Delta-Sigma Analog-to-Digital Converter). Compatibility of the LM95071-Q1's three-wire serial interface with SPI and MICROWIRE allows simple communications with common microcontrollers and processors. Shutdown mode can be used to optimize current drain for different applications. A Manufacturer/Device ID register identifies the LM95071-Q1 as a Texas Instruments product.

### 8.2 Functional Block Diagram



### 8.3 Feature Description

#### 8.3.1 Power Up and Power Down

The LM95071-Q1 always powers up in a known state and in the continuous conversion mode. Immediately after power up, the LM95071-Q1 will output an erroneous code until the first temperature conversion has completed.

When the supply voltage is less than about 1.6V (typical), the LM95071-Q1 is considered powered down. As the supply voltage rises above the nominal 1.6-V power up threshold, the internal registers are reset to the power up default state described above.

#### 8.3.2 Temperature Data Format

Temperature data is represented by a 14-bit, two's complement word with an LSB (Least Significant Bit) equal to 0.03125°C:

**Table 1. Digital Output for Temperature Data**

Temperature	Digital Output	
	Binary	Hex
+150°C	0100 1011 0000 0011	4B03
+125°C	0011 1110 1000 0011	3E83
+25°C	0000 1100 1000 0011	0C83
+0.03125°C	0000 0000 0000 0111	0007
0°C	0000 0000 0000 0011	0003

**Table 1. Digital Output for Temperature Data (continued)**

Temperature	Digital Output	
	Binary	Hex
-0.03125°C	1111 1111 1111 1111	FFFF
-25°C	1111 0011 1000 0011	F383
-40°C	1110 1100 0000 0011	EC03

The first data byte is the most significant byte with most significant bit first, permitting only as much data as necessary to be read to determine temperature condition. For instance, if the first four bits of the temperature data indicate an overtemperature condition, the host processor could immediately take action to remedy the excessive temperatures.

### 8.3.3 Tight Accuracy, Fine Resolution and Low Noise

The LM95071-Q1 is well suited for applications that require tight temperature measurement accuracy. In many applications, from process control to HVAC, the low temperature error can mean better system performance and, by eliminating a system calibration step, lower production cost.

With fine digital resolution, the LM95071-Q1 senses and reports very small changes in its temperature, making it ideal for applications where temperature sensitivity is important. For example, the LM95071-Q1 enables the system to quickly identify the direction of temperature change, allowing the processor to take compensating action before the system reaches a critical temperature.

The LM95071-Q1 has very low output noise (see [Figure 7](#) in the *Typical Characteristics* section), which makes it ideal for applications where stable thermal compensation is a priority. For example, in a temperature-compensated oscillator application, the very small deviation in successive temperature readings translates to a stable frequency output from the oscillator.

## 8.4 Device Functional Modes

### 8.4.1 Shutdown Mode/Manufacturer ID

The master controller may enable the shutdown mode for the purpose of reducing power consumption or for reading the Manufacturer/Device ID information. The shutdown mode is enabled by writing XX FF hex to the LM95071-Q1 as shown in [Figure 13c](#). The serial bus is still active when the LM95071-Q1 is in shutdown. When in shutdown mode the LM95071-Q1 always will output 1000 0000 0000 1111. This is the Manufacturer/Device ID information. The first 5-bits of the field (1000 0XXX) are reserved for the manufacturer ID.

## 8.5 Programming

### 8.5.1 Serial Bus Interface

The LM95071-Q1 operates as a slave and is compatible with SPI or MICROWIRE bus specifications. Data is clocked out on the falling edge of the serial clock (SC), while data is clocked in on the rising edge of SC. A complete communication is framed by falling and rising chip select (CS) signal. The CS signal should be held high for at least one clock cycle (160 ns minimum) between communications. The transmit-only communication (register read) consists of 16 clock cycles. A complete transmit/receive communication will consist of 32 serial clocks (see [Serial Bus Timing Diagrams](#)). The first 16 clocks comprise the transmit phase of communication, while the second 16 clocks are the receive phase.

When  $\overline{CS}$  is high SI/O will be in TRI-STATE. Communication should be initiated by taking chip select ( $\overline{CS}$ ) low. This should not be done when SC is changing from a low to high state. Once  $\overline{CS}$  is low the serial I/O pin (SI/O) will transmit the first bit of data. The master can then read this bit with the rising edge of SC. The remainder of the data will be clocked out by the falling edge of SC.  $\overline{CS}$  can be taken high at any time during the transmit phase. If  $\overline{CS}$  is brought low in the middle of a conversion the LM95071-Q1 will complete the conversion and the output shift register will be updated after  $\overline{CS}$  is brought back high.

## Programming (continued)

The receive phase of a communication starts after 16 SC periods.  $\overline{CS}$  can remain low for 32 SC cycles. The LM95071/LM95071-Q1 will read the data available on the SI/O line on the rising edge of the serial clock. Input data is to an 8-bit shift register. The part will detect the last eight bits shifted into the register. The receive phase can last up to 16 SC periods. All ones must be shifted in order to place the part into shutdown. All zeros must be shifted in order to place the LM95071-Q1 into continuous conversion mode. Only the following codes should be transmitted to the LM95071-Q1:

- 00 hex for continuous conversion
- FF hex for shutdown

Another code may place the part into a test mode. Test modes are used by Texas Instruments to thoroughly test the function of the LM95071-Q1 during production testing. Only eight bits have been defined above since only the last eight transmitted are detected by the LM95071-Q1, before  $\overline{CS}$  is taken HIGH.

The following communication can be used to determine the Manufacturer's/Device ID and then immediately place the part into continuous conversion mode. With  $\overline{CS}$  continuously low:

- Read 16 bits of temperature data
- Write 16 bits of data commanding shutdown
- Read 16 bits of Manufacturer's/Device ID data
- Write 8 to 16 bits of data commanding Conversion Mode
- Take  $\overline{CS}$  HIGH.

Note that 228 ms (max) will have to pass for a conversion to complete before the LM95071-Q1 actually transmits temperature data.

### 8.5.2 Serial Bus Timing Diagrams

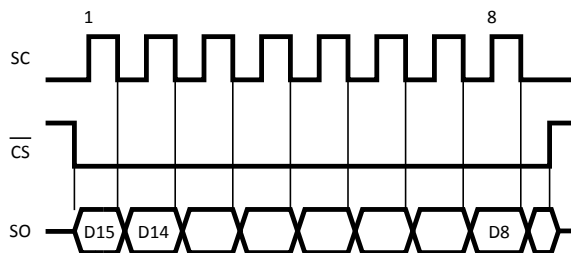


Figure 10. Reading Continuous Conversion - Single Eight-Bit Frame

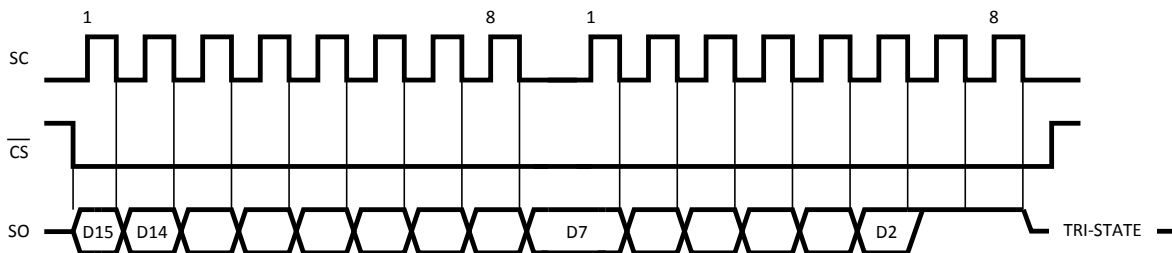


Figure 11. Reading Continuous Conversion - Two Eight-Bit Frames

## Programming (continued)

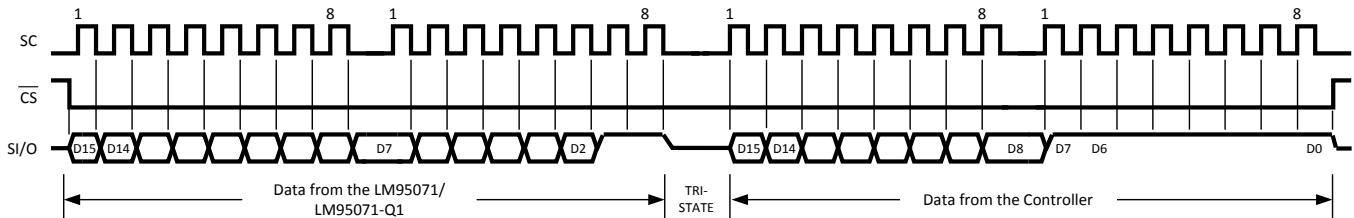


Figure 12. Writing Shutdown Mode

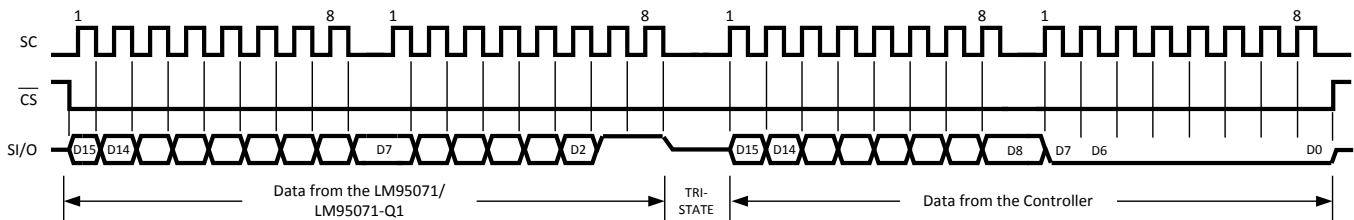


Figure 13. Writing Conversion Mode

## 8.6 Register Maps

### 8.6.1 Internal Register Structure

The LM95071-Q1 has three registers: the temperature register, the configuration register and the Manufacturer/Device identification register. The temperature and Manufacturer/Device identification registers are read only. The configuration register is write only.

#### 8.6.1.1 Configuration Register

(Selects shutdown or continuous conversion modes):

Table 2. (Write Only):

D15	D14	D13	D12	D11	D10	D9	D8	D7	D6	D5	D4	D3	D2	D1	D0
X	X	X	X	X	X	X	X								

Shutdown

D0–D15 set to XX FF hex enables shutdown mode.

D0–D15 set to XX 00 hex sets continuous-conversion mode.

Note: setting D0–D15 to any other values may place the LM95071-Q1 into a manufacturer's test mode, upon which the LM95071-Q1 will stop responding as described. These test modes are to be used for Texas Instruments production testing only. See [Serial Bus Interface](#) for a complete discussion.

#### 8.6.1.2 Temperature Register

Table 3. (Read Only):

D15	D14	D13	D12	D11	D10	D9	D8	D7	D6	D5	D4	D3	D2	D1	D0
MSB	Bit 12	Bit 11	Bit 10	Bit 9	Bit 8	Bit 7	Bit 6	Bit 5	Bit 4	Bit 3	Bit 2	Bit 1	LSB	1	1

D0–D1: Logic 1 will be output on SI/0.

D2–D15: Temperature Data. One LSB = 0.03125°C. Two's complement format.

### 8.6.1.3 Manufacturer/Device ID Register

**Table 4. (Read Only):**

D15	D14	D13	D12	D11	D10	D9	D8	D7	D6	D5	D4	D3	D2	D1	D0
1	0	0	0	0	0	0	0	0	0	0	0	1	1	1	1

D0–D1: Logic 1 will be output on SI/0.

D2–D15: Manufacturer/Device ID Data. This register is accessed whenever the LM95071-Q1 is in shutdown mode.

## 9 器件和文档支持

### 9.1 接收文档更新通知

要接收文档更新通知，请导航至 [TI.com.cn](http://TI.com.cn) 上的器件产品文件夹。单击右上角的通知我进行注册，即可每周接收产品信息更改摘要。有关更改的详细信息，请查阅已修订文档中包含的修订历史记录。

### 9.2 社区资源

下列链接提供到 TI 社区资源的连接。链接的内容由各个分销商“按照原样”提供。这些内容并不构成 TI 技术规范，并且不一定反映 TI 的观点；请参阅 TI 的《使用条款》。

**TI E2E™ 在线社区** *TI 的工程师对工程师 (E2E) 社区*。此社区的创建目的在于促进工程师之间的协作。在 [e2e.ti.com](http://e2e.ti.com) 中，您可以咨询问题、分享知识、拓展思路并与同行工程师一道帮助解决问题。

**设计支持** *TI 参考设计支持* 可帮助您快速查找有帮助的 E2E 论坛、设计支持工具以及技术支持的联系信息。

### 9.3 商标

E2E is a trademark of Texas Instruments.

TRI-STATE is a registered trademark of National Semiconductor Corporation.

All other trademarks are the property of their respective owners.

### 9.4 静电放电警告



这些装置包含有限的内置 ESD 保护。存储或装卸时，应将导线一起截短或将装置放置于导电泡棉中，以防止 MOS 门极遭受静电损伤。

### 9.5 术语表

**SLYZ022** — *TI 术语表*。

这份术语表列出并解释术语、缩写和定义。

## 10 机械、封装和可订购信息

以下页面包含机械、封装和可订购信息。这些信息是指定器件的最新可用数据。数据如有变更，恕不另行通知，且不会对此文档进行修订。如需获取此数据表的浏览器版本，请查阅左侧的导航栏。

**PACKAGING INFORMATION**

Orderable Device	Status (1)	Package Type	Package Drawing	Pins	Package Qty	Eco Plan (2)	Lead finish/ Ball material (6)	MSL Peak Temp (3)	Op Temp (°C)	Device Marking (4/5)	Samples
LM95071QIMF/NOPB	OBSOLETE	SOT-23	DBV	5		TBD	Call TI	Call TI	-40 to 150	T18Q	
LM95071QIMFX/NOPB	ACTIVE	SOT-23	DBV	5	3000	RoHS & Green	SN	Level-1-260C-UNLIM	-40 to 150	T18Q	Samples

(1) The marketing status values are defined as follows:

**ACTIVE:** Product device recommended for new designs.

**LIFEBUY:** TI has announced that the device will be discontinued, and a lifetime-buy period is in effect.

**NRND:** Not recommended for new designs. Device is in production to support existing customers, but TI does not recommend using this part in a new design.

**PREVIEW:** Device has been announced but is not in production. Samples may or may not be available.

**OBSOLETE:** TI has discontinued the production of the device.

(2) **RoHS:** TI defines "RoHS" to mean semiconductor products that are compliant with the current EU RoHS requirements for all 10 RoHS substances, including the requirement that RoHS substance do not exceed 0.1% by weight in homogeneous materials. Where designed to be soldered at high temperatures, "RoHS" products are suitable for use in specified lead-free processes. TI may reference these types of products as "Pb-Free".

**RoHS Exempt:** TI defines "RoHS Exempt" to mean products that contain lead but are compliant with EU RoHS pursuant to a specific EU RoHS exemption.

**Green:** TI defines "Green" to mean the content of Chlorine (Cl) and Bromine (Br) based flame retardants meet JS709B low halogen requirements of <=1000ppm threshold. Antimony trioxide based flame retardants must also meet the <=1000ppm threshold requirement.

(3) MSL, Peak Temp. - The Moisture Sensitivity Level rating according to the JEDEC industry standard classifications, and peak solder temperature.

(4) There may be additional marking, which relates to the logo, the lot trace code information, or the environmental category on the device.

(5) Multiple Device Markings will be inside parentheses. Only one Device Marking contained in parentheses and separated by a "~" will appear on a device. If a line is indented then it is a continuation of the previous line and the two combined represent the entire Device Marking for that device.

(6) Lead finish/Ball material - Orderable Devices may have multiple material finish options. Finish options are separated by a vertical ruled line. Lead finish/Ball material values may wrap to two lines if the finish value exceeds the maximum column width.

**Important Information and Disclaimer:**The information provided on this page represents TI's knowledge and belief as of the date that it is provided. TI bases its knowledge and belief on information provided by third parties, and makes no representation or warranty as to the accuracy of such information. Efforts are underway to better integrate information from third parties. TI has taken and continues to take reasonable steps to provide representative and accurate information but may not have conducted destructive testing or chemical analysis on incoming materials and chemicals. TI and TI suppliers consider certain information to be proprietary, and thus CAS numbers and other limited information may not be available for release.

In no event shall TI's liability arising out of such information exceed the total purchase price of the TI part(s) at issue in this document sold by TI to Customer on an annual basis.

**OTHER QUALIFIED VERSIONS OF LM95071-Q1 :**

- Catalog : [LM95071](#)

NOTE: Qualified Version Definitions:

- Catalog - TI's standard catalog product



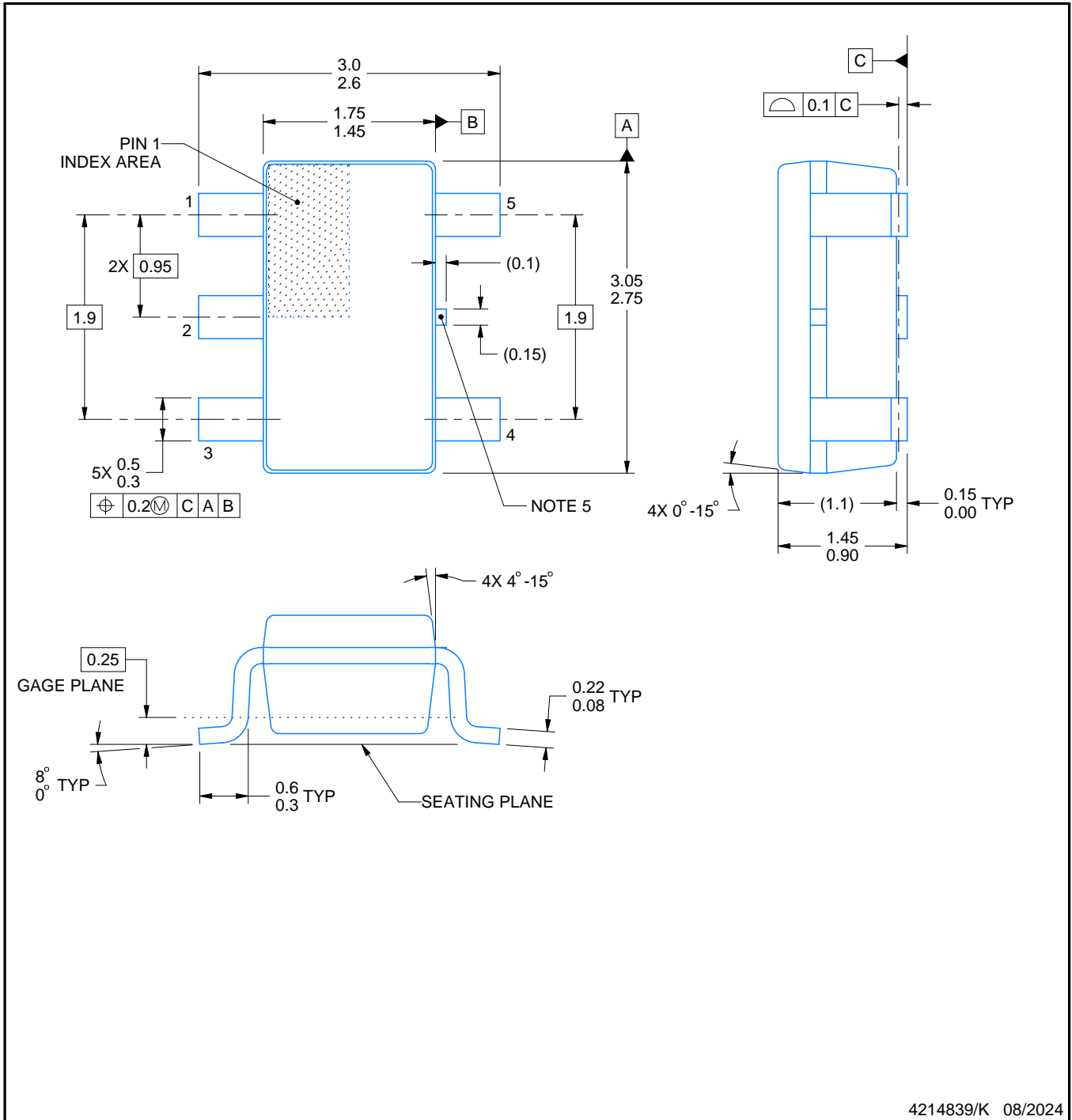
# DBV0005A



# PACKAGE OUTLINE

SOT-23 - 1.45 mm max height

SMALL OUTLINE TRANSISTOR



4214839/K 08/2024

**NOTES:**

1. All linear dimensions are in millimeters. Any dimensions in parenthesis are for reference only. Dimensioning and tolerancing per ASME Y14.5M.
2. This drawing is subject to change without notice.
3. Reference JEDEC MO-178.
4. Body dimensions do not include mold flash, protrusions, or gate burrs. Mold flash, protrusions, or gate burrs shall not exceed 0.25 mm per side.
5. Support pin may differ or may not be present.

# EXAMPLE BOARD LAYOUT

DBV0005A

SOT-23 - 1.45 mm max height

SMALL OUTLINE TRANSISTOR



LAND PATTERN EXAMPLE  
EXPOSED METAL SHOWN  
SCALE:15X



SOLDER MASK DETAILS

4214839/K 08/2024

NOTES: (continued)

- 6. Publication IPC-7351 may have alternate designs.
- 7. Solder mask tolerances between and around signal pads can vary based on board fabrication site.

# EXAMPLE STENCIL DESIGN

DBV0005A

SOT-23 - 1.45 mm max height

SMALL OUTLINE TRANSISTOR



SOLDER PASTE EXAMPLE  
BASED ON 0.125 mm THICK STENCIL  
SCALE:15X

4214839/K 08/2024

NOTES: (continued)

8. Laser cutting apertures with trapezoidal walls and rounded corners may offer better paste release. IPC-7525 may have alternate design recommendations.
9. Board assembly site may have different recommendations for stencil design.

## 重要声明和免责声明

TI“按原样”提供技术和可靠性数据（包括数据表）、设计资源（包括参考设计）、应用或其他设计建议、网络工具、安全信息和其他资源，不保证没有瑕疵且不做任何明示或暗示的担保，包括但不限于对适销性、某特定用途方面的适用性或不侵犯任何第三方知识产权的暗示担保。

这些资源可供使用 TI 产品进行设计的熟练开发人员使用。您将自行承担以下全部责任：(1) 针对您的应用选择合适的 TI 产品，(2) 设计、验证并测试您的应用，(3) 确保您的应用满足相应标准以及任何其他功能安全、信息安全、监管或其他要求。

这些资源如有变更，恕不另行通知。TI 授权您仅可将这些资源用于研发本资源所述的 TI 产品的应用。严禁对这些资源进行其他复制或展示。您无权使用任何其他 TI 知识产权或任何第三方知识产权。您应全额赔偿因在这些资源的使用中对 TI 及其代表造成的任何索赔、损害、成本、损失和债务，TI 对此概不负责。

TI 提供的产品受 [TI 的销售条款](#) 或 [ti.com](#) 上其他适用条款/TI 产品随附的其他适用条款的约束。TI 提供这些资源并不会扩展或以其他方式更改 TI 针对 TI 产品发布的适用的担保或担保免责声明。

TI 反对并拒绝您可能提出的任何其他或不同的条款。

邮寄地址：Texas Instruments, Post Office Box 655303, Dallas, Texas 75265  
Copyright © 2024，德州仪器 (TI) 公司