

LMH32401 450MHz 可编程增益、差分输出跨阻放大器

1 特性

- 集成的可编程增益：2k Ω 或 20k Ω
- 性能：增益 = 2k Ω 、C_{PD} = 1pF：
 - 带宽：450 MHz
 - 输入参考噪声：250nA_{RMS}
 - 上升，下降时间：0.8ns
- 性能：增益 = 20k Ω 、C_{PD} = 1pF：
 - 带宽：275 MHz
 - 输入参考噪声：49nA_{RMS}
 - 上升，下降时间：1.3ns
- 集成式环境光消除
- 集成式 100mA 保护钳位
- 集成式输出多路复用器
- 宽输出摆幅：1.5 V V_{PP}
- 静态电流：30mA
- 封装：16 引脚 VQFN 和裸片
- 温度范围：-40 至 125° C

2 应用

- 机械扫描激光雷达
- 固态扫描激光雷达
- 激光测距仪
- 光学 ToF 位置传感器
- 无人机视觉
- 工业机器人激光雷达
- 移动机器人激光雷达
- 扫地机器人激光雷达

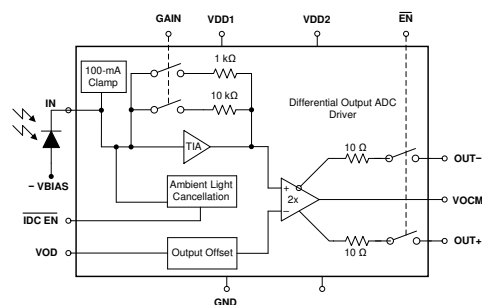

简化版方框图

3 说明

LMH32401 器件是一款增益可编程的单端输入转差分输出跨阻放大器，适用于光检测和测距（激光雷达）应用和激光测距系统。可以为 LMH32401 器件配置 2k Ω 或 20k Ω 增益。LMH32401 器件具有 1.5V_{PP} 的输出摆幅，可驱动 100 Ω 负载。

LMH32401 器件集成了一个 100mA 钳位电路，可以为放大器提供保护并允许器件迅速从过载输入状况中恢复。LMH32401 器件还具有一个集成式环境光消除电路，可取代光电二极管与放大器之间的交流耦合，从而节省布板空间并降低系统成本。当需要直流耦合时，可以禁用环境光消除电路。

当不使用放大器时，可以使用 $\overline{\text{EN}}$ 引脚将 LMH32401 器件置于低功耗模式，以节省电力。将放大器置于低功耗模式会使其输出引脚进入高阻抗状态。此功能允许多个 LMH32401 放大器多路复用到单个 ADC 中， $\overline{\text{EN}}$ 控制引脚将用作多路复用器选择功能。

封装信息⁽¹⁾

器件型号	封装	封装尺寸 (标称值)
LMH32401	VQFN (16)	3.00mm × 3.00mm

器件信息⁽¹⁾

器件型号	封装	芯片尺寸 (标称值)
LMH32401	裸片	1.025mm × 1.060mm

(1) 如需了解所有可用封装，请参阅数据表末尾的封装选项附录。

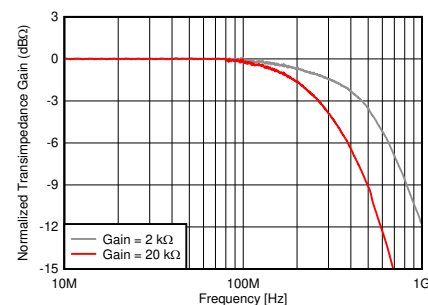

闭环跨阻带宽



Table of Contents

1 特性	1	7.3 Feature Description.....	22
2 应用	1	7.4 Device Functional Modes.....	24
3 说明	1	8 Application and Implementation	25
4 Revision History	2	8.1 Application Information.....	25
5 Pin Configuration and Functions	3	8.2 Typical Application	26
6 Specifications	5	9 Power Supply Recommendations	29
6.1 Absolute Maximum Ratings.....	5	10 Layout	29
6.2 ESD Ratings.....	5	10.1 Layout Guidelines.....	29
6.3 Recommended Operating Conditions.....	5	10.2 Layout Example.....	30
6.4 Thermal Information.....	5	11 Device and Documentation Support	31
6.5 Electrical Characteristics: Gain = 2 kΩ.....	7	11.1 Device Support.....	31
6.6 Electrical Characteristics: Gain = 20 kΩ.....	8	11.2 Documentation Support.....	31
6.7 Electrical Characteristics: Both Gains.....	9	11.3 接收文档更新通知.....	31
6.8 Electrical Characteristics: Logic Threshold and Switching Characteristics.....	11	11.4 支持资源.....	31
6.9 Typical Characteristics.....	12	11.5 Trademarks.....	31
7 Detailed Description	21	11.6 静电放电警告.....	31
7.1 Overview.....	21	11.7 术语表.....	31
7.2 Functional Block Diagram.....	21	12 Mechanical, Packaging, and Orderable Information	32

4 Revision History

注：以前版本的页码可能与当前版本的页码不同

Changes from Revision C (August 2022) to Revision D (January 2023)	Page
• Updated the <i>backside potential</i> information for <i>bare die package</i> information in the <i>Pin Configuration and Functions</i> section	3
<hr/>	
Changes from Revision B (February 2022) to Revision C (August 2022)	Page
• 将裸片的状态从 <i>预发布</i> 更改为 <i>正在供货</i>	1
• Updated the <i>bare die package</i> information in the <i>Pin Configuration and Functions</i> section.....	3
<hr/>	
Changes from Revision A (September 2020) to Revision B (February 2022)	Page
• 更新了整个文档的表、图和交叉参考的编号格式.....	1
• 向 <i>特性</i> 部分和 <i>器件信息</i> 表添加了 <i>裸片预发布封装</i>	1
• Added the <i>bare die preview package</i> to the <i>Pin Configuration and Functions</i> section.....	3
<hr/>	
Changes from Revision * (October 2019) to Revision A (June 2020)	Page
• 将状态从“预告信息”更改为“量产数据”	1

5 Pin Configuration and Functions

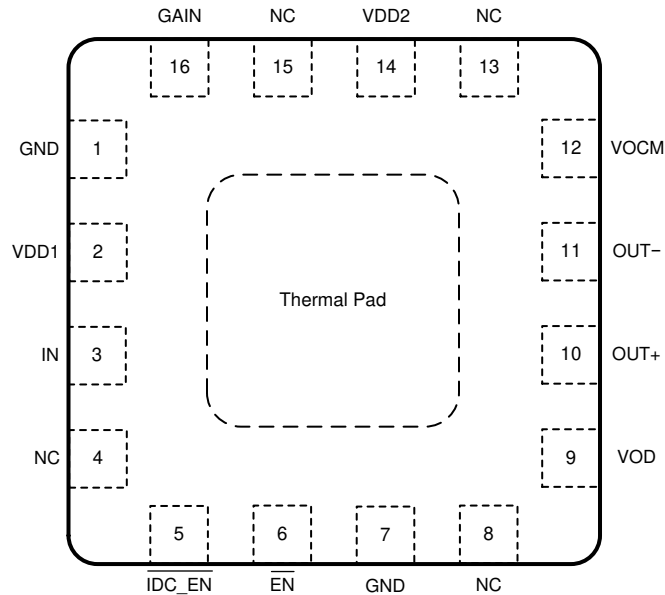

Not to scale

图 5-1. RGT Package, 16-Pin VQFN with Exposed Thermal Pad (Top View)

表 5-1. Pin Functions

PIN		TYPE ⁽²⁾	DESCRIPTION
NAME	NO.		
EN	6	I	Device enable pin. $\overline{\text{EN}}$ = logic low = normal operation (default) ⁽¹⁾ ; EN = logic high = power off mode.
GAIN	16	I	Gain setting. GAIN = low = 2 k Ω (default) ⁽¹⁾ ; GAIN = high = 20 k Ω .
GND	1, 7	I	Amplifier ground.
IDC_EN	5	I	Ambient light cancellation (ALC) loop enable. IDC_EN = logic low = enable DC current cancellation (default) ⁽¹⁾ ; IDC_EN = logic high = disable DC current cancellation.
IN	3	I	Transimpedance amplifier input.
NC	4, 8, 13, 15	—	No connection.
OUT -	11	O	Inverting amplifier output. When light is incident on the photodiode the output pin transitions in a negative direction from the no light condition (APD anode connected to negative bias).
OUT+	10	O	Noninverting amplifier output. When light is incident on the photodiode the output pin transitions in a positive direction from the no light condition (APD anode connected to negative bias).
VDD1	2	I	Positive power supply for the transimpedance amplifier stage.
VDD2	14	I	Positive power supply for the differential amplifier stage. Tie VDD1 and VDD2 to the same power supply with independent power-supply bypassing.
VOCM	12	I	Differential amplifier common-mode output setting.
VOD	9	I	Differential amplifier differential output offset setting.
Thermal pad		—	Connect the thermal pad to GND or the most negative power supply of the device under test (DUT).

- (1) TI recommends driving a digital pin with a low-impedance source rather than leaving the pin floating because fast-moving transients can couple into the pin and inadvertently change the logic level.
- (2) I = input, O = output

DIE THICKNESS	BACKSIDE FINISH	BACKSIDE POTENTIAL	BOND PAD METALLIZATION
381 μm	Silicon with backgrind	Wafer backside is not electrically isolated and should be held at the same potential as the most negative power supply connected to the die (GND)	AlCu



图 5-2. Bare Die Package

表 5-2. Bond Pad Coordinates of Bare Die Version in Microns

PAD NUMBER	PAD NAME	X-MIN	Y-MIN	X-MAX	Y-MAX
1	GND	15	711.4	90	786.4
2	VDD1	15	543	90	618
3	IN	15	362	90	437
4	NC	15	201	90	276
5	IDC_EN	124.675	15	199.675	90
6	EN	286.675	15	361.675	90
7	GND	547.7	15	622.7	90
8	NC	713.675	15	788.675	90
9	VOD	855	169.075	930	244.075
10	OUT+	855	307.6	930	382.6
11	NC	855	452.5	930	527.5
12	OUT-	855	597.325	930	672.325
13	VOCM	855	736.05	930	811.05
14	NC	713.65	890	788.65	965
15	VDD2	547.675	890	622.675	965
16	NC	286.675	890	361.675	965
17	GAIN	124.675	890	199.675	965

6 Specifications

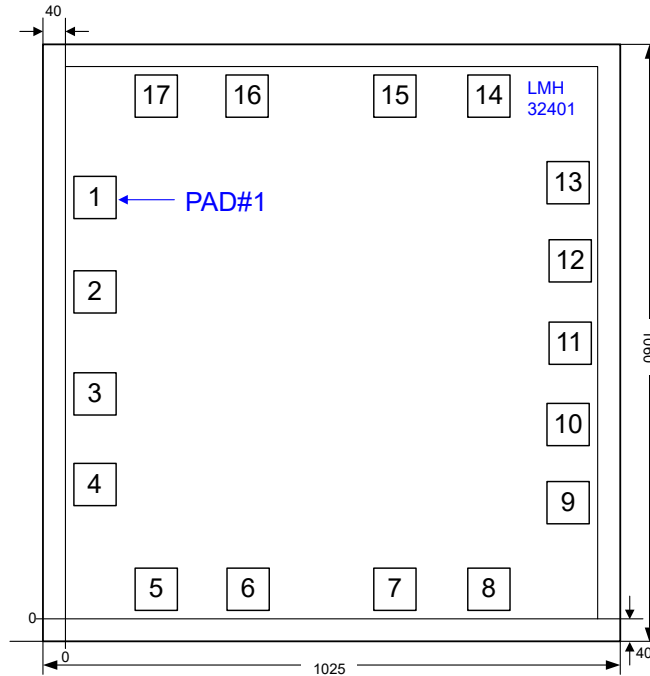
6.1 Absolute Maximum Ratings

over operating free-air temperature range (unless otherwise noted)⁽¹⁾

		MIN	MAX	UNIT
V _{DD1} , V _{DD2}	Total supply voltage, V _{DD} ⁽²⁾		3.65	V
	Voltage at output pins	0	V _{DD}	V
	Voltage at logic pins	- 0.25	V _{DD}	V
I _{IN}	Continuous current into IN		25	mA
I _{OUT}	Continuous output current		35	mA
T _J	Junction temperature		150	°C
T _A	Operating free-air temperature	- 40	125	°C
T _{stg}	Storage temperature	- 65	150	°C

- (1) Stresses beyond those listed under *Absolute Maximum Rating* may cause permanent damage to the device. These are stress ratings only, which do not imply functional operation of the device at these or any other conditions beyond those indicated under *Recommended Operating Condition*. Exposure to absolute-maximum-rated conditions for extended periods may affect device reliability.
- (2) VDD1 and VDD2 should always be tied to the same supply and have separate power-supply bypass capacitors.

6.2 ESD Ratings

			VALUE	UNIT
V _(ESD)	Electrostatic discharge	Human body model (HBM), per ANSI/ESDA/ JEDEC JS-001, all pins ⁽¹⁾	±1000	V
		Charged device model (CDM), per JEDEC specification JESD22-C101, all pins ⁽²⁾	±250	

- (1) JEDEC document JEP155 states that 500-V HBM allows safe manufacturing with a standard ESD control process. Manufacturing with less than 500-V HBM is possible with the necessary precautions.
- (2) JEDEC document JEP157 states that 250-V CDM allows safe manufacturing with a standard ESD control process. Manufacturing with less than 250-V CDM is possible with the necessary precautions.

6.3 Recommended Operating Conditions

over operating free-air temperature range (unless otherwise noted)

		MIN	NOM	MAX	UNIT
V _{DD}	Total supply voltage	3	3.3	3.45	V
T _A	Operating free-air temperature	- 40		125	°C

6.4 Thermal Information

THERMAL METRIC ⁽¹⁾		LMH32401 ⁽²⁾	UNIT
		RGT (VQFN)	
		12 PINS	
R _{θJA}	Junction-to-ambient thermal resistance	56.3	°C/W
R _{θJC(top)}	Junction-to-case (top) thermal resistance	67	°C/W
R _{θJB}	Junction-to-board thermal resistance	31.3	°C/W
Ψ _{JT}	Junction-to-top characterization parameter	3.7	°C/W
Ψ _{JB}	Junction-to-board characterization parameter	31.2	°C/W
R _{θJC(bot)}	Junction-to-case (bottom) thermal resistance	15.6	°C/W

- (1) For more information about traditional and new thermal metrics, see the [Semiconductor and IC Package Thermal Metrics](#) application report.

- (2) Thermal information is applicable to packaged parts only.

6.5 Electrical Characteristics: Gain = 2 k Ω

$V_{DD} = 3.3$ V, $V_{OCM} = \text{open}$, $V_{OD} = 0$ V, $C_{PD}^{(1)} = 1$ pF, $\overline{EN} = 0$ V, $GAIN = 0$ V, $\overline{IDC_EN} = 3.3$ V, $R_L = 100$ Ω , and $T_A = 25^\circ\text{C}$ (unless otherwise noted)

PARAMETER		TEST CONDITIONS	MIN	TYP	MAX	UNIT
AC PERFORMANCE						
SSBW	Small-signal bandwidth	$V_{OUT} = 100$ mV _{PP}		450		MHz
LSBW	Large-signal bandwidth	$V_{OUT} = 1$ V _{PP}		450		MHz
t_R, t_F	Rise and fall time	$V_{OUT} = 100$ mV _{PP} , pulse width = 10 ns		0.8		ns
	Slew rate ⁽²⁾	$V_{OUT} = 1$ V _{PP} , pulse width = 10 ns		1100		V/ μ s
	Overload pulse extention ⁽³⁾	$I_{IN} = 10$ mA, pulse width = 10 ns		4		ns
i_{IN}	Integrated input current noise	$f = 500$ MHz		250		nA _{RMS}
DC PERFORMANCE						
Z_{21}	Small-signal transimpedance gain ⁽⁴⁾		1.75	2	2.25	k Ω
V_{OD}	Differential output offset voltage ($V_{OUT-} - V_{OUT+}$)		-12	3.5	12	mV
$\Delta V_{OD} / \Delta T_A$	Differential output offset voltage drift			± 5.5		μ V/ $^\circ$ C
INPUT PERFORMANCE						
R_{IN}	Input Resistance		60	100	120	Ω
V_{IN}	Default input bias voltage	Input pin floating	2.42	2.47	2.52	V
$\Delta V_{IN} / \Delta T_A$	Default input bias voltage drift	Input pin floating		1.1		mV/ $^\circ$ C
I_{IN}	DC input current range	$Z_{21} < 3$ -dB degradation from $I_{IN} = 50$ μ A	600	705		μ A

(1) Input capacitance of photodiode.

(2) Average of rising and falling slew rate.

(3) Pulse width extension measured at 50% of pulse height of a square wave.

(4) Gain measured at the amplifier output pins when driving a 100- Ω resistive load. At higher resistor loads the gain increases.

6.6 Electrical Characteristics: Gain = 20 k Ω

$V_{DD} = 3.3$ V, $V_{OCM} = \text{open}$, $V_{OD} = 0$ V, $C_{PD}^{(1)} = 1$ pF, $\overline{EN} = 0$ V, $GAIN = 3.3$ V, $\overline{IDC_EN} = 3.3$ V, $R_L = 100$ Ω , and $T_A = 25^\circ\text{C}$ (unless otherwise noted)

PARAMETER		TEST CONDITIONS	MIN	TYP	MAX	UNIT
AC PERFORMANCE						
SSBW	Small-signal bandwidth	$V_{OUT} = 100$ mV _{PP}		275		MHz
LSBW	Large-signal bandwidth	$V_{OUT} = 1$ V _{PP}		275		MHz
t_R, t_F	Rise and fall time	$V_{OUT} = 100$ mV _{PP} , pulse width = 10 ns		1.3		ns
	Slew rate ⁽²⁾	$V_{OUT} = 1$ V _{PP} , pulse width = 10 ns		700		V/ μ s
	Overload pulse extension ⁽⁴⁾	$I_{IN} = 10$ mA, pulse width = 10 ns		4		ns
i_{IN}	Integrated input current noise	$f = 250$ MHz		49		nA _{RMS}
DC PERFORMANCE						
Z_{21}	Small-signal transimpedance gain ⁽³⁾		17	20	22.5	k Ω
V_{OD}	Differential output offset voltage ($V_{OUT-} - V_{OUT+}$)		-20	5	20	mV
$\Delta V_{OD} / \Delta T_A$	Differential output offset voltage			± 17.5		μ V/ $^\circ\text{C}$
INPUT PERFORMANCE						
R_{IN}	Input Resistance		270	350	410	Ω
V_{IN}	Default input bias voltage	Input pin floating	2.42	2.47	2.52	V
$\Delta V_{IN} / \Delta T_A$	Default input bias voltage drift	Input pin floating		1.1		mV/ $^\circ\text{C}$
I_{IN}	DC input current range	$Z_{21} < 3$ -dB degradation from $I_{IN} = 5$ μ A	60	72		μ A

- (1) Input capacitance of photodiode.
- (2) Average of rising and falling slew rate.
- (3) Gain measured at the amplifier output pins when driving a 100- Ω resistive load. At higher resistor loads the gain increases.
- (4) Pulse width extension measured at 50% of pulse height of a square wave.

6.7 Electrical Characteristics: Both Gains

$V_{DD} = 3.3\text{ V}$, $V_{OCM} = \text{open}$, $V_{OD} = 0\text{ V}$, $C_{PD}^{(1)} = 1\text{ pF}$, $\overline{EN} = 0\text{ V}$, $GAIN = 0\text{ V} / 3.3\text{ V}$, $\overline{IDC_EN} = 3.3\text{ V}$, $R_L = 100\ \Omega$, and $T_A = 25^\circ\text{C}$ (unless otherwise noted)

PARAMETER		TEST CONDITIONS	MIN	TYP	MAX	UNIT
OUTPUT PERFORMANCE						
V_{OH}	Single-sided output voltage swing (high) ⁽²⁾	$T_A = 25^\circ\text{C}$	2.87	2.9		V
V_{OL}	Single-sided output voltage swing (low) ⁽²⁾	$T_A = 25^\circ\text{C}$		0.36	0.39	V
I_{OUT}	Linear output drive (sink and source)	$T_A = 25^\circ\text{C}$, $I_{IN} = 500\ \mu\text{A}$, gain = 2 k Ω , $R_L = 25\ \Omega$	24	26.6	32	mA
		$T_A = -40^\circ\text{C}$, $I_{IN} = 500\ \mu\text{A}$, gain = 2 k Ω , $R_L = 25\ \Omega$		27.1		
		$T_A = 125^\circ\text{C}$, $I_{IN} = 500\ \mu\text{A}$, gain = 2 k Ω , $R_L = 25\ \Omega$		25.1		
I_{SC}	Output short-circuit current (differential) ⁽³⁾			70		mA
Z_{OUT}	DC output impedance (amplifier enabled)	Differential impedance	18	21	24	Ω
Z_{OUT}	DC output impedance in shutdown	Differential impedance	2.8	3.3		k Ω
OUTPUT COMMON-MODE CONTROL (V_{OCM}) PERFORMANCE						
SSBW	Small-signal bandwidth	$V_{OCM} = 100\text{ mV}_{PP}$ at V_{OCM} pin		285		MHz
LSBW	Large-signal bandwidth	$V_{OCM} = 1\text{ V}_{PP}$ at V_{OCM} pin		85		MHz
e_N	Output common-mode noise	$f = 10\text{ MHz}$, 1-nF capacitor to GND on V_{OCM} pin		17.8		nV/ $\sqrt{\text{Hz}}$
A_V	Gain, ($\Delta V_{OCM} / \Delta V_{OCM}$)	IN floating, $V_{OCM} = 1.1\text{ V}$ (driven)		1		V/V
	Gain error	$T_A = 25^\circ\text{C}$, $V_{OCM} = 0.7\text{ V}$ to 2.3 V	- 2%	0.5%	2%	
		$T_A = -40^\circ\text{C}$ to 125°C , $V_{OCM} = 0.7\text{ V}$ to 2.3 V		$\pm 1\%$		
	Input impedance			17		k Ω
V_{OCMOS}	V_{OCM} pin default offset from 1.1 V	V_{OCM} floating, (V_{OCM} measured - 1.1 V)	0	10	20	mV
$\Delta V_{OCM} / \Delta I_{IN}$	V_{OCM} error vs Input current	Gain = 20 k Ω , V_{OCM} driven to 1.1 V		- 15		$\mu\text{V}/\mu\text{A}$
V_{OCM}	Output common-mode voltage, $(V_{OUT+} + V_{OUT-})/2$	$T_A = 25^\circ\text{C}$, V_{OCM} pin floating	1.05	1.1	1.15	V
	Output common-mode voltage drift, $(\Delta V_{OCM} / \Delta T_A)$	$T_A = -40^\circ\text{C}$ to 125°C , V_{OCM} pin floating		75		$\mu\text{V}/^\circ\text{C}$
V_{OCM}	Output common-mode voltage, $(V_{OUT+} + V_{OUT-})/2$	$T_A = 25^\circ\text{C}$, V_{OCM} pin driven to 1.1 V	1.05	1.1	1.15	V
	Output common-mode voltage drift, $(\Delta V_{OCM} / \Delta T_A)$	$T_A = -40^\circ\text{C}$ to 125°C , V_{OCM} pin driven to 1.1 V		- 14		$\mu\text{V}/^\circ\text{C}$

LMH32401

ZHCSKC6D - OCTOBER 2019 - REVISED JANUARY 2023

 $V_{DD} = 3.3\text{ V}$, $V_{OCM} = \text{open}$, $V_{OD} = 0\text{ V}$, $C_{PD}^{(1)} = 1\text{ pF}$, $\overline{EN} = 0\text{ V}$, $GAIN = 0\text{ V} / 3.3\text{ V}$, $\overline{IDC_EN} = 3.3\text{ V}$, $R_L = 100\ \Omega$, and $T_A = 25^\circ\text{C}$ (unless otherwise noted)

PARAMETER		TEST CONDITIONS	MIN	TYP	MAX	UNIT
OUTPUT DIFFERENTIAL OFFSET (V_{OD}) PERFORMANCE						
SSBW	Small-signal bandwidth	$V_{OD} = 100\text{ mV}_{PP}$ at VOD pin		45		MHz
LSBW	Large-signal bandwidth	$V_{OD} = 1\text{ V}_{PP}$		14		MHz
V_{OS_D}	Differential output offset, $V_{OUT} = (V_{OUT-} - V_{OUT+})$	IN floating, $V_{OD} = 0.5\text{ V}$	490	510	530	mV
	Differential output offset drift, $\Delta V_{OS_D} / \Delta T_A$	IN floating, $V_{OD} = 0.5\text{ V}$		0.03		mV/°C
V_{OS_D}	Differential output offset, $V_{OUT} = (V_{OUT-} - V_{OUT+})$	IN floating, VOD floating	490	510	530	mV
	Differential output offset drift, $\Delta V_{OS_D} / \Delta T_A$	IN floating, VOD floating		0.04		mV/°C
A_V	Gain, ($\Delta V_{OUT} / \Delta V_{OD}$), where $V_{OUT} = (V_{OUT-} - V_{OUT+})$	IN floating, $V_{OCM} = 1.1\text{ V}$ (driven)		1.01		V/V
	Gain error	$T_A = 25^\circ\text{C}$, $V_{OD} = 0\text{ V}$ to 1.2 V $T_A = -40^\circ\text{C}$ to 125°C , $V_{OD} = 0\text{ V}$ to 1.2 V	-5%	-1%	5%	
	Input impedance			2.5		k Ω
AMBIENT LIGHT CANCELLATION PERFORMANCE ($\overline{IDC_EN} = 0\text{ V}$)⁽⁴⁾						
	Settling time (within V_{OD} limit)	$I_{IN} = 0\ \mu\text{A} \rightarrow 100\ \mu\text{A}$, $GAIN = 2\text{ k}\Omega$		18		μs
		$I_{IN} = 0\ \mu\text{A} \rightarrow 10\ \mu\text{A}$, $GAIN = 20\text{ k}\Omega$		2.5		
		$I_{IN} = 100\ \mu\text{A} \rightarrow 0\ \mu\text{A}$, $GAIN = 2\text{ k}\Omega$		35		
		$I_{IN} = 10\ \mu\text{A} \rightarrow 0\ \mu\text{A}$, $GAIN = 20\text{ k}\Omega$		13		
	Ambient light current cancellation range	Differential output offset ($V_{OUT-} - V_{OUT+}$) shift from $I_{DC} = 10\ \mu\text{A} < \pm 10\text{ mV}$	2	3		mA
POWER SUPPLY						
I_Q	Quiescent current, total	$T_A = 25^\circ\text{C}$	24	30	33.5	mA
		$T_A = 125^\circ\text{C}$		32		
		$T_A = -40^\circ\text{C}$		27		
PSRR+	Positive power-supply rejection ratio, $V_{DD1} = V_{DD2}$		54	66		dB
SHUTDOWN						
I_Q	Disabled quiescent current ($\overline{EN} = V_{DD}$)	$T_A = 25^\circ\text{C}$	2.4	3.3	4.2	mA
		$T_A = -40^\circ\text{C}$		2.75		
		$T_A = 125^\circ\text{C}$		5.2		
	Enable pin input bias current	$T_A = 25^\circ\text{C}$		75	120	μA

- (1) Input capacitance of photodiode.
- (2) Output levels achieved by adjusting V_{OCM} , V_{OD} , and input current.
- (3) Device cannot withstand continuous short-circuit between the differential outputs.
- (4) Enabling the ambient light cancellation loop adds noise to the system.

6.8 Electrical Characteristics: Logic Threshold and Switching Characteristics

$V_{DD} = 3.3\text{ V}$, $V_{OCM} = \text{Open}$, $V_{OD} = 0\text{ V}$, $C_{PD}^{(1)} = 1\text{ pF}$, $\overline{EN} = 0\text{ V}$, $GAIN = 0\text{ V} / 3.3\text{ V}$, $\overline{IDC_EN} = 3.3\text{ V}$, $R_L = 100\ \Omega$, and $T_A = 25^\circ\text{C}$. (unless otherwise noted)

PARAMETER	TEST CONDITIONS	MIN	TYP	MAX	UNIT
LOGIC THRESHOLD PERFORMANCE					
High gain enable, threshold voltage	Amplifier in high gain above this voltage		1.8	2	V
Low gain enable, threshold voltage	Amplifier in low gain below this voltage	0.8	1		V
\overline{EN} control, disable threshold voltage	Amplifier disabled above this voltage		1.8	2	V
\overline{EN} control, enable threshold voltage	Amplifier enabled below this voltage	0.8	1		V
$\overline{IDC_EN}$ control, disable threshold voltage	Ambient light cancellation loop disabled above this voltage		1.8	2	V
$\overline{IDC_EN}$ control, enable threshold voltage	Ambient light cancellation loop enabled below this voltage	0.8	1		V
GAIN CONTROL TRANSIENT PERFORMANCE					
High gain to low gain transition-time, (1% settling)	Ambient loop disabled, $f_{IN} = 25\text{ MHz}$, $V_{OUT} = 1\text{ V}_{PP}$ (Initial condition), $I_{DC} = 0\ \mu\text{A}$		90		ns
Low gain to high gain transition-time, (1% settling)	Ambient loop disabled, $f_{IN} = 25\text{ MHz}$, $V_{OUT} = 1\text{ V}_{PP}$ (Final condition), $I_{DC} = 0\ \mu\text{A}$		750		ns
High gain to low gain transition-time, (1% settling)	Ambient loop enabled, $f_{IN} = 25\text{ MHz}$, $V_{OUT} = 1\text{ V}_{PP}$ (Initial condition), $I_{DC} = 100\ \mu\text{A}$		4		μs
Low gain to high gain transition-time, (1% settling)	Ambient loop enabled, $f_{IN} = 25\text{ MHz}$, $V_{OUT} = 1\text{ V}_{PP}$ (Final condition), $I_{DC} = 100\ \mu\text{A}$		4		μs
\overline{EN} CONTROL TRANSIENT PERFORMANCE					
Enable transition-time (1% settling)	Ambient loop disabled, $f_{IN} = 25\text{ MHz}$, $V_{OUT} = 1\text{ V}_{PP}$, $I_{DC} = 0\ \mu\text{A}$, $GAIN = 2\text{ k}\Omega$		125		ns
Disable transition-time (1% settling)	Ambient loop disabled, $f_{IN} = 25\text{ MHz}$, $V_{OUT} = 1\text{ V}_{PP}$, $I_{DC} = 0\ \mu\text{A}$, $GAIN = 2\text{ k}\Omega$		3		ns
Enable transition-time (1% settling)	Ambient loop disabled, $f_{IN} = 25\text{ MHz}$, $V_{OUT} = 1\text{ V}_{PP}$, $I_{DC} = 0\ \mu\text{A}$, $GAIN = 20\text{ k}\Omega$		850		ns
Disable transition-time (1% settling)	Ambient loop disabled, $f_{IN} = 25\text{ MHz}$, $V_{OUT} = 1\text{ V}_{PP}$, $I_{DC} = 0\ \mu\text{A}$, $GAIN = 20\text{ k}\Omega$		3		ns
Enable transition-time (1% settling)	Ambient loop enabled, $f_{IN} = 25\text{ MHz}$, $V_{OUT} = 1\text{ V}_{PP}$, $I_{DC} = 100\ \mu\text{A}$, $GAIN = 2\text{ k}\Omega$		10		μs
Disable transition-time (1% settling)	Ambient loop enabled, $f_{IN} = 25\text{ MHz}$, $V_{OUT} = 1\text{ V}_{PP}$, $I_{DC} = 100\ \mu\text{A}$, $GAIN = 20\text{ k}\Omega$		3.5		ns
Enable transition-time (1% settling)	Ambient loop enabled, $f_{IN} = 25\text{ MHz}$, $V_{OUT} = 1\text{ V}_{PP}$, $I_{DC} = 100\ \mu\text{A}$, $GAIN = 20\text{ k}\Omega$		4		μs
Disable transition-time (1% settling)	Ambient loop enabled, $f_{IN} = 25\text{ MHz}$, $V_{OUT} = 1\text{ V}_{PP}$, $I_{DC} = 100\ \mu\text{A}$, $GAIN = 2\text{ k}\Omega$		3		ns

(1) Input capacitance of photodiode.

6.9 Typical Characteristics

At $V_{DD} = 3.3\text{ V}$, $V_{OCM} = \text{open}$, $V_{OD} = 0\text{ V}$, $C_{PD} = 1\text{ pF}$, $\overline{EN} = 0\text{ V}$ (enabled), $\overline{IDC_EN} = 3.3\text{ V}$ (disabled), $R_L = 100\ \Omega$ (differential load between $OUT+$ and $OUT-$), and $T_A = 25^\circ\text{C}$ (unless otherwise noted).



图 6-1. Small Signal Response vs Input Capacitance



图 6-2. Small Signal Response vs Input Capacitance

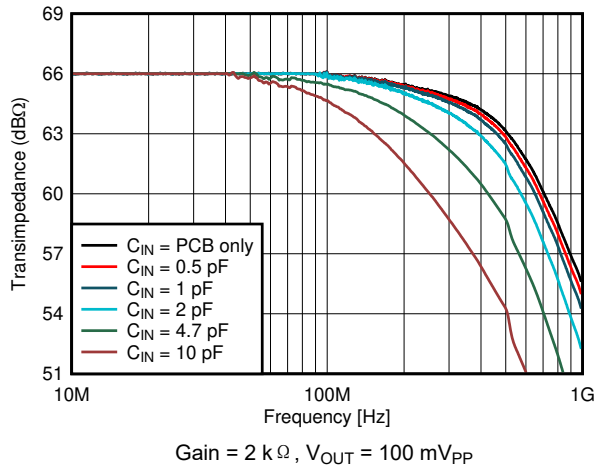

图 6-3. Large Signal Response vs Input Capacitance

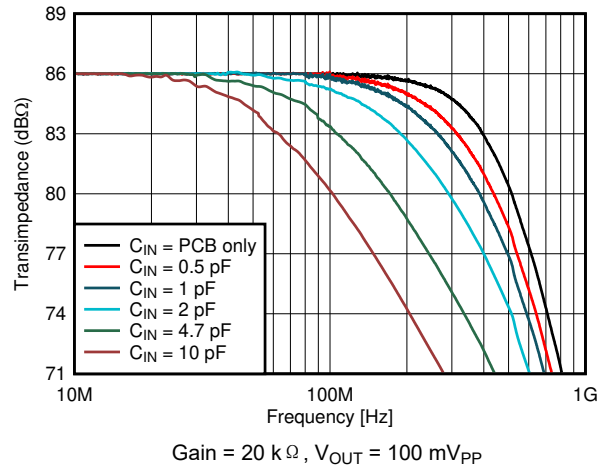

图 6-4. Large Signal Response vs Input Capacitance

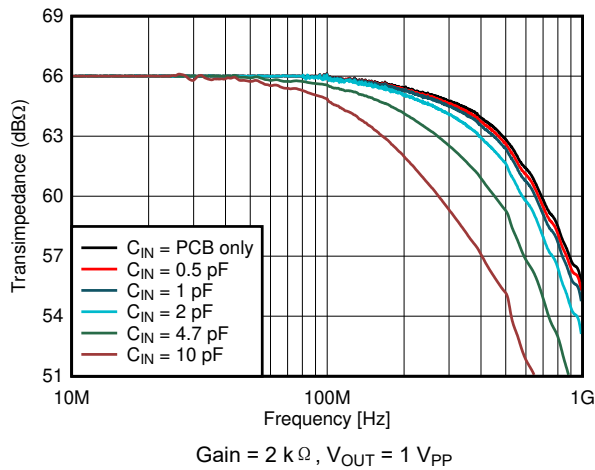

图 6-5. Small Signal Response vs Load Capacitance

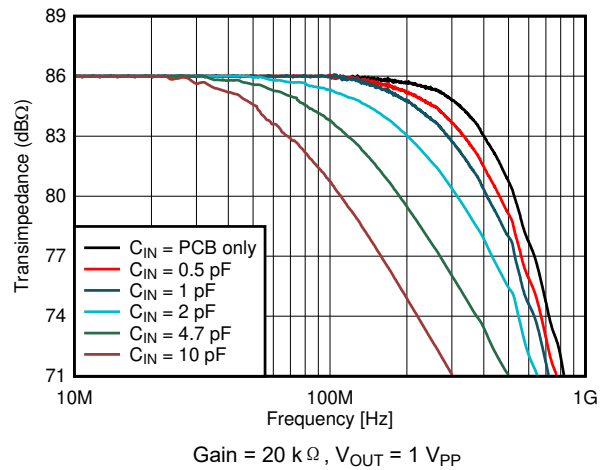

图 6-6. Small Signal Response vs Load Capacitance

6.9 Typical Characteristics (continued)

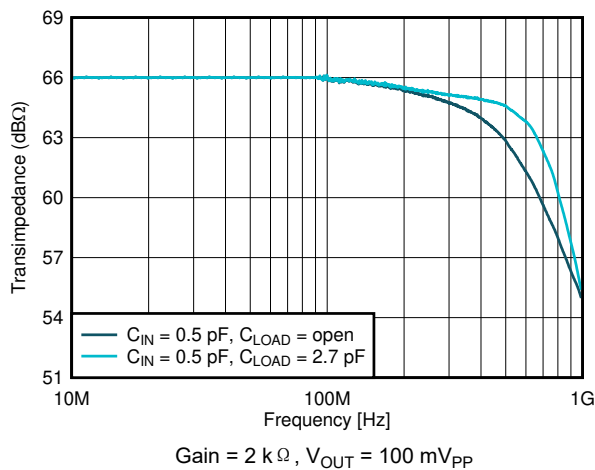
At $V_{DD} = 3.3\text{ V}$, $V_{OCM} = \text{open}$, $V_{OD} = 0\text{ V}$, $C_{PD} = 1\text{ pF}$, $\overline{EN} = 0\text{ V}$ (enabled), $\overline{IDC_EN} = 3.3\text{ V}$ (disabled), $R_L = 100\ \Omega$ (differential load between $OUT+$ and $OUT-$), and $T_A = 25^\circ\text{C}$ (unless otherwise noted).

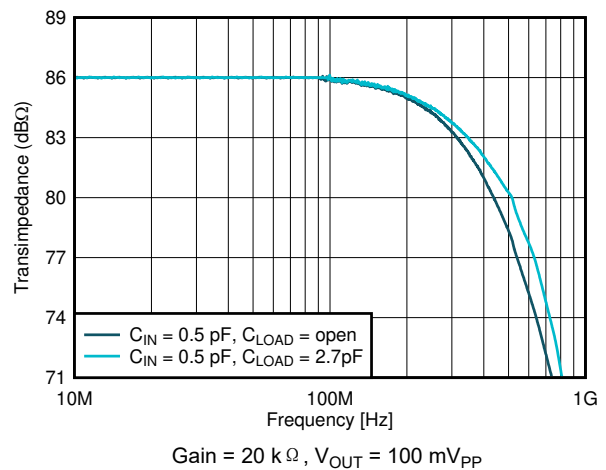

图 6-7. Small Signal Response vs Ambient Temperature



图 6-8. Small Signal Response vs Ambient Temperature

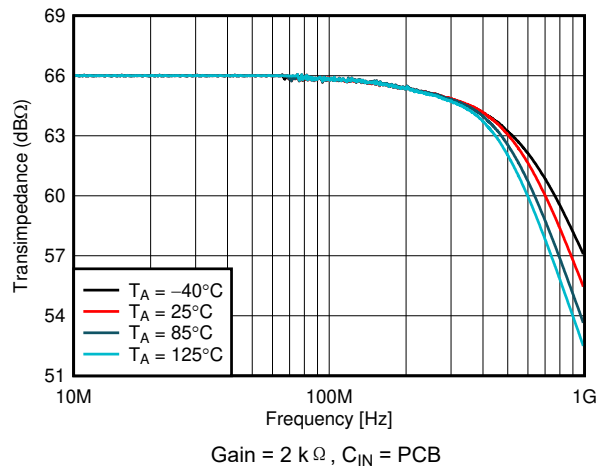

图 6-9. Low-side Frequency Response vs Ambient Light Cancellation

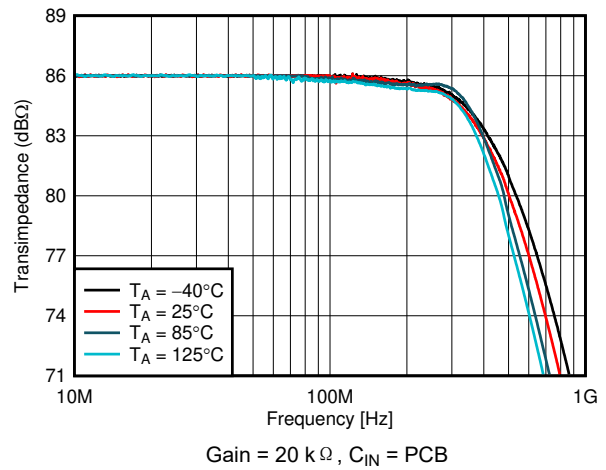

图 6-10. Closed-loop Output Impedance vs Frequency

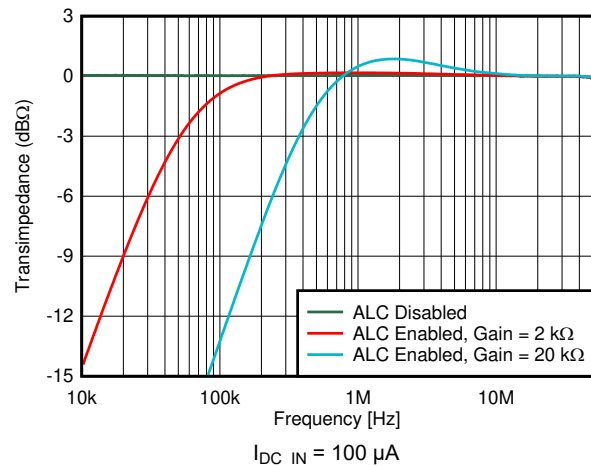

图 6-11. Input Noise Density vs Input Capacitance

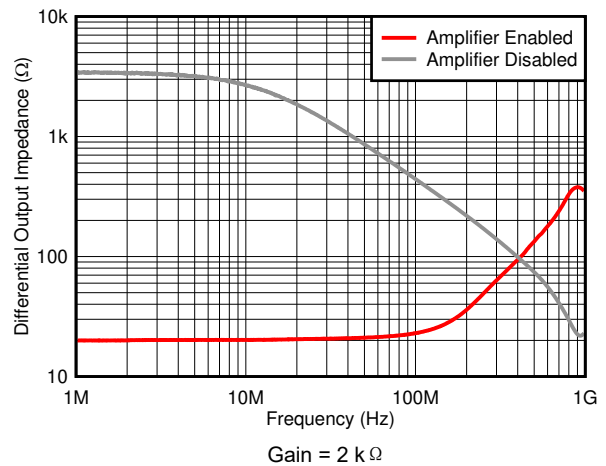

图 6-12. Input Noise Density vs Input Capacitance

6.9 Typical Characteristics (continued)

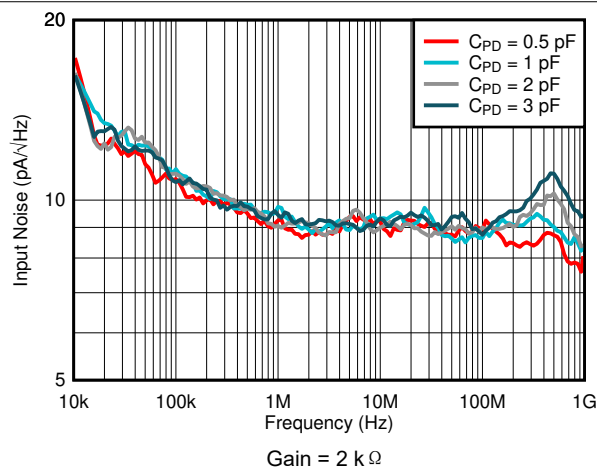
At $V_{DD} = 3.3\text{ V}$, $V_{OCM} = \text{open}$, $V_{OD} = 0\text{ V}$, $C_{PD} = 1\text{ pF}$, $\overline{EN} = 0\text{ V}$ (enabled), $\overline{IDC_EN} = 3.3\text{ V}$ (disabled), $R_L = 100\ \Omega$ (differential load between $OUT+$ and $OUT-$), and $T_A = 25^\circ\text{C}$ (unless otherwise noted).

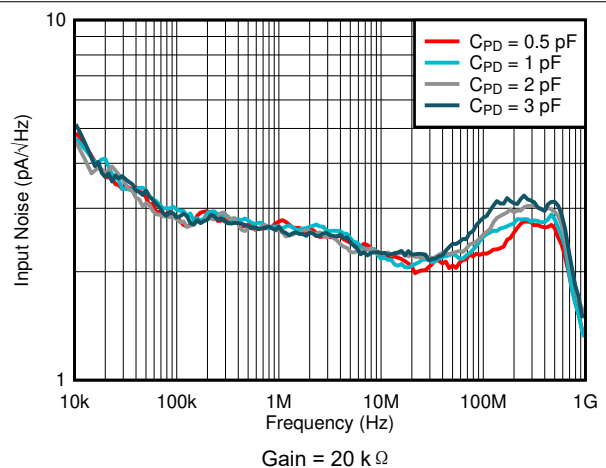

图 6-13. Input Noise Density vs Load Capacitance



图 6-14. Input Noise Density vs Load Capacitance

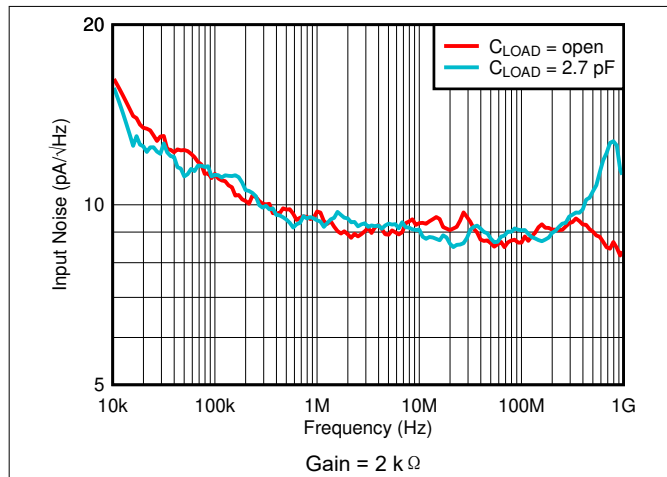

图 6-15. Input Noise Density vs Ambient Light DC Current

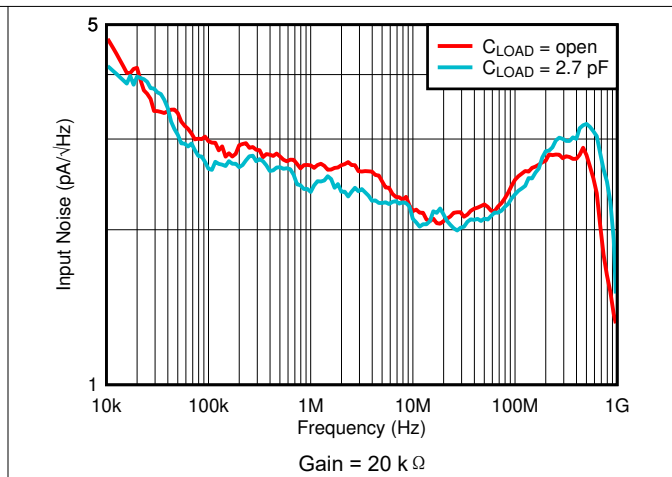

图 6-16. Input Noise Density vs Ambient Light DC Current

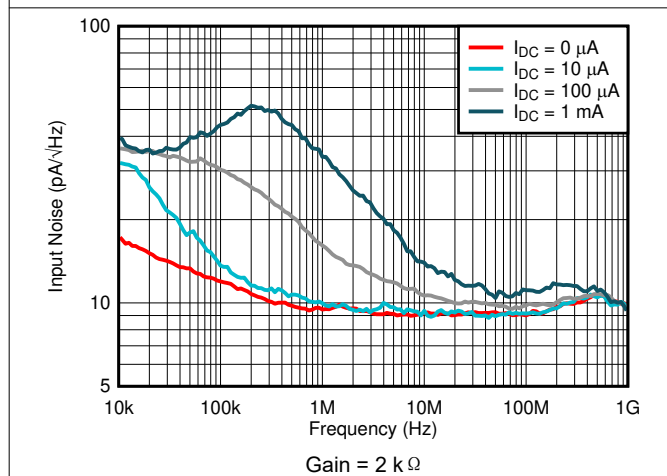

图 6-17. Input Noise Density vs Ambient Temperature

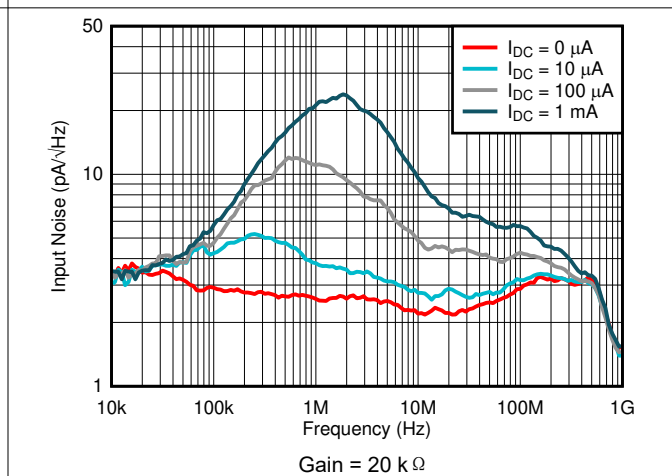

图 6-18. Output Noise Density vs Output Configuration

6.9 Typical Characteristics (continued)

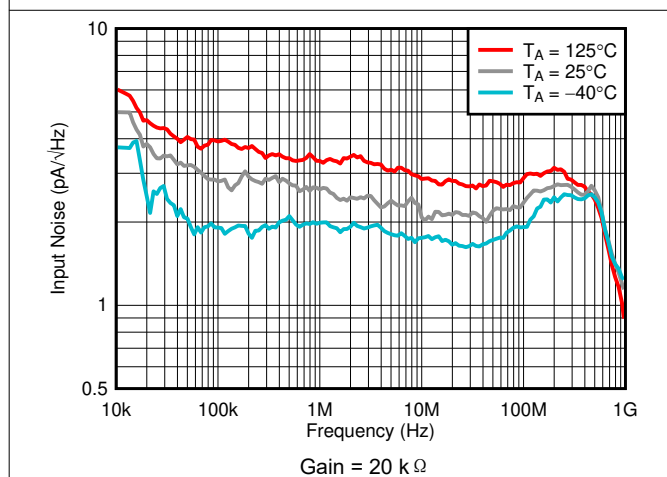
At $V_{DD} = 3.3\text{ V}$, $V_{OCM} = \text{open}$, $V_{OD} = 0\text{ V}$, $C_{PD} = 1\text{ pF}$, $\overline{EN} = 0\text{ V}$ (enabled), $\overline{IDC_EN} = 3.3\text{ V}$ (disabled), $R_L = 100\ \Omega$ (differential load between $OUT+$ and $OUT-$), and $T_A = 25^\circ\text{C}$ (unless otherwise noted).

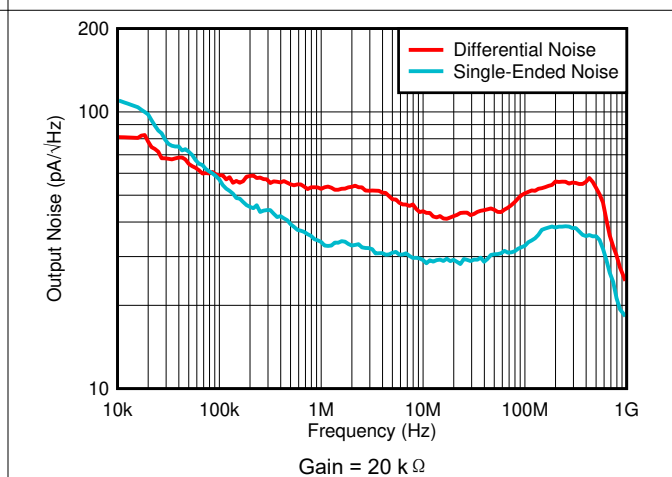

图 6-19. Pulse Response vs Output Swing



图 6-20. Pulse Response vs Output Swing

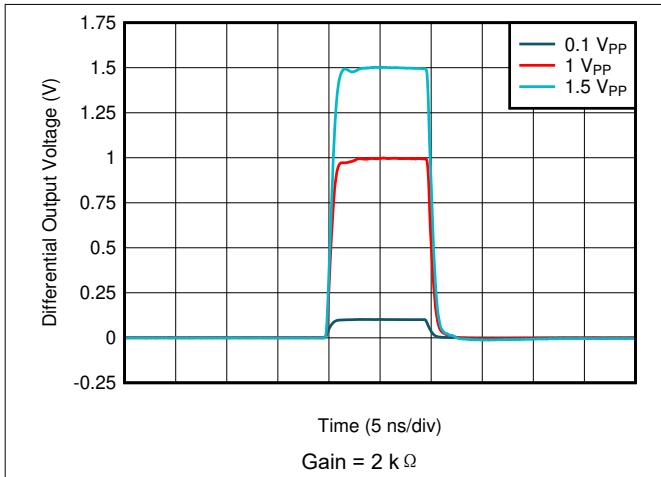

图 6-21. Overloaded Pulse Response

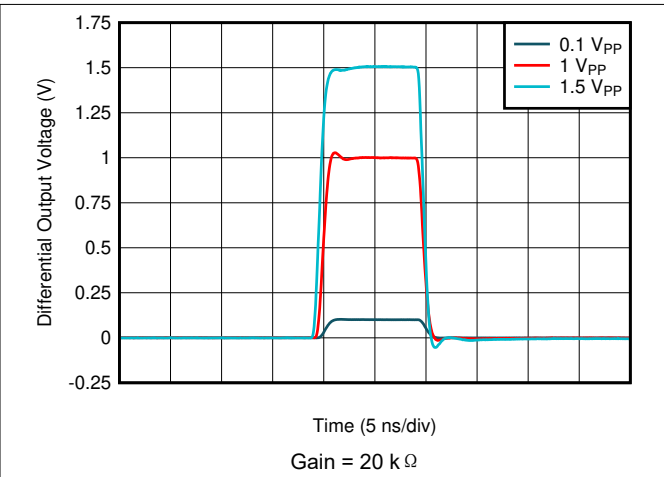

图 6-22. Overloaded Pulse Response

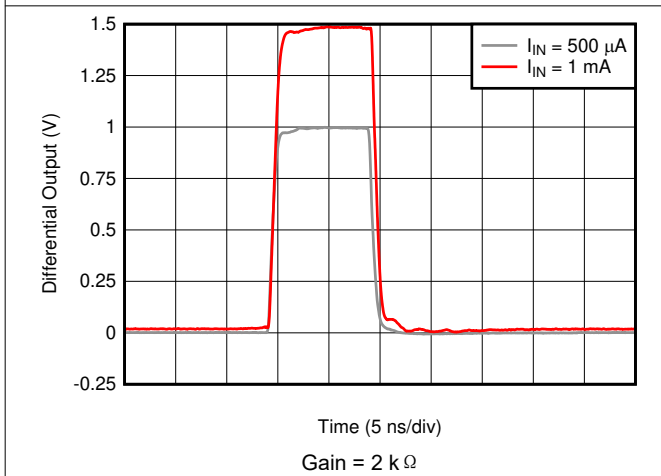

图 6-23. Turn-On Time

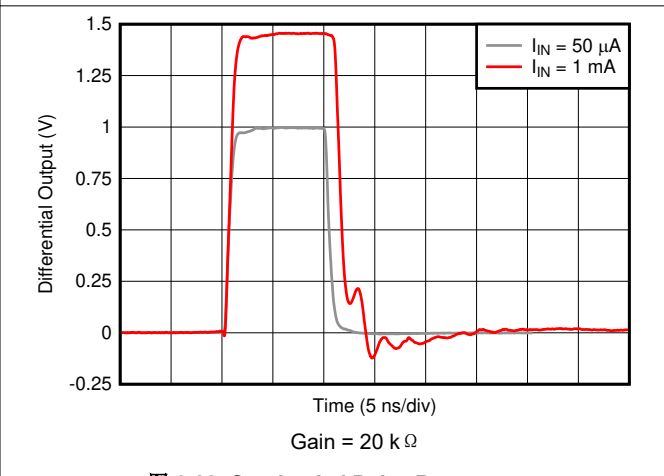

图 6-24. Turn-On Time

6.9 Typical Characteristics (continued)

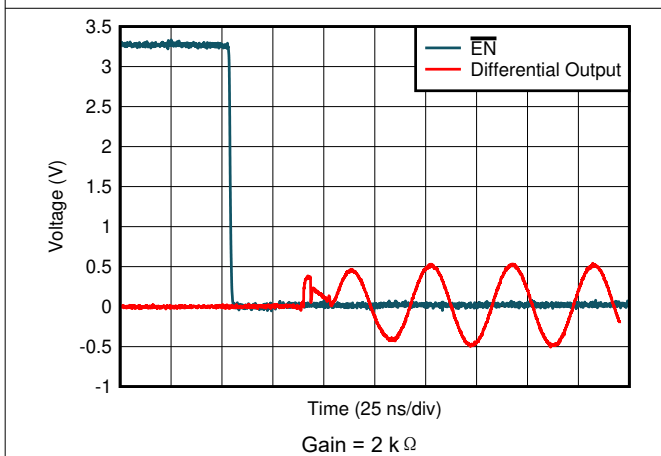
At $V_{DD} = 3.3\text{ V}$, $V_{OCM} = \text{open}$, $V_{OD} = 0\text{ V}$, $C_{PD} = 1\text{ pF}$, $\overline{EN} = 0\text{ V}$ (enabled), $\overline{IDC_EN} = 3.3\text{ V}$ (disabled), $R_L = 100\ \Omega$ (differential load between $OUT+$ and $OUT-$), and $T_A = 25^\circ\text{C}$ (unless otherwise noted).

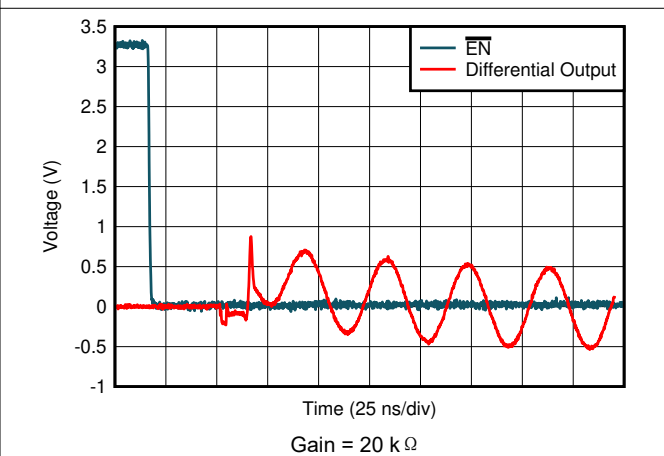

图 6-25. Turn-Off Time



图 6-26. Turn-Off Time

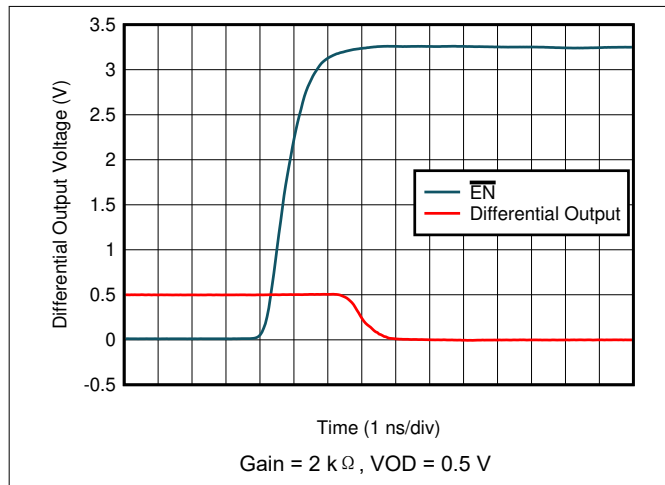

图 6-27. Ambient Loop Cancellation Settling Time

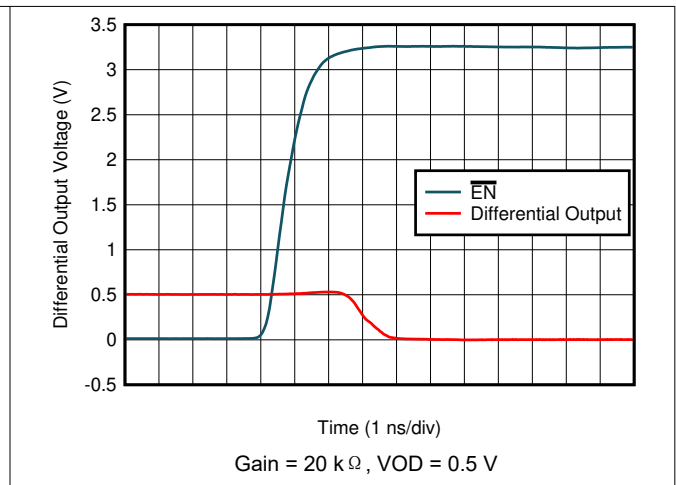

图 6-28. Ambient Loop Cancellation Settling Time

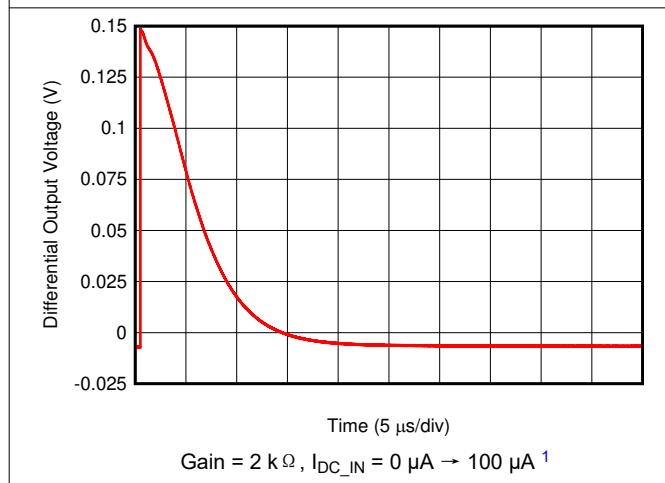

图 6-29. Ambient Loop Cancellation Settling Time

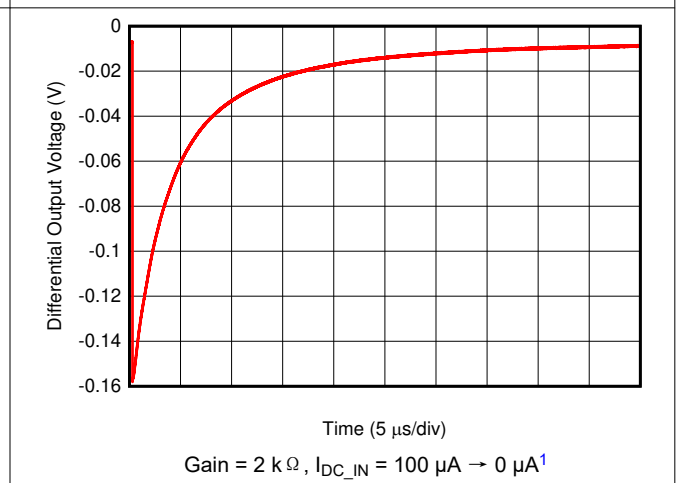

图 6-30. Ambient Loop Cancellation Settling Time

¹ Current due to ambient light transitions at $t = 0$ in.

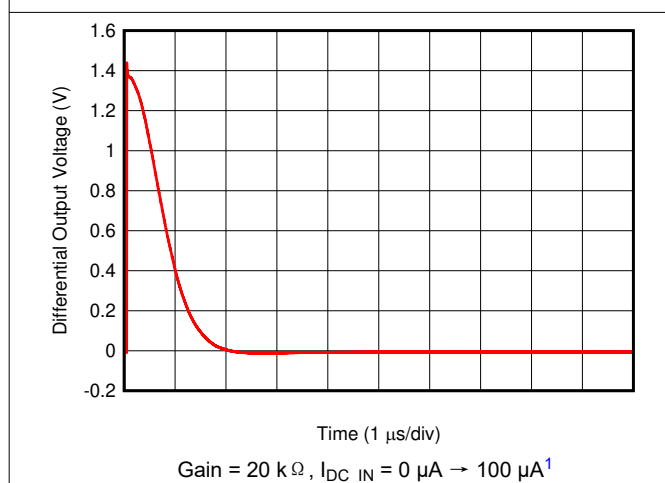
6.9 Typical Characteristics (continued)

At $V_{DD} = 3.3\text{ V}$, $V_{OCM} = \text{open}$, $V_{OD} = 0\text{ V}$, $C_{PD} = 1\text{ pF}$, $\overline{\text{EN}} = 0\text{ V}$ (enabled), $\overline{\text{IDC_EN}} = 3.3\text{ V}$ (disabled), $R_L = 100\ \Omega$ (differential load between $\text{OUT}+$ and $\text{OUT}-$), and $T_A = 25^\circ\text{C}$ (unless otherwise noted).

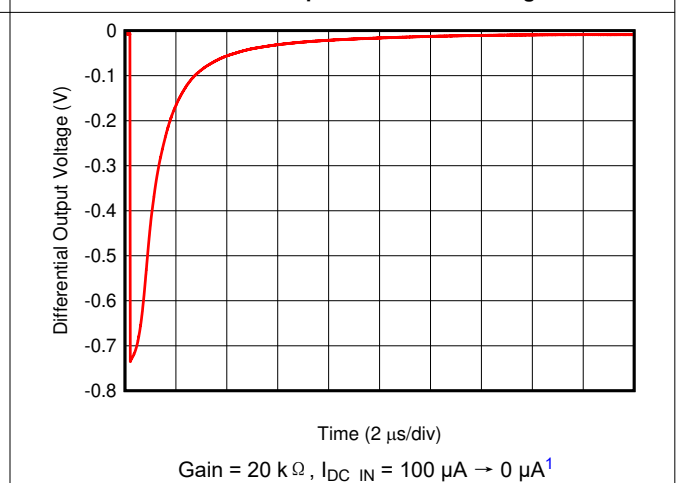

图 6-31. Transimpedance Gain vs Input Current



图 6-32. Transimpedance Gain vs Input Current

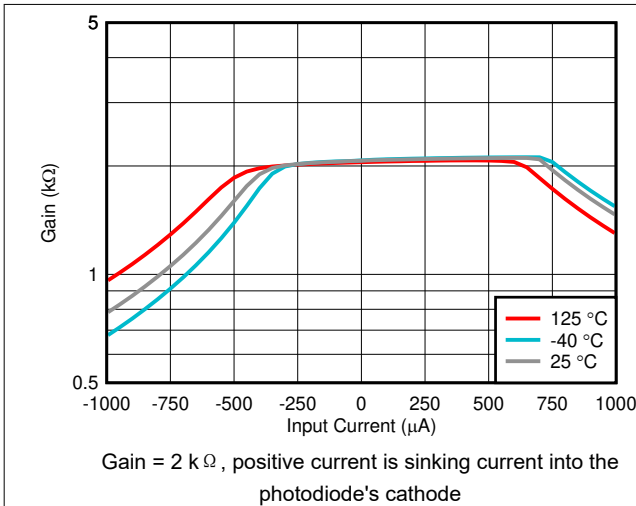

图 6-33. Transimpedance Gain vs Ambient Temperature

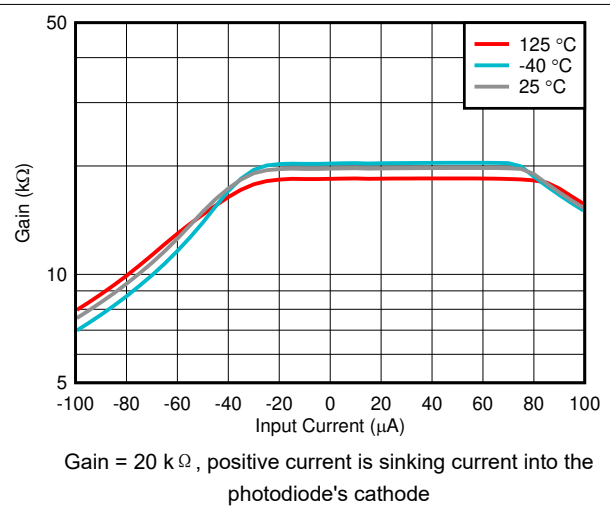

图 6-34. Transimpedance Gain vs Ambient Temperature

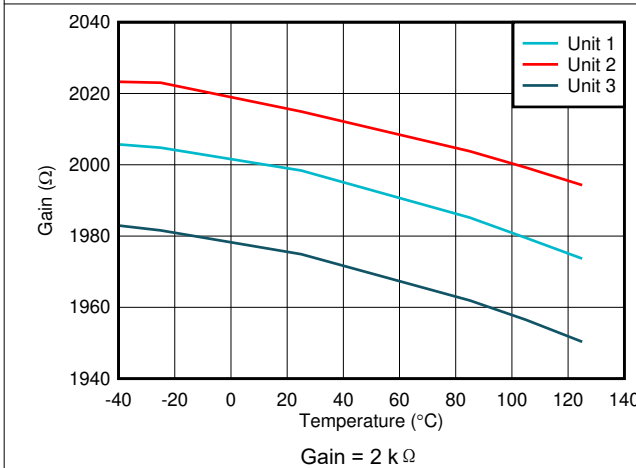

图 6-35. Input Bias Voltage vs Supply Voltage

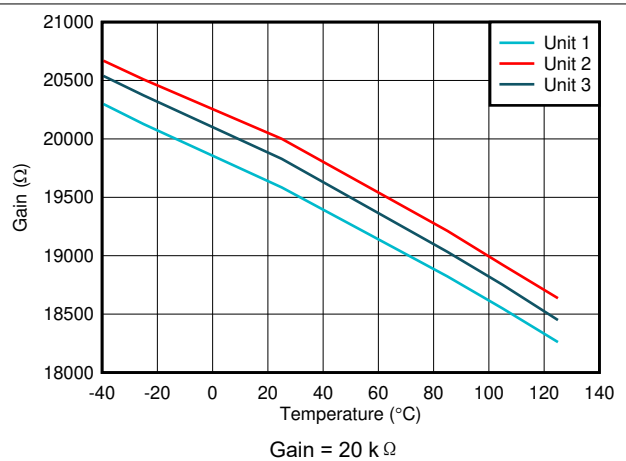

图 6-36. Input Bias Voltage vs Ambient Temperature

6.9 Typical Characteristics (continued)

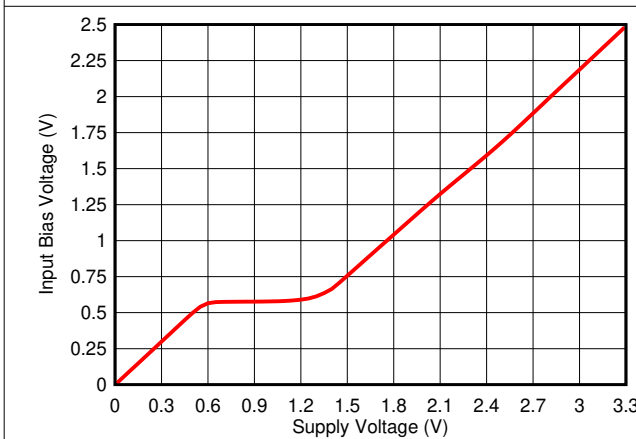
At $V_{DD} = 3.3\text{ V}$, $V_{OCM} = \text{open}$, $V_{OD} = 0\text{ V}$, $C_{PD} = 1\text{ pF}$, $\overline{EN} = 0\text{ V}$ (enabled), $\overline{IDC_EN} = 3.3\text{ V}$ (disabled), $R_L = 100\ \Omega$ (differential load between $OUT+$ and $OUT-$), and $T_A = 25^\circ\text{C}$ (unless otherwise noted).

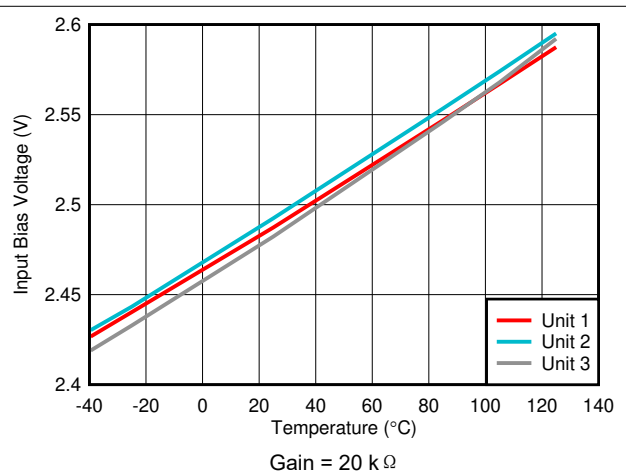

图 6-37. Quiescent Current vs Ambient Temperature



图 6-38. Quiescent Current vs Supply Voltage

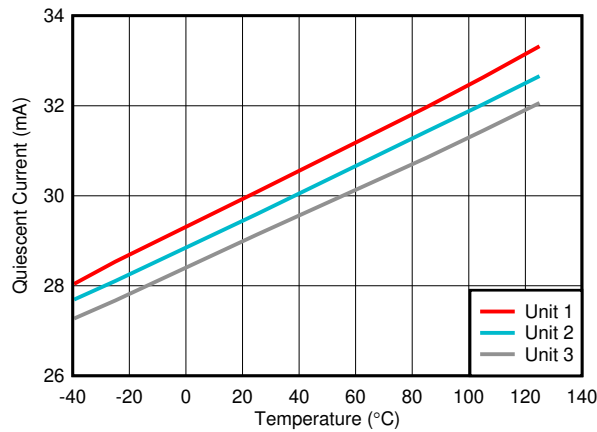

图 6-39. High-side Swing vs Input Current

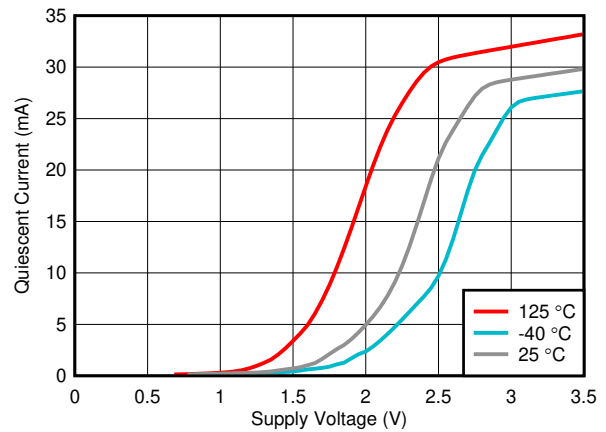

图 6-40. Low-side Swing vs Input Current

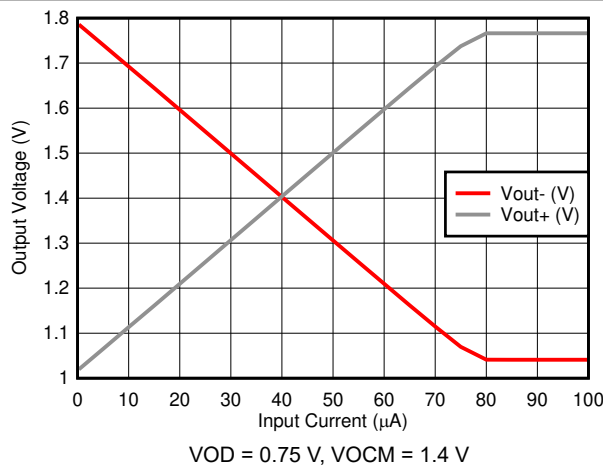

图 6-41. Differential Output Offset Gain

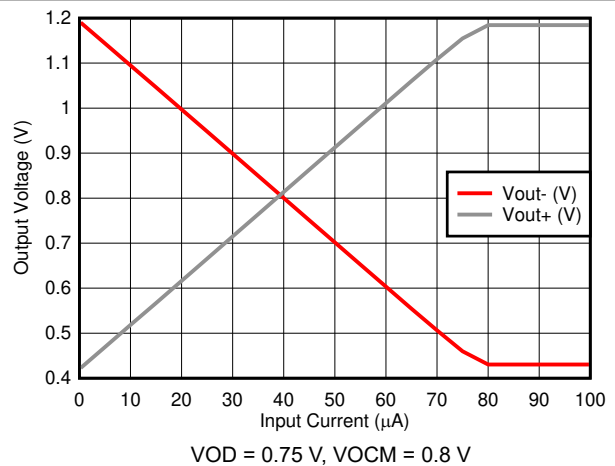

图 6-42. Ambient Light Cancellation Range vs Ambient Temperature

6.9 Typical Characteristics (continued)

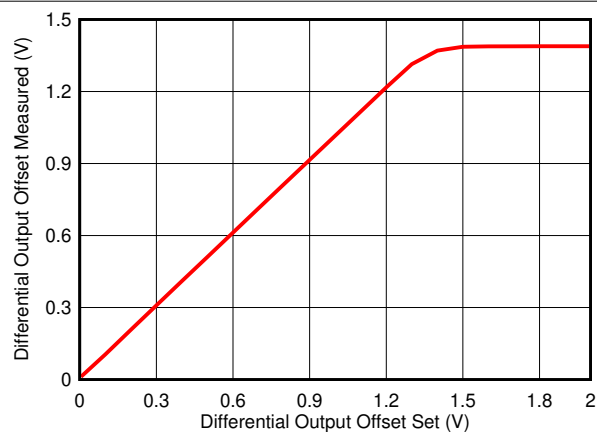
At $V_{DD} = 3.3\text{ V}$, $V_{OCM} = \text{open}$, $V_{OD} = 0\text{ V}$, $C_{PD} = 1\text{ pF}$, $\overline{\text{EN}} = 0\text{ V}$ (enabled), $\overline{\text{IDC_EN}} = 3.3\text{ V}$ (disabled), $R_L = 100\ \Omega$ (differential load between $\text{OUT}+$ and $\text{OUT}-$), and $T_A = 25^\circ\text{C}$ (unless otherwise noted).

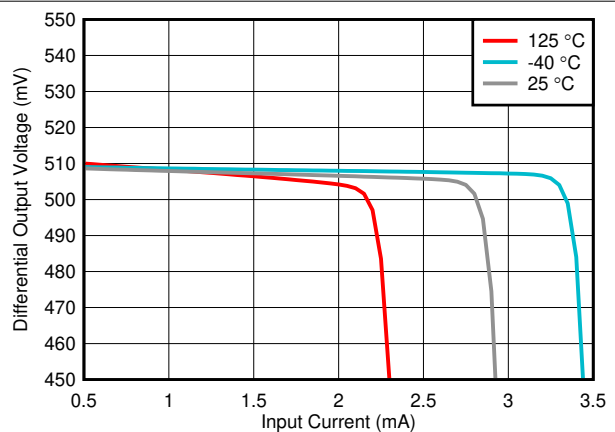
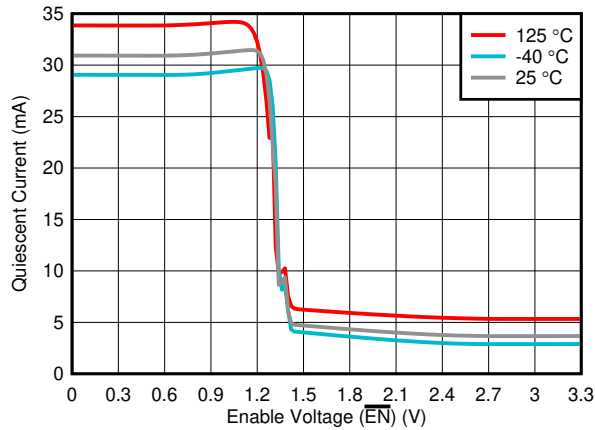

Logic switching demonstrated using $\overline{\text{EN}}$ pin. $\overline{\text{IDC_EN}}$ and gain pins behave similarly.

图 6-43. Logic Threshold vs Ambient Temperature



图 6-44. Quiescent Current Distribution



图 6-45. Transimpedance Gain (Low) Distribution

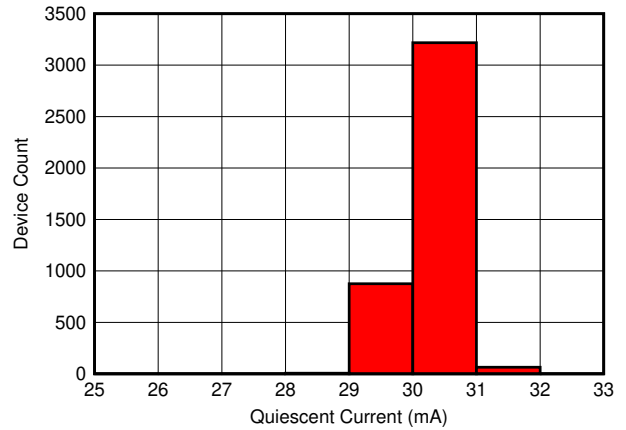

图 6-46. Transimpedance Gain (High) Distribution

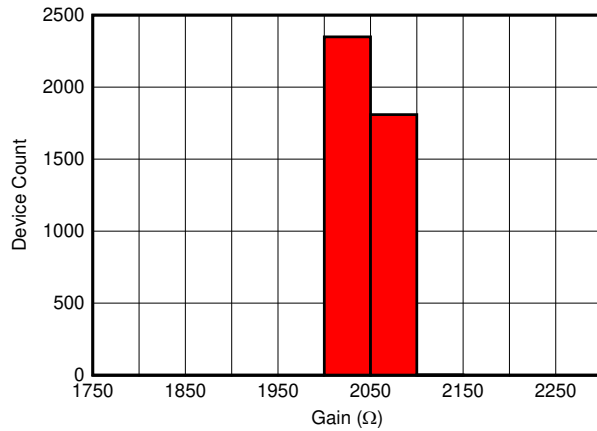

图 6-47. Output Common-Mode Voltage (V_{OCM}) Distribution

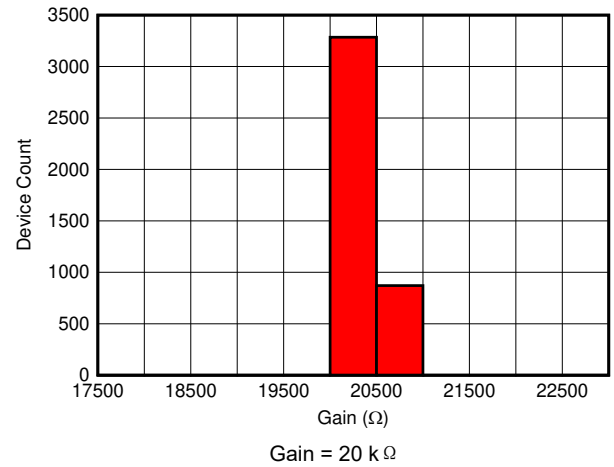

图 6-48. Differential Output Offset Voltage (V_{OD}) Distribution

6.9 Typical Characteristics (continued)

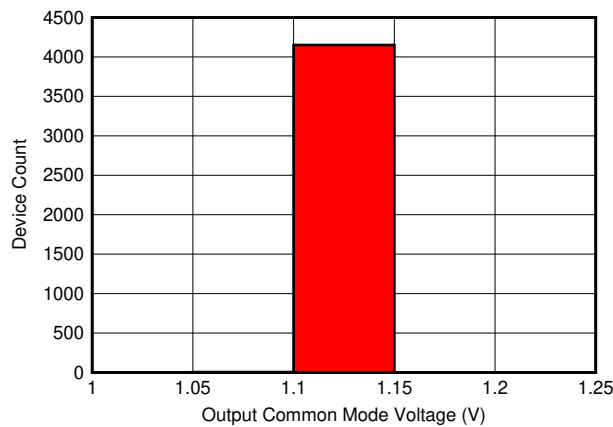
At $V_{DD} = 3.3\text{ V}$, $V_{OCM} = \text{open}$, $V_{OD} = 0\text{ V}$, $C_{PD} = 1\text{ pF}$, $\overline{EN} = 0\text{ V}$ (enabled), $\overline{IDC_EN} = 3.3\text{ V}$ (disabled), $R_L = 100\ \Omega$ (differential load between $OUT+$ and $OUT-$), and $T_A = 25^\circ\text{C}$ (unless otherwise noted).

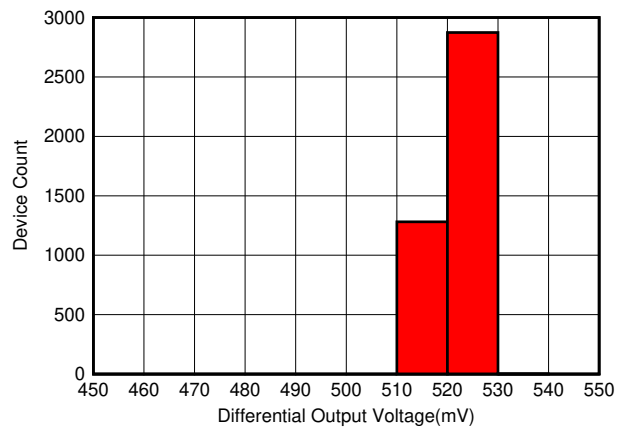
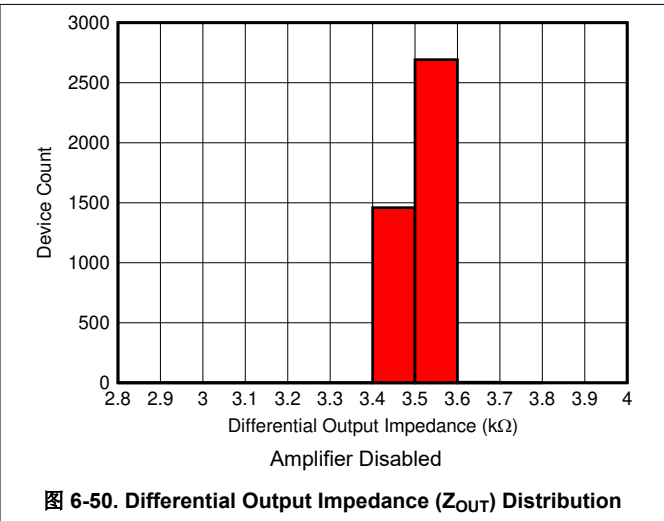
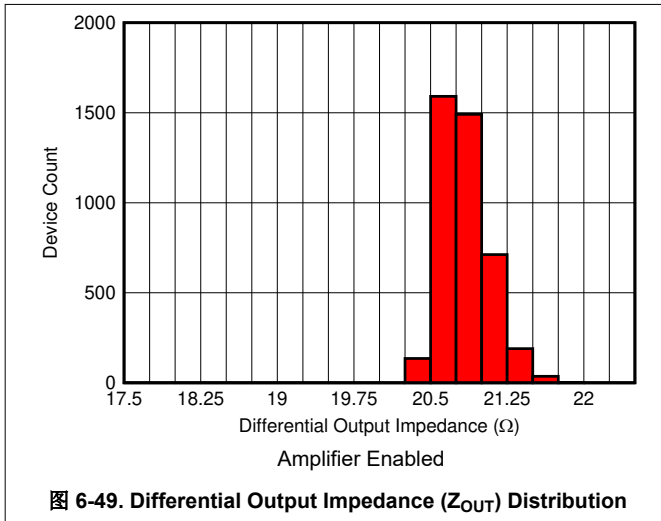

7 Detailed Description

7.1 Overview

The LMH32401 device is a single-channel, differential output, high-speed transimpedance amplifier (TIA) that features several integrated functions geared towards light detection and ranging (LIDAR) and pulsed time-of-flight (ToF) systems. The LMH32401 device is designed to work with photodiode (PD) configurations that can source or sink the current. When the photodiode sinks the photocurrent (anode is biased to a negative voltage and cathode is tied to the amplifier input) the fast recovery clamp activates when the amplifier input is overloaded. When the photodiode sources the photocurrent (cathode is biased to a positive voltage and anode is tied to the amplifier input) a soft clamp activates when the amplifier input is overloaded. When the soft clamp activates, the amplifier takes longer to recover. The recovery time depends on the level of input overload. The LMH32401 device is offered in a space-saving 3-mm × 3-mm, 16-pin VQFN package and is rated over a temperature range from -40°C to +125°C.

7.2 Functional Block Diagram

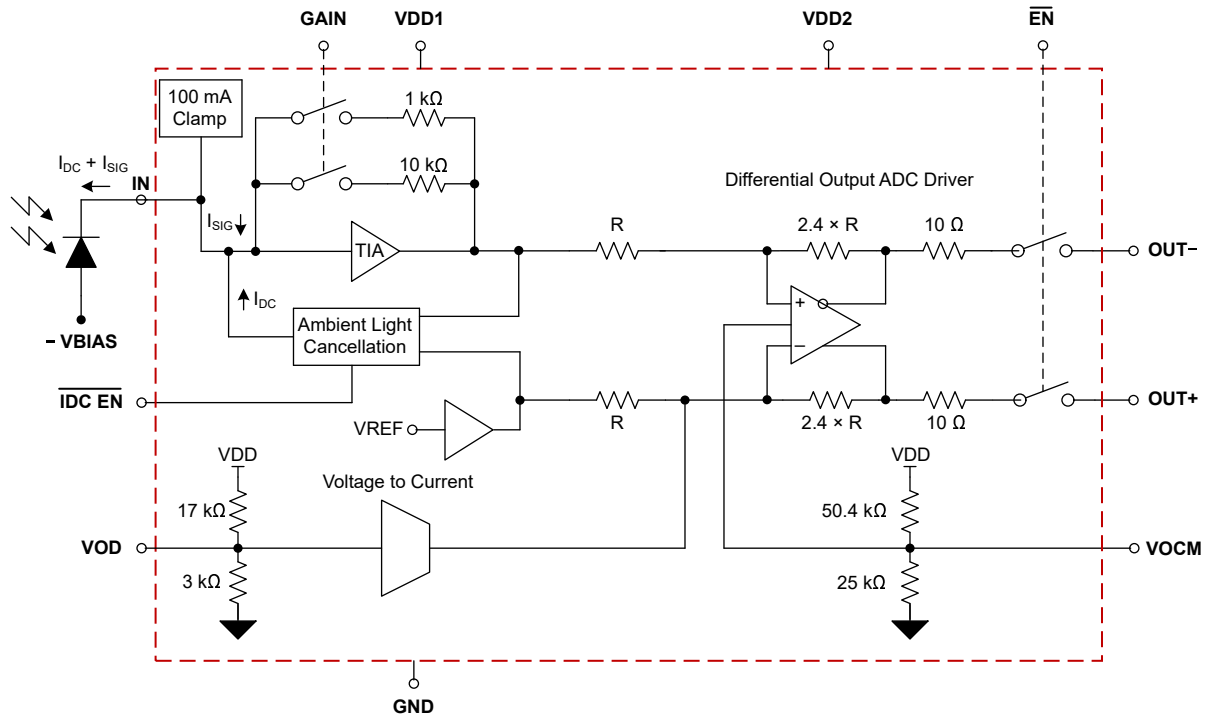

7.3 Feature Description

7.3.1 Switched Gain Transimpedance Amplifier

The LMH32401 device features a programmable gain transimpedance amplifier (TIA) stage followed by a fixed-gain, single-ended input to differential output amplifier stage. The closed-loop bandwidth and noise of a TIA are affected by the transimpedance gain and photodiode capacitance. For a given value of photodiode capacitance, the LMH32401 device has higher bandwidth in its low-gain configuration compared to the high-gain configuration. Increasing the gain of the TIA stage by a factor of X increases the output signal by a factor X , but the noise contribution from the resistor only increases by \sqrt{X} . The input-referred noise density of the low-gain configuration is therefore higher than the input-referred noise density of the high-gain configuration.

The gain of the TIA stage is controlled by the GAIN pin. Setting this pin low places the TIA in its low-gain configuration, whereas setting the pin high places the TIA in a high-gain configuration. The LMH32401 device defaults to its low-gain configuration when the GAIN pin is left floating.

7.3.2 Clamping and Input Protection

The LMH32401 device is designed to work with photodiode (PD) configurations that can source or sink current; however, the LMH32401 is optimized for a sinking current configuration. It is assumed that the LMH32401 device is being used with a PD that is configured with its cathode tied to the amplifier input and the anode tied to a negative supply voltage, unless stated otherwise.

The LMH32401 features two internal clamps, a fast recovery clamp and a soft clamp. The fast recovery clamp is the active clamp when the photodiode is sinking a photocurrent. The soft clamp is the active clamp when the photodiode is sourcing a photocurrent. Stray reflections from nearby objects with high reflectivity can produce large output current pulses from the PD. The linear input range of the LMH32401 device is approximately 65 μA in the high-gain configuration and 650 μA in the low-gain configuration (PD sinking the photocurrent).

Input currents in excess of the linear current range cause the internal nodes of the amplifier to saturate, which increases the amplifier recovery time. The end result is a broadening of the output pulse leading to blind zones in the system response. To protect against this condition, the LMH32401 features an integrated clamp that absorbs and diverts the excess current to the positive supply (V_{DD1}) when the amplifier detects its nodes entering a saturated condition. The integrated clamp minimizes the pulse extension to less than a few ns for input pulses up to 100 mA. The power-supply pins (V_{DD1} and V_{DD2}) must each have their own bypass capacitors to prevent large input pulses from affecting the differential output stage. When the amplifier is in low-power mode, the clamp circuitry is still active, thereby protecting the TIA input.

7.3.3 ESD Protection

All LMH32401 pins have an internal electrostatic discharge (ESD) protection diode to the positive and negative supply rails to protect the amplifier from ESD events.

7.3.4 Differential Output Stage

The differential output stage of the LMH32401 device performs the following two functions, which are common across all differential amplifiers:

1. Converts the single-ended output from the TIA stage to a differential output.
2. Performs a common-mode output shift to match the specified ADC input common-mode voltage.

The differential output stage has two 10- Ω series resistors on its output to isolate the amplifier output stage transistors from the package bond-wire inductance and printed circuit board (PCB) capacitance. The net gain of the LMH32401 device (TIA + output stage) is 2 k Ω (low gain) and 20 k Ω (high gain) when driving an external 100- Ω resistor. When the external load resistor is increased above 100 Ω , the effective gain from the IN pin to the differential output pin increases. Conversely, when the external load resistor is decreased to less than 100 Ω , the effective gain from the IN pin to the differential output pin decreases as a result of the larger voltage drop across the two internal 10- Ω resistors. When there is no load resistor between the OUT+ and OUT- pins, the effective gain of the LMH32401 is 2.4 k Ω and 24 k Ω in the low-gain and high-gain configurations, respectively.

The output common-mode voltage of the LMH32401 device can be set externally through the V_{OCM} pin. A resistor divider internal to the amplifier, between V_{DD2} and ground sets the default voltage to 1.1 V. The internal resistors generate common-mode noise that is typically rejected by the CMRR of the subsequent ADC stage. To maximize the amplifier signal-to-noise ratio (SNR), place an external noise bypass capacitor to ground on the V_{OCM} pin. In single-ended signal chains, such as ToF systems that use time-to-digital converters (TDCs), only a single output of the LMH32401 device is needed. In such situations, terminate the unused differential output in the same manner as the used output to maintain balance and symmetry. The signal swing of the single-ended output is half the available differential output swing. Additionally, the common-mode noise of the output stage, which is typically rejected by the differential input ADC, is now added to the total noise, further degrading SNR.

The output stage of the LMH32401 device has an additional V_{OD} input that sets the differential output between OUT⁻ and OUT⁺. 图 7-1 shows how each output pin of the LMH32401 device is at the voltage set by the V_{OCM} pin (default = 1.1 V) when the photodiode output current is zero and the V_{OD} input is set to 0 V. When the V_{OD} pin is driven to a voltage of X volts, the two output pins are separated by X volts when the photodiode current is zero. The average voltage is still equal to V_{OCM}. For example, 图 7-2 shows if V_{OCM} is set to 1.1 V and V_{OD} is set to 0.4 V, then OUT⁻ = 1.1 V + 0.2 V = 1.3 V and OUT⁺ = 1.1 V - 0.2 V = 0.9 V.

The V_{OD} pin is functional only when the LMH32401 device is used with a PD that sinks the photocurrent. Set V_{OD} = 0 V when the LMH32401 device is interfaced with a PD that sources the photocurrent. The V_{OD} output offset feature is included in the LMH32401 device because the output current of a photodiode is unipolar. Depending on the reverse bias configuration, the photodiode can either sink or source current, but cannot do both at the same time. With the anode connected to a negative bias and the cathode connected to the TIA stage input, the photodiode can only sink current, which implies that the TIA stage output swings in a positive direction above its default input bias voltage (2.47 V). Subsequently, OUT⁻ only swings below V_{OCM} and OUT⁺ only swings above V_{OCM}. 图 7-1 shows how the LMH32401 device only uses half of its output swing range (V_{OUT} = V_{OUT+} - V_{OUT-}) when V_{OD} = 0 V, because one output never swings below V_{OCM} and the other output never goes above V_{OCM}. The signal dynamic range in this case is 0.4 V_{PP} - 0 V = 0.4 V_{PP}.

图 7-2 shows how the V_{OD} pin voltage allows OUT⁻ to be level-shifted above V_{OCM} and OUT⁺ to be level-shifted below V_{OCM} to maximize the output swing capabilities of the amplifier. The signal dynamic range in this case is 0.4 V_{PP} - (-0.4 V_{PP}) = 0.8 V_{PP}.

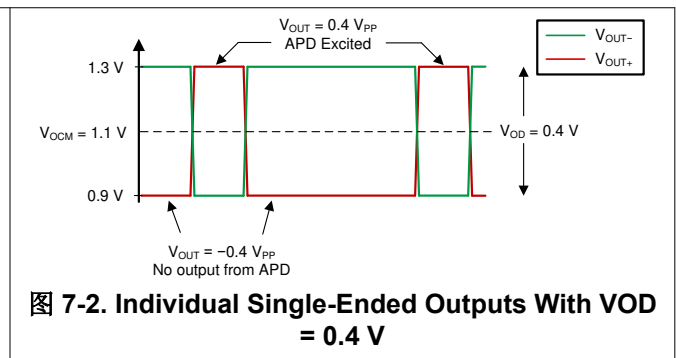
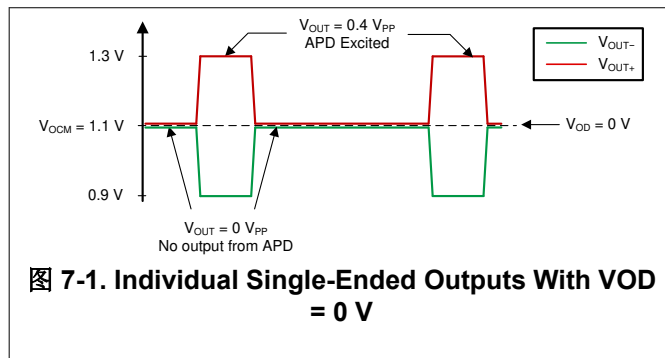

When the LMH32401 device drives a 100-Ω load, the voltage set at the V_{OD} pin is equal to the differential output offset (V_{OUT} = V_{OUT+} - V_{OUT-}) when the input signal current is zero. Use 方程式 1 to calculate the differential output offset under other load conditions.

$$V_{OD} = 1.2 \times VOD \times \frac{R_L}{(R_L \times 20 \Omega)} \quad (1)$$

Where:

- V_{OD} = Voltage applied at pin 9
- V_{OUT} = (V_{OUT-} - V_{OUT+})

- R_L = External load resistance

7.4 Device Functional Modes

7.4.1 Ambient Light Cancellation (ALC) Mode

The LMH32401 device has an integrated DC cancellation loop that cancels and voltage offsets from incidental ambient light. The ALC mode only works when the PD is sinking the photocurrent. The DC cancellation loop is enabled by setting $\overline{\text{IDC_EN}}$ low. Incident ambient light on a photodiode produces a DC current resulting in an offset voltage at the output of the LMH32401's TIA stage. The *Functional Block Diagram* shows how the ALC loop senses the low-frequency DC offset at the output of the TIA stage and compares it against an internal reference voltage (V_{REF}). The ALC loop then outputs an opposing DC current (I_{DC}) to compensate for the differential offset voltage at its input. The loop has a high-pass cutoff frequency of 100 kHz. The ambient light cancellation loop is disabled when the amplifier is placed in power-down mode.

The shot noise current introduced by the DC cancellation loop increases the overall amplifier noise; so, if the ambient light level is negligible, then disable the loop to improve SNR. The cancellation loop helps save PCB space and system costs by eliminating the need for external AC coupling passive components. Additionally, the extra trace inductance and PCB capacitance introduced by using external AC coupling components degrades the LMH32401 device dynamic performance.

7.4.2 Power-Down Mode (Multiplexer Mode)

The LMH32401 device can be placed in low-power mode by setting $\overline{\text{EN}}$ high, which helps in saving system power. Enabling low-power mode puts the outputs of the internal amplifiers in the LMH32401 device, including the differential outputs, in a high-impedance state. [Figure 7-3](#) shows how this device feature can further save board space and cost by eliminating the need for a discrete high-speed multiplexer, if a system consists of several photodiode and amplifier channels multiplexed to a single ADC channel. The disabled channel outputs are not an ideal open circuit so as the number of multiplexed channels increases the disabled channels begin to load the enabled channel. Multiplexing more than four channels in parallel degrades the performance of the enabled channel. When the amplifier is in its low-power mode, the clamp circuitry is still active thereby protecting the TIA input. The ambient light cancellation loop is disabled when the amplifier is placed in power-down mode. When the LMH32401 device is brought out of power-down operation the ambient light cancellation loop requires several time constants to settle. [Figure 6-9](#) shows the low-frequency loop response which in turn determines the time constant needed for the loop to settle.



图 7-3. Configuring Two LMH32401 Devices in Multiplexer Mode to Drive a Single ADC

8 Application and Implementation

备注

以下应用部分中的信息不属于 TI 器件规格的范围，TI 不担保其准确性和完整性。TI 的客户应负责确定器件是否适用于其应用。客户应验证并测试其设计，以确保系统功能。

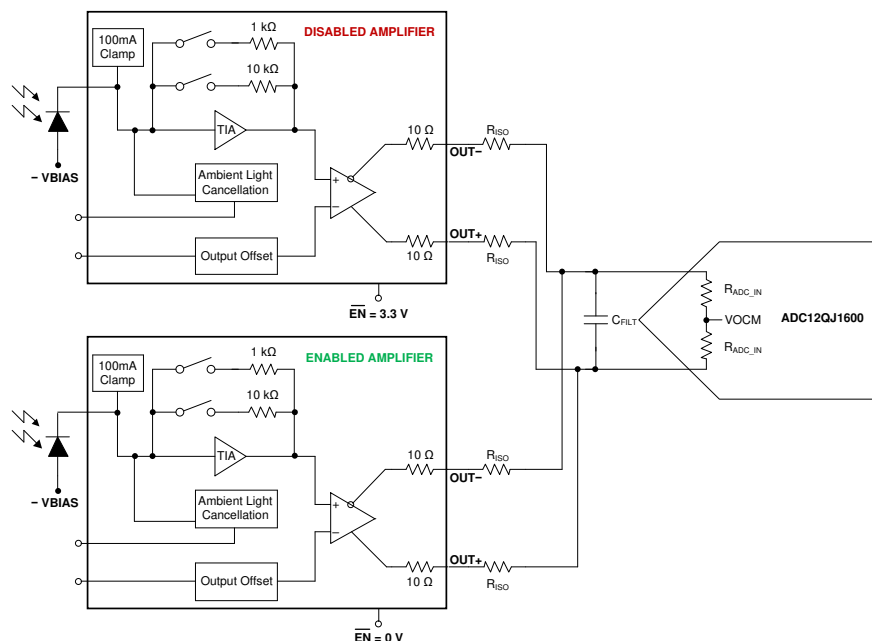
8.1 Application Information

The differential outputs of the LMH32401 device can directly drive a high-speed differential input ADC. 图 8-1 shows the LMH32401 differential outputs directly driving the ADC12QJ1600. The effective signal gain between the TIA input and the ADC input is 2 kΩ or 20 kΩ when driving an ADC with a 100-Ω differential input impedance ($R_{ADC_IN} = 50 \Omega$). 方程式 2 gives the effective signal gain between the TIA input and the ADC input when driving an ADC with any other value of differential input impedance ($R_{ADC_IN} \neq 50 \Omega$).



图 8-1. LMH32401 to ADC Interface

$$A_V = 2 \text{ k}\Omega \text{ (or } 20 \text{ k}\Omega) \times 1.2 \times \frac{2 \times R_{ADC_IN}}{(2 \times R_{ADC_IN} + 20 \Omega)} \quad (2)$$

Where:

- A_V = Differential gain from the TIA input to the ADC input
- R_{ADC_IN} = Input resistance of the ADC

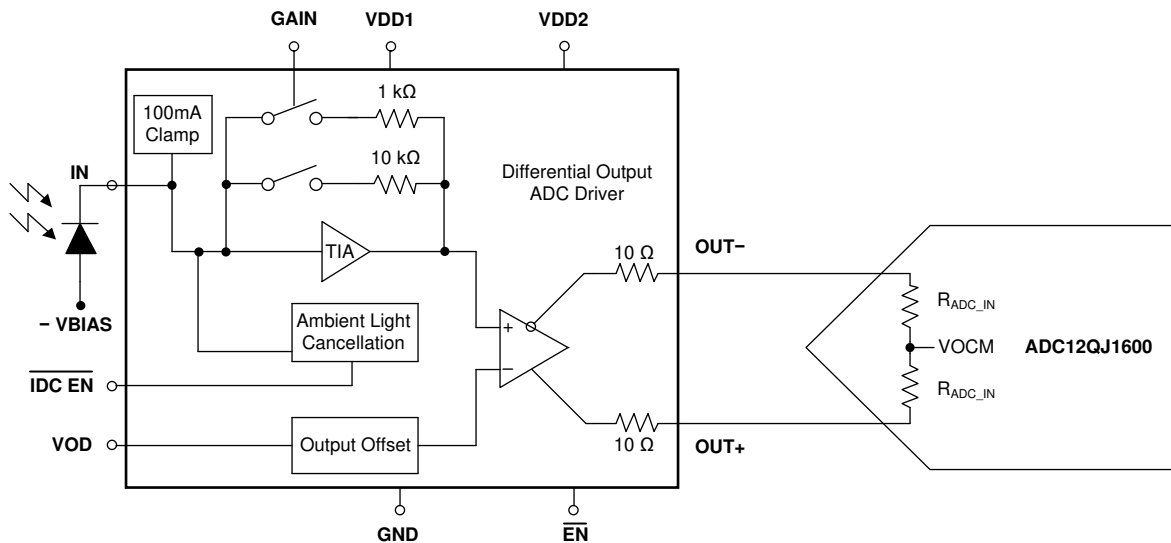
图 8-2 shows a matching resistor network between the LMH32401 output and the ADC12QJ1600 input. The matching network is needed to prevent signal reflections when the signal path between the LMH32401 and ADC is very long. 方程式 3 gives the effective gain from the TIA input to the ADC input when using a matching resistor network.



图 8-2. LMH32401 to ADC Interface with a Matching Resistor Network

$$A_V = 2 \text{ k}\Omega \text{ (or } 20 \text{ k}\Omega) \times 1.2 \times \frac{2 \times R_{\text{ADC_IN}}}{(2 \times R_{\text{ADC_IN}} + 2 \times R_{\text{ISO}} + 20 \Omega)} \quad (3)$$

Where:

- A_V = Gain from the TIA input to the ADC input
- $R_{\text{ADC_IN}}$ = Differential input resistance of the ADC
- R_{ISO} = Series resistance between the TIA and ADC

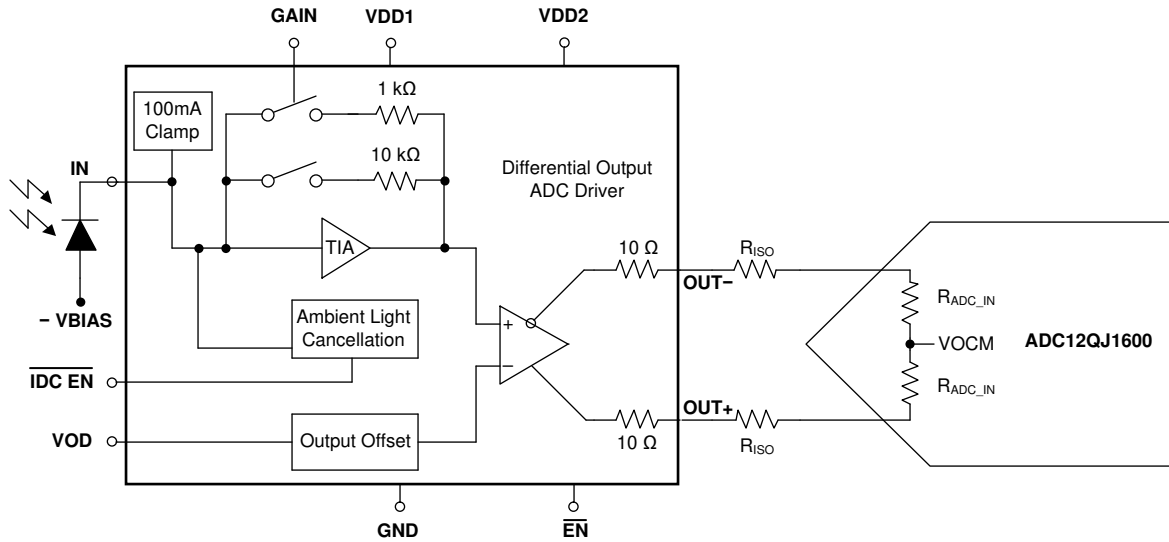
方程式 4 gives the voltage to be applied at the VOD pin (pin 9) if a certain differential offset voltage (V_{OD}) is needed at the ADC input for the circuit in 图 8-2.

$$V_{\text{OD}} = V_{\text{OD}} \times \left(\frac{1}{1.2} \right) \times \frac{(2 \times R_{\text{ADC_IN}} + 2 \times R_{\text{ISO}} + 20 \Omega)}{(2 \times R_{\text{ADC_IN}})} \quad (4)$$

Where:

- V_{OD} = Voltage applied at pin 9
- V_{OD} = Desired differential offset voltage at the ADC input
- $R_{\text{ADC_IN}}$ = Differential input resistance of the ADC
- R_{ISO} = Series resistance between the TIA and ADC

8.2 Typical Application

This section demonstrates the performance of the LMH32401 device when the input current flows into the IN pin. 图 8-3 shows the circuit used to test the LMH32401 device with a voltage source. This configuration demonstrates the use case when the photodiode's anode is tied to the amplifier input and its cathode is tied to a positive voltage greater than 2.47 V.



图 8-3. LMH32401 Test Circuit

8.2.1 Design Requirements

The objective is to design a low-noise, wideband differential output transimpedance amplifier. The design requirements are as follows:

- Amplifier supply voltage: 3.3 V
- Transimpedance gain: 2 k Ω and 20 k Ω
- Input capacitance: $C_{PCB} \approx 1$ pF
- Target bandwidth: > 250 MHz
- Differential output offset (VOD): 0 V
- Ambient light cancellation (IDC_EN): 3.3 V (disabled)

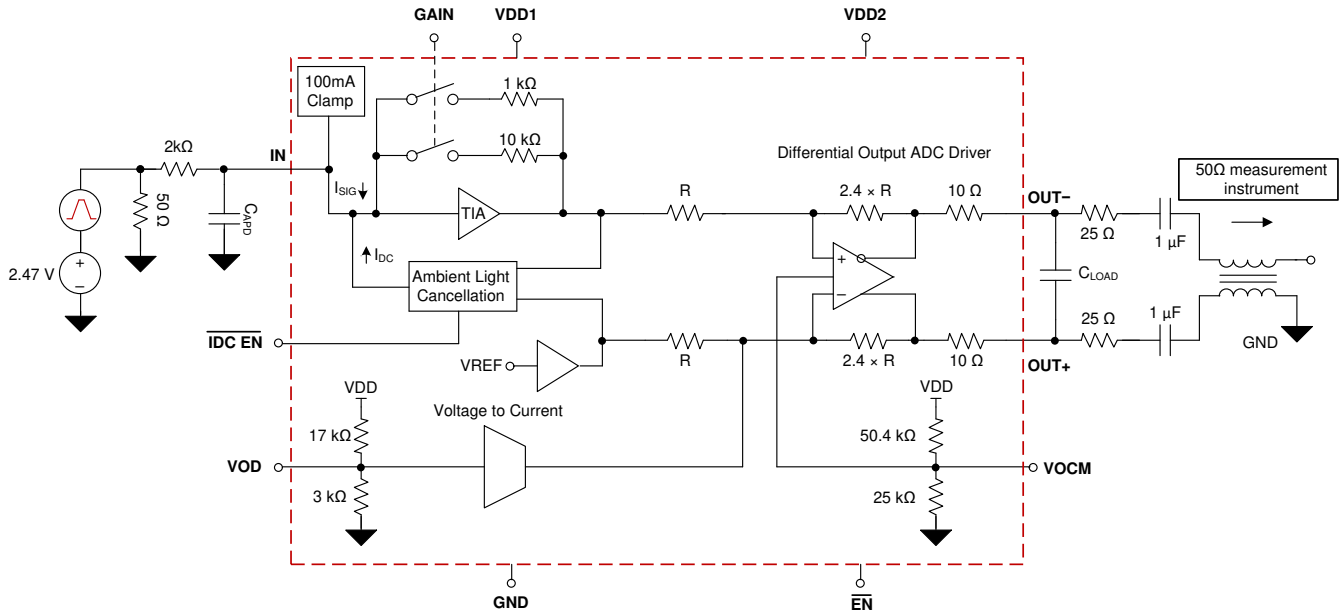
8.2.2 Detailed Design Procedure

图 8-3 shows the LMH32401 device test circuit used to measure its bandwidth and transient pulse response. The voltage source is DC biased close to the input bias voltage of the LMH32401 device (approximately 2.47 V). The internal design of the LMH32401 device is optimized to only source current out of the input pin (pin 3), and all the data shown previously is with the current flowing out of the pin. When the voltage input from the source exceeds 2.47 V, the LMH32401 device input will sink the current. Set VOD = 0 V when the input has to sink the current from the photodiode, or in this case the voltage source. Set the DC bias so that sum of the input AC and DC component is always greater than the input voltage (2.47 V) when testing the LMH32401 device with a network analyzer or sinusoidal source.

图 8-4 and 图 8-5 shows the bandwidth of the LMH32401 device when its input is sinking the current. The input current range of the LMH32401 device is reduced when it is sinking the current. This effect is seen by the decrease in bandwidth as the output swing increases and is more pronounced in a gain configuration of 20 k Ω . Compare 图 8-4 with 图 6-1 and 图 6-3 to see the effect of current direction and input range in a 2 k Ω gain configuration. In a similar way, compare 图 8-5 with 图 6-2 and 图 6-4 to see the effect of current direction and input range in a gain of 20 k Ω .

图 8-6 和 图 8-7 显示 LMH32401 器件的脉冲输出响应，当输入电流增加到放大器线性输入范围之外时。当输入是 sinking 电流时，软钳位将有助于快速恢复；然而，随着输入电流过冲量增加，脉冲将略微展宽。比较 图 8-6 与 图 6-21 以查看增益为 $2\text{ k}\Omega$ 时的脉冲展宽效应。比较 图 8-7 与 图 6-22 以查看增益为 $20\text{ k}\Omega$ 时的脉冲展宽效应。脉冲展宽的知识可用于确定即使在过冲情况下也可能发生的近似输入电流，这是由于环境中存在 retro-reflectors 的存在。如图 7-1 所示，每个半差分输出脉冲将只摆动在 V_{OCM} 电压之上或之下，且差分输出摆幅为 $0.75 V_{PP}$ ，因为 V_{OD} 设置为 0 V 。因此，只有总 ADC 范围的一半在此光电二极管配置中得到利用。

8.2.3 Application Curves



图 8-4. Bandwidth vs Output Swing
(Gain = $2\text{ k}\Omega$)



图 8-5. Bandwidth vs Output Swing
(Gain = $20\text{ k}\Omega$)

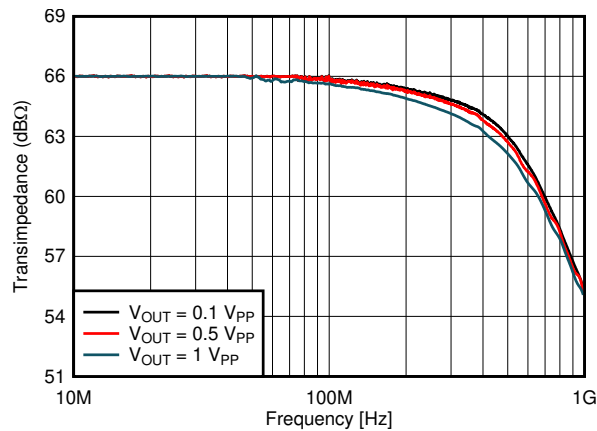

图 8-6. Pulse Response vs Input Current
(Gain = $2\text{ k}\Omega$)

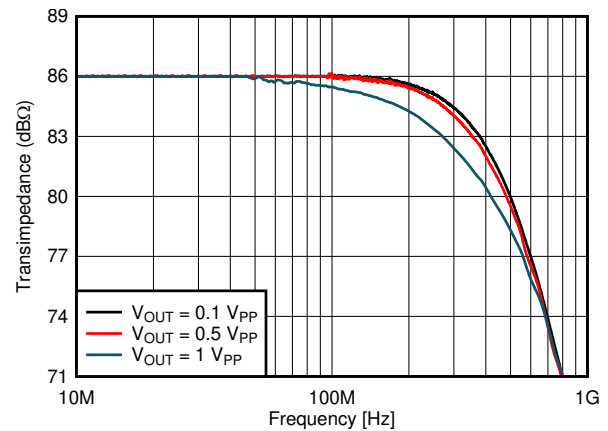

图 8-7. Pulse Response vs Input Current
(Gain = $20\text{ k}\Omega$)

9 Power Supply Recommendations

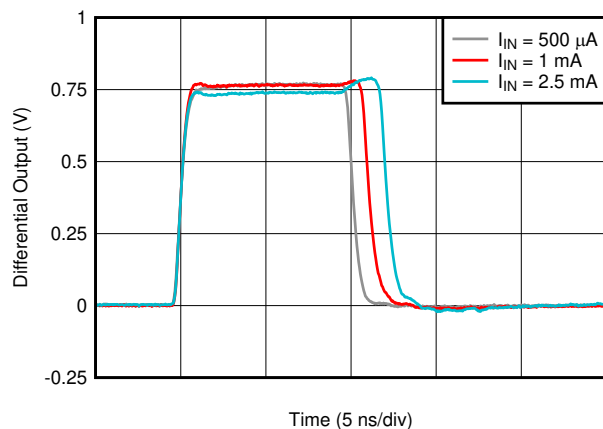
The LMH32401 device operates on 3.3-V supplies. The VDD1 and VDD2 pins must always be driven from the same supply source and individually bypassed. A low power-supply source impedance must be maintained across frequency. So use multiple bypass capacitors in parallel. Place the bypass capacitors as close to the supply pins as possible. Place the smallest capacitor on the same side of the PCB as the LMH32401 device. Placing the larger valued bypass capacitors on the same side of the PCB is preferable as well. However, if there are space constraints, then the capacitors can be moved to the opposite side of the PCB using multiple vias to reduce the series inductance resulting from the vias. The LMH32401 device can operate on bipolar supplies by connecting pins 1 and 7 to the negative supply. The thermal pad must always be connected to the most negative supply. The digital pin threshold voltages must be appropriately level shifted as they are connected to voltages at pins 1 and 7.

10 Layout

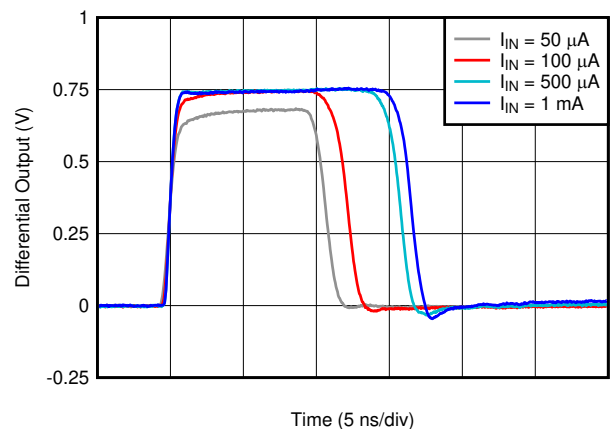
10.1 Layout Guidelines

Achieving optimum performance with a high-frequency amplifier such as the LMH32401 device requires careful attention to board layout parasitics and external component types. Recommendations that optimize performance include the following:

- **Minimize parasitic capacitance from the signal I/O pins to ac ground.** Parasitic capacitance on the output pins can cause instability whereas parasitic capacitance on the input pin reduces the amplifier bandwidth. To reduce unwanted capacitance, cut out the power and ground traces under the signal input and output pins. Otherwise, ground and power planes must be unbroken elsewhere on the board.
- **Minimize the distance from the power-supply pins to high-frequency bypass capacitors.** Use high-quality, 100-pF to 0.1- μ F, C0G and NPO-type decoupling capacitors with voltage ratings at least three times greater than the amplifiers maximum power supplies. Place the smallest value capacitors on the same side as the DUT. If space constraints force the larger value bypass capacitors to be placed on the opposite side of the PCB, then use multiple vias on the supply and ground side of the capacitors. This configuration makes sure that there is a low-impedance path to the amplifiers power-supply pins across the amplifiers gain bandwidth specification. Avoid narrow power and ground traces to minimize inductance between the pins and the decoupling capacitors. Larger (2.2- μ F to 6.8- μ F) decoupling capacitors that are effective at lower frequency must be used on the supply pins. Place these decoupling capacitors further from the device. Share the decoupling capacitors among several devices in the same area of the printed circuit board (PCB).

10.2 Layout Example



图 10-1. Layout Recommendation

11 Device and Documentation Support

11.1 Device Support

11.1.1 Development Support

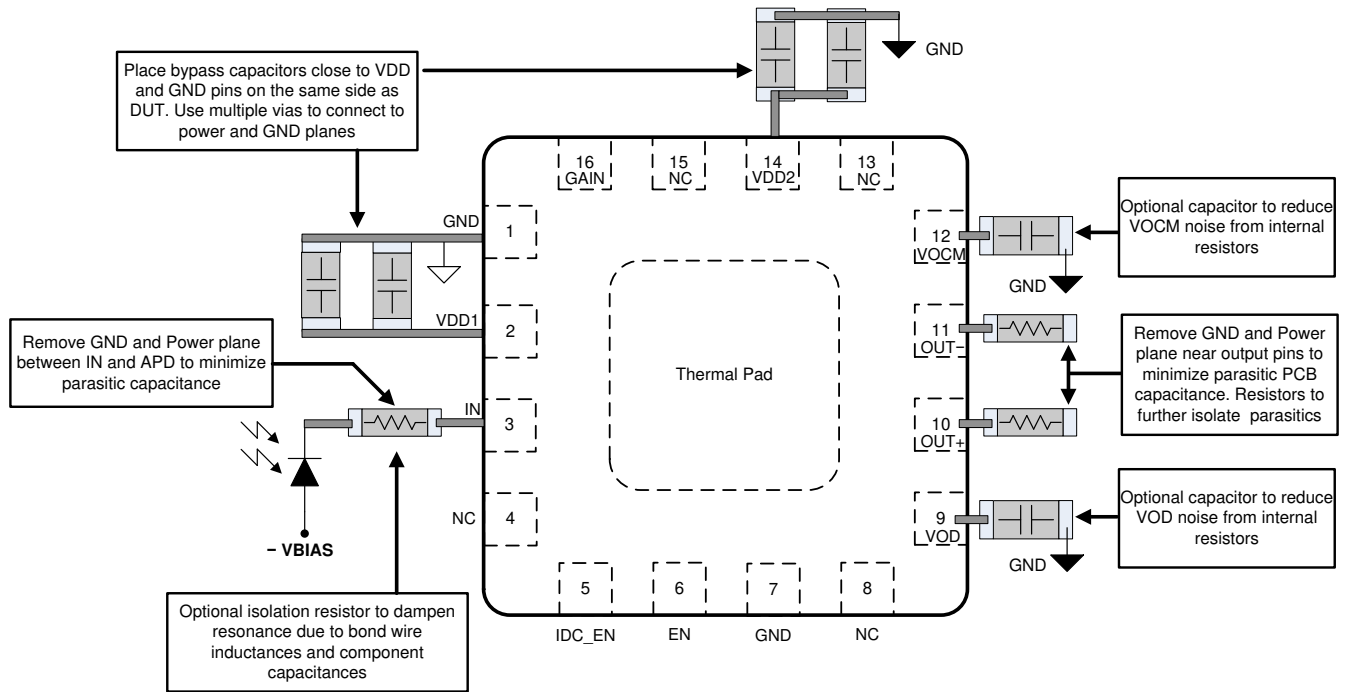
- Texas Instruments, [LMH32401 Transimpedance Amplifier Evaluation Module](#).
- Texas Instruments, [Optical Front-End System Reference Design design guide](#).
- Texas Instruments, [LIDAR-Pulsed Time-of-Flight Reference Design Using High-Speed Data Converters design guide](#).
- Texas Instruments, [LIDAR Pulsed Time of Flight Reference Design design guide](#).

11.2 Documentation Support

11.2.1 Related Documentation

For related documentation see the following:

- Texas Instruments, [LMH32401IRGT Evaluation Module user's guide](#).
- Texas Instruments, [Transimpedance Considerations for High-Speed Amplifiers application report](#).
- Texas Instruments, [What You Need To Know About Transimpedance Amplifiers - Part 1 blog](#).
- Texas Instruments, [An Introduction to Automotive LIDAR](#).
- Texas Instruments, [Maximizing the Dynamic Range of Analog Front Ends Having a Transimpedance Amplifier](#).
- Texas Instruments, [Time of Flight and LIDAR - Optical Front End Design](#).
- Texas Instruments, [What You Need To Know About Transimpedance Amplifiers - Part 2 blog](#).
- Texas Instruments, [Training Video: How to Design Transimpedance Amplifier Circuits](#).
- Texas Instruments, [Training Video: High-Speed Transimpedance Amplifier Design Flow](#).
- Texas Instruments, [Training Video: How to Convert a TINA-TI Model into a Generic SPICE Model](#).

11.3 接收文档更新通知

要接收文档更新通知，请导航至 [ti.com](#) 上的器件产品文件夹。点击 [订阅更新](#) 进行注册，即可每周接收产品信息更改摘要。有关更改的详细信息，请查看任何已修订文档中包含的修订历史记录。

11.4 支持资源

[TI E2E™ 支持论坛](#) 是工程师的重要参考资料，可直接从专家获得快速、经过验证的解答和设计帮助。搜索现有解答或提出自己的问题可获得所需的快速设计帮助。

链接的内容由各个贡献者“按原样”提供。这些内容并不构成 TI 技术规范，并且不一定反映 TI 的观点；请参阅 TI 的 [《使用条款》](#)。

11.5 Trademarks

TI E2E™ is a trademark of Texas Instruments.

所有商标均为其各自所有者的财产。

11.6 静电放电警告



静电放电 (ESD) 会损坏这个集成电路。德州仪器 (TI) 建议通过适当的预防措施处理所有集成电路。如果不遵守正确的处理和安装程序，可能会损坏集成电路。

ESD 的损坏小至导致微小的性能降级，大至整个器件故障。精密的集成电路可能更容易受到损坏，这是因为非常细微的参数更改都可能会导致器件与其发布的规格不相符。

11.7 术语表

[TI 术语表](#) 本术语表列出并解释了术语、首字母缩略词和定义。

12 Mechanical, Packaging, and Orderable Information

The following pages include mechanical, packaging, and orderable information. This information is the most current data available for the designated devices. This data is subject to change without notice and revision of this document. For browser-based versions of this data sheet, refer to the left-hand navigation.

PACKAGING INFORMATION

Orderable Device	Status (1)	Package Type	Package Drawing	Pins	Package Qty	Eco Plan (2)	Lead finish/ Ball material (6)	MSL Peak Temp (3)	Op Temp (°C)	Device Marking (4/5)	Samples
LMH32401IRGTR	ACTIVE	VQFN	RGT	16	3000	RoHS & Green	NIPDAU	Level-1-260C-UNLIM	-40 to 125	L32401	Samples
LMH32401IRGTT	ACTIVE	VQFN	RGT	16	250	RoHS & Green	NIPDAU	Level-1-260C-UNLIM	-40 to 125	L32401	Samples
LMH32401YR	ACTIVE	DIESALE	Y	0	3000	RoHS & Green	Call TI	N / A for Pkg Type	-40 to 125		Samples

(1) The marketing status values are defined as follows:

ACTIVE: Product device recommended for new designs.

LIFEBUY: TI has announced that the device will be discontinued, and a lifetime-buy period is in effect.

NRND: Not recommended for new designs. Device is in production to support existing customers, but TI does not recommend using this part in a new design.

PREVIEW: Device has been announced but is not in production. Samples may or may not be available.

OBSOLETE: TI has discontinued the production of the device.

(2) **RoHS:** TI defines "RoHS" to mean semiconductor products that are compliant with the current EU RoHS requirements for all 10 RoHS substances, including the requirement that RoHS substance do not exceed 0.1% by weight in homogeneous materials. Where designed to be soldered at high temperatures, "RoHS" products are suitable for use in specified lead-free processes. TI may reference these types of products as "Pb-Free".

RoHS Exempt: TI defines "RoHS Exempt" to mean products that contain lead but are compliant with EU RoHS pursuant to a specific EU RoHS exemption.

Green: TI defines "Green" to mean the content of Chlorine (Cl) and Bromine (Br) based flame retardants meet JS709B low halogen requirements of <=1000ppm threshold. Antimony trioxide based flame retardants must also meet the <=1000ppm threshold requirement.

(3) MSL, Peak Temp. - The Moisture Sensitivity Level rating according to the JEDEC industry standard classifications, and peak solder temperature.

(4) There may be additional marking, which relates to the logo, the lot trace code information, or the environmental category on the device.

(5) Multiple Device Markings will be inside parentheses. Only one Device Marking contained in parentheses and separated by a "~" will appear on a device. If a line is indented then it is a continuation of the previous line and the two combined represent the entire Device Marking for that device.

(6) Lead finish/Ball material - Orderable Devices may have multiple material finish options. Finish options are separated by a vertical ruled line. Lead finish/Ball material values may wrap to two lines if the finish value exceeds the maximum column width.

Important Information and Disclaimer:The information provided on this page represents TI's knowledge and belief as of the date that it is provided. TI bases its knowledge and belief on information provided by third parties, and makes no representation or warranty as to the accuracy of such information. Efforts are underway to better integrate information from third parties. TI has taken and continues to take reasonable steps to provide representative and accurate information but may not have conducted destructive testing or chemical analysis on incoming materials and chemicals. TI and TI suppliers consider certain information to be proprietary, and thus CAS numbers and other limited information may not be available for release.

In no event shall TI's liability arising out of such information exceed the total purchase price of the TI part(s) at issue in this document sold by TI to Customer on an annual basis.

TAPE AND REEL INFORMATION

QUADRANT ASSIGNMENTS FOR PIN 1 ORIENTATION IN TAPE

*All dimensions are nominal

Device	Package Type	Package Drawing	Pins	SPQ	Reel Diameter (mm)	Reel Width W1 (mm)	A0 (mm)	B0 (mm)	K0 (mm)	P1 (mm)	W (mm)	Pin1 Quadrant
LMH32401IRGTR	VQFN	RGT	16	3000	330.0	12.4	3.3	3.3	1.1	8.0	12.0	Q2
LMH32401IRGTT	VQFN	RGT	16	250	180.0	12.4	3.3	3.3	1.1	8.0	12.0	Q2
LMH32401YR	DIESALE	Y	0	3000	180.0	8.4	1.1	1.1	0.4	4.0	8.0	Q1

TAPE AND REEL BOX DIMENSIONS

*All dimensions are nominal

Device	Package Type	Package Drawing	Pins	SPQ	Length (mm)	Width (mm)	Height (mm)
LMH32401IRGTR	VQFN	RGT	16	3000	367.0	367.0	35.0
LMH32401IRGTT	VQFN	RGT	16	250	210.0	185.0	35.0
LMH32401YR	DIESALE	Y	0	3000	210.0	185.0	35.0

RGT 16

GENERIC PACKAGE VIEW

VQFN - 1 mm max height

PLASTIC QUAD FLATPACK - NO LEAD



Images above are just a representation of the package family, actual package may vary.
Refer to the product data sheet for package details.

4203495/1



SIDE WALL METAL THICKNESS DIM A	
OPTION 1	OPTION 2
0.1	0.2



4222419/D 04/2022

NOTES:

1. All linear dimensions are in millimeters. Any dimensions in parenthesis are for reference only. Dimensioning and tolerancing per ASME Y14.5M.
2. This drawing is subject to change without notice.
3. The package thermal pad must be soldered to the printed circuit board for thermal and mechanical performance.

EXAMPLE BOARD LAYOUT

RGT0016C

VQFN - 1 mm max height

PLASTIC QUAD FLATPACK - NO LEAD

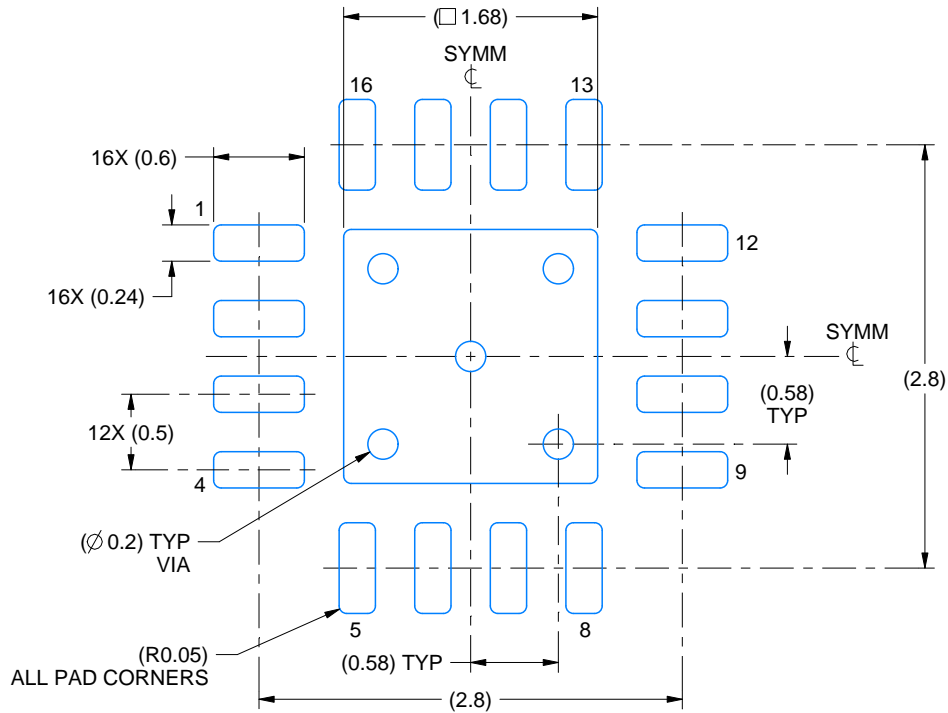

LAND PATTERN EXAMPLE
EXPOSED METAL SHOWN
SCALE:20X

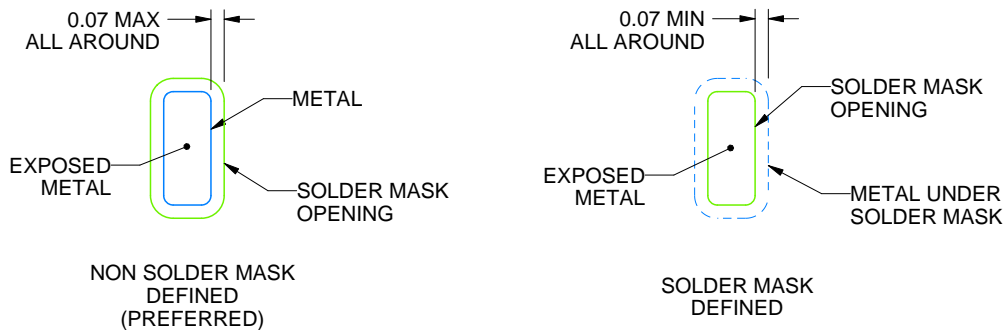

SOLDER MASK DETAILS

4222419/D 04/2022

NOTES: (continued)

4. This package is designed to be soldered to a thermal pad on the board. For more information, see Texas Instruments literature number SLUA271 (www.ti.com/lit/slua271).
5. Vias are optional depending on application, refer to device data sheet. If any vias are implemented, refer to their locations shown on this view. It is recommended that vias under paste be filled, plugged or tented.

EXAMPLE STENCIL DESIGN

RGT0016C

VQFN - 1 mm max height

PLASTIC QUAD FLATPACK - NO LEAD

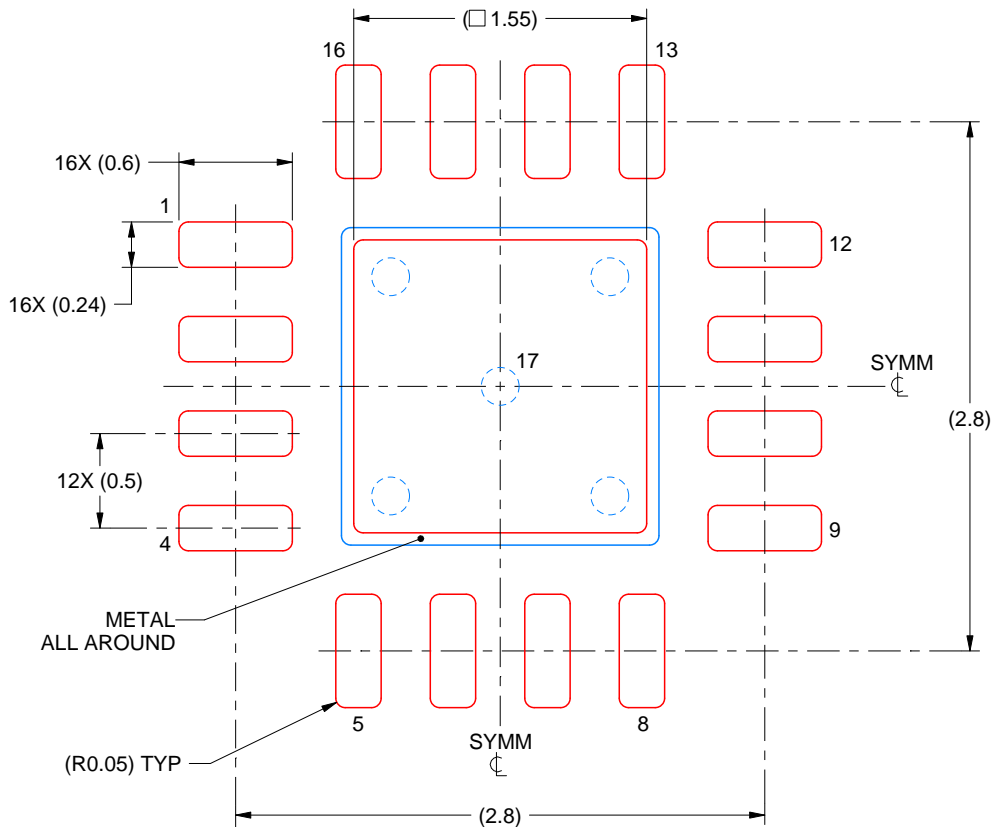

SOLDER PASTE EXAMPLE
BASED ON 0.125 mm THICK STENCIL

EXPOSED PAD 17:
85% PRINTED SOLDER COVERAGE BY AREA UNDER PACKAGE
SCALE:25X

4222419/D 04/2022

NOTES: (continued)

6. Laser cutting apertures with trapezoidal walls and rounded corners may offer better paste release. IPC-7525 may have alternate design recommendations.

重要声明和免责声明

TI“按原样”提供技术和可靠性数据（包括数据表）、设计资源（包括参考设计）、应用或其他设计建议、网络工具、安全信息和其他资源，不保证没有瑕疵且不做任何明示或暗示的担保，包括但不限于对适销性、某特定用途方面的适用性或不侵犯任何第三方知识产权的暗示担保。

这些资源可供使用 TI 产品进行设计的熟练开发人员使用。您将自行承担以下全部责任：(1) 针对您的应用选择合适的 TI 产品，(2) 设计、验证并测试您的应用，(3) 确保您的应用满足相应标准以及任何其他功能安全、信息安全、监管或其他要求。

这些资源如有变更，恕不另行通知。TI 授权您仅可将这些资源用于研发本资源所述的 TI 产品的应用。严禁对这些资源进行其他复制或展示。您无权使用任何其他 TI 知识产权或任何第三方知识产权。您应全额赔偿因在这些资源的使用中对 TI 及其代表造成的任何索赔、损害、成本、损失和债务，TI 对此概不负责。

TI 提供的产品受 [TI 的销售条款](#) 或 [ti.com](#) 上其他适用条款/TI 产品随附的其他适用条款的约束。TI 提供这些资源并不会扩展或以其他方式更改 TI 针对 TI 产品发布的适用的担保或担保免责声明。

TI 反对并拒绝您可能提出的任何其他或不同的条款。

邮寄地址：Texas Instruments, Post Office Box 655303, Dallas, Texas 75265
Copyright © 2024，德州仪器 (TI) 公司