

具有集成平衡-非平衡变压器的 LMH9135 3.2GHz 至 4.2GHz 差分至单端放大器

1 特性

- 单通道、窄带差分输入至单端输出射频增益块放大器
- 支持 3.2GHz 至 4.2GHz 1dB BW 典型值
- 在整个频带内具有 18dB 的典型增益
- 3.8dB 噪声系数
- 31.5dBm OIP3
- 18dBm 输出 P1dB
- +3.3V 单电源供电，具有 395mW 功耗
- 工作温度高达 105°C T_C

2 应用

- 适用于 GPS/DAC 的差分 DAC 输出驱动器
- 差分至单端放转换
- 平衡-非平衡变压器替代产品
- 小型蜂窝或 m-MIMO 基站
- 5G 有源天线系统 (AAS)
- 无线蜂窝基站

3 说明

LMH9135 是一款高性能、单通道、差分输入至单端输出传输射频增益块放大器，支持 3.2GHz 至 4.2GHz 频段。该器件可满足下一代 5G 有源天线系统 (AAS) 或小型蜂窝应用的要求，同时可驱动功率放大器 (PA) 输入端。该射频放大器可提供 18dB 的典型增益，并具有 +31.5dBm 输出 IP3 的出色线性性能，同时在整个 1dB 带宽内保持小于 4dB 的噪声系数。该器件内部匹配 100 Ω 差分输入阻抗，可轻松与输入端的射频采样或零中频模拟前端 (AFE) 相连。此外，该器件内部匹配 50 Ω 单端输出阻抗，可与后置放大器、表面声波 (SAW) 滤波器或功率放大器 (PA) 轻松交互。

该器件使用 3.3V 单电源供电，其典型有功功率约为 395mW，因此适用于高密度 5G 大规模 (MIMO) 应用。此外，该器件采用节省空间的 2mm x 2mm、12 引脚 QFN 封装。该器件的额定工作温度高达 105°C，可提供稳健的系统设计。该器件具有符合 JEDEC 标准的 1.8V 断电引脚，可为该器件快速断电和上电，适用于时分双工 (TDD) 系统。

器件信息 (1)

器件型号	封装	封装尺寸 (标称值)
LMH9135	WQFN (12)	2.00mm x 2.00mm

(1) 如需了解所有可用封装，请参阅数据表末尾的可订购产品附录。

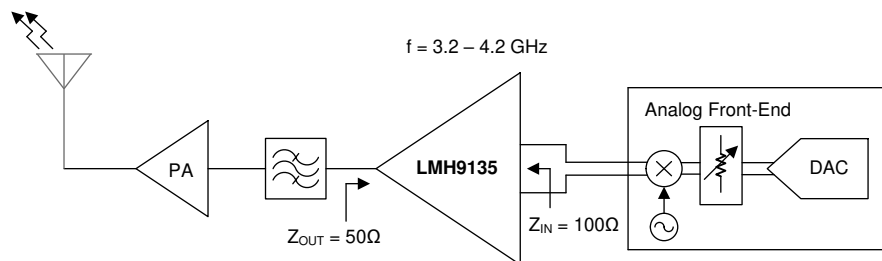

LMH9135 : 差分至单端放大器



Table of Contents

1 特性	1	7.4 Device Functional Modes.....	10
2 应用	1	8 Application and Implementation	10
3 说明	1	8.1 Application Information.....	10
4 Revision History	2	8.2 Typical Application.....	10
5 Pin Configuration and Functions	3	9 Power Supply Recommendations	13
Pin Functions.....	3	10 Layout	14
6 Specifications	4	10.1 Layout Guidelines.....	14
6.1 Absolute Maximum Ratings.....	4	10.2 Layout Example.....	14
6.2 ESD Ratings.....	4	11 Device and Documentation Support	15
6.3 Recommended Operating Conditions.....	4	11.1 Documentation Support.....	15
6.4 Thermal Information.....	4	11.2 Receiving Notification of Documentation Updates..	15
6.5 Electrical Characteristics.....	5	11.3 Support Resources.....	15
6.6 Typical Characteristics.....	6	11.4 Trademarks.....	15
7 Detailed Description	9	11.5 Electrostatic Discharge Caution.....	15
7.1 Overview.....	9	11.6 Glossary.....	15
7.2 Functional Block Diagram.....	9	12 Mechanical, Packaging, and Orderable Information	15
7.3 Feature Description.....	9		

4 Revision History

注：以前版本的页码可能与当前版本的页码不同

DATE	REVISION	NOTES
August 2020	*	Initial Release

5 Pin Configuration and Functions



图 5-1. RRL Package 12-Pin WQFN Top View

Pin Functions

PIN		I/O	DESCRIPTION
NO.	NAME		
1	VSS	Power	Ground
2	INP	Input	RF differential positive input into amplifier
3	INM	Power	RF differential negative input into amplifier
4	VSS	Power	Ground
5	VSS	Power	Ground
6	PD	Input	Power down connection. PD = 0 V = normal operation; PD = 1.8 V = power off mode
7	VSS	Power	Ground
8	VSS	Output	Ground
9	OUTP	Output	RF single-ended output from amplifier
10	VSS	Power	Ground
11	VDD	Power	Positive supply voltage (3.3 V)
12	NC	—	Do not connect this pin
Thermal Pad		—	Connect the thermal pad to Ground

6 Specifications

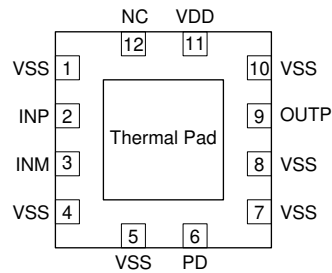
6.1 Absolute Maximum Ratings

over operating free-air temperature range (unless otherwise noted)⁽¹⁾

		MIN	MAX	UNIT
Supply voltage	VDD	- 0.3	3.6	V
RF Pins	INP, INM, OUTP	- 0.3	VDD	V
Digital Input PIN	PD	- 0.3	VDD	V
Continuous wave (CW) input	T = 25 °C		18	dBm
T _J	Junction temperature		150	°C
T _{stg}	Storage temperature	- 65	150	°C

- (1) Stresses beyond those listed under *Absolute Maximum Rating* may cause permanent damage to the device. These are stress ratings only, which do not imply functional operation of the device at these or any other conditions beyond those indicated under *Recommended Operating Condition*. Exposure to absolute-maximum-rated conditions for extended periods may affect device reliability.

6.2 ESD Ratings

			VALUE	UNIT
V _(ESD)	Electrostatic discharge	Human body model (HBM), per ANSI/ESDA/ JEDEC JS-001, all pins ⁽¹⁾	±1000	V
		Charged device model (CDM), per JEDEC specification JESD22-C101, all pins ⁽²⁾	±500	

- (1) JEDEC document JEP155 states that 500-V HBM allows safe manufacturing with a standard ESD control process.
 (2) JEDEC document JEP157 states that 250-V CDM allows safe manufacturing with a standard ESD control process.

6.3 Recommended Operating Conditions

over operating free-air temperature range (unless otherwise noted)

		MIN	NOM	MAX	UNIT
VDD	Supply voltage	3.15	3.3	3.45	V
T _C	Case (bottom) temperature	- 40		105	°C
T _J	Junction temperature	- 40		125	°C

6.4 Thermal Information

THERMAL METRIC ⁽¹⁾		DEVICE	UNIT
		PKG DES (PKG FAM)	
		PINS	
R _{θJA}	Junction-to-ambient thermal resistance	74.8	°C/W
R _{θJC(top)}	Junction-to-case (top) thermal resistance	72.4	°C/W
R _{θJB}	Junction-to-board thermal resistance	37.1	°C/W
Ψ _{JT}	Junction-to-top characterization parameter	3.2	°C/W
Ψ _{JB}	Junction-to-board characterization parameter	37.1	°C/W
R _{θJC(bot)}	Junction-to-case (bottom) thermal resistance	14.2	°C/W

- (1) For more information about traditional and new thermal metrics, see the [Semiconductor and IC Package Thermal Metrics](#) application report.

6.5 Electrical Characteristics

$T_A = +25^\circ\text{C}$, $V_{DD} = 3.3\text{V}$, Frequency (f_{in}) = 3.5 GHz, Differential Input Impedance (Z_{IN}) = 100 Ω , Output Load (Z_{LOAD}) = 50 Ω (unless otherwise noted)

PARAMETER		TEST CONDITIONS	MIN	TYP	MAX	UNIT
RF PERFORMANCE - LMH9135						
F_{RF}	RF frequency range		3200		4200	MHz
BW_{1dB}	1dB Bandwidth			1000		MHz
S_{21}	Gain			18		dB
NF	Noise Figure	$R_S = 100\ \Omega$ differential		3.8		dB
OP1dB	Output P1dB	$Z_{LOAD} = 50\ \Omega$		18		dBm
OIP3	Output IP3	$f_{in} = 3.5\ \text{GHz} \pm 5\ \text{MHz Spacing}$, $P_{OUT/TONE} = 2\ \text{dBm}$		31.5		dBm
	Differential Input Gain Imbalance			± 0.5		dB
	Differential Input Phase Imbalance			± 4		degree
S11	Input return loss ⁽¹⁾	$f_{in} = 3.3 - 3.8\ \text{GHz}$		-10		dB
		$f_{in} = 3.3 - 4.2\ \text{GHz}$		-10		dB
S22	Output return loss ⁽¹⁾	$f_{in} = 3.3 - 3.8\ \text{GHz}$		-10		dB
		$f_{in} = 3.3 - 4.2\ \text{GHz}$		-10		dB
S12	Reverse isolation			35		dB
CMRR	Common Mode Rejection Ratio ⁽²⁾			30		dB
Switching and Digital input characteristics						
t_{ON}	Turn-ON time	50% VPD to 90% RF		0.2		μs
t_{OFF}	Tun-OFF time	50% VPD to 10% RF		0.2		μs
V_{IH}	High-Level Input Voltage	PD pin	1.4			V
V_{IL}	Low-Level Input Voltage	PD pin			0.5	V
DC current and Power Consumption						
I_{VDD_ON}	Supply Current			120		mA
I_{VDD_PD}	Power Down Current			10		mA
P_{dis}	Power Dissipation			395		mW

(1) Reference impedance: Input = 100 Ω differential, Output = 50 Ω single-ended

(2) CMRR is calculated using $(S_{12} - S_{13}) / (S_{12} + S_{13})$ for Transmit (1 is output port, 2 & 3 are differential input ports)

6.6 Typical Characteristics

At $T_A = 25^\circ\text{C}$, $V_{DD} = 3.3\text{ V}$, differential input impedance (Z_{IN}) = $100\ \Omega$, single-ended output impedance (Z_{LOAD}) = $50\ \Omega$ (unless otherwise noted).

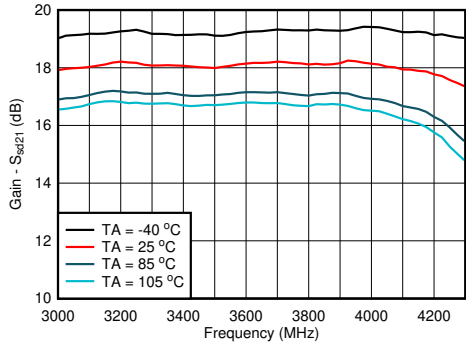

$P_{OUT} = 2\text{ dBm}$

图 6-1. Gain vs Frequency and Temperature

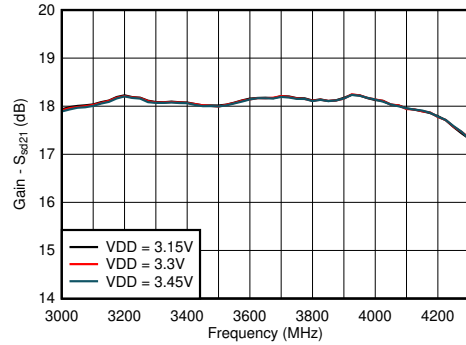

$P_{OUT} = 2\text{ dBm}$

图 6-2. Gain vs Frequency and Supply Voltage



图 6-3. Input Return Loss vs Frequency



图 6-4. Output Return Loss vs Frequency

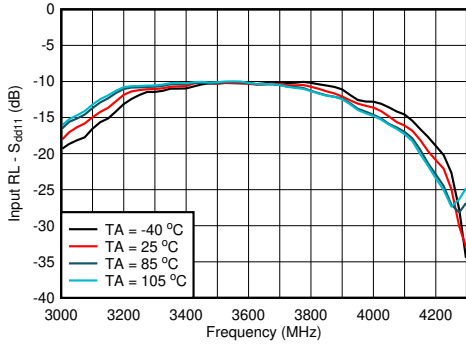

图 6-5. Reverse Isolation vs Frequency

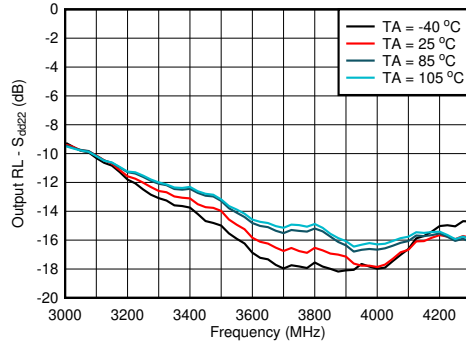

$P_{OUT/TONE} = 2\text{ dBm}$, 10-MHz tone spacing

图 6-6. Output IP3 vs Frequency and Temperature

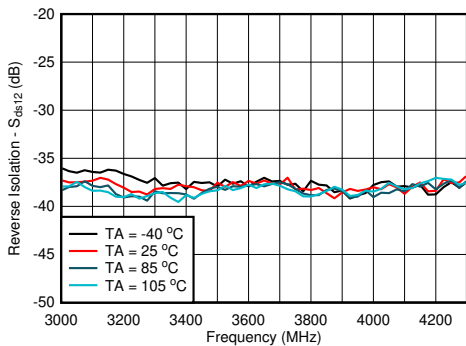
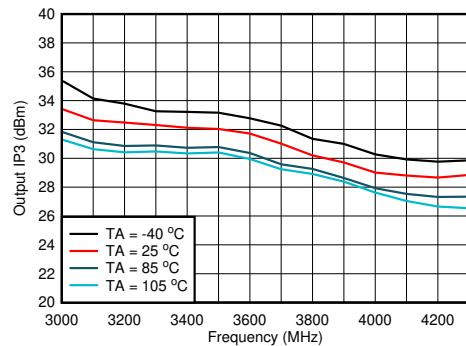
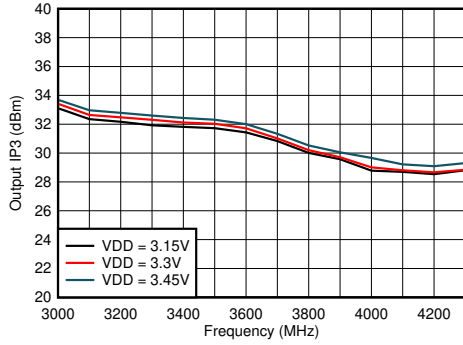

$P_{OUT/TONE} = 2 \text{ dBm}$, 10-MHz tone spacing

图 6-7. Output IP3 vs Frequency and Supply Voltage

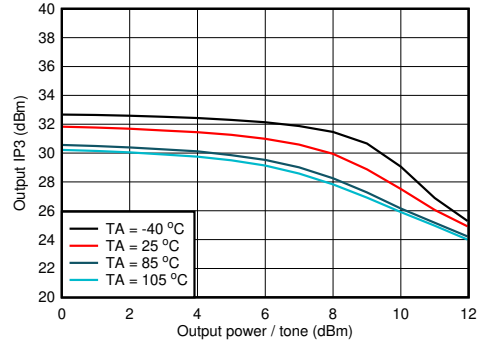

$f = 3.5 \text{ GHz}$, 10-MHz tone spacing

图 6-8. Output IP3 vs Output Power per Tone

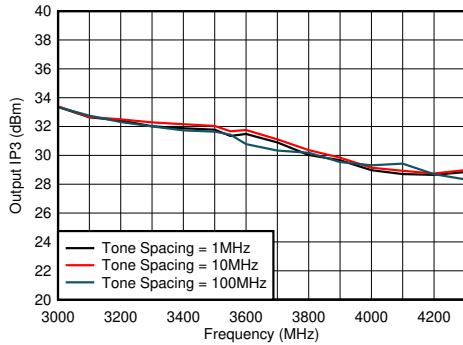

$P_{OUT/TONE} = 2 \text{ dBm}$

图 6-9. Output IP3 vs Frequency and Tone Spacing



图 6-10. Output P1dB vs Frequency and Temperature



图 6-11. Output P1dB vs Frequency and Supply Voltage

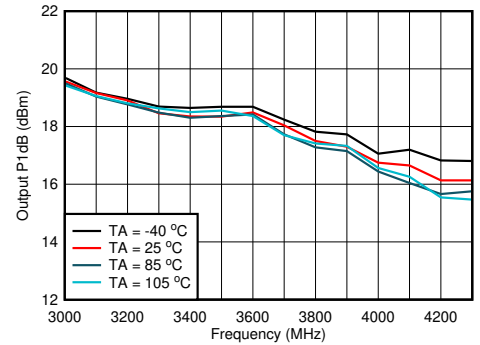

$Z_{SOURCE} = 100\text{-}\Omega$ differential

图 6-12. Noise Figure vs Frequency and Temperature

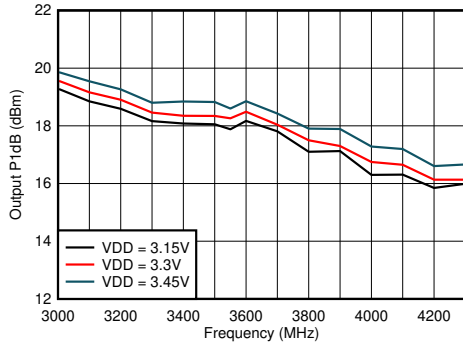
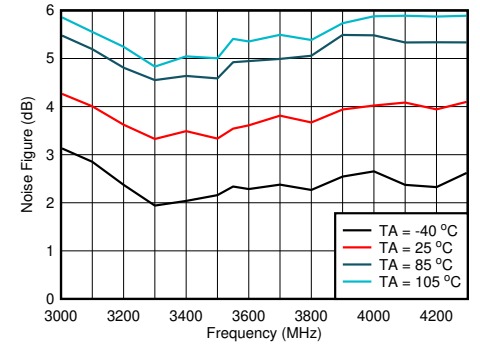

图 6-13. Common-mode Rejection Ratio vs Frequency



图 6-14. Gain Imbalance vs Frequency and Temperature

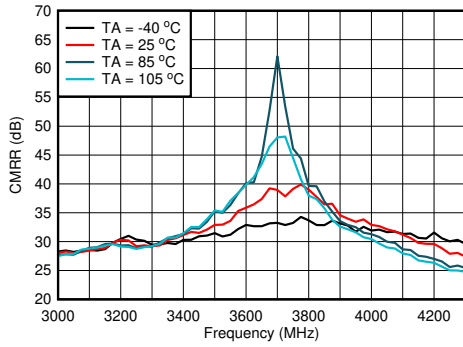

图 6-15. Phase Imbalance vs Frequency and Temperature

7 Detailed Description

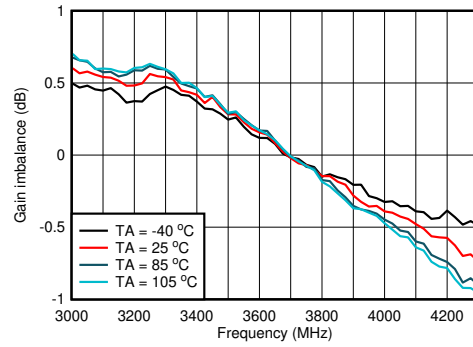
7.1 Overview

The LMH9135 device is a differential input to single-ended output narrow-band RF amplifier used in transmitter applications. The device provides 18 dB fixed power gain with excellent linearity and noise performance across the frequency band 3.2 - 4.2 GHz. The device is internally matched for 100- Ω impedance at the differential input and 50- Ω impedance at the single-ended output, as shown in [图 7-1](#).

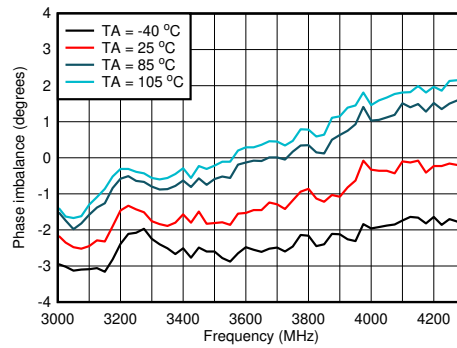
LMH9135 have on-chip active bias circuitry to maintain device performance over a wide temperature and supply voltage range. The included power down function allows the amplifier to shut down saving power when the amplifier is not needed. Fast shut down and start up enable the amplifier to be used in a host of time division duplex applications.

Operating on a single 3.3 V supply and 120 mA of typical supply current, the devices are available in a 2 mm x 2 mm 12-pin QFN package.

7.2 Functional Block Diagram



图 7-1. Functional Block Diagram

7.3 Feature Description

The LMH9135 device is a differential input to single-ended output RF amplifier for narrow band active balun implementation. The device integrates the functionality of a single-ended RF amplifier and passive balun in traditional transmitter applications achieving small form factor with comparable linearity and noise performance, as shown in [图 7-2](#).

The active balun implementation coupled with higher operating temperature of 105°C allows for more robust receiver system implementation compared to passive balun that is prone to reliability failures at high temperatures. The robust operation is achieved by the on-chip active bias circuitry which maintains device performance over a wide temperature and supply voltage range.

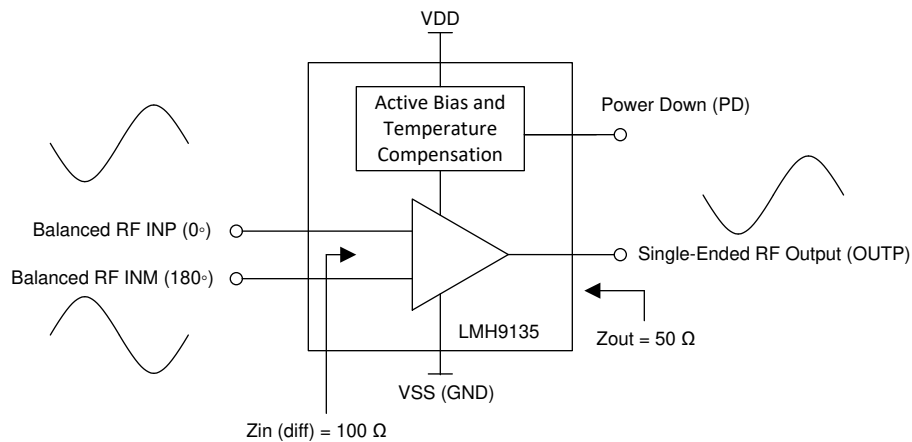

图 7-2. Differential Input to Single-Ended Output, Active Balun Implementation

7.4 Device Functional Modes

LMH9135 features a PD pin which should be connected to GND for normal operation. To power down the device, connect the PD pin to a logic high voltage of 1.8 V.

8 Application and Implementation

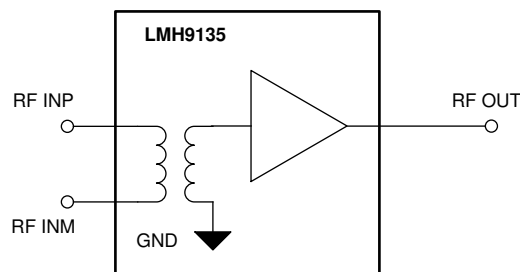
Note

Information in the following applications sections is not part of the TI component specification, and TI does not warrant its accuracy or completeness. TI's customers are responsible for determining suitability of components for their purposes. Customers should validate and test their design implementation to confirm system functionality.

8.1 Application Information

LMH9135 is a differential to single-ended RF gain block amplifier, which works as an active balun in the transmit path of a 3.3-GHz to 3.8-GHz 5G, TDD m-MIMO or small cell base station. The device replaces the traditional passive balun and single-ended RF amplifier offering a smaller footprint solution to the customer. TI recommends following good RF layout and grounding techniques to maximize the device performance.

8.2 Typical Application

LMH9135 is typically used in a four transmit and four receive (4T/4R) array of active antenna system for 5G, TDD, wireless base station applications. Such a system is shown in [Figure 8-1](#), where the LMH9135 is used in the transmit path as an active balun that converts differential DAC output from Tx AFE to single-ended signal. Also shown in the figure is the application of LMH9235 chip, which is the counter-part of LMH9135 in the Receive path.



图 8-1. LMH9135 in a 4T/4R 5G Active Antenna System

The 4T/4R system can be scaled to 16T/16R, 64T/64R, or higher antenna arrays that result in proportional scaling of the overall system power dissipation. As a result of the proportional scaling factor for multiple channels in a system, the individual device power consumption must be reduced to dissipate less overall heat in the system. Operating on a single 3.3-V supply, the LMH9135 consumes only about 400 mW and therefore provides power saving to the customer. Multiple LMH9135 devices can be powered from a single DC/DC converter or a low-dropout regulator (LDO) operating on a 3.3-V supply. A DC/DC converter provides the most power efficient way of generating the 3.3-V supply. However, care must be taken when using the DC/DC converter to minimize the switching noise using inductor chokes and adequate isolation must be provided between the analog and digital power domains.

8.2.1 Design Requirements

Input of LMH9135 is matched to $100\ \Omega$ and therefore can be directly driven by a DAC that has $100\ \Omega$ source impedance without any external matching network. If a DAC with different impedance is used, then it should be appropriately matched to get the best RF performance.

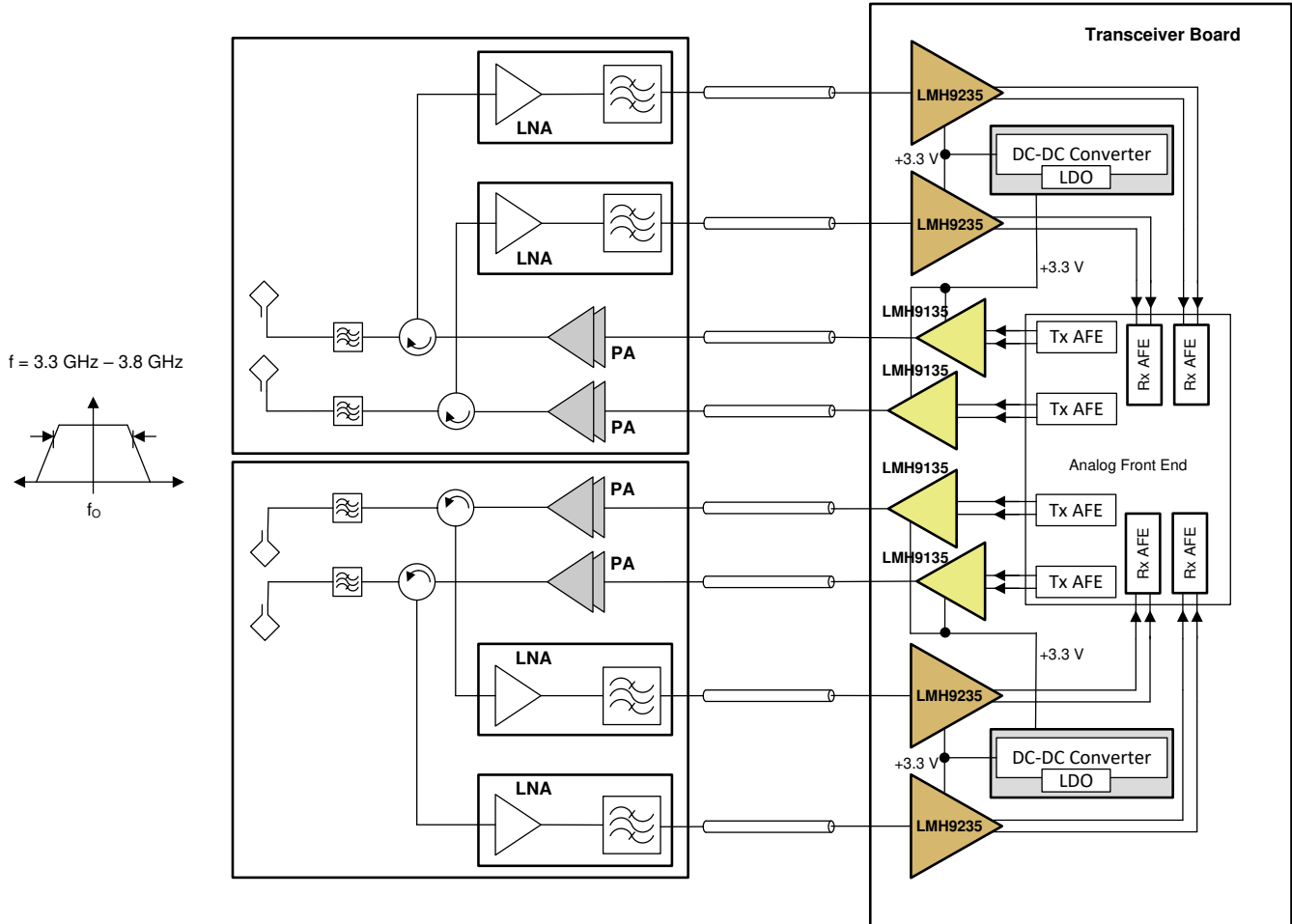
The example in 图 8-2 shows how LMH9135 can be matched to a DAC that has $200\text{-}\Omega$ differential termination.



图 8-2. LMH9135 Driven by a DAC with 200-Ω Termination

8.2.2 Detailed Design Procedure

A simple differential LC network is used here as the matching network. In 图 8-2, shunt inductor L1 and series capacitors C2 form the matching network. The series capacitors C1 act as the DC-blocking capacitors. 表 8-1 shows the matching network component values.

表 8-1. Matching Network Component Values for 200-Ω Termination

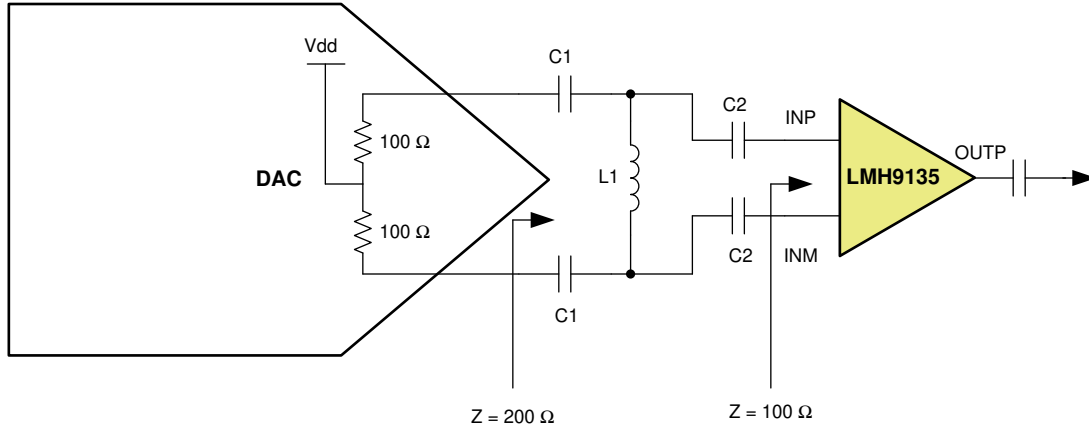
COMPONENT	VALUE
C1	5.6 pF
L1	6.8 nH
C2	0.8 pF

8.2.3 Application Curves

The graphs given below show the gain, input return loss, and output return loss of the design with different DAC terminations.



图 8-3. Gain vs Frequency for Different DAC Terminations



图 8-4. Input Return Loss vs Frequency for Different DAC Terminations

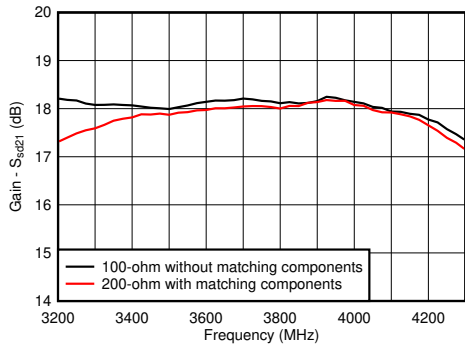

图 8-5. Output Return Loss vs Frequency for Different DAC Terminations

9 Power Supply Recommendations

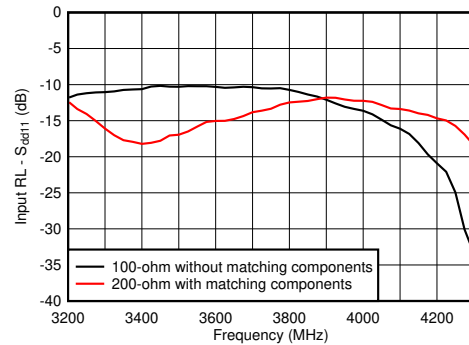
The LMH9135 device operates on a common nominal 3.3 V supply voltage. It is recommended to isolate the supply voltage through decoupling capacitors placed close to the device. Select capacitors with self resonant frequency above the application frequency. When multiple capacitors are used in parallel to create a broadband decoupling network, place the capacitor with the higher self-resonant frequency closer to the device.

10 Layout

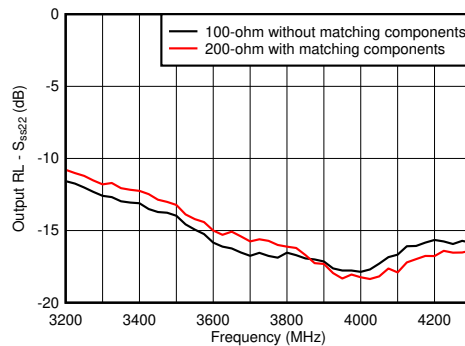
10.1 Layout Guidelines

When designing with an RF amplifier operating in the frequency range 3 GHz to 4.2 GHz with relatively high gain, certain board layout precautions must be taken to ensure stability and optimum performance. TI recommends that the LMH9135 board be multi-layered to improve thermal performance, grounding, and power-supply decoupling. [图 10-1](#) shows a good layout example. In this figure, only the top signal layer is shown.

- Excellent electrical connection from the thermal pad to the board ground is essential. Use the recommended footprint, solder the pad to the board, and do not include a solder mask under the pad.
- Connect the pad ground to the device terminal ground on the top board layer.
- Ensure that ground planes on the top and any internal layers are well stitched with vias.
- Design the two input and one output RF traces for 50- Ω impedance. TI recommends grounded coplanar waveguide (GCPW) type transmission lines for the RF traces. Use a PCB trace width calculator tool to design the transmission lines.
- Avoid routing clocks and digital control lines near RF signal lines.
- Do not route RF or DC signal lines over noisy power planes.
- Place supply decoupling close to the device.
- The differential output traces must be symmetrical in order to achieve the best differential balance and linearity performance.

See the [LMH9135 Evaluation Module user's guide](#) for more details on board layout and design.

10.2 Layout Example



图 10-1. Layout Showing Matched Differential Traces and Supply Decoupling

11 Device and Documentation Support

11.1 Documentation Support

11.1.1 Related Documentation

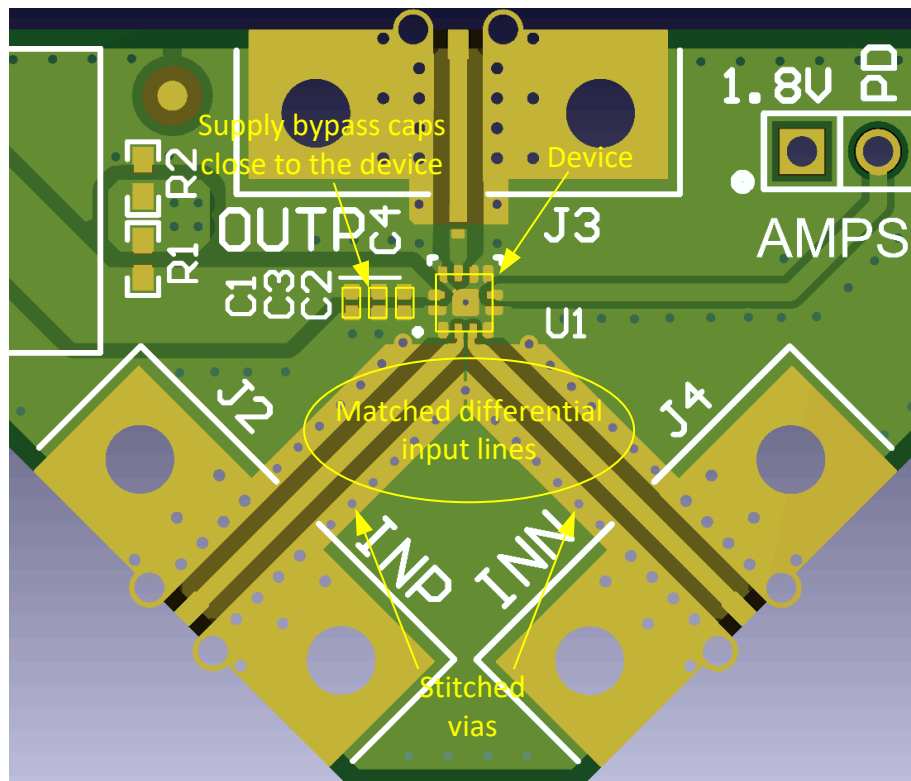
For related documentation see the following:

- Texas Instruments, [LMH9135 Evaluation Module User's Guide](#)
- Texas Instruments, [LMH9135 S-parameter Models](#)
- Texas Instruments, [LMH9135RRLEVM EU Declaration of Conformity \(DoC\)](#)

11.2 Receiving Notification of Documentation Updates

To receive notification of documentation updates, navigate to the device product folder on ti.com. In the upper right corner, click on *Alert me* to register and receive a weekly digest of any product information that has changed. For change details, review the revision history included in any revised document.

11.3 Support Resources

TI E2E™ [support forums](#) are an engineer's go-to source for fast, verified answers and design help — straight from the experts. Search existing answers or ask your own question to get the quick design help you need.

Linked content is provided "AS IS" by the respective contributors. They do not constitute TI specifications and do not necessarily reflect TI's views; see TI's [Terms of Use](#).

11.4 Trademarks

TI E2E™ is a trademark of Texas Instruments.

所有商标均为其各自所有者的财产。

11.5 Electrostatic Discharge Caution



This integrated circuit can be damaged by ESD. Texas Instruments recommends that all integrated circuits be handled with appropriate precautions. Failure to observe proper handling and installation procedures can cause damage.

ESD damage can range from subtle performance degradation to complete device failure. Precision integrated circuits may be more susceptible to damage because very small parametric changes could cause the device not to meet its published specifications.

11.6 Glossary

[TI Glossary](#) This glossary lists and explains terms, acronyms, and definitions.

12 Mechanical, Packaging, and Orderable Information

The following pages include mechanical, packaging, and orderable information. This information is the most current data available for the designated devices. This data is subject to change without notice and revision of this document. For browser-based versions of this data sheet, refer to the left-hand navigation.

重要声明和免责声明

TI 提供技术和可靠性数据 (包括数据表)、设计资源 (包括参考设计)、应用或其他设计建议、网络工具、安全信息和其他资源, 不保证没有瑕疵且不做任何明示或暗示的担保, 包括但不限于对适销性、某特定用途方面的适用性或不侵犯任何第三方知识产权的暗示担保。

这些资源可供使用 TI 产品进行设计的熟练开发人员使用。您将独自承担以下全部责任: (1) 针对您的应用选择合适的 TI 产品, (2) 设计、验证并测试您的应用, (3) 确保您的应用满足相应标准以及任何其他安全、安保或其他要求。这些资源如有变更, 恕不另行通知。TI 授权您仅可将这些资源用于开发本资源所述的使用 TI 产品的应用。严禁对这些资源进行其他复制或展示。您无权使用任何其他 TI 知识产权或任何第三方知识产权。您应全额赔偿因在这些资源的使用中对 TI 及其代表造成的任何索赔、损害、成本、损失和债务, TI 对此概不负责。

TI 提供的产品受 TI 的销售条款 () 或 Ti.com.cn 上其他适用条款/TI 产品随附的其他适用条款的约束。TI 提供这些资源并不会扩展或以其他方式更改 TI 针对 TI 产品发布的适用的担保或担保免责声明。

邮寄地址: Texas Instruments, Post Office Box 655303, Dallas, Texas 75265
Copyright © 2020, 德州仪器 (TI) 公司

PACKAGING INFORMATION

Orderable Device	Status (1)	Package Type	Package Drawing	Pins	Package Qty	Eco Plan (2)	Lead finish/ Ball material (6)	MSL Peak Temp (3)	Op Temp (°C)	Device Marking (4/5)	Samples
LMH9135IRRLR	ACTIVE	WQFN	RRL	12	3000	RoHS & Green	NIPDAUAG	Level-2-260C-1 YEAR	-40 to 105	35AO	Samples

(1) The marketing status values are defined as follows:

ACTIVE: Product device recommended for new designs.

LIFEBUY: TI has announced that the device will be discontinued, and a lifetime-buy period is in effect.

NRND: Not recommended for new designs. Device is in production to support existing customers, but TI does not recommend using this part in a new design.

PREVIEW: Device has been announced but is not in production. Samples may or may not be available.

OBSELETE: TI has discontinued the production of the device.

(2) **RoHS:** TI defines "RoHS" to mean semiconductor products that are compliant with the current EU RoHS requirements for all 10 RoHS substances, including the requirement that RoHS substance do not exceed 0.1% by weight in homogeneous materials. Where designed to be soldered at high temperatures, "RoHS" products are suitable for use in specified lead-free processes. TI may reference these types of products as "Pb-Free".

RoHS Exempt: TI defines "RoHS Exempt" to mean products that contain lead but are compliant with EU RoHS pursuant to a specific EU RoHS exemption.

Green: TI defines "Green" to mean the content of Chlorine (Cl) and Bromine (Br) based flame retardants meet JS709B low halogen requirements of <=1000ppm threshold. Antimony trioxide based flame retardants must also meet the <=1000ppm threshold requirement.

(3) MSL, Peak Temp. - The Moisture Sensitivity Level rating according to the JEDEC industry standard classifications, and peak solder temperature.

(4) There may be additional marking, which relates to the logo, the lot trace code information, or the environmental category on the device.

(5) Multiple Device Markings will be inside parentheses. Only one Device Marking contained in parentheses and separated by a "-" will appear on a device. If a line is indented then it is a continuation of the previous line and the two combined represent the entire Device Marking for that device.

(6) Lead finish/Ball material - Orderable Devices may have multiple material finish options. Finish options are separated by a vertical ruled line. Lead finish/Ball material values may wrap to two lines if the finish value exceeds the maximum column width.

Important Information and Disclaimer:The information provided on this page represents TI's knowledge and belief as of the date that it is provided. TI bases its knowledge and belief on information provided by third parties, and makes no representation or warranty as to the accuracy of such information. Efforts are underway to better integrate information from third parties. TI has taken and continues to take reasonable steps to provide representative and accurate information but may not have conducted destructive testing or chemical analysis on incoming materials and chemicals. TI and TI suppliers consider certain information to be proprietary, and thus CAS numbers and other limited information may not be available for release.

In no event shall TI's liability arising out of such information exceed the total purchase price of the TI part(s) at issue in this document sold by TI to Customer on an annual basis.

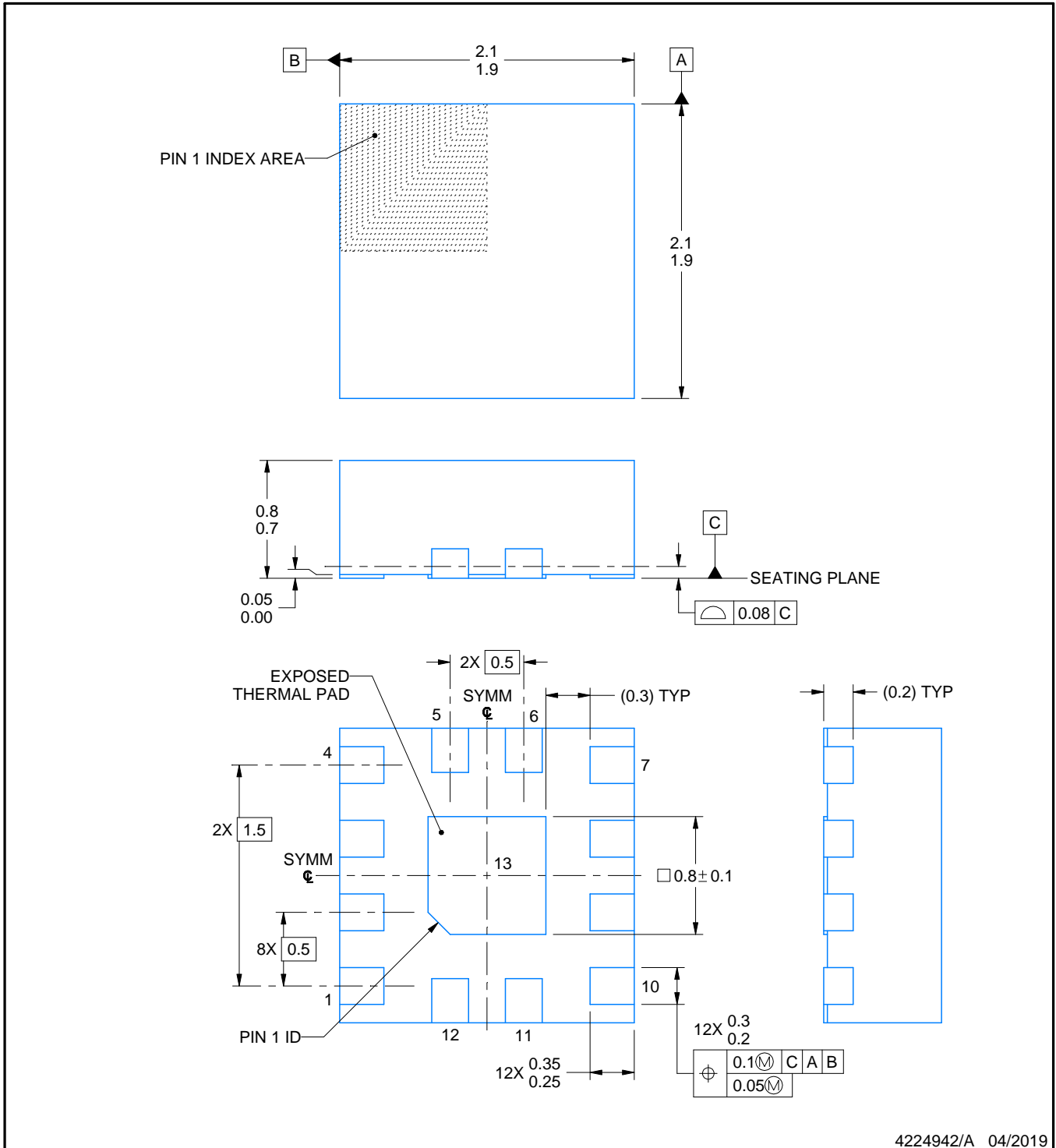
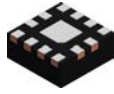

4224942/A 04/2019

NOTES:

1. All linear dimensions are in millimeters. Any dimensions in parenthesis are for reference only. Dimensioning and tolerancing per ASME Y14.5M.
2. This drawing is subject to change without notice.
3. The package thermal pad must be soldered to the printed circuit board for thermal and mechanical performance.

EXAMPLE BOARD LAYOUT

RRL0012A

WQFN - 0.8 mm max height

PLASTIC QUAD FLATPACK - NO LEAD

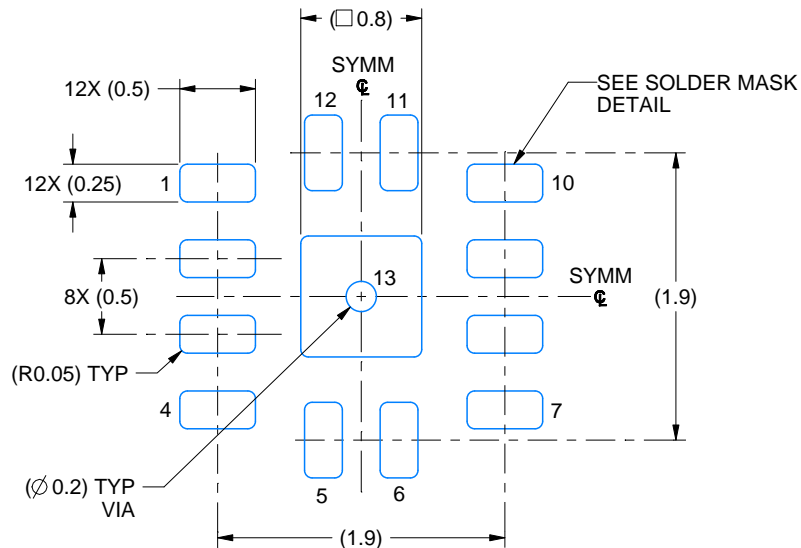

LAND PATTERN EXAMPLE
EXPOSED METAL SHOWN
SCALE: 20X

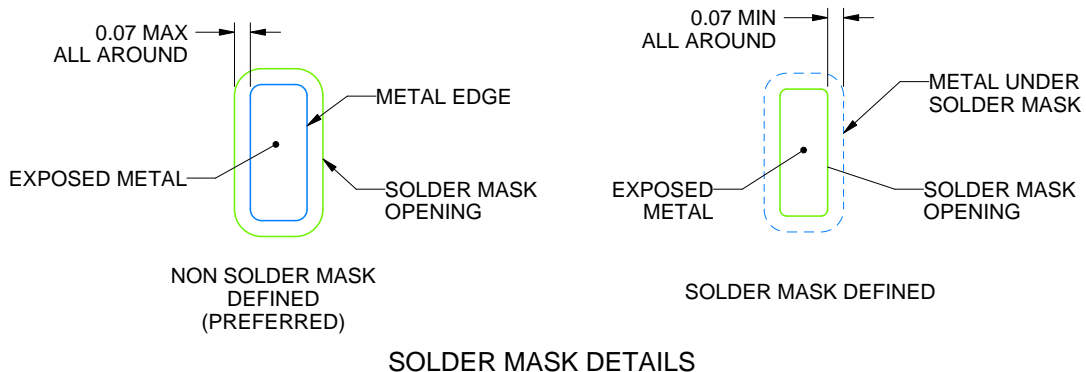

4224942/A 04/2019

NOTES: (continued)

4. This package is designed to be soldered to a thermal pad on the board. For more information, see Texas Instruments literature number SLUA271 (www.ti.com/lit/sl原因271).
5. Vias are optional depending on application, refer to device data sheet. If any vias are implemented, refer to their locations shown on this view. It is recommended that vias under paste be filled, plugged or tented.

EXAMPLE STENCIL DESIGN

RRL0012A

WQFN - 0.8 mm max height

PLASTIC QUAD FLATPACK - NO LEAD

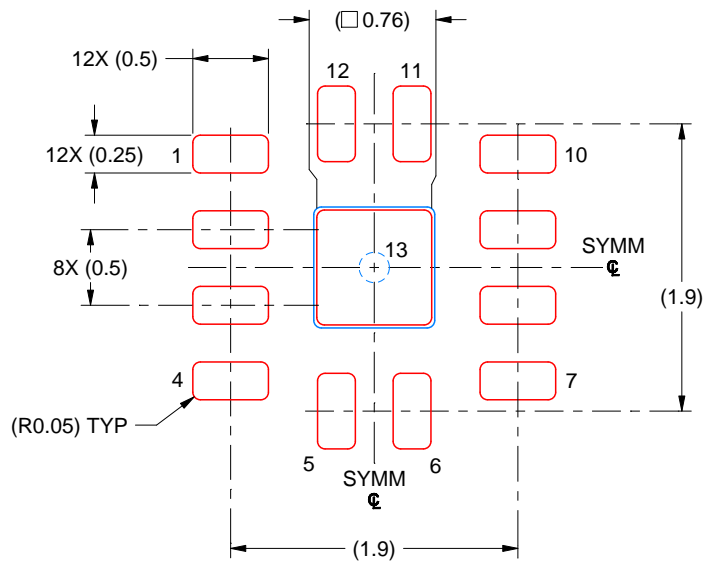

SOLDER PASTE EXAMPLE
BASED ON 0.125 MM THICK STENCIL
SCALE: 20X

EXPOSED PAD 13
90% PRINTED SOLDER COVERAGE BY AREA UNDER PACKAGE

4224942/A 04/2019

NOTES: (continued)

6. Laser cutting apertures with trapezoidal walls and rounded corners may offer better paste release. IPC-7525 may have alternate design recommendations.

重要声明和免责声明

TI 提供技术和可靠性数据（包括数据表）、设计资源（包括参考设计）、应用或其他设计建议、网络工具、安全信息和其他资源，不保证没有瑕疵且不做任何明示或暗示的担保，包括但不限于对适销性、某特定用途方面的适用性或不侵犯任何第三方知识产权的暗示担保。

这些资源可供使用 TI 产品进行设计的熟练开发人员使用。您将自行承担以下全部责任：(1) 针对您的应用选择合适的 TI 产品，(2) 设计、验证并测试您的应用，(3) 确保您的应用满足相应标准以及任何其他安全、安保或其他要求。这些资源如有变更，恕不另行通知。TI 授权您仅可将这些资源用于研发本资源所述的 TI 产品的应用。严禁对这些资源进行其他复制或展示。您无权使用任何其他 TI 知识产权或任何第三方知识产权。您应全额赔偿因在这些资源的使用中对 TI 及其代表造成的任何索赔、损害、成本、损失和债务，TI 对此概不负责。

TI 提供的产品受 TI 的销售条款 (<https://www.ti.com.cn/zh-cn/legal/termsofsale.html>) 或 [ti.com.cn](https://www.ti.com.cn) 上其他适用条款/TI 产品随附的其他适用条款的约束。TI 提供这些资源并不会扩展或以其他方式更改 TI 针对 TI 产品发布的适用的担保或担保免责声明。

邮寄地址：上海市浦东新区世纪大道 1568 号中建大厦 32 楼，邮政编码：200122

Copyright © 2021 德州仪器半导体技术（上海）有限公司