

## LMK6x 低抖动高性能 BAW 振荡器

### 1 特性

- 高性能差分 and 单端输出振荡器、支持以下范围内的任何固定频率：
  - LMK6D：1MHz 至 400MHz，LVDS 输出
  - LMK6H：1MHz 至 400MHz，HCSL 输出
  - LMK6P：1MHz 至 400MHz，LVPECL 输出
  - LMK6C：1MHz 至 200MHz，LVCMOS 输出
- 超低抖动：
  - LMK6D/LMK6H/LMK6P：频率为 156.25MHz 时 RMS 抖动典型值为 100fs，最大值为 125fs (12kHz 至 20MHz)
  - LMK6C：频率为 100MHz 时 RMS 抖动典型值为 350fs，最大值为 500fs (12kHz 至 20MHz)
  - LMK6H：符合 PCIe 第 1 代到第 6 代标准
- $\pm 25$ ppm 的总频率稳定性 (考虑 10 年老化和所有其他因素)
- 超小型业界通用 DLE 和 DLF 封装
- 支持扩展工业温度等级：
  - LMK6P/LMK6D/LMK6H：-40°C 至 85°C
  - LMK6C：-40°C 至 105°C
- 集成 LDO，具有强大的抗电源噪声能力：
  - 在 500kHz 纹波下具有 -72dBc PSRR
- 启动时间：< 5ms
- 标准频率：
  - LVCMOS (MHz)：1、2.04、4、8.192、10、12、12.288、16、19.2、20、23.5、24、24.57、25、25.6、26、26.21、27、28.12、32.768、33.333、40、48、49.15、50、54、60、65.53、66、74.25、76.8、80、100、108、125、133.330 和 156.25
  - 差分 (MHz)：25、26、32.5、50、51.84、54、65、76.8、80、100、108、122.88、125、133.330、148.35、148.5、150、155.52、156.25、161.1328125、200、312.5 和 400
- 器件可支持 1MHz 至 400MHz 之间的任何频率。如有任何频率和样片需求，请与 TI 代表联系

### 2 应用

- 56G/112G PAM4 时钟
- 100G/200G/400G/800G 光纤传输网络和相干光学元件
- 网络设备、交换机、路由器、线路卡、SAN、数据中心和基带单元 (BBU)
- 符合 PCIe 第 1 代到第 6 代标准的参考时钟
- 工业应用
- 测试和测量

- ASIC、FPGA、MCU 参考时钟
- 高性能晶体振荡器替代产品

### 3 说明

德州仪器 (TI) 的体声波 (BAW) 是一种微谐振器技术，能够将高精度 BAW 谐振器直接集成到具有超低抖动时钟电路的封装中。与其他硅基制造工艺一样，BAW 完全由 TI 工厂设计和制造。

LMK6x 器件是一款超低抖动固定频率振荡器，融合了 BAW 作为谐振器源。该器件根据特定运行模式进行出厂编程，包括频率、电压、输出类型和功能引脚。LMK6x 带有高性能分数分频器，能够产生指定范围内的任何频率，提供可满足所有频率需求的单个器件系列。

凭借高性能时钟、机械稳定性、灵活性和小型封装选项，此器件非常适用于电信、数据以及企业网络和工业应用中使用的高速 SERDES 内的参考时钟和核心时钟。

#### 封装信息

器件型号	输出类型	封装 <sup>(1)</sup>	封装尺寸 <sup>(2)</sup>
LMK6C	LVCMOS	VSON (DLE-4)	3.2mm × 2.5mm
LMK6C		VSON (DLF-4)	2.5mm × 2mm
LMK6D LMK6H LMK6P	LVDS、 HCSL、 LVPECL	VSON (DLE-6)	3.2mm × 2.5mm
LMK6D LMK6H LMK6P		VSON (DLF-6)	2.5mm × 2mm

- 有关所有可用封装，请参阅节 12。
- 封装尺寸 (长 × 宽) 为标称值，并包括引脚 (如适用)。

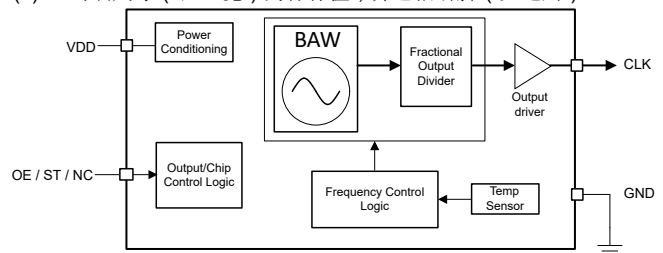

LMK6x 简化方框图



## 内容

<b>1 特性</b> .....	1	8.1 概述.....	21
<b>2 应用</b> .....	1	8.2 功能方框图.....	21
<b>3 说明</b> .....	1	8.3 特性说明.....	21
<b>4 器件订购信息</b> .....	3	8.4 器件功能模式.....	26
<b>5 引脚配置和功能</b> .....	5	<b>9 应用和实施</b> .....	26
<b>6 规格</b> .....	6	9.1 应用信息.....	27
6.1 绝对最大额定值.....	6	9.2 典型应用.....	27
6.2 ESD 等级.....	6	9.3 电源相关建议.....	30
6.3 环境合规性.....	6	9.4 布局.....	30
6.4 建议运行条件.....	6	<b>10 器件和文档支持</b> .....	33
6.5 热性能信息.....	7	10.1 文档支持.....	33
6.6 热性能信息.....	7	10.2 接收文档更新通知.....	33
6.7 电气特性.....	8	10.3 支持资源.....	33
6.8 时序图.....	14	10.4 商标.....	33
6.9 典型特性.....	14	10.5 静电放电警告.....	33
<b>7 参数测量信息</b> .....	19	10.6 术语表.....	33
7.1 器件输出配置.....	19	<b>11 修订历史记录</b> .....	33
<b>8 详细说明</b> .....	21	<b>12 机械、封装和可订购信息</b> .....	34

## 4 器件订购信息

使用图 4-1 和图 4-2 了解 LMK6x 可订购选项的器件命名规则。



图 4-1. 器件型号指南：LMK6D、LMK6H 和 LMK6P



图 4-2. 器件型号指南 : LMK6C

## 5 引脚配置和功能

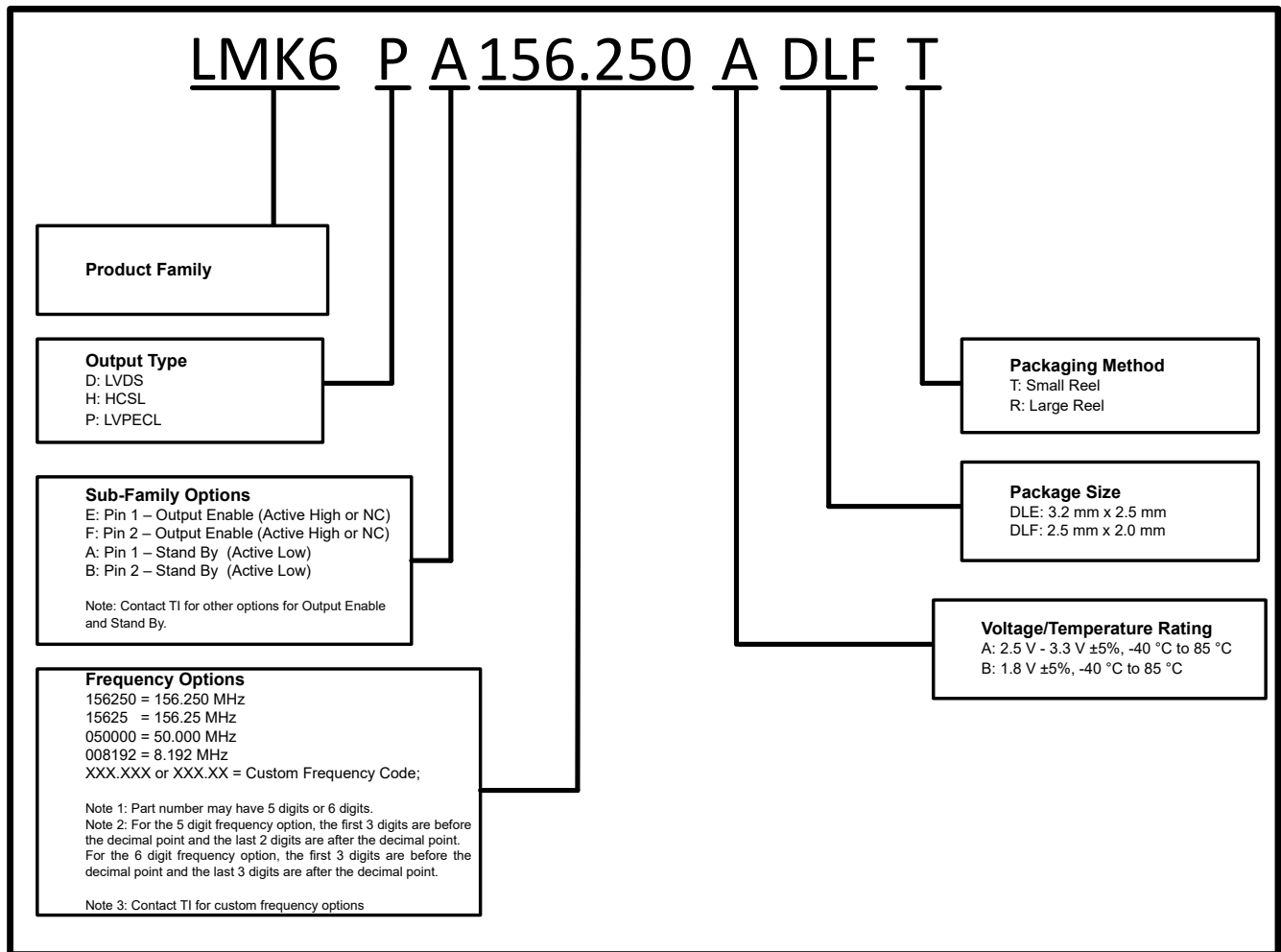

图 5-1. LMK6P、LMK6D 或 LMK6H 6 引脚 VSON (顶视图)

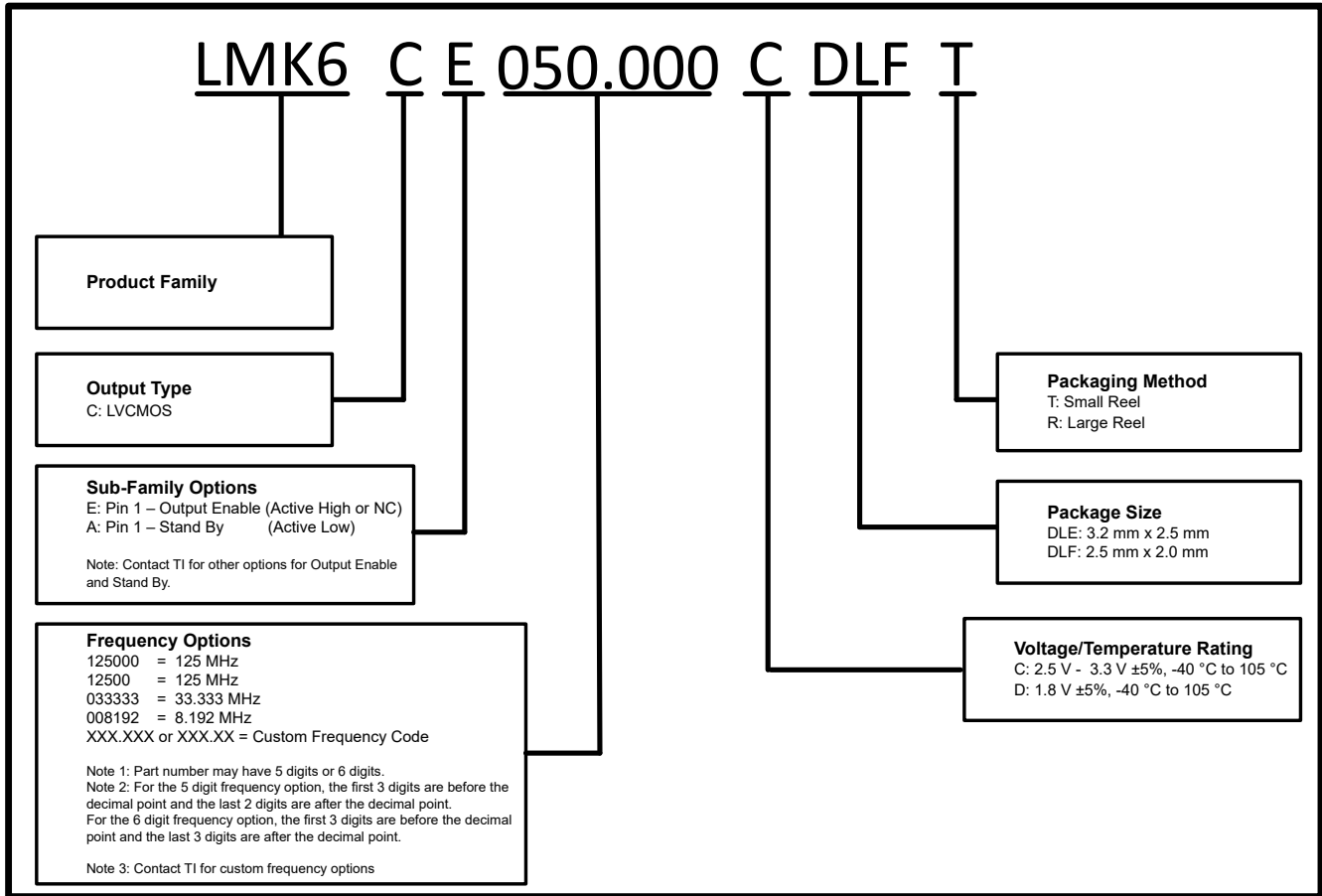
表 5-1. LMK6P、LMK6D 或 LMK6H 引脚功能

引脚		类型 <sup>(1)</sup>	说明
名称	DLE/DLF		
OE/ST/NC	1	I/NC	输出使能 (OE) 或待机 (ST) 引脚或无连接 (NC)。有关更多详细信息，请参阅表 8-1。
OE/ST/NC	2	NC/I	输出使能 (OE) 或待机 (ST) 引脚或无连接 (NC)。有关更多详细信息，请参阅表 8-1。
GND	3	G	器件地
OUTP	4	O	正差分输出时钟
OUTN	5	O	负差分输出时钟
VDD	6	P	器件电源

(1) I = 输入，O = 输出，I/O = 输入或输出，G = 地，P = 电源，NC = 无连接 (可保持悬空)。

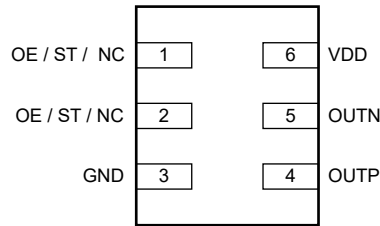

图 5-2. LMK6C 4 引脚 VSON (顶视图)

表 5-2. LMK6C 引脚功能

引脚		类型 <sup>(1)</sup>	说明
名称	DLE/DLF		
OE/ST/NC	1	I/NC	输出使能 (OE) 或待机 (ST) 引脚或无连接 (NC)。有关更多详细信息，请参阅表 8-2。
GND	2	G	器件地
OUT	3	O	LVCMOS 输出时钟
VDD	4	P	器件电源

(1) I = 输入，O = 输出，I/O = 输入或输出，G = 地，P = 电源，NC = 无连接 (可保持悬空)。

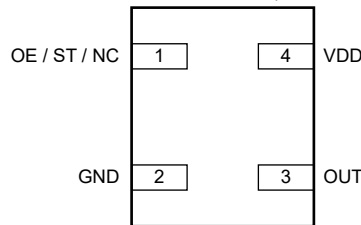
## 6 规格

### 6.1 绝对最大额定值

在自然通风条件下的工作温度范围内测得 (除非另有说明) <sup>(1)</sup>

		最小值	最大值	单位
VDD	器件电源电压 <sup>(2)</sup>	-0.3	3.63	V
	器件电源电压 <sup>(3)</sup>	-0.3	1.98	V
EN	逻辑输入电压	-0.3	VDD + 0.3	V
OUTP、OUTN	时钟输出电压 <sup>(4)</sup>	-0.3	VDD + 0.3	V
OUT	时钟输出电压 <sup>(5)</sup>	-0.3	VDD + 0.3	V
T <sub>J</sub>	结温		125	°C
T <sub>STG</sub>	贮存温度		150	°C

- (1) 超出“绝对最大额定值”运行可能会对器件造成永久损坏。绝对最大额定值并不表示器件在这些条件下或在建议运行条件以外的任何其他条件下能够正常运行。如果在建议运行条件之外但在绝对最大额定值范围内使用，器件可能不会完全正常运行，这可能会影响器件的可靠性、功能和性能，并缩短器件的寿命。
- (2) 适用于所有建议工作电压为 2.5V +/- 5% 和 3.3V +/- 5% 的器件
- (3) 适用于所有建议工作电压为 1.8V +/- 5% 的器件
- (4) 适用于所有差分输出 - LMK6D、LMK6H 和 LMK6P。
- (5) 适用于单端输出 - LMK6C。

### 6.2 ESD 等级

			值	单位
V <sub>(ESD)</sub>	静电放电	人体放电模型 (HBM), 符合 ANSI/ESDA/JEDEC JS-001 标准, 所有引脚 <sup>(1)</sup>	±2000	V
		充电器件模型 (CDM), 符合 JEDEC JS-002, 所有引脚 <sup>(2)</sup>	±500	

- (1) JEDEC 文档 JEP155 指出：500V HBM 时能够在标准 ESD 控制流程下安全生产。
- (2) JEDEC 文档 JEP157 指出：250V CDM 时能够在标准 ESD 控制流程下安全生产。

### 6.3 环境合规性

		值	单位
抗机械冲击	MIL-STD-883F, 方法 2002, 条件 A	1500	g
抗机械振动	MIL-STD-883F, 方法 2026, 条件 C	10	g
	MIL-STD-883F, 方法 2007, 条件 A	20	g
湿敏等级 (MSL)		MSL1	

### 6.4 建议运行条件

在自然通风条件下的工作温度范围内测得 (除非另有说明)

		最小值	标称值	最大值	单位
VDD	器件电源电压 <sup>(1)</sup>	1.7	1.8	1.9	V
	器件电源电压 <sup>(2)</sup>	2.37	2.5、3.3	3.5	V
T <sub>A</sub>	环境温度 <sup>(3)</sup>	-40		85	°C
	环境温度 <sup>(4)</sup>	-40		105	°C
T <sub>J</sub>	结温			125	°C
t <sub>RAMP</sub>	VDD 上电斜坡时间 <sup>(1) (2)</sup>	0.1		100	ms

- (1) 适用于所有建议工作电压为 1.8V +/- 5% 的器件
- (2) 适用于所有建议工作电压为 2.5V +/- 5% 和 3.3V +/- 5% 的器件
- (3) 适用于所有差分输出 - LMK6D、LMK6H 和 LMK6P。

(4) 适用于单端输出 - LMK6C。

## 6.5 热性能信息

热指标 <sup>(1)</sup>		LMK6D/H/P		单位
		DLE (VSON)	DLF (VSON)	
		6 引脚	6 引脚	
$R_{\theta JA}$	结至环境热阻	101.2	107.9	°C/W
$R_{\theta JC(top)}$	结至外壳 (顶部) 热阻	58.6	70.1	°C/W
$R_{\theta JB}$	结至电路板热阻	31.3	39.4	°C/W
$\Psi_{JT}$	结至顶部特征参数	2.7	2.3	°C/W
$\Psi_{JB}$	结至电路板特征参数	31.1	39.2	°C/W

(1) 有关新旧热指标的更多信息，请参阅[半导体](#)和[IC 封装热指标](#)应用报告。

## 6.6 热性能信息

热指标 <sup>(1)</sup>		LMK6C		单位
		DLE (VSON)	DLF (VSON)	
		4 引脚	4 引脚	
$R_{\theta JA}$	结至环境热阻	124.8	128.1	°C/W
$R_{\theta JC(top)}$	结至外壳 (顶部) 热阻	61.2	73.2	°C/W
$R_{\theta JB}$	结至电路板热阻	42.5	39.8	°C/W
$\Psi_{JT}$	结至顶部特征参数	2.8	2.4	°C/W
$\Psi_{JB}$	结至电路板特征参数	42.3	39.5	°C/W

(1) 有关新旧热指标的更多信息，请参阅[半导体](#)和[IC 封装热指标](#)应用报告。

## 6.7 电气特性

典型温度 = 25°C，频率输出 = 156.25MHz，VDD = 3.3V，LVCMOS 输出电容负载 = 2.2pF (除非另有说明) <sup>(7)</sup>

参数		测试条件	最小值	典型值	最大值	单位
<b>电流消耗特性</b>						
I <sub>DD</sub>	器件功耗 (LVPECL、VDD = 2.5V/3.3V、不包括负载电流)	100MHz		65	82	mA
		156.25MHz		69	87	mA
		200MHz		67	85	mA
		312.5MHz		76	95	mA
		400MHz		88	108	mA
	器件功耗 (LVPECL、VDD = 1.8V、不包括负载电流)	100MHz		61	79	mA
		156.25MHz		66	83	mA
		200MHz		64	82	mA
		312.5MHz		73	91	mA
		400MHz		84	104	mA
	器件功耗 (HCSL、VDD = 2.5V/3.3V、不包括负载电流)	100MHz		65	82	mA
		156.25MHz		69	87	mA
		200MHz		67	86	mA
		312.5MHz		76	96	mA
		400MHz		88	108	mA
	器件功耗 (HCSL、VDD = 1.8V、不包括负载电流)	100MHz		58	75	mA
		156.25MHz		62	80	mA
		200MHz		60	78	mA
		312.5MHz		69	88	mA
		400MHz		77	97	mA
	器件功耗 (LVDS、VDD = 2.5V/3.3V、不包括负载电流)	100MHz		54	71	mA
		156.25MHz		58	75	mA
		200MHz		56	74	mA
		312.5MHz		65	84	mA
		400MHz		76	96	mA
	器件功耗 (LVDS、VDD = 1.8V、不包括负载电流)	100MHz		52	68	mA
		156.25MHz		56	72	mA
		200MHz		54	71	mA
		312.5MHz		63	80	mA
		400MHz		74	92	mA
	器件功耗 (LVCMOS、VDD = 2.5V/3.3V、带负载)	100MHz		45	62	mA
		156.25MHz		55	71	mA
200MHz			61	77	mA	
器件功耗 (LVCMOS、VDD = 1.8V、带负载)	100MHz		44	59	mA	
	156.25MHz		50	65	mA	
	200MHz		56	72	mA	
I <sub>DD-STBY</sub>	器件待机电流	ST (待机) = GND		6	13	mA
I <sub>DD-PD</sub>	输出禁用时的器件电流 (100MHz)	OE = GND、LVPECL 模式、VDD = 3.3V		48	67	mA
		OE = GND、HCSL 模式、VDD = 3.3V		49	67	mA
		OE = GND、LVDS 模式、VDD = 3.3V		49	66	mA
		OE = GND、LVCMOS 模式、VDD = 3.3V		40	56	mA
<b>LVPECL 输出特性</b>						



典型温度 = 25°C, 频率输出 = 156.25MHz, VDD = 3.3V, LVCMOS 输出电容负载 = 2.2pF (除非另有说明) (7)

参数		测试条件	最小值	典型值	最大值	单位
F <sub>out</sub>	输出频率		1		400	MHz
V <sub>OD</sub>	输出电压摆幅 (V <sub>OH</sub> - V <sub>OL</sub> )	交流耦合, VDD = 3.3V	525	645	765	mV
		交流耦合, VDD = 2.5V	450	555	660	mV
		交流耦合, VDD = 1.8V	280	375	470	mV
		直流耦合, VDD = 2.5V/3.3V <sup>(1)</sup>	650	800	950	mV
		直流耦合, VDD = 1.8V <sup>(1)</sup>	450	600	750	mV
V <sub>OD,DIFF</sub>	差分输出峰峰值摆幅		2× V <sub>OD</sub>			V <sub>pp</sub>
V <sub>OS</sub>	输出共模电压	VDD = 3.3V <sup>(1)</sup>	1.5	1.6	1.7	V
		VDD = 2.5V <sup>(1)</sup>	0.825	0.9	0.975	V
		VDD = 1.8V <sup>(1)</sup>	0.45	0.5	0.55	V
t <sub>R</sub> /t <sub>F</sub>	输出上升/下降时间	V <sub>OD,DIFF</sub> 的 20% 至 80%、VDD = 2.5V/3.3V		120	200	ps
		V <sub>OD,DIFF</sub> 的 20% 至 80%、VDD = 1.8V		120	200	ps
ODC	输出占空比	VDD = 2.5V/3.3V、在波形上 50% 的点之间测量	45	50	55	%
		VDD = 1.8V、在波形上 50% 的点之间测量	45	50	55	%
<b>LVDS 输出特性</b>						
F <sub>out</sub>	输出频率		1		400	MHz
V <sub>OD</sub>	输出电压摆幅 (V <sub>OH</sub> - V <sub>OL</sub> )	在 LVDS 负载条件下	250	350	450	mV
V <sub>OD,DIFF</sub>	差分输出峰峰值摆幅		2× V <sub>OD</sub>			V <sub>pp</sub>
V <sub>OS</sub>	输出共模电压	VDD = 2.5V/3.3V	1.025	1.2	1.375	V
		VDD = 1.8V	0.80	0.9	1.0	V
t <sub>R</sub> /t <sub>F</sub>	输出上升/下降时间	V <sub>OD,DIFF</sub> 的 20% 至 80%、VDD = 2.5V/3.3V		150	250	ps
		V <sub>OD,DIFF</sub> 的 20% 至 80%、VDD = 1.8V		150	250	ps
ODC	输出占空比	VDD = 2.5V/3.3V、在波形上 50% 的点之间测量	45	50	55	%
		VDD = 1.8V、在波形上 50% 的点之间测量	45	50	55	%
<b>HCSL 输出特性</b>						
F <sub>out</sub>	输出频率		1		400	MHz
V <sub>OH</sub>	输出高电压	直流耦合、50Ω 接地、VDD = 2.5V/3.3V	650	750	850	mV
		直流耦合、50Ω 接地、VDD = 1.8V	460	560	660	mV
V <sub>OL</sub>	输出低电压	直流耦合、50Ω 接地、VDD = 2.5V/3.3V	-150	0	150	mV
		直流耦合、50Ω 接地、VDD = 1.8V	-150	0	150	mV
V <sub>OD,DIFF</sub>	差分输出峰峰值摆幅		2× V <sub>OH</sub> - V <sub>OL</sub>			V
V <sub>cross</sub>	绝对交叉点电压	VDD = 3.3V/2.5V, f <sub>out</sub> = 100MHz	0.2	0.35	0.50	V <sub>pp</sub>
		VDD = 1.8V, f <sub>out</sub> = 100MHz	0.15	0.275	0.40	V <sub>pp</sub>
V <sub>cross-delta</sub>	绝对交叉点电压差	VDD = 3.3V/2.5V/1.8V, f <sub>out</sub> = 100MHz	0.14			V
dV/dt	输出压摆率	50Ω 接地; 直流耦合负载; 从中心测得的压摆率为 +/-150mV。	2		12	V/ns
Δ dV/dt	输出压摆率变化				20	%
ODC	输出占空比		45	50	55	%

**LMK6C, LMK6D, LMK6H, LMK6P**

ZHCSNQ0E - APRIL 2022 - REVISED APRIL 2024

 典型温度 = 25°C, 频率输出 = 156.25MHz, VDD = 3.3V, LVCMOS 输出电容负载 = 2.2pF (除非另有说明) <sup>(7)</sup>

参数		测试条件	最小值	典型值	最大值	单位
<b>LVCMOS 输出特性</b>						
F <sub>out</sub>	输出频率		1		200	MHz
V <sub>OL</sub>	输出低电压	I <sub>OL</sub> = 3.6mA, VDD = 1.8V			0.36	V
		I <sub>OL</sub> = 5.0mA, VDD = 2.5V			0.5	V
		I <sub>OL</sub> = 6.6mA, VDD = 3.3V			0.66	V
V <sub>OH</sub>	输出高电压	I <sub>OH</sub> = 3.6mA, VDD = 1.8V	1.44			V
		I <sub>OH</sub> = 5.0mA, VDD = 2.5V	2			V
		I <sub>OH</sub> = 6.6mA, VDD = 3.3V	2.64			V
t <sub>R</sub> /t <sub>F</sub>	输出上升/下降时间	V <sub>OH</sub> -V <sub>OL</sub> 的 20% 至 80%、C <sub>L</sub> = 2pF		0.5	1	ns
ODC	输出占空比		45	50	55	%
R <sub>out</sub>	输出阻抗	OE = 高电平	40	50	60	Ω
C <sub>L</sub>	最大容性负载	F <sub>out</sub> > 50MHz <sup>(3)</sup>			15	pF
		F <sub>out</sub> < 50MHz <sup>(3)</sup>			30	pF
<b>功能引脚输入特性 (OE/ST 引脚)</b>						
V <sub>IL</sub>	输入低电压				0.6	V
V <sub>IH</sub>	输入高电压		1.3			V
I <sub>IL</sub>	输入低电流	OE = GND	-40			μA
I <sub>IH</sub>	输入高电流	OE = VDD			40	μA
C <sub>IN</sub>	输入电容			2		pF
<b>LVDS、HCSL 和 LVPECL 频率容差</b>						
F <sub>T</sub>	总频率稳定性	包括：焊接漂移、初始容差、-40°C 到 85°C 温度范围内的变化、额定电源电压范围内的变化以及 25°C 条件下的 10 年老化。	-25		25	ppm
		包括：焊接漂移、初始容差、-40°C 到 85°C 温度范围内的变化、电源电压范围内的变化。	-20		20	ppm
<b>LVCMOS 频率容差</b>						
F <sub>T</sub>	总频率稳定性	包括：焊接漂移、初始容差、-40°C 到 105°C 温度范围内的变化、额定电源电压范围内的变化以及 25°C 条件下的 10 年老化。	-25		25	ppm
		包括：焊接漂移、初始容差、-40°C 到 105°C 温度范围内的变化、额定电源电压范围内的变化。	-20		20	ppm
<b>差分输出 PSRR 特性</b>						
PSRR	输出频率为 156.25MHz, VDD = 2.5V/3.3V, 无电源去耦电容时, 50mV 电源纹波引起的杂散	50kHz 处的正弦波		-71		dBc
		100kHz 处的正弦波		-71		dBc
		500kHz 处的正弦波		-72		dBc
		1MHz 处的正弦波		-70		dBc
PSRR	输出频率为 156.25MHz, VDD = 1.8V, 无电源去耦电容时, 50mV 电源纹波引起的杂散	50kHz 处的正弦波		-64		dBc
		100kHz 处的正弦波		-64		dBc
		500kHz 处的正弦波		-67		dBc
		1MHz 处的正弦波		-68		dBc
PSRR	抖动对电源纹波的灵敏度;	100kHz 正弦波纹波、3.3V 电源 <sup>(2)</sup>		4		fs/mV
<b>LVCMOS PSRR 特性</b>						

典型温度 = 25°C, 频率输出 = 156.25MHz, VDD = 3.3V, LVCMOS 输出电容负载 = 2.2pF (除非另有说明) (7)

参数		测试条件	最小值	典型值	最大值	单位
PSRR	输出频率为 50MHz, VDD = 2.5V/3.3V, 无电源去耦电容时, 50mV 电源纹波引起的杂散	50kHz 处的正弦波		-72		dBc
		100kHz 处的正弦波		-71		dBc
		500kHz 处的正弦波		-70		dBc
		1MHz 处的正弦波		-69		dBc
PSRR	输出频率为 50MHz, VDD = 1.8V, 无电源去耦电容时, 50mV 电源纹波引起的杂散	50kHz 处的正弦波		-50		dBc
		100kHz 处的正弦波		-50		dBc
		500kHz 处的正弦波		-52		dBc
		1MHz 处的正弦波		-55		dBc
PSRR	抖动对电源纹波的灵敏度;	100kHz 正弦波纹波、3.3V 电源 <sup>(2)</sup>		10		fs/mV
<b>上电特性</b>						
t <sub>START_UP</sub>	启动时间	从 0.95 x VDD 开始计时, 直至输出启用且输出符合规格; 在 VDD 电源斜坡时间约为 200 μs 的条件下测试			5	ms
t <sub>OE-EN</sub>	输出使能时间	从 OE = V <sub>IH</sub> 开始, 直到输出启用且输出符合规格所用的时间 (F <sub>out</sub> > 10MHz)			25	μs
t <sub>OE-DIS</sub>	输出禁用时间	从 OE = V <sub>IL</sub> 开始, 直到输出禁用所用的时间 (F <sub>out</sub> > 10MHz)			1	μs
<b>LVPECL - 时钟输出抖动</b>						
R <sub>J</sub>	RMS 抖动 (集成 BW : 12kHz 至 20MHz)	F <sub>out</sub> = 156.25MHz		100	125	fs
PN <sub>1k</sub>	1kHz 偏移时的相位噪声	F <sub>out</sub> = 156.25MHz		-95		dBc/Hz
PN <sub>10k</sub>	10kHz 偏移时的相位噪声			-127		dBc/Hz
PN <sub>100k</sub>	100kHz 偏移时的相位噪声			-146		dBc/Hz
PN <sub>1M</sub>	1MHz 偏移时的相位噪声			-156		dBc/Hz
PN <sub>10M</sub>	10MHz 偏移时的相位噪声			-158		dBc/Hz
R <sub>J</sub>	RMS 抖动 (集成 BW : 12kHz 至 20MHz)	F <sub>out</sub> = 312.5MHz		100	125	fs
PN <sub>1k</sub>	1kHz 偏移时的相位噪声	F <sub>out</sub> = 312.5MHz		-89		dBc/Hz
PN <sub>10k</sub>	10kHz 偏移时的相位噪声			-121		dBc/Hz
PN <sub>100k</sub>	100kHz 偏移时的相位噪声			-140		dBc/Hz
PN <sub>1M</sub>	1MHz 偏移时的相位噪声			-150		dBc/Hz
PN <sub>10M</sub>	10MHz 偏移时的相位噪声			-154		dBc/Hz
R <sub>J</sub>	RMS 抖动 (集成 BW : 12kHz 至 20MHz)	F <sub>out</sub> = 100MHz		125	170	fs
		F <sub>out</sub> = 125MHz		100	125	fs
		F <sub>out</sub> = 155.52MHz		100	125	fs
		F <sub>out</sub> = 161.1328125MHz		110	150	fs
		F <sub>out</sub> = 200MHz		120	150	fs
		F <sub>out</sub> = 400MHz		100	135	fs
R <sub>PeriodJITT,RMS</sub>	RMS 周期抖动	F <sub>out</sub> ≥ 25MHz		1.7		ps
R <sub>JITT,PK-PK</sub>	峰峰值周期抖动	F <sub>out</sub> ≥ 25MHz		13		ps
<b>LVDS - 时钟输出抖动</b>						
R <sub>J</sub>	RMS 抖动 (集成 BW : 12kHz 至 20MHz)	F <sub>out</sub> = 156.25MHz		100	125	fs

**LMK6C, LMK6D, LMK6H, LMK6P**

ZHCSNQ0E - APRIL 2022 - REVISED APRIL 2024

典型温度 = 25°C, 频率输出 = 156.25MHz, VDD = 3.3V, LVCMOS 输出电容负载 = 2.2pF (除非另有说明) (7)

参数		测试条件	最小值	典型值	最大值	单位
PN <sub>1k</sub>	1kHz 偏移时的相位噪声	F <sub>out</sub> = 156.25MHz		-95		dBc/Hz
PN <sub>10k</sub>	10kHz 偏移时的相位噪声			-128		dBc/Hz
PN <sub>100k</sub>	100kHz 偏移时的相位噪声			-146		dBc/Hz
PN <sub>1M</sub>	1MHz 偏移时的相位噪声			-156		dBc/Hz
PN <sub>10M</sub>	10MHz 偏移时的相位噪声			-156.5		dBc/Hz
R <sub>J</sub>	RMS 抖动 (集成 BW : 12kHz 至 20MHz)	F <sub>out</sub> = 312.5MHz		100	125	fs
PN <sub>1k</sub>	1kHz 偏移时的相位噪声	F <sub>out</sub> = 312.5MHz		-89		dBc/Hz
PN <sub>10k</sub>	10kHz 偏移时的相位噪声			-122		dBc/Hz
PN <sub>100k</sub>	100kHz 偏移时的相位噪声			-139		dBc/Hz
PN <sub>1M</sub>	1MHz 偏移时的相位噪声			-150		dBc/Hz
PN <sub>10M</sub>	10MHz 偏移时的相位噪声			-153.5		dBc/Hz
R <sub>J</sub>	RMS 抖动 (集成 BW : 12kHz 至 20MHz)	F <sub>out</sub> = 100MHz		140	170	fs
		F <sub>out</sub> = 125MHz		110	125	fs
		F <sub>out</sub> = 155.52MHz		105	140	fs
		F <sub>out</sub> = 161.1328125MHz		125	160	fs
		F <sub>out</sub> = 200MHz		125	150	fs
		F <sub>out</sub> = 400MHz		100	135	fs
R <sub>PeriodJITT,RMS</sub>	RMS 周期抖动	F <sub>out</sub> ≥ 25MHz		1.6		ps
R <sub>JITT,PK-PK</sub>	峰峰值周期抖动	F <sub>out</sub> ≥ 25MHz		13		ps
<b>HCSL - 时钟输出抖动</b>						
J <sub>PCle1-cc</sub>	PCIe 第 1 代通用时钟抖动 (抖动限制 = 86ps)	F <sub>out</sub> = 100MHz	0.146		6.4	ps
J <sub>PCle1-SRNS</sub>	PCIe 第 1 代 SRNS 抖动		0.447		6.99	ps
J <sub>PCle2-cc</sub>	PCIe 第 2 代通用时钟抖动 (抖动限制 = 3ps)		0.103		0.554	ps
J <sub>PCle2-SRNS</sub>	PCIe 第 2 代 SRNS 抖动		0.135		0.56	ps
J <sub>PCle3-cc</sub>	PCIe 第 3 代通用时钟抖动 (抖动限制 = 1ps)		0.029		0.164	ps
J <sub>PCle3-SRNS</sub>	PCIe 第 3 代 SRNS 抖动		0.033		0.180	ps
J <sub>PCle4-cc</sub>	PCIe 第 4 代通用时钟抖动 (抖动限制 = 500fs)		0.029		0.164	ps
J <sub>PCle4-SRNS</sub>	PCIe 第 4 代 SRNS 抖动		0.033		0.180	ps
J <sub>PCle5-cc</sub>	PCIe 第 5 代通用时钟抖动 (抖动限制 = 150fs)		0.007		0.070	ps
J <sub>PCle5-SRNS</sub>	PCIe 第 5 代 SRNS 抖动		0.007		0.074	ps
J <sub>PCle6-cc</sub>	PCIe 第 6 代通用时钟抖动 (抖动限制 = 100fs)		0.007		0.042	ps
J <sub>PCle6-SRNS</sub>	PCIe 第 6 代 SRNS 抖动		0.009		0.052	ps
R <sub>J</sub>	RMS 抖动 (集成 BW : 12kHz 至 20MHz)	F <sub>out</sub> = 156.25MHz		100	125	fs

典型温度 = 25°C，频率输出 = 156.25MHz，VDD = 3.3V，LVCMOS 输出电容负载 = 2.2pF (除非另有说明) (7)

参数		测试条件	最小值	典型值	最大值	单位
PN <sub>1k</sub>	1kHz 偏移时的相位噪声	F <sub>out</sub> = 156.25MHz		-95		dBc/Hz
PN <sub>10k</sub>	10kHz 偏移时的相位噪声			-127		dBc/Hz
PN <sub>100k</sub>	100kHz 偏移时的相位噪声			-146		dBc/Hz
PN <sub>1M</sub>	1MHz 偏移时的相位噪声			-156		dBc/Hz
PN <sub>10M</sub>	10MHz 偏移时的相位噪声			-158		dBc/Hz
R <sub>J</sub>	RMS 抖动 (集成 BW : 12kHz 至 20MHz)	F <sub>out</sub> = 312.5MHz		100	125	fs
PN <sub>1k</sub>	1kHz 偏移时的相位噪声	F <sub>out</sub> = 312.5MHz		-89		dBc/Hz
PN <sub>10k</sub>	10kHz 偏移时的相位噪声			-121		dBc/Hz
PN <sub>100k</sub>	100kHz 偏移时的相位噪声			-140		dBc/Hz
PN <sub>1M</sub>	1MHz 偏移时的相位噪声			-150		dBc/Hz
PN <sub>10M</sub>	10MHz 偏移时的相位噪声			-154		dBc/Hz
R <sub>J</sub>	RMS 抖动 (集成 BW : 12kHz 至 20MHz)	F <sub>out</sub> = 100MHz		125	170	fs
		F <sub>out</sub> = 125MHz		100	125	fs
		F <sub>out</sub> = 155.52MHz		100	125	fs
		F <sub>out</sub> = 161.1328125MHz		110	150	fs
		F <sub>out</sub> = 200MHz		120	150	fs
R <sub>J</sub>		F <sub>out</sub> = 400MHz		100	135	fs
R <sub>PeriodJITT,RMS</sub>	RMS 周期抖动	F <sub>out</sub> ≥ 25MHz		1.7		ps
R <sub>JITT,PK-PK</sub>	峰峰值周期抖动	F <sub>out</sub> ≥ 25MHz		13		ps
<b>LVCMOS - 时钟输出抖动</b>						
R <sub>J</sub>	RMS 抖动 (集成 BW : 12kHz 至 20MHz)	F <sub>out</sub> = 156.25MHz		0.25	0.5	ps
PN <sub>1k</sub>	1kHz 偏移时的相位噪声	F <sub>out</sub> = 156.25MHz		-100		dBc/Hz
PN <sub>10k</sub>	10kHz 偏移时的相位噪声			-128		dBc/Hz
PN <sub>100k</sub>	100kHz 偏移时的相位噪声			-143		dBc/Hz
PN <sub>1M</sub>	1MHz 偏移时的相位噪声			-150		dBc/Hz
PN <sub>10M</sub>	10MHz 偏移时的相位噪声			-152		dBc/Hz
R <sub>J</sub>	RMS 抖动 (集成 BW : 12kHz 至 5MHz)	F <sub>out</sub> = 24MHz		0.25	0.5	ps
		F <sub>out</sub> = 25MHz		0.25	0.5	ps
		F <sub>out</sub> = 33.33MHz		0.25	1	ps
	RMS 抖动 (集成 BW : 12kHz 至 20MHz)	F <sub>out</sub> = 40MHz		0.5	1	ps
		F <sub>out</sub> = 50MHz		0.4	1	ps
		F <sub>out</sub> = 66.66MHz		0.5	1	ps
		F <sub>out</sub> = 74.25MHz		0.3	0.5	ps
		F <sub>out</sub> = 78MHz		0.35	0.5	ps
		F <sub>out</sub> = 100MHz		0.35	0.5	ps
		F <sub>out</sub> = 125MHz		0.35	0.5	ps
R <sub>PeriodJITT,RMS</sub>	RMS 周期抖动	F <sub>out</sub> ≥ 25MHz		1.5		ps
R <sub>JITT,PK-PK</sub>	峰峰值周期抖动	F <sub>out</sub> ≥ 25MHz		13		ps

- (1) 直流负载条件  
(2) 使用 TI LMK6x 评估模块测得

- (3) 请参阅应用曲线部分，了解不同电容负载值下上升时间和下降时间的详细信息。
- (4) 抖动规格与设计 and 特性相关

### 6.8 时序图



图 6-1. 差分输出电压和上升/下降时间



图 6-2. 单端输出电压和上升/下降时间

### 6.9 典型特性

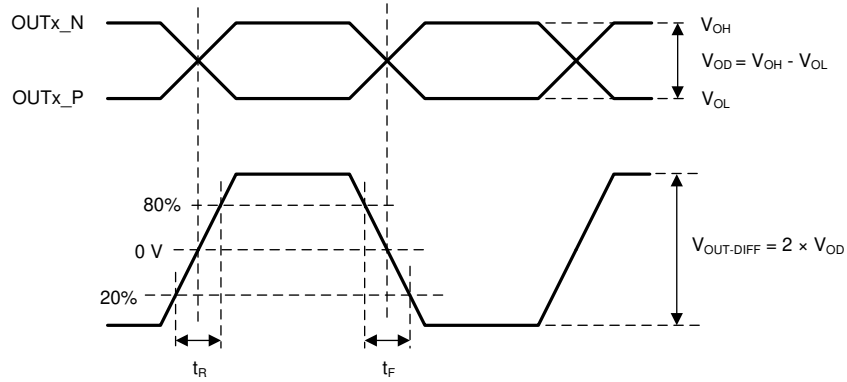

图 6-3. 电流消耗与频率间的关系 (LVC MOS、1.8V)

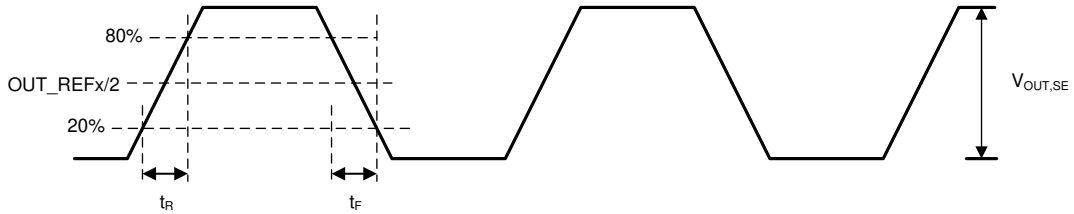

图 6-4. 电流消耗与频率间的关系 (LVC MOS、2.5V)

6.9 典型特性 (续)

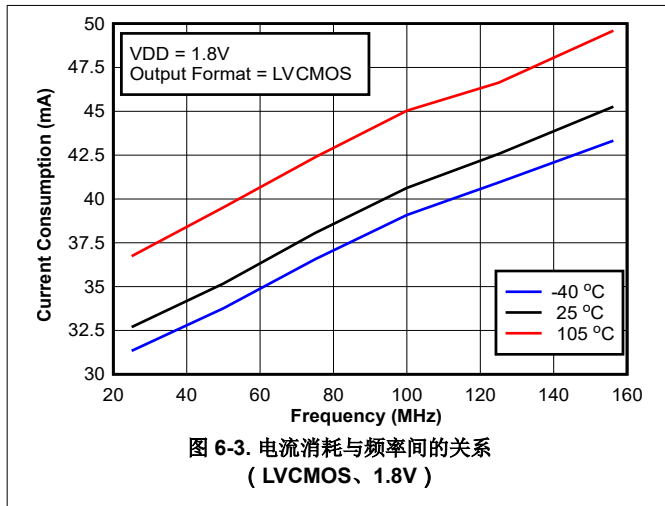

图 6-5. 电流消耗与频率间的关系 (LVC MOS、3.3V)

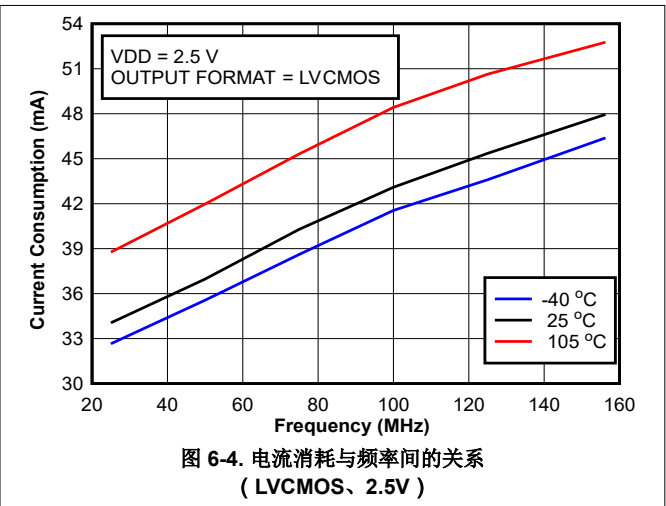

图 6-6. 电流消耗与频率间的关系 (HCSL、1.8V)

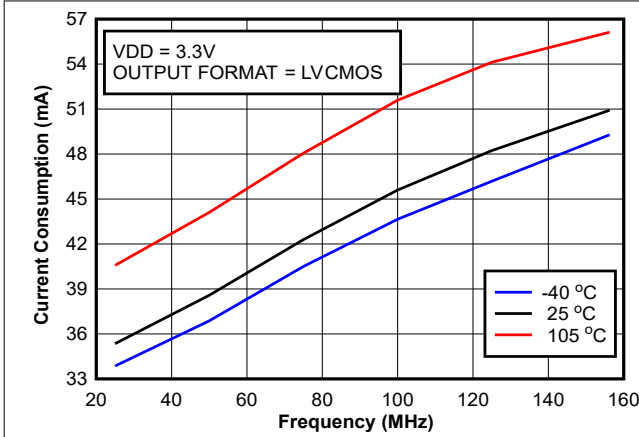

图 6-7. 电流消耗与频率间的关系 (HCSL、2.5V)

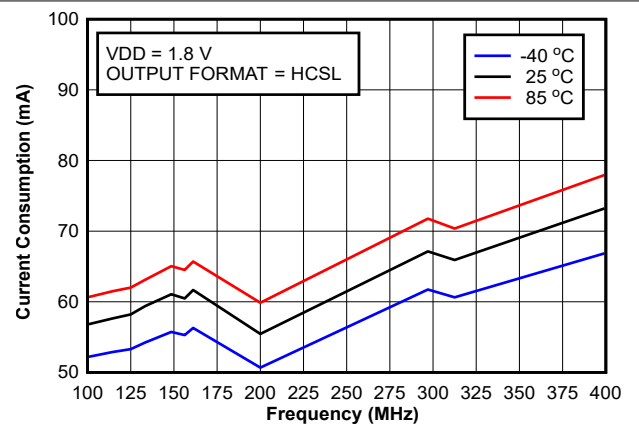

图 6-8. 电流消耗与频率间的关系 (HCSL、3.3V)

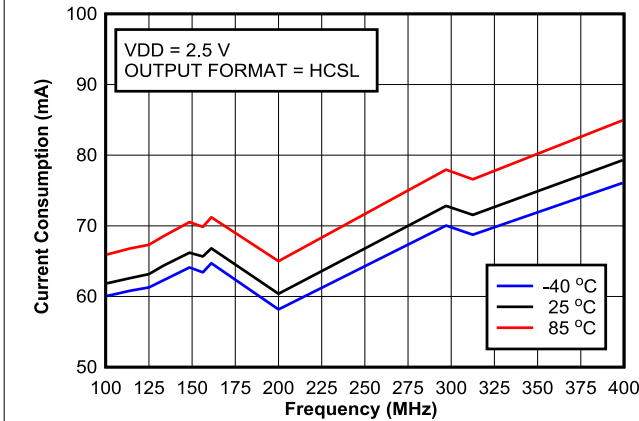

图 6-9. 电流消耗与频率间的关系 (LVPECL、1.8V)

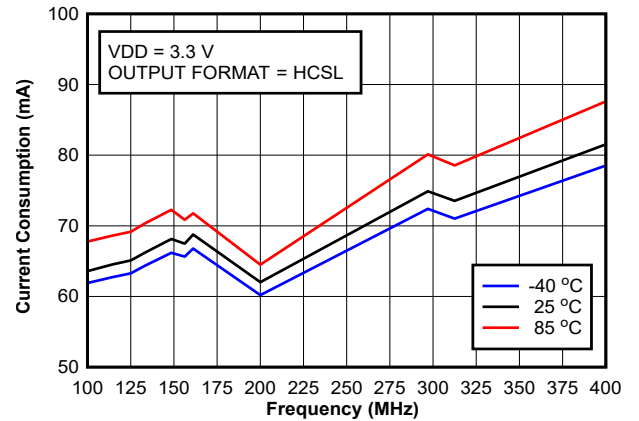

图 6-10. 电流消耗与频率间的关系 (LVPECL、2.5V)

## 6.9 典型特性 (续)

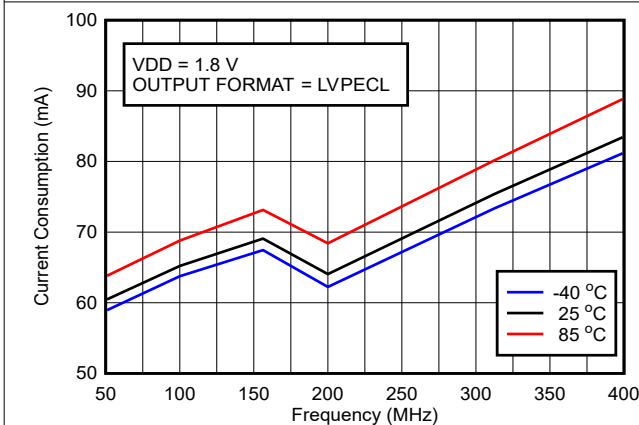

图 6-11. 电流消耗与频率间的关系  
(LVPECL、3.3V)

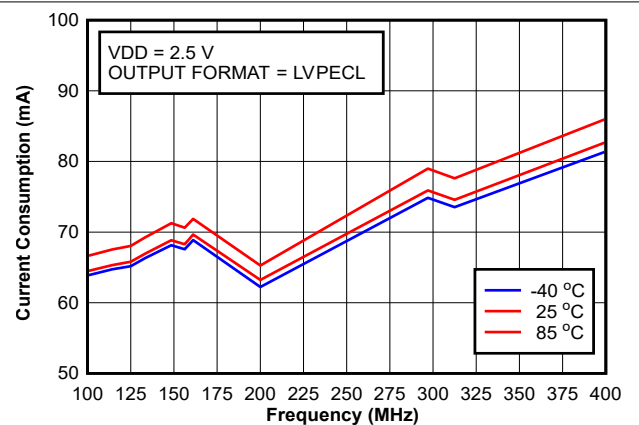

图 6-12. 电流消耗与频率间的关系  
(LVDS、1.8V)

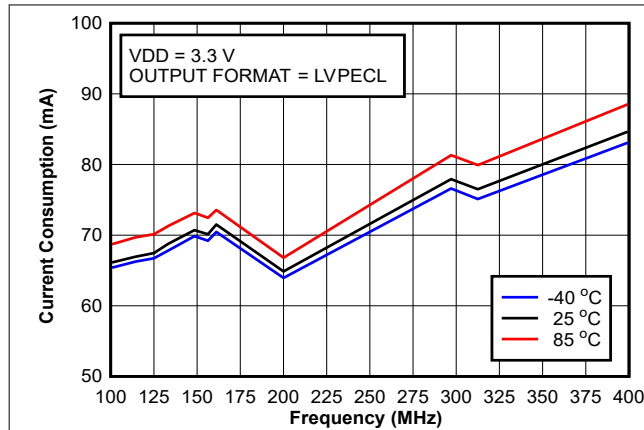

图 6-13. 电流消耗与频率间的关系  
(LVDS、2.5V)

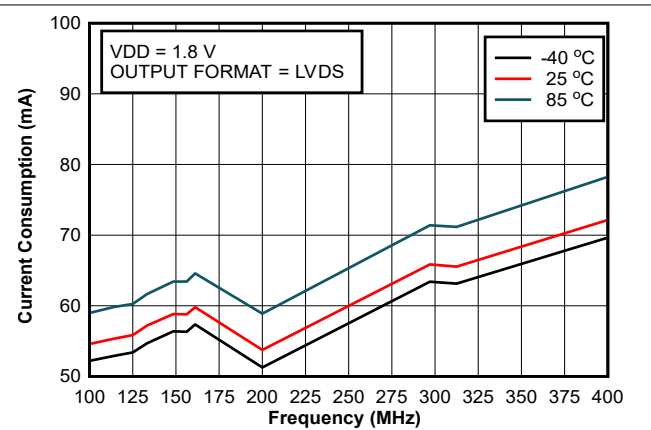

图 6-14. 电流消耗与频率间的关系  
(LVDS、3.3V)

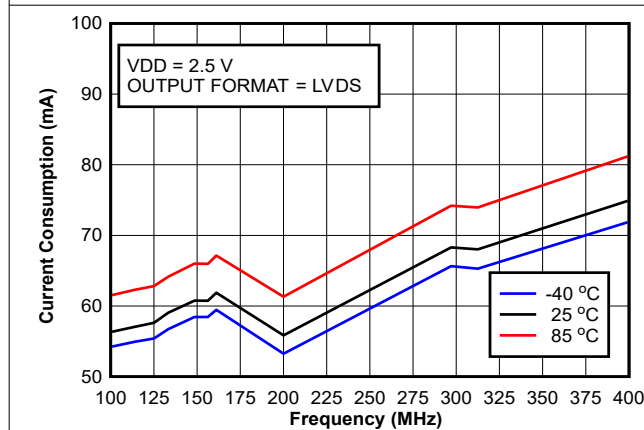

图 6-15. LVPECL、HCSL 的 RMS 抖动与频率 (100MHz 至 200MHz) 间的关系；典型值 3.3V、25°C

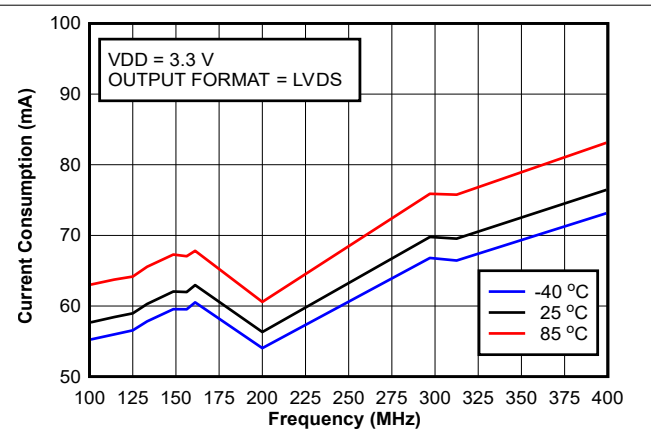

图 6-16. LVDS 的 RMS 抖动与频率 (100MHz 至 200MHz) 间的关系；典型值 3.3V、25°C

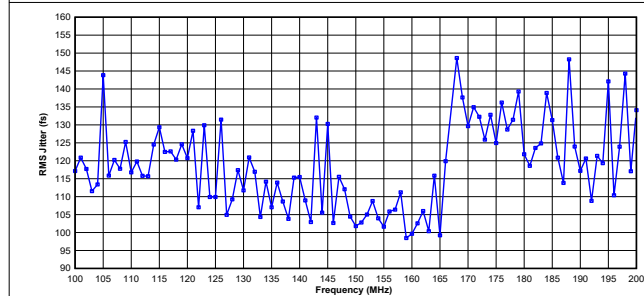

## 6.9 典型特性 (续)

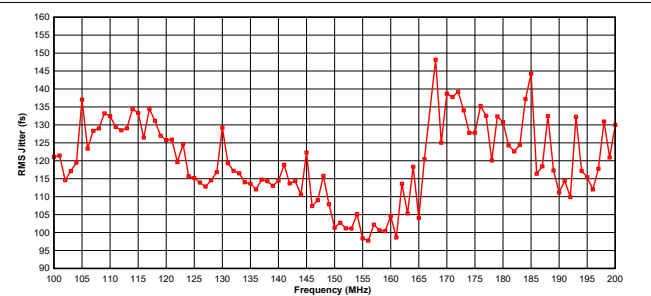

图 6-17. LVPECL、HCSL 的 RMS 抖动与频率 (200MHz 至 300MHz) 间的关系；典型值 3.3V、25°C



图 6-18. LVDS 的 RMS 抖动与频率 (200MHz 至 300MHz) 间的关系；典型值 3.3V、25°C

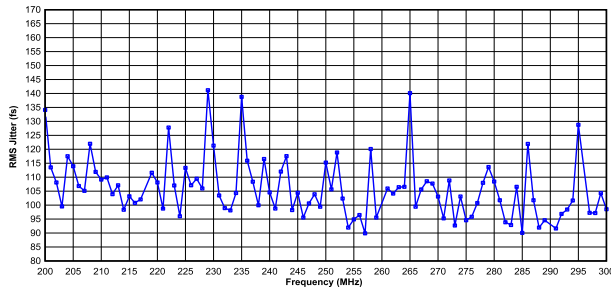

图 6-19. LVPECL、HCSL 的 RMS 抖动与频率 (300MHz 至 400MHz) 间的关系；典型值 3.3V、25°C

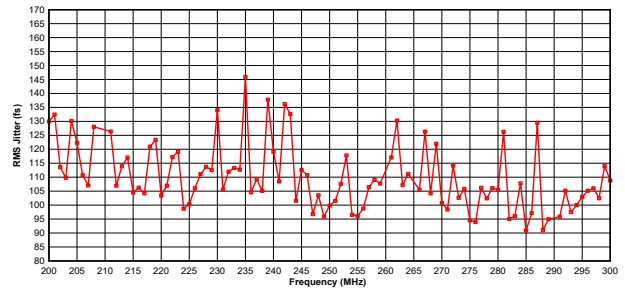

图 6-20. LVDS 的 RMS 抖动与频率 (300MHz 至 400MHz) 间的关系；典型值 3.3V、25°C

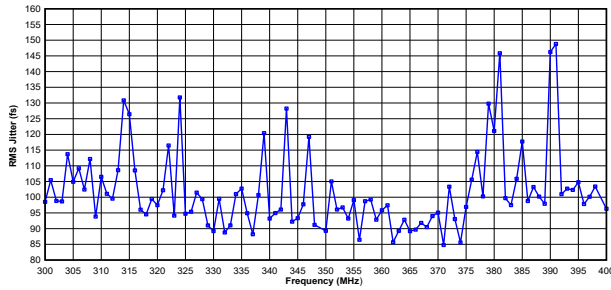

图 6-21. LVPECL、HCSL 的 RMS 抖动与频率 (低于 100MHz) 间的关系；典型值 3.3V、25°C

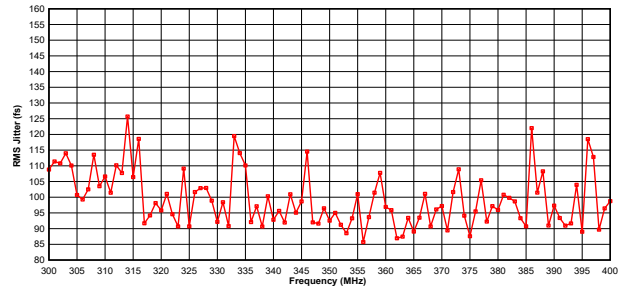

图 6-22. LVDS 的 RMS 抖动与频率 (低于 100MHz) 间的关系；典型值 3.3V、25°C

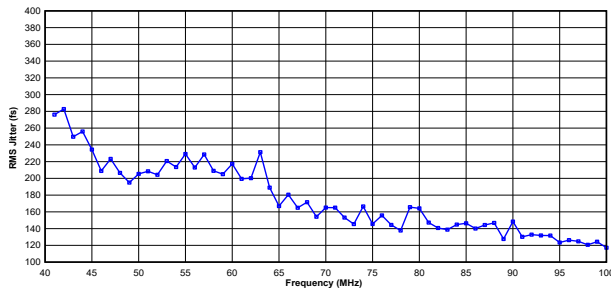

图 6-23. LVCMOS 的 RMS 抖动与频率 (100MHz 至 200MHz) 间的关系；典型值 3.3V、25°C

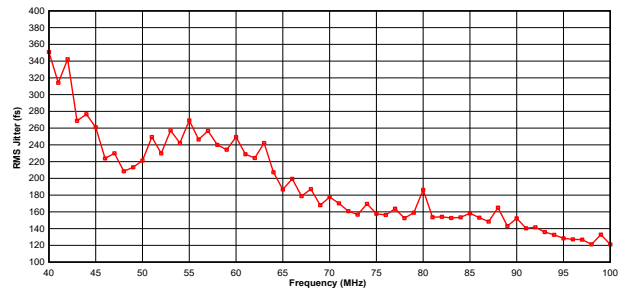

图 6-24. LVCMOS 的 RMS 抖动与频率 (10MHz 至 100MHz) 间的关系；典型值 3.3V、25°C

## 6.9 典型特性 (续)

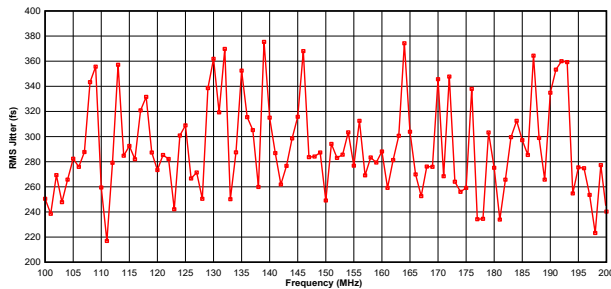

图 6-25. 占空比 (%) 与频率和电源电压间的关系；25°C

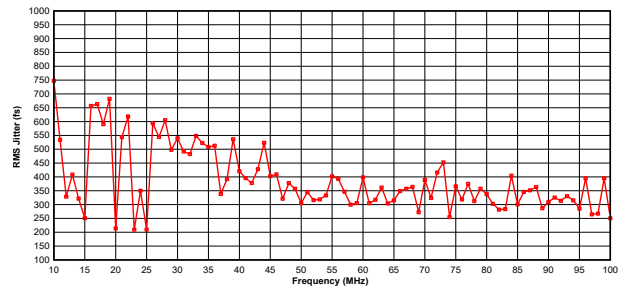

图 6-26. 占空比 (%) 与温度和电源间的关系；频率 50MHz

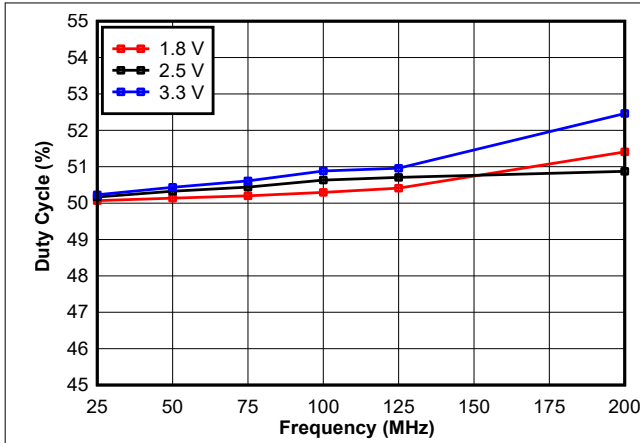

图 6-27. LVCMOS 在全温度范围内的占空比 (%) 与频率间的关系；3.3V

## 7 参数测量信息

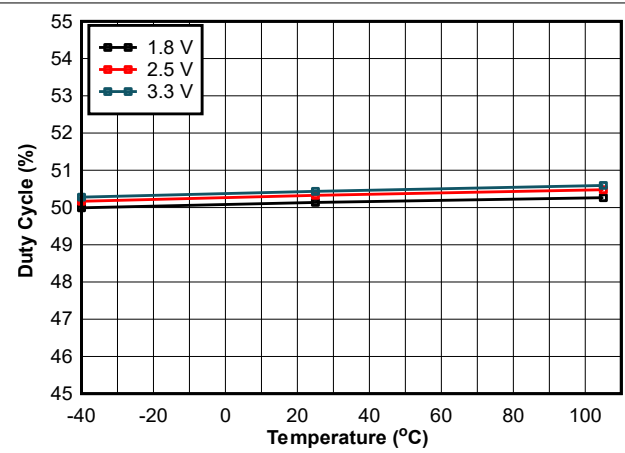
### 7.1 器件输出配置

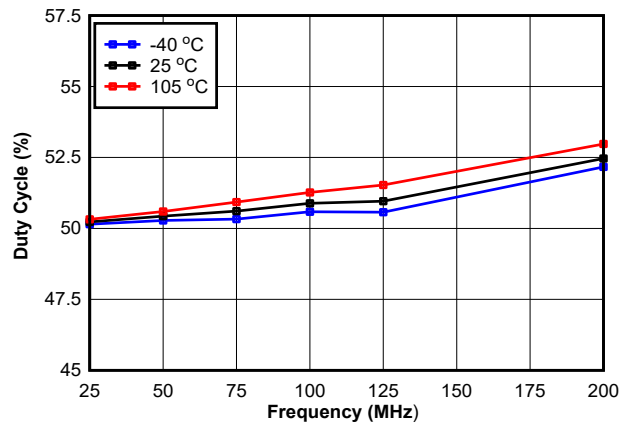

图 7-1. LMK6C 输出测试配置



图 7-2. LMK6C 输出相位噪声测试配置

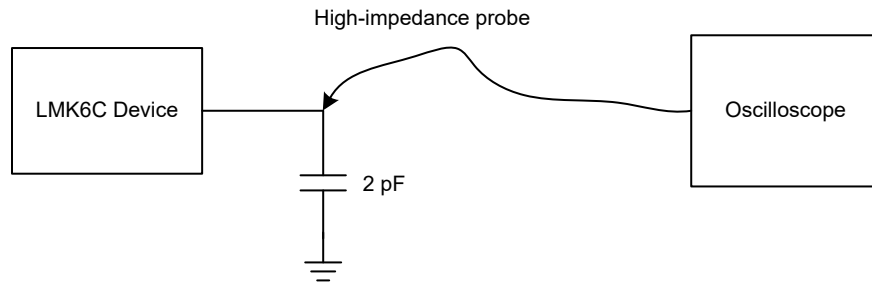

图 7-3. LMK6D 输出测试配置

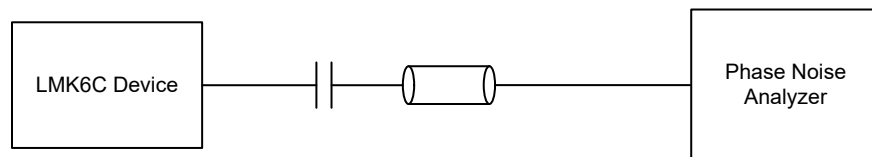

图 7-4. LMK6D 输出相位噪声测试配置

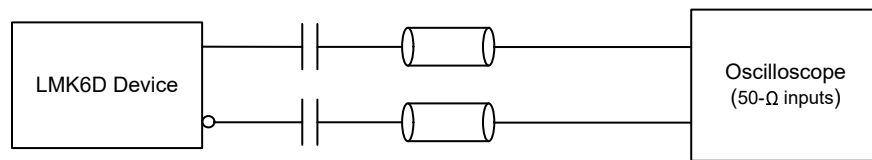

图 7-5. LMK6P 输出测试配置

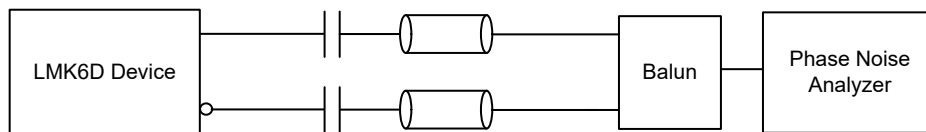

图 7-6. LMK6P 输出相位噪声测试配置

表 7-1. LMK6P 输出测试配置和相位噪声配置 Rp 值

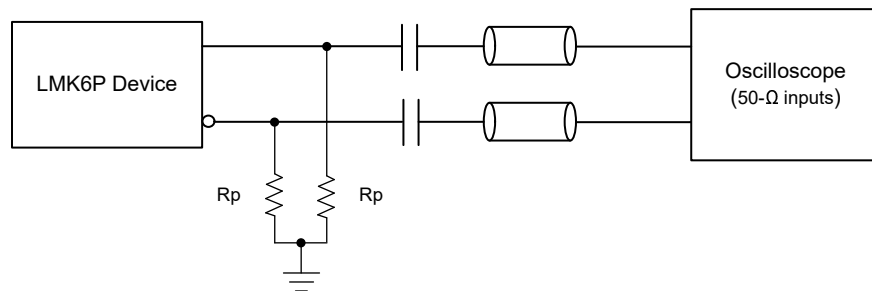
电源电压 (V)	Rp ( $\Omega$ )
3.3	207.5
2.5	112.5
1.8	83.3

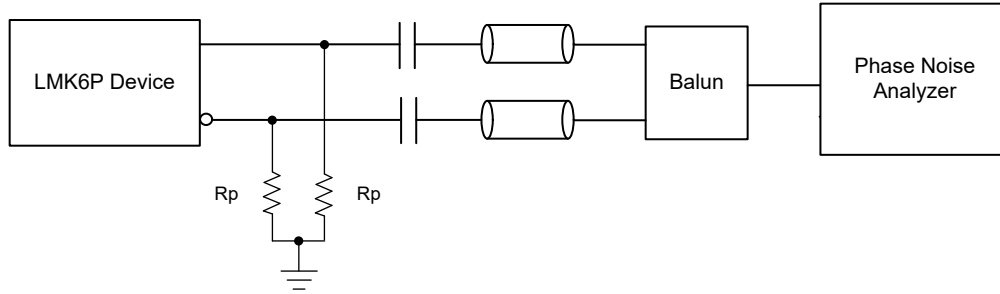

图 7-7. LMK6H 输出测试配置



图 7-8. LMK6H 输出相位噪声测试配置

## 8 详细说明

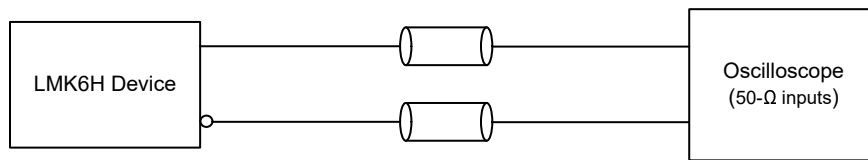
### 8.1 概述

LMK6x 是一款基于 BAW 的固定频率振荡器，可为差分 and 单端输出类型提供超低抖动。

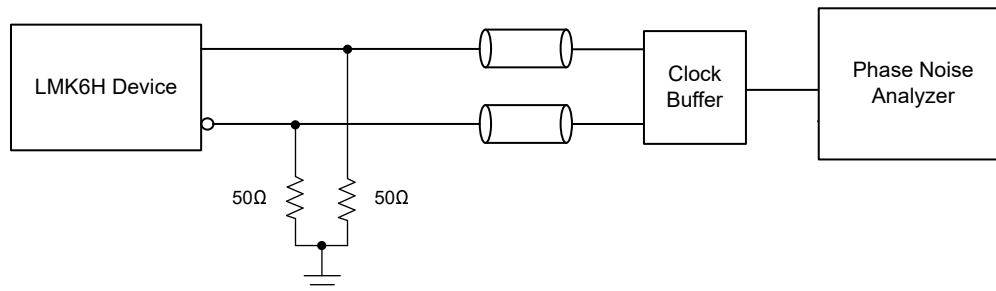
### 8.2 功能方框图

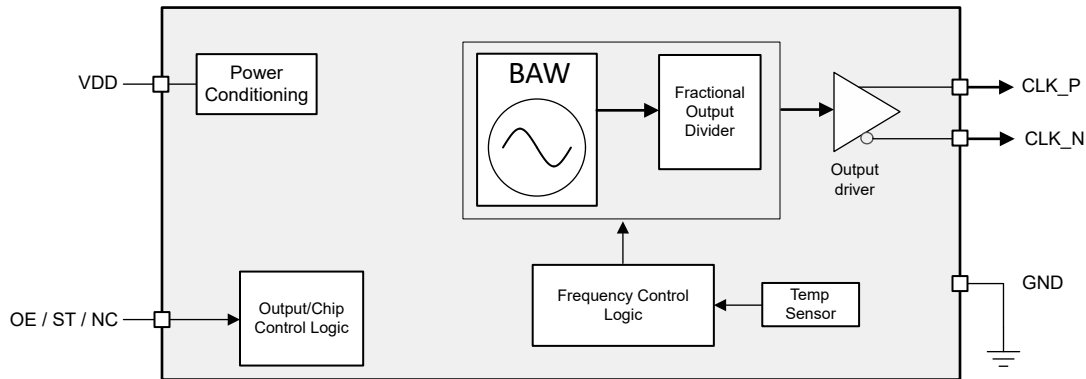

### 8.3 特性说明

#### 8.3.1 体声波 (BAW)

TI BAW 谐振器技术可利用压电式转换在 2.5GHz 频率下产生高 Q 值谐振。谐振器是一个由顶部和底部电极覆盖的四边形区域。交替的高、低噪声阻抗层会在谐振体下方形成声镜，防止声能泄漏到基板中。此外，这些声镜还放置在谐振器堆叠的顶部，保护器件免受污染，并更大限度地减少泄漏到封装材料中的能量。这款独特的双布拉格声波谐振器 (DBAR) 可实现高效激励，无需在其周围制造成本高昂的真空腔。因此，TI BAW 谐振器不受由表面吸附污染物导致的频率变化的影响，而且可以直接放置在小型标准尺寸振荡器 IC 的非密封塑料封装中。有关 BAW 技术的更多详细信息，请参阅 [BAW](#)。

#### 8.3.2 器件块级描述

该器件包含 BAW 谐振器、分数输出分频器 (FOD) 和输出驱动器，它们共同生成预编程的输出频率。内部的精密温度传感器持续监测振荡频率随温度的变化，然后将其输入到频率控制逻辑块。此频率控制逻辑块可在内部执行频率校准，以便在整个温度范围内和老化过程中将输出频率保持在  $\pm 25\text{ppm}$  以内。输出驱动器能够提供单端 LVCMOS 和差分 LVPECL、LVDS 和 HCSL 输出格式。该器件还包含可降低电源噪声的内部 LDO，从而实现低噪声时钟输出。

#### 8.3.3 功能引脚

LMK6C 上的引脚 1 以及 LMK6P、LMK6D 和 LMK6H 上的引脚 1 或引脚 2 是功能引脚，根据可订购器件型号，这些引脚具有多种功能。该功能可用作输出使能 (OE)、待机 (ST) 或无连接 (NC)。OE 和 ST 均提供高电平有效和低电平有效选项。请联系 TI 以获得低电平有效选项。表 8-1 列出了差分输出 6 引脚封装的引脚 1 和引脚 2 的功能，表 8-2 列出了单端输出的引脚 1 的功能。

表 8-1. 6 引脚封装 ( LMK6D、LMK6H、LMK6P ) 的功能引脚说明

可订购选项	引脚说明	输出功能	其他功能引脚配置
E ( 引脚 1 )	输出使能 ( 高电平有效/NC )。	<b>高电平或无连接</b> ：在指定频率下输出有效 <b>低电平</b> ：输出禁用、高阻抗；电流消耗由 $I_{DD-PD}$ 决定	引脚 2 可以保持悬空或接地
F ( 引脚 2 )	输出使能 ( 高电平有效/NC )。	<b>高电平或无连接</b> ：在指定频率下输出有效 <b>低电平</b> ：输出禁用、高阻抗；电流消耗由 $I_{DD-PD}$ 决定	引脚 1 可以保持悬空或接地

表 8-1. 6 引脚封装 ( LMK6D、LMK6H、LMK6P ) 的功能引脚说明 ( 续 )

可订购选项	引脚说明	输出功能	其他功能引脚配置
A ( 引脚 1 )	待机 ( 低电平有效 )	<b>低电平</b> ：高阻抗；待机模式；电流消耗由待机电流 $I_{DD-STBY}$ 决定 <b>高电平或无连接</b> ：在指定频率下输出有效	引脚 2 可以保持开路或接地
B ( 引脚 2 )	待机 ( 低电平有效 )	<b>低电平</b> ：高阻抗；待机模式；电流消耗由待机电流 $I_{DD-STBY}$ 决定 <b>高电平或无连接</b> ：在指定频率下输出有效	引脚 1 可以保持开路或接地

表 8-2. 4 引脚封装 ( LMK6C ) 的功能引脚说明

可订购选项	引脚说明	输出功能
E ( 引脚 1 )	输出使能 ( 高电平有效/NC )。	<b>高电平或无连接</b> ：在指定频率下输出有效 <b>低电平</b> ：输出禁用、高阻抗；电流消耗由 $I_{DD-PD}$ 决定
A ( 引脚 1 )	待机 ( 低电平有效 )	<b>低电平</b> ：高阻抗；待机模式；电流消耗由待机电流 $I_{DD-STBY}$ 决定 <b>高电平或无连接</b> ：在指定频率下输出有效

在待机模式下，所有模块均断电，以最大程度节省电流消耗，相当于 [电气特性](#) 表中 [电流消耗特性](#) 部分给出的待机电流。返回到输出时钟有效时间与初始启动时间相同。

功能引脚内部驱动电阻大于 100k $\Omega$ 。

### 8.3.4 时钟输出连接和端接

这些图展示了建议的输出连接和端接电路。



图 8-1. LMK6C 输出至 LVCMOS 接收器



图 8-2. LMK6D 输出直流耦合至带内部端接/偏置的 LVDS 接收器

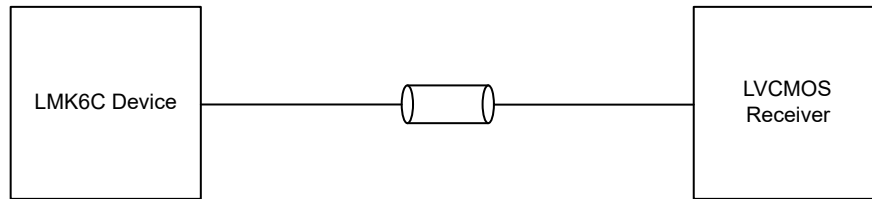

图 8-3. LMK6D 输出交流耦合至带内部端接/偏置的 LVDS 接收器

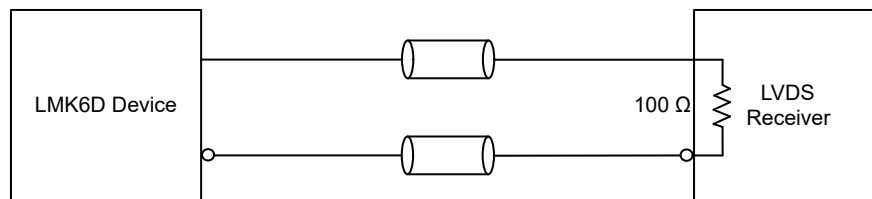

图 8-4. LMK6P 输出直流耦合至带外部端接/偏置的 LVPECL 接收器 (T 型网络)

表 8-3. LMK6P T 型网络直流耦合电阻值

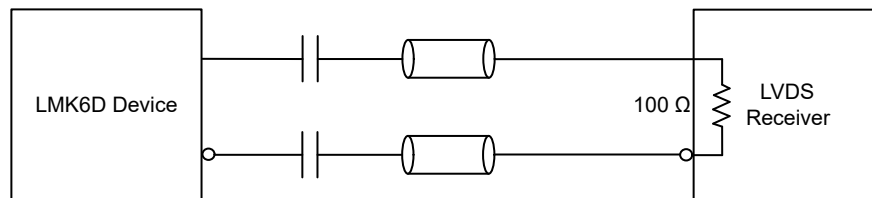
电源电压 (V)	R1 ( $\Omega$ )	R2 ( $\Omega$ )
3.3	133	82
2.5	250	62.5
1.8	450	56.5

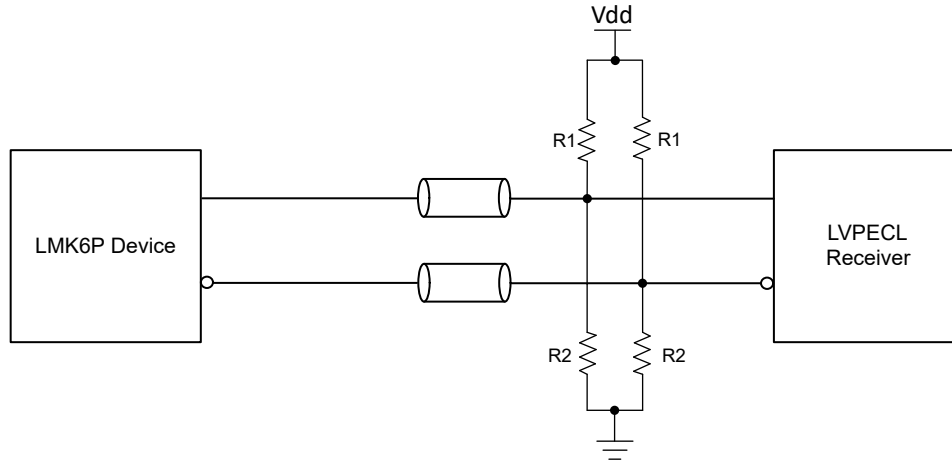

图 8-5. LMK6P 输出交流耦合至带外部端接/偏置的 LVPECL 接收器 (T 型网络)

表 8-4. LMK6P T 型网络交流耦合电阻值

电源电压 (V)	Rp ( $\Omega$ )	R1 ( $\Omega$ )	R2 ( $\Omega$ )
3.3	207.5	133	82
2.5	112.5	250	62.5
1.8	83.3	450	56.6

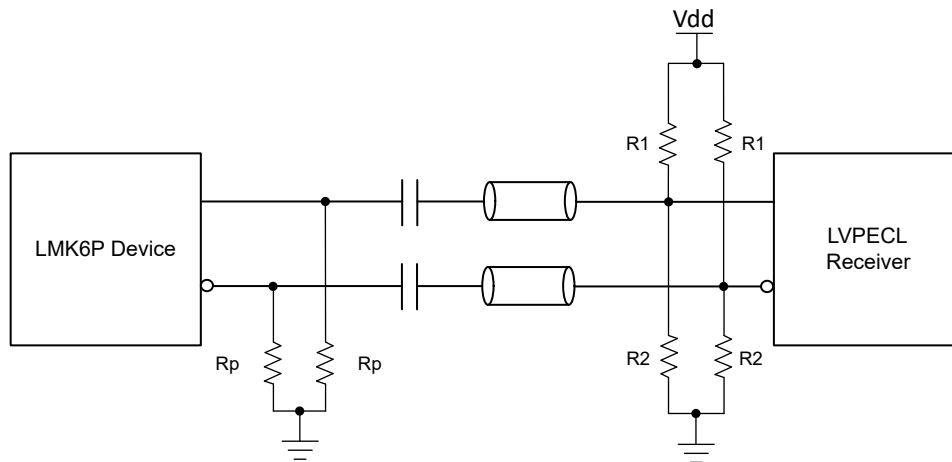

图 8-6. LMK6P 输出直流耦合至带外部端接/偏置的 LVPECL 接收器 (Y 型网络)

表 8-5. LMK6P Y 型网络直流耦合电阻值

电源电压 (V)	R1 ( $\Omega$ )	R2 ( $\Omega$ )
3.3	50	78.8
2.5	50	31.3
1.8	50	16.7

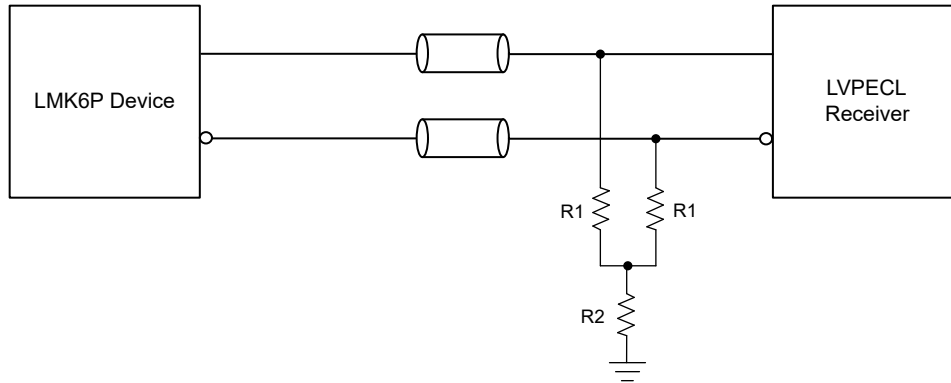

图 8-7. LMK6P 输出交流耦合至带外部端接/偏置的 LVPECL 接收器 (Y 型网络)

表 8-6. LMK6P Y 型网络交流耦合电阻值

电源电压 (V)	Rp ( $\Omega$ )	R1 ( $\Omega$ )	R2 ( $\Omega$ )
3.3	207.5	50	78.8
2.5	112.5	50	31.3
1.8	83.3	50	16.7



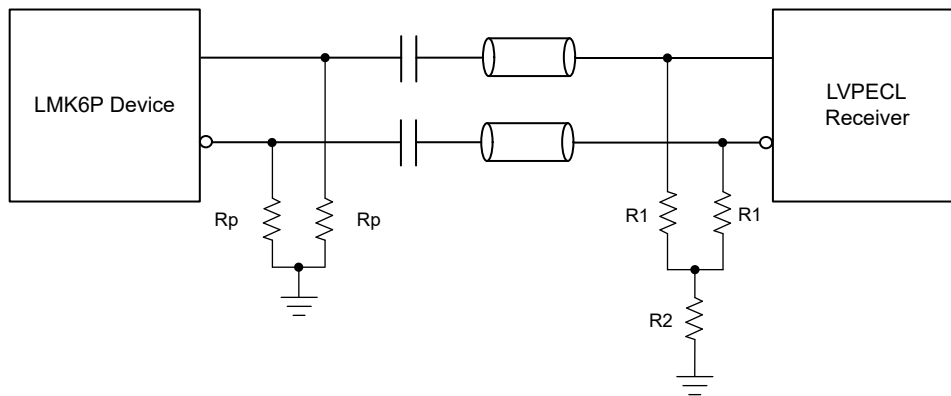

图 8-8. LMK6H 输出至带外部端接的 HCSSL 接收器



图 8-9. LMK6H 输出交流耦合至带外部端接的 HCSSL 接收器

### 8.3.5 温度稳定性

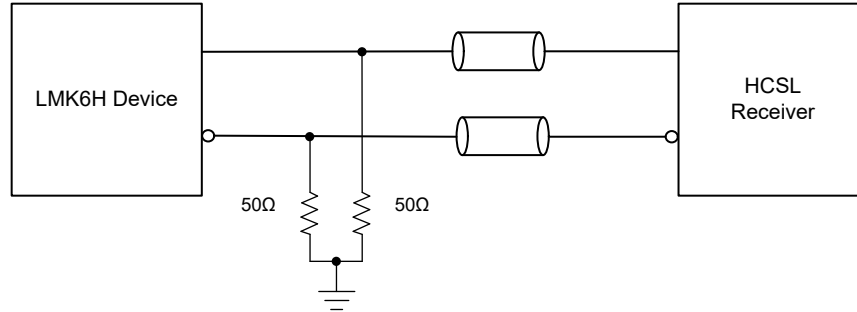
图 8-10 显示了 LMK6x 差分输出振荡器在  $-40^{\circ}\text{C}$  至  $85^{\circ}\text{C}$  温度范围内总共 60 个器件的频率变化。图 8-11 显示了 LMK6C 单端输出振荡器在  $-40^{\circ}\text{C}$  至  $105^{\circ}\text{C}$  工作温度范围内的频率变化。这些图展示了器件的典型温度稳定性，同时保持在  $\pm 10\text{ppm}$  以下。按照标准焊接曲线将器件焊接到评估板上，并进行频率变化测量。这些测试的输出频率为  $156.25\text{MHz}$ 。

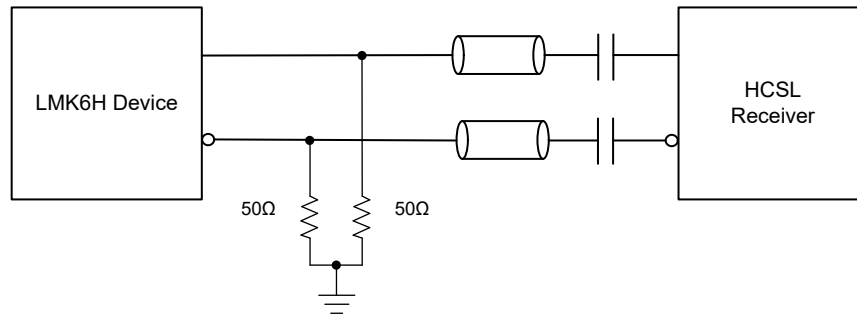

图 8-10. 频率随温度的变化 ( LMK6x 差分输出器件 )



图 8-11. 频率随温度的变化 ( LMK6C 单端输出器件 )

### 8.3.6 机械稳健性

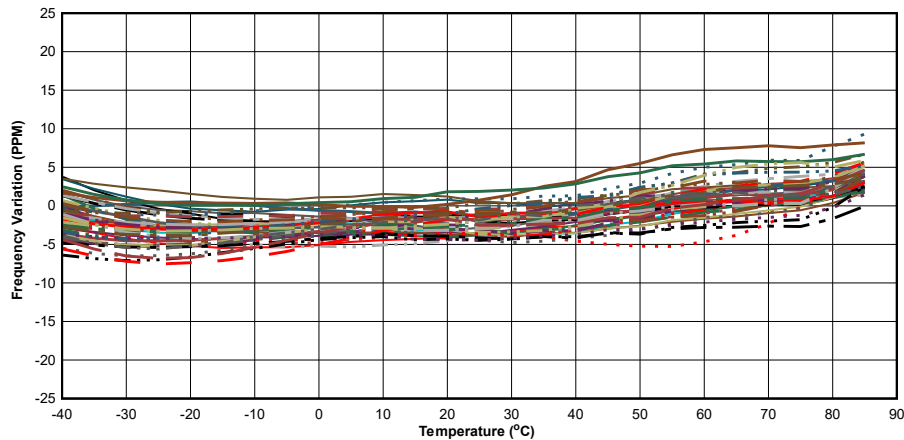
对于参考振荡器，振动和冲击是导致相位噪声和抖动增加、移频和尖峰甚至谐振器及其封装物理损坏的常见原因。与石英晶体振荡器相比，BAW 谐振器的数量级更小、质量更轻、频率更高，因此具有更强的抗振性和抗冲击性。

图 8-12 显示了 LMK6x BAW 振荡器的振动性能。在该测试中，安装在 EVM 上的 LMK6x 振荡器受到 10g 的加速度力，X、Y 和 Z 轴的频率范围为 50Hz 至 2kHz。使用 Keysight® E5052B 捕获因振动而产生的杂散相位噪声轨迹，并根据杂散功率计算出频率偏差。然后，根据载波频率将频率偏差转换为 ppb，并统一为 ppb/g。最后，将沿所有三个轴的 ppb/g RMS 总和以 ppb/g 为单位报告为振动灵敏度。LMK6x 在振动下的性能约为 2ppb/g，而大多数石英振荡器的最佳性能为 3ppb/g，更差的可能超过 10ppb/g。

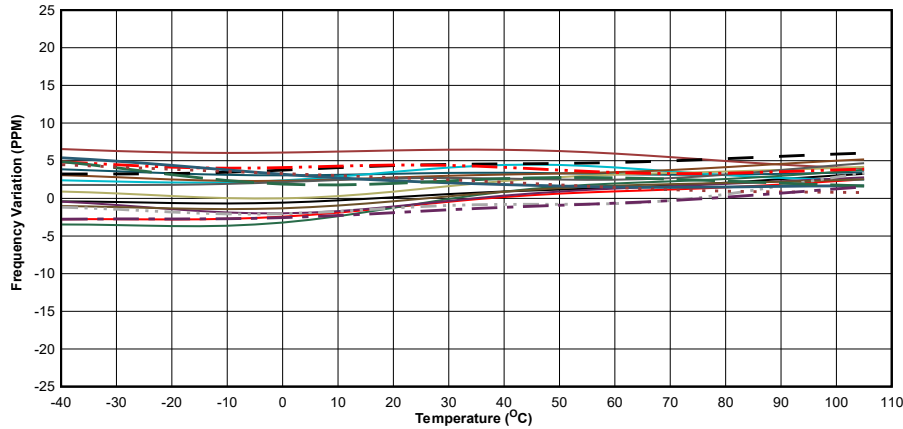

图 8-12. LMK6X BAW 振荡器的振动性能

## 8.4 器件功能模式

LMK6x BAW 振荡器是固定输出频率器件，无需任何编程。器件引脚 1 ( 以及 6 引脚器件的引脚 2 ) 具有不同的功能。有关功能引脚的更多信息，请参阅 [功能引脚](#) 部分。

## 9 应用和实施

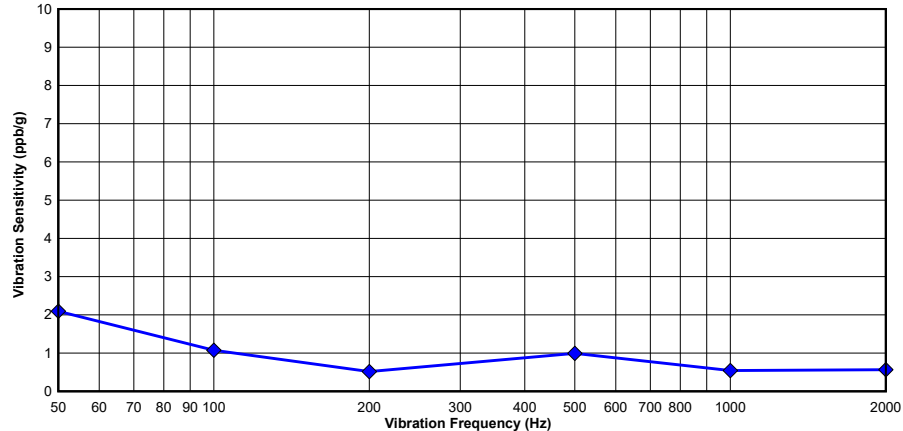
### 备注

以下应用部分中的信息不属于 TI 元件规格，TI 不担保其准确性和完整性。TI 的客户负责确定元件是否适合其用途，以及验证和测试其设计实现以确认系统功能。

## 9.1 应用信息

LMK6x 是可用作基准时钟的高性能固定频率振荡器。对于差分 LMK6D、LMK6H、LMK6P，该产品系列支持 1MHz 至 400MHz 的输出频率；对于单端 LVCMOS 时钟输出类型，则支持 1MHz 至 200MHz 的输出频率；另外还支持 1.8V 或 2.5V 至 3.3V 电源轨。

## 9.2 典型应用

有关 LMK6x 系列振荡器的参考原理图实施，请参阅 [LMK6EVM 用户指南](#)，了解旁路电容器和交流耦合电容器值建议。有关所需的输出时钟端接和偏置，请参阅 [时钟输出连接和端接](#) 部分。

图 9-1 显示了典型应用示例。在此示例中，LMK6D 差分振荡器用作 LVDS 缓冲器输入的输入。



图 9-1. 应用示例

### 9.2.1 设计要求

LMK6x 是一款无需编程的固定频率振荡器。确保严格遵循 [时钟输出连接和端接](#) 部分所述的建议端接选项。请参阅 [功能引脚](#) 部分，了解引脚 1 和引脚 2 的功能，并根据输出使能 (OE)、待机 (ST) 选项的要求订购器件型号。

### 9.2.2 详细设计过程

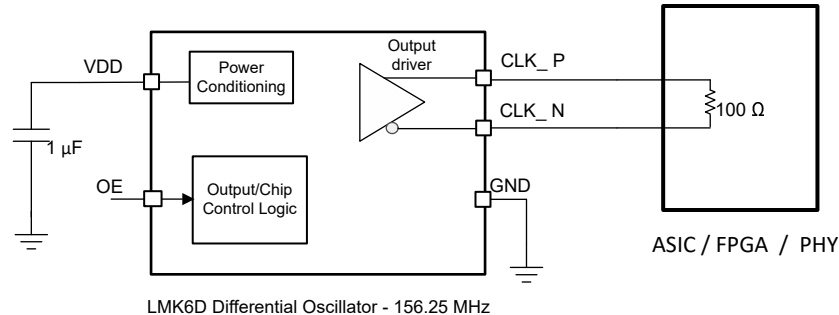
LMK6x 具有三种不同的差分输出选项：LVDS、LVPECL、HCSL，以及一种 LVCMOS 单端输出类型。在实际系统中设计振荡器输出类型时，应根据应用要求使用适当的交流或直流端接。有关所有交流和直流端接方案的详细信息，请参阅 [时钟输出连接和端接](#) 部分，并使用适当的选项。本节中的图表提供了带有端接电阻值的所有交流和直流耦合选项。LMK6x 具有集成式 LDO 和出色的 PSRR 性能，如 [电气特性](#) 所示。在设计 LMK6x BAW 振荡器时，请参考 LMK6EVM 的参考布局建议。

对于 LMK6C 的功能引脚 1，将典型的 10k $\Omega$  或更小的电阻连接到 VDD，以将 OE 引脚驱动为高电平。请注意，如果不希望使用上拉电阻，该引脚可以保持开路，因为该器件具有一个大于 100k $\Omega$  的内部上拉电阻。要将 OE 引脚驱动至低电平时，使用典型的 10k $\Omega$  或更小的电阻作为下拉电阻。对于 LMK6D、LMK6H、LMK6P 的功能引脚 1 或功能引脚 2，可以使用与 LMK6C 类似的方法。

### 9.2.3 应用曲线

LMK6C LVCMOS 输出根据系统中的实际用例连接到不同的负载电容。由于负载电容不同，特定输出频率的上升时间/下降时间也不同。以下各图显示了 -40 $^{\circ}$ C 至 105 $^{\circ}$ C 温度范围内负载电容为 2.2pF、4.7pF、10pF、15pF 和 22pF 时的上升/下降时间。



图 9-2. 输出频率为 25MHz、电源电压为 3.3V 时的上升/下降时间 (ps) 与温度间的关系



图 9-3. 输出频率为 50MHz、电源电压为 3.3V 时的上升/下降时间 (ps) 与温度间的关系

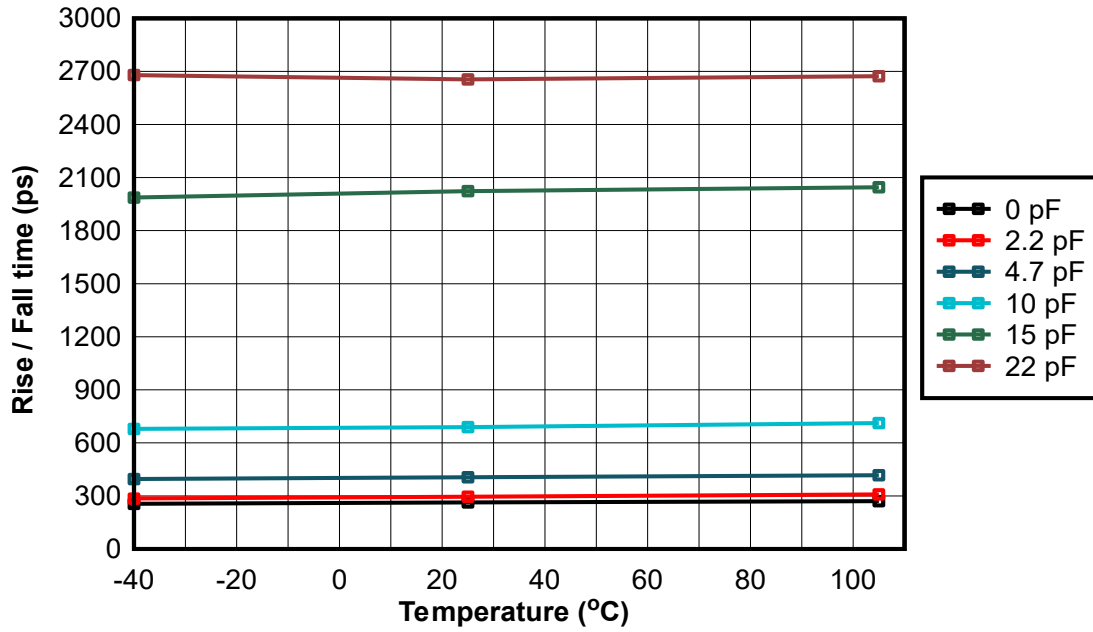

图 9-4. 输出频率为 100MHz、电源电压为 3.3V 时的上升/下降时间 (ps) 与温度间的关系

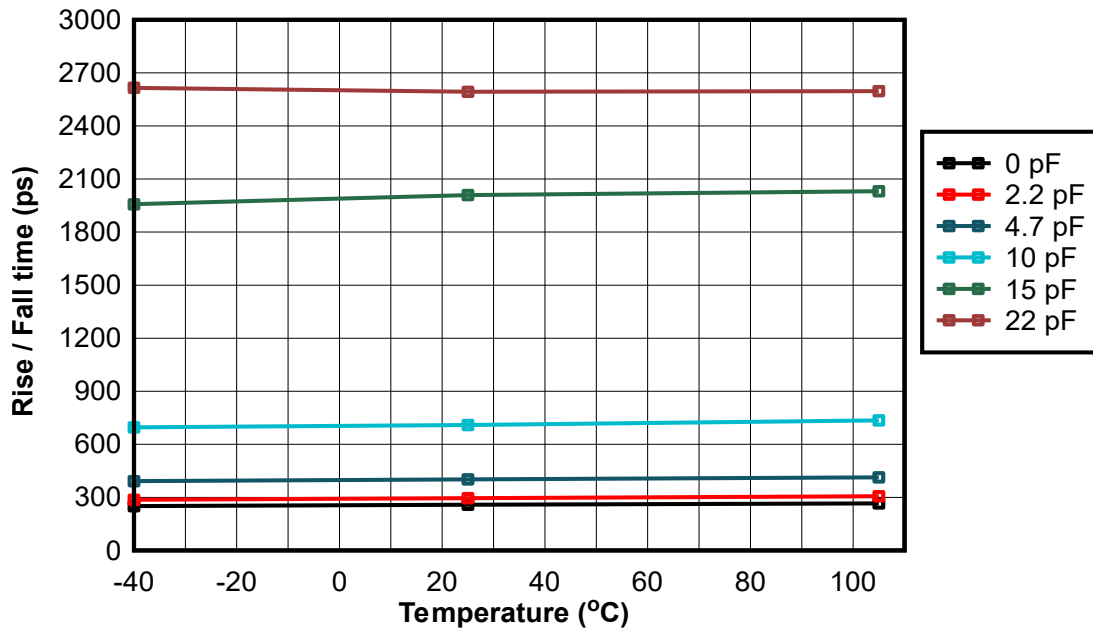

图 9-5. 输出频率为 200MHz、电源电压为 3.3V 时的上升/下降时间 (ps) 与温度间的关系

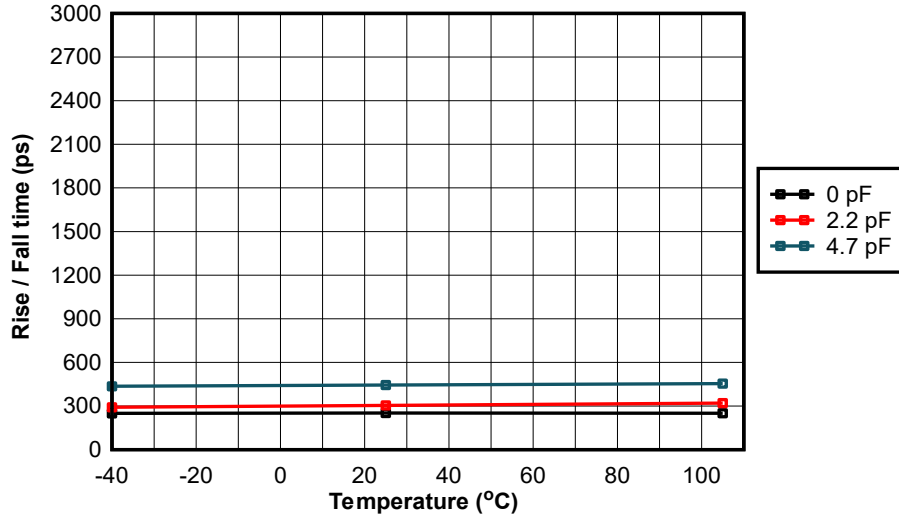

图 9-6. 上升/下降时间 (ps) 与电源电压和负载电容间的关系

### 9.3 电源相关建议

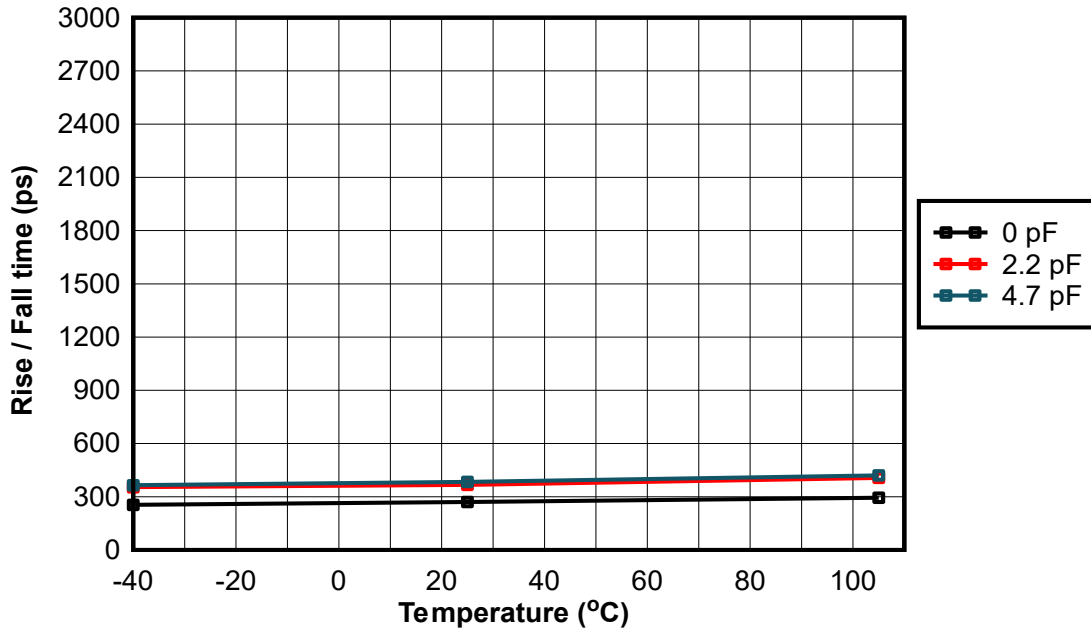
为实现 LMK6x 的最佳电气性能，TI 建议在器件电源旁路网络上使用 1μF 电容器。TI 还建议使用元件侧安装电源旁路电容器，最好使用 0201 或 0402 封装尺寸电容器，以简化信号布线。使旁路电容器与器件电源之间的连接尽可能短。使用与接地平面的低阻抗连接将电容器的另一侧接地。

### 9.4 布局

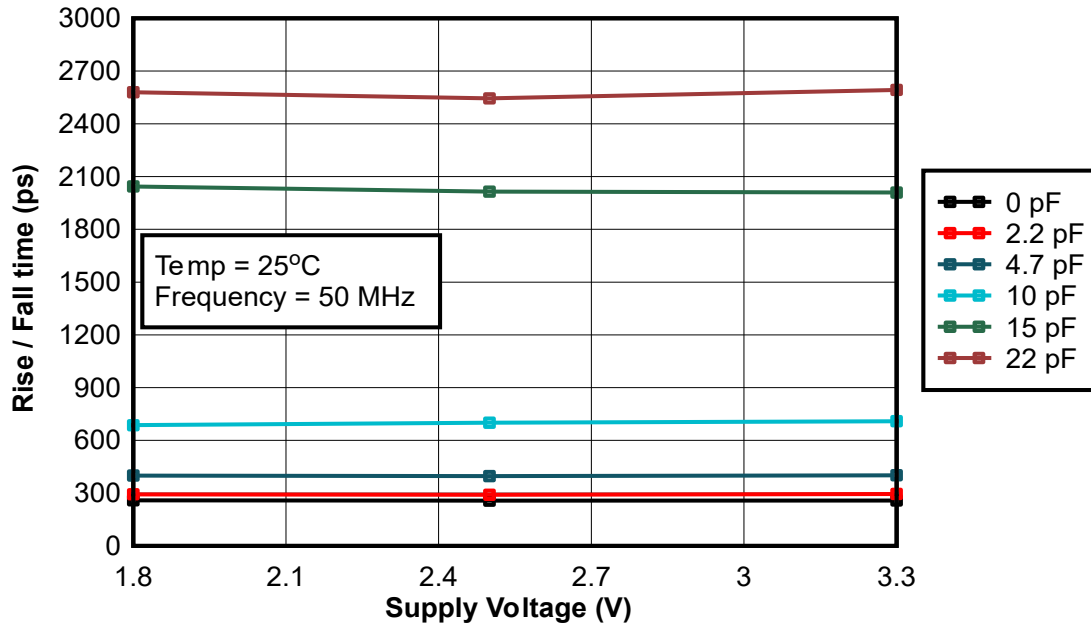
#### 9.4.1 布局指南

以下各节就使用 LMK6x 时的电路板布局布线、回流焊曲线和电源旁路提出了建议，以便为整个系统提供良好的热性能、电气性能和信号完整性。

##### 9.4.1.1 提供热可靠性

LMK6x 是一款高性能器件。因此，请注意器件配置和印刷电路板 (PCB) 布局对功耗的影响。接地引脚必须通过三个或以上通孔连接到 PCB 的接地平面，以最大限度地提高封装的散热。

方程式 1 描述了 LMK6x 周围的 PCB 温度与结温之间的关系。

$$T_B = T_J - \Psi_{JB} \times P \quad (1)$$

其中

- $T_B$  : LMK6x 周围的 PCB 温度
- $T_J$  : LMK6x 结温
- $\Psi_{JB}$  : LMK6x 的结至板热阻参数 ( 请参阅 [规格](#) 部分中的 [热信息表](#) 了解相关信息 )
- $P$  : LMK6x 片上功率耗散

##### 9.4.1.2 建议的回流焊曲线

TI 建议遵循焊锡膏供应商提供的建议，以优化助焊剂活性，并在 J-STD-20 指南范围内达到合金的适当熔化温度。在处理 LMK6x 时，尽量使用最低的峰值温度，同时也要低于 MSL 标签上列出的元件峰值温度额定值。确切的温度曲线取决于多个因素，包括 MSL 标签上额定的元件最高峰值温度、电路板厚度、PCB 材料类型、PCB 几何形状、元件位置、尺寸、PCB 内的密度、焊料制造商建议的曲线以及 SMT 组装操作确认的回流设备能力。

### 9.4.2 布局

请参阅 [LMK6EVM 用户指南](#)，了解 LMK6D、LMK6H、LMK6P 和 LMK6C 器件的印刷电路板布局布线示例。下图显示了在 LMK6x EVM 评估模块上完成的 PCB 布局示例。



图 9-7. LMK6 EVM 的 PCB 布局示例 - 顶层



图 9-8. LMK6 EVM 的 PCB 布局示例 - 接地层 1

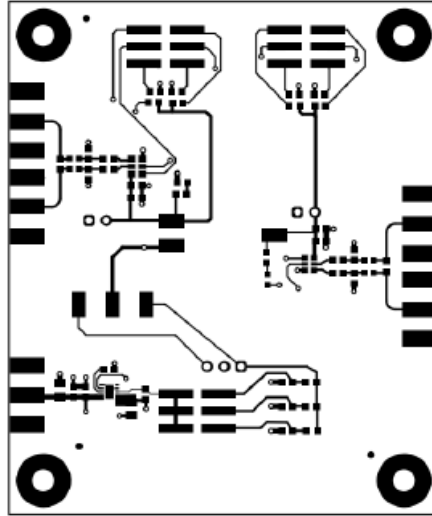

图 9-9. LMK6 EVM 的 PCB 布局示例 - 接地层 2

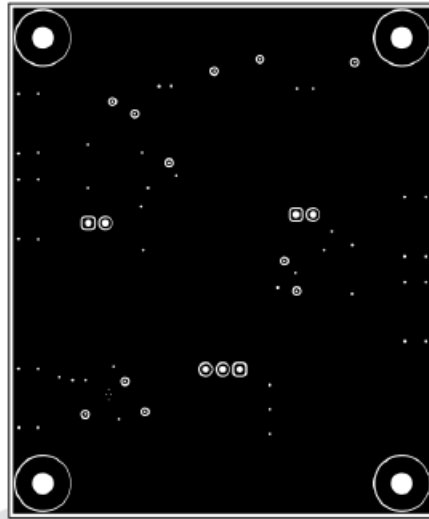

图 9-10. LMK6 EVM 的 PCB 布局示例 - 底层

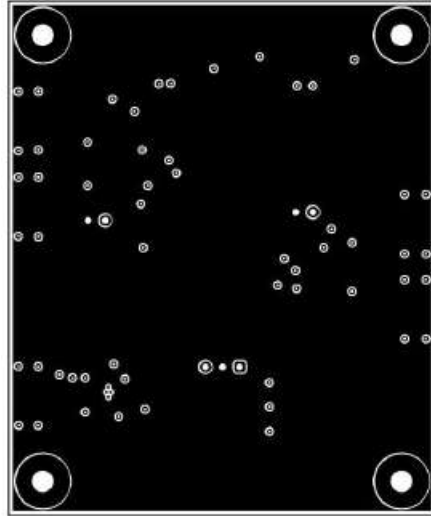

## 10 器件和文档支持

### 10.1 文档支持

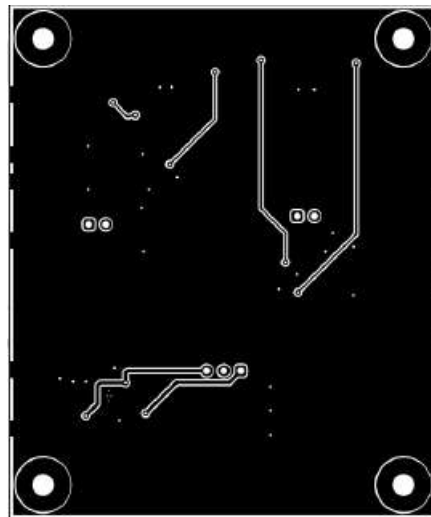
#### 10.1.1 相关文档

请参阅以下相关文档：

- 德州仪器 (TI), [LMK6EVM 用户指南](#)
- 德州仪器 (TI), [独立 BAW 振荡器相对于石英振荡器的优势](#), 应用手册
- 德州仪器 (TI), [适用于楼宇自动化的 BAW 振荡器解决方案](#), 应用手册
- 德州仪器 (TI), [适用于工厂自动化的 BAW 振荡器解决方案](#), 应用手册
- 德州仪器 (TI), [适用于电网基础设施的 BAW 振荡器解决方案](#), 应用手册
- 德州仪器 (TI), [适用于光学模块的 BAW 振荡器解决方案](#), 应用手册

### 10.2 接收文档更新通知

要接收文档更新通知，请导航至 [ti.com](https://www.ti.com) 上的器件产品文件夹。点击 [通知](#) 进行注册，即可每周接收产品信息更改摘要。有关更改的详细信息，请查看任何已修订文档中包含的修订历史记录。

### 10.3 支持资源

[TI E2E™ 中文支持论坛](#) 是工程师的重要参考资料，可直接从专家处获得快速、经过验证的解答和设计帮助。搜索现有解答或提出自己的问题，获得所需的快速设计帮助。

链接的内容由各个贡献者“按原样”提供。这些内容并不构成 TI 技术规范，并且不一定反映 TI 的观点；请参阅 TI 的 [使用条款](#)。

### 10.4 商标

TI E2E™ is a trademark of Texas Instruments.

Keysight® is a registered trademark of Keysight Technologies, Inc..

所有商标均为其各自所有者的财产。

### 10.5 静电放电警告



静电放电 (ESD) 会损坏这个集成电路。德州仪器 (TI) 建议通过适当的预防措施处理所有集成电路。如果不遵守正确的处理和安装程序，可能会损坏集成电路。

ESD 的损坏小至导致微小的性能降级，大至整个器件故障。精密的集成电路可能更容易受到损坏，这是因为非常细微的参数更改都可能会导致器件与其发布的规格不相符。

### 10.6 术语表

[TI 术语表](#) 本术语表列出并解释了术语、首字母缩略词和定义。

## 11 修订历史记录

注：以前版本的页码可能与当前版本的页码不同

### Changes from Revision D (February 2023) to Revision E (January 2024) Page

- |  |   |
|--|---|
| • 向标准频率列表添加了值.....                           | 1 |
| • 更改了 <a href="#">器件订购信息</a> 部分中的器件型号指南..... | 3 |

### Changes from Revision C (December 2022) to Revision D (February 2023) Page

- |   |   |
|---|---|
| • 在 <a href="#">引脚功能</a> 表中，针对 DLF 封装版本将编号列更改为 DLE/DLF..... | 5 |
|---|---|

---

**Changes from Revision B (November 2022) to Revision C (December 2022)**

**Page**

- 将数据表状态从“预告信息”更改为“量产数据” ..... 1
  - 从 LMK6D、LMK6H 和 LMK6P 器件中删除了预发布说明..... 1
- 

## 12 机械、封装和可订购信息

以下页面包含机械、封装和可订购信息。这些信息是指定器件可用的最新数据。数据如有变更，恕不另行通知，且不会对此文档进行修订。有关此数据表的浏览器版本，请查阅左侧的导航栏。

**PACKAGING INFORMATION**

Orderable Device	Status (1)	Package Type	Package Drawing	Pins	Package Qty	Eco Plan (2)	Lead finish/ Ball material (6)	MSL Peak Temp (3)	Op Temp (°C)	Device Marking (4/5)	Samples
LMK6CA026214DDLFR	ACTIVE	VSON	DLF	4	3000	RoHS & Green	Call TI	Level-1-260C-UNLIM	-40 to 105	HC3O	<a href="#">Samples</a>
LMK6CA032768DDLFR	ACTIVE	VSON	DLF	4	3000	RoHS & Green	Call TI	Level-1-260C-UNLIM	-40 to 105	HC3P	<a href="#">Samples</a>
LMK6CA048000CDLFR	ACTIVE	VSON	DLF	4	3000	RoHS & Green	Call TI	Level-1-260C-UNLIM	-40 to 105	LCDC	<a href="#">Samples</a>
LMK6CA048000CDLFT	ACTIVE	VSON	DLF	4	3000	RoHS & Green	Call TI	Level-1-260C-UNLIM	-40 to 105	LCDC	<a href="#">Samples</a>
LMK6CE001000DDLER	ACTIVE	VSON	DLE	4	3000	RoHS & Green	Call TI	Level-1-260C-UNLIM	-40 to 105	LC1R	<a href="#">Samples</a>
LMK6CE001000DDLET	ACTIVE	VSON	DLE	4	250	RoHS & Green	Call TI	Level-1-260C-UNLIM	-40 to 105	LC1R	<a href="#">Samples</a>
LMK6CE001000DDLFR	ACTIVE	VSON	DLF	4	3000	RoHS & Green	Call TI	Level-1-260C-UNLIM	-40 to 105	LC1R	<a href="#">Samples</a>
LMK6CE001200CDLFR	ACTIVE	VSON	DLF	4	3000	RoHS & Green	Call TI	Level-1-260C-UNLIM	-40 to 105	LCBO	<a href="#">Samples</a>
LMK6CE001200CDLFT	ACTIVE	VSON	DLF	4	250	RoHS & Green	Call TI	Level-1-260C-UNLIM	-40 to 105	LCBO	<a href="#">Samples</a>
LMK6CE012288CDLFR	ACTIVE	VSON	DLF	4	3000	RoHS & Green	Call TI	Level-1-260C-UNLIM	-40 to 105	LCBJ	<a href="#">Samples</a>
LMK6CE012288CDLFT	ACTIVE	VSON	DLF	4	250	RoHS & Green	Call TI	Level-1-260C-UNLIM	-40 to 105	LCBJ	<a href="#">Samples</a>
LMK6CE016000CDLER	ACTIVE	VSON	DLE	4	3000	RoHS & Green	Call TI	Level-1-260C-UNLIM	-40 to 105	HCBK	<a href="#">Samples</a>
LMK6CE016000CDLET	ACTIVE	VSON	DLE	4	250	RoHS & Green	Call TI	Level-1-260C-UNLIM	-40 to 105	HCBK	<a href="#">Samples</a>
LMK6CE019200CDLER	ACTIVE	VSON	DLE	4	3000	RoHS & Green	Call TI	Level-1-260C-UNLIM	-40 to 105	HCBB	<a href="#">Samples</a>
LMK6CE02000CDLER	ACTIVE	VSON	DLE	4	3000	RoHS & Green	Call TI	Level-1-260C-UNLIM	-40 to 105	HCBA	<a href="#">Samples</a>
LMK6CE02000CDLET	ACTIVE	VSON	DLE	4	250	RoHS & Green	Call TI	Level-1-260C-UNLIM	-40 to 105	HCBA	<a href="#">Samples</a>
LMK6CE02000CDLFR	ACTIVE	VSON	DLF	4	3000	RoHS & Green	Call TI	Level-1-260C-UNLIM	-40 to 105	HCBA	<a href="#">Samples</a>
LMK6CE02000CDLFT	ACTIVE	VSON	DLF	4	250	RoHS & Green	Call TI	Level-1-260C-UNLIM	-40 to 105	HCBA	<a href="#">Samples</a>
LMK6CE02400CDLER	ACTIVE	VSON	DLE	4	3000	RoHS & Green	Call TI	Level-1-260C-UNLIM	-40 to 105	LCBI	<a href="#">Samples</a>
LMK6CE02400CDLET	ACTIVE	VSON	DLE	4	250	RoHS & Green	Call TI	Level-1-260C-UNLIM	-40 to 105	LCBI	<a href="#">Samples</a>

Orderable Device	Status (1)	Package Type	Package Drawing	Pins	Package Qty	Eco Plan (2)	Lead finish/ Ball material (6)	MSL Peak Temp (3)	Op Temp (°C)	Device Marking (4/5)	Samples
LMK6CE02400CDLFR	ACTIVE	VSON	DLF	4	3000	RoHS & Green	Call TI	Level-1-260C-UNLIM	-40 to 105	LCBI	<a href="#">Samples</a>
LMK6CE02400CDLFT	ACTIVE	VSON	DLF	4	250	RoHS & Green	Call TI	Level-1-260C-UNLIM	-40 to 105	LCBI	<a href="#">Samples</a>
LMK6CE024576CDLFR	ACTIVE	VSON	DLF	4	3000	RoHS & Green	Call TI	Level-1-260C-UNLIM	-40 to 105	LCBH	<a href="#">Samples</a>
LMK6CE024576CDLFT	ACTIVE	VSON	DLF	4	250	RoHS & Green	Call TI	Level-1-260C-UNLIM	-40 to 105	LCBH	<a href="#">Samples</a>
LMK6CE02500CDLER	ACTIVE	VSON	DLE	4	3000	RoHS & Green	Call TI	Level-1-260C-UNLIM	-40 to 105	LCBG	<a href="#">Samples</a>
LMK6CE02500CDLET	ACTIVE	VSON	DLE	4	250	RoHS & Green	Call TI	Level-1-260C-UNLIM	-40 to 105	LCBG	<a href="#">Samples</a>
LMK6CE02500CDLFR	ACTIVE	VSON	DLF	4	3000	RoHS & Green	Call TI	Level-1-260C-UNLIM	-40 to 105	LCBG	<a href="#">Samples</a>
LMK6CE02500CDLFT	ACTIVE	VSON	DLF	4	250	RoHS & Green	Call TI	Level-1-260C-UNLIM	-40 to 105	LCBG	<a href="#">Samples</a>
LMK6CE02500DDLER	ACTIVE	VSON	DLE	4	3000	RoHS & Green	Call TI	Level-1-260C-UNLIM	-40 to 105	LC1G	<a href="#">Samples</a>
LMK6CE02500DDLET	ACTIVE	VSON	DLE	4	250	RoHS & Green	Call TI	Level-1-260C-UNLIM	-40 to 105	LC1G	<a href="#">Samples</a>
LMK6CE02500DDLFR	ACTIVE	VSON	DLF	4	3000	RoHS & Green	Call TI	Level-1-260C-UNLIM	-40 to 105	LC1G	<a href="#">Samples</a>
LMK6CE02500DDLFT	ACTIVE	VSON	DLF	4	250	RoHS & Green	Call TI	Level-1-260C-UNLIM	-40 to 105	LC1G	<a href="#">Samples</a>
LMK6CE027000CDLER	ACTIVE	VSON	DLE	4	3000	RoHS & Green	Call TI	Level-1-260C-UNLIM	-40 to 105	HCB9	<a href="#">Samples</a>
LMK6CE027000CDLET	ACTIVE	VSON	DLE	4	250	RoHS & Green	Call TI	Level-1-260C-UNLIM	-40 to 105	HCB9	<a href="#">Samples</a>
LMK6CE027000CDLFR	ACTIVE	VSON	DLF	4	3000	RoHS & Green	Call TI	Level-1-260C-UNLIM	-40 to 105	HCB9	<a href="#">Samples</a>
LMK6CE027000CDLFT	ACTIVE	VSON	DLF	4	250	RoHS & Green	Call TI	Level-1-260C-UNLIM	-40 to 105	HCB9	<a href="#">Samples</a>
LMK6CE028125CDLFR	ACTIVE	VSON	DLF	4	3000	RoHS & Green	Call TI	Level-1-260C-UNLIM	-40 to 105	HCBJ	<a href="#">Samples</a>
LMK6CE030000CDLFR	ACTIVE	VSON	DLF	4	3000	RoHS & Green	Call TI	Level-1-260C-UNLIM	-40 to 105	LCBD	<a href="#">Samples</a>
LMK6CE030000CDLFT	ACTIVE	VSON	DLF	4	250	RoHS & Green	Call TI	Level-1-260C-UNLIM	-40 to 105	LCBD	<a href="#">Samples</a>
LMK6CE033333DDLFR	ACTIVE	VSON	DLF	4	3000	RoHS & Green	Call TI	Level-1-260C-UNLIM	-40 to 105	HC18	<a href="#">Samples</a>
LMK6CE033333DDLFT	ACTIVE	VSON	DLF	4	250	RoHS & Green	Call TI	Level-1-260C-UNLIM	-40 to 105	HC18	<a href="#">Samples</a>

Orderable Device	Status (1)	Package Type	Package Drawing	Pins	Package Qty	Eco Plan (2)	Lead finish/ Ball material (6)	MSL Peak Temp (3)	Op Temp (°C)	Device Marking (4/5)	Samples
LMK6CE03333ACDLER	ACTIVE	VSON	DLE	4	3000	RoHS & Green	Call TI	Level-1-260C-UNLIM	-40 to 105	HCBT	<a href="#">Samples</a>
LMK6CE03333ACDLET	ACTIVE	VSON	DLE	4	250	RoHS & Green	Call TI	Level-1-260C-UNLIM	-40 to 105	HCBT	<a href="#">Samples</a>
LMK6CE03333CDLER	ACTIVE	VSON	DLE	4	3000	RoHS & Green	Call TI	Level-1-260C-UNLIM	-40 to 105	HCB8	<a href="#">Samples</a>
LMK6CE03333CDLET	ACTIVE	VSON	DLE	4	250	RoHS & Green	Call TI	Level-1-260C-UNLIM	-40 to 105	HCB8	<a href="#">Samples</a>
LMK6CE04000CDLFR	ACTIVE	VSON	DLF	4	3000	RoHS & Green	Call TI	Level-1-260C-UNLIM	-40 to 105	HCB6	<a href="#">Samples</a>
LMK6CE04000CDLFT	ACTIVE	VSON	DLF	4	250	RoHS & Green	Call TI	Level-1-260C-UNLIM	-40 to 105	HCB6	<a href="#">Samples</a>
LMK6CE048000CDLFR	ACTIVE	VSON	DLF	4	3000	RoHS & Green	Call TI	Level-1-260C-UNLIM	-40 to 105	LCBC	<a href="#">Samples</a>
LMK6CE04800DDLFR	ACTIVE	VSON	DLF	4	3000	RoHS & Green	Call TI	Level-1-260C-UNLIM	-40 to 105	LC1C	<a href="#">Samples</a>
LMK6CE04800DDLFT	ACTIVE	VSON	DLF	4	250	RoHS & Green	Call TI	Level-1-260C-UNLIM	-40 to 105	LC1C	<a href="#">Samples</a>
LMK6CE049152CDLFR	ACTIVE	VSON	DLF	4	3000	RoHS & Green	Call TI	Level-1-260C-UNLIM	-40 to 105	HCBR	<a href="#">Samples</a>
LMK6CE05000CDLER	ACTIVE	VSON	DLE	4	3000	RoHS & Green	Call TI	Level-1-260C-UNLIM	-40 to 105	LCCB	<a href="#">Samples</a>
LMK6CE05000CDLET	ACTIVE	VSON	DLE	4	250	RoHS & Green	Call TI	Level-1-260C-UNLIM	-40 to 105	LCCB	<a href="#">Samples</a>
LMK6CE05000CDLFR	ACTIVE	VSON	DLF	4	3000	RoHS & Green	Call TI	Level-1-260C-UNLIM	-40 to 105	LCCB	<a href="#">Samples</a>
LMK6CE05000CDLFT	ACTIVE	VSON	DLF	4	250	RoHS & Green	Call TI	Level-1-260C-UNLIM	-40 to 105	LCCB	<a href="#">Samples</a>
LMK6CE05000DDLER	ACTIVE	VSON	DLE	4	3000	RoHS & Green	Call TI	Level-1-260C-UNLIM	-40 to 105	LC1B	<a href="#">Samples</a>
LMK6CE05000DDLET	ACTIVE	VSON	DLE	4	250	RoHS & Green	Call TI	Level-1-260C-UNLIM	-40 to 105	LC1B	<a href="#">Samples</a>
LMK6CE05000DDLFR	ACTIVE	VSON	DLF	4	3000	RoHS & Green	Call TI	Level-1-260C-UNLIM	-40 to 105	LC1B	<a href="#">Samples</a>
LMK6CE05000DDLFT	ACTIVE	VSON	DLF	4	250	RoHS & Green	Call TI	Level-1-260C-UNLIM	-40 to 105	LC1B	<a href="#">Samples</a>
LMK6CE066666CDLER	ACTIVE	VSON	DLE	4	3000	RoHS & Green	Call TI	Level-1-260C-UNLIM	-40 to 105	LCBA	<a href="#">Samples</a>
LMK6CE066666CDLET	ACTIVE	VSON	DLE	4	250	RoHS & Green	Call TI	Level-1-260C-UNLIM	-40 to 105	LCBA	<a href="#">Samples</a>
LMK6CE07425DDLFR	ACTIVE	VSON	DLF	4	3000	RoHS & Green	Call TI	Level-1-260C-UNLIM	-40 to 105	LC19	<a href="#">Samples</a>

Orderable Device	Status (1)	Package Type	Package Drawing	Pins	Package Qty	Eco Plan (2)	Lead finish/ Ball material (6)	MSL Peak Temp (3)	Op Temp (°C)	Device Marking (4/5)	Samples
LMK6CE07425DDLFT	ACTIVE	VSON	DLF	4	250	RoHS & Green	Call TI	Level-1-260C-UNLIM	-40 to 105	LC19	<a href="#">Samples</a>
LMK6CE10000CDLER	ACTIVE	VSON	DLE	4	3000	RoHS & Green	Call TI	Level-1-260C-UNLIM	-40 to 105	LCB8	<a href="#">Samples</a>
LMK6CE10000CDLET	ACTIVE	VSON	DLE	4	250	RoHS & Green	Call TI	Level-1-260C-UNLIM	-40 to 105	LCB8	<a href="#">Samples</a>
LMK6CE10000CDLFR	ACTIVE	VSON	DLF	4	3000	RoHS & Green	Call TI	Level-1-260C-UNLIM	-40 to 105	LCB8	<a href="#">Samples</a>
LMK6CE10000CDLFT	ACTIVE	VSON	DLF	4	250	RoHS & Green	Call TI	Level-1-260C-UNLIM	-40 to 105	LCB8	<a href="#">Samples</a>
LMK6CE10000DDLER	ACTIVE	VSON	DLE	4	3000	RoHS & Green	Call TI	Level-1-260C-UNLIM	-40 to 105	LC18	<a href="#">Samples</a>
LMK6CE10000DDLET	ACTIVE	VSON	DLE	4	3000	RoHS & Green	Call TI	Level-1-260C-UNLIM	-40 to 105	LC18	<a href="#">Samples</a>
LMK6CE10000DDLFR	ACTIVE	VSON	DLF	4	3000	RoHS & Green	Call TI	Level-1-260C-UNLIM	-40 to 105	LC18	<a href="#">Samples</a>
LMK6CE10000DDLFT	ACTIVE	VSON	DLF	4	250	RoHS & Green	Call TI	Level-1-260C-UNLIM	-40 to 105	LC18	<a href="#">Samples</a>
LMK6CE10800DDLFR	ACTIVE	VSON	DLF	4	3000	RoHS & Green	Call TI	Level-1-260C-UNLIM	-40 to 105	HC11	<a href="#">Samples</a>
LMK6CE10800DDLFT	ACTIVE	VSON	DLF	4	250	RoHS & Green	Call TI	Level-1-260C-UNLIM	-40 to 105	HC11	<a href="#">Samples</a>
LMK6CE125000DDLER	ACTIVE	VSON	DLE	4	3000	RoHS & Green	Call TI	Level-1-260C-UNLIM	-40 to 105	LC16	<a href="#">Samples</a>
LMK6CE12500CDLER	ACTIVE	VSON	DLE	4	3000	RoHS & Green	Call TI	Level-1-260C-UNLIM	-40 to 105	LCB6	<a href="#">Samples</a>
LMK6CE12500CDLET	ACTIVE	VSON	DLE	4	250	RoHS & Green	Call TI	Level-1-260C-UNLIM	-40 to 105	LCB6	<a href="#">Samples</a>
LMK6CE15625DDLFR	ACTIVE	VSON	DLF	4	3000	RoHS & Green	Call TI	Level-1-260C-UNLIM	-40 to 105	LC12	<a href="#">Samples</a>
LMK6CE15625DDLFT	ACTIVE	VSON	DLF	4	250	RoHS & Green	Call TI	Level-1-260C-UNLIM	-40 to 105	LC12	<a href="#">Samples</a>
LMK6DA02500ADLFR	ACTIVE	VSON	DLF	6	3000	RoHS & Green	Call TI	Level-1-260C-UNLIM	-40 to 85	LDAG	<a href="#">Samples</a>
LMK6DA02500ADLFT	ACTIVE	VSON	DLF	6	250	RoHS & Green	Call TI	Level-1-260C-UNLIM	-40 to 85	LDAG	<a href="#">Samples</a>
LMK6DA05184ADLER	ACTIVE	VSON	DLE	6	3000	RoHS & Green	Call TI	Level-1-260C-UNLIM	-40 to 85	HDAH	<a href="#">Samples</a>
LMK6DA05184ADLET	ACTIVE	VSON	DLE	6	250	RoHS & Green	Call TI	Level-1-260C-UNLIM	-40 to 85	HDAH	<a href="#">Samples</a>
LMK6DA10000ADLER	ACTIVE	VSON	DLE	6	3000	RoHS & Green	Call TI	Level-1-260C-UNLIM	-40 to 85	LDA8	<a href="#">Samples</a>

Orderable Device	Status (1)	Package Type	Package Drawing	Pins	Package Qty	Eco Plan (2)	Lead finish/ Ball material (6)	MSL Peak Temp (3)	Op Temp (°C)	Device Marking (4/5)	Samples
LMK6DA10000ADLET	ACTIVE	VSON	DLE	6	250	RoHS & Green	Call TI	Level-1-260C-UNLIM	-40 to 85	LDA8	<a href="#">Samples</a>
LMK6DA10000ADLFR	ACTIVE	VSON	DLF	6	3000	RoHS & Green	Call TI	Level-1-260C-UNLIM	-40 to 85	LDA8	<a href="#">Samples</a>
LMK6DA10000ADLFT	ACTIVE	VSON	DLF	6	250	RoHS & Green	Call TI	Level-1-260C-UNLIM	-40 to 85	LDA8	<a href="#">Samples</a>
LMK6DA12288ADLER	ACTIVE	VSON	DLE	6	3000	RoHS & Green	Call TI	Level-1-260C-UNLIM	-40 to 85	HDA4	<a href="#">Samples</a>
LMK6DA12288ADLET	ACTIVE	VSON	DLE	6	250	RoHS & Green	Call TI	Level-1-260C-UNLIM	-40 to 85	HDA4	<a href="#">Samples</a>
LMK6DA12288ADLFR	ACTIVE	VSON	DLF	6	3000	RoHS & Green	Call TI	Level-1-260C-UNLIM	-40 to 85	HDA4	<a href="#">Samples</a>
LMK6DA12288ADLFT	ACTIVE	VSON	DLF	6	250	RoHS & Green	Call TI	Level-1-260C-UNLIM	-40 to 85	HDA4	<a href="#">Samples</a>
LMK6DA125000ADLER	ACTIVE	VSON	DLE	6	3000	RoHS & Green	Call TI	Level-1-260C-UNLIM	-40 to 85	LDA6	<a href="#">Samples</a>
LMK6DA125000ADLET	ACTIVE	VSON	DLE	6	3000	RoHS & Green	Call TI	Level-1-260C-UNLIM	-40 to 85	LDA6	<a href="#">Samples</a>
LMK6DA12500ADLFR	ACTIVE	VSON	DLF	6	3000	RoHS & Green	Call TI	Level-1-260C-UNLIM	-40 to 85	LDA6	<a href="#">Samples</a>
LMK6DA12500ADLFT	ACTIVE	VSON	DLF	6	250	RoHS & Green	Call TI	Level-1-260C-UNLIM	-40 to 85	LDA6	<a href="#">Samples</a>
LMK6DA14850ADLFR	ACTIVE	VSON	DLF	6	3000	RoHS & Green	Call TI	Level-1-260C-UNLIM	-40 to 85	LDA3	<a href="#">Samples</a>
LMK6DA14850ADLFT	ACTIVE	VSON	DLF	6	250	RoHS & Green	Call TI	Level-1-260C-UNLIM	-40 to 85	LDA3	<a href="#">Samples</a>
LMK6DA15552ADLER	ACTIVE	VSON	DLE	6	3000	RoHS & Green	Call TI	Level-1-260C-UNLIM	-40 to 85	HDA3	<a href="#">Samples</a>
LMK6DA15552ADLET	ACTIVE	VSON	DLE	6	250	RoHS & Green	Call TI	Level-1-260C-UNLIM	-40 to 85	HDA3	<a href="#">Samples</a>
LMK6DA15625ADLER	ACTIVE	VSON	DLE	6	3000	RoHS & Green	Call TI	Level-1-260C-UNLIM	-40 to 85	LDA2	<a href="#">Samples</a>
LMK6DA15625ADLET	ACTIVE	VSON	DLE	6	250	RoHS & Green	Call TI	Level-1-260C-UNLIM	-40 to 85	LDA2	<a href="#">Samples</a>
LMK6DA15625ADLFR	ACTIVE	VSON	DLF	6	3000	RoHS & Green	Call TI	Level-1-260C-UNLIM	-40 to 85	LDA2	<a href="#">Samples</a>
LMK6DA15625ADLFT	ACTIVE	VSON	DLF	6	250	RoHS & Green	Call TI	Level-1-260C-UNLIM	-40 to 85	LDA2	<a href="#">Samples</a>
LMK6DA20000ADLER	ACTIVE	VSON	DLE	6	3000	RoHS & Green	Call TI	Level-1-260C-UNLIM	-40 to 85	HDA1	<a href="#">Samples</a>
LMK6DA20000ADLET	ACTIVE	VSON	DLE	6	250	RoHS & Green	Call TI	Level-1-260C-UNLIM	-40 to 85	HDA1	<a href="#">Samples</a>

Orderable Device	Status (1)	Package Type	Package Drawing	Pins	Package Qty	Eco Plan (2)	Lead finish/ Ball material (6)	MSL Peak Temp (3)	Op Temp (°C)	Device Marking (4/5)	Samples
LMK6DA20000ADLFR	ACTIVE	VSON	DLF	6	3000	RoHS & Green	Call TI	Level-1-260C-UNLIM	-40 to 85	HDA1	<a href="#">Samples</a>
LMK6DA20000ADLFT	ACTIVE	VSON	DLF	6	250	RoHS & Green	Call TI	Level-1-260C-UNLIM	-40 to 85	HDA1	<a href="#">Samples</a>
LMK6DA31250ADLFR	ACTIVE	VSON	DLF	6	3000	RoHS & Green	Call TI	Level-1-260C-UNLIM	-40 to 85	LDA0	<a href="#">Samples</a>
LMK6DA31250ADLFT	ACTIVE	VSON	DLF	6	250	RoHS & Green	Call TI	Level-1-260C-UNLIM	-40 to 85	LDA0	<a href="#">Samples</a>
LMK6DA40000ADLFR	ACTIVE	VSON	DLF	6	3000	RoHS & Green	Call TI	Level-1-260C-UNLIM	-40 to 85	LDAM	<a href="#">Samples</a>
LMK6DA40000ADLFT	ACTIVE	VSON	DLF	6	250	RoHS & Green	Call TI	Level-1-260C-UNLIM	-40 to 85	LDAM	<a href="#">Samples</a>
LMK6DE02600ADLFR	ACTIVE	VSON	DLF	6		RoHS & Green	Call TI	Level-1-260C-UNLIM	-40 to 85	LDGF	<a href="#">Samples</a>
LMK6DE050000ADLER	ACTIVE	VSON	DLE	6	3000	RoHS & Green	Call TI	Level-1-260C-UNLIM	-40 to 85	LDGB	<a href="#">Samples</a>
LMK6DE050000ADLET	ACTIVE	VSON	DLE	6	250	RoHS & Green	Call TI	Level-1-260C-UNLIM	-40 to 85	LDGB	<a href="#">Samples</a>
LMK6DE133330ADLER	ACTIVE	VSON	DLE	6	3000	RoHS & Green	Call TI	Level-1-260C-UNLIM	-40 to 85	LDG5	<a href="#">Samples</a>
LMK6DE133330ADLET	ACTIVE	VSON	DLE	6	250	RoHS & Green	Call TI	Level-1-260C-UNLIM	-40 to 85	LDG5	<a href="#">Samples</a>
LMK6DE156250BDLER	ACTIVE	VSON	DLE	6	3000	RoHS & Green	Call TI	Level-1-260C-UNLIM	-40 to 85	LD72	<a href="#">Samples</a>
LMK6DE156250BDLET	ACTIVE	VSON	DLE	6	250	RoHS & Green	Call TI	Level-1-260C-UNLIM	-40 to 85	LD72	<a href="#">Samples</a>
LMK6DE322265ADLFR	ACTIVE	VSON	DLF	6	3000	RoHS & Green	Call TI	Level-1-260C-UNLIM	-40 to 85	HDGS	<a href="#">Samples</a>
LMK6DE322265ADLFT	ACTIVE	VSON	DLF	6	250	RoHS & Green	Call TI	Level-1-260C-UNLIM	-40 to 85	HDGS	<a href="#">Samples</a>
LMK6DE400000BDLER	ACTIVE	VSON	DLE	6	3000	RoHS & Green	Call TI	Level-1-260C-UNLIM	-40 to 85	LD7M	<a href="#">Samples</a>
LMK6HA10000ADLER	ACTIVE	VSON	DLE	6	3000	RoHS & Green	Call TI	Level-1-260C-UNLIM	-40 to 85	LHA8	<a href="#">Samples</a>
LMK6HA10000ADLET	ACTIVE	VSON	DLE	6	250	RoHS & Green	Call TI	Level-1-260C-UNLIM	-40 to 85	LHA8	<a href="#">Samples</a>
LMK6HA10000ADLFR	ACTIVE	VSON	DLF	6	3000	RoHS & Green	Call TI	Level-1-260C-UNLIM	-40 to 85	LHA8	<a href="#">Samples</a>
LMK6HA10000ADLFT	ACTIVE	VSON	DLF	6	250	RoHS & Green	Call TI	Level-1-260C-UNLIM	-40 to 85	LHA8	<a href="#">Samples</a>
LMK6HA10000BDLFR	ACTIVE	VSON	DLF	6	3000	RoHS & Green	Call TI	Level-1-260C-UNLIM	-40 to 85	LH18	<a href="#">Samples</a>



Orderable Device	Status (1)	Package Type	Package Drawing	Pins	Package Qty	Eco Plan (2)	Lead finish/ Ball material (6)	MSL Peak Temp (3)	Op Temp (°C)	Device Marking (4/5)	Samples
LMK6HA10000BDLFT	ACTIVE	VSON	DLF	6	250	RoHS & Green	Call TI	Level-1-260C-UNLIM	-40 to 85	LH18	<a href="#">Samples</a>
LMK6HA15625ADLER	ACTIVE	VSON	DLE	6	3000	RoHS & Green	Call TI	Level-1-260C-UNLIM	-40 to 85	LHA2	<a href="#">Samples</a>
LMK6HA15625ADLET	ACTIVE	VSON	DLE	6	250	RoHS & Green	Call TI	Level-1-260C-UNLIM	-40 to 85	LHA2	<a href="#">Samples</a>
LMK6HA40000ADLER	ACTIVE	VSON	DLE	6	3000	RoHS & Green	Call TI	Level-1-260C-UNLIM	-40 to 85	LHAM	<a href="#">Samples</a>
LMK6HA40000ADLET	ACTIVE	VSON	DLE	6	250	RoHS & Green	Call TI	Level-1-260C-UNLIM	-40 to 85	LHAM	<a href="#">Samples</a>
LMK6HE025000ADLER	ACTIVE	VSON	DLE	6	3000	RoHS & Green	Call TI	Level-1-260C-UNLIM	-40 to 85	LHGG	<a href="#">Samples</a>
LMK6HE025000ADLET	ACTIVE	VSON	DLE	6	250	RoHS & Green	Call TI	Level-1-260C-UNLIM	-40 to 85	LHGG	<a href="#">Samples</a>
LMK6HE100000ADLER	ACTIVE	VSON	DLE	6		RoHS & Green	Call TI	Level-1-260C-UNLIM	-40 to 85	LHG8	<a href="#">Samples</a>
LMK6HE156250BDLFR	ACTIVE	VSON	DLF	6	3000	RoHS & Green	Call TI	Level-1-260C-UNLIM	-40 to 85	LH22	<a href="#">Samples</a>
LMK6HE156250BDLFT	ACTIVE	VSON	DLF	6	250	RoHS & Green	Call TI	Level-1-260C-UNLIM	-40 to 85	LH22	<a href="#">Samples</a>
LMK6HE400000BDLER	ACTIVE	VSON	DLE	6	3000	RoHS & Green	Call TI	Level-1-260C-UNLIM	-40 to 85	LH7M	<a href="#">Samples</a>
LMK6HE400000BDLET	ACTIVE	VSON	DLE	6	250	RoHS & Green	Call TI	Level-1-260C-UNLIM	-40 to 85	LH7M	<a href="#">Samples</a>
LMK6HE40000ADLFR	ACTIVE	VSON	DLF	6	3000	RoHS & Green	Call TI	Level-1-260C-UNLIM	-40 to 85	LHGM	<a href="#">Samples</a>
LMK6HE40000ADLFT	ACTIVE	VSON	DLF	6	250	RoHS & Green	Call TI	Level-1-260C-UNLIM	-40 to 85	LHGM	<a href="#">Samples</a>
LMK6PA15625ADLER	ACTIVE	VSON	DLE	6	3000	RoHS & Green	Call TI	Level-1-260C-UNLIM	-40 to 85	LPA2	<a href="#">Samples</a>
LMK6PA15625ADLET	ACTIVE	VSON	DLE	6	250	RoHS & Green	Call TI	Level-1-260C-UNLIM	-40 to 85	LPA2	<a href="#">Samples</a>
LMK6PA15625ADLFR	ACTIVE	VSON	DLF	6	3000	RoHS & Green	Call TI	Level-1-260C-UNLIM	-40 to 85	LPA2	<a href="#">Samples</a>
LMK6PA15625ADLFT	ACTIVE	VSON	DLF	6	250	RoHS & Green	Call TI	Level-1-260C-UNLIM	-40 to 85	LPA2	<a href="#">Samples</a>
LMK6PE025000ADLER	ACTIVE	VSON	DLE	6	3000	RoHS & Green	Call TI	Level-1-260C-UNLIM	-40 to 85	LPGG	<a href="#">Samples</a>
LMK6PE025000ADLET	ACTIVE	VSON	DLE	6	250	RoHS & Green	Call TI	Level-1-260C-UNLIM	-40 to 85	LPGG	<a href="#">Samples</a>
LMK6PE025000BDLFR	ACTIVE	VSON	DLF	6	3000	RoHS & Green	Call TI	Level-1-260C-UNLIM	-40 to 85	LP7G	<a href="#">Samples</a>

Orderable Device	Status (1)	Package Type	Package Drawing	Pins	Package Qty	Eco Plan (2)	Lead finish/ Ball material (6)	MSL Peak Temp (3)	Op Temp (°C)	Device Marking (4/5)	Samples
LMK6PE025000BDLFT	ACTIVE	VSON	DLF	6	250	RoHS & Green	Call TI	Level-1-260C-UNLIM	-40 to 85	LP7G	<a href="#">Samples</a>
LMK6PE100000ADLER	ACTIVE	VSON	DLE	6	3000	RoHS & Green	Call TI	Level-1-260C-UNLIM	-40 to 85	LPG8	<a href="#">Samples</a>
LMK6PE100000ADLET	ACTIVE	VSON	DLE	6	250	RoHS & Green	Call TI	Level-1-260C-UNLIM	-40 to 85	LPG8	<a href="#">Samples</a>
LMK6PE150000ADLER	ACTIVE	VSON	DLE	6	3000	RoHS & Green	Call TI	Level-1-260C-UNLIM	-40 to 85	LPGQ	<a href="#">Samples</a>
LMK6PE150000ADLET	ACTIVE	VSON	DLE	6	250	RoHS & Green	Call TI	Level-1-260C-UNLIM	-40 to 85	LPGQ	<a href="#">Samples</a>
LMK6PE161132ADLER	ACTIVE	VSON	DLE	6	3000	RoHS & Green	Call TI	Level-1-260C-UNLIM	-40 to 85	LPG1	<a href="#">Samples</a>
LMK6PE161132ADLET	ACTIVE	VSON	DLE	6	250	RoHS & Green	Call TI	Level-1-260C-UNLIM	-40 to 85	LPG1	<a href="#">Samples</a>

(1) The marketing status values are defined as follows:

**ACTIVE:** Product device recommended for new designs.

**LIFEBUY:** TI has announced that the device will be discontinued, and a lifetime-buy period is in effect.

**NRND:** Not recommended for new designs. Device is in production to support existing customers, but TI does not recommend using this part in a new design.

**PREVIEW:** Device has been announced but is not in production. Samples may or may not be available.

**OBSELETE:** TI has discontinued the production of the device.

(2) **RoHS:** TI defines "RoHS" to mean semiconductor products that are compliant with the current EU RoHS requirements for all 10 RoHS substances, including the requirement that RoHS substance do not exceed 0.1% by weight in homogeneous materials. Where designed to be soldered at high temperatures, "RoHS" products are suitable for use in specified lead-free processes. TI may reference these types of products as "Pb-Free".

**RoHS Exempt:** TI defines "RoHS Exempt" to mean products that contain lead but are compliant with EU RoHS pursuant to a specific EU RoHS exemption.

**Green:** TI defines "Green" to mean the content of Chlorine (Cl) and Bromine (Br) based flame retardants meet JS709B low halogen requirements of <=1000ppm threshold. Antimony trioxide based flame retardants must also meet the <=1000ppm threshold requirement.

(3) MSL, Peak Temp. - The Moisture Sensitivity Level rating according to the JEDEC industry standard classifications, and peak solder temperature.

(4) There may be additional marking, which relates to the logo, the lot trace code information, or the environmental category on the device.

(5) Multiple Device Markings will be inside parentheses. Only one Device Marking contained in parentheses and separated by a "~" will appear on a device. If a line is indented then it is a continuation of the previous line and the two combined represent the entire Device Marking for that device.

(6) Lead finish/Ball material - Orderable Devices may have multiple material finish options. Finish options are separated by a vertical ruled line. Lead finish/Ball material values may wrap to two lines if the finish value exceeds the maximum column width.

**Important Information and Disclaimer:** The information provided on this page represents TI's knowledge and belief as of the date that it is provided. TI bases its knowledge and belief on information provided by third parties, and makes no representation or warranty as to the accuracy of such information. Efforts are underway to better integrate information from third parties. TI has taken and continues to take reasonable steps to provide representative and accurate information but may not have conducted destructive testing or chemical analysis on incoming materials and chemicals. TI and TI suppliers consider certain information to be proprietary, and thus CAS numbers and other limited information may not be available for release.

In no event shall TI's liability arising out of such information exceed the total purchase price of the TI part(s) at issue in this document sold by TI to Customer on an annual basis.

## TAPE AND REEL INFORMATION



### QUADRANT ASSIGNMENTS FOR PIN 1 ORIENTATION IN TAPE



\*All dimensions are nominal

Device	Package Type	Package Drawing	Pins	SPQ	Reel Diameter (mm)	Reel Width W1 (mm)	A0 (mm)	B0 (mm)	K0 (mm)	P1 (mm)	W (mm)	Pin1 Quadrant
LMK6CA026214DDLFR	VSON	DLF	4	3000	180.0	8.4	2.25	2.8	1.1	4.0	8.0	Q1
LMK6CA032768DDLFR	VSON	DLF	4	3000	180.0	8.4	2.25	2.8	1.1	4.0	8.0	Q1
LMK6CA048000CDLFR	VSON	DLF	4	3000	180.0	8.4	2.25	2.8	1.1	4.0	8.0	Q1
LMK6CA048000CDLFT	VSON	DLF	4	3000	180.0	8.4	2.25	2.8	1.1	4.0	8.0	Q1
LMK6CE001000DDLER	VSON	DLE	4	3000	330.0	12.4	2.8	3.5	1.2	4.0	12.0	Q1
LMK6CE001000DDLET	VSON	DLE	4	250	180.0	12.4	2.8	3.5	1.2	4.0	12.0	Q1
LMK6CE001000DDLFR	VSON	DLF	4	3000	180.0	8.4	2.25	2.8	1.1	4.0	8.0	Q1
LMK6CE001200CDLFR	VSON	DLF	4	3000	180.0	8.4	2.25	2.8	1.1	4.0	8.0	Q1
LMK6CE001200CDLFT	VSON	DLF	4	250	180.0	8.4	2.25	2.8	1.1	4.0	8.0	Q1
LMK6CE012288CDLFR	VSON	DLF	4	3000	180.0	8.4	2.25	2.8	1.1	4.0	8.0	Q1
LMK6CE012288CDLFT	VSON	DLF	4	250	180.0	8.4	2.25	2.8	1.1	4.0	8.0	Q1
LMK6CE016000CDLER	VSON	DLE	4	3000	330.0	12.4	2.8	3.5	1.2	4.0	12.0	Q1
LMK6CE016000CDLET	VSON	DLE	4	250	180.0	12.4	2.8	3.5	1.2	4.0	12.0	Q1
LMK6CE019200CDLER	VSON	DLE	4	3000	330.0	12.4	2.8	3.5	1.2	4.0	12.0	Q1
LMK6CE02000CDLER	VSON	DLE	4	3000	330.0	12.4	2.8	3.5	1.2	4.0	12.0	Q1
LMK6CE02000CDLET	VSON	DLE	4	250	180.0	12.4	2.8	3.5	1.2	4.0	12.0	Q1

Device	Package Type	Package Drawing	Pins	SPQ	Reel Diameter (mm)	Reel Width W1 (mm)	A0 (mm)	B0 (mm)	K0 (mm)	P1 (mm)	W (mm)	Pin1 Quadrant
LMK6CE02000CDLFR	VSON	DLF	4	3000	180.0	8.4	2.25	2.8	1.1	4.0	8.0	Q1
LMK6CE02000CDLFT	VSON	DLF	4	250	180.0	8.4	2.25	2.8	1.1	4.0	8.0	Q1
LMK6CE02400CDLER	VSON	DLE	4	3000	330.0	12.4	2.8	3.5	1.2	4.0	12.0	Q1
LMK6CE02400CDLET	VSON	DLE	4	250	180.0	12.4	2.8	3.5	1.2	4.0	12.0	Q1
LMK6CE02400CDLFR	VSON	DLF	4	3000	180.0	8.4	2.25	2.8	1.1	4.0	8.0	Q1
LMK6CE02400CDLFT	VSON	DLF	4	250	180.0	8.4	2.25	2.8	1.1	4.0	8.0	Q1
LMK6CE024576CDLFR	VSON	DLF	4	3000	180.0	8.4	2.25	2.8	1.1	4.0	8.0	Q1
LMK6CE024576CDLFT	VSON	DLF	4	250	180.0	8.4	2.25	2.8	1.1	4.0	8.0	Q1
LMK6CE02500CDLER	VSON	DLE	4	3000	330.0	12.4	2.8	3.5	1.2	4.0	12.0	Q1
LMK6CE02500CDLET	VSON	DLE	4	250	180.0	12.4	2.8	3.5	1.2	4.0	12.0	Q1
LMK6CE02500CDLFR	VSON	DLF	4	3000	180.0	8.4	2.25	2.8	1.1	4.0	8.0	Q1
LMK6CE02500CDLFT	VSON	DLF	4	250	180.0	8.4	2.25	2.8	1.1	4.0	8.0	Q1
LMK6CE02500DDLFR	VSON	DLE	4	3000	330.0	12.4	2.8	3.5	1.2	4.0	12.0	Q1
LMK6CE02500DDLET	VSON	DLE	4	250	180.0	12.4	2.8	3.5	1.2	4.0	12.0	Q1
LMK6CE02500DDLFR	VSON	DLF	4	3000	180.0	8.4	2.25	2.8	1.1	4.0	8.0	Q1
LMK6CE02500DDLFT	VSON	DLF	4	250	180.0	8.4	2.25	2.8	1.1	4.0	8.0	Q1
LMK6CE027000CDLER	VSON	DLE	4	3000	330.0	12.4	2.8	3.5	1.2	4.0	12.0	Q1
LMK6CE027000CDLET	VSON	DLE	4	250	180.0	12.4	2.8	3.5	1.2	4.0	12.0	Q1
LMK6CE027000CDLFR	VSON	DLF	4	3000	180.0	8.4	2.25	2.8	1.1	4.0	8.0	Q1
LMK6CE027000CDLFT	VSON	DLF	4	250	180.0	8.4	2.25	2.8	1.1	4.0	8.0	Q1
LMK6CE028125CDLFR	VSON	DLF	4	3000	180.0	8.4	2.25	2.8	1.1	4.0	8.0	Q1
LMK6CE030000CDLFR	VSON	DLF	4	3000	180.0	8.4	2.25	2.8	1.1	4.0	8.0	Q1
LMK6CE030000CDLFT	VSON	DLF	4	250	180.0	8.4	2.25	2.8	1.1	4.0	8.0	Q1
LMK6CE033333DDLFR	VSON	DLF	4	3000	180.0	8.4	2.25	2.8	1.1	4.0	8.0	Q1
LMK6CE033333DDLFT	VSON	DLF	4	250	180.0	8.4	2.25	2.8	1.1	4.0	8.0	Q1
LMK6CE033333ACDLER	VSON	DLE	4	3000	330.0	12.4	2.8	3.5	1.2	4.0	12.0	Q1
LMK6CE033333ACDLET	VSON	DLE	4	250	180.0	12.4	2.8	3.5	1.2	4.0	12.0	Q1
LMK6CE033333CDLER	VSON	DLE	4	3000	330.0	12.4	2.8	3.5	1.2	4.0	12.0	Q1
LMK6CE033333CDLET	VSON	DLE	4	250	180.0	12.4	2.8	3.5	1.2	4.0	12.0	Q1
LMK6CE04000CDLFR	VSON	DLF	4	3000	180.0	8.4	2.25	2.8	1.1	4.0	8.0	Q1
LMK6CE04000CDLFT	VSON	DLF	4	250	180.0	8.4	2.25	2.8	1.1	4.0	8.0	Q1
LMK6CE048000CDLFR	VSON	DLF	4	3000	180.0	8.4	2.25	2.8	1.1	4.0	8.0	Q1
LMK6CE04800DDLFR	VSON	DLF	4	3000	180.0	8.4	2.25	2.8	1.1	4.0	8.0	Q1
LMK6CE04800DDLFT	VSON	DLF	4	250	180.0	8.4	2.25	2.8	1.1	4.0	8.0	Q1
LMK6CE049152CDLFR	VSON	DLF	4	3000	180.0	8.4	2.25	2.8	1.1	4.0	8.0	Q1
LMK6CE05000CDLER	VSON	DLE	4	3000	330.0	12.4	2.8	3.5	1.2	4.0	12.0	Q1
LMK6CE05000CDLET	VSON	DLE	4	250	180.0	12.4	2.8	3.5	1.2	4.0	12.0	Q1
LMK6CE05000CDLFR	VSON	DLF	4	3000	180.0	8.4	2.25	2.8	1.1	4.0	8.0	Q1
LMK6CE05000CDLFT	VSON	DLF	4	250	180.0	8.4	2.25	2.8	1.1	4.0	8.0	Q1
LMK6CE05000DDLFR	VSON	DLE	4	3000	330.0	12.4	2.8	3.5	1.2	4.0	12.0	Q1
LMK6CE05000DDLET	VSON	DLE	4	250	180.0	12.4	2.8	3.5	1.2	4.0	12.0	Q1

Device	Package Type	Package Drawing	Pins	SPQ	Reel Diameter (mm)	Reel Width W1 (mm)	A0 (mm)	B0 (mm)	K0 (mm)	P1 (mm)	W (mm)	Pin1 Quadrant
LMK6CE05000DDLFR	VSON	DLF	4	3000	180.0	8.4	2.25	2.8	1.1	4.0	8.0	Q1
LMK6CE05000DDLFT	VSON	DLF	4	250	180.0	8.4	2.25	2.8	1.1	4.0	8.0	Q1
LMK6CE066666CDLER	VSON	DLE	4	3000	330.0	12.4	2.8	3.5	1.2	4.0	12.0	Q1
LMK6CE066666CDLET	VSON	DLE	4	250	180.0	12.4	2.8	3.5	1.2	4.0	12.0	Q1
LMK6CE07425DDLFR	VSON	DLF	4	3000	180.0	8.4	2.25	2.8	1.1	4.0	8.0	Q1
LMK6CE07425DDLFT	VSON	DLF	4	250	180.0	8.4	2.25	2.8	1.1	4.0	8.0	Q1
LMK6CE10000CDLER	VSON	DLE	4	3000	330.0	12.4	2.8	3.5	1.2	4.0	12.0	Q1
LMK6CE10000CDLET	VSON	DLE	4	250	180.0	12.4	2.8	3.5	1.2	4.0	12.0	Q1
LMK6CE10000CDLFR	VSON	DLF	4	3000	180.0	8.4	2.25	2.8	1.1	4.0	8.0	Q1
LMK6CE10000CDLFT	VSON	DLF	4	250	180.0	8.4	2.25	2.8	1.1	4.0	8.0	Q1
LMK6CE10000DDLFR	VSON	DLE	4	3000	330.0	12.4	2.8	3.5	1.2	4.0	12.0	Q1
LMK6CE10000DDLET	VSON	DLE	4	3000	180.0	12.4	2.8	3.5	1.2	4.0	12.0	Q1
LMK6CE10000DDLFR	VSON	DLF	4	3000	180.0	8.4	2.25	2.8	1.1	4.0	8.0	Q1
LMK6CE10000DDLFT	VSON	DLF	4	250	180.0	8.4	2.25	2.8	1.1	4.0	8.0	Q1
LMK6CE10800DDLFR	VSON	DLF	4	3000	180.0	8.4	2.25	2.8	1.1	4.0	8.0	Q1
LMK6CE10800DDLFT	VSON	DLF	4	250	180.0	8.4	2.25	2.8	1.1	4.0	8.0	Q1
LMK6CE125000DDLFR	VSON	DLE	4	3000	330.0	12.4	2.8	3.5	1.2	4.0	12.0	Q1
LMK6CE125000CDLER	VSON	DLE	4	3000	330.0	12.4	2.8	3.5	1.2	4.0	12.0	Q1
LMK6CE125000CDLET	VSON	DLE	4	250	180.0	12.4	2.8	3.5	1.2	4.0	12.0	Q1
LMK6CE15625DDLFR	VSON	DLF	4	3000	180.0	8.4	2.25	2.8	1.1	4.0	8.0	Q1
LMK6CE15625DDLFT	VSON	DLF	4	250	180.0	8.4	2.25	2.8	1.1	4.0	8.0	Q1
LMK6DA02500ADLFR	VSON	DLF	6	3000	180.0	8.4	2.25	2.8	1.1	4.0	8.0	Q1
LMK6DA02500ADLFT	VSON	DLF	6	250	180.0	8.4	2.25	2.8	1.1	4.0	8.0	Q1
LMK6DA05184ADLER	VSON	DLE	6	3000	330.0	12.4	2.8	3.5	1.2	4.0	12.0	Q1
LMK6DA05184ADLET	VSON	DLE	6	250	180.0	12.4	2.8	3.5	1.2	4.0	12.0	Q1
LMK6DA10000ADLER	VSON	DLE	6	3000	330.0	12.4	2.8	3.5	1.2	4.0	12.0	Q1
LMK6DA10000ADLET	VSON	DLE	6	250	180.0	12.4	2.8	3.5	1.2	4.0	12.0	Q1
LMK6DA10000ADLFR	VSON	DLF	6	3000	180.0	8.4	2.25	2.8	1.1	4.0	8.0	Q1
LMK6DA10000ADLFT	VSON	DLF	6	250	180.0	8.4	2.25	2.8	1.1	4.0	8.0	Q1
LMK6DA12288ADLER	VSON	DLE	6	3000	330.0	12.4	2.8	3.5	1.2	4.0	12.0	Q1
LMK6DA12288ADLET	VSON	DLE	6	250	180.0	12.4	2.8	3.5	1.2	4.0	12.0	Q1
LMK6DA12288ADLFR	VSON	DLF	6	3000	180.0	8.4	2.25	2.8	1.1	4.0	8.0	Q1
LMK6DA12288ADLFT	VSON	DLF	6	250	180.0	8.4	2.25	2.8	1.1	4.0	8.0	Q1
LMK6DA125000ADLER	VSON	DLE	6	3000	330.0	12.4	2.8	3.5	1.2	4.0	12.0	Q1
LMK6DA125000ADLET	VSON	DLE	6	3000	180.0	12.4	2.8	3.5	1.2	4.0	12.0	Q1
LMK6DA12500ADLFR	VSON	DLF	6	3000	180.0	8.4	2.25	2.8	1.1	4.0	8.0	Q1
LMK6DA12500ADLFT	VSON	DLF	6	250	180.0	8.4	2.25	2.8	1.1	4.0	8.0	Q1
LMK6DA14850ADLFR	VSON	DLF	6	3000	180.0	8.4	2.25	2.8	1.1	4.0	8.0	Q1
LMK6DA14850ADLFT	VSON	DLF	6	250	180.0	8.4	2.25	2.8	1.1	4.0	8.0	Q1
LMK6DA15552ADLER	VSON	DLE	6	3000	330.0	12.4	2.8	3.5	1.2	4.0	12.0	Q1
LMK6DA15552ADLET	VSON	DLE	6	250	180.0	12.4	2.8	3.5	1.2	4.0	12.0	Q1

Device	Package Type	Package Drawing	Pins	SPQ	Reel Diameter (mm)	Reel Width W1 (mm)	A0 (mm)	B0 (mm)	K0 (mm)	P1 (mm)	W (mm)	Pin1 Quadrant
LMK6DA15625ADLER	VSON	DLE	6	3000	330.0	12.4	2.8	3.5	1.2	4.0	12.0	Q1
LMK6DA15625ADLET	VSON	DLE	6	250	180.0	12.4	2.8	3.5	1.2	4.0	12.0	Q1
LMK6DA15625ADLFR	VSON	DLF	6	3000	180.0	8.4	2.25	2.8	1.1	4.0	8.0	Q1
LMK6DA15625ADLFT	VSON	DLF	6	250	180.0	8.4	2.25	2.8	1.1	4.0	8.0	Q1
LMK6DA20000ADLER	VSON	DLE	6	3000	330.0	12.4	2.8	3.5	1.2	4.0	12.0	Q1
LMK6DA20000ADLET	VSON	DLE	6	250	180.0	12.4	2.8	3.5	1.2	4.0	12.0	Q1
LMK6DA20000ADLFR	VSON	DLF	6	3000	180.0	8.4	2.25	2.8	1.1	4.0	8.0	Q1
LMK6DA20000ADLFT	VSON	DLF	6	250	180.0	8.4	2.25	2.8	1.1	4.0	8.0	Q1
LMK6DA31250ADLFR	VSON	DLF	6	3000	180.0	8.4	2.25	2.8	1.1	4.0	8.0	Q1
LMK6DA31250ADLFT	VSON	DLF	6	250	180.0	8.4	2.25	2.8	1.1	4.0	8.0	Q1
LMK6DA40000ADLFR	VSON	DLF	6	3000	180.0	8.4	2.25	2.8	1.1	4.0	8.0	Q1
LMK6DA40000ADLFT	VSON	DLF	6	250	180.0	8.4	2.25	2.8	1.1	4.0	8.0	Q1
LMK6DE026000ADLFR	VSON	DLF	6	0	180.0	8.4	2.25	2.8	1.1	4.0	8.0	Q1
LMK6DE050000ADLER	VSON	DLE	6	3000	330.0	12.4	2.8	3.5	1.2	4.0	12.0	Q1
LMK6DE050000ADLET	VSON	DLE	6	250	180.0	12.4	2.8	3.5	1.2	4.0	12.0	Q1
LMK6DE133330ADLER	VSON	DLE	6	3000	330.0	12.4	2.8	3.5	1.2	4.0	12.0	Q1
LMK6DE133330ADLET	VSON	DLE	6	250	180.0	12.4	2.8	3.5	1.2	4.0	12.0	Q1
LMK6DE156250BDLER	VSON	DLE	6	3000	330.0	12.4	2.8	3.5	1.2	4.0	12.0	Q1
LMK6DE156250BDLET	VSON	DLE	6	250	180.0	12.4	2.8	3.5	1.2	4.0	12.0	Q1
LMK6DE322265ADLFR	VSON	DLF	6	3000	180.0	8.4	2.25	2.8	1.1	4.0	8.0	Q1
LMK6DE322265ADLFT	VSON	DLF	6	250	180.0	8.4	2.25	2.8	1.1	4.0	8.0	Q1
LMK6DE400000BDLER	VSON	DLE	6	3000	330.0	12.4	2.8	3.5	1.2	4.0	12.0	Q1
LMK6HA10000ADLER	VSON	DLE	6	3000	330.0	12.4	2.8	3.5	1.2	4.0	12.0	Q1
LMK6HA10000ADLET	VSON	DLE	6	250	180.0	12.4	2.8	3.5	1.2	4.0	12.0	Q1
LMK6HA10000ADLFR	VSON	DLF	6	3000	180.0	8.4	2.25	2.8	1.1	4.0	8.0	Q1
LMK6HA10000ADLFT	VSON	DLF	6	250	180.0	8.4	2.25	2.8	1.1	4.0	8.0	Q1
LMK6HA10000BDLFR	VSON	DLF	6	3000	180.0	8.4	2.25	2.8	1.1	4.0	8.0	Q1
LMK6HA10000BDLFT	VSON	DLF	6	250	180.0	8.4	2.25	2.8	1.1	4.0	8.0	Q1
LMK6HA15625ADLER	VSON	DLE	6	3000	330.0	12.4	2.8	3.5	1.2	4.0	12.0	Q1
LMK6HA15625ADLET	VSON	DLE	6	250	180.0	12.4	2.8	3.5	1.2	4.0	12.0	Q1
LMK6HA40000ADLER	VSON	DLE	6	3000	330.0	12.4	2.8	3.5	1.2	4.0	12.0	Q1
LMK6HA40000ADLET	VSON	DLE	6	250	180.0	12.4	2.8	3.5	1.2	4.0	12.0	Q1
LMK6HE025000ADLER	VSON	DLE	6	3000	330.0	12.4	2.8	3.5	1.2	4.0	12.0	Q1
LMK6HE025000ADLET	VSON	DLE	6	250	180.0	12.4	2.8	3.5	1.2	4.0	12.0	Q1
LMK6HE100000ADLER	VSON	DLE	6	0	330.0	12.4	2.8	3.5	1.2	4.0	12.0	Q1
LMK6HE156250BDLFR	VSON	DLF	6	3000	180.0	8.4	2.25	2.8	1.1	4.0	8.0	Q1
LMK6HE156250BDLFT	VSON	DLF	6	250	180.0	8.4	2.25	2.8	1.1	4.0	8.0	Q1
LMK6HE400000BDLER	VSON	DLE	6	3000	330.0	12.4	2.8	3.5	1.2	4.0	12.0	Q1
LMK6HE400000BDLET	VSON	DLE	6	250	180.0	12.4	2.8	3.5	1.2	4.0	12.0	Q1
LMK6HE40000ADLFR	VSON	DLF	6	3000	180.0	8.4	2.25	2.8	1.1	4.0	8.0	Q1
LMK6HE40000ADLFT	VSON	DLF	6	250	180.0	8.4	2.25	2.8	1.1	4.0	8.0	Q1

Device	Package Type	Package Drawing	Pins	SPQ	Reel Diameter (mm)	Reel Width W1 (mm)	A0 (mm)	B0 (mm)	K0 (mm)	P1 (mm)	W (mm)	Pin1 Quadrant
LMK6PA15625ADLER	VSON	DLE	6	3000	330.0	12.4	2.8	3.5	1.2	4.0	12.0	Q1
LMK6PA15625ADLET	VSON	DLE	6	250	180.0	12.4	2.8	3.5	1.2	4.0	12.0	Q1
LMK6PA15625ADLFR	VSON	DLF	6	3000	180.0	8.4	2.25	2.8	1.1	4.0	8.0	Q1
LMK6PA15625ADLFT	VSON	DLF	6	250	180.0	8.4	2.25	2.8	1.1	4.0	8.0	Q1
LMK6PE025000ADLER	VSON	DLE	6	3000	330.0	12.4	2.8	3.5	1.2	4.0	12.0	Q1
LMK6PE025000ADLET	VSON	DLE	6	250	180.0	12.4	2.8	3.5	1.2	4.0	12.0	Q1
LMK6PE025000BDLFR	VSON	DLF	6	3000	180.0	8.4	2.25	2.8	1.1	4.0	8.0	Q1
LMK6PE025000BDLFT	VSON	DLF	6	250	180.0	8.4	2.25	2.8	1.1	4.0	8.0	Q1
LMK6PE100000ADLER	VSON	DLE	6	3000	330.0	12.4	2.8	3.5	1.2	4.0	12.0	Q1
LMK6PE100000ADLET	VSON	DLE	6	250	180.0	12.4	2.8	3.5	1.2	4.0	12.0	Q1
LMK6PE150000ADLER	VSON	DLE	6	3000	330.0	12.4	2.8	3.5	1.2	4.0	12.0	Q1
LMK6PE150000ADLET	VSON	DLE	6	250	180.0	12.4	2.8	3.5	1.2	4.0	12.0	Q1
LMK6PE161132ADLER	VSON	DLE	6	3000	330.0	12.4	2.8	3.5	1.2	4.0	12.0	Q1
LMK6PE161132ADLET	VSON	DLE	6	250	180.0	12.4	2.8	3.5	1.2	4.0	12.0	Q1



## TAPE AND REEL BOX DIMENSIONS



\*All dimensions are nominal

Device	Package Type	Package Drawing	Pins	SPQ	Length (mm)	Width (mm)	Height (mm)
LMK6CA026214DDLFR	VSON	DLF	4	3000	182.0	182.0	20.0
LMK6CA032768DDLFR	VSON	DLF	4	3000	182.0	182.0	20.0
LMK6CA048000CDLFR	VSON	DLF	4	3000	182.0	182.0	20.0
LMK6CA048000CDLFT	VSON	DLF	4	3000	182.0	182.0	20.0
LMK6CE001000DDLER	VSON	DLE	4	3000	367.0	367.0	35.0
LMK6CE001000DDLET	VSON	DLE	4	250	182.0	182.0	20.0
LMK6CE001000DDLFR	VSON	DLF	4	3000	182.0	182.0	20.0
LMK6CE001200CDLFR	VSON	DLF	4	3000	182.0	182.0	20.0
LMK6CE001200CDLFT	VSON	DLF	4	250	182.0	182.0	20.0
LMK6CE012288CDLFR	VSON	DLF	4	3000	182.0	182.0	20.0
LMK6CE012288CDLFT	VSON	DLF	4	250	182.0	182.0	20.0
LMK6CE016000CDLER	VSON	DLE	4	3000	367.0	367.0	35.0
LMK6CE016000CDLET	VSON	DLE	4	250	182.0	182.0	20.0
LMK6CE019200CDLER	VSON	DLE	4	3000	367.0	367.0	35.0
LMK6CE02000CDLER	VSON	DLE	4	3000	367.0	367.0	35.0
LMK6CE02000CDLET	VSON	DLE	4	250	182.0	182.0	20.0
LMK6CE02000CDLFR	VSON	DLF	4	3000	182.0	182.0	20.0
LMK6CE02000CDLFT	VSON	DLF	4	250	182.0	182.0	20.0

Device	Package Type	Package Drawing	Pins	SPQ	Length (mm)	Width (mm)	Height (mm)
LMK6CE02400CDLER	VSON	DLE	4	3000	367.0	367.0	35.0
LMK6CE02400CDLET	VSON	DLE	4	250	182.0	182.0	20.0
LMK6CE02400CDLFR	VSON	DLF	4	3000	182.0	182.0	20.0
LMK6CE02400CDLFT	VSON	DLF	4	250	182.0	182.0	20.0
LMK6CE024576CDLFR	VSON	DLF	4	3000	182.0	182.0	20.0
LMK6CE024576CDLFT	VSON	DLF	4	250	182.0	182.0	20.0
LMK6CE02500CDLER	VSON	DLE	4	3000	367.0	367.0	35.0
LMK6CE02500CDLET	VSON	DLE	4	250	182.0	182.0	20.0
LMK6CE02500CDLFR	VSON	DLF	4	3000	182.0	182.0	20.0
LMK6CE02500CDLFT	VSON	DLF	4	250	182.0	182.0	20.0
LMK6CE02500DDLER	VSON	DLE	4	3000	367.0	367.0	35.0
LMK6CE02500DDLET	VSON	DLE	4	250	182.0	182.0	20.0
LMK6CE02500DDLFR	VSON	DLF	4	3000	182.0	182.0	20.0
LMK6CE02500DDLFT	VSON	DLF	4	250	182.0	182.0	20.0
LMK6CE027000CDLER	VSON	DLE	4	3000	367.0	367.0	35.0
LMK6CE027000CDLET	VSON	DLE	4	250	182.0	182.0	20.0
LMK6CE027000CDLFR	VSON	DLF	4	3000	182.0	182.0	20.0
LMK6CE027000CDLFT	VSON	DLF	4	250	182.0	182.0	20.0
LMK6CE028125CDLFR	VSON	DLF	4	3000	182.0	182.0	20.0
LMK6CE030000CDLFR	VSON	DLF	4	3000	182.0	182.0	20.0
LMK6CE030000CDLFT	VSON	DLF	4	250	182.0	182.0	20.0
LMK6CE033333DDLFR	VSON	DLF	4	3000	182.0	182.0	20.0
LMK6CE033333DDLFT	VSON	DLF	4	250	182.0	182.0	20.0
LMK6CE033333CDLER	VSON	DLE	4	3000	367.0	367.0	35.0
LMK6CE033333CDLET	VSON	DLE	4	250	182.0	182.0	20.0
LMK6CE033333CDLER	VSON	DLE	4	3000	346.0	346.0	33.0
LMK6CE033333CDLET	VSON	DLE	4	250	182.0	182.0	20.0
LMK6CE040000CDLFR	VSON	DLF	4	3000	182.0	182.0	20.0
LMK6CE040000CDLFT	VSON	DLF	4	250	182.0	182.0	20.0
LMK6CE048000CDLFR	VSON	DLF	4	3000	182.0	182.0	20.0
LMK6CE048000DDLFR	VSON	DLF	4	3000	182.0	182.0	20.0
LMK6CE048000DDLFT	VSON	DLF	4	250	182.0	182.0	20.0
LMK6CE049152CDLFR	VSON	DLF	4	3000	182.0	182.0	20.0
LMK6CE050000CDLER	VSON	DLE	4	3000	367.0	367.0	35.0
LMK6CE050000CDLET	VSON	DLE	4	250	182.0	182.0	20.0
LMK6CE050000CDLFR	VSON	DLF	4	3000	182.0	182.0	20.0
LMK6CE050000CDLFT	VSON	DLF	4	250	182.0	182.0	20.0
LMK6CE050000DDLER	VSON	DLE	4	3000	367.0	367.0	35.0
LMK6CE050000DDLET	VSON	DLE	4	250	182.0	182.0	20.0
LMK6CE050000DDLFR	VSON	DLF	4	3000	182.0	182.0	20.0
LMK6CE050000DDLFT	VSON	DLF	4	250	182.0	182.0	20.0
LMK6CE066666CDLER	VSON	DLE	4	3000	367.0	367.0	35.0
LMK6CE066666CDLET	VSON	DLE	4	250	182.0	182.0	20.0

Device	Package Type	Package Drawing	Pins	SPQ	Length (mm)	Width (mm)	Height (mm)
LMK6CE07425DDLFR	VSON	DLF	4	3000	182.0	182.0	20.0
LMK6CE07425DDLFT	VSON	DLF	4	250	182.0	182.0	20.0
LMK6CE10000CDLER	VSON	DLE	4	3000	367.0	367.0	35.0
LMK6CE10000CDLET	VSON	DLE	4	250	182.0	182.0	20.0
LMK6CE10000CDLFR	VSON	DLF	4	3000	182.0	182.0	20.0
LMK6CE10000CDLFT	VSON	DLF	4	250	182.0	182.0	20.0
LMK6CE10000DDLFR	VSON	DLE	4	3000	367.0	367.0	35.0
LMK6CE10000DDLET	VSON	DLE	4	3000	182.0	182.0	20.0
LMK6CE10000DDLFR	VSON	DLF	4	3000	182.0	182.0	20.0
LMK6CE10000DDLFT	VSON	DLF	4	250	182.0	182.0	20.0
LMK6CE10800DDLFR	VSON	DLF	4	3000	182.0	182.0	20.0
LMK6CE10800DDLFT	VSON	DLF	4	250	182.0	182.0	20.0
LMK6CE125000DDLFR	VSON	DLE	4	3000	367.0	367.0	35.0
LMK6CE125000CDLER	VSON	DLE	4	3000	367.0	367.0	35.0
LMK6CE125000CDLET	VSON	DLE	4	250	182.0	182.0	20.0
LMK6CE15625DDLFR	VSON	DLF	4	3000	182.0	182.0	20.0
LMK6CE15625DDLFT	VSON	DLF	4	250	182.0	182.0	20.0
LMK6DA02500ADLFR	VSON	DLF	6	3000	182.0	182.0	20.0
LMK6DA02500ADLFT	VSON	DLF	6	250	182.0	182.0	20.0
LMK6DA05184ADLER	VSON	DLE	6	3000	346.0	346.0	33.0
LMK6DA05184ADLET	VSON	DLE	6	250	182.0	182.0	20.0
LMK6DA10000ADLER	VSON	DLE	6	3000	367.0	367.0	35.0
LMK6DA10000ADLET	VSON	DLE	6	250	182.0	182.0	20.0
LMK6DA10000ADLFR	VSON	DLF	6	3000	182.0	182.0	20.0
LMK6DA10000ADLFT	VSON	DLF	6	250	182.0	182.0	20.0
LMK6DA12288ADLER	VSON	DLE	6	3000	346.0	346.0	33.0
LMK6DA12288ADLET	VSON	DLE	6	250	210.0	185.0	35.0
LMK6DA12288ADLFR	VSON	DLF	6	3000	182.0	182.0	20.0
LMK6DA12288ADLFT	VSON	DLF	6	250	182.0	182.0	20.0
LMK6DA125000ADLER	VSON	DLE	6	3000	367.0	367.0	35.0
LMK6DA125000ADLET	VSON	DLE	6	3000	182.0	182.0	20.0
LMK6DA12500ADLFR	VSON	DLF	6	3000	182.0	182.0	20.0
LMK6DA12500ADLFT	VSON	DLF	6	250	182.0	182.0	20.0
LMK6DA14850ADLFR	VSON	DLF	6	3000	182.0	182.0	20.0
LMK6DA14850ADLFT	VSON	DLF	6	250	182.0	182.0	20.0
LMK6DA15552ADLER	VSON	DLE	6	3000	346.0	346.0	33.0
LMK6DA15552ADLET	VSON	DLE	6	250	210.0	185.0	35.0
LMK6DA15625ADLER	VSON	DLE	6	3000	367.0	367.0	35.0
LMK6DA15625ADLET	VSON	DLE	6	250	182.0	182.0	20.0
LMK6DA15625ADLFR	VSON	DLF	6	3000	182.0	182.0	20.0
LMK6DA15625ADLFT	VSON	DLF	6	250	182.0	182.0	20.0
LMK6DA20000ADLER	VSON	DLE	6	3000	346.0	346.0	33.0
LMK6DA20000ADLET	VSON	DLE	6	250	210.0	185.0	35.0

Device	Package Type	Package Drawing	Pins	SPQ	Length (mm)	Width (mm)	Height (mm)
LMK6DA20000ADLFR	VSON	DLF	6	3000	182.0	182.0	20.0
LMK6DA20000ADLFT	VSON	DLF	6	250	182.0	182.0	20.0
LMK6DA31250ADLFR	VSON	DLF	6	3000	182.0	182.0	20.0
LMK6DA31250ADLFT	VSON	DLF	6	250	182.0	182.0	20.0
LMK6DA40000ADLFR	VSON	DLF	6	3000	182.0	182.0	20.0
LMK6DA40000ADLFT	VSON	DLF	6	250	182.0	182.0	20.0
LMK6DE026000ADLFR	VSON	DLF	6	0	182.0	182.0	20.0
LMK6DE050000ADLER	VSON	DLE	6	3000	367.0	367.0	35.0
LMK6DE050000ADLET	VSON	DLE	6	250	182.0	182.0	20.0
LMK6DE133330ADLER	VSON	DLE	6	3000	367.0	367.0	35.0
LMK6DE133330ADLET	VSON	DLE	6	250	182.0	182.0	20.0
LMK6DE156250BDLER	VSON	DLE	6	3000	367.0	367.0	35.0
LMK6DE156250BDLET	VSON	DLE	6	250	182.0	182.0	20.0
LMK6DE322265ADLFR	VSON	DLF	6	3000	182.0	182.0	20.0
LMK6DE322265ADLFT	VSON	DLF	6	250	182.0	182.0	20.0
LMK6DE400000BDLER	VSON	DLE	6	3000	367.0	367.0	35.0
LMK6HA10000ADLER	VSON	DLE	6	3000	346.0	346.0	33.0
LMK6HA10000ADLET	VSON	DLE	6	250	210.0	185.0	35.0
LMK6HA10000ADLFR	VSON	DLF	6	3000	182.0	182.0	20.0
LMK6HA10000ADLFT	VSON	DLF	6	250	182.0	182.0	20.0
LMK6HA10000BDLFR	VSON	DLF	6	3000	182.0	182.0	20.0
LMK6HA10000BDLFT	VSON	DLF	6	250	182.0	182.0	20.0
LMK6HA15625ADLER	VSON	DLE	6	3000	367.0	367.0	35.0
LMK6HA15625ADLET	VSON	DLE	6	250	182.0	182.0	20.0
LMK6HA40000ADLER	VSON	DLE	6	3000	367.0	367.0	35.0
LMK6HA40000ADLET	VSON	DLE	6	250	182.0	182.0	20.0
LMK6HE025000ADLER	VSON	DLE	6	3000	367.0	367.0	35.0
LMK6HE025000ADLET	VSON	DLE	6	250	182.0	182.0	20.0
LMK6HE100000ADLER	VSON	DLE	6	0	367.0	367.0	35.0
LMK6HE156250BDLFR	VSON	DLF	6	3000	182.0	182.0	20.0
LMK6HE156250BDLFT	VSON	DLF	6	250	182.0	182.0	20.0
LMK6HE400000BDLER	VSON	DLE	6	3000	367.0	367.0	35.0
LMK6HE400000BDLET	VSON	DLE	6	250	182.0	182.0	20.0
LMK6HE40000ADLFR	VSON	DLF	6	3000	182.0	182.0	20.0
LMK6HE40000ADLFT	VSON	DLF	6	250	182.0	182.0	20.0
LMK6PA15625ADLER	VSON	DLE	6	3000	346.0	346.0	33.0
LMK6PA15625ADLET	VSON	DLE	6	250	182.0	182.0	20.0
LMK6PA15625ADLFR	VSON	DLF	6	3000	182.0	182.0	20.0
LMK6PA15625ADLFT	VSON	DLF	6	250	182.0	182.0	20.0
LMK6PE025000ADLER	VSON	DLE	6	3000	367.0	367.0	35.0
LMK6PE025000ADLET	VSON	DLE	6	250	182.0	182.0	20.0
LMK6PE025000BDLFR	VSON	DLF	6	3000	182.0	182.0	20.0
LMK6PE025000BDLFT	VSON	DLF	6	250	182.0	182.0	20.0

---

<b>Device</b>	<b>Package Type</b>	<b>Package Drawing</b>	<b>Pins</b>	<b>SPQ</b>	<b>Length (mm)</b>	<b>Width (mm)</b>	<b>Height (mm)</b>
LMK6PE100000ADLER	VSON	DLE	6	3000	367.0	367.0	35.0
LMK6PE100000ADLET	VSON	DLE	6	250	182.0	182.0	20.0
LMK6PE150000ADLER	VSON	DLE	6	3000	367.0	367.0	35.0
LMK6PE150000ADLET	VSON	DLE	6	250	182.0	182.0	20.0
LMK6PE161132ADLER	VSON	DLE	6	3000	367.0	367.0	35.0
LMK6PE161132ADLET	VSON	DLE	6	250	182.0	182.0	20.0

## GENERIC PACKAGE VIEW

**DLE 6**

**VSON - 1 mm max height**

2.5 x 3.2, multiple pitch

PLASTIC SMALL OUTLINE - NO LEAD

This image is a representation of the package family, actual package may vary.  
Refer to the product data sheet for package details.

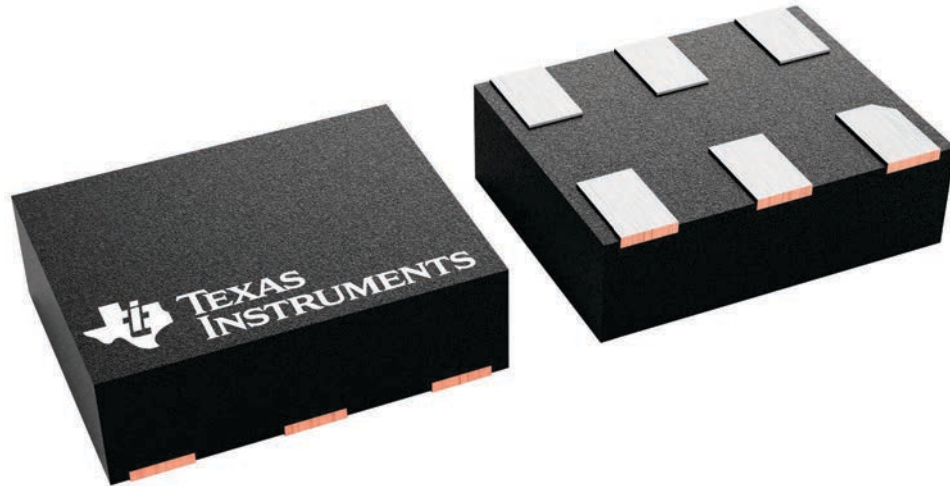

4229714/A

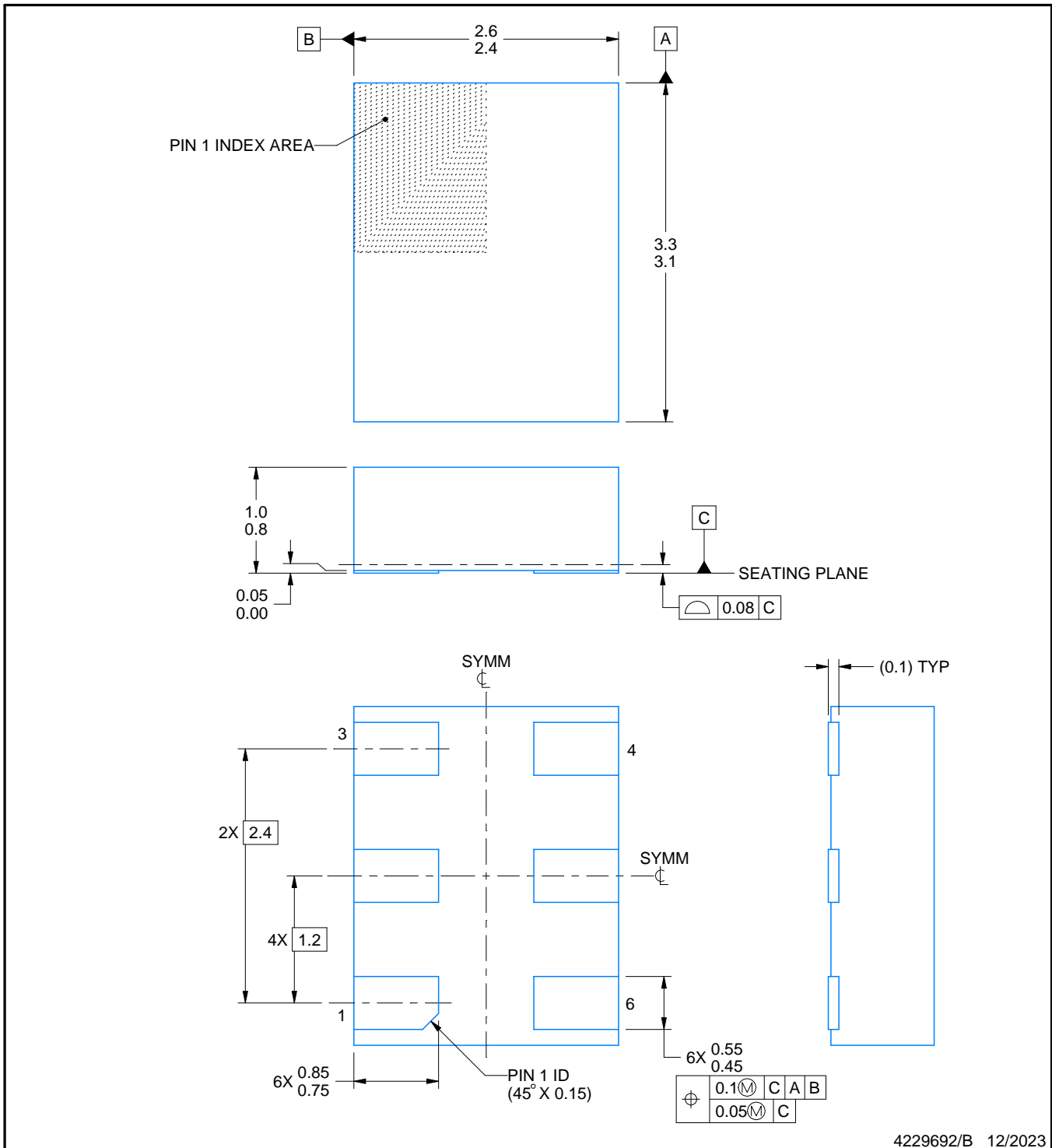
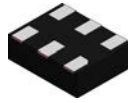

4229692/B 12/2023

NOTES:

1. All linear dimensions are in millimeters. Any dimensions in parenthesis are for reference only. Dimensioning and tolerancing per ASME Y14.5M.
2. This drawing is subject to change without notice.

# EXAMPLE BOARD LAYOUT

DLE0006B

VSON - 1 mm max height

PLASTIC SMALL OUTLINE - NO LEAD

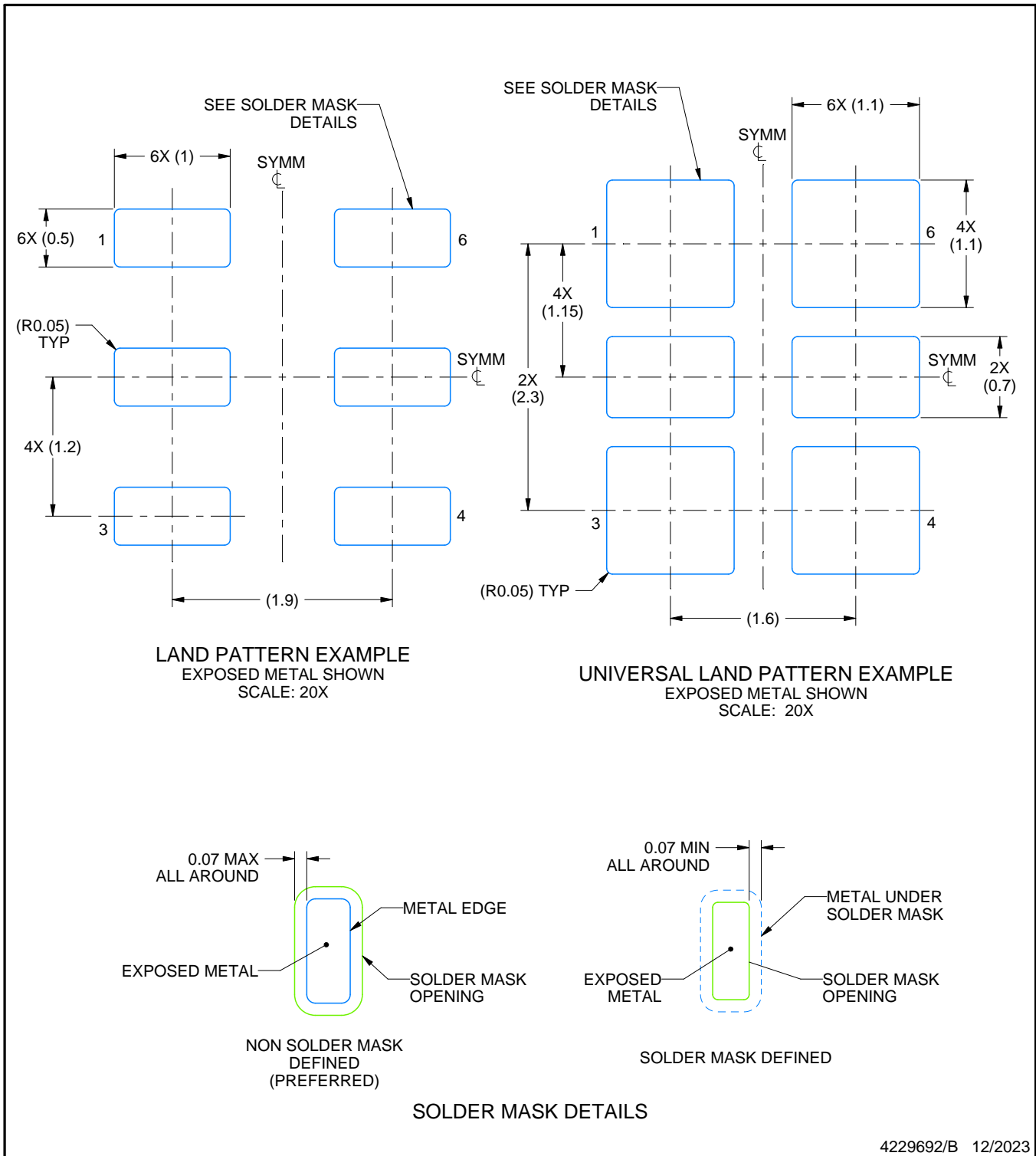

4229692/B 12/2023

NOTES: (continued)

3. For more information, see Texas Instruments literature number SLUA271 ([www.ti.com/lit/slua271](http://www.ti.com/lit/slua271)).



# EXAMPLE STENCIL DESIGN

DLE0006B

VSON - 1 mm max height

PLASTIC SMALL OUTLINE - NO LEAD

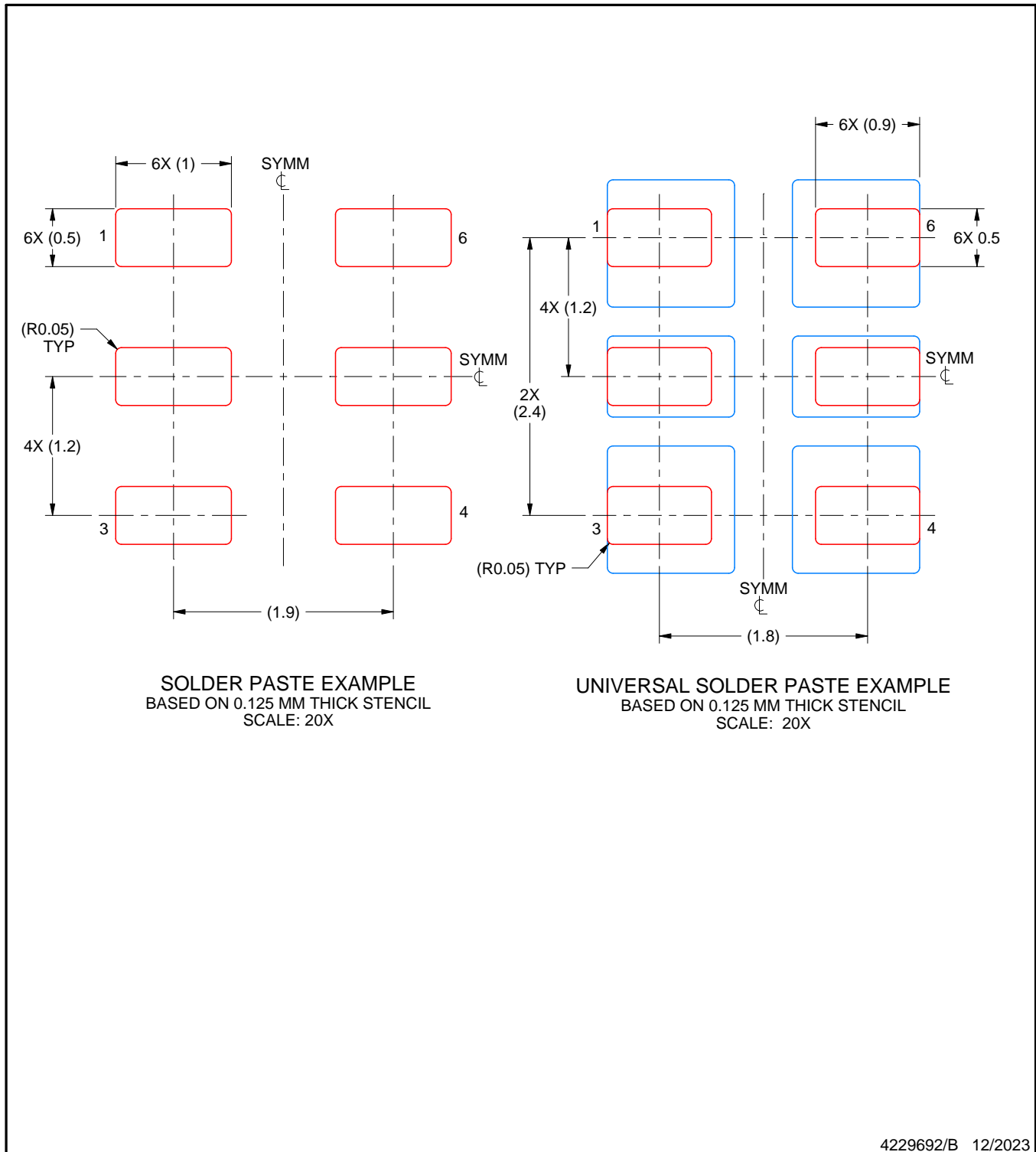

NOTES: (continued)

4. Laser cutting apertures with trapezoidal walls and rounded corners may offer better paste release. IPC-7525 may have alternate design recommendations.

## GENERIC PACKAGE VIEW

**DLF 6**

**VSON - 1 mm max height**

2 x 2.5, multiple pitch

PLASTIC SMALL OUTLINE - NO LEAD

This image is a representation of the package family, actual package may vary.  
Refer to the product data sheet for package details.

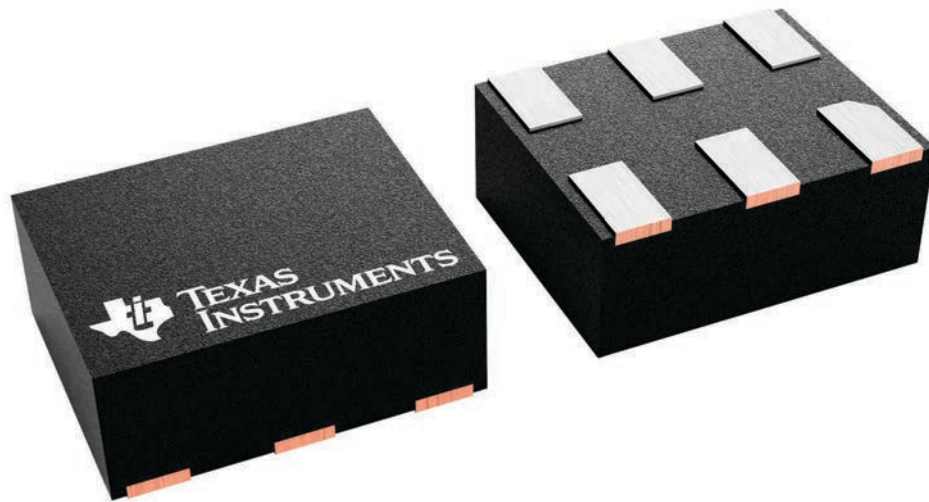

4229715/A

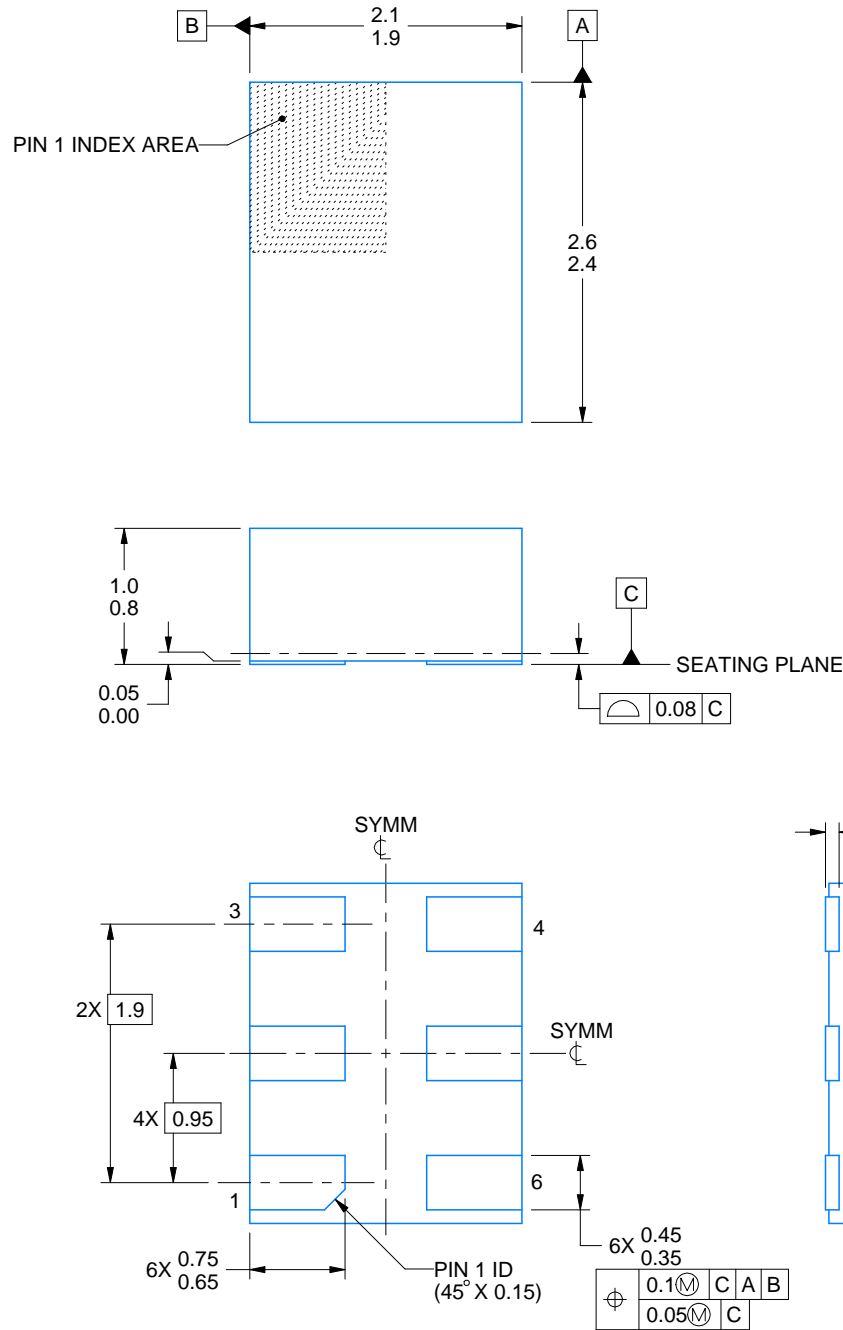
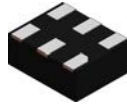

4229693/B 12/2023

**NOTES:**

1. All linear dimensions are in millimeters. Any dimensions in parenthesis are for reference only. Dimensioning and tolerancing per ASME Y14.5M.
2. This drawing is subject to change without notice.

# EXAMPLE BOARD LAYOUT

**DLF0006B**

**VSON - 1 mm max height**

PLASTIC SMALL OUTLINE - NO LEAD

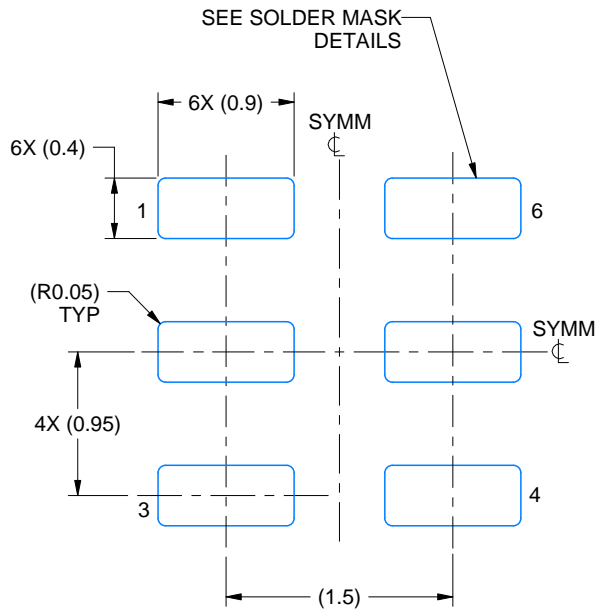

**LAND PATTERN EXAMPLE**  
EXPOSED METAL SHOWN  
SCALE: 20X

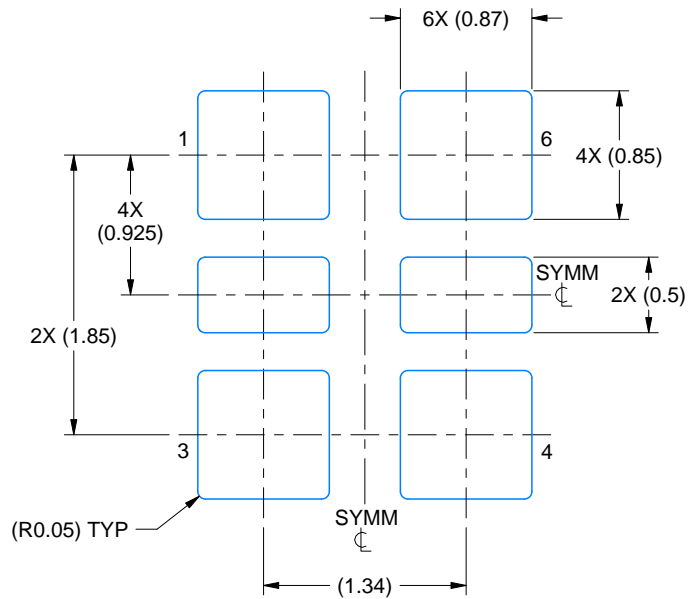

**UNIVERSAL LAND PATTERN EXAMPLE**  
EXPOSED METAL SHOWN  
SCALE: 20X

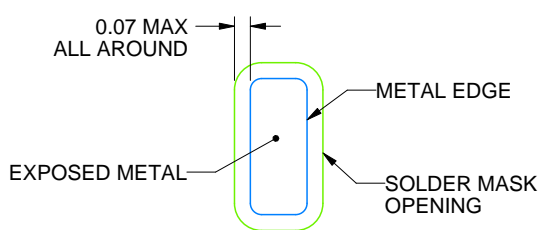

**NON SOLDER MASK DEFINED (PREFERRED)**

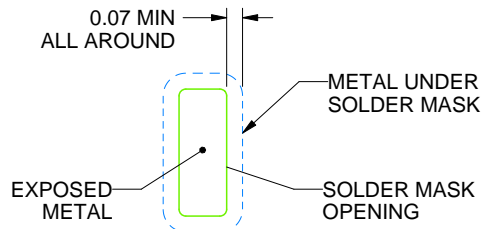

**SOLDER MASK DEFINED**

**SOLDER MASK DETAILS**

4229693/B 12/2023

NOTES: (continued)

3. For more information, see Texas Instruments literature number SLUA271 ([www.ti.com/lit/slua271](http://www.ti.com/lit/slua271)).

# EXAMPLE STENCIL DESIGN

DLF0006B

VSON - 1 mm max height

PLASTIC SMALL OUTLINE - NO LEAD

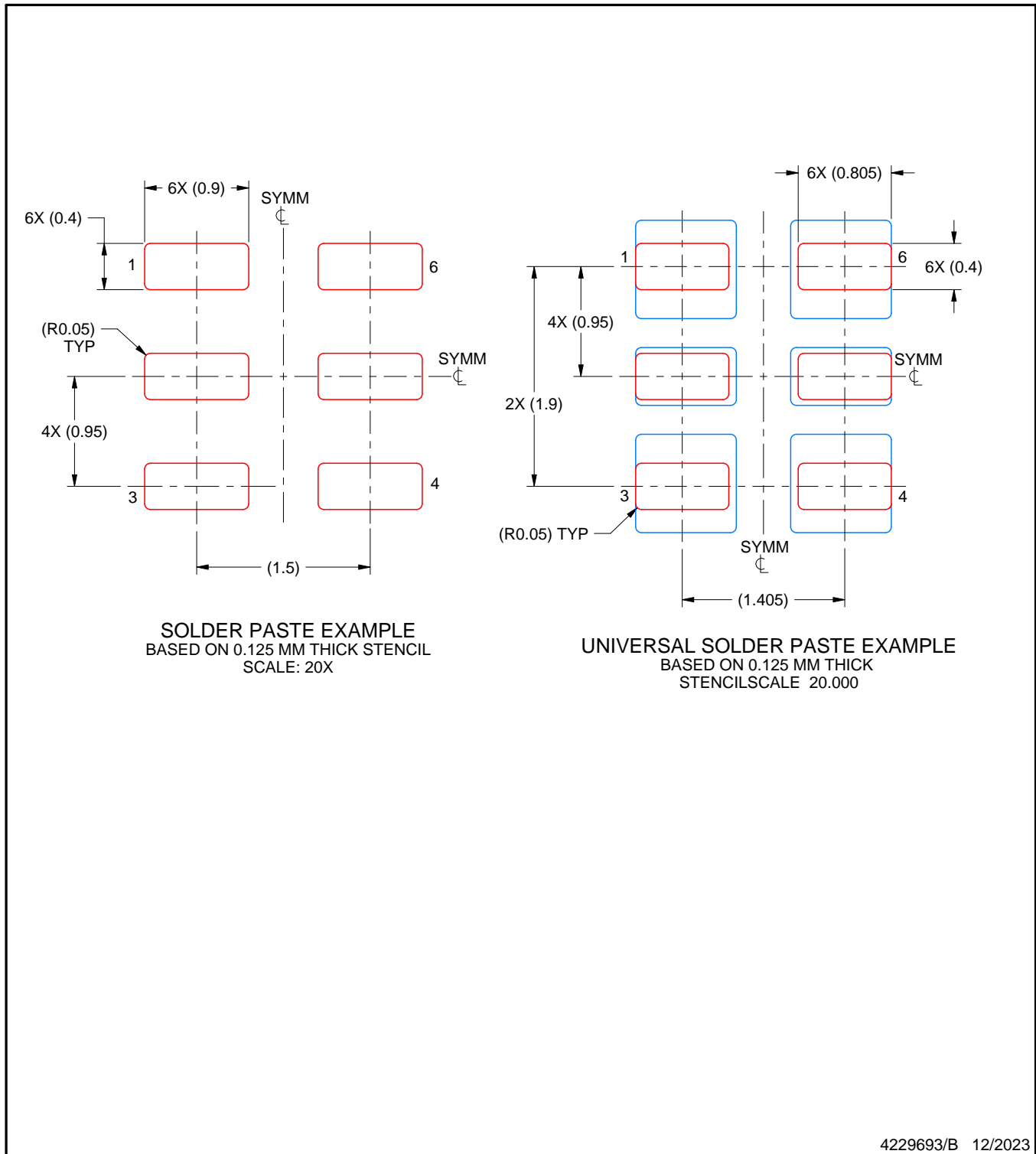

4229693/B 12/2023

NOTES: (continued)

4. Laser cutting apertures with trapezoidal walls and rounded corners may offer better paste release. IPC-7525 may have alternate design recommendations.

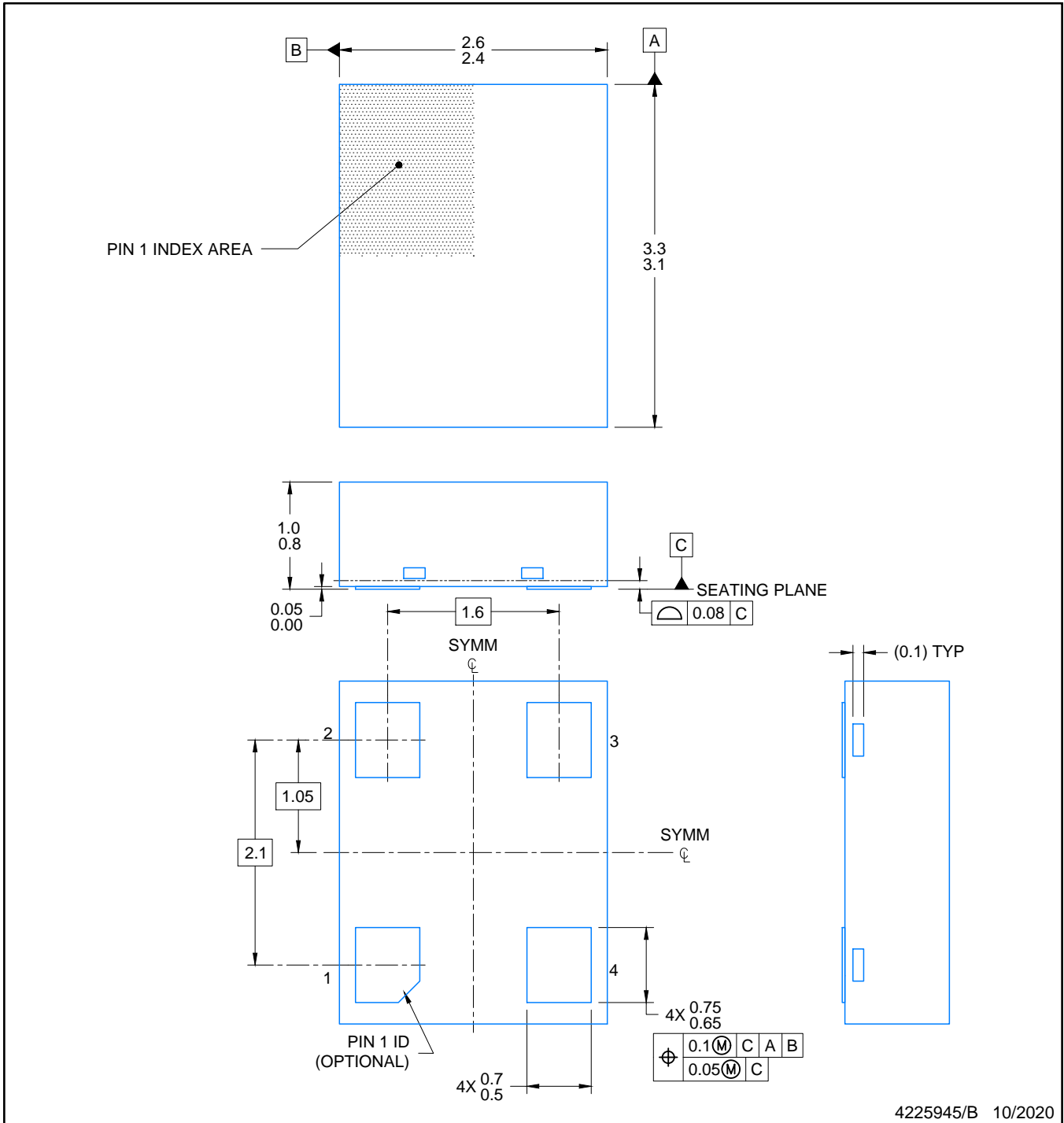

NOTES:

1. All linear dimensions are in millimeters. Any dimensions in parenthesis are for reference only. Dimensioning and tolerancing per ASME Y14.5M.
2. This drawing is subject to change without notice.

# EXAMPLE BOARD LAYOUT

DLE0004A

VSON - 1 mm max height

PLASTIC QUAD FLAT PACK-NO LEAD

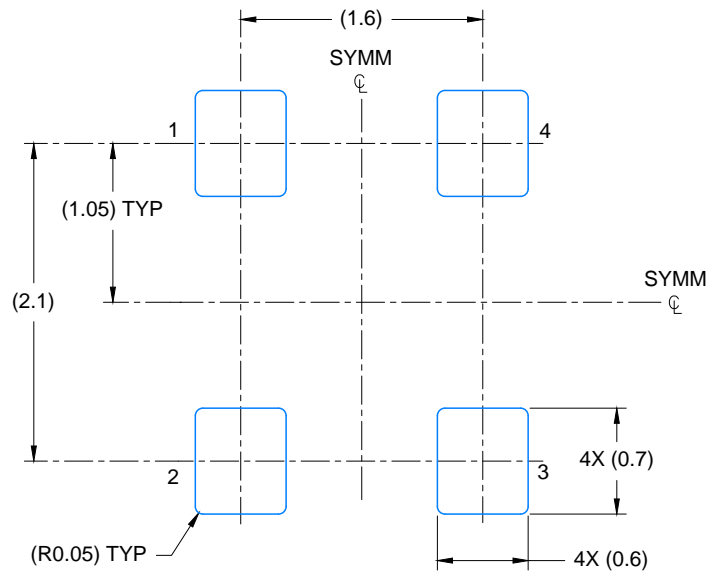

LAND PATTERN EXAMPLE  
EXPOSED METAL SHOWN  
SCALE: 20X

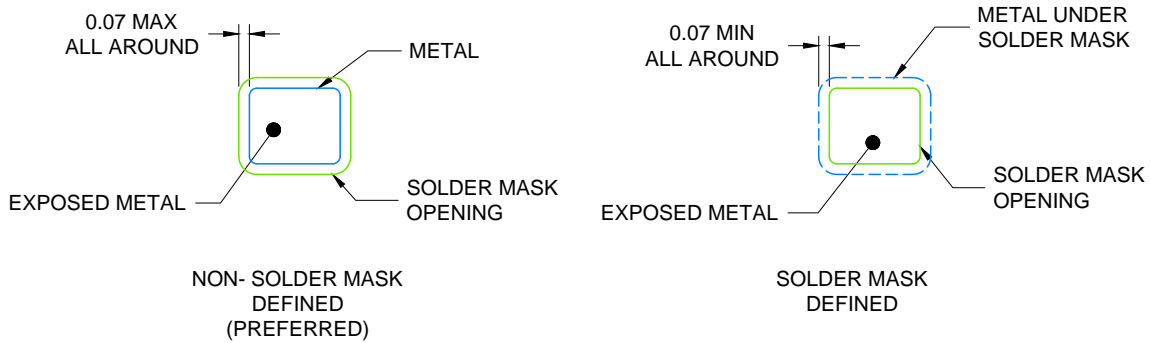

SOLDER MASK DETAILS

4225945/B 10/2020

NOTES: (continued)

- For more information, see Texas Instruments literature number SLUA271 ([www.ti.com/lit/sluea271](http://www.ti.com/lit/sluea271)) .

# EXAMPLE STENCIL DESIGN

VSON - 1 mm max height

DLE0004A

PLASTIC QUAD FLAT PACK-NO LEAD

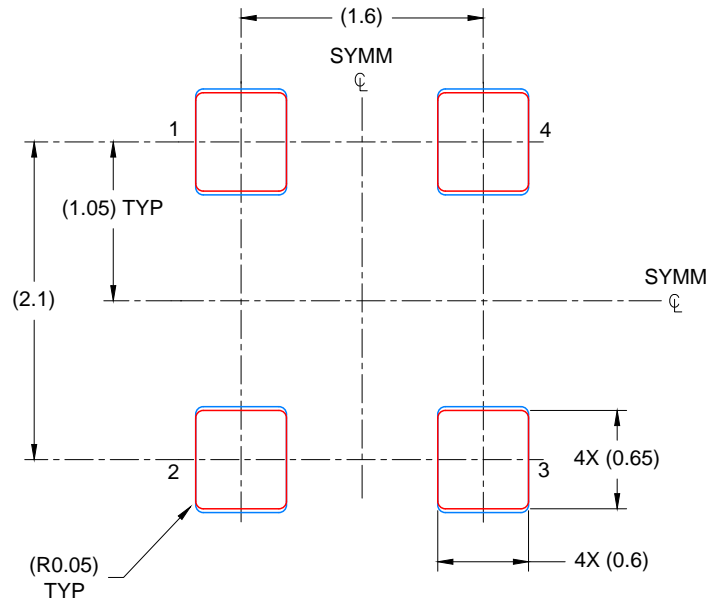

SOLDER PASTE EXAMPLE  
BASED ON 0.125 mm THICK STENCIL  
PRINTED SOLDER COVERAGE BY AREA UNDER PACKAGE  
ALL PADS: 93%  
SCALE: 20X

4225945/B 10/2020

NOTES: (continued)

4. Laser cutting apertures with trapezoidal walls and rounded corners may offer better paste release. IPC-7525 may have alternate design recommendations.



## GENERIC PACKAGE VIEW

**DLF 4**

**VSON - 1 mm max height**

2 x 2.5, 1.65 mm pitch

PLASTIC QUAD FLAT PACK-NO LEAD

This image is a representation of the package family, actual package may vary.  
Refer to the product data sheet for package details.



4231598/A

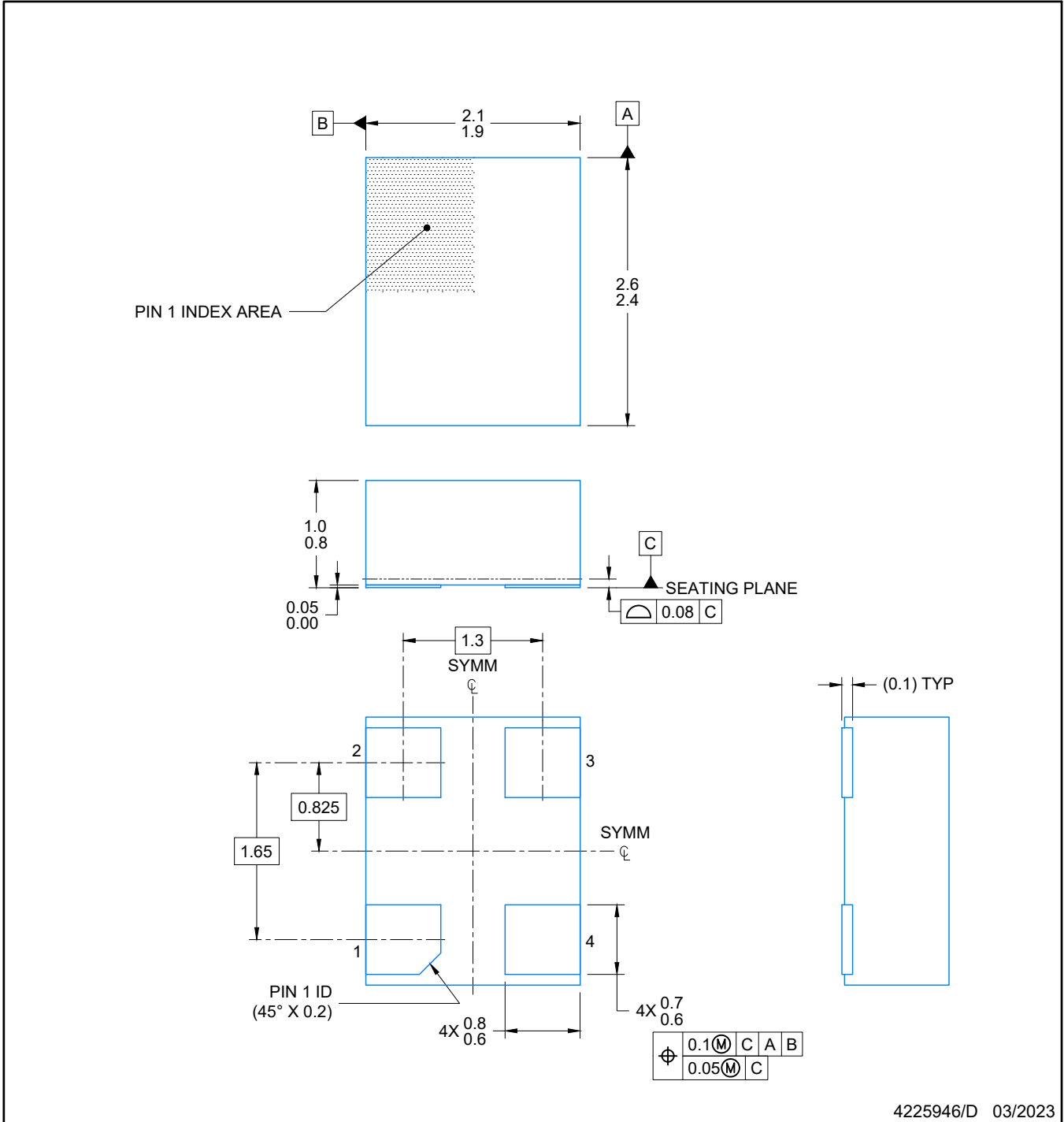

**NOTES:**

1. All linear dimensions are in millimeters. Any dimensions in parenthesis are for reference only. Dimensioning and tolerancing per ASME Y14.5M.
2. This drawing is subject to change without notice.

# EXAMPLE BOARD LAYOUT

**DLF0004A**

**VSON - 1 mm max height**

PLASTIC QUAD FLAT PACK-NO LEAD

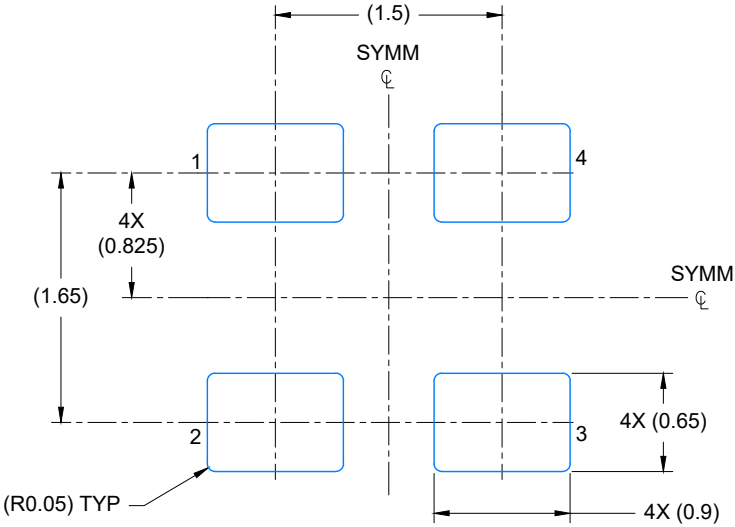

LAND PATTERN EXAMPLE  
EXPOSED METAL SHOWN  
SCALE: 20X

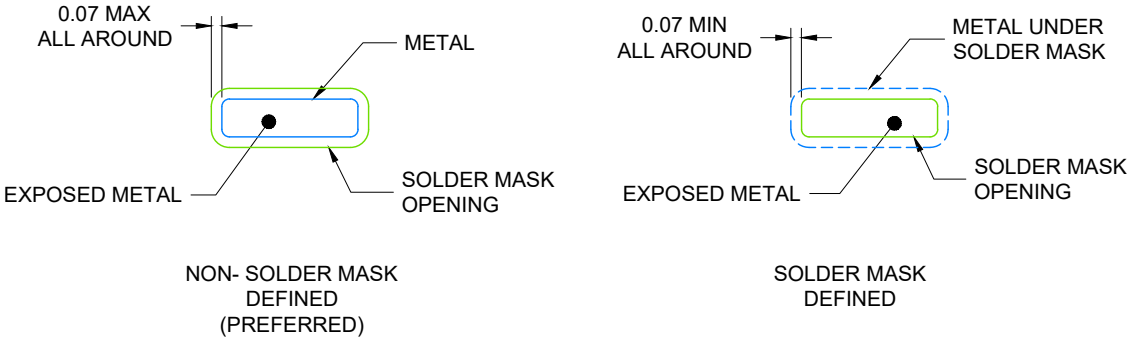

SOLDER MASK DETAILS

4225946/D 03/2023

NOTES: (continued)

- 3. For more information, see Texas Instruments literature number SLUA271 ([www.ti.com/lit/slua271](http://www.ti.com/lit/slua271)).

# EXAMPLE STENCIL DESIGN

**DLF0004A**

**VSON - 1 mm max height**

PLASTIC QUAD FLAT PACK-NO LEAD

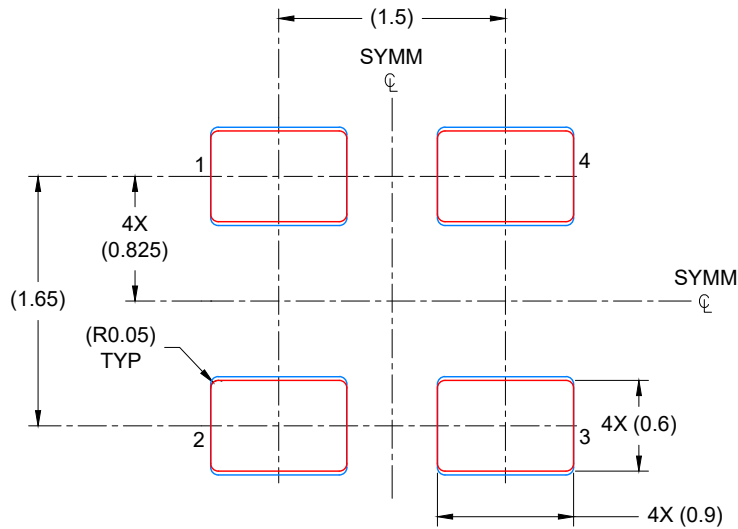

**SOLDER PASTE EXAMPLE**  
BASED ON 0.125 mm THICK STENCIL

PRINTED SOLDER COVERAGE BY AREA UNDER PACKAGE  
PADS 1,3,4 & 6: 92%  
SCALE: 20X

4225946/D 03/2023

NOTES: (continued)

4. Laser cutting apertures with trapezoidal walls and rounded corners may offer better paste release. IPC-7525 may have alternate design recommendations.

## 重要通知和免责声明

TI“按原样”提供技术和可靠性数据（包括数据表）、设计资源（包括参考设计）、应用或其他设计建议、网络工具、安全信息和其他资源，不保证没有瑕疵且不做任何明示或暗示的担保，包括但不限于对适销性、某特定用途方面的适用性或不侵犯任何第三方知识产权的暗示担保。

这些资源可供使用 TI 产品进行设计的熟练开发人员使用。您将自行承担以下全部责任：(1) 针对您的应用选择合适的 TI 产品，(2) 设计、验证并测试您的应用，(3) 确保您的应用满足相应标准以及任何其他功能安全、信息安全、监管或其他要求。

这些资源如有变更，恕不另行通知。TI 授权您仅可将这些资源用于研发本资源所述的 TI 产品的相关应用。严禁以其他方式对这些资源进行复制或展示。您无权使用任何其他 TI 知识产权或任何第三方知识产权。您应全额赔偿因在这些资源的使用中对 TI 及其代表造成的任何索赔、损害、成本、损失和债务，TI 对此概不负责。

TI 提供的产品受 [TI 的销售条款](#) 或 [ti.com](#) 上其他适用条款/TI 产品随附的其他适用条款的约束。TI 提供这些资源并不会扩展或以其他方式更改 TI 针对 TI 产品发布的适用的担保或担保免责声明。

TI 反对并拒绝您可能提出的任何其他或不同的条款。

邮寄地址：Texas Instruments, Post Office Box 655303, Dallas, Texas 75265  
版权所有 © 2025，德州仪器 (TI) 公司