

## LP2981 采用 SOT-23 封装的 100mA 低压降稳压器

### 1 特性

- 输入电压 ( $V_{IN}$ ) 范围：
  - 旧芯片：2.2V 至 16V
  - 新芯片：2.5V 至 16V
- 输出电压 ( $V_{OUT}$ ) 范围：1.2V 至 5.0V
- 输出电压 ( $V_{OUT}$ ) 精度：
  - A 级旧芯片为  $\pm 0.75\%$
  - 标准级旧芯片为  $\pm 1.25\%$
  - 新芯片  $\pm 0.5\%$  (A 级和标准级)
- 负载和温度范围内的输出电压 ( $V_{OUT}$ ) 精度： $\pm 1\%$  (新芯片)
- 输出电流：高达 100mA
- 低  $I_Q$  (新芯片)： $I_{LOAD} = 0\text{mA}$  时为  $69\ \mu\text{A}$
- 低  $I_Q$  (新芯片)： $I_{LOAD} = 100\text{mA}$  时为  $620\ \mu\text{A}$
- 关断电流与温度间的关系：
  - $< 1\ \mu\text{A}$  (旧芯片)
  - $\leq 1.75\ \mu\text{A}$  (新芯片)
- 输出电流限制和热保护
- 使用  $2.2\ \mu\text{F}$  陶瓷电容器实现稳定工作 (新芯片)
- 高 PSRR (新芯片)：
  - 1kHz 频率下为 75dB, 1MHz 频率下为 45dB
- 工作结温： $-40^\circ\text{C}$  至  $125^\circ\text{C}$
- 封装：5 引脚 SOT-23 (DBV)

### 2 应用

- 电表
- 微型逆变器
- 服务器 PSU (12V 输出)
- 家用断路器
- 单轴和多轴伺服驱动器

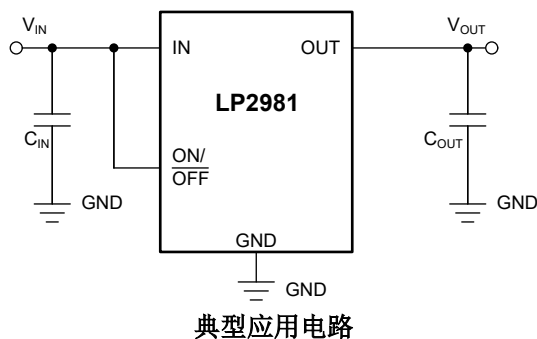

### 3 说明

LP2981 是一款固定输出、低压降 (LDO) 稳压器，支持 2.5V 至 16V 的输入电压范围 (仅限新芯片) 和高达 100mA 的负载电流。LP2981 支持 1.2V 至 5.0V 的输出范围 (新芯片)。

此外，LP2981 (新芯片) 在整个负载和温度范围内具有 1% 的输出精度，可满足低压微控制器 (MCU) 和处理器的需求。

在该新芯片中，高带宽 PSRR 性能在 1kHz 时为 75dB，在 1MHz 时为 45dB，因此有助于衰减上游直流/直流转换器的开关频率，并尽可能地减少后置稳压器滤波。

内部软启动时间和电流限制保护可减小启动期间的浪涌电流，从而尽可能降低输入电容。还包括标准保护特性，例如过流和过热保护。

#### 封装信息

器件型号	封装 <sup>(1)</sup>	封装尺寸 <sup>(2)</sup>
LP2981	SOT-23 (5)	2.90mm x 2.80mm
LP2981A		

(1) 有关详细信息，请参阅节 12。

(2) 封装尺寸 (长 x 宽) 为标称值，并包括引脚 (如适用)。

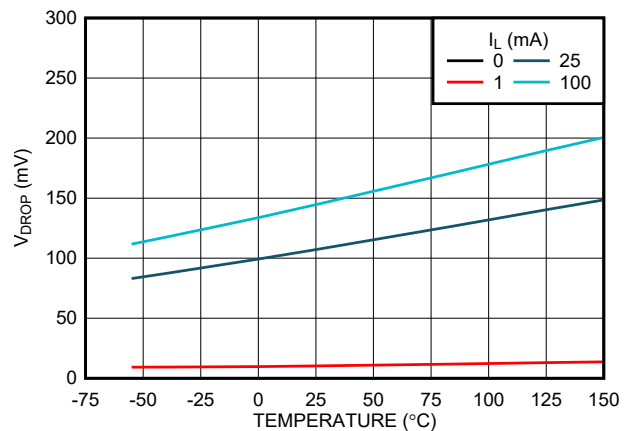

压降电压与温度间的关系 (新芯片)



## Table of Contents

<b>1 特性</b> .....	1	7.1 Application Information.....	17
<b>2 应用</b> .....	1	7.2 Typical Application.....	20
<b>3 说明</b> .....	1	<b>8 Power Supply Recommendations</b> .....	23
<b>4 Pin Configuration and Functions</b> .....	3	<b>9 Layout</b> .....	23
<b>5 Specifications</b> .....	4	9.1 Layout Guidelines.....	23
5.1 Absolute Maximum Ratings.....	4	9.2 Layout Example.....	23
5.2 ESD Ratings.....	4	<b>10 Device and Documentation Support</b> .....	24
5.3 Recommended Operating Conditions.....	4	10.1 Device Nomenclature.....	24
5.4 Thermal Information.....	5	10.2 Documentation Support.....	24
5.5 Electrical Characteristics.....	5	10.3 Receiving Notification of Documentation Updates..	24
5.6 Typical Characteristics.....	8	10.4 支持资源.....	24
<b>6 Detailed Description</b> .....	12	10.5 Trademarks.....	24
6.1 Overview.....	12	10.6 静电放电警告.....	24
6.2 Functional Block Diagram.....	13	10.7 术语表.....	24
6.3 Feature Description.....	13	<b>11 Revision History</b> .....	25
6.4 Device Functional Modes.....	16	<b>12 Mechanical, Packaging, and Orderable Information</b> .....	25
<b>7 Application and Implementation</b> .....	17		

## 4 Pin Configuration and Functions



图 4-1. DBV Package, 5-Pin SOT-23 (Top View)

表 4-1. Pin Functions

PIN		TYPE	DESCRIPTION
NO.	NAME		
1	IN	I	Input supply pin. Use a capacitor with a value of 1 $\mu$ F or larger from this pin to ground. See <a href="#">节 7.1.2.1</a> for more information.
2	GND	—	Common ground (device substrate).
3	ON/OFF	I	Enable pin for the LDO. Driving the ON/OFF pin high enables the device. Driving this pin low disables the device. High and low thresholds are listed in the <a href="#">节 5.5</a> table. Tie this pin to $V_{IN}$ if unused.
4	NC	—	Not internally connected. This pin can be left open or tied to ground for improved thermal performance.
5	OUT	O	Output of the regulator. Use a capacitor with a value of 2.2 $\mu$ F or larger from this pin to ground <sup>(1)</sup> . See <a href="#">节 7.1.2.2</a> for more information.

- (1) The nominal output capacitance must be greater than 1  $\mu$ F. Throughout this document, the nominal derating on these capacitors is 50%. Make sure that the effective capacitance at the pin is greater than 1  $\mu$ F.

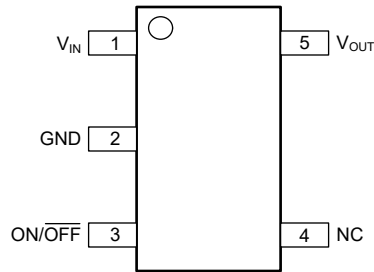
## 5 Specifications

### 5.1 Absolute Maximum Ratings

over operating free-air temperature range (unless otherwise noted)<sup>(1)</sup> <sup>(2)</sup>

		MIN	MAX	UNIT
V <sub>IN</sub>	Continuous input voltage range (for legacy chip)	- 0.3	16	V
	Continuous input voltage range (for new chip)	- 0.3	18	
V <sub>OUT</sub>	Output voltage range (for legacy chip)	- 0.3	9	
	Output voltage range (for new chip)	- 0.3	V <sub>IN</sub> + 0.3 or 9 (whichever is smaller)	
V <sub>ON/OFF</sub>	ON/OFF pin voltage range (for legacy chip)	- 0.3	16	
	ON/OFF pin voltage range (for new chip)	- 0.3	18	
V <sub>IN</sub> - V <sub>OUT</sub>	Input-output voltage (for legacy chip)	- 0.3	16	
	Input-output voltage (for new chip)	- 0.3	18	
Current	Maximum output current	Internally limited		mA
Temperature	Operating junction, T <sub>J</sub>	- 55	150	°C
	Storage, T <sub>stg</sub>	- 65	150	

- (1) Operation outside the *Absolute Maximum Ratings* may cause permanent device damage. *Absolute Maximum Ratings* do not imply functional operation of the device at these or any other conditions beyond those listed under *Recommended Operating Conditions*. If used outside the *Recommended Operating Conditions* but within the *Absolute Maximum Ratings*, the device may not be fully functional, and this may affect device reliability, functionality, performance, and shorten the device lifetime.
- (2) All voltages with respect to GND.

### 5.2 ESD Ratings

			VALUE (Legacy Chip)	VALUE (New Chip)	UNIT
V <sub>(ESD)</sub>	Electrostatic discharge	Human body model (HBM), per ANSI/ESDA/JEDEC JS-001 <sup>(1)</sup>	±2000	±3000	V
		Charged device model (CDM), per JEDEC specification JESD22-C101 <sup>(2)</sup>	±500	±1000	
		Machine model (MM)	±100	N/A	

- (1) JEDEC document JEP155 states that 2-kV HBM allows safe manufacturing with a standard ESD control process.
- (2) JEDEC document JEP157 states that 500-V CDM allows safe manufacturing with a standard ESD control process.

### 5.3 Recommended Operating Conditions

		MIN	NOM	MAX	UNIT
V <sub>IN</sub>	Supply input voltage (for legacy chip)	2.2		16	V
	Supply input voltage (for new chip)	2.5		16	
V <sub>IN</sub> - V <sub>OUT</sub>	Input-output differential (for legacy chip)	0.7		11	
	Input-output differential (for new chip)	0		16	
V <sub>OUT</sub>	Output voltage (for new chip)	1.2		5	
V <sub>ON/OFF</sub>	Enable voltage (for legacy chip)	0		V <sub>IN</sub>	
	Enable voltage (for new chip)	0		16	
I <sub>OUT</sub>	Output current	0		100	
C <sub>IN</sub> <sup>(1)</sup>	Input capacitor		1		μF
C <sub>OUT</sub>	Output capacitor (for legacy chip)	2.2	4.7		
	Output capacitance (for new chip) <sup>(1)</sup>	1	2.2	200	

		MIN	NOM	MAX	UNIT
T <sub>J</sub>	Operating junction temperature	- 40		125	°C

- (1) All capacitor values are assumed to derate to 50% of the nominal capacitor value. Maintain an effective output capacitance of 1  $\mu$ F minimum for stability.

## 5.4 Thermal Information

THERMAL METRIC <sup>(1)</sup>		Legacy Chip <sup>(2)</sup>	New Chip <sup>(2)</sup>	UNIT
		DBV (SOT23-5)	DBV (SOT23-5)	
		5 PINS	5 PINS	
R <sub>θJA</sub>	Junction-to-ambient thermal resistance	205.2	178.6	°C/W
R <sub>θJC(top)</sub>	Junction-to-case (top) thermal resistance	11.83	77.9	°C/W
R <sub>θJB</sub>	Junction-to-board thermal resistance	37.7	47.2	°C/W
ψ <sub>JT</sub>	Junction-to-top characterization parameter	12.2	15.9	°C/W
ψ <sub>JB</sub>	Junction-to-board characterization parameter	33.8	46.9	°C/W

- (1) For more information about traditional and new thermal metrics, see the [Semiconductor and IC Package Thermal Metrics](#) application note.
- (2) Thermal performance results are based on the JEDEC standard of 2s2p PCB configuration. These thermal metric parameters can be further improved by 35-55% based on thermally optimized PCB layout designs. See the analysis of the [Impact of board layout on LDO thermal performance](#) application report.

## 5.5 Electrical Characteristics

specified at T<sub>J</sub> = 25 °C, V<sub>IN</sub> = V<sub>OUT(nom)</sub> + 1.0 V or V<sub>IN</sub> = 2.5 V (whichever is greater), I<sub>OUT</sub> = 1 mA, V<sub>ON/OFF</sub> = 2 V, C<sub>IN</sub> = 1.0  $\mu$ F, and C<sub>OUT</sub> = 2.2  $\mu$ F (unless otherwise noted)

PARAMETER	TEST CONDITIONS		MIN	TYP	MAX	UNIT	
$\Delta V_{OUT}$	Output voltage tolerance	I <sub>L</sub> = 1 mA	Legacy chip (Standard grade)	-	1.25	1.25	%
			Legacy chip (A grade)	-	0.75	0.75	%
			New chip	- 0.5		0.5	%
		1 mA < I <sub>L</sub> < 100 mA	Legacy chip (Standard grade)	- 2.0		2.0	%
			Legacy chip (A grade)	- 1.0		1.0	%
			New chip	- 0.5		0.5	%
		1 mA < I <sub>L</sub> < 100 mA, - 40°C ≤ T <sub>J</sub> ≤ 125°C	Legacy chip (Standard grade)	- 3.5		3.5	%
			Legacy chip (A grade)	- 2.5		2.5	%
			New chip	- 1		1	%
$\Delta V_{OUT(\Delta V_{IN})}$	Line regulation	V <sub>O(NOM)</sub> + 1 V ≤ V <sub>IN</sub> ≤ 16 V	Legacy chip	0.007	0.014	%V	
			New chip	0.002	0.014		
		V <sub>O(NOM)</sub> + 1 V ≤ V <sub>IN</sub> ≤ 16 V, - 40°C ≤ T <sub>J</sub> ≤ 125°C	Legacy chip	0.007	0.032		
			New chip	0.002	0.032		
$\Delta V_{OUT(\Delta I_{LOAD})}$	Load regulation	1 mA < I <sub>L</sub> < 100 mA, - 40°C ≤ T <sub>J</sub> ≤ 125°C, V <sub>IN</sub> = V <sub>O(NOM)</sub> +0.5 V	New chip	0.1	0.5	%/A	

specified at  $T_J = 25\text{ }^\circ\text{C}$ ,  $V_{IN} = V_{OUT(nom)} + 1.0\text{ V}$  or  $V_{IN} = 2.5\text{ V}$  (whichever is greater),  $I_{OUT} = 1\text{ mA}$ ,  $V_{ON/OFF} = 2\text{ V}$ ,  $C_{IN} = 1.0\text{ }\mu\text{F}$ , and  $C_{OUT} = 2.2\text{ }\mu\text{F}$  (unless otherwise noted)

PARAMETER		TEST CONDITIONS	MIN	TYP	MAX	UNIT	
$V_{IN} - V_{OUT}$	Dropout voltage <sup>(1)</sup>	$I_{OUT} = 0\text{ mA}$	Legacy chip	1	3	mV	
			New chip	1	2.75		
		$I_{OUT} = 0\text{ mA}, -40^\circ\text{C} \leq T_J \leq 125^\circ\text{C}$	Legacy chip		5		
			New chip		3		
		$I_{OUT} = 1\text{ mA}$	Legacy chip	7	10		
			New chip	11.5	14		
		$I_{OUT} = 1\text{ mA}, -40^\circ\text{C} \leq T_J \leq 125^\circ\text{C}$	Legacy chip		15		
			New chip		17		
		$I_{OUT} = 25\text{ mA}$	Legacy chip	70	100		
			New chip	110	132		
		$I_{OUT} = 25\text{ mA}, -40^\circ\text{C} \leq T_J \leq 125^\circ\text{C}$	Legacy chip		150		
			New chip		167		
		$I_{OUT} = 100\text{ mA}$	Legacy chip	200	250		
			New chip	160	175		
		$I_{OUT} = 100\text{ mA}, -40^\circ\text{C} \leq T_J \leq 125^\circ\text{C}$	Legacy chip		375		
			New chip		218		
$I_{GND}$	GND pin current	$I_{OUT} = 0\text{ mA}$	Legacy chip	65	95	$\mu\text{A}$	
			New chip	69	95		
		$I_{OUT} = 0\text{ mA}, -40^\circ\text{C} \leq T_J \leq 125^\circ\text{C}$	Legacy chip		125		
			New chip		123		
		$I_{OUT} = 1\text{ mA}$	Legacy chip	80	110		
			New chip	78	110		
		$I_{OUT} = 1\text{ mA}, -40^\circ\text{C} \leq T_J \leq 125^\circ\text{C}$	Legacy chip		170		
			New chip		140		
		$I_{OUT} = 25\text{ mA}$	Legacy chip	200	300		
			New chip	225	295		
		$I_{OUT} = 25\text{ mA}, -40^\circ\text{C} \leq T_J \leq 125^\circ\text{C}$	Legacy chip		550		
			New chip		345		
		$I_{OUT} = 100\text{ mA}$	Legacy chip	600	1000		
			New chip	620	790		
		$I_{OUT} = 100\text{ mA}, -40^\circ\text{C} \leq T_J \leq 125^\circ\text{C}$	Legacy chip		1700		
			New chip		950		
$V_{ON/OFF} < 0.3\text{ V}, V_{IN} = 16\text{ V}$	Legacy chip	0.01	0.8				
	New chip	1.25	1.75				
$V_{ON/OFF} < 0.15\text{ V}, V_{IN} = 16\text{ V}, -40^\circ\text{C} \leq T_J \leq 105^\circ\text{C}$	Legacy chip	0.05	2				
			5				
$V_{ON/OFF} < 0.15\text{ V}, V_{IN} = 16\text{ V}, -40^\circ\text{C} \leq T_J \leq 125^\circ\text{C}$	New chip	1.12	2.75				
$V_{UVLO+}$	Rising bias supply UVLO	$V_{IN}$ rising, $-40^\circ\text{C} \leq T_J \leq 125^\circ\text{C}$		2.2	2.4	V	
$V_{UVLO-}$	Falling bias supply UVLO	$V_{IN}$ falling, $-40^\circ\text{C} \leq T_J \leq 125^\circ\text{C}$	New chip	1.9			
$V_{UVLO(HYST)}$	UVLO hysteresis	$-40^\circ\text{C} \leq T_J \leq 125^\circ\text{C}$		0.130			
$I_{O(SC)}$	Short Output Current	$R_L = 0\text{ }\Omega$ (steady state)	Legacy chip	150		mA	
			New chip	150			

specified at  $T_J = 25^\circ\text{C}$ ,  $V_{IN} = V_{OUT(nom)} + 1.0\text{ V}$  or  $V_{IN} = 2.5\text{ V}$  (whichever is greater),  $I_{OUT} = 1\text{ mA}$ ,  $V_{ON/OFF} = 2\text{ V}$ ,  $C_{IN} = 1.0\ \mu\text{F}$ , and  $C_{OUT} = 2.2\ \mu\text{F}$  (unless otherwise noted)

PARAMETER		TEST CONDITIONS	MIN	TYP	MAX	UNIT	
$V_{ON/OFF}$	ON/OFF input voltage	Low = Output OFF	Legacy chip	0.5		V	
			New chip	0.72			
		Low = Output OFF, $V_{OUT} + 1 \leq V_{IN} \leq 16\text{ V}$ , $-40^\circ\text{C} \leq T_J \leq 125^\circ\text{C}$	Legacy chip		0.15		
			New chip		0.15		
		High = Output ON	Legacy chip	1.4			
			New chip	0.85			
High = Output ON, $V_{OUT} + 1 \leq V_{IN} \leq 16\text{ V}$ , $-40^\circ\text{C} \leq T_J \leq 125^\circ\text{C}$	Legacy chip	1.6					
	New chip	1.6					
$I_{ON/OFF}$	ON/OFF input current	$V_{ON/OFF} = 0\text{ V}$	Legacy chip	0.01		$\mu\text{A}$	
			New chip	0.42			
		$V_{ON/OFF} = 0\text{ V}$ , $V_{OUT} + 1 \leq V_{IN} \leq 16\text{ V}$ , $-40^\circ\text{C} \leq T_J \leq 125^\circ\text{C}$	Legacy chip		-1		
			New chip		-0.9		
		$V_{ON/OFF} = 5\text{ V}$	Legacy chip	5			
			New chip	0.011			
$V_{ON/OFF} = 5\text{ V}$ , $V_{OUT} + 1 \leq V_{IN} \leq 16\text{ V}$ , $-40^\circ\text{C} \leq T_J \leq 125^\circ\text{C}$	Legacy chip		15				
	New chip		2.20				
$I_{O(PK)}$	Peak output current	$V_{OUT} \geq V_{O(NOM)} - 5\%$ (steady state)	Legacy chip	400		mA	
			New chip	350			
$\Delta V_O / \Delta V_{IN}$	Ripple Rejection	$f = 1\text{ kHz}$ , $C_{OUT} = 10\ \mu\text{F}$	Legacy chip	63		dB	
			New chip	75			
$V_n$	Output noise voltage	Bandwidth = 300 Hz to 50 kHz, $C_{OUT} = 2.2\ \mu\text{F}$ , $V_{OUT} = 3.3\text{ V}$ , $I_{LOAD} = 150\text{ mA}$	Legacy chip	160		$\mu\text{VRMS}$	
		Bandwidth = 300 Hz to 50 kHz, $C_{OUT} = 2.2\ \mu\text{F}$ , $V_{OUT} = 3.3\text{ V}$ , $I_{LOAD} = 150\text{ mA}$	New chip	140			
$T_{sd+}$	Thermal shutdown threshold	Shutdown, temperature increasing	New chip	170		$^\circ\text{C}$	
$T_{sd-}$		Reset, temperature decreasing		150			

- (1) Dropout voltage ( $V_{DO}$ ) is defined as the input-to-output differential at which the output voltage drops 100 mV below the value measured with a 1-V differential.  $V_{DO}$  is measured with  $V_{IN} = V_{OUT(nom)} - 100\text{ mV}$  for fixed output devices.

## 5.6 Typical Characteristics

Unless otherwise specified:  $T_A = 25^\circ\text{C}$ ,  $V_{IN} = V_{O(NOM)} + 1\text{ V}$ ,  $C_{OUT} = 10\ \mu\text{F}$ ,  $C_{IN} = 1\ \mu\text{F}$  all voltage options, ON/OFF pin tied to  $V_{IN}$ .



图 5-1. Output Voltage vs Load Current (Legacy Chip)



图 5-2. Output Voltage vs Load Current (New Chip)

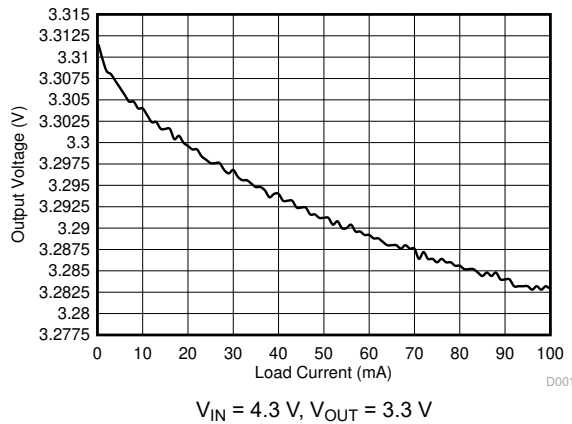

图 5-3. Load Regulation vs Temperature (New Chip)

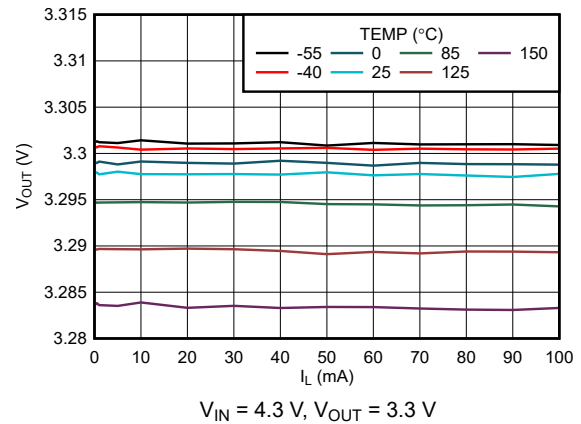

图 5-4. Output Voltage vs Temperature (New Chip)

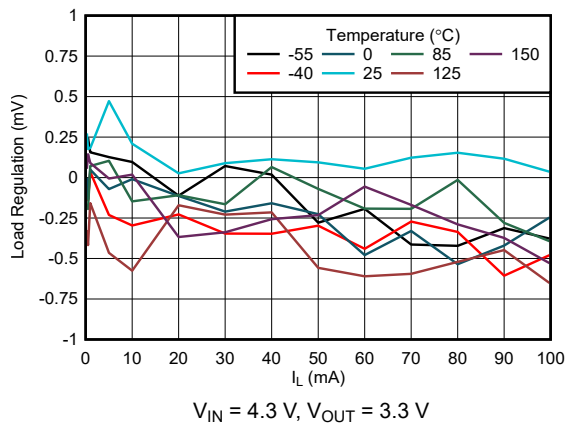

图 5-5. Output Voltage vs  $V_{IN}$  (New Chip)

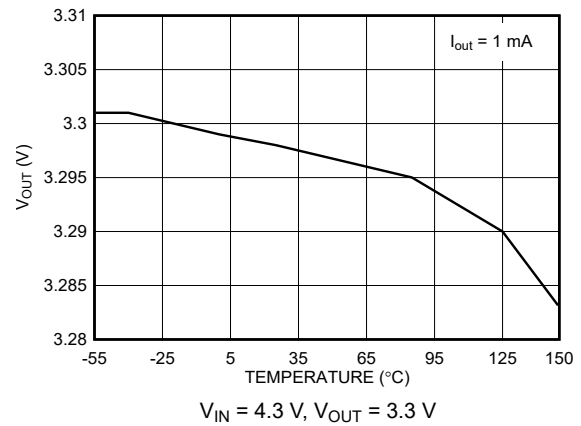

图 5-6. Output Voltage vs  $V_{IN}$  and Temperature (New Chip)



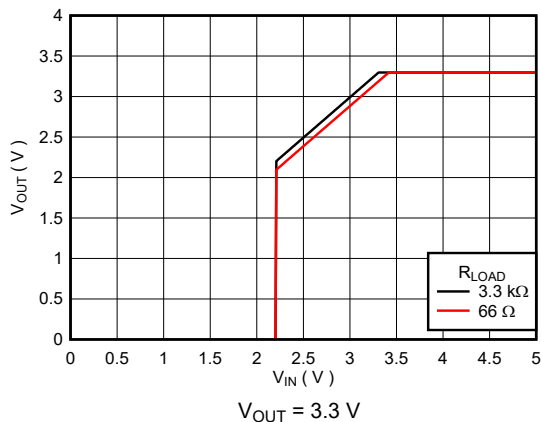

图 5-7. Line Regulation vs  $V_{IN}$  and Temperature (New Chip)

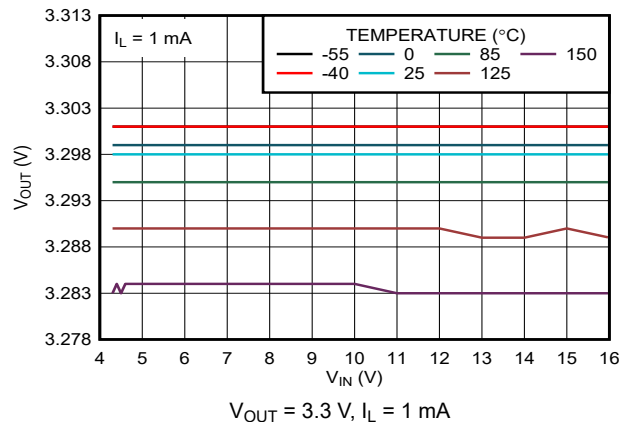

图 5-8. Dropout Voltage ( $V_{DO}$ ) vs Temperature (New Chip)

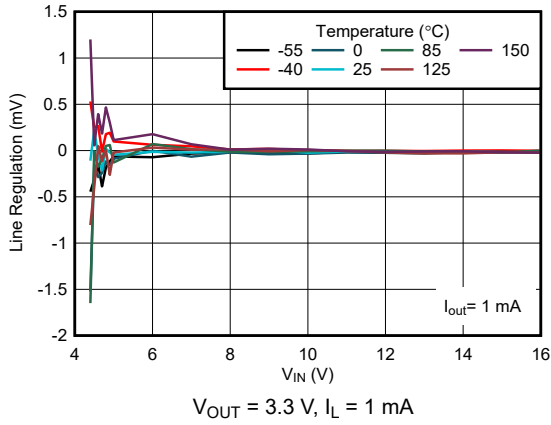

图 5-9. Dropout Voltage ( $V_{DO}$ ) vs Load Current (New Chip)

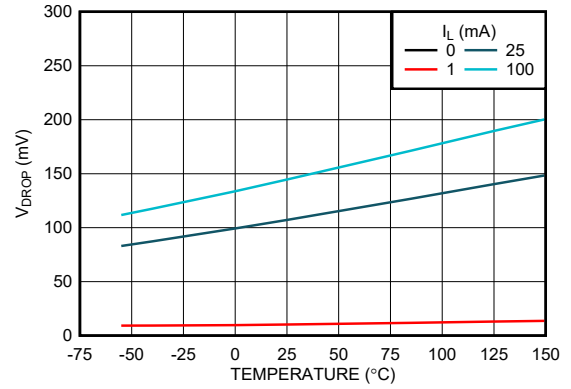

图 5-10. Ground Pin Current ( $I_{GND}$ ) vs Temperature (New Chip)

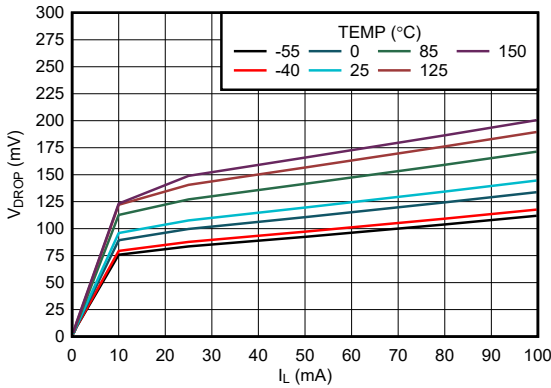

图 5-11. Ground Pin Current ( $I_{GND}$ ) vs Load Current (New Chip)

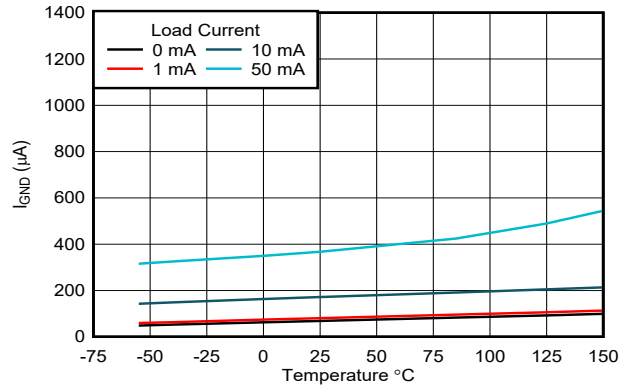

图 5-12. Input Current vs Input Voltage ( $V_{IN}$ ) (New Chip)

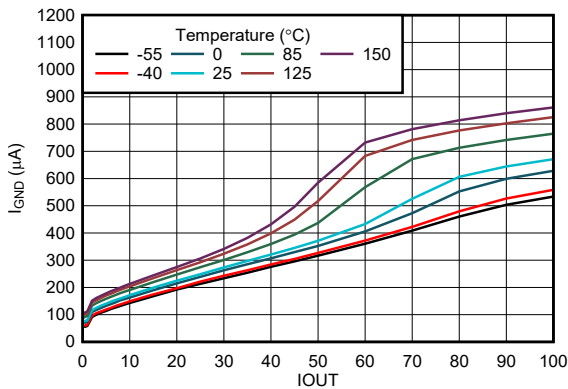

图 5-13. Line Transient Response (New Chip)

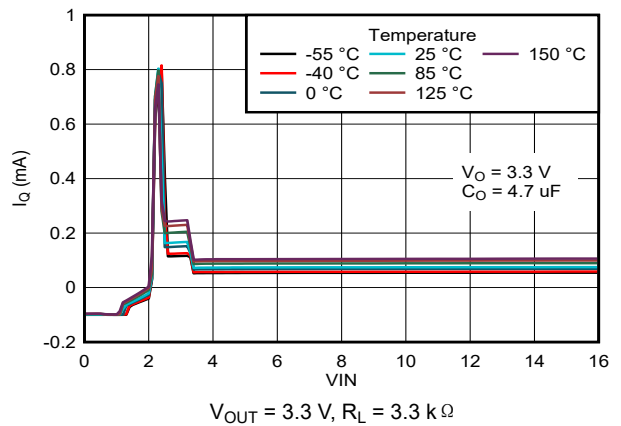

图 5-14. Line Transient Response (New Chip)

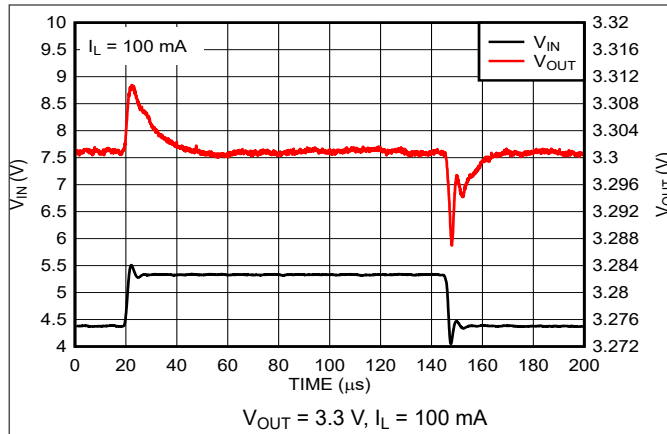

图 5-15. Load Transient Response (New Chip)

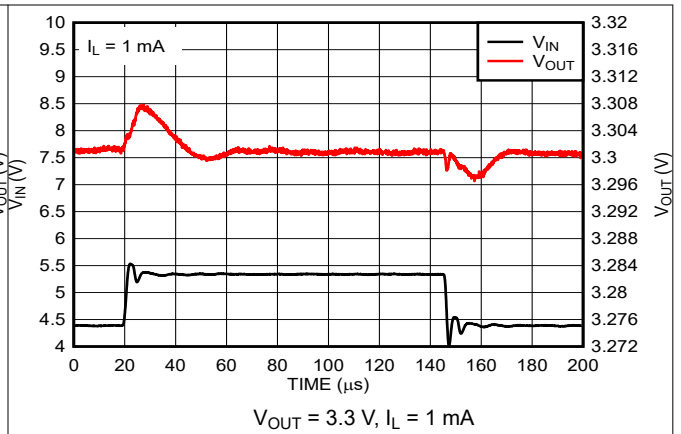

图 5-16. Short Circuit Current vs Time (New Chip)

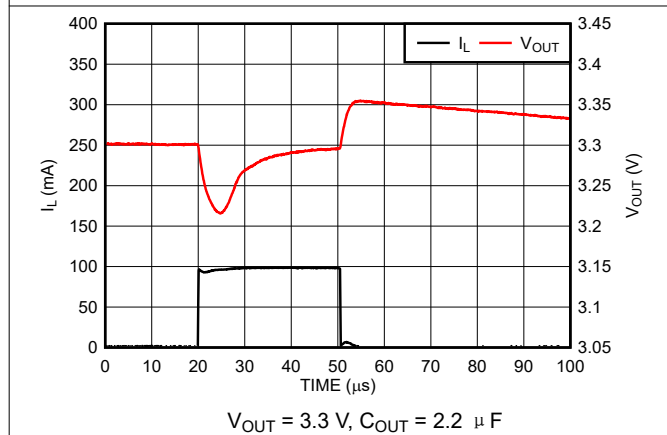

图 5-17. Short Circuit Current vs Time (New Chip)

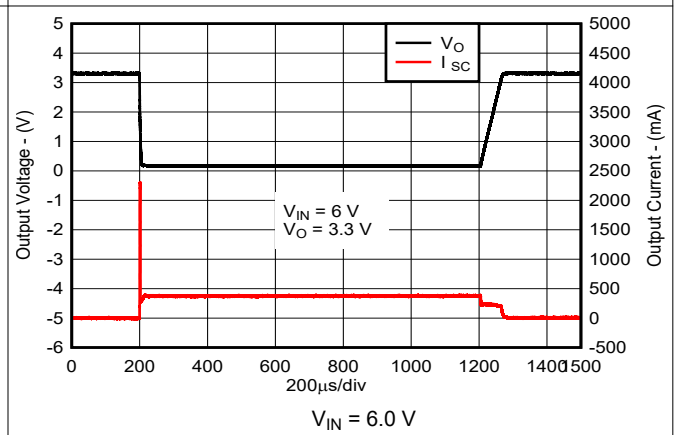

图 5-18. Instantaneous Short Circuit Current vs Temperature (New Chip)

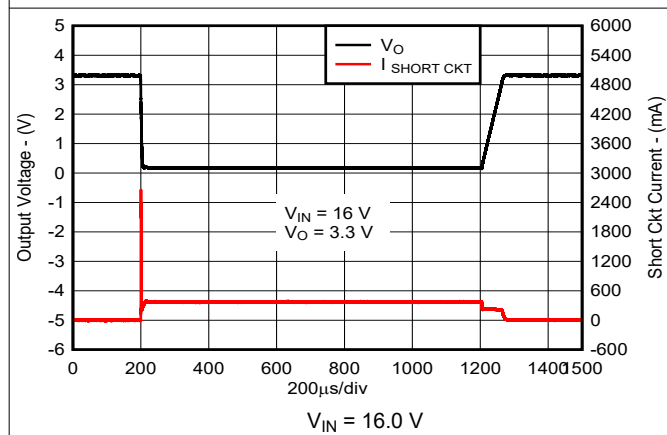

图 5-19. Short Circuit Current vs Output Voltage ( $V_{OUT}$ ) (New Chip)

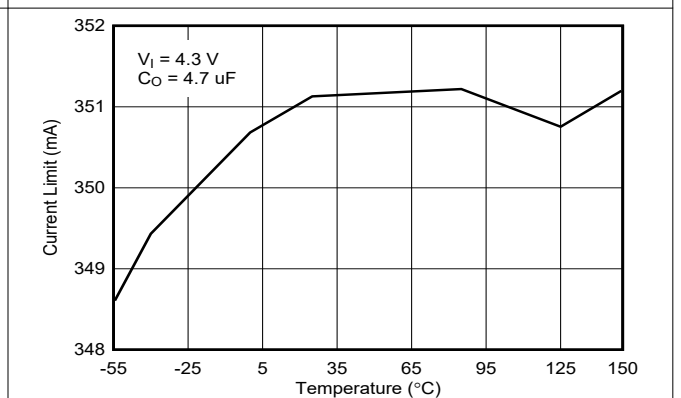

图 5-20. Ripple Rejection vs Load Current ( $I_L$ ) and Frequency (New Chip)

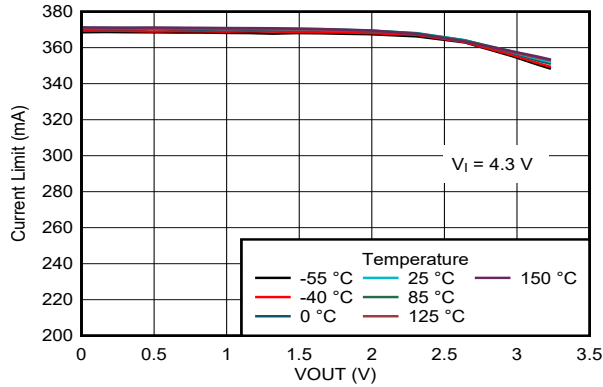

图 5-21. Ripple Rejection vs Output Capacitor ( $C_L$ ) and Frequency (New Chip)

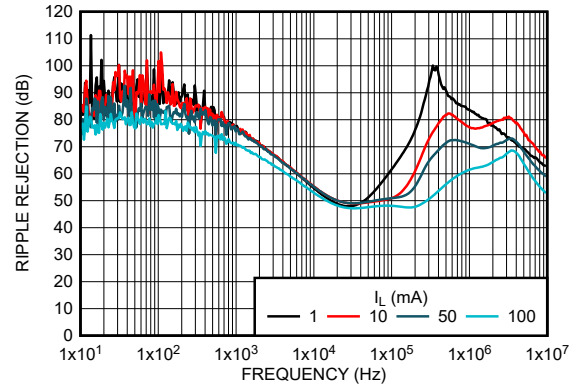

图 5-22. Output Noise Density vs Load Current ( $I_L$ ) Frequency (New Chip)

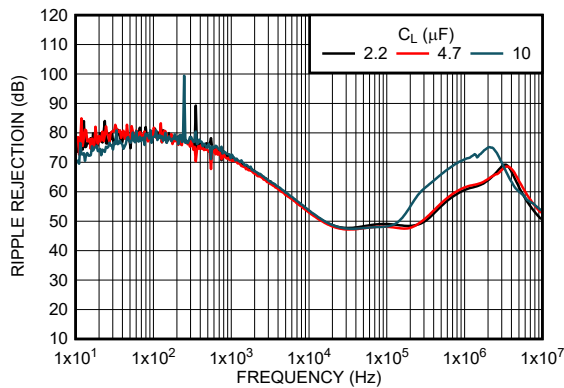

图 5-23. Output Noise Density vs Output Capacitor ( $C_L$ ) Frequency (New Chip)

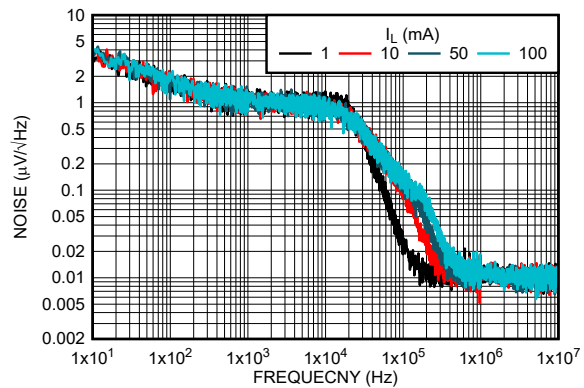

图 5-24. Output Reverse Leakage vs Temperature (New Chip)

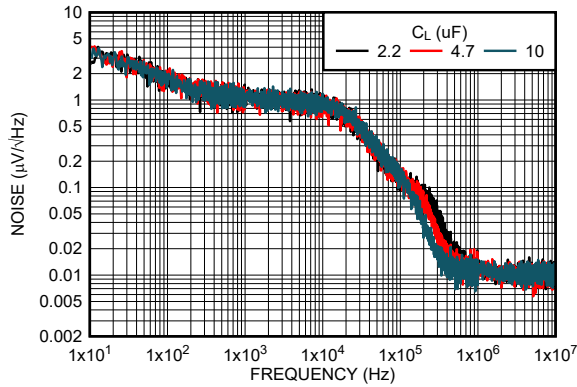

图 5-25. Turn-on Waveform (New Chip)

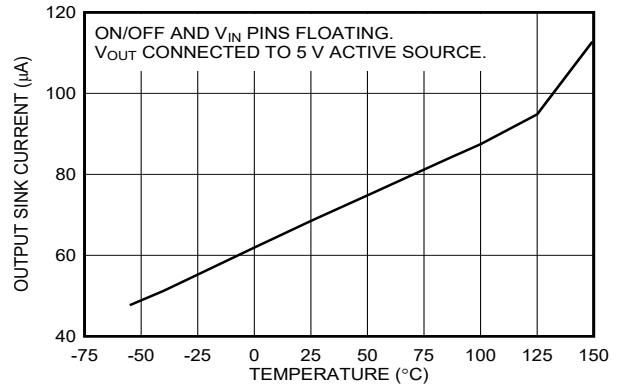

图 5-26. Turn-off Waveform (New Chip)

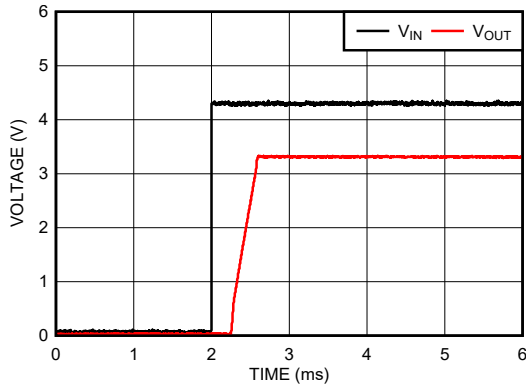

图 5-27. ON/ OFF Pin Current vs  $V_{ON/OFF}$  (New Chip)

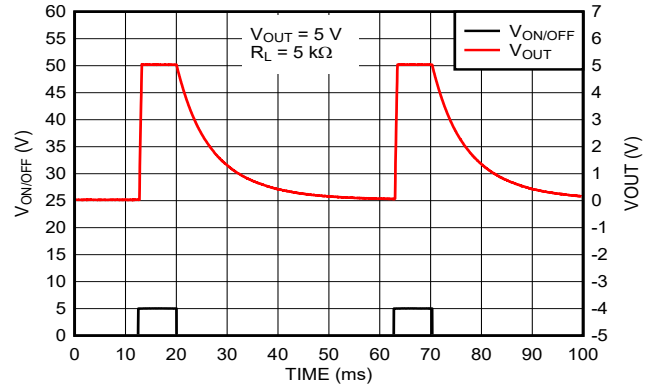

图 5-28. ON/ OFF Pin Current vs  $V_{ON/OFF}$  (New Chip)

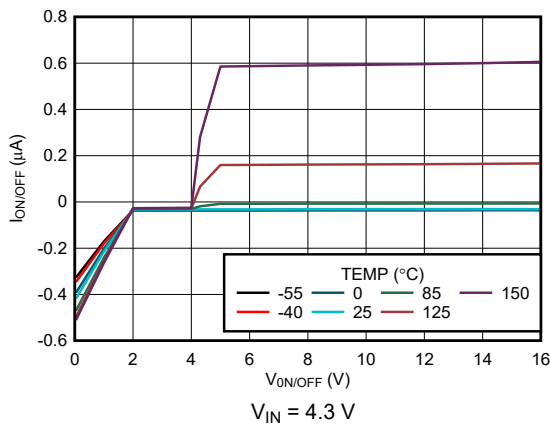

图 5-29. ON/ OFF Threshold vs Temperature (New Chip)

## 6 Detailed Description

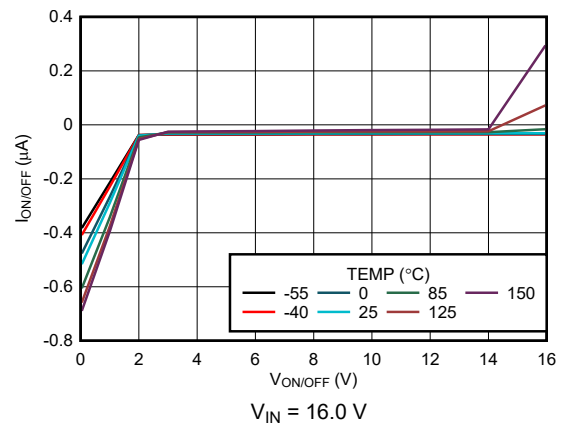
### 6.1 Overview

The LP2981 and LP2981A are fixed-output, high PSRR, low-dropout regulators that offer exceptional, cost-effective performance for both portable and non-portable applications. The LP2981-N has an output tolerance of 1% across line, load, and temperature variation (for the new chip) and is capable of delivering 100 mA of continuous load current.

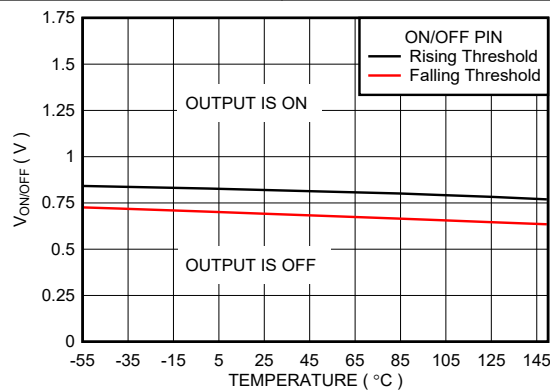
This device features integrated overcurrent protection, thermal shutdown, output enable, and internal output pulldown and has a built-in soft-start mechanism for controlled inrush current. This device delivers excellent line and load transient performance. The operating ambient temperature range of the device is  $-40^{\circ}\text{C}$  to  $125^{\circ}\text{C}$ .

## 6.2 Functional Block Diagram

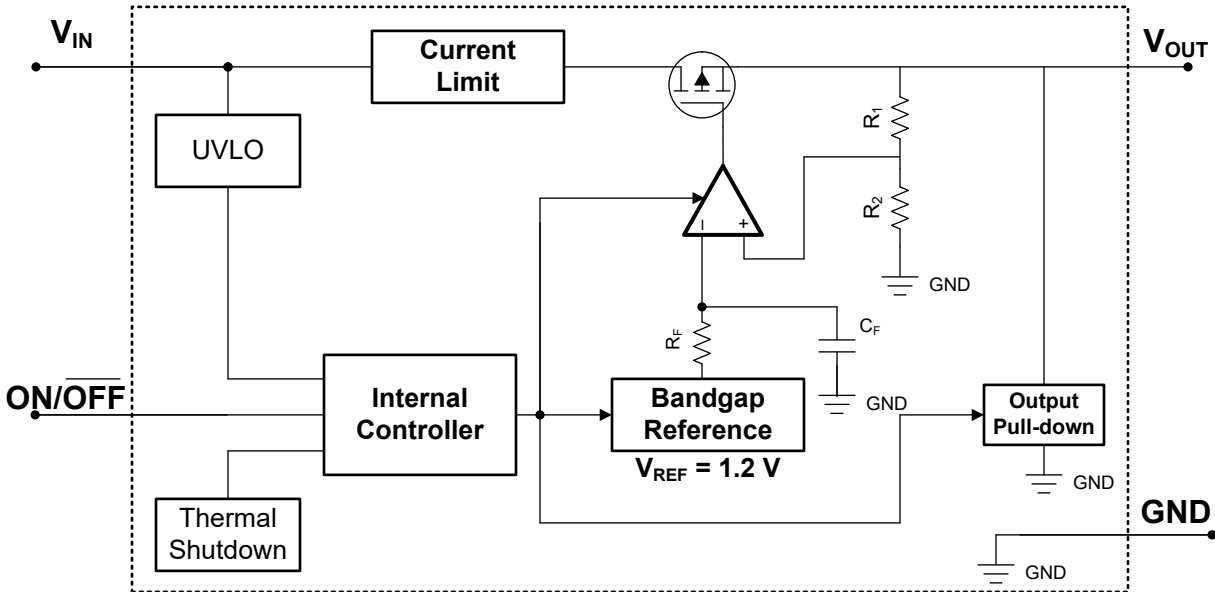

## 6.3 Feature Description

### 6.3.1 Output Enable

The ON/ $\overline{\text{OFF}}$  pin for the device is an active-high pin. The output voltage is enabled when the voltage of the ON/ $\overline{\text{OFF}}$  pin is greater than the high-level input voltage of the ON/ $\overline{\text{OFF}}$  pin and disabled when the ON/ $\overline{\text{OFF}}$  pin voltage is less than the low-level input voltage of the ON/ $\overline{\text{OFF}}$  pin. If independent control of the output voltage is not needed, connect the ON/ $\overline{\text{OFF}}$  pin to the input of the device.

For the new chip, the device has an internal pulldown circuit that activates when the device is disabled by pulling the ON/ $\overline{\text{OFF}}$  pin voltage lower than the low-level input voltage of the ON/ $\overline{\text{OFF}}$  pin to actively discharge the output voltage.

### 6.3.2 Dropout Voltage

Dropout voltage ( $V_{\text{DO}}$ ) is defined as the input voltage minus the output voltage ( $V_{\text{IN}} - V_{\text{OUT}}$ ) at the rated output current ( $I_{\text{RATED}}$ ), where the pass transistor is fully on.  $I_{\text{RATED}}$  is the maximum  $I_{\text{OUT}}$  listed in the 节 5.3 table. The pass transistor is in the ohmic or triode region of operation, and acts as a switch. The dropout voltage indirectly specifies a minimum input voltage greater than the nominal programmed output voltage at which the output voltage is expected to stay in regulation. If the input voltage falls to less than the nominal output regulation, then the output voltage falls as well.

For a CMOS regulator, the dropout voltage is determined by the drain-source on-state resistance ( $R_{\text{DS(ON)}}$ ) of the pass transistor. Therefore, if the linear regulator operates at less than the rated current, the dropout voltage for that current scales accordingly. The following equation calculates the  $R_{\text{DS(ON)}}$  of the device.

$$R_{\text{DS(ON)}} = \frac{V_{\text{DO}}}{I_{\text{RATED}}} \quad (1)$$

### 6.3.3 Current Limit

The device has an internal current limit circuit that protects the regulator during transient high-load current faults or shorting events. The current limit is a brick-wall scheme. In a high-load current fault, the brick-wall scheme limits the output current to the current limit ( $I_{CL}$ ).  $I_{CL}$  is listed in the [节 5.5](#) table.

The output voltage is not regulated when the device is in current limit. When a current limit event occurs, the device begins to heat up because of the increase in power dissipation. When the device is in brick-wall current limit, the pass transistor dissipates power  $[(V_{IN} - V_{OUT}) \times I_{CL}]$ . If thermal shutdown is triggered, the device turns off. After the device cools down, the internal thermal shutdown circuit turns the device back on. If the output current fault condition continues, the device cycles between current limit and thermal shutdown. For more information on current limits, see the [Know Your Limits](#) application note.

图 6-1 shows a diagram of the current limit.



图 6-1. Current Limit

### 6.3.4 Undervoltage Lockout (UVLO)

For the new chip, the device has an independent undervoltage lockout (UVLO) circuit that monitors the input voltage, allowing a controlled and consistent turn on and off of the output voltage. To prevent the device from turning off if the input drops during turn on, the UVLO has hysteresis as specified in the [节 5.5](#) table.

### 6.3.5 Thermal Shutdown

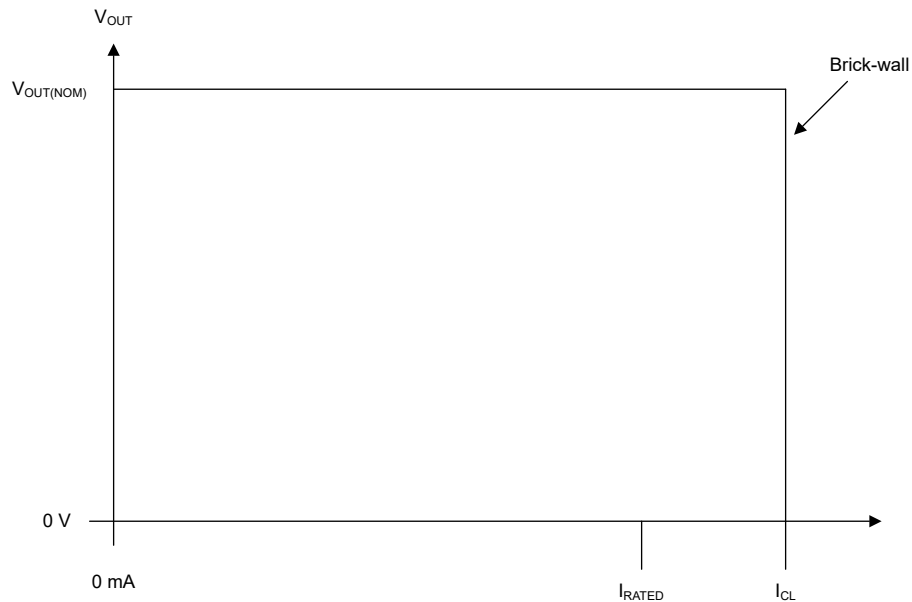
The device contains a thermal shutdown protection circuit to disable the device when the junction temperature ( $T_J$ ) of the pass transistor rises to  $T_{SD(shutdown)}$  (typical). Thermal shutdown hysteresis makes sure that the device resets (turns on) when the temperature falls to  $T_{SD(reset)}$  (typical). Thermal shutdown circuit specifications are defined in [节 5.5](#).

The thermal time-constant of the semiconductor die is fairly short, thus the device can cycle on and off when thermal shutdown is reached until power dissipation is reduced. Power dissipation during start up can be high from large  $V_{IN} - V_{OUT}$  voltage drops across the device or from high inrush currents charging large output capacitors. Under some conditions, the thermal shutdown protection disables the device before start-up completes.

For reliable operation, limit the junction temperature to the maximum listed in the [节 5.3](#) table. Operation above this maximum temperature causes the device to exceed operational specifications. Although the internal

protection circuitry of the device is designed to protect against thermal overall conditions, this circuitry is not intended to replace proper heat sinking. Continuously running the device into thermal shutdown or above the maximum recommended junction temperature reduces long-term reliability.

### 6.3.6 Output Pulldown

The new chip has an output pulldown circuit. The output pulldown activates in the following conditions:

- When the device is disabled ( $V_{ON/OFF} < V_{ON/OFF(LOW)}$ )
- If  $1.0\text{ V} < V_{IN} < V_{UVLO}$

Do not rely on the output pulldown circuit for discharging a large amount of output capacitance after the input supply has collapsed because reverse current can flow from the output to the input. This reverse current flow can cause damage to the device. See the [节 7.1.5](#) section for more details.

## 6.4 Device Functional Modes

### 6.4.1 Device Functional Mode Comparison

表 6-1 shows the conditions that lead to the different modes of operation. See the [节 5.5](#) table for parameter values.

表 6-1. Device Functional Mode Comparison

OPERATING MODE	PARAMETER			
	$V_{IN}$	$V_{ON/OFF}$	$I_{OUT}$	$T_J$
Normal operation	$V_{IN} > V_{OUT(nom)} + V_{DO}$ and $V_{IN} > V_{IN(min)}$	$V_{ON/OFF} > V_{ON/OFF(HI)}$	$I_{OUT} < I_{OUT(max)}$	$T_J < T_{SD(shutdown)}$
Dropout operation	$V_{IN(min)} < V_{IN} < V_{OUT(nom)} + V_{DO}$	$V_{ON/OFF} > V_{ON/OFF(HI)}$	$I_{OUT} < I_{OUT(max)}$	$T_J < T_{SD(shutdown)}$
Disabled (any true condition disables the device)	$V_{IN} < V_{UVLO}$	$V_{ON/OFF} < V_{ON/OFF(LOW)}$	Not applicable	$T_J > T_{SD(shutdown)}$

### 6.4.2 Normal Operation

The device regulates to the nominal output voltage when the following conditions are met:

- The input voltage is greater than the nominal output voltage plus the dropout voltage ( $V_{OUT(nom)} + V_{DO}$ )
- The output current is less than the current limit ( $I_{OUT} < I_{CL}$ )
- The device junction temperature is less than the thermal shutdown temperature ( $T_J < T_{SD}$ )
- The ON/OFF voltage has previously exceeded the ON/OFF rising threshold voltage and has not yet decreased to less than the enable falling threshold

### 6.4.3 Dropout Operation

If the input voltage is lower than the nominal output voltage plus the specified dropout voltage, but all other conditions are met for normal operation, the device operates in dropout mode. In this mode, the output voltage tracks the input voltage. During this mode, the transient performance of the device becomes significantly degraded because the pass transistor is in the ohmic or triode region, and acts as a switch. Line or load transients in dropout can result in large output-voltage deviations.

When the device is in a steady dropout state (defined as when the device is in dropout,  $V_{IN} < V_{OUT(NOM)} + V_{DO}$ , directly after being in a normal regulation state, but *not* during start up), the pass transistor is driven into the ohmic or triode region. When the input voltage returns to a value greater than or equal to the nominal output voltage plus the dropout voltage ( $V_{OUT(NOM)} + V_{DO}$ ), the output voltage can overshoot for a short period of time while the device pulls the pass transistor back into the linear region.

### 6.4.4 Disabled

The output of the device can be shutdown by forcing the voltage of the ON/OFF pin to less than the maximum ON/OFF pin low-level input voltage (see the [节 5.5](#) table). When disabled, the pass transistor is turned off, internal circuits are shutdown, and the output voltage is actively discharged to ground by an internal discharge circuit from the output to ground.



## 7 Application and Implementation

### 备注

以下应用部分中的信息不属于 TI 器件规格的范围，TI 不担保其准确性和完整性。TI 的客户应负责确定器件是否适用于其应用。客户应验证并测试其设计，以确保系统功能。

### 7.1 Application Information

The LP2981 and LP2981A are linear voltage regulators operating from 2.5 V to 16 V (for new chip) on the input and regulates voltages between 1.2 V to 5 V with  $\pm 1\%$  accuracy (across line, load and temperature) and 100-mA maximum output current.

Successfully implementing an LDO in an application depends on the application requirements. If the requirements are simply input voltage and output voltage, compliance specifications (such as internal power dissipation or stability) must be verified to provide a solid design. If timing, start-up, noise, power supply rejection ratio (PSRR), or any other transient specification is required, then the design becomes more challenging.

#### 7.1.1 Recommended Capacitor Types

##### 7.1.1.1 Recommended Capacitors for the Legacy Chip

###### 7.1.1.1.1 Tantalum Capacitors

For the legacy chip LP2981-N, tantalum capacitors are the best choice for use at the output of the LDO. Most good quality tantalums can be used with the LP2981-N, but check the manufacturer data sheet to verify that the ESR is in range. At lower temperatures, as ESR increases, a capacitor with ESR, near the upper limit for stability at room temperature can cause instability. For very low temperature applications, output tantalum capacitors can be used in parallel configuration to prevent the ESR from going up too high.

###### 7.1.1.1.2 Ceramic Capacitors

For the legacy chip LP2981-N, ceramic capacitors are not recommended for use at the output of the LDO. This recommendation is because the ESR of a ceramic can be low enough to go below the minimum stable value for the LP2981-N. A measured 2.2- $\mu$ F ceramic capacitor is verified to have an ESR of approximately 15 m $\Omega$ , which is low enough to cause oscillations. If a ceramic capacitor is used on the output, a 1- $\Omega$  resistor is required to be placed in series with the capacitor.

###### 7.1.1.1.3 Aluminum Capacitors

For the legacy chip LP2981-N, aluminum electrolytics are not typically used with the LDO, because of the large physical size. These aluminum capacitors must meet the same ESR requirements over the operating temperature range, more difficult because of the steep increase at cold temperature. An aluminum electrolytic can exhibit an ESR increase of as much as 50x when going from 20°C to -40°C. Also, some aluminum electrolytics are not operational below -25°C because the electrolyte can freeze.

##### 7.1.1.2 Recommended Capacitors for the New Chip

The new chip is designed to be stable using low equivalent series resistance (ESR) ceramic capacitors at the input and output. Multilayer ceramic capacitors have become the industry standard for these types of applications and are recommended, but must be used with good judgment. Ceramic capacitors that employ X7R-, X5R-, and C0G-rated dielectric materials provide relatively good capacitive stability across temperature, whereas using Y5V-rated capacitors is discouraged because of large variations in capacitance.

Regardless of the ceramic capacitor type selected, the effective capacitance varies with operating voltage and temperature. Generally, expect the effective capacitance to decrease by as much as 50%. The input and output capacitors listed in the *Recommended Operating Conditions* table account for an effective capacitance of approximately 50% of the nominal value.

#### 7.1.2 Input and Output Capacitor Requirements

### 7.1.2.1 Input Capacitor

For the legacy chip, an input capacitor ( $C_{IN}$ )  $\geq 1 \mu F$  is required (the amount of capacitance can be increased without limit). Any good-quality tantalum or ceramic capacitor can be used. The capacitor must be located no more than half an inch from the input pin and returned to a clean analog ground.

For the new chip, although an input capacitor is not required for stability, good analog design practice is to connect a capacitor from IN to GND. This capacitor counteracts reactive input sources and improves transient response, input ripple, and PSRR. Use an input capacitor if the source impedance is more than  $0.5 \Omega$ . A higher value capacitor can be necessary if large, fast rise-time load or line transients are anticipated or if the device is located several inches from the input power source.

### 7.1.2.2 Output Capacitor

For the legacy chip, The output capacitor must meet both the requirement for minimum amount of capacitance and equivalent series resistance (ESR) value. Curves are provided which show the allowable ESR range as a function of load current for various output voltages and capacitor values (refer to [图 7-3](#), [图 7-4](#), [图 7-5](#), and [图 7-6](#)).

For the new chip, Dynamic performance of the device is improved with the use of an output capacitor. Use an output capacitor, preferably ceramic capacitors, within the range specified in the [节 5.3](#) table for stability.

### 7.1.3 Estimating Junction Temperature

The JEDEC standard now recommends the use of psi ( $\Psi$ ) thermal metrics to estimate the junction temperatures of the linear regulator when in-circuit on a typical PCB board application. These metrics are not thermal resistance parameters and instead offer a practical and relative way to estimate junction temperature. These psi metrics are determined to be significantly independent of the copper area available for heat-spreading. The [节 5.4](#) table lists the primary thermal metrics, which are the junction-to-top characterization parameter ( $\Psi_{JT}$ ) and junction-to-board characterization parameter ( $\Psi_{JB}$ ). These parameters provide two methods for calculating the junction temperature ( $T_J$ ), as described in the following equations. Use the junction-to-top characterization parameter ( $\Psi_{JT}$ ) with the temperature at the top-center of the device package ( $T_T$ ) to calculate the junction temperature. Use the junction-to-board characterization parameter ( $\Psi_{JB}$ ) with the PCB surface temperature 1 mm from the device package ( $T_B$ ) to calculate the junction temperature.

$$T_J = T_T + \Psi_{JT} \times P_D \quad (2)$$

where:

- $P_D$  is the dissipated power
- $T_T$  is the temperature at the center-top of the device package

$$T_J = T_B + \Psi_{JB} \times P_D \quad (3)$$

where:

- $T_B$  is the PCB surface temperature measured 1 mm from the device package and centered on the package edge

For detailed information on the thermal metrics and how to use these metrics, see the [Semiconductor and IC Package Thermal Metrics](#) application note.

### 7.1.4 Power Dissipation (P<sub>D</sub>)

Circuit reliability requires consideration of the device power dissipation, location of the circuit on the printed circuit board (PCB), and correct sizing of the thermal plane. The PCB area around the regulator must have few or no other heat-generating devices that cause added thermal stress.

To first-order approximation, power dissipation in the regulator depends on the input-to-output voltage difference and load conditions. The following equation calculates power dissipation (P<sub>D</sub>).

$$P_D = (V_{IN} - V_{OUT}) \times I_{OUT} \quad (4)$$

#### 备注

Power dissipation can be minimized, and therefore greater efficiency can be achieved, by correct selection of the system voltage rails. For the lowest power dissipation use the minimum input voltage required for correct output regulation.

For devices with a thermal pad, the primary heat conduction path for the device package is through the thermal pad to the PCB. Solder the thermal pad to a copper pad area under the device. This pad area must contain an array of plated vias that conduct heat to additional copper planes for increased heat dissipation.

The maximum power dissipation determines the maximum allowable ambient temperature (T<sub>A</sub>) for the device. According to the following equation, power dissipation and junction temperature are most often related by the junction-to-ambient thermal resistance (R<sub>θJA</sub>) of the combined PCB and device package and the temperature of the ambient air (T<sub>A</sub>).

$$T_J = T_A + (R_{\theta JA} \times P_D) \quad (5)$$

Thermal resistance (R<sub>θJA</sub>) is highly dependent on the heat-spreading capability built into the particular PCB design, and therefore varies according to the total copper area, copper weight, and location of the planes. The junction-to-ambient thermal resistance listed in the [节 5.4](#) table is determined by the JEDEC standard PCB and copper-spreading area, and is used as a relative measure of package thermal performance. As mentioned in the [An empirical analysis of the impact of board layout on LDO thermal performance](#) application note, R<sub>θJA</sub> can be improved by 35% to 55% compared to the *Thermal Information* table value with the PCB board layout optimization.

### 7.1.5 Reverse Current

Excessive reverse current can damage this device. Reverse current flows through the intrinsic body diode of the pass transistor instead of the normal conducting channel. At high magnitudes, this current flow degrades the long-term reliability of the device.

Conditions where reverse current can occur are outlined in this section, all of which can exceed the absolute maximum rating of V<sub>OUT</sub> ≤ V<sub>IN</sub> + 0.3 V.

- If the device has a large C<sub>OUT</sub> and the input supply collapses with little or no load current
- The output is biased when the input supply is not established
- The output is biased above the input supply

If reverse current flow is expected in the application, use external protection to protect the device. Reverse current is not limited in the device, so external limiting is required if extended reverse voltage operation is anticipated.

图 7-1 shows one approach for protecting the device.



图 7-1. Example Circuit for Reverse Current Protection Using a Schottky Diode

## 7.2 Typical Application

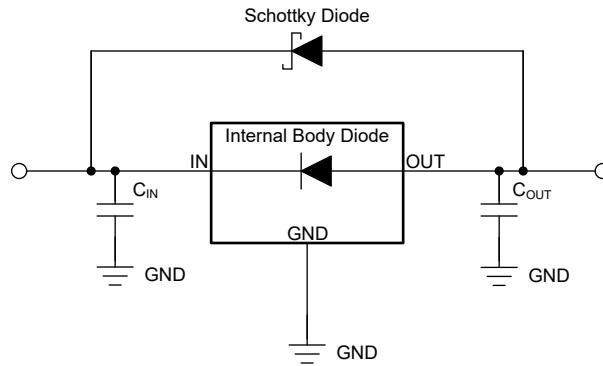
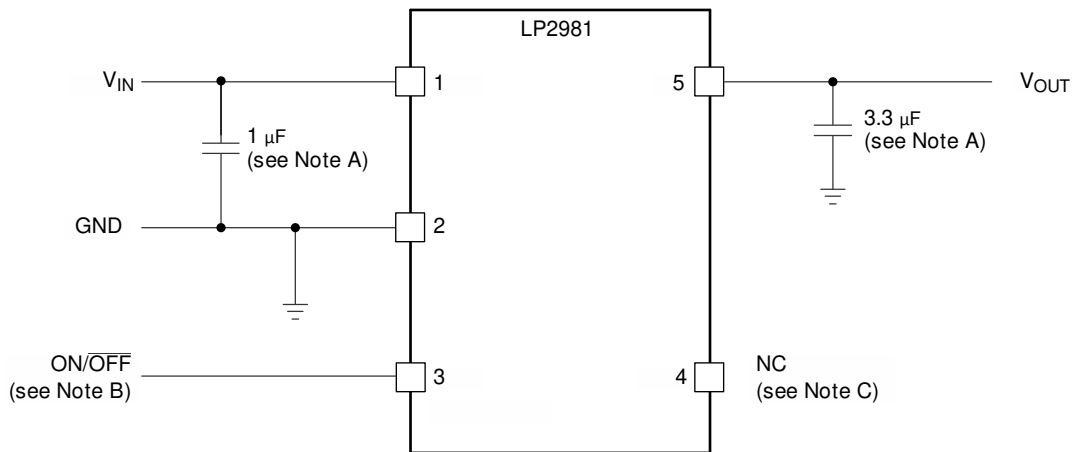

Copyright © 2016, Texas Instruments Incorporated

- A. Minimum  $C_{OUT}$  value for stability (can be increased without limit for improved stability and transient response).
- B. ON/ OFF must be actively terminated. Connect to  $V_{IN}$  if shutdown feature is not used.
- C. For the new chip, Pin 4 (NC) is not internally connected.

图 7-2. LP2981 Typical Application

### 7.2.1 Design Requirements

表 7-1 lists the parameters for this application.

表 7-1. Design Parameters

PARAMETER	DESIGN REQUIREMENT
Input voltage	12 V $\pm$ 10%, provided by an external regulator
Output voltage	3.3 V $\pm$ 1%
Output current	100 mA (maximum), 1 mA (minimum)
RMS noise, 300 Hz to 50 kHz	< 1 mV <sub>RMS</sub>
PSRR at 1 kHz	> 40 dB

## 7.2.2 Detailed Design Procedure

### 7.2.2.1 ON and OFF Input Operation

The LP2981/A is shut off by pulling the ON/  $\overline{\text{OFF}}$  input low, and turned on by driving the input high. If this feature is not to be used, the ON/OFF input must be tied to  $V_{\text{IN}}$  to keep the regulator on at all times (the ON/  $\overline{\text{OFF}}$  input must **not** be left floating).

For proper operation, the signal source used to drive the ON/  $\overline{\text{OFF}}$  input must be able to swing above and below the specified turn-on or turn-off voltage thresholds which specify an ON or  $\overline{\text{OFF}}$  state (see 节 5.5).

The ON/  $\overline{\text{OFF}}$  signal can come from either a totem-pole output, or an open-collector output with pullup resistor to the LP2981 and LP2891A input voltage or another logic supply. The high-level voltage can exceed the LP2981 and LP2891A input voltage, but must remain within the ratings list in 节 5.1 for the ON/  $\overline{\text{OFF}}$  pin.

### 7.2.3 Application Curves



图 7-3. 5-V, 3.3- $\mu\text{F}$  ESR Curves (Legacy Chip)



图 7-4. 5-V, 10- $\mu\text{F}$  ESR Curves (Legacy Chip)

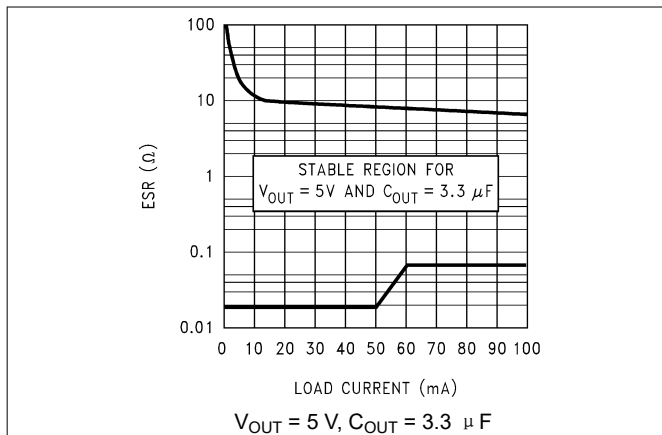

图 7-5. 3.0-V, 3.3- $\mu\text{F}$  ESR Curves (Legacy Chip)

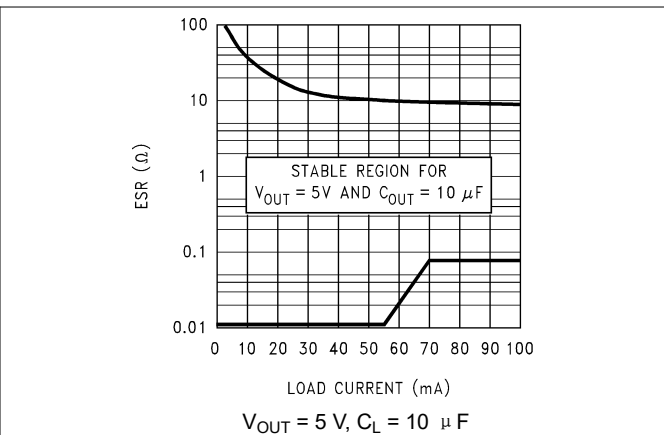

图 7-6. 3.0-V, 10- $\mu\text{F}$  ESR Curves (Legacy Chip)

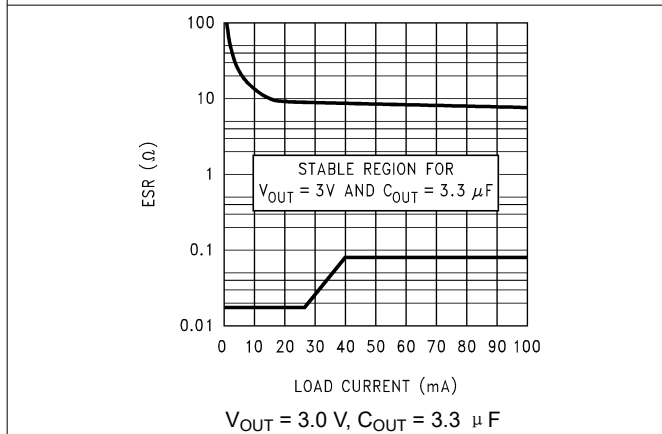

图 7-7. Line Transient Response (New Chip)

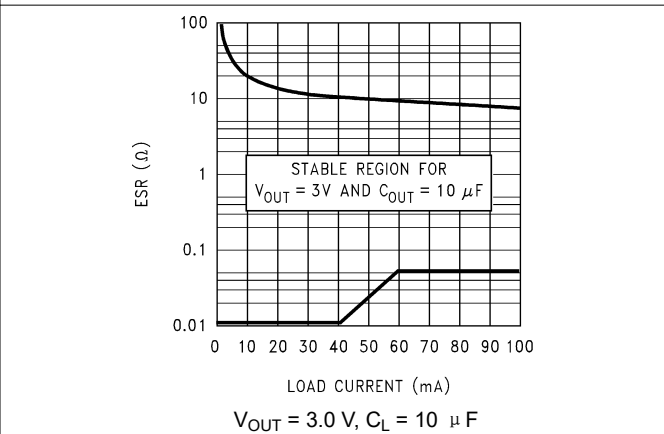

图 7-8. Line Transient Response (New Chip)

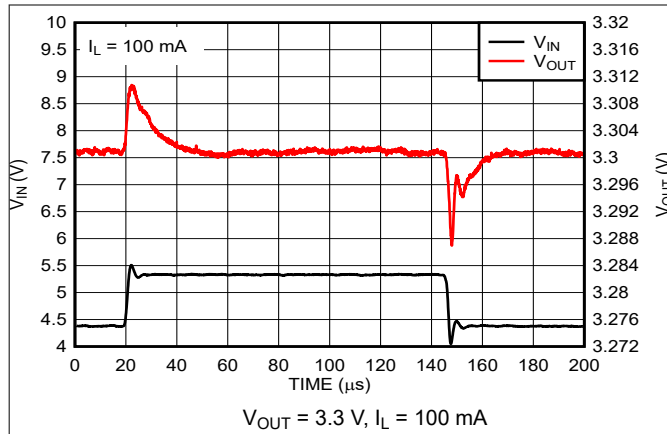

图 7-9. Load Transient Response (New Chip)

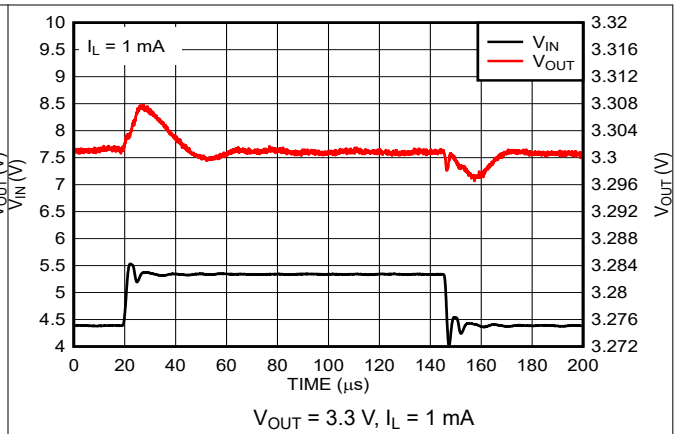

图 7-10. Turn-on Waveform (New Chip)

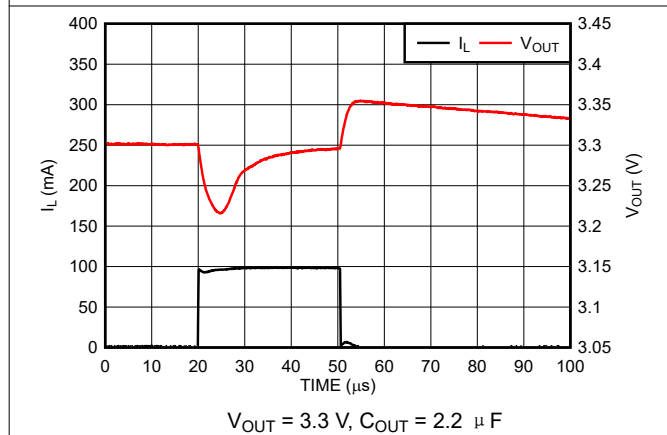

图 7-11. Turn-off Waveform (New Chip)

## 8 Power Supply Recommendations

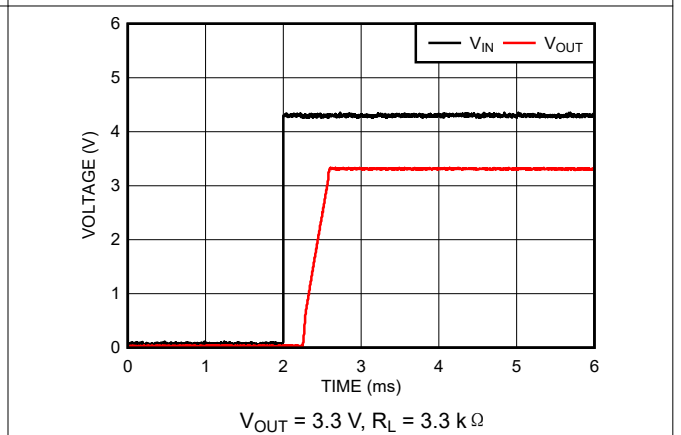
The LP2981 is designed to operate from an input voltage supply range between 2.5 V and 16 V (for the new chip). The input voltage range provides adequate headroom for the device to have a regulated output. This input supply must be well regulated. If the input supply is noisy, additional input capacitors with low ESR can help improve the output noise performance.

## 9 Layout

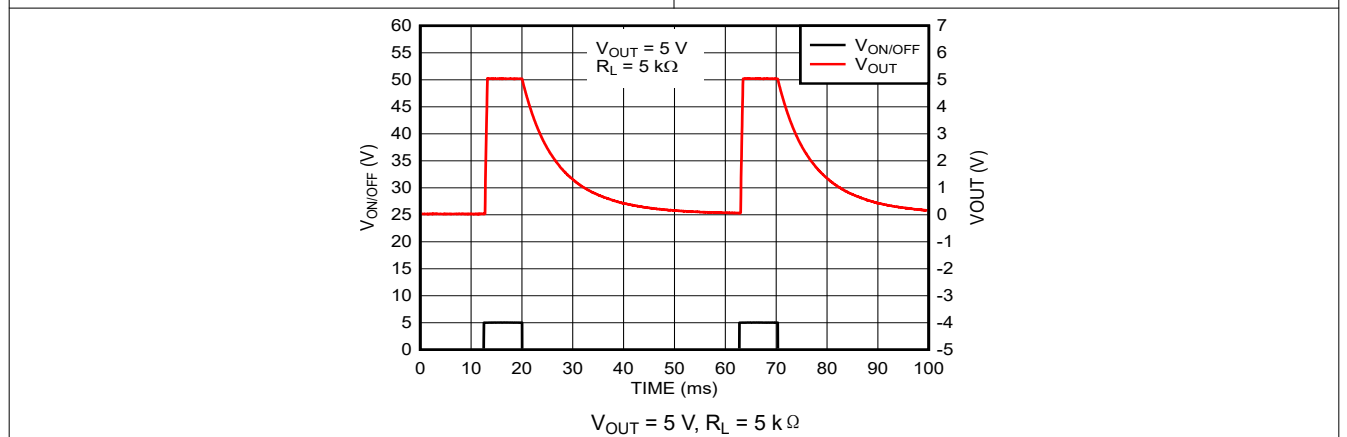
### 9.1 Layout Guidelines

For best overall performance, place all circuit components on the same side of the printed-circuit board and as near as practical to the respective LDO pin connections. Place ground return connections to the input and output capacitors, and to the LDO ground pin as close to each other as possible, connected by a wide, component-side, copper surface. The use of vias and long traces to create LDO circuit connections is strongly discouraged and negatively affects system performance. This grounding and layout scheme minimizes inductive parasitics, and thereby reduces load-current transients, minimizes noise, and increases circuit stability. A ground reference plane is also recommended and is either embedded in the PCB or located on the bottom side of the PCB opposite the components. This reference plane serves to assure accuracy of the output voltage, shield noise, and behaves similar to a thermal plane to spread (or sink) heat from the LDO device. In most applications, this ground plane is necessary to meet thermal requirements.

### 9.2 Layout Example



图 9-1. Recommended Layout

## 10 Device and Documentation Support

### 10.1 Device Nomenclature

表 10-1. Available Options

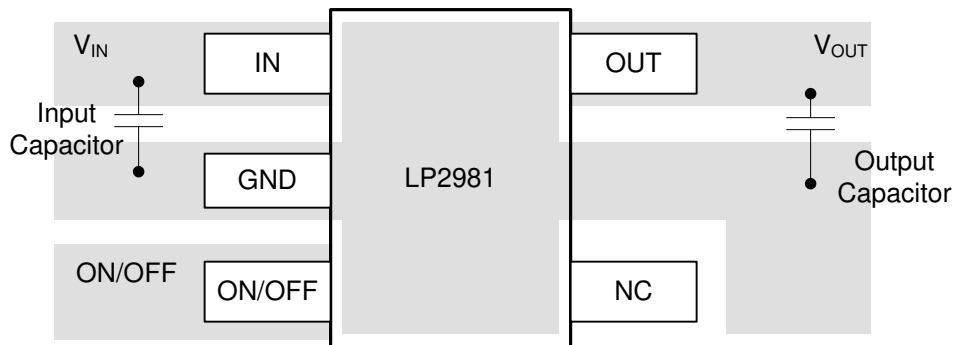
PRODUCT <sup>(1)</sup>	V <sub>OUT</sub>
LP2981c- <b>xx</b> yyyz Legacy chip	<b>c</b> is for the accuracy of LDO output. <b>xx</b> is the nominal output voltage (for example, 33 = 3.3 V; 50 = 5.0 V). <b>yyy</b> is the package designator. <b>z</b> is the package quantity. R is for large quantity reel, T is for small quantity reel.
LP2981c- <b>xx</b> yyyz <b>M3</b> New chip	<b>c</b> is for the accuracy of LDO output. <b>xx</b> is the nominal output voltage (for example, 33 = 3.3 V; 50 = 5.0 V). <b>yyy</b> is the package designator. <b>z</b> is the package quantity. R is for large quantity reel, T is for small quantity reel. <b>M3</b> is a suffix designator for newer chip redesigns, fabricated on the latest TI process technology.

(1) For the most current package and ordering information, see the Package Option Addendum at the end of this document, or visit the device product folder at [www.ti.com](http://www.ti.com).

### 10.2 Documentation Support

#### 10.2.1 Related Documentation

For related documentation see the following:

- Texas Instruments, [LDO Noise Demystified](#), application note
- Texas Instruments, [LDO PSRR Measurement Simplified](#), application note
- Texas Instruments, [A Topical Index of TI LDO Application Notes](#), application note

### 10.3 Receiving Notification of Documentation Updates

To receive notification of documentation updates, navigate to the device product folder on ti.com. In the upper right corner, click on *Alert me* to register and receive a weekly digest of any product information that has changed. For change details, review the revision history included in any revised document.

### 10.4 支持资源

TI E2E™ 中文支持论坛是工程师的重要参考资料，可直接从专家处获得快速、经过验证的解答和设计帮助。搜索现有解答或提出自己的问题，获得所需的快速设计帮助。

链接的内容由各个贡献者“按原样”提供。这些内容并不构成 TI 技术规范，并且不一定反映 TI 的观点；请参阅 TI 的[使用条款](#)。

### 10.5 Trademarks

TI E2E™ is a trademark of Texas Instruments.

所有商标均为其各自所有者的财产。

### 10.6 静电放电警告



静电放电 (ESD) 会损坏这个集成电路。德州仪器 (TI) 建议通过适当的预防措施处理所有集成电路。如果不遵守正确的处理和安装程序，可能会损坏集成电路。

ESD 的损坏小至导致微小的性能降级，大至整个器件故障。精密的集成电路可能更容易受到损坏，这是因为非常细微的参数更改都可能会导致器件与其发布的规格不相符。

### 10.7 术语表

#### TI 术语表

本术语表列出并解释了术语、首字母缩略词和定义。



## 11 Revision History

注：以前版本的页码可能与当前版本的页码不同

<b>Changes from Revision G (July 2016) to Revision H (December 2023)</b>	<b>Page</b>
• 更新了整个文档中的表格、图和交叉参考的编号格式.....	1
• 更改了整个文档，以便与当前系列格式保持一致.....	1
• 向文档添加了 M3 器件.....	1
• Added <i>Device Nomenclature</i> section.....	24
• Added three references to <i>Related Documentation</i> .....	24
<hr/>	
<b>Changes from Revision F (August 2008) to Revision G (July 2016)</b>	<b>Page</b>
• 添加了器件信息表、ESD 等级表、特性说明部分、器件功能模式、应用和实施部分、电源相关建议部分、布局部分、器件和文档支持部分以及机械、封装和可订购信息部分.....	1

## 12 Mechanical, Packaging, and Orderable Information

The following pages include mechanical, packaging, and orderable information. This information is the most current data available for the designated devices. This data is subject to change without notice and revision of this document. For browser-based versions of this data sheet, refer to the left-hand navigation.

**PACKAGING INFORMATION**

Orderable Device	Status (1)	Package Type	Package Drawing	Pins	Package Qty	Eco Plan (2)	Lead finish/ Ball material (6)	MSL Peak Temp (3)	Op Temp (°C)	Device Marking (4/5)	Samples
LP2981-28DBVR	ACTIVE	SOT-23	DBV	5	3000	RoHS & Green	SN	Level-1-260C-UNLIM	-40 to 125	LP5G	<a href="#">Samples</a>
LP2981-28DBVT	ACTIVE	SOT-23	DBV	5	250	RoHS & Green	SN	Level-1-260C-UNLIM	-40 to 125	LP5G	<a href="#">Samples</a>
LP2981-28DBVTG4	ACTIVE	SOT-23	DBV	5	250	RoHS & Green	NIPDAU	Level-1-260C-UNLIM	-40 to 125	LP5G	<a href="#">Samples</a>
LP2981-29DBVR	ACTIVE	SOT-23	DBV	5	3000	RoHS & Green	NIPDAU	Level-1-260C-UNLIM	-40 to 125	LP3G	<a href="#">Samples</a>
LP2981-30DBVR	ACTIVE	SOT-23	DBV	5	3000	RoHS & Green	NIPDAU   SN	Level-1-260C-UNLIM	-40 to 125	(LP7G, LP7L)	<a href="#">Samples</a>
LP2981-30DBVT	ACTIVE	SOT-23	DBV	5	250	RoHS & Green	NIPDAU   SN	Level-1-260C-UNLIM	-40 to 125	(LP7G, LP7L)	<a href="#">Samples</a>
LP2981-33DBVR	ACTIVE	SOT-23	DBV	5	3000	RoHS & Green	NIPDAU   SN	Level-1-260C-UNLIM	-40 to 125	(LPBG, LPBL)	<a href="#">Samples</a>
LP2981-33DBVT	OBSOLETE	SOT-23	DBV	5		TBD	Call TI	Call TI	-40 to 125	(LPBG, LPBL)	
LP2981-50DBVR	ACTIVE	SOT-23	DBV	5	3000	RoHS & Green	NIPDAU   SN	Level-1-260C-UNLIM	-40 to 125	(LPDG, LPDL)	<a href="#">Samples</a>
LP2981-50DBVRG4	ACTIVE	SOT-23	DBV	5	3000	RoHS & Green	NIPDAU	Level-1-260C-UNLIM	-40 to 125	(LPDG, LPDL)	<a href="#">Samples</a>
LP2981-50DBVT	OBSOLETE	SOT-23	DBV	5		TBD	Call TI	Call TI	-40 to 125	(LPDG, LPDL)	
LP2981A-28DBVR	ACTIVE	SOT-23	DBV	5	3000	RoHS & Green	NIPDAU   SN	Level-1-260C-UNLIM	-40 to 125	(LP6G, LP6L)	<a href="#">Samples</a>
LP2981A-28DBVT	ACTIVE	SOT-23	DBV	5	250	RoHS & Green	NIPDAU   SN	Level-1-260C-UNLIM	-40 to 125	(LP6G, LP6L)	<a href="#">Samples</a>
LP2981A-29DBVR	ACTIVE	SOT-23	DBV	5	3000	RoHS & Green	NIPDAU	Level-1-260C-UNLIM	-40 to 125	LRBG	<a href="#">Samples</a>
LP2981A-30DBVR	ACTIVE	SOT-23	DBV	5	3000	RoHS & Green	NIPDAU   SN	Level-1-260C-UNLIM	-40 to 125	(LP8G, LP8L)	<a href="#">Samples</a>
LP2981A-30DBVRG4	ACTIVE	SOT-23	DBV	5	3000	RoHS & Green	NIPDAU	Level-1-260C-UNLIM	-40 to 125	LP8G	<a href="#">Samples</a>
LP2981A-30DBVTG4	ACTIVE	SOT-23	DBV	5	250	RoHS & Green	NIPDAU	Level-1-260C-UNLIM	-40 to 125	LP8G	<a href="#">Samples</a>
LP2981A-33DBVR	ACTIVE	SOT-23	DBV	5	3000	RoHS & Green	NIPDAU   SN	Level-1-260C-UNLIM	-40 to 125	(LPCG, LPCL)	<a href="#">Samples</a>
LP2981A-33DBVRG4	ACTIVE	SOT-23	DBV	5	3000	RoHS & Green	NIPDAU	Level-1-260C-UNLIM	-40 to 125	LPCG	<a href="#">Samples</a>
LP2981A-33DBVTG4	ACTIVE	SOT-23	DBV	5	250	RoHS & Green	NIPDAU	Level-1-260C-UNLIM	-40 to 125	LPCG	<a href="#">Samples</a>

Orderable Device	Status (1)	Package Type	Package Drawing	Pins	Package Qty	Eco Plan (2)	Lead finish/ Ball material (6)	MSL Peak Temp (3)	Op Temp (°C)	Device Marking (4/5)	Samples
LP2981A-50DBVR	ACTIVE	SOT-23	DBV	5	3000	RoHS & Green	NIPDAU   SN	Level-1-260C-UNLIM	-40 to 125	(LPEG, LPEL)	<a href="#">Samples</a>
LP2981A-50DBVRG4	ACTIVE	SOT-23	DBV	5	3000	RoHS & Green	NIPDAU	Level-1-260C-UNLIM	-40 to 125	(LPEG, LPEL)	<a href="#">Samples</a>
LP2981A-50DBVT	ACTIVE	SOT-23	DBV	5	250	RoHS & Green	NIPDAU	Level-1-260C-UNLIM	-40 to 125	(LPEG, LPEL)	<a href="#">Samples</a>

(1) The marketing status values are defined as follows:

**ACTIVE:** Product device recommended for new designs.

**LIFEBUY:** TI has announced that the device will be discontinued, and a lifetime-buy period is in effect.

**NRND:** Not recommended for new designs. Device is in production to support existing customers, but TI does not recommend using this part in a new design.

**PREVIEW:** Device has been announced but is not in production. Samples may or may not be available.

**OBSELETE:** TI has discontinued the production of the device.

(2) **RoHS:** TI defines "RoHS" to mean semiconductor products that are compliant with the current EU RoHS requirements for all 10 RoHS substances, including the requirement that RoHS substance do not exceed 0.1% by weight in homogeneous materials. Where designed to be soldered at high temperatures, "RoHS" products are suitable for use in specified lead-free processes. TI may reference these types of products as "Pb-Free".

**RoHS Exempt:** TI defines "RoHS Exempt" to mean products that contain lead but are compliant with EU RoHS pursuant to a specific EU RoHS exemption.

**Green:** TI defines "Green" to mean the content of Chlorine (Cl) and Bromine (Br) based flame retardants meet JS709B low halogen requirements of <=1000ppm threshold. Antimony trioxide based flame retardants must also meet the <=1000ppm threshold requirement.

(3) MSL, Peak Temp. - The Moisture Sensitivity Level rating according to the JEDEC industry standard classifications, and peak solder temperature.

(4) There may be additional marking, which relates to the logo, the lot trace code information, or the environmental category on the device.

(5) Multiple Device Markings will be inside parentheses. Only one Device Marking contained in parentheses and separated by a "-" will appear on a device. If a line is indented then it is a continuation of the previous line and the two combined represent the entire Device Marking for that device.

(6) Lead finish/Ball material - Orderable Devices may have multiple material finish options. Finish options are separated by a vertical ruled line. Lead finish/Ball material values may wrap to two lines if the finish value exceeds the maximum column width.

**Important Information and Disclaimer:**The information provided on this page represents TI's knowledge and belief as of the date that it is provided. TI bases its knowledge and belief on information provided by third parties, and makes no representation or warranty as to the accuracy of such information. Efforts are underway to better integrate information from third parties. TI has taken and continues to take reasonable steps to provide representative and accurate information but may not have conducted destructive testing or chemical analysis on incoming materials and chemicals. TI and TI suppliers consider certain information to be proprietary, and thus CAS numbers and other limited information may not be available for release.

In no event shall TI's liability arising out of such information exceed the total purchase price of the TI part(s) at issue in this document sold by TI to Customer on an annual basis.

**TAPE AND REEL INFORMATION**

**QUADRANT ASSIGNMENTS FOR PIN 1 ORIENTATION IN TAPE**

\*All dimensions are nominal

Device	Package Type	Package Drawing	Pins	SPQ	Reel Diameter (mm)	Reel Width W1 (mm)	A0 (mm)	B0 (mm)	K0 (mm)	P1 (mm)	W (mm)	Pin1 Quadrant
LP2981-28DBVR	SOT-23	DBV	5	3000	178.0	9.0	3.23	3.17	1.37	4.0	8.0	Q3
LP2981-28DBVTG4	SOT-23	DBV	5	250	178.0	9.0	3.23	3.17	1.37	4.0	8.0	Q3
LP2981-30DBVR	SOT-23	DBV	5	3000	180.0	8.4	3.2	3.2	1.4	4.0	8.0	Q3
LP2981-33DBVR	SOT-23	DBV	5	3000	180.0	8.4	3.2	3.2	1.4	4.0	8.0	Q3
LP2981-50DBVR	SOT-23	DBV	5	3000	180.0	8.4	3.2	3.2	1.4	4.0	8.0	Q3
LP2981A-28DBVR	SOT-23	DBV	5	3000	178.0	9.0	3.23	3.17	1.37	4.0	8.0	Q3
LP2981A-30DBVR	SOT-23	DBV	5	3000	180.0	8.4	3.2	3.2	1.4	4.0	8.0	Q3
LP2981A-30DBVRG4	SOT-23	DBV	5	3000	178.0	9.0	3.3	3.2	1.4	4.0	8.0	Q3
LP2981A-30DBVTG4	SOT-23	DBV	5	250	178.0	9.0	3.23	3.17	1.37	4.0	8.0	Q3
LP2981A-33DBVR	SOT-23	DBV	5	3000	180.0	8.4	3.2	3.2	1.4	4.0	8.0	Q3
LP2981A-33DBVRG4	SOT-23	DBV	5	3000	178.0	9.0	3.3	3.2	1.4	4.0	8.0	Q3
LP2981A-33DBVTG4	SOT-23	DBV	5	250	178.0	9.0	3.23	3.17	1.37	4.0	8.0	Q3
LP2981A-50DBVR	SOT-23	DBV	5	3000	180.0	8.4	3.2	3.2	1.4	4.0	8.0	Q3

**TAPE AND REEL BOX DIMENSIONS**

\*All dimensions are nominal

Device	Package Type	Package Drawing	Pins	SPQ	Length (mm)	Width (mm)	Height (mm)
LP2981-28DBVR	SOT-23	DBV	5	3000	180.0	180.0	18.0
LP2981-28DBVTG4	SOT-23	DBV	5	250	180.0	180.0	18.0
LP2981-30DBVR	SOT-23	DBV	5	3000	210.0	185.0	35.0
LP2981-33DBVR	SOT-23	DBV	5	3000	210.0	185.0	35.0
LP2981-50DBVR	SOT-23	DBV	5	3000	210.0	185.0	35.0
LP2981A-28DBVR	SOT-23	DBV	5	3000	180.0	180.0	18.0
LP2981A-30DBVR	SOT-23	DBV	5	3000	210.0	185.0	35.0
LP2981A-30DBVRG4	SOT-23	DBV	5	3000	180.0	180.0	18.0
LP2981A-30DBVTG4	SOT-23	DBV	5	250	180.0	180.0	18.0
LP2981A-33DBVR	SOT-23	DBV	5	3000	210.0	185.0	35.0
LP2981A-33DBVRG4	SOT-23	DBV	5	3000	180.0	180.0	18.0
LP2981A-33DBVTG4	SOT-23	DBV	5	250	180.0	180.0	18.0
LP2981A-50DBVR	SOT-23	DBV	5	3000	210.0	185.0	35.0



# EXAMPLE BOARD LAYOUT

DBV0005A

SOT-23 - 1.45 mm max height

SMALL OUTLINE TRANSISTOR



LAND PATTERN EXAMPLE  
EXPOSED METAL SHOWN  
SCALE:15X



SOLDER MASK DETAILS

4214839/K 08/2024

NOTES: (continued)

- 6. Publication IPC-7351 may have alternate designs.
- 7. Solder mask tolerances between and around signal pads can vary based on board fabrication site.

# EXAMPLE STENCIL DESIGN

DBV0005A

SOT-23 - 1.45 mm max height

SMALL OUTLINE TRANSISTOR



SOLDER PASTE EXAMPLE  
BASED ON 0.125 mm THICK STENCIL  
SCALE:15X

4214839/K 08/2024

NOTES: (continued)

8. Laser cutting apertures with trapezoidal walls and rounded corners may offer better paste release. IPC-7525 may have alternate design recommendations.
9. Board assembly site may have different recommendations for stencil design.



## 重要声明和免责声明

TI“按原样”提供技术和可靠性数据（包括数据表）、设计资源（包括参考设计）、应用或其他设计建议、网络工具、安全信息和其他资源，不保证没有瑕疵且不做任何明示或暗示的担保，包括但不限于对适销性、某特定用途方面的适用性或不侵犯任何第三方知识产权的暗示担保。

这些资源可供使用 TI 产品进行设计的熟练开发人员使用。您将自行承担以下全部责任：(1) 针对您的应用选择合适的 TI 产品，(2) 设计、验证并测试您的应用，(3) 确保您的应用满足相应标准以及任何其他功能安全、信息安全、监管或其他要求。

这些资源如有变更，恕不另行通知。TI 授权您仅可将这些资源用于研发本资源所述的 TI 产品的应用。严禁对这些资源进行其他复制或展示。您无权使用任何其他 TI 知识产权或任何第三方知识产权。您应全额赔偿因在这些资源的使用中对 TI 及其代表造成的任何索赔、损害、成本、损失和债务，TI 对此概不负责。

TI 提供的产品受 [TI 的销售条款](#) 或 [ti.com](#) 上其他适用条款/TI 产品随附的其他适用条款的约束。TI 提供这些资源并不会扩展或以其他方式更改 TI 针对 TI 产品发布的适用的担保或担保免责声明。

TI 反对并拒绝您可能提出的任何其他或不同的条款。

邮寄地址：Texas Instruments, Post Office Box 655303, Dallas, Texas 75265  
Copyright © 2024，德州仪器 (TI) 公司