

LP2992 采用 SOT-23 和 WSON 封装、旨在与极低 ESR 输出电容器配合使用的 低功耗 250mA 低噪声超低压降稳压器

1 特性

- V_{IN} 范围 (新芯片) : 2.5V 至 16V
- V_{OUT} 范围 (新芯片) :
 - 1.2V 至 5.0V (固定值, 100mV 阶跃)
- V_{OUT} 精度 :
 - A 级旧芯片为 $\pm 1\%$
 - 标准级旧芯片为 $\pm 1.5\%$
 - $\pm 0.5\%$ (仅限新芯片)
- 对于新芯片, 在整个负载和温度范围内的输出精度为 $\pm 1\%$
- 输出电流: 高达 250 mA
- 低 I_Q (新芯片) : $I_{LOAD} = 0\text{mA}$ 时为 $69\ \mu\text{A}$
- 低 I_Q (新芯片) : $I_{LOAD} = 250\ \text{mA}$ 时为 $875\ \mu\text{A}$
- 关断电流 :
 - 旧芯片为 $0.01\ \mu\text{A}$ (典型值)
 - 新芯片为 $1.12\ \mu\text{A}$ (典型值)
- 低噪声: $30\ \mu\text{V}_{RMS}$, 带 10nF 旁路电容器
- 输出电流限制和热保护
- 使用 $2.2\ \mu\text{F}$ 陶瓷电容器实现稳定工作
- 高 PSRR: 1kHz 频率下为 70dB, 1MHz 频率下为 40dB
- 工作结温: -40°C 至 125°C
- 封装: 5 引脚 SOT-23 (DBV)

2 应用

- 洗衣机和烘干机
- 陆地移动无线电
- 有源天线系统 mMIMO
- 无线电动工具
- 电机驱动器和控制板

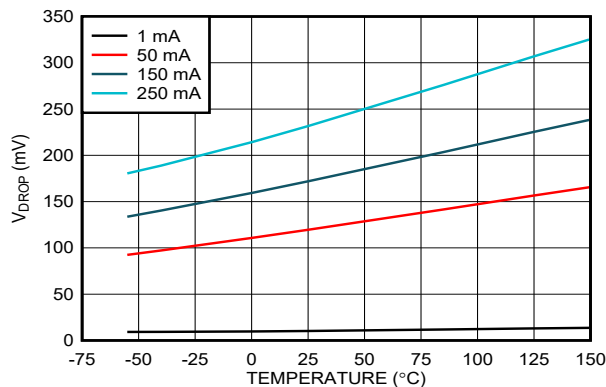

新芯片的压降电压与温度间的关系

3 描述

LP2992 是一款宽输入、固定输出、低噪声、低压降稳压器, 支持 2.5V 至 16V 的输入电压范围和高达 250mA 的负载电流。LP2992 支持 1.2V 至 5.0V 的输出范围 (对于新芯片)。

此外, LP2992 (新芯片) 在整个负载和温度范围内具有 1% 的输出精度, 可满足低压微控制器 (MCU) 和处理器的需求。

$30\ \mu\text{V}_{RMS}$ 的低输出噪声 (带 10nF 旁路电容器) 以及 1kHz 时大于 70dB 和 1MHz 时大于 40dB 的宽带宽 PSRR 性能有助于衰减上游直流/直流转换器的开关频率, 并尽可能减少后置稳压器滤波。

内部软启动时间和电流限制保护可减小启动期间的浪涌电流, 从而尽可能降低输入电容。还包括标准保护特性, 例如过流和过热保护。

LP2992 采用 5 引脚 $2.9\text{mm} \times 2.8\text{mm}$ SOT-23 (DBV) 封装。

封装信息

器件型号	封装 ⁽¹⁾	封装尺寸 ⁽²⁾
LP2992	DBV (SOT-23, 5)	$2.9\text{mm} \times 2.8\text{mm}$
	WSON (6)	$3.29\ \text{mm} \times 2.92\ \text{mm}$

(1) 有关详细信息, 请参阅节 12。

(2) 封装尺寸 (长 \times 宽) 为标称值, 并包括引脚 (如适用)。

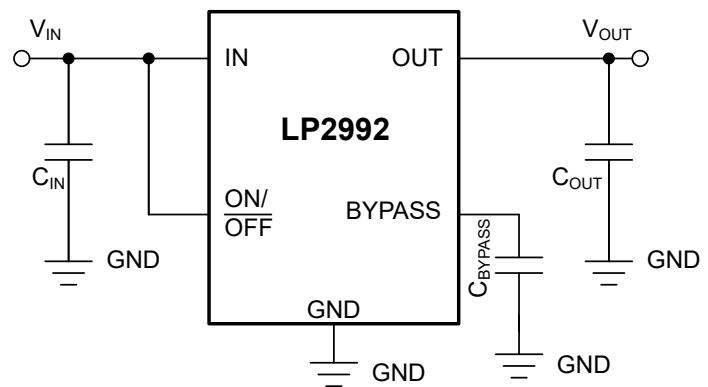

典型应用电路



Table of Contents

1 特性	1	7.1 Application Information.....	23
2 应用	1	7.2 Typical Application.....	25
3 描述	1	8 Power Supply Recommendations	27
4 Pin Configuration and Functions	3	9 Layout	28
5 Specifications	4	9.1 Layout Guidelines.....	28
5.1 Absolute Maximum Ratings.....	4	9.2 Layout Examples.....	28
5.2 ESD Ratings.....	4	10 Device and Documentation Support	29
5.3 Recommended Operating Conditions.....	4	10.1 Device Nomenclature.....	29
5.4 Electrical Characteristics.....	5	10.2 Documentation Support.....	29
5.5 Thermal Information.....	8	10.3 Receiving Notification of Documentation Updates..	29
5.6 Typical Characteristics.....	9	10.4 支持资源.....	29
6 Detailed Description	19	10.5 Trademarks.....	29
6.1 Overview.....	19	10.6 静电放电警告.....	29
6.2 Functional Block Diagram.....	19	10.7 术语表.....	29
6.3 Feature Description.....	19	11 Revision History	30
6.4 Device Functional Modes.....	21	12 Mechanical, Packaging, and Orderable Information	30
7 Application and Implementation	23		

4 Pin Configuration and Functions



图 4-1. DBV Package, 5-Pin SOT-23 (Top View)

表 4-1. Pin Functions

PIN		TYPE	DESCRIPTION
NAME	NO.		
BYPASS	4	I/O	BYPASS pin to achieve low noise performance. Connecting an external capacitor between BYPASS pin and ground reduces reference voltage noise. See the 节 5.3 section for more information.
GND	2	—	Ground
ON/ $\overline{\text{OFF}}$	3	I	Enable pin for the LDO. Driving the ON/ $\overline{\text{OFF}}$ pin high enables the device. Driving this pin low disables the device. High and low thresholds are listed in the 节 5.4 table. Tie this pin to V_{IN} if unused.
V_{IN}	1	I	Input supply pin. Use a capacitor with a value of 1 μF or larger from this pin to ground. See 节 7.1.2 for more information.
V_{OUT}	5	O	Output of the regulator. Use a capacitor with a value of 2.2 μF or larger from this pin to ground ⁽¹⁾ . See the 节 7.1.2 section for more information.

- (1) The nominal output capacitance must be greater than 1 μF . Throughout this document, the nominal derating on these capacitors is 50%. Make sure that the effective capacitance at the pin is greater than 1 μF .

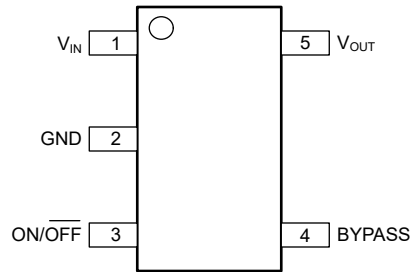
5 Specifications

5.1 Absolute Maximum Ratings

over operating free-air temperature range (unless otherwise noted)^{(1) (2)}

		MIN	MAX	UNIT
V _{IN}	Continuous input voltage range (for legacy chip)	- 0.3	16	V
	Continuous input voltage range (for new chip)	- 0.3	18	
V _{OUT}	Output voltage range (for legacy chip)	- 0.3	9	
	Output voltage range (for new chip)	- 0.3	V _{IN} + 0.3 or 9 (whichever is smaller)	
V _{BYPASS}	BYPASS pin voltage range (for new chip)	- 0.3	3	
V _{ON/OFF}	ON/OFF pin voltage range (for legacy chip)	- 0.3	16	
	ON/OFF pin voltage range (for new chip)	- 0.3	18	
Current	Maximum output	Internally limited		A
Temperature	Operating junction, T _J	- 55	150	°C
		- 65	150	

- (1) Operation outside the Absolute Maximum Ratings may cause permanent device damage. Absolute Maximum Ratings do not imply functional operation of the device at these or any other conditions beyond those listed under Recommended Operating Conditions. If used outside the Recommended Operating Conditions but within the Absolute Maximum Ratings, the device may not be fully functional, and this may affect device reliability, functionality, performance, and shorten the device lifetime.
- (2) All voltages with respect to GND.

5.2 ESD Ratings

			VALUE (Legacy Chip)	VALUE (New Chip)	UNIT
V _(ESD)	Electrostatic discharge	Human body model (HBM), per ANSI/ESDA/JEDEC JS-001 ⁽¹⁾	±2000	±3000	V
		Charged device model (CDM), per JEDEC specification JESD22-C101 ⁽²⁾	±500	±1000	

- (1) JEDEC document JEP155 states that 2-kV HBM allows safe manufacturing with a standard ESD control process.
- (2) JEDEC document JEP157 states that 500-V CDM allows safe manufacturing with a standard ESD control process.

5.3 Recommended Operating Conditions

		MIN	NOM	MAX	UNIT
V _{IN}	Supply input voltage (for legacy chip)	2.2		16	V
	Supply input voltage (for new chip)	2.5		16	
V _{OUT}	Output voltage (for legacy chip)	1.2		10.0	
	Output voltage (for new chip)	1.2		5.0	
V _{BYPASS}	Bypass voltage		1.2		
V _{ON/OFF}	Enable voltage (for legacy chip)	0		V _{IN}	
	Enable voltage (for new chip)	0		16	
I _{OUT}	Output current	0		250	mA
C _{IN} ⁽¹⁾	Input capacitor		1		μF
C _{OUT}	Output capacitor (for legacy chip)	2.2	4.7		μF
	Output capacitance (for new chip) ⁽¹⁾	1	2.2	200	
T _J	Operating junction temperature	- 40		125	°C

- (1) All capacitor values are assumed to derate to 50% of the nominal capacitor value. Maintain an effective output capacitance of 1 μF minimum for stability.

5.4 Electrical Characteristics

specified at $T_J = 25^\circ\text{C}$, $V_{IN} = V_{OUT(nom)} + 1.0\text{ V}$ or $V_{IN} = 2.5\text{ V}$ (whichever is greater), $I_{OUT} = 1\text{ mA}$, $V_{ON/OFF} = 2\text{ V}$, $C_{IN} = 1.0\text{ }\mu\text{F}$, and $C_{OUT} = 2.2\text{ }\mu\text{F}$ (unless otherwise noted)

PARAMETER		TEST CONDITIONS	MIN	TYP	MAX	UNIT
ΔV_{OUT}	Output voltage tolerance	$I_L = 1\text{ mA}$	Legacy chip (standard grade)	- 1.5	1.5	%
			Legacy chip (A grade)	- 1.0	1.0	
			New chip	- 0.5	0.5	
		$1\text{ mA} \leq I_L \leq 50\text{ mA}$	Legacy chip (standard grade)	- 2.5	2.5	
			Legacy chip (A grade)	- 1.5	1.5	
			New chip	- 0.5	0.5	
		$1\text{ mA} \leq I_L \leq 50\text{ mA}$, $-40^\circ\text{C} \leq T_J \leq 125^\circ\text{C}$	Legacy chip (standard grade)	- 3.5	3.5	
			Legacy chip (A grade)	- 2.5	2.5	
			New chip	- 1	1	
		$1\text{ mA} \leq I_L \leq 250\text{ mA}$	Legacy chip (standard grade)	- 4	4	
			Legacy chip (A grade)	- 3.5	3.5	
			New chip	- 0.5	0.5	
$1\text{ mA} \leq I_L \leq 250\text{ mA}$, $-40^\circ\text{C} \leq T_J \leq 125^\circ\text{C}$	Legacy chip (standard grade)	- 5	5			
	Legacy chip (A grade)	- 4.5	4.5			
	New chip	- 1	1			
$\Delta V_{OUT(\Delta V_{IN})}$	Line regulation	$V_{O(NOM)} + 1\text{ V} \leq V_{IN} \leq 16\text{ V}$	Legacy chip	0.007	0.014	%V
			New chip	0.002	0.014	
		$V_{O(NOM)} + 1\text{ V} \leq V_{IN} \leq 16\text{ V}$, $-40^\circ\text{C} \leq T_J \leq 125^\circ\text{C}$	Legacy chip	0.007	0.032	
			New chip	0.002	0.032	
$V_{IN(MIN)}$	Minimum input voltage required to maintain output regulation	$-40^\circ\text{C} \leq T_J \leq 125^\circ\text{C}$	Legacy chip	2.05	V	
			New chip	2.05		
	Minimum input voltage required to maintain output regulation		Legacy chip	2.2		
			New chip	2.35		

5.4 Electrical Characteristics (续)

specified at $T_J = 25^\circ\text{C}$, $V_{IN} = V_{OUT(nom)} + 1.0\text{ V}$ or $V_{IN} = 2.5\text{ V}$ (whichever is greater), $I_{OUT} = 1\text{ mA}$, $V_{ON/OFF} = 2\text{ V}$, $C_{IN} = 1.0\text{ }\mu\text{F}$, and $C_{OUT} = 2.2\text{ }\mu\text{F}$ (unless otherwise noted)

PARAMETER		TEST CONDITIONS	MIN	TYP	MAX	UNIT	
I_{GND}	GND pin current	$I_{OUT} = 0\text{ mA}$	Legacy chip	65	95	μA	
			New chip	69	95		
		$I_{OUT} = 0\text{ mA}, -40^\circ\text{C} \leq T_J \leq 125^\circ\text{C}$	Legacy chip		125		
			New chip		123		
		$I_{OUT} = 1\text{ mA}$	Legacy chip	75	110		
			New chip	78	110		
		$I_{OUT} = 1\text{ mA}, -40^\circ\text{C} \leq T_J \leq 125^\circ\text{C}$	Legacy chip		170		
			New chip		140		
		$I_{OUT} = 50\text{ mA}$	Legacy chip	350	600		
			New chip	380	440		
		$I_{OUT} = 50\text{ mA}, -40^\circ\text{C} \leq T_J \leq 125^\circ\text{C}$	Legacy chip		1000		
			New chip		650		
		$I_{OUT} = 150\text{ mA}$	Legacy chip	850	1500		
			New chip	765	890		
		$I_{OUT} = 150\text{ mA}, -40^\circ\text{C} \leq T_J \leq 125^\circ\text{C}$	Legacy chip		2500		
			New chip		1060		
		$I_{OUT} = 250\text{ mA}$	Legacy Chip	1500	2300		
			New Chip	875	1010		
$I_{OUT} = 250\text{ mA}, -40^\circ\text{C} \leq T_J \leq 125^\circ\text{C}$	Legacy Chip		4000				
	New Chip		1200				
$V_{ON/OFF} < 0.3\text{ V}, V_{IN} = 16\text{ V}$	Legacy chip	0.01	0.8				
	New chip	1.25	1.75				
$V_{ON/OFF} < 0.15\text{ V}, V_{IN} = 16\text{ V}, -40^\circ\text{C} \leq T_J \leq 125^\circ\text{C}$	Legacy chip	0.05	2				
	New chip	1.12	2.75				

5.4 Electrical Characteristics (续)

specified at $T_J = 25^\circ\text{C}$, $V_{IN} = V_{OUT(nom)} + 1.0\text{ V}$ or $V_{IN} = 2.5\text{ V}$ (whichever is greater), $I_{OUT} = 1\text{ mA}$, $V_{ON/OFF} = 2\text{ V}$, $C_{IN} = 1.0\text{ }\mu\text{F}$, and $C_{OUT} = 2.2\text{ }\mu\text{F}$ (unless otherwise noted)

PARAMETER		TEST CONDITIONS	MIN	TYP	MAX	UNIT	
V_{DO}	Dropout voltage ⁽¹⁾	$I_{OUT} = 0\text{ mA}$	Legacy chip	0.5	2.5	mV	
			New chip	1	2.75		
		$I_{OUT} = 0\text{ mA}$, $-40^\circ\text{C} \leq T_J \leq 125^\circ\text{C}$	Legacy chip		4		
			New chip		3		
		$I_{OUT} = 1\text{ mA}$	Legacy chip	5	9		
			New chip	11.5	14		
		$I_{OUT} = 1\text{ mA}$, $-40^\circ\text{C} \leq T_J \leq 125^\circ\text{C}$	Legacy chip		12		
			New chip		17		
		$I_{OUT} = 50\text{ mA}$	Legacy chip	100	125		
			New chip	120	145		
		$I_{OUT} = 50\text{ mA}$, $-40^\circ\text{C} \leq T_J \leq 125^\circ\text{C}$	Legacy chip		180		
			New chip		184		
		$I_{OUT} = 150\text{ mA}$	Legacy chip	260	325		
			New chip	180	198		
$I_{OUT} = 150\text{ mA}$, $-40^\circ\text{C} \leq T_J \leq 125^\circ\text{C}$	Legacy chip		470				
	New chip		254				
$I_{OUT} = 250\text{ mA}$	Legacy chip	450	575				
	New chip	225	260				
$I_{OUT} = 250\text{ mA}$, $-40^\circ\text{C} \leq T_J \leq 125^\circ\text{C}$	Legacy chip		850				
	New chip		340				
$V_{ON/OFF}$	ON/OFF input voltage	Low = Output OFF	Legacy chip	0.55		V	
			New chip	0.72			
		Low = Output OFF, $V_{OUT} + 1 \leq V_{IN} \leq 16\text{ V}$, $-40^\circ\text{C} \leq T_J \leq 125^\circ\text{C}$	Legacy chip		0.15		
			New chip		0.15		
		High = Output ON	Legacy chip	1.4			
			New chip	0.85			
		High = Output ON, $V_{OUT} + 1 \leq V_{IN} \leq 16\text{ V}$, $-40^\circ\text{C} \leq T_J \leq 125^\circ\text{C}$	Legacy chip	1.6			
			New chip	1.6			
$I_{ON/OFF}$	ON/OFF input current	$V_{ON/OFF} = 0\text{ V}$, $V_{OUT} + 1 \leq V_{IN} \leq 16\text{ V}$, $-40^\circ\text{C} \leq T_J \leq 125^\circ\text{C}$	Legacy chip		-2	μA	
			New chip		-0.9		
$I_{ON/OFF}$	ON/OFF input current	$V_{ON/OFF} = 0\text{ V}$	Legacy chip	0.01		μA	
			New chip	0.42			
$I_{O(PK)}$	Peak output current	$V_{OUT} \geq V_{O(NOM)} - 5\%$ (steady state)	Legacy chip	300	350	mA	
			New chip	300	350		
$I_{O(SC)}$	Short output current	$R_L = 0\text{ }\Omega$ (steady state)	Legacy chip	400		mA	
			New chip	375			
$\Delta V_O / \Delta V_{IN}$	Ripple rejection	$f = 1\text{ kHz}$, $C_{BYPASS} = 10\text{ nF}$, $C_{OUT} = 10\text{ }\mu\text{F}$	Legacy chip	45		dB	
			New chip	78			
V_n	Output noise voltage	Bandwidth = 300 Hz to 50 kHz, $C_{BYPASS} = 10\text{ nF}$, $C_{OUT} = 2.2\text{ }\mu\text{F}$, $V_{OUT} = 3.3\text{ V}$	Legacy chip	30		μVRMS	
			New chip	30			

(1) Dropout voltage (V_{DO}) is defined as the input-to-output differential at which the output voltage drops 100 mV below the value measured with a 1 V differential. V_{DO} is measured with $V_{IN} = V_{OUT(nom)} - 100\text{ mV}$ for fixed output devices.

5.5 Thermal Information

THERMAL METRIC ⁽¹⁾		Legacy Chip ⁽²⁾	New Chip ⁽²⁾	UNIT
		DBV (SOT23-5)	DBV (SOT23-5)	
		5 PINS	5 PINS	
$R_{\theta JA}$	Junction-to-ambient thermal resistance	169.7	178.6	°C/W
$R_{\theta JC(top)}$	Junction-to-case (top) thermal resistance	122.6	77.9	°C/W
$R_{\theta JB}$	Junction-to-board thermal resistance	29.9	47.2	°C/W
ψ_{JT}	Junction-to-top characterization parameter	16.7	15.9	°C/W
ψ_{JB}	Junction-to-board characterization parameter	29.4	46.9	°C/W

- (1) For more information about traditional and new thermal metrics, see the [Semiconductor and IC Package Thermal Metrics](#) application note.
- (2) Thermal performance results are based on the JEDEC standard of 2s2p PCB configuration. These thermal metric parameters can be further improved by 35-55% based on thermally optimized PCB layout designs. See the analysis of the [Impact of board layout on LDO thermal performance](#) application report.

5.6 Typical Characteristics

$C_{IN} = 1 \mu F$, $C_{OUT} = 4.7 \mu F$, $V_{IN} = V_{OUT(NOM)} + 1 V$, $T_A = 25^\circ C$, ON/OFF pin is tied to the IN pin (unless otherwise noted)



图 5-1. V_{OUT} vs Temperature for Legacy Chip



$V_{IN} = 4.3 V$, $V_{OUT} = 3.3 V$ (for new chip)

图 5-2. V_{OUT} vs Temperature for New Chip

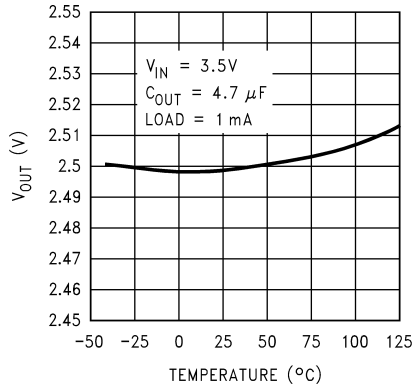
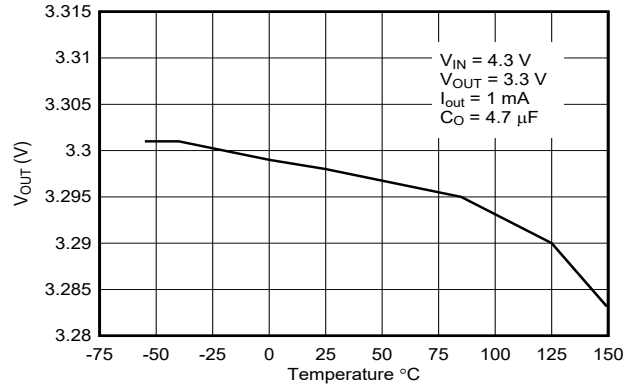

图 5-3. Short-Circuit Current for Legacy Chip



图 5-4. Short-Circuit Current vs Time for New Chip

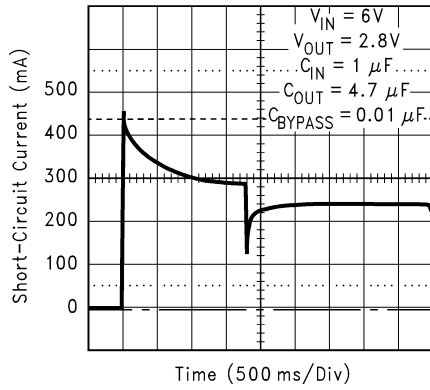

图 5-5. Short-Circuit Current for Legacy Chip

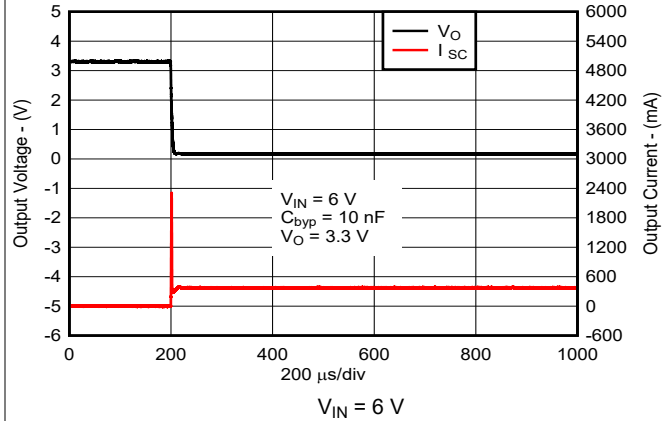

图 5-6. Short-Circuit Current vs Time for New Chip

5.6 Typical Characteristics (continued)

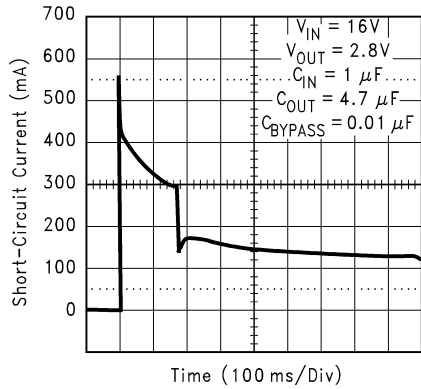
$C_{IN} = 1 \mu F$, $C_{OUT} = 4.7 \mu F$, $V_{IN} = V_{OUT(NOM)} + 1 V$, $T_A = 25^\circ C$, ON/OFF pin is tied to the IN pin (unless otherwise noted)

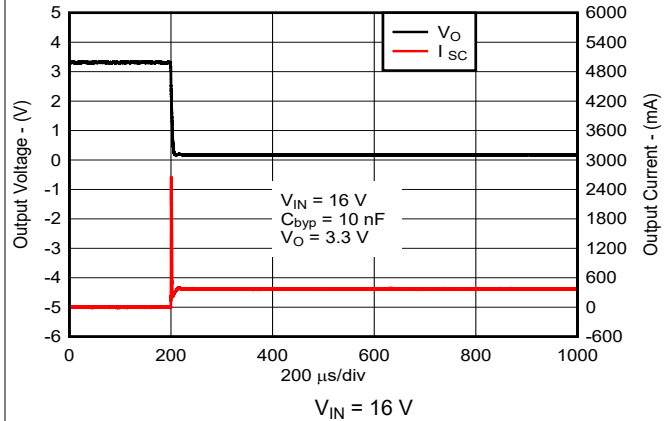

图 5-7. Short-Circuit Current vs Output Voltage for Legacy Chip



图 5-8. Short-Circuit Current vs Output Voltage for New Chip

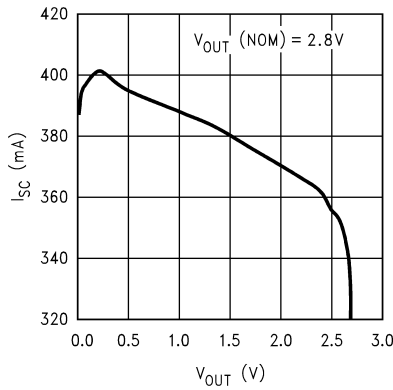

图 5-9. Ripple Rejection vs Frequency for Legacy Chip

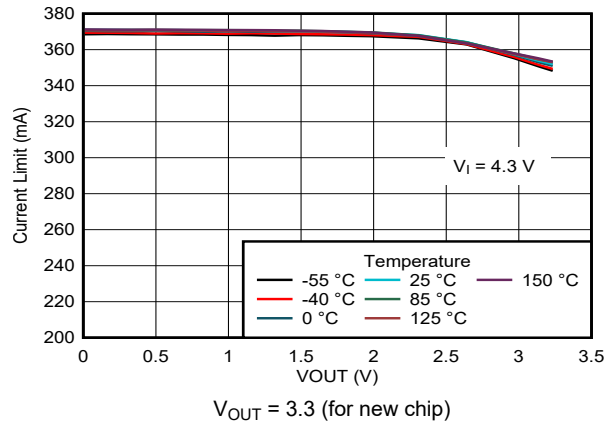

图 5-10. Ripple Rejection vs Frequency for Legacy Chip

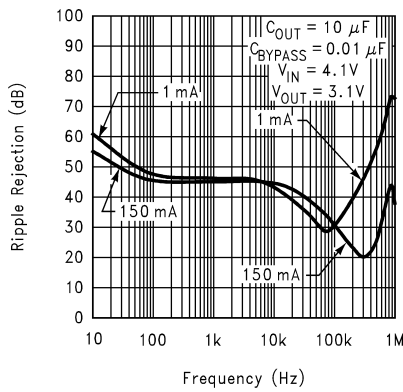

图 5-11. Ripple Rejection vs Frequency for Legacy Chip

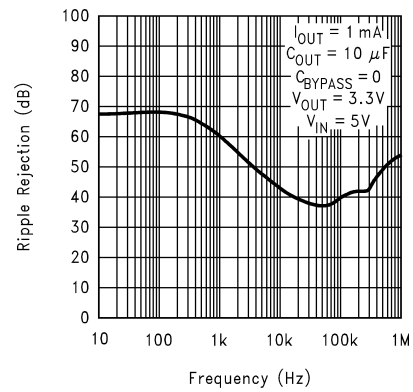

图 5-12. Ripple Rejection vs Frequency for Legacy Chip

5.6 Typical Characteristics (continued)

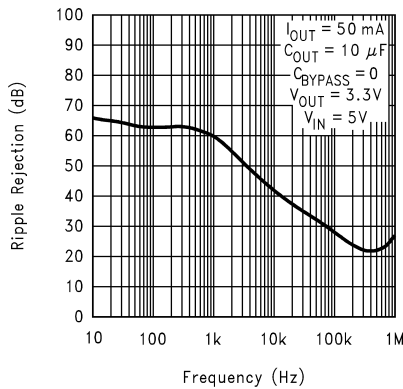
$C_{IN} = 1 \mu\text{F}$, $C_{OUT} = 4.7 \mu\text{F}$, $V_{IN} = V_{OUT(NOM)} + 1 \text{ V}$, $T_A = 25^\circ\text{C}$, ON/OFF pin is tied to the IN pin (unless otherwise noted)

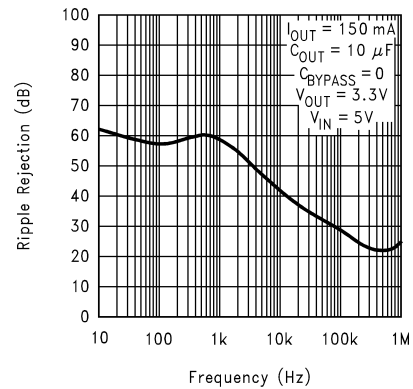

图 5-13. Ripple Rejection vs Frequency for New Chip



图 5-14. Ripple Rejection vs Frequency for Legacy Chip

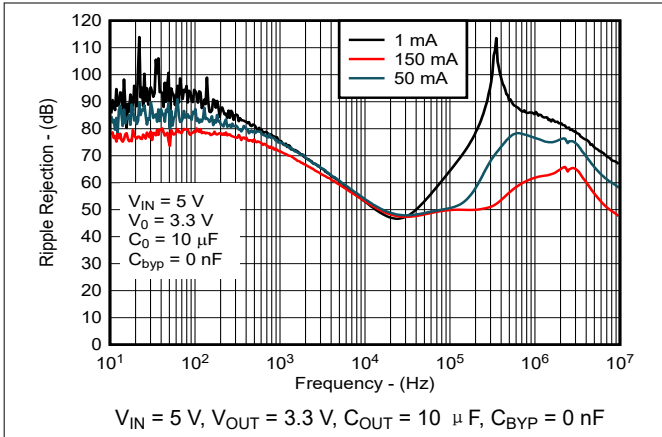

图 5-15. Ripple Rejection vs Frequency for Legacy Chip

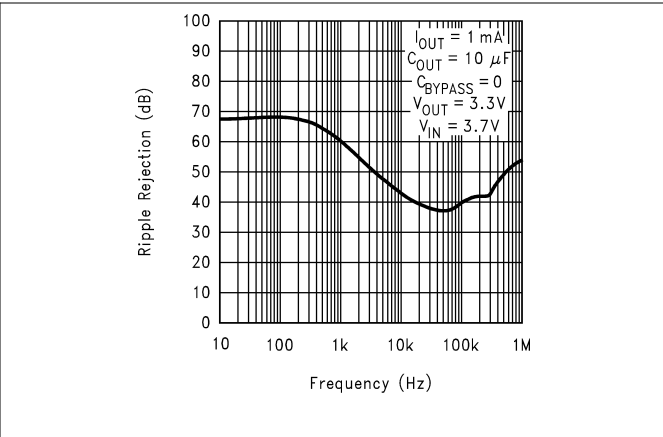

图 5-16. Ripple Rejection vs Frequency for Legacy Chip

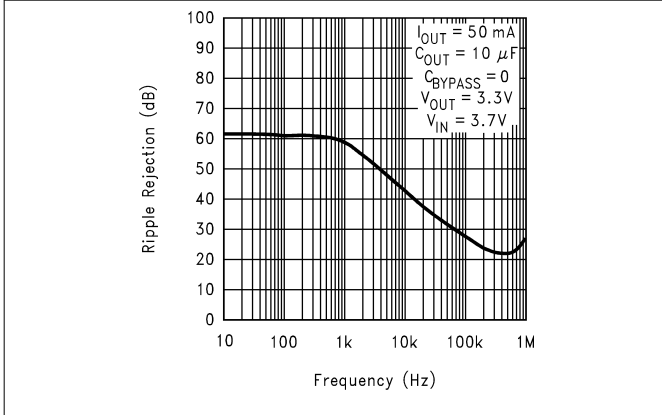

图 5-17. Ripple Rejection vs Frequency for New Chip

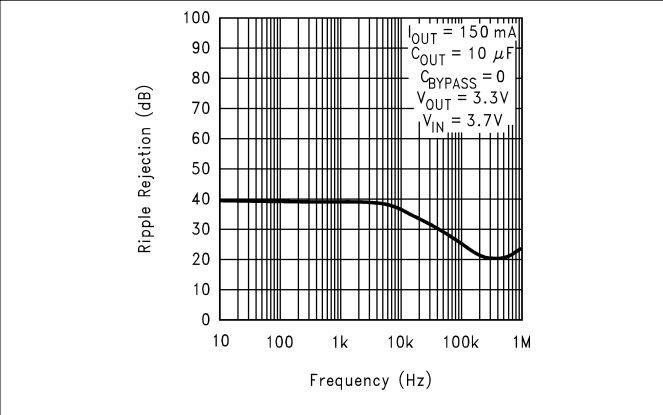

图 5-18. Ripple Rejection vs Frequency for Legacy Chip

5.6 Typical Characteristics (continued)

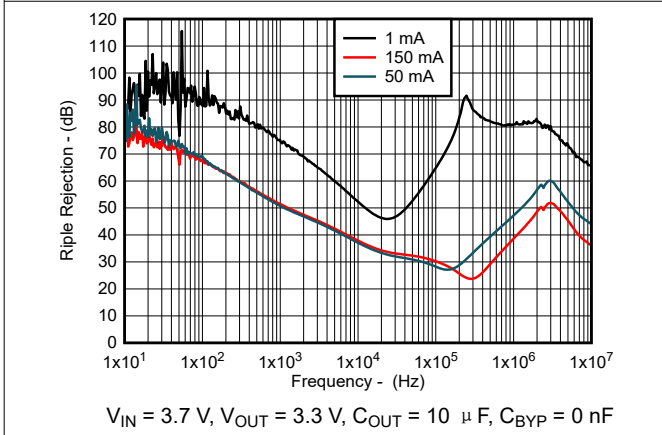
$C_{IN} = 1 \mu F$, $C_{OUT} = 4.7 \mu F$, $V_{IN} = V_{OUT(NOM)} + 1 V$, $T_A = 25^\circ C$, ON/OFF pin is tied to the IN pin (unless otherwise noted)

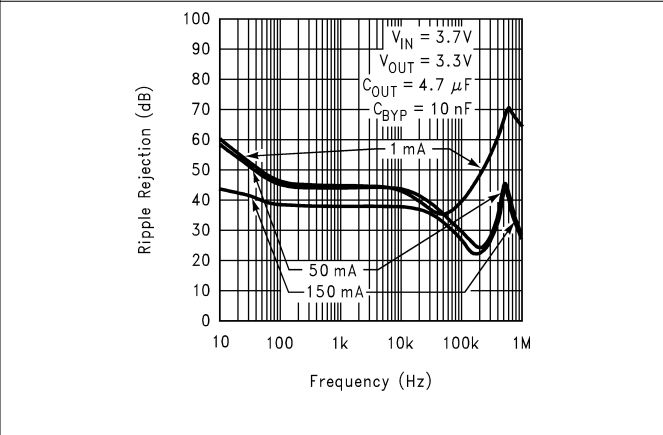

图 5-19. Ripple Rejection vs Frequency for Legacy Chip



$V_{IN} = 5 V$, $V_{OUT} = 3.3 V$, $C_{OUT} = 10 \mu F$, $C_{BYP} = 10 nF$

图 5-20. Ripple Rejection vs Frequency for New Chip

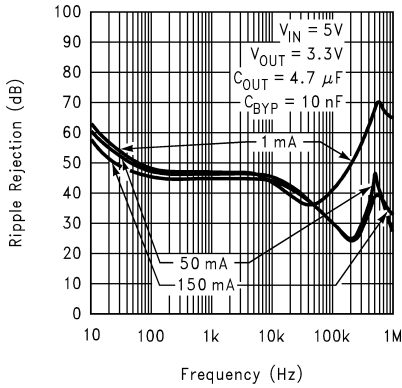
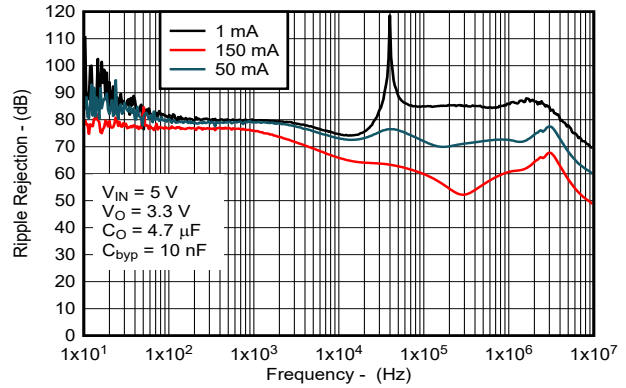

图 5-21. Output Impedance vs Frequency for Legacy Chip



图 5-22. Output Impedance vs Frequency for Legacy Chip

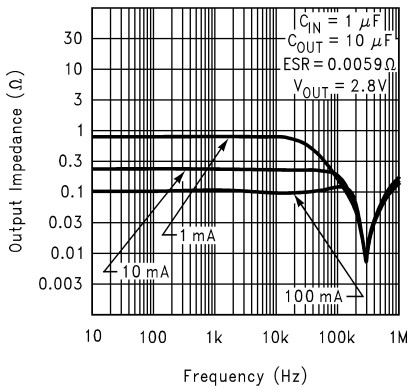

图 5-23. Output Noise Density for Legacy Chip

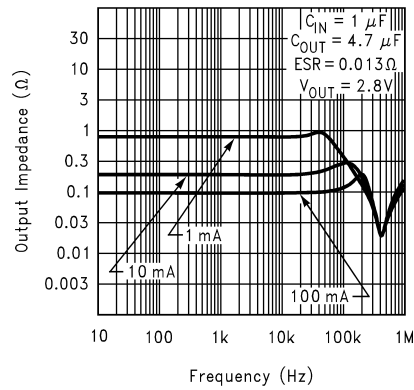

图 5-24. Output Noise Density vs Frequency for New Chip

5.6 Typical Characteristics (continued)

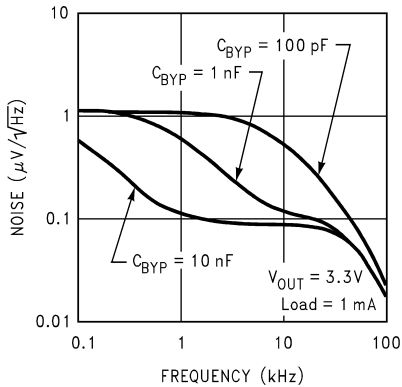
$C_{IN} = 1 \mu\text{F}$, $C_{OUT} = 4.7 \mu\text{F}$, $V_{IN} = V_{OUT(NOM)} + 1 \text{ V}$, $T_A = 25^\circ\text{C}$, ON/OFF pin is tied to the IN pin (unless otherwise noted)

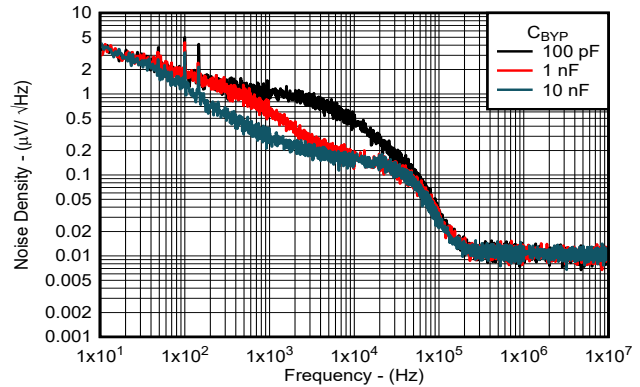

图 5-25. Output Noise Density for Legacy Chip



$V_{OUT} = 3.3 \text{ V}$, $I_{OUT} = 150 \text{ mA}$

图 5-26. Output Noise Density vs Frequency for New Chip

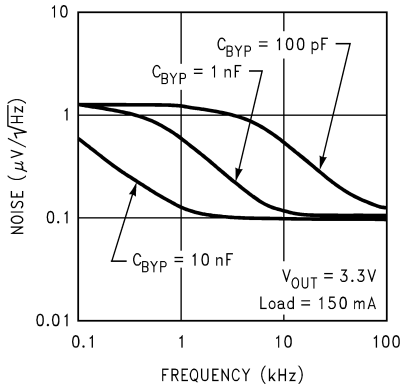
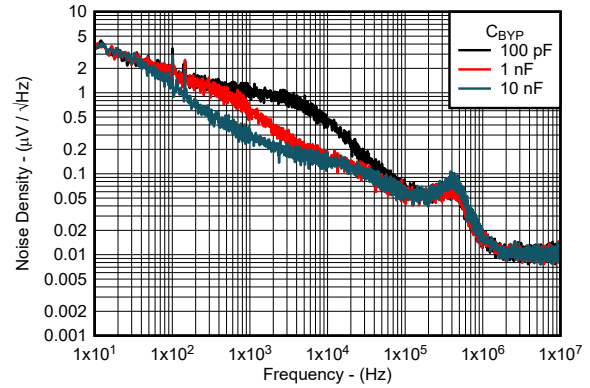

图 5-27. GND Pin vs Load Current for Legacy Chip



图 5-28. GND Pin vs Load Current for New Chip

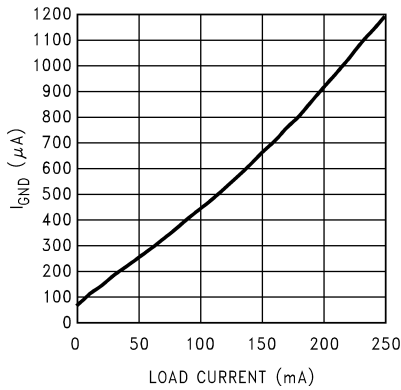

图 5-29. Dropout Voltage vs Temperature for Legacy Chip

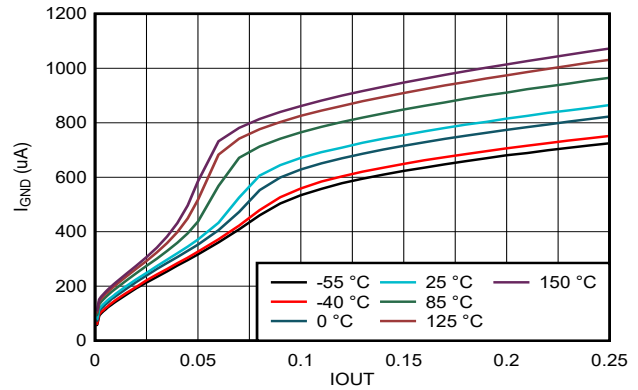

图 5-30. Dropout Voltage vs Temperature for New Chip

5.6 Typical Characteristics (continued)

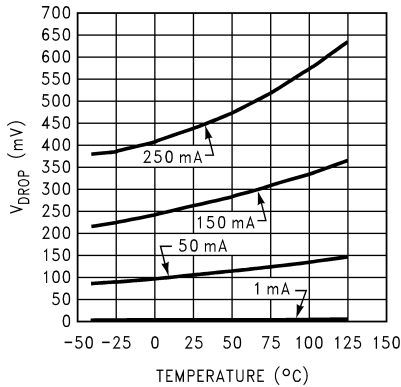
$C_{IN} = 1 \mu F$, $C_{OUT} = 4.7 \mu F$, $V_{IN} = V_{OUT(NOM)} + 1 V$, $T_A = 25^\circ C$, ON/OFF pin is tied to the IN pin (unless otherwise noted)

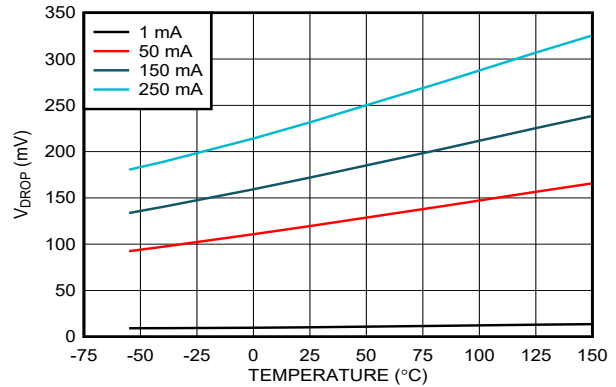

图 5-31. Input Current vs Input Voltage for Legacy Chip



图 5-32. Input Current vs Input Voltage for New Chip

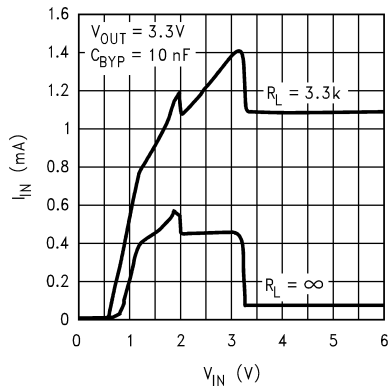

图 5-33. I_{GND} vs Load and Temperature for Legacy Chip

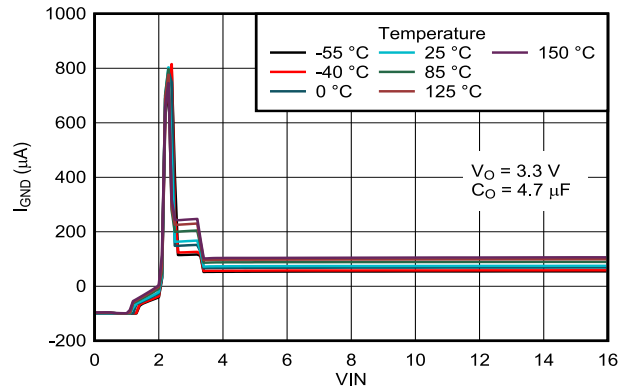

图 5-34. I_{GND} vs Load and Temperature for New Chip

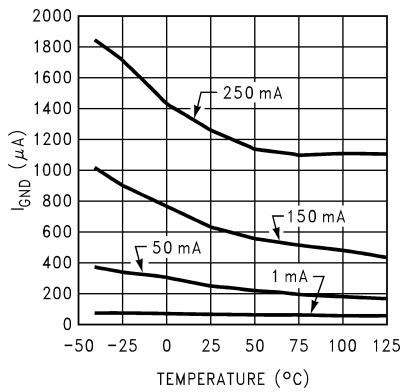

图 5-35. Short-Circuit Current vs Temperature for Legacy Chip

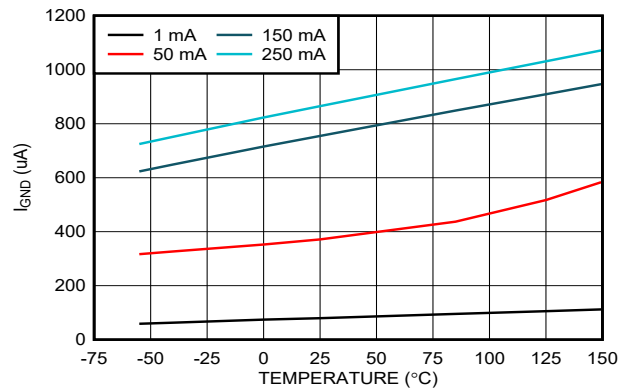

图 5-36. Short-Circuit Current vs Temperature for New Chip

5.6 Typical Characteristics (continued)

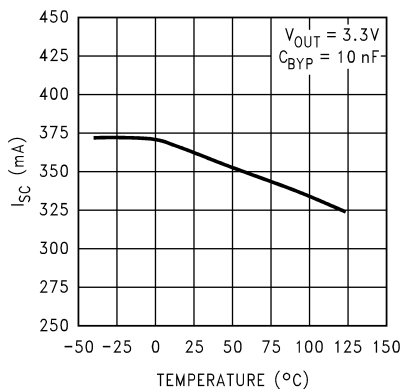
$C_{IN} = 1 \mu F$, $C_{OUT} = 4.7 \mu F$, $V_{IN} = V_{OUT(NOM)} + 1 V$, $T_A = 25^\circ C$, ON/OFF pin is tied to the IN pin (unless otherwise noted)

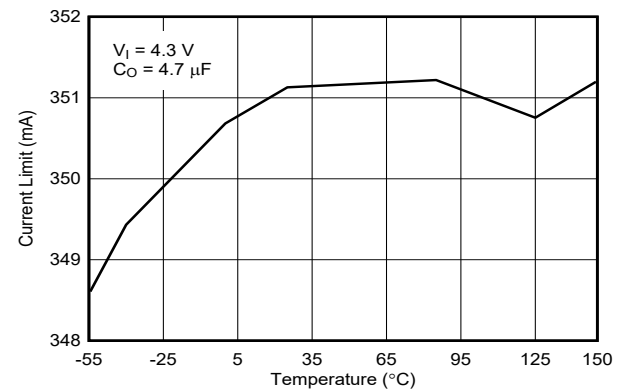

图 5-37. Load Transient Response for Legacy Chip



图 5-38. Load Transient for New Chip

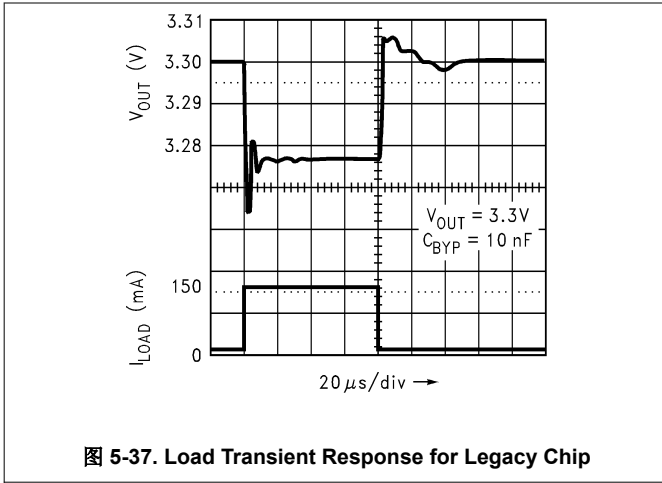

图 5-39. Load Transient Response for Legacy Chip

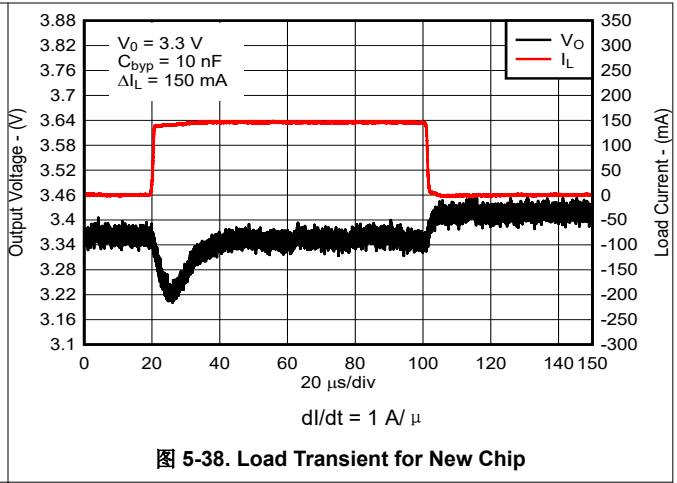

图 5-40. Load Transient Response for New Chip

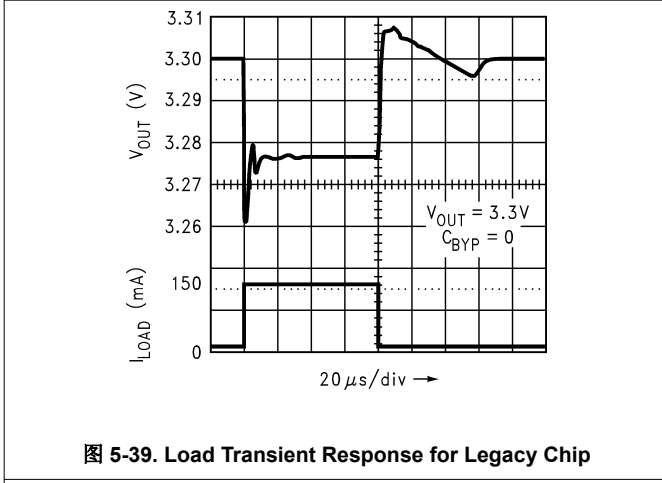

图 5-41. Load Transient Response for Legacy Chip

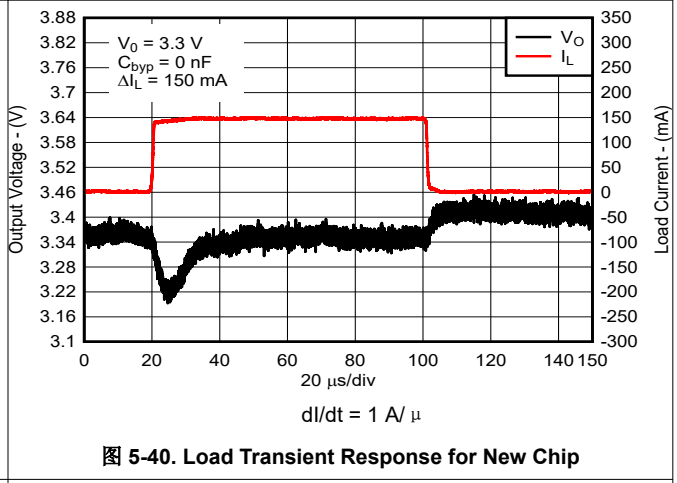

图 5-42. Load Transient Response for New Chip

5.6 Typical Characteristics (continued)

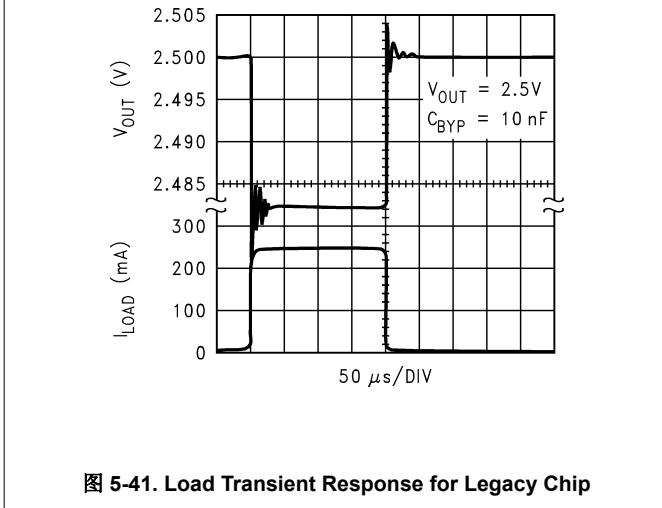
$C_{IN} = 1 \mu F$, $C_{OUT} = 4.7 \mu F$, $V_{IN} = V_{OUT(NOM)} + 1 V$, $T_A = 25^\circ C$, ON/OFF pin is tied to the IN pin (unless otherwise noted)

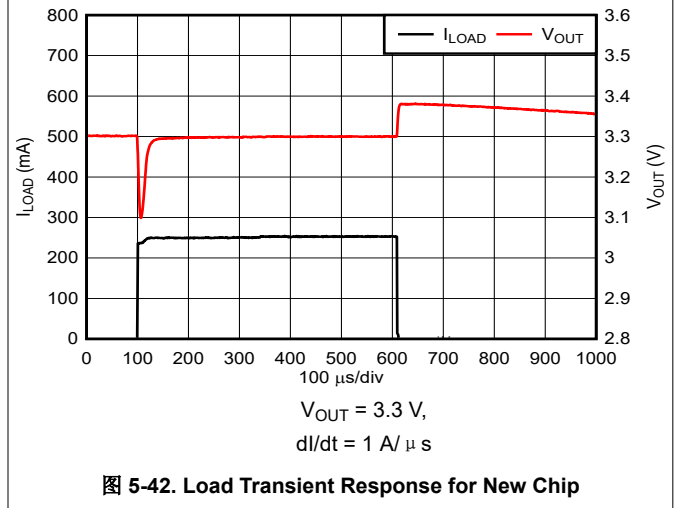

图 5-43. Line Transient Response for Legacy Chip



图 5-44. Line Transient Response for New Chip

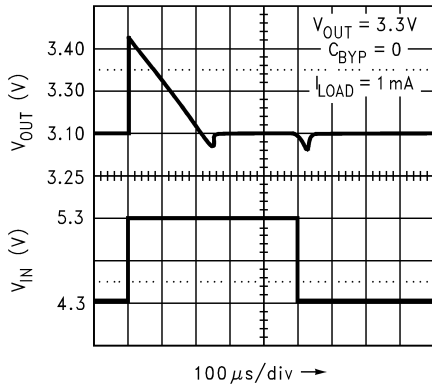

图 5-45. Line Transient Response for Legacy Chip

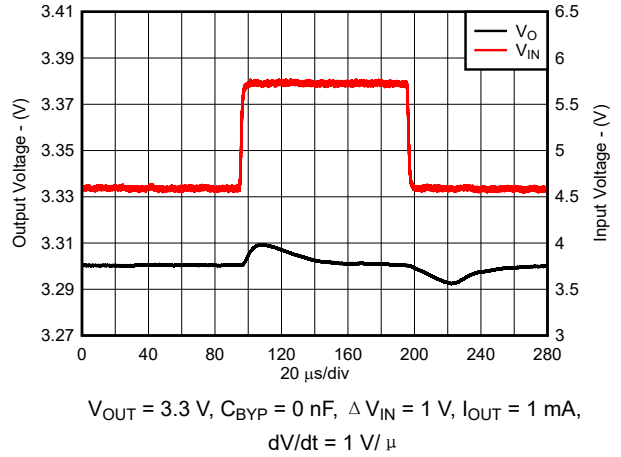

图 5-46. Line Transient Response for New Chip

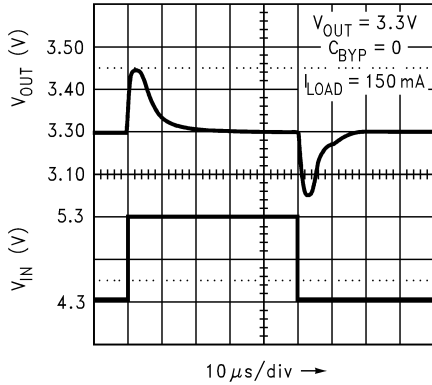

图 5-47. Line Transient Response for Legacy Chip

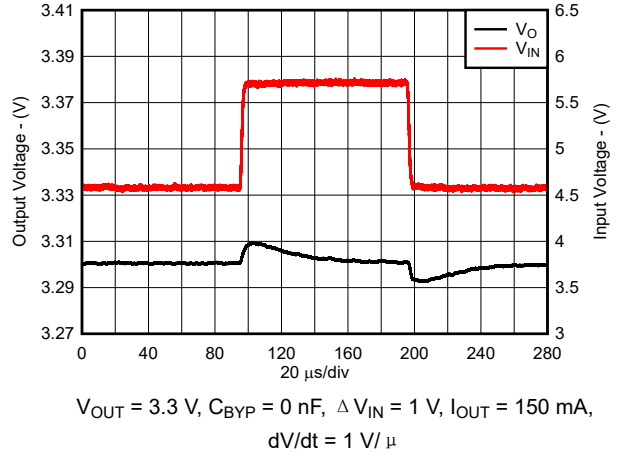

图 5-48. Line Transient Response for New Chip

5.6 Typical Characteristics (continued)

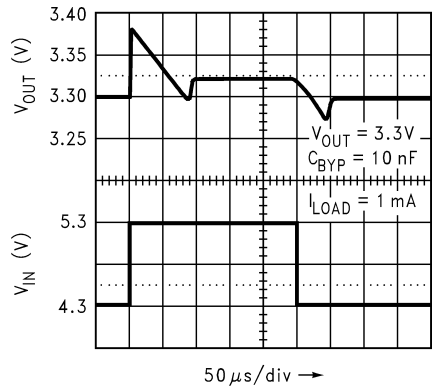
$C_{IN} = 1 \mu F$, $C_{OUT} = 4.7 \mu F$, $V_{IN} = V_{OUT(NOM)} + 1 V$, $T_A = 25^\circ C$, ON/OFF pin is tied to the IN pin (unless otherwise noted)

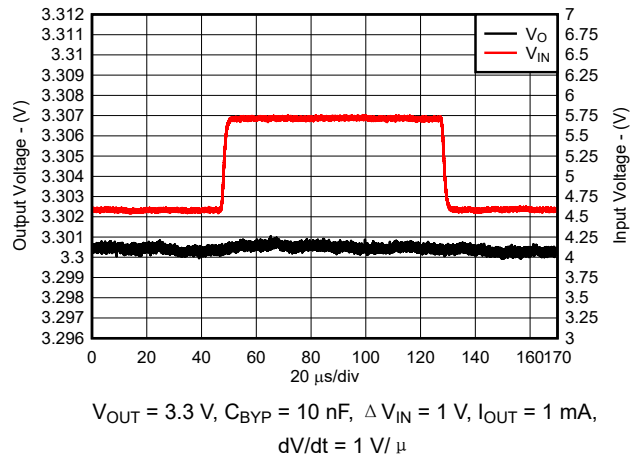

图 5-49. Line Transient Response for Legacy Chip



图 5-50. Line Transient Response for New Chip

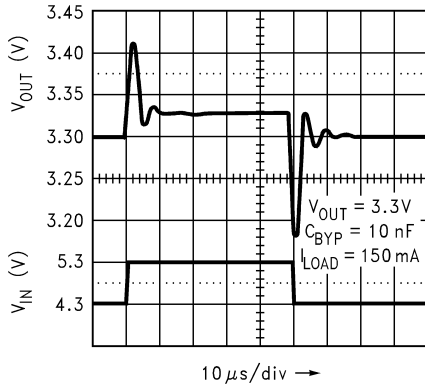

图 5-51. Turn-on Time for Legacy Chip

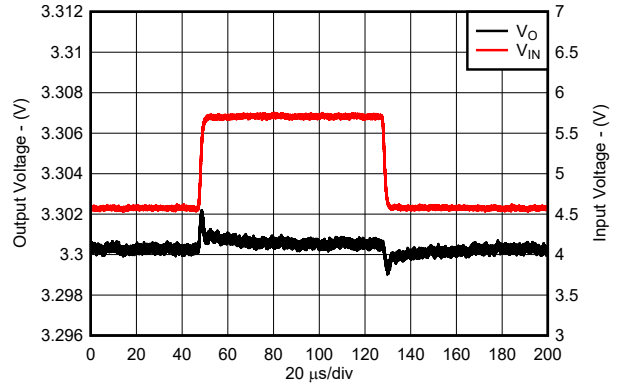

图 5-52. Turn-on Time for New Chip

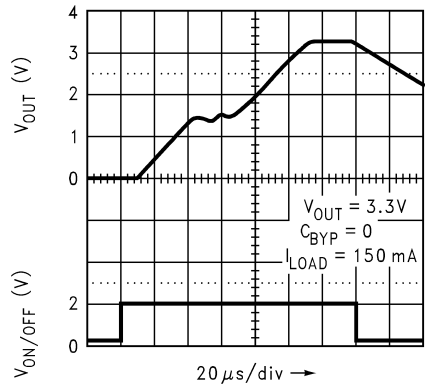

图 5-53. Turn-on Time for Legacy Chip

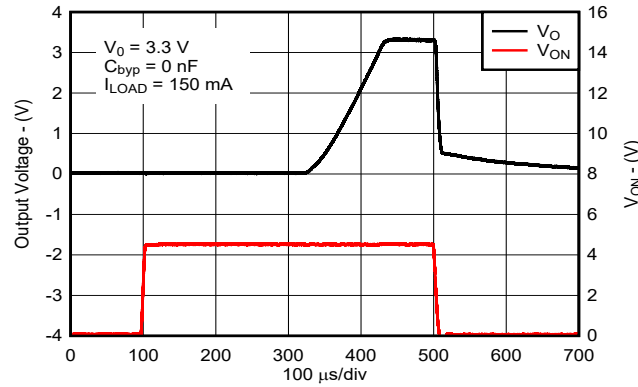

图 5-54. Turn-on Time for New Chip

5.6 Typical Characteristics (continued)

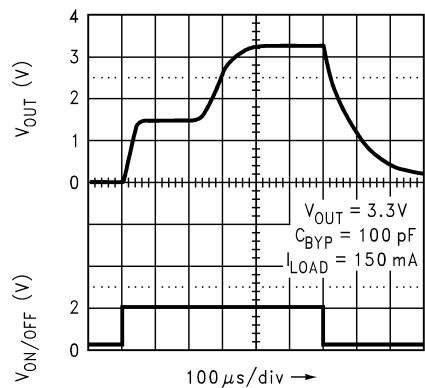
$C_{IN} = 1 \mu F$, $C_{OUT} = 4.7 \mu F$, $V_{IN} = V_{OUT(NOM)} + 1 V$, $T_A = 25^\circ C$, ON/OFF pin is tied to the IN pin (unless otherwise noted)

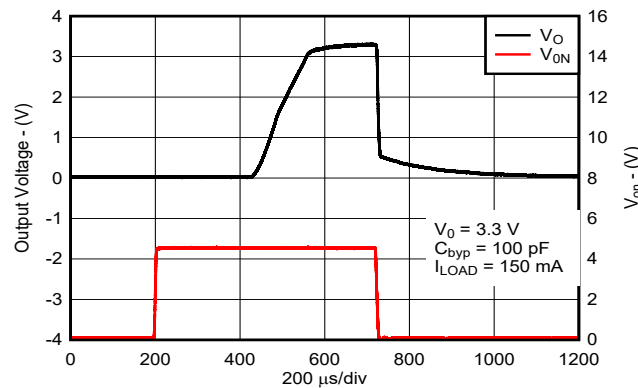

图 5-55. Turn-on Time for Legacy Chip



图 5-56. Turn-on Time for New Chip

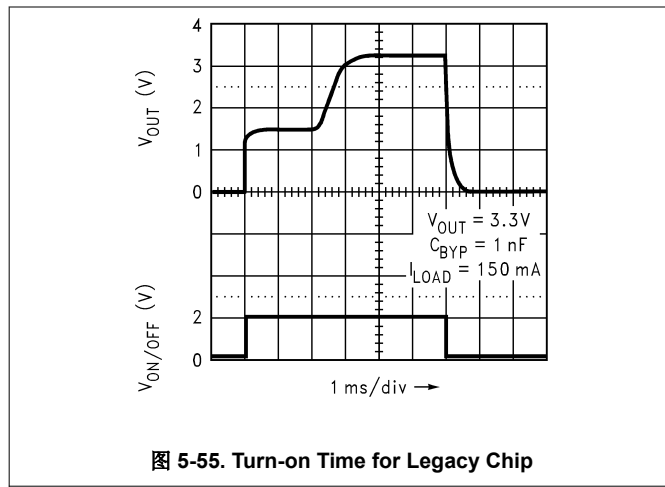

图 5-57. Turn-on Time for Legacy Chip

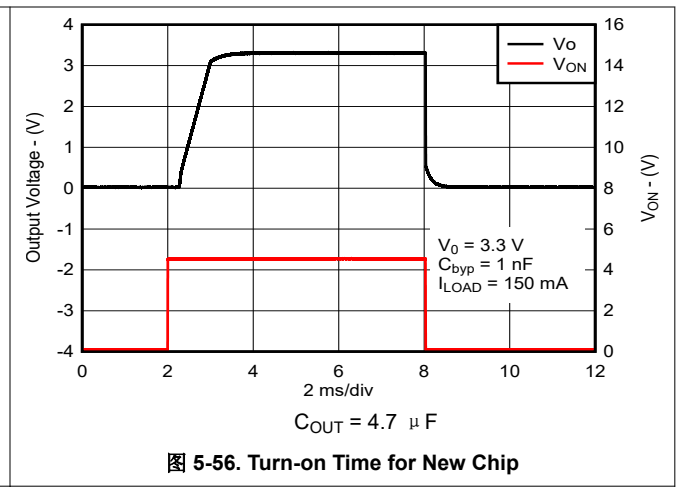

图 5-58. Turn-on Time for New Chip

6 Detailed Description

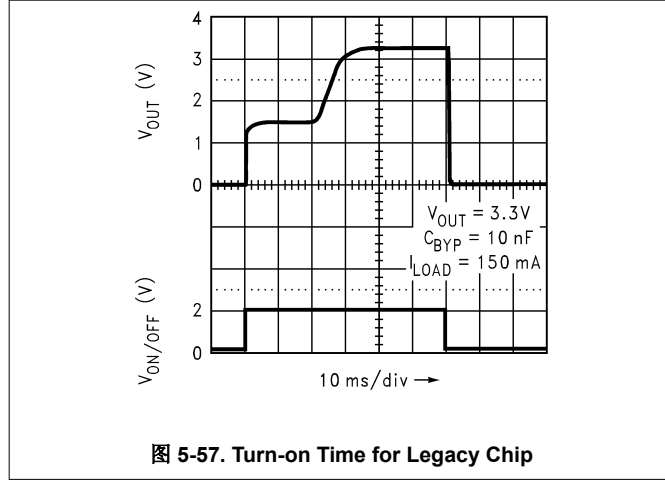
6.1 Overview

The LP2992 is a fixed-output, low-noise, high PSRR, low-dropout regulator that offers exceptional, cost-effective performance for both portable and nonportable applications. The LP2992 has an output tolerance of 1% across line, load, and temperature variation (for the new chip) and is capable of delivering 250 mA of continuous load current.

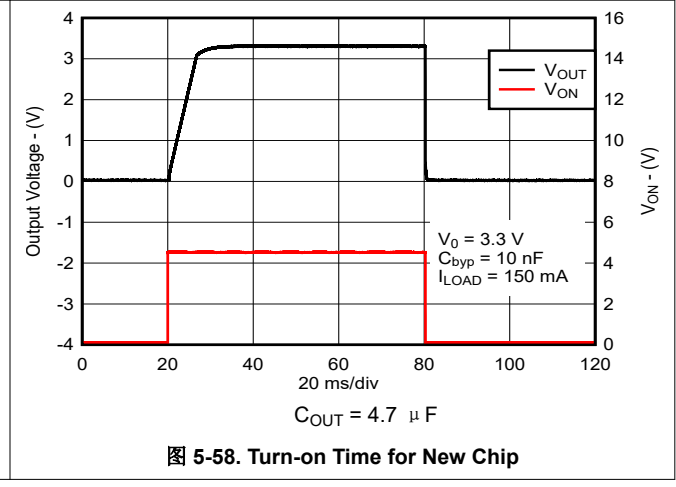
This device features integrated overcurrent protection, thermal shutdown, output enable, and internal output pulldown and has a built-in soft-start mechanism for controlled inrush current. This device delivers excellent line and load transient performance. The operating ambient temperature range of the device is -40°C to 125°C .

6.2 Functional Block Diagram

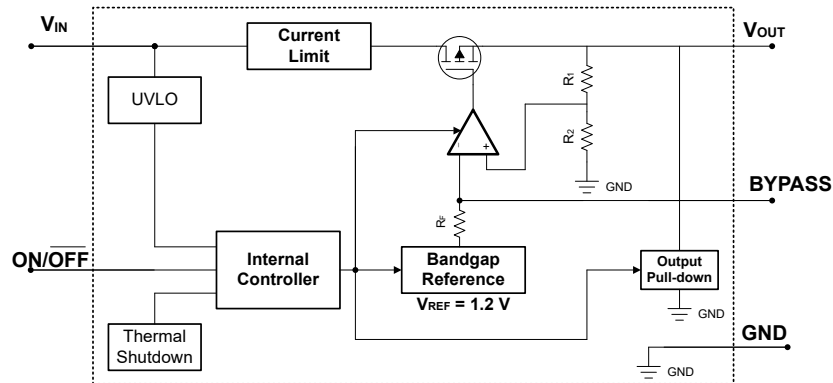

6.3 Feature Description

6.3.1 Output Enable

The ON/ $\overline{\text{OFF}}$ pin for the device is an active-high pin. The output voltage is enabled when the voltage of the ON/ $\overline{\text{OFF}}$ pin is greater than the high-level input voltage of the ON/ $\overline{\text{OFF}}$ pin and disabled with the ON/ $\overline{\text{OFF}}$ pin voltage is less than the low-level input voltage of the ON/ $\overline{\text{OFF}}$ pin. If independent control of the output voltage is not needed, connect the ON/ $\overline{\text{OFF}}$ pin to the input of the device.

The device has an internal pulldown circuit that activates when the device is disabled by pulling the ON/ $\overline{\text{OFF}}$ pin voltage lower than the low-level input voltage of the ON/ $\overline{\text{OFF}}$ pin, to actively discharge the output voltage.

6.3.2 Dropout Voltage

Dropout voltage (V_{DO}) is defined as the input voltage minus the output voltage ($V_{\text{IN}} - V_{\text{OUT}}$) at the rated output current (I_{RATED}), where the pass transistor is fully on. I_{RATED} is the maximum I_{OUT} listed in the [Table 5.3](#). The pass transistor is in the ohmic or triode region of operation, and acts as a switch. The dropout voltage indirectly specifies a minimum input voltage greater than the nominal programmed output voltage at which the output voltage is expected to stay in regulation. If the input voltage falls to less than the nominal output regulation, then the output voltage falls as well.

For a CMOS regulator, the dropout voltage is determined by the drain-source on-state resistance ($R_{DS(ON)}$) of the pass transistor. Therefore, if the linear regulator operates at less than the rated current, the dropout voltage for that current scales accordingly. The following equation calculates the $R_{DS(ON)}$ of the device.

$$R_{DS(ON)} = \frac{V_{DO}}{I_{RATED}} \quad (1)$$

6.3.3 Current Limit

The device has an internal current limit circuit that protects the regulator during transient high-load current faults or shorting events. The current limit is a brick-wall scheme. In a high-load current fault, the brick-wall scheme limits the output current to the current limit (I_{CL}). I_{CL} is listed in the [§ 5.4](#) table.

The output voltage is not regulated when the device is in current limit. When a current limit event occurs, the device begins to heat up because of the increase in power dissipation. When the device is in brick-wall current limit, the pass transistor dissipates power $[(V_{IN} - V_{OUT}) \times I_{CL}]$. If thermal shutdown is triggered, the device turns off. After the device cools down, the internal thermal shutdown circuit turns the device back on. If the output current fault condition continues, the device cycles between current limit and thermal shutdown. For more information on current limits, see the [Know Your Limits](#) application note.

[图 6-1](#) shows a diagram of the current limit.



图 6-1. Current Limit

6.3.4 Undervoltage Lockout (UVLO)

The device has an independent undervoltage lockout (UVLO) circuit that monitors the input voltage, allowing a controlled and consistent turn on and off of the output voltage. To prevent the device from turning off if the input drops during turn on, the UVLO has hysteresis as specified in the [§ 5.4](#) table.

6.3.5 Output Pulldown

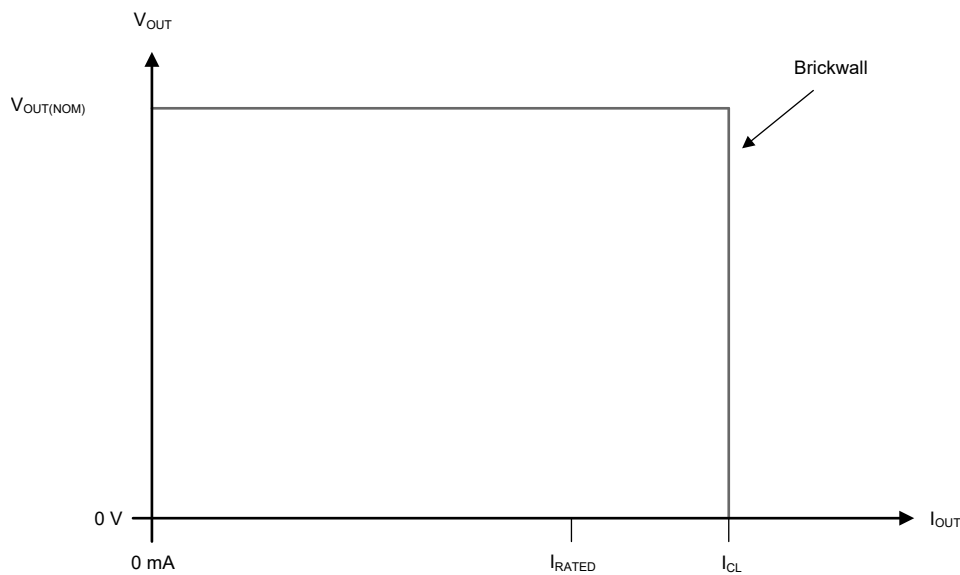
The new chip has an output pulldown circuit. The output pulldown activates in the following conditions:

- When the device is disabled ($V_{ON/OFF} < V_{ON/OFF(LOW)}$)
- If $1.0\text{ V} < V_{IN} < V_{UVLO}$

Do not rely on the output pulldown circuit for discharging a large amount of output capacitance after the input supply has collapsed because reverse current can flow from the output to the input. This reverse current flow can cause damage to the device. See the [§ 7.1.6](#) section for more details.

6.3.6 Thermal Shutdown

The device contains a thermal shutdown protection circuit to disable the device when the junction temperature (T_J) of the pass transistor rises to $T_{SD(shutdown)}$ (typical). Thermal shutdown hysteresis resets (turns on) the device when the temperature falls to $T_{SD(reset)}$ (typical).

The thermal time-constant of the semiconductor die is fairly short, thus the device can cycle on and off when thermal shutdown is reached until power dissipation is reduced. Power dissipation during start up can be high from large $V_{IN} - V_{OUT}$ voltage drops across the device or from high inrush currents charging large output capacitors. Under some conditions, the thermal shutdown protection disables the device before start up completes.

For reliable operation, limit the junction temperature to the maximum listed in the [§ 5.3](#) table. Operation above this maximum temperature causes the device to exceed operational specifications. Although the internal protection circuitry of the device is designed to protect against thermal overall conditions, this circuitry is not intended to replace proper heat sinking. Continuously running the device into thermal shutdown or above the maximum recommended junction temperature reduces long-term reliability.

6.4 Device Functional Modes

6.4.1 Device Functional Mode Comparison

[表 6-1](#) shows the conditions that lead to the different modes of operation. See [§ 5.4](#) for parameter values.

表 6-1. Device Functional Mode Comparison

OPERATING MODE	PARAMETER			
	V_{IN}	$V_{ON/OFF}$	I_{OUT}	T_J
Normal operation	$V_{IN} > V_{OUT(nom)} + V_{DO}$ and $V_{IN} > V_{IN(min)}$	$V_{ON/OFF} > V_{ON/OFF(HI)}$	$I_{OUT} < I_{OUT(max)}$	$T_J < T_{SD(shutdown)}$
Dropout operation	$V_{IN(min)} < V_{IN} < V_{OUT(nom)} + V_{DO}$	$V_{ON/OFF} > V_{ON/OFF(HI)}$	$I_{OUT} < I_{OUT(max)}$	$T_J < T_{SD(shutdown)}$
Disabled (any true condition disables the device)	$V_{IN} < V_{UVLO}$	$V_{ON/OFF} < V_{ON/OFF(LOW)}$	Not applicable	$T_J > T_{SD(shutdown)}$

6.4.2 Normal Operation

The device regulates to the nominal output voltage when the following conditions are met:

- The input voltage is greater than the nominal output voltage plus the dropout voltage ($V_{OUT(nom)} + V_{DO}$)
- The output current is less than the current limit ($I_{OUT} < I_{CL}$)
- The device junction temperature is less than the thermal shutdown temperature ($T_J < T_{SD}$)
- The ON/OFF voltage has previously exceeded the ON/OFF rising threshold voltage and has not yet decreased to less than the enable falling threshold

6.4.3 Dropout Operation

If the input voltage is lower than the nominal output voltage plus the specified dropout voltage, but all other conditions are met for normal operation, the device operates in dropout mode. In this mode, the output voltage tracks the input voltage. During this mode, the transient performance of the device becomes significantly degraded because the pass transistor is in the ohmic or triode region, and acts as a switch. Line or load transients in dropout can result in large output-voltage deviations.

When the device is in a steady dropout state (defined as when the device is in dropout, $V_{IN} < V_{OUT(NOM)} + V_{DO}$, directly after being in a normal regulation state, but *not* during start up), the pass transistor is driven into the ohmic or triode region. When the input voltage returns to a value greater than or equal to the nominal output voltage plus the dropout voltage ($V_{OUT(NOM)} + V_{DO}$), the output voltage can overshoot for a short period of time while the device pulls the pass transistor back into the linear region.

6.4.4 Disabled

The output of the device can be shutdown by forcing the voltage of the $\overline{ON/OFF}$ pin to less than the maximum $\overline{ON/OFF}$ pin low-level input voltage (see the [§ 5.4](#) table). When disabled, the pass transistor is turned off, internal circuits are shutdown, and the output voltage is actively discharged to ground by an internal discharge circuit from the output to ground.

7 Application and Implementation

备注

以下应用部分中的信息不属于 TI 器件规格的范围，TI 不担保其准确性和完整性。TI 的客户应负责确定器件是否适用于其应用。客户应验证并测试其设计，以确保系统功能。

7.1 Application Information

7.1.1 Estimating Junction Temperature

The JEDEC standard now recommends the use of psi (Ψ) thermal metrics to estimate the junction temperatures of the linear regulator when in-circuit on a typical PCB board application. These metrics are not thermal resistance parameters and instead offer a practical and relative way to estimate junction temperature. These psi metrics are determined to be significantly independent of the copper area available for heat-spreading. 节 5.5 lists the primary thermal metrics, which are the junction-to-top characterization parameter (Ψ_{JT}) and junction-to-board characterization parameter (Ψ_{JB}). These parameters provide two methods for calculating the junction temperature (T_J), as described in the following equations. Use the junction-to-top characterization parameter (Ψ_{JT}) with the temperature at the center-top of device package (T_T) to calculate the junction temperature. Use the junction-to-board characterization parameter (Ψ_{JB}) with the PCB surface temperature 1 mm from the device package (T_B) to calculate the junction temperature.

$$T_J = T_T + \Psi_{JT} \times P_D \quad (2)$$

where:

- P_D is the dissipated power
- T_T is the temperature at the center-top of the device package

$$T_J = T_B + \Psi_{JB} \times P_D \quad (3)$$

where:

- T_B is the PCB surface temperature measured 1 mm from the device package and centered on the package edge

For detailed information on the thermal metrics and how to use them, see the [Semiconductor and IC Package Thermal Metrics](#) application note.

7.1.2 Input and Output Capacitor Requirements

Although an input capacitor is not required for stability, good analog design practice is to connect a capacitor from IN to GND. This capacitor counteracts reactive input sources and improves transient response, input ripple, and PSRR. Use an input capacitor if the source impedance is more than 0.5Ω . A higher value capacitor can be necessary if large, fast rise-time load or line transients are anticipated or if the device is located several inches from the input power source.

Dynamic performance of the device is improved with the use of an output capacitor. Use an output capacitor within the range specified in the 节 5.3 table for stability.

7.1.3 Noise Bypass Capacitor (C_{BYPASS})

The LP2992 allows for low-noise performance with the use of a bypass capacitor that is connected to the internal band-gap reference with the BYPASS pin. This high-impedance band-gap circuitry is biased in the microampere range and, thus, cannot be loaded significantly, otherwise, the output (and, correspondingly, the output of the regulator) changes. Thus, for best output accuracy, dc leakage current through C_{BYPASS} must be minimized as much as possible and must never exceed 100 nA. The C_{BYPASS} capacitor also impacts the start-up behavior of the regulator. Inrush current and start-up time increase with larger bypass capacitor values.

Use a 10-nF capacitor for C_{BYPASS} . Ceramic and film capacitors are good choices for this purpose.

7.1.4 Power Dissipation (P_D)

Circuit reliability requires consideration of the device power dissipation, location of the circuit on the printed circuit board (PCB), and correct sizing of the thermal plane. The PCB area around the regulator must have few or no other heat-generating devices that cause added thermal stress.

To first-order approximation, power dissipation in the regulator depends on the input-to-output voltage difference and load conditions. The following equation calculates power dissipation (P_D).

$$P_D = (V_{\text{IN}} - V_{\text{OUT}}) \times I_{\text{OUT}} \quad (4)$$

备注

Power dissipation can be minimized, and therefore greater efficiency can be achieved, by correct selection of the system voltage rails. For the lowest power dissipation use the minimum input voltage required for correct output regulation.

For devices with a thermal pad, the primary heat conduction path for the device package is through the thermal pad to the PCB. Solder the thermal pad to a copper pad area under the device. This pad area must contain an array of plated vias that conduct heat to additional copper planes for increased heat dissipation.

The maximum power dissipation determines the maximum allowable ambient temperature (T_A) for the device. According to the following equation, power dissipation and junction temperature are most often related by the junction-to-ambient thermal resistance ($R_{\theta \text{JA}}$) of the combined PCB and device package and the temperature of the ambient air (T_A).

$$T_J = T_A + (R_{\theta \text{JA}} \times P_D) \quad (5)$$

Thermal resistance ($R_{\theta \text{JA}}$) is highly dependent on the heat-spreading capability built into the particular PCB design, and therefore varies according to the total copper area, copper weight, and location of the planes. The junction-to-ambient thermal resistance listed in 节 5.5 table is determined by the JEDEC standard PCB and copper-spreading area, and is used as a relative measure of package thermal performance.

7.1.5 Recommended Capacitor Types

The device is designed to be stable using low equivalent series resistance (ESR) ceramic capacitors at the input and output. Multilayer ceramic capacitors have become the industry standard for these types of applications and are recommended, but must be used with good judgment. Ceramic capacitors that employ X7R-, X5R-, and C0G-rated dielectric materials provide relatively good capacitive stability across temperature, whereas the use of Y5V-rated capacitors is discouraged because of large variations in capacitance.

Regardless of the ceramic capacitor type selected, the effective capacitance varies with operating voltage and temperature. Generally, expect the effective capacitance to decrease by as much as 50%. The input and output capacitors listed in 节 5.3 account for an effective capacitance of approximately 50% of the nominal value.

7.1.6 Reverse Current

Excessive reverse current can damage this device. Reverse current flows through the intrinsic body diode of the pass transistor instead of the normal conducting channel. At high magnitudes, this current flow degrades the long-term reliability of the device.

Conditions where reverse current can occur are outlined in this section, all of which can exceed the absolute maximum rating of $V_{\text{OUT}} \leq V_{\text{IN}} + 0.3 \text{ V}$.

- If the device has a large C_{OUT} and the input supply collapses with little or no load current
- The output is biased when the input supply is not established
- The output is biased above the input supply

If reverse current flow is expected in the application, use external protection to protect the device. Reverse current is not limited in the device, so external limiting is required if extended reverse voltage operation is anticipated.

图 7-1 shows one approach for protecting the device.



图 7-1. Example Circuit for Reverse Current Protection Using a Schottky Diode

7.2 Typical Application

图 7-2 shows the standard usage of the LP2992 as a low-dropout regulator.

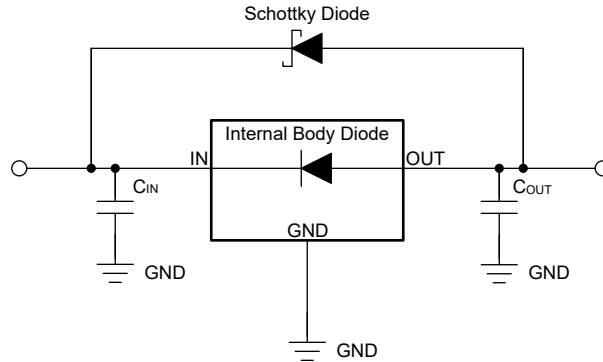

图 7-2. LP2992 Typical Application

7.2.1 Design Requirements

Minimum C_{OUT} value for stability (can be increased without limit for improved stability and transient response)

ON/ $\overline{\text{OFF}}$ must be actively terminated. Connect to V_{IN} if shutdown feature is not used.

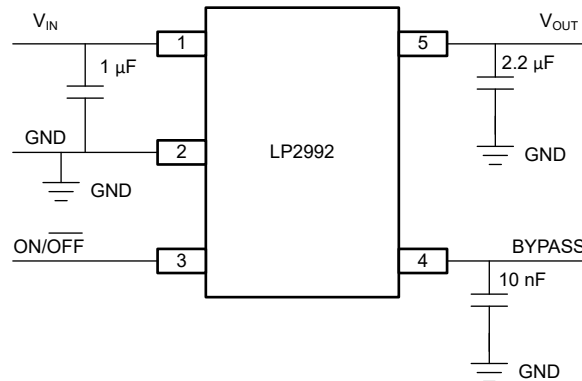
Optional BYPASS capacitor for low-noise operation.

7.2.2 Detailed Design Procedure

7.2.2.1 ON/ $\overline{\text{OFF}}$ Operation

The LP2992 allows for a shutdown mode using the ON/ $\overline{\text{OFF}}$ pin. Driving the pin LOW (≤ 0.4 V) turns the device OFF; conversely, a HIGH (≥ 1.2 V) turns the device ON. If the shutdown feature is not used, connect ON/ $\overline{\text{OFF}}$ to the input so that the regulator is on at all times. For proper operation, do not leave ON/ $\overline{\text{OFF}}$ unconnected.

7.2.3 Application Curves

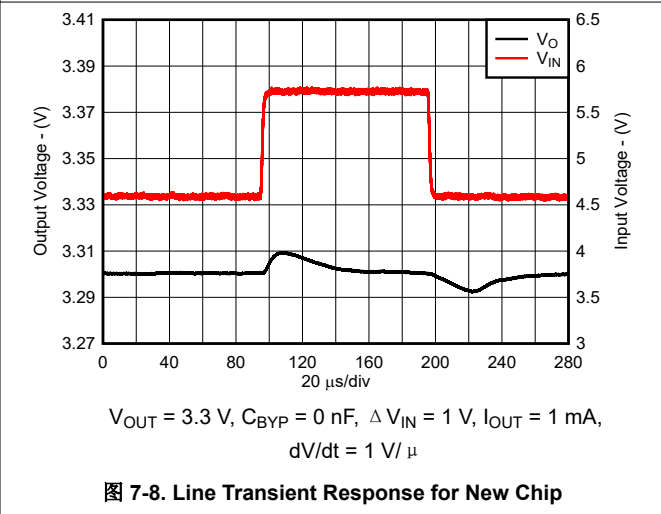
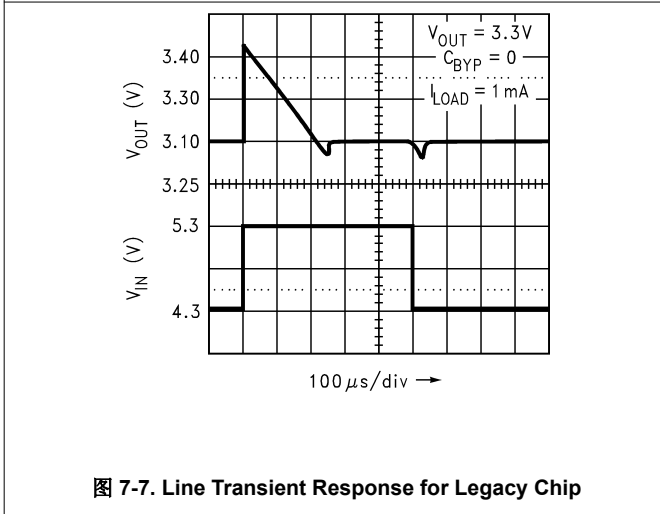
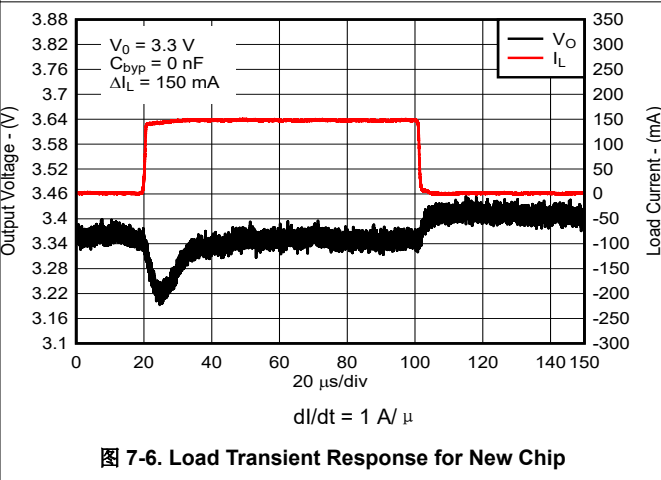
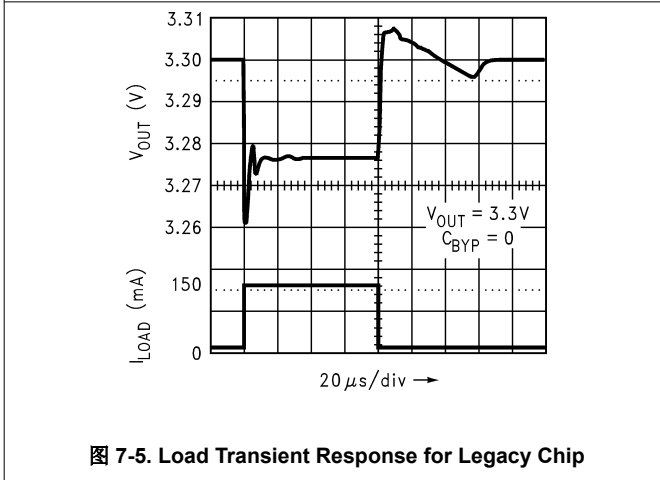
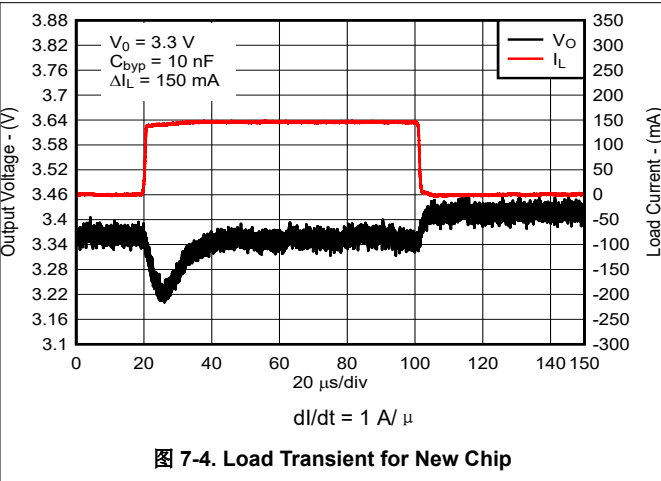
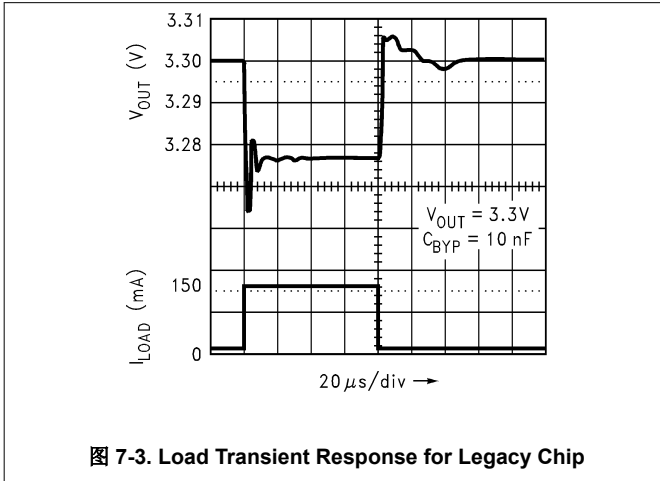

7.2.3 Application Curves (continued)



图 7-9. Line Transient Response for Legacy Chip



图 7-10. Line Transient Response for New Chip

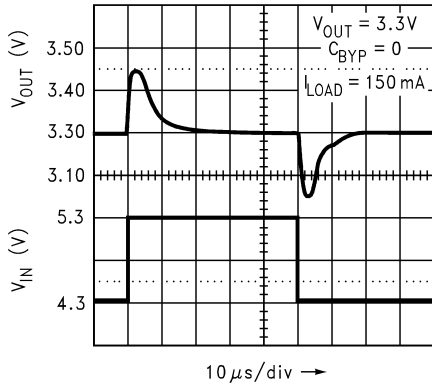

图 7-11. Turn-on Time for Legacy Chip

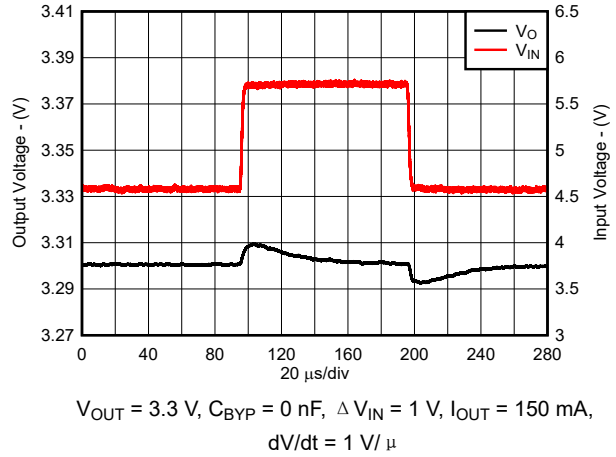

图 7-12. Turn-on Time for New Chip

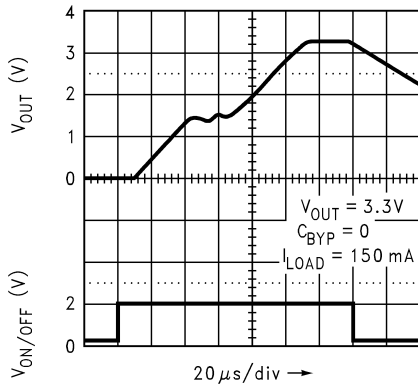

图 7-13. Turn-on Time for Legacy Chip

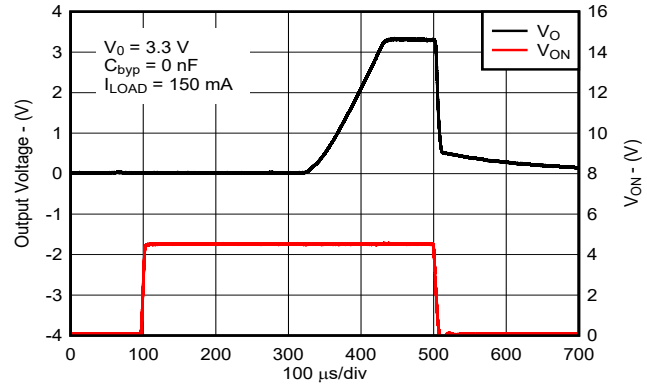

图 7-14. Turn-on Time for New Chip

8 Power Supply Recommendations

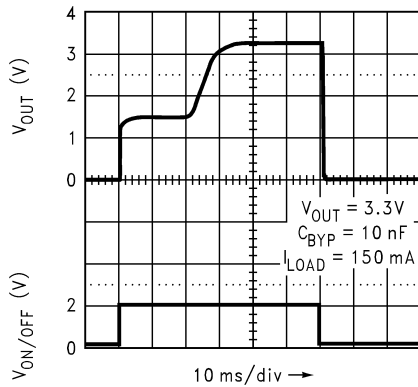
A power supply can be used at the input voltage within the ranges given in the [Recommended Operating Conditions](#) table. Use bypass capacitors as described in the [节 9.1](#) section.

9 Layout

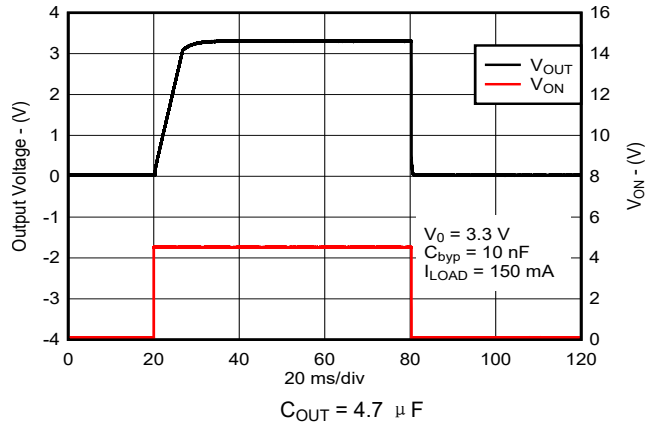
9.1 Layout Guidelines

- Bypass the input pin to ground with a bypass capacitor.
- The optimum placement of the bypass capacitor is closest to the V_{IN} of the device and GND of the system. Care must be taken to minimize the loop area formed by the bypass capacitor connection, the V_{IN} pin, and the GND pin of the system.
- For operation at full-rated load, use wide trace lengths to eliminate IR drop and heat dissipation.

9.2 Layout Examples



图 9-1. Layout Diagram

10 Device and Documentation Support

10.1 Device Nomenclature

表 10-1. Available Options

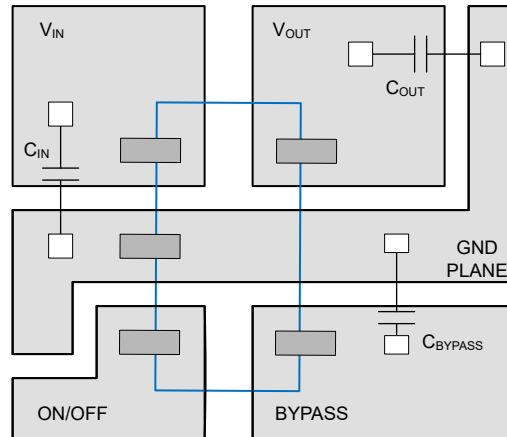
PRODUCT ⁽¹⁾	V _{OUT}
LP2992- xyyyz Legacy chip	xx is the nominal output voltage (for example, 33 = 3.3 V; 50 = 5.0 V). yyy is the package designator. z is the package quantity. R is for large quantity reel, T is for small quantity reel.
LP2992- xyyyzM3 New chip	xx is the nominal output voltage (for example, 33 = 3.3 V; 50 = 5.0 V). yyy is the package designator. z is the package quantity. R is for large quantity reel, T is for small quantity reel. M3 is a suffix designator for newer chip redesigns, fabricated on the latest TI process technology.

(1) For the most current package and ordering information, see the Package Option Addendum at the end of this document, or visit the device product folder at www.ti.com.

10.2 Documentation Support

10.2.1 Related Documentation

For related documentation see the following:

- Texas Instruments, [AN-1187 Leadless Leadframe Package \(LLP\)](#), application note
- Texas Instruments, [Semiconductor and IC Package Thermal Metrics](#), application note
- Texas Instruments, [Using New Thermal Metrics](#), application note
- Texas Instruments, [Thermal Characteristics of Linear and Logic Packages Using JEDEC PCB Designs](#), application note

10.3 Receiving Notification of Documentation Updates

To receive notification of documentation updates, navigate to the device product folder on ti.com. In the upper right corner, click on *Alert me* to register and receive a weekly digest of any product information that has changed. For change details, review the revision history included in any revised document.

10.4 支持资源

[TI E2E™ 中文支持论坛](#)是工程师的重要参考资料，可直接从专家处获得快速、经过验证的解答和设计帮助。搜索现有解答或提出自己的问题，获得所需的快速设计帮助。

链接的内容由各个贡献者“按原样”提供。这些内容并不构成 TI 技术规范，并且不一定反映 TI 的观点；请参阅 TI 的[使用条款](#)。

10.5 Trademarks

TI E2E™ is a trademark of Texas Instruments.

所有商标均为其各自所有者的财产。

10.6 静电放电警告



静电放电 (ESD) 会损坏这个集成电路。德州仪器 (TI) 建议通过适当的预防措施处理所有集成电路。如果不遵守正确的处理和安装程序，可能会损坏集成电路。

ESD 的损坏小至导致微小的性能降级，大至整个器件故障。精密的集成电路可能更容易受到损坏，这是因为非常细微的参数更改都可能会导致器件与其发布的规格不相符。

10.7 术语表

[TI 术语表](#) 本术语表列出并解释了术语、首字母缩略词和定义。

11 Revision History

注：以前版本的页码可能与当前版本的页码不同

Changes from Revision J (January 2017) to Revision K (December 2023)	Page
• 更新了整个文档中的表格、图和交叉参考的编号格式。.....	1
• 更改了整个文档，以便与当前系列格式保持一致.....	1
• 向文档添加了 M3 器件.....	1
• 更新了整个文档中的表格、图和交叉参考的编号格式。.....	1
• Updated Absolute Maximum Ratings, Recommended Operating Conditions, Electrical Characteristics and Thermal Information for M3-suffix(new chip).....	5
• Added <i>Device Nomenclature</i> section.....	29
Changes from Revision I (November 2015) to Revision J (January 2017)	Page
• 删除了 <i>简化版原理图</i> 中电容器的特定值.....	1
• Added <i>Receiving Notification of Documentation Updates</i>	29

12 Mechanical, Packaging, and Orderable Information

The following pages include mechanical, packaging, and orderable information. This information is the most current data available for the designated devices. This data is subject to change without notice and revision of this document. For browser-based versions of this data sheet, refer to the left-hand navigation.

PACKAGING INFORMATION

Orderable Device	Status (1)	Package Type	Package Drawing	Pins	Package Qty	Eco Plan (2)	Lead finish/ Ball material (6)	MSL Peak Temp (3)	Op Temp (°C)	Device Marking (4/5)	Samples
LP2992AILD-1.5/NOPB	ACTIVE	WSON	NGD	6	1000	RoHS & Green	SN	Level-3-260C-168 HR	-40 to 125	L011A	Samples
LP2992AILD-1.8/NOPB	ACTIVE	WSON	NGD	6	1000	RoHS & Green	NIPDAU SN	Level-3-260C-168 HR	-40 to 125	L012A	Samples
LP2992AILD-3.3/NOPB	ACTIVE	WSON	NGD	6	1000	RoHS & Green	NIPDAU SN	Level-3-260C-168 HR	-40 to 125	L014A	Samples
LP2992AILD-5.0/NOPB	ACTIVE	WSON	NGD	6	1000	RoHS & Green	NIPDAU SN	Level-3-260C-168 HR	-40 to 125	L015A	Samples
LP2992AILD-3.3/NOPB	ACTIVE	WSON	NGD	6	4500	RoHS & Green	NIPDAU SN	Level-3-260C-168 HR	-40 to 125	L014A	Samples
LP2992AILD-5.0/NOPB	ACTIVE	WSON	NGD	6	4500	RoHS & Green	NIPDAU SN	Level-3-260C-168 HR	-40 to 125	L015A	Samples
LP2992AIM5-1.5/NOPB	ACTIVE	SOT-23	DBV	5	1000	RoHS & Green	SN	Level-1-260C-UNLIM	-40 to 125	LFBA	Samples
LP2992AIM5-1.8/NOPB	ACTIVE	SOT-23	DBV	5	3000	RoHS & Green	SN	Level-1-260C-UNLIM	-40 to 125	LFCA	Samples
LP2992AIM5-2.5/NOPB	ACTIVE	SOT-23	DBV	5	3000	RoHS & Green	SN	Level-1-260C-UNLIM	-40 to 125	LFDA	Samples
LP2992AIM5-3.3/NOPB	ACTIVE	SOT-23	DBV	5	3000	RoHS & Green	NIPDAU SN	Level-1-260C-UNLIM	-40 to 125	LFEA	Samples
LP2992AIM5-5.0/NOPB	ACTIVE	SOT-23	DBV	5	3000	RoHS & Green	SN	Level-1-260C-UNLIM	-40 to 125	LFFA	Samples
LP2992AIM5X-1.5/NOPB	ACTIVE	SOT-23	DBV	5	3000	RoHS & Green	SN	Level-1-260C-UNLIM	-40 to 125	LFBA	Samples
LP2992AIM5X-1.8/NOPB	ACTIVE	SOT-23	DBV	5	3000	RoHS & Green	SN	Level-1-260C-UNLIM	-40 to 125	LFCA	Samples
LP2992AIM5X-2.5/NOPB	ACTIVE	SOT-23	DBV	5	3000	RoHS & Green	SN	Level-1-260C-UNLIM	-40 to 125	LFDA	Samples
LP2992AIM5X-3.3/NOPB	ACTIVE	SOT-23	DBV	5	3000	RoHS & Green	NIPDAU SN	Level-1-260C-UNLIM	-40 to 125	LFEA	Samples
LP2992AIM5X-5.0/NOPB	ACTIVE	SOT-23	DBV	5	3000	RoHS & Green	SN	Level-1-260C-UNLIM	-40 to 125	LFFA	Samples
LP2992ILD-1.8/NOPB	ACTIVE	WSON	NGD	6	1000	RoHS & Green	NIPDAU SN	Level-3-260C-168 HR	-40 to 125	L012A B	Samples
LP2992ILD-2.5/NOPB	ACTIVE	WSON	NGD	6	1000	RoHS & Green	SN	Level-3-260C-168 HR	-40 to 125	L013A B	Samples
LP2992ILD-3.3/NOPB	ACTIVE	WSON	NGD	6	1000	RoHS & Green	NIPDAU SN	Level-3-260C-168 HR	-40 to 125	L014A B	Samples

Orderable Device	Status (1)	Package Type	Package Drawing	Pins	Package Qty	Eco Plan (2)	Lead finish/ Ball material (6)	MSL Peak Temp (3)	Op Temp (°C)	Device Marking (4/5)	Samples
LP2992ILD-5.0/NOPB	ACTIVE	WSO	NGD	6	1000	RoHS & Green	NIPDAU SN	Level-3-260C-168 HR	-40 to 125	L015A B	Samples
LP2992ILD-1.5/NOPB	ACTIVE	WSO	NGD	6	4500	RoHS & Green	NIPDAU SN	Level-3-260C-168 HR	-40 to 125	L011A B	Samples
LP2992ILD-3.3/NOPB	ACTIVE	WSO	NGD	6	4500	RoHS & Green	NIPDAU SN	Level-3-260C-168 HR	-40 to 125	L014A B	Samples
LP2992ILD-5.0/NOPB	ACTIVE	WSO	NGD	6	4500	RoHS & Green	SN	Level-3-260C-168 HR	-40 to 125	L015A B	Samples
LP2992IM5-1.5/NOPB	ACTIVE	SOT-23	DBV	5	1000	RoHS & Green	SN	Level-1-260C-UNLIM	-40 to 125	LFBB	Samples
LP2992IM5-1.8/NOPB	ACTIVE	SOT-23	DBV	5	3000	RoHS & Green	SN	Level-1-260C-UNLIM	-40 to 125	LFCB	Samples
LP2992IM5-2.5/NOPB	ACTIVE	SOT-23	DBV	5	1000	RoHS & Green	SN	Level-1-260C-UNLIM	-40 to 125	LFDB	Samples
LP2992IM5-3.0/NOPB	ACTIVE	SOT-23	DBV	5	1000	RoHS & Green	SN	Level-1-260C-UNLIM		LF8B	Samples
LP2992IM5-3.3/NOPB	ACTIVE	SOT-23	DBV	5	3000	RoHS & Green	NIPDAU SN	Level-1-260C-UNLIM	-40 to 125	LFEB	Samples
LP2992IM5-5.0/NOPB	ACTIVE	SOT-23	DBV	5	3000	RoHS & Green	SN	Level-1-260C-UNLIM	-40 to 125	LFFB	Samples
LP2992IM5X-1.5/NOPB	ACTIVE	SOT-23	DBV	5	3000	RoHS & Green	SN	Level-1-260C-UNLIM	-40 to 125	LFBB	Samples
LP2992IM5X-1.8/NOPB	ACTIVE	SOT-23	DBV	5	3000	RoHS & Green	SN	Level-1-260C-UNLIM	-40 to 125	LFCB	Samples
LP2992IM5X-2.5/NOPB	ACTIVE	SOT-23	DBV	5	3000	RoHS & Green	SN	Level-1-260C-UNLIM	-40 to 125	LFDB	Samples
LP2992IM5X-3.3/NOPB	ACTIVE	SOT-23	DBV	5	3000	RoHS & Green	NIPDAU SN	Level-1-260C-UNLIM	-40 to 125	LFEB	Samples
LP2992IM5X-5.0/NOPB	ACTIVE	SOT-23	DBV	5	3000	RoHS & Green	SN	Level-1-260C-UNLIM	-40 to 125	LFFB	Samples

(1) The marketing status values are defined as follows:

ACTIVE: Product device recommended for new designs.

LIFEBUY: TI has announced that the device will be discontinued, and a lifetime-buy period is in effect.

NRND: Not recommended for new designs. Device is in production to support existing customers, but TI does not recommend using this part in a new design.

PREVIEW: Device has been announced but is not in production. Samples may or may not be available.

OBSELETE: TI has discontinued the production of the device.

(2) **RoHS:** TI defines "RoHS" to mean semiconductor products that are compliant with the current EU RoHS requirements for all 10 RoHS substances, including the requirement that RoHS substance do not exceed 0.1% by weight in homogeneous materials. Where designed to be soldered at high temperatures, "RoHS" products are suitable for use in specified lead-free processes. TI may reference these types of products as "Pb-Free".

RoHS Exempt: TI defines "RoHS Exempt" to mean products that contain lead but are compliant with EU RoHS pursuant to a specific EU RoHS exemption.

Green: TI defines "Green" to mean the content of Chlorine (Cl) and Bromine (Br) based flame retardants meet JS709B low halogen requirements of ≤ 1000 ppm threshold. Antimony trioxide based flame retardants must also meet the ≤ 1000 ppm threshold requirement.

(3) MSL, Peak Temp. - The Moisture Sensitivity Level rating according to the JEDEC industry standard classifications, and peak solder temperature.

(4) There may be additional marking, which relates to the logo, the lot trace code information, or the environmental category on the device.

(5) Multiple Device Markings will be inside parentheses. Only one Device Marking contained in parentheses and separated by a "~" will appear on a device. If a line is indented then it is a continuation of the previous line and the two combined represent the entire Device Marking for that device.

(6) Lead finish/Ball material - Orderable Devices may have multiple material finish options. Finish options are separated by a vertical ruled line. Lead finish/Ball material values may wrap to two lines if the finish value exceeds the maximum column width.

Important Information and Disclaimer: The information provided on this page represents TI's knowledge and belief as of the date that it is provided. TI bases its knowledge and belief on information provided by third parties, and makes no representation or warranty as to the accuracy of such information. Efforts are underway to better integrate information from third parties. TI has taken and continues to take reasonable steps to provide representative and accurate information but may not have conducted destructive testing or chemical analysis on incoming materials and chemicals. TI and TI suppliers consider certain information to be proprietary, and thus CAS numbers and other limited information may not be available for release.

In no event shall TI's liability arising out of such information exceed the total purchase price of the TI part(s) at issue in this document sold by TI to Customer on an annual basis.

TAPE AND REEL INFORMATION

QUADRANT ASSIGNMENTS FOR PIN 1 ORIENTATION IN TAPE

*All dimensions are nominal

Device	Package Type	Package Drawing	Pins	SPQ	Reel Diameter (mm)	Reel Width W1 (mm)	A0 (mm)	B0 (mm)	K0 (mm)	P1 (mm)	W (mm)	Pin1 Quadrant
LP2992AILD-1.5/NOPB	WSO	NGD	6	1000	178.0	12.4	3.6	3.2	1.0	8.0	12.0	Q1
LP2992AILD-1.8/NOPB	WSO	NGD	6	1000	178.0	12.4	3.6	3.2	1.0	8.0	12.0	Q1
LP2992AILD-3.3/NOPB	WSO	NGD	6	1000	178.0	12.4	3.6	3.2	1.0	8.0	12.0	Q1
LP2992AILD-5.0/NOPB	WSO	NGD	6	1000	180.0	12.4	3.6	3.2	1.0	8.0	12.0	Q1
LP2992AILD-3.3/NOPB	WSO	NGD	6	4500	330.0	12.4	3.6	3.2	1.0	8.0	12.0	Q1
LP2992AILD-5.0/NOPB	WSO	NGD	6	4500	330.0	12.4	3.6	3.2	1.0	8.0	12.0	Q1
LP2992AIM5-1.5/NOPB	SOT-23	DBV	5	1000	178.0	8.4	3.2	3.2	1.4	4.0	8.0	Q3
LP2992AIM5-1.8/NOPB	SOT-23	DBV	5	3000	180.0	8.4	3.2	3.2	1.4	4.0	8.0	Q3
LP2992AIM5-2.5/NOPB	SOT-23	DBV	5	3000	180.0	8.4	3.2	3.2	1.4	4.0	8.0	Q3
LP2992AIM5-3.3/NOPB	SOT-23	DBV	5	3000	180.0	8.4	3.2	3.2	1.4	4.0	8.0	Q3
LP2992AIM5-5.0/NOPB	SOT-23	DBV	5	3000	180.0	8.4	3.2	3.2	1.4	4.0	8.0	Q3
LP2992AIM5X-1.5/NOPB	SOT-23	DBV	5	3000	178.0	8.4	3.2	3.2	1.4	4.0	8.0	Q3
LP2992AIM5X-1.8/NOPB	SOT-23	DBV	5	3000	178.0	8.4	3.2	3.2	1.4	4.0	8.0	Q3
LP2992AIM5X-2.5/NOPB	SOT-23	DBV	5	3000	178.0	8.4	3.2	3.2	1.4	4.0	8.0	Q3
LP2992AIM5X-3.3/NOPB	SOT-23	DBV	5	3000	180.0	8.4	3.2	3.2	1.4	4.0	8.0	Q3
LP2992AIM5X-5.0/NOPB	SOT-23	DBV	5	3000	180.0	8.4	3.2	3.2	1.4	4.0	8.0	Q3

Device	Package Type	Package Drawing	Pins	SPQ	Reel Diameter (mm)	Reel Width W1 (mm)	A0 (mm)	B0 (mm)	K0 (mm)	P1 (mm)	W (mm)	Pin1 Quadrant
LP2992ILD-1.8/NOPB	WSON	NGD	6	1000	178.0	12.4	3.6	3.2	1.0	8.0	12.0	Q1
LP2992ILD-2.5/NOPB	WSON	NGD	6	1000	178.0	12.4	3.6	3.2	1.0	8.0	12.0	Q1
LP2992ILD-3.3/NOPB	WSON	NGD	6	1000	178.0	12.4	3.6	3.2	1.0	8.0	12.0	Q1
LP2992ILD-5.0/NOPB	WSON	NGD	6	1000	180.0	12.4	3.6	3.2	1.0	8.0	12.0	Q1
LP2992ILD-1.5/NOPB	WSON	NGD	6	4500	330.0	12.4	3.6	3.2	1.0	8.0	12.0	Q1
LP2992ILD-3.3/NOPB	WSON	NGD	6	4500	330.0	12.4	3.6	3.2	1.0	8.0	12.0	Q1
LP2992ILD-5.0/NOPB	WSON	NGD	6	4500	330.0	12.4	3.6	3.2	1.0	8.0	12.0	Q1
LP2992IM5-1.5/NOPB	SOT-23	DBV	5	1000	178.0	8.4	3.2	3.2	1.4	4.0	8.0	Q3
LP2992IM5-1.8/NOPB	SOT-23	DBV	5	3000	180.0	8.4	3.2	3.2	1.4	4.0	8.0	Q3
LP2992IM5-2.5/NOPB	SOT-23	DBV	5	1000	178.0	8.4	3.2	3.2	1.4	4.0	8.0	Q3
LP2992IM5-3.0/NOPB	SOT-23	DBV	5	1000	178.0	8.4	3.2	3.2	1.4	4.0	8.0	Q3
LP2992IM5-3.3/NOPB	SOT-23	DBV	5	3000	180.0	8.4	3.2	3.2	1.4	4.0	8.0	Q3
LP2992IM5-5.0/NOPB	SOT-23	DBV	5	3000	180.0	8.4	3.2	3.2	1.4	4.0	8.0	Q3
LP2992IM5X-1.5/NOPB	SOT-23	DBV	5	3000	178.0	8.4	3.2	3.2	1.4	4.0	8.0	Q3
LP2992IM5X-1.8/NOPB	SOT-23	DBV	5	3000	180.0	8.4	3.2	3.2	1.4	4.0	8.0	Q3
LP2992IM5X-2.5/NOPB	SOT-23	DBV	5	3000	178.0	8.4	3.2	3.2	1.4	4.0	8.0	Q3
LP2992IM5X-3.3/NOPB	SOT-23	DBV	5	3000	180.0	8.4	3.2	3.2	1.4	4.0	8.0	Q3
LP2992IM5X-5.0/NOPB	SOT-23	DBV	5	3000	180.0	8.4	3.2	3.2	1.4	4.0	8.0	Q3

TAPE AND REEL BOX DIMENSIONS



*All dimensions are nominal

Device	Package Type	Package Drawing	Pins	SPQ	Length (mm)	Width (mm)	Height (mm)
LP2992AILD-1.5/NOPB	WSON	NGD	6	1000	208.0	191.0	35.0
LP2992AILD-1.8/NOPB	WSON	NGD	6	1000	208.0	191.0	35.0
LP2992AILD-3.3/NOPB	WSON	NGD	6	1000	208.0	191.0	35.0
LP2992AILD-5.0/NOPB	WSON	NGD	6	1000	213.0	191.0	35.0
LP2992AILD-3.3/NOPB	WSON	NGD	6	4500	356.0	356.0	36.0
LP2992AILD-5.0/NOPB	WSON	NGD	6	4500	356.0	356.0	36.0
LP2992AIM5-1.5/NOPB	SOT-23	DBV	5	1000	208.0	191.0	35.0
LP2992AIM5-1.8/NOPB	SOT-23	DBV	5	3000	210.0	185.0	35.0
LP2992AIM5-2.5/NOPB	SOT-23	DBV	5	3000	210.0	185.0	35.0
LP2992AIM5-3.3/NOPB	SOT-23	DBV	5	3000	210.0	185.0	35.0
LP2992AIM5-5.0/NOPB	SOT-23	DBV	5	3000	210.0	185.0	35.0
LP2992AIM5X-1.5/NOPB	SOT-23	DBV	5	3000	208.0	191.0	35.0
LP2992AIM5X-1.8/NOPB	SOT-23	DBV	5	3000	208.0	191.0	35.0
LP2992AIM5X-2.5/NOPB	SOT-23	DBV	5	3000	208.0	191.0	35.0
LP2992AIM5X-3.3/NOPB	SOT-23	DBV	5	3000	210.0	185.0	35.0
LP2992AIM5X-5.0/NOPB	SOT-23	DBV	5	3000	210.0	185.0	35.0
LP2992ILD-1.8/NOPB	WSON	NGD	6	1000	208.0	191.0	35.0
LP2992ILD-2.5/NOPB	WSON	NGD	6	1000	208.0	191.0	35.0

Device	Package Type	Package Drawing	Pins	SPQ	Length (mm)	Width (mm)	Height (mm)
LP2992ILD-3.3/NOPB	WSON	NGD	6	1000	208.0	191.0	35.0
LP2992ILD-5.0/NOPB	WSON	NGD	6	1000	213.0	191.0	35.0
LP2992ILD-1.5/NOPB	WSON	NGD	6	4500	367.0	367.0	38.0
LP2992ILD-3.3/NOPB	WSON	NGD	6	4500	356.0	356.0	36.0
LP2992ILD-5.0/NOPB	WSON	NGD	6	4500	356.0	356.0	36.0
LP2992IM5-1.5/NOPB	SOT-23	DBV	5	1000	208.0	191.0	35.0
LP2992IM5-1.8/NOPB	SOT-23	DBV	5	3000	210.0	185.0	35.0
LP2992IM5-2.5/NOPB	SOT-23	DBV	5	1000	208.0	191.0	35.0
LP2992IM5-3.0/NOPB	SOT-23	DBV	5	1000	208.0	191.0	35.0
LP2992IM5-3.3/NOPB	SOT-23	DBV	5	3000	210.0	185.0	35.0
LP2992IM5-5.0/NOPB	SOT-23	DBV	5	3000	210.0	185.0	35.0
LP2992IM5X-1.5/NOPB	SOT-23	DBV	5	3000	208.0	191.0	35.0
LP2992IM5X-1.8/NOPB	SOT-23	DBV	5	3000	210.0	185.0	35.0
LP2992IM5X-2.5/NOPB	SOT-23	DBV	5	3000	208.0	191.0	35.0
LP2992IM5X-3.3/NOPB	SOT-23	DBV	5	3000	210.0	185.0	35.0
LP2992IM5X-5.0/NOPB	SOT-23	DBV	5	3000	210.0	185.0	35.0

EXAMPLE BOARD LAYOUT

DBV0005A

SOT-23 - 1.45 mm max height

SMALL OUTLINE TRANSISTOR



LAND PATTERN EXAMPLE
EXPOSED METAL SHOWN
SCALE:15X



SOLDER MASK DETAILS

4214839/K 08/2024

NOTES: (continued)

- 6. Publication IPC-7351 may have alternate designs.
- 7. Solder mask tolerances between and around signal pads can vary based on board fabrication site.

EXAMPLE STENCIL DESIGN

DBV0005A

SOT-23 - 1.45 mm max height

SMALL OUTLINE TRANSISTOR



SOLDER PASTE EXAMPLE
BASED ON 0.125 mm THICK STENCIL
SCALE:15X

4214839/K 08/2024

NOTES: (continued)

8. Laser cutting apertures with trapezoidal walls and rounded corners may offer better paste release. IPC-7525 may have alternate design recommendations.
9. Board assembly site may have different recommendations for stencil design.

NGD0006A

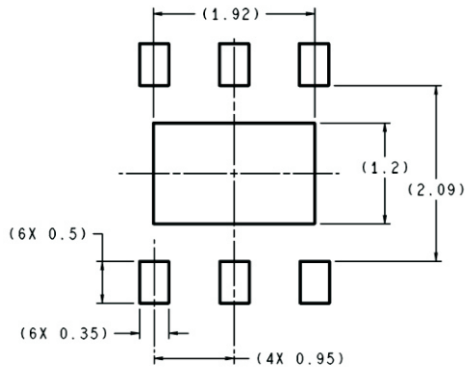

RECOMMENDED LAND PATTERN
1:1 RATIO WITH PKG SOLDER PADS

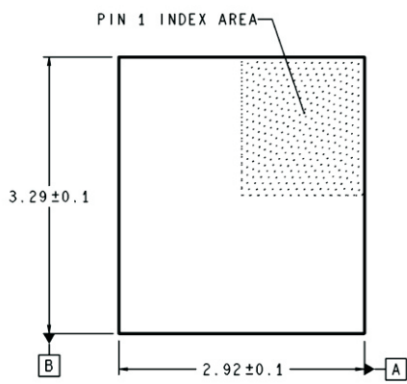

DIMENSIONS ARE IN MILLIMETERS

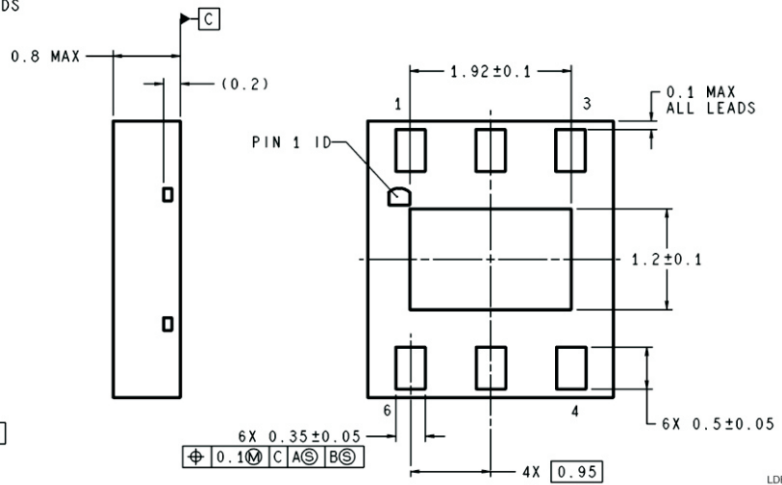

LDE06A (Rev A)

重要声明和免责声明

TI“按原样”提供技术和可靠性数据（包括数据表）、设计资源（包括参考设计）、应用或其他设计建议、网络工具、安全信息和其他资源，不保证没有瑕疵且不做任何明示或暗示的担保，包括但不限于对适销性、某特定用途方面的适用性或不侵犯任何第三方知识产权的暗示担保。

这些资源可供使用 TI 产品进行设计的熟练开发人员使用。您将自行承担以下全部责任：(1) 针对您的应用选择合适的 TI 产品，(2) 设计、验证并测试您的应用，(3) 确保您的应用满足相应标准以及任何其他功能安全、信息安全、监管或其他要求。

这些资源如有变更，恕不另行通知。TI 授权您仅可将这些资源用于研发本资源所述的 TI 产品的应用。严禁对这些资源进行其他复制或展示。您无权使用任何其他 TI 知识产权或任何第三方知识产权。您应全额赔偿因在这些资源的使用中对 TI 及其代表造成的任何索赔、损害、成本、损失和债务，TI 对此概不负责。

TI 提供的产品受 [TI 的销售条款](#) 或 [ti.com](#) 上其他适用条款/TI 产品随附的其他适用条款的约束。TI 提供这些资源并不会扩展或以其他方式更改 TI 针对 TI 产品发布的适用的担保或担保免责声明。

TI 反对并拒绝您可能提出的任何其他或不同的条款。

邮寄地址：Texas Instruments, Post Office Box 655303, Dallas, Texas 75265
Copyright © 2024，德州仪器 (TI) 公司