

# OPAx325

## 精度、10MHz、低噪声、低功耗、RRIO、CMOS 运算放大器

### 1 特性

- 零交叉失真时的精度：
  - 低失调电压：150 $\mu$ V（最大值）
  - 高共模抑制比 (CMRR)：114dB
  - 轨至轨 I/O
- 高带宽：10MHz
- 静态电流：650 $\mu$ A/每通道
- 单电源电压范围：2.2V 至 5.5V
- 低输入偏置电流：0.2pA
- 低噪声：10kHz 时为 9nV/ $\sqrt{\text{Hz}}$
- 压摆率：5V/ $\mu$ s
- 单位增益稳定

### 2 应用

- 高阻抗传感器信号调节
- 跨阻放大器
- 测试和测量设备
- 可编程逻辑控制器 (PLC)
- 电机控制环路
- 通信
- 输入、输出 ADC 和 DAC 缓冲器
- 有源滤波器

### 3 说明

OPA325、OPA2325 和 OPA4325 (OPAx325) 是精密的低压互补金属氧化物半导体 (CMOS) 运算放大器，经优化后具有极低噪声和高带宽，静态工作电流仅为 650 $\mu$ A。

OPAx325 具有零交叉失真的线性输入级，能够在整个输入范围内提供 114dB（典型值）的出色共模抑制比 (CMRR)。共模输入范围将正负电源电压分别扩展了 100mV。输出电压摆幅通常在 10mV 电源轨内。

OPAx325 同时拥有零交叉失真、高带宽 (10MHz)、高压摆率 (5V/ $\mu$ s) 和低噪声 (9nV/ $\sqrt{\text{Hz}}$ ) 等优秀特性，堪称一款非常出色的逐次逼近寄存器 (SAR) 模数转换器 (ADC) 输入驱动放大器。此外，OPAx325 还具有 2.2V 至 5.5V 的宽电源电压范围，而且整个电源电压范围内的电源抑制比 (PSRR) 都极为出色，因此该器件非常适合不经稳压而直接由电池供电的高精度、低功耗类应用。

OPA325（单通道版）采用 SOT23-5 封装。OPA2325（双通道版）采用 SO-8 和 MSOP-8 封装。OPA4325（四通道版）采用 TSSOP-14 封装。

#### 器件信息<sup>(1)</sup>

器件型号	封装	封装尺寸（标称值）
OPA325	SOT-23 (5)	2.90mm × 1.60mm
OPA2325	SOIC (8)	4.90mm × 3.91mm
	VSSOP (8)	3.00mm × 3.00mm
OPA4325	TSSOP (14)	5.00mm × 4.40mm

(1) 如需了解所有可用封装，请参阅数据表末尾的封装选项附录。

失调电压与输入共模电压间的关系

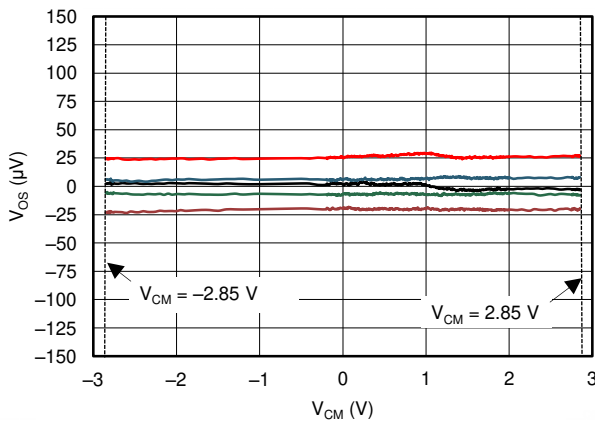

#### 可用作 ADC 驱动放大器的 OPAx325

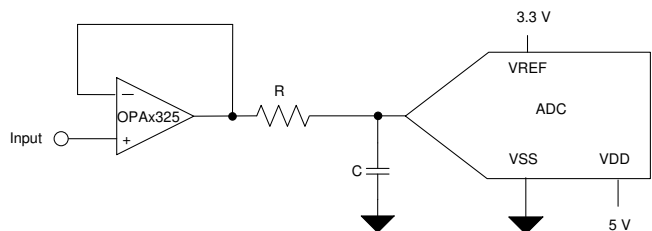

## 目录

<b>1</b>	特性 .....	<b>1</b>	7.3	Feature Description .....	<b>17</b>
<b>2</b>	应用 .....	<b>1</b>	7.4	Device Functional Modes .....	<b>18</b>
<b>3</b>	说明 .....	<b>1</b>	<b>8</b>	<b>Application and Implementation</b> .....	<b>19</b>
<b>4</b>	修订历史记录 .....	<b>2</b>	8.1	Application Information .....	<b>19</b>
<b>5</b>	<b>Pin Configuration and Functions</b> .....	<b>3</b>	8.2	Typical Application .....	<b>20</b>
<b>6</b>	<b>Specifications</b> .....	<b>5</b>	<b>9</b>	<b>Power Supply Recommendations</b> .....	<b>25</b>
6.1	Absolute Maximum Ratings .....	<b>5</b>	<b>10</b>	<b>Layout</b> .....	<b>25</b>
6.2	ESD Ratings .....	<b>5</b>	10.1	Layout Guidelines .....	<b>25</b>
6.3	Recommended Operating Conditions .....	<b>5</b>	10.2	Layout Example .....	<b>26</b>
6.4	Thermal Information: OPA325 .....	<b>6</b>	<b>11</b>	<b>器件和文档支持</b> .....	<b>27</b>
6.5	Thermal Information: OPA2325 .....	<b>6</b>	11.1	文档支持 .....	<b>27</b>
6.6	Thermal Information: OPA4325 .....	<b>6</b>	11.2	相关链接 .....	<b>27</b>
6.7	Electrical Characteristics: $V_S = 2.2\text{ V to }5.5\text{ V or } \pm 1.1\text{ V to } \pm 2.75\text{ V}$ .....	<b>7</b>	11.3	接收文档更新通知 .....	<b>27</b>
6.8	Typical Characteristics .....	<b>9</b>	11.4	社区资源 .....	<b>27</b>
<b>7</b>	<b>Detailed Description</b> .....	<b>16</b>	11.5	商标 .....	<b>27</b>
7.1	Overview .....	<b>16</b>	11.6	静电放电警告 .....	<b>27</b>
7.2	Functional Block Diagram .....	<b>16</b>	11.7	Glossary .....	<b>27</b>
			<b>12</b>	<b>机械、封装和可订购信息</b> .....	<b>27</b>

## 4 修订历史记录

注：之前版本的页码可能与当前版本有所不同。

<b>Changes from Revision C (May 2019) to Revision D</b>	<b>Page</b>
• 已添加 向数据表中添加了 OPA325 及相关内容 .....	<b>1</b>

<b>Changes from Revision B (February 2019) to Revision C</b>	<b>Page</b>
• 已更改 将 OPA4325 器件状态从预览更改为生产数据（正在供货） .....	<b>1</b>

<b>Changes from Revision A (July 2017) to Revision B</b>	<b>Page</b>
• 已添加 向数据表中添加了 OPA4325 预告信息器件 .....	<b>1</b>
• Added operating temperature to <i>Absolute Maximum Ratings</i> table .....	<b>5</b>
• Deleted specified temperature from <i>Absolute Maximum Ratings</i> table; specified temperature already listed in <i>Recommended Operating Conditions</i> table .....	<b>5</b>

<b>Changes from Original (October 2016) to Revision A</b>	<b>Page</b>
• 已添加 针对双通道器件添加了新型 VSSOP 封装选项 .....	<b>1</b>
• 已添加 针对 TI 参考设计添加了顶部导航图标 .....	<b>1</b>

## 5 Pin Configuration and Functions

**OPA325: DBV Package  
5-Pin SOT-23  
Top View**

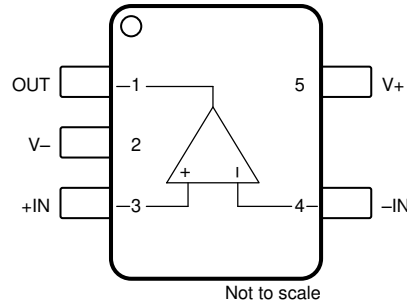

**Pin Functions: OPA325**

PIN		I/O	DESCRIPTION
NAME	NO.		
-IN	4	I	Inverting input
+IN	3	I	Noninverting input
OUT	1	O	Output
V-	2	—	Negative (lowest) power supply
V+	5	—	Positive (highest) power supply

**OPA2325: D and DGK Packages  
8-Pin SOIC, 8-Pin VSSOP  
Top View**

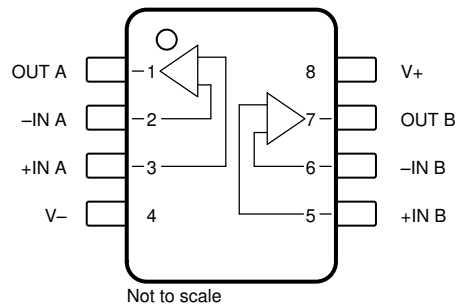

**Pin Functions: OPA2325**

PIN		I/O	DESCRIPTION
NAME	NO.		
-IN A	2	I	Inverting input channel A
+IN A	3	I	Noninverting input channel A
-IN B	6	I	Inverting input channel B
+IN B	5	I	Noninverting input channel B
OUT A	1	O	Output channel A
OUT B	7	O	Output channel B
V-	4	—	Negative supply
V+	8	—	Positive supply

**OPA4325: PW Package  
14-Pin TSSOP  
Top View**

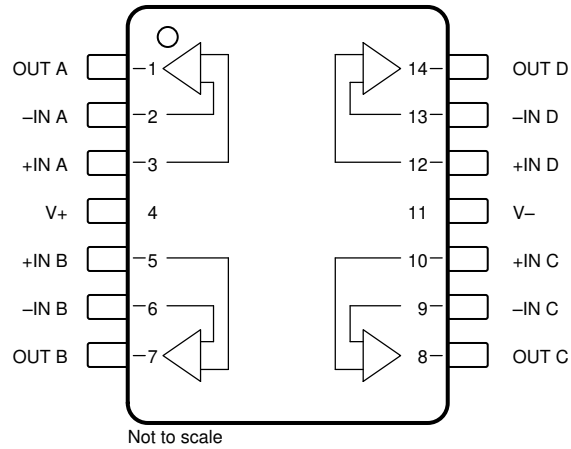

**Pin Functions: OPA4325**

PIN		I/O	DESCRIPTION
NAME	NO.		
-IN A	2	I	Inverting input channel A
+IN A	3	I	Noninverting input channel A
-IN B	6	I	Inverting input channel B
+IN B	5	I	Noninverting input channel B
-IN C	9	I	Inverting input channel C
+IN C	10	I	Noninverting input channel C
-IN D	13	I	Inverting input channel D
+IN D	12	I	Noninverting input channel D
OUT A	1	O	Output channel A
OUT B	7	O	Output channel B
OUT C	8	O	Output channel C
OUT D	14	O	Output channel D
V-	11	—	Negative supply
V+	4	—	Positive supply

## 6 Specifications

### 6.1 Absolute Maximum Ratings

over operating free-air temperature range (unless otherwise noted)<sup>(1)</sup>

		MIN	MAX	UNIT
Supply voltage	$V_S = (V+) - (V-)$		6	V
Signal input pins	Voltage <sup>(2)</sup>	(V-) – 0.5	(V+) + 0.5	V
	Current <sup>(2)</sup>	–10	10	mA
Output short-circuit <sup>(3)</sup>		Continuous		mA
Temperature	Operating, $T_A$	–40	150	°C
	Junction, $T_J$		150	
	Storage, $T_{stg}$	–65	150	

- (1) Stresses beyond those listed under *Absolute Maximum Ratings* may cause permanent damage to the device. These are stress ratings only, which do not imply functional operation of the device at these or any other conditions beyond those indicated under *Recommended Operating Conditions*. Exposure to absolute-maximum-rated conditions for extended periods may affect device reliability.
- (2) Input pins are diode-clamped to the power-supply rails. Input signals that can swing more than 0.5 V beyond the supply rails must be current limited to 10 mA or less.
- (3) Short-circuit to ground, one amplifier per package.

### 6.2 ESD Ratings

			VALUE	UNIT
$V_{(ESD)}$	Electrostatic discharge	Human-body model (HBM), per ANSI/ESDA/JEDEC JS-001 <sup>(1)</sup>	±4000	V
		Charged-device model (CDM), per JEDEC specification JESD22-C101 <sup>(2)</sup>	±1000	

- (1) JEDEC document JEP155 states that 500-V HBM allows safe manufacturing with a standard ESD control process.
- (2) JEDEC document JEP157 states that 250-V CDM allows safe manufacturing with a standard ESD control process.

### 6.3 Recommended Operating Conditions

over operating free-air temperature range (unless otherwise noted)

			MIN	NOM	MAX	UNIT
$V_S$	Supply voltage	Single supply	2.2		5.5	V
		Dual supply	±1.1		±2.75	
$T_A$	Specified temperature		–40		125	°C

#### 6.4 Thermal Information: OPA325

THERMAL METRIC <sup>(1)</sup>		OPA325		UNIT
		DBV (SOT)		
		5 PINS		
$R_{\theta JA}$	Junction-to-ambient thermal resistance	205		°C/W
$R_{\theta JC(top)}$	Junction-to-case (top) thermal resistance	200		°C/W
$R_{\theta JB}$	Junction-to-board thermal resistance	113		°C/W
$\Psi_{JT}$	Junction-to-top characterization parameter	38.2		°C/W
$\Psi_{JB}$	Junction-to-board characterization parameter	104.9		°C/W
$R_{\theta JC(bot)}$	Junction-to-case (bottom) thermal resistance	N/A		°C/W

(1) For more information about traditional and new thermal metrics, see the [Semiconductor and IC Package Thermal Metrics application report](#).

#### 6.5 Thermal Information: OPA2325

THERMAL METRIC <sup>(1)</sup>		OPA2325		UNIT
		D (SOIC)	DGK (VSSOP)	
		8 PINS	8 PINS	
$R_{\theta JA}$	Junction-to-ambient thermal resistance	119	143	°C/W
$R_{\theta JC(top)}$	Junction-to-case (top) thermal resistance	60	47	°C/W
$R_{\theta JB}$	Junction-to-board thermal resistance	61	64	°C/W
$\Psi_{JT}$	Junction-to-top characterization parameter	15.0	5.3	°C/W
$\Psi_{JB}$	Junction-to-board characterization parameter	60.4	62.8	°C/W
$R_{\theta JC(bot)}$	Junction-to-case (bottom) thermal resistance	N/A	N/A	°C/W

(1) For more information about traditional and new thermal metrics, see the [Semiconductor and IC Package Thermal Metrics application report](#).

#### 6.6 Thermal Information: OPA4325

THERMAL METRIC <sup>(1)</sup>		OPA4325		UNIT
		PW (TSSOP)		
		14 PINS		
$R_{\theta JA}$	Junction-to-ambient thermal resistance	93		°C/W
$R_{\theta JC(top)}$	Junction-to-case (top) thermal resistance	28		°C/W
$R_{\theta JB}$	Junction-to-board thermal resistance	34		°C/W
$\Psi_{JT}$	Junction-to-top characterization parameter	1.9		°C/W
$\Psi_{JB}$	Junction-to-board characterization parameter	33.1		°C/W
$R_{\theta JC(bot)}$	Junction-to-case (bottom) thermal resistance	N/A		°C/W

(1) For more information about traditional and new thermal metrics, see the [Semiconductor and IC Package Thermal Metrics application report](#).

## 6.7 Electrical Characteristics: $V_S = 2.2\text{ V to }5.5\text{ V}$ or $\pm 1.1\text{ V to } \pm 2.75\text{ V}$

at  $T_A = 25^\circ\text{C}$ ,  $R_L = 10\text{ k}\Omega$  connected to  $V_S / 2$ ,  $V_{CM} = V_S / 2$ , and  $V_{OUT} = V_S / 2$  (unless otherwise noted)

PARAMETER		TEST CONDITIONS	MIN	TYP	MAX	UNIT
<b>OFFSET VOLTAGE</b>						
$V_{OS}$	Input offset voltage			40	150	$\mu\text{V}$
$dV_{OS}/dT$	Input offset voltage drift	$V_S = 5.5\text{ V}$ , $T_A = -40^\circ\text{C to } +125^\circ\text{C}$		2	7.5	$\mu\text{V}/^\circ\text{C}$
PSRR	Power-supply rejection ratio	$V_S = 2.2\text{ V to } +5.5\text{ V}$		6	20	$\mu\text{V/V}$
		$V_S = 2.2\text{ V to } 5.5\text{ V}$ , $T_A = -40^\circ\text{C to } +125^\circ\text{C}$		15		
	Channel separation	At 1 kHz		130		dB
<b>INPUT VOLTAGE</b>						
$V_{CM}$	Common-mode voltage range		$(V-) - 0.1$		$(V+) + 0.1$	V
CMRR	Common-mode rejection ratio	$V_S = 5.5\text{ V}$ , $(V-) - 0.1\text{ V} < V_{CM} < (V+) + 0.1\text{ V}$	100	114		dB
		$T_A = -40^\circ\text{C to } +125^\circ\text{C}$	95			
<b>INPUT BIAS CURRENT</b>						
$I_B$	Input bias current			$\pm 0.2$	$\pm 10$	$\text{pA}$
		$T_A = -40^\circ\text{C to } +85^\circ\text{C}$			$\pm 500$	
		$T_A = -40^\circ\text{C to } +125^\circ\text{C}$				$\pm 10$
$I_{OS}$	Input offset current			$\pm 0.2$	$\pm 10$	$\text{pA}$
		$T_A = -40^\circ\text{C to } +85^\circ\text{C}$			$\pm 500$	
		$T_A = -40^\circ\text{C to } +125^\circ\text{C}$				$\pm 10$
<b>NOISE</b>						
	Input voltage noise	$f = 0.1\text{ Hz to } 10\text{ Hz}$		2.8		$\mu\text{V}_{PP}$
$e_n$	Input voltage noise density	$f = 1\text{ kHz}$		10		$\text{nV}/\sqrt{\text{Hz}}$
		$f = 10\text{ kHz}$		9		
$i_n$	Input current noise density	$f = 1\text{ kHz}$		1.3		$\text{fA}/\sqrt{\text{Hz}}$
<b>INPUT CAPACITANCE</b>						
	Differential			5		pF
	Common-mode			4		pF
<b>OPEN-LOOP GAIN</b>						
$A_{OL}$	Open-loop voltage gain	$0.1\text{ V} < V_O < (V+) - 0.1\text{ V}$ , $R_L = 10\text{ k}\Omega$	105	130		dB
		$0.1\text{ V} < V_O < (V+) - 0.1\text{ V}$ , $R_L = 10\text{ k}\Omega$ , $T_A = -40^\circ\text{C to } +125^\circ\text{C}$	95	128		
		$0.2\text{ V} < V_O < (V+) - 0.2\text{ V}$ , $R_L = 2\text{ k}\Omega$	100	110		
PM	Phase margin	$G = 1\text{ V/V}$ , $V_S = 5\text{ V}$ , $C_L = 15\text{ pF}$		67		Degrees
<b>FREQUENCY RESPONSE (<math>V_S = 5.0\text{ V}</math>, <math>C_L = 50\text{ pF}</math>)</b>						
GBP	Gain bandwidth product	Unity gain		10		MHz
SR	Slew rate	$G = +1$		5		$\text{V}/\mu\text{s}$
$t_S$	Settling time	To 0.1%, 2-V step, $G = +1$		0.6		$\mu\text{s}$
		To 0.01%, 2-V step, $G = +1$		1		
	Overload recovery time	$V_{IN} \times G > V_S$		200		ns
THD+N	Total harmonic distortion + noise <sup>(1)</sup>	$V_O = 4\text{ V}_{PP}$ , $G = +1$ , $f = 10\text{ kHz}$ , $R_L = 10\text{ k}\Omega$		0.0005%		
		$V_O = 2\text{ V}_{PP}$ , $G = +1$ , $f = 10\text{ kHz}$ , $R_L = 600\ \Omega$		0.005%		

(1) Third-order filter; bandwidth = 80 kHz at -3 dB.

**Electrical Characteristics:  $V_S = 2.2\text{ V to }5.5\text{ V}$  or  $\pm 1.1\text{ V to } \pm 2.75\text{ V}$  (continued)**

 at  $T_A = 25^\circ\text{C}$ ,  $R_L = 10\text{ k}\Omega$  connected to  $V_S / 2$ ,  $V_{CM} = V_S / 2$ , and  $V_{OUT} = V_S / 2$  (unless otherwise noted)

PARAMETER		TEST CONDITIONS	MIN	TYP	MAX	UNIT
<b>OUTPUT</b>						
$V_O$	Voltage output swing from both rails	$R_L = 10\text{ k}\Omega$		10	20	mV
		$R_L = 10\text{ k}\Omega$ , $T_A = -40^\circ\text{C to } +125^\circ\text{C}$			30	
		$R_L = 2\text{ k}\Omega$		25	45	
		$R_L = 2\text{ k}\Omega$ , $T_A = -40^\circ\text{C to } +125^\circ\text{C}$			55	
$I_{SC}$	Short-circuit current	$V_S = 5.5\text{ V}$	See the <a href="#">Typical Characteristics</a>			mA
$C_L$	Capacitive load drive		See the <a href="#">Typical Characteristics</a>			
$R_O$	Open-loop output resistance	$I_O = 0\text{ mA}$ , $f = 1\text{ MHz}$		180		$\Omega$
<b>POWER SUPPLY</b>						
$I_Q$	Quiescent current per amplifier	$I_O = 0\text{ mA}$ , $V_S = 5.5\text{ V}$		0.65	0.75	mA
		$I_O = 0\text{ mA}$ , $V_S = 5.5\text{ V}$ , $T_A = -40^\circ\text{C to } +125^\circ\text{C}$			0.8	
	Power-on time	$V_+ = 0\text{ V to }5\text{ V}$ , to 90% $I_Q$ level		28		$\mu\text{s}$



### 6.8 Typical Characteristics

at  $T_A = 25^\circ\text{C}$ ,  $V_{CM} = V_{OUT} = \text{midsupply}$ , and  $R_L = 10\text{ k}\Omega$  (unless otherwise noted)



图 1. Offset Voltage Production Distribution Histogram



图 2. Offset Voltage Drift Distribution Histogram

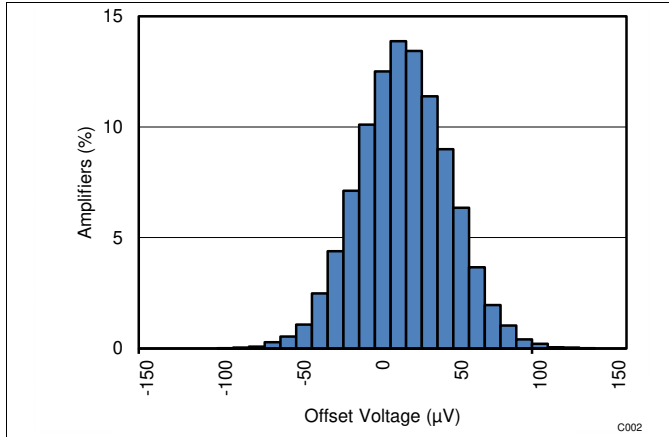

图 3. Offset Voltage vs Common-Mode Voltage

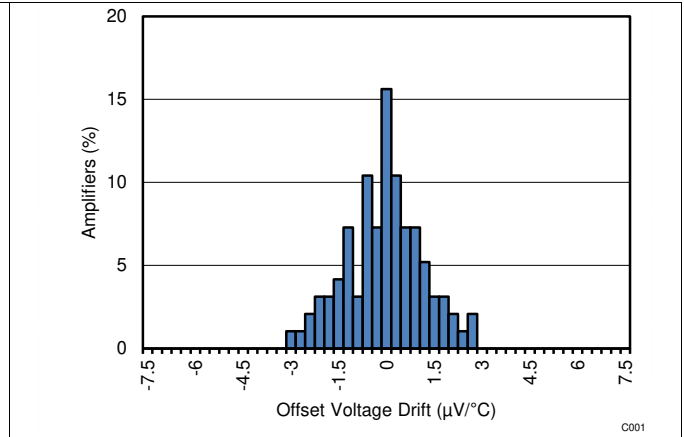

图 4. Offset Voltage vs Temperature

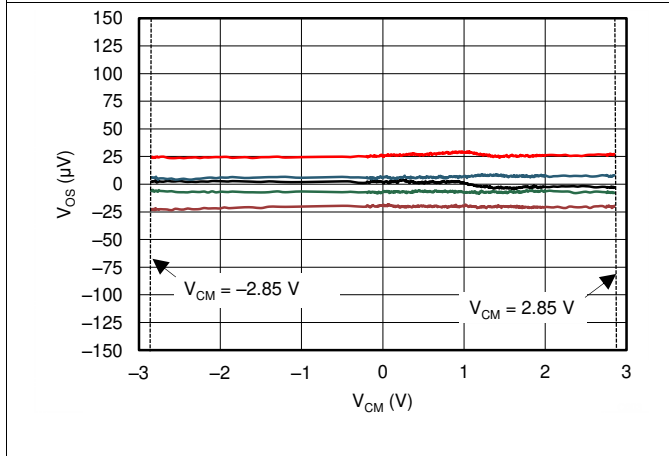

图 5. Open-Loop Gain and Phase vs Frequency

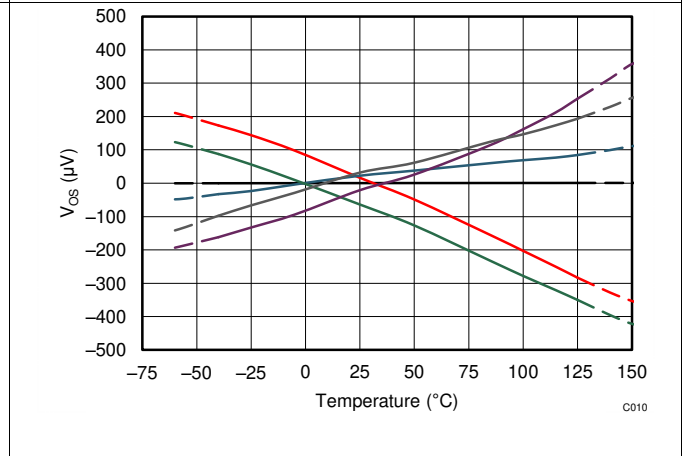

图 6. Offset Voltage vs Supply Voltage

Typical Characteristics (接下页)

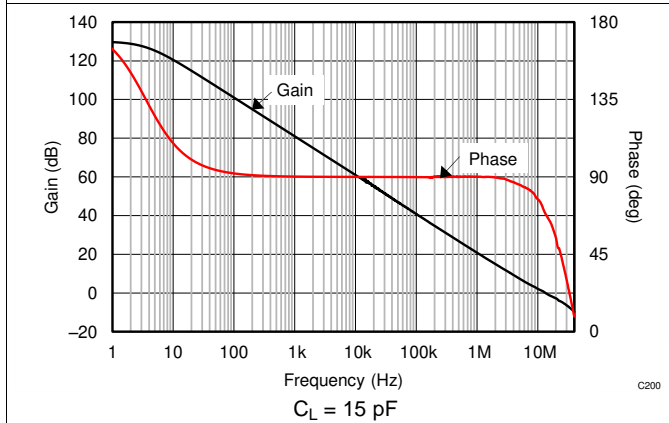
at  $T_A = 25^\circ\text{C}$ ,  $V_{CM} = V_{OUT} = \text{mid supply}$ , and  $R_L = 10\text{ k}\Omega$  (unless otherwise noted)

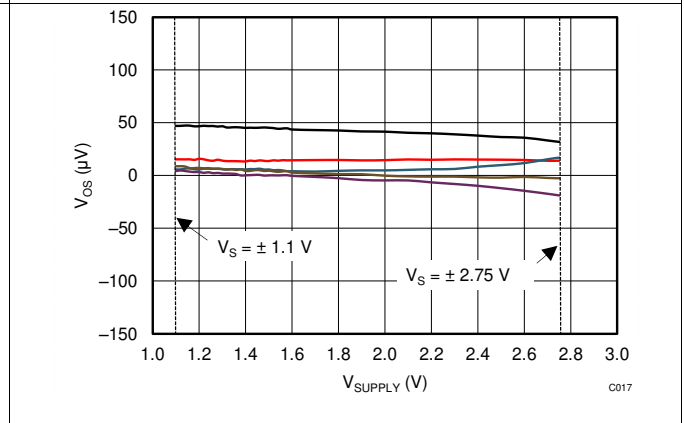

图 7. Open-Loop Gain vs Temperature



图 8. Open-Loop Gain vs Temperature

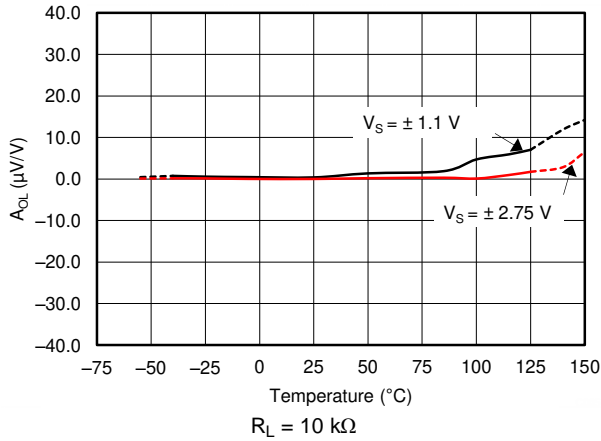

图 9. Quiescent Current vs Temperature

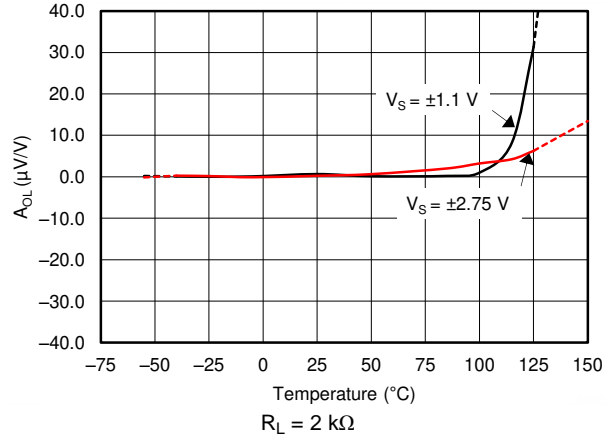

图 10. Quiescent Current vs Supply Voltage

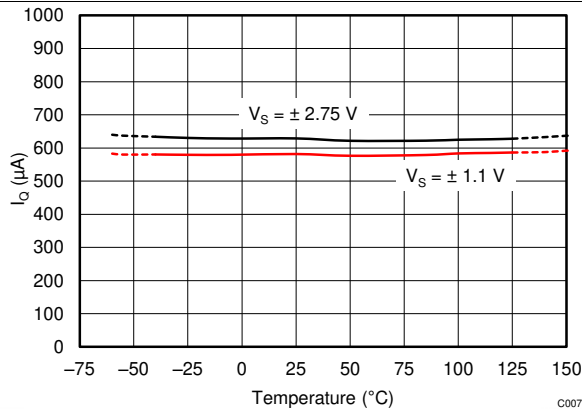

图 11. Input Bias Current vs Common-Mode Voltage

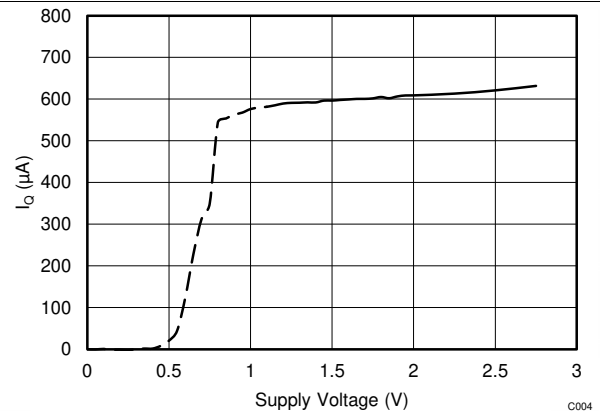

图 12. Input Bias Current Distribution Histogram

Typical Characteristics (接下页)

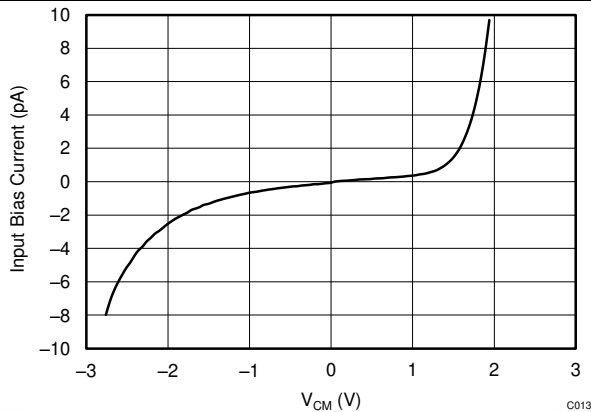
at  $T_A = 25^\circ\text{C}$ ,  $V_{CM} = V_{OUT} = \text{mid supply}$ , and  $R_L = 10\text{ k}\Omega$  (unless otherwise noted)

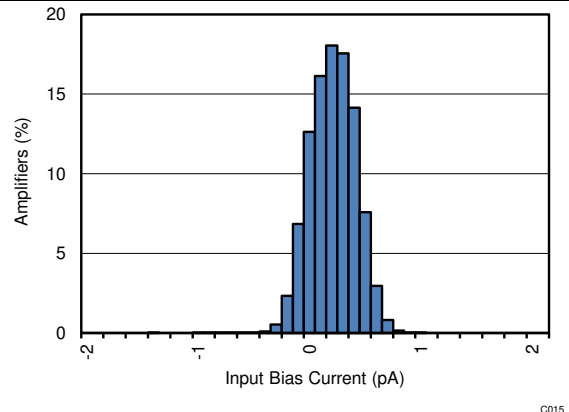

图 13. Input Offset Current Distribution Histogram



图 14. Input Bias Current vs Temperature

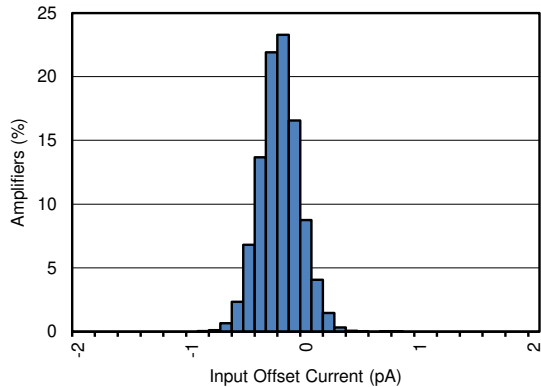

图 15. Output Voltage Swing (Positive) vs Output Current

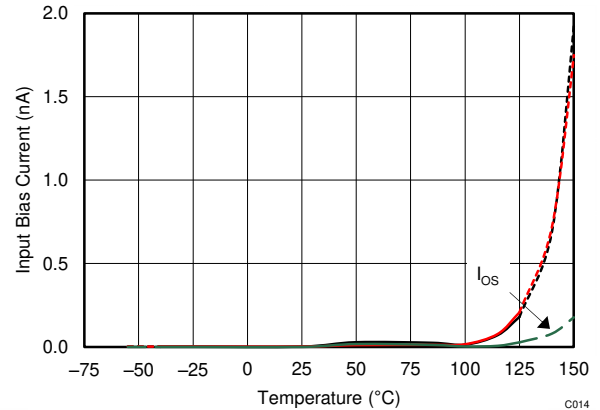

图 16. Output Voltage Swing (Negative) vs Output Current

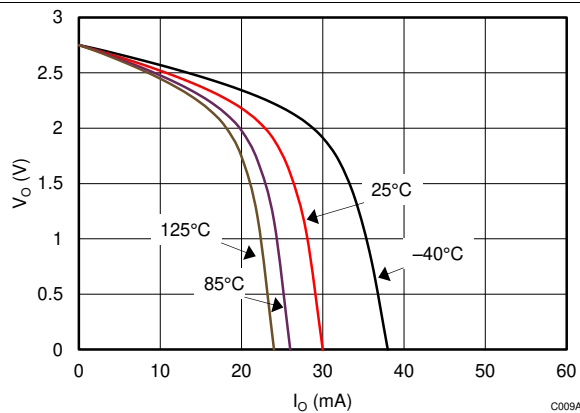

图 17. Short-Circuit Current vs Temperature

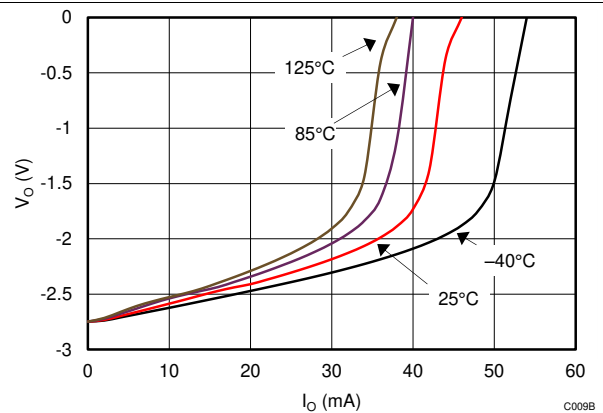

图 18. CMRR and PSRR vs Frequency

Typical Characteristics (接下页)

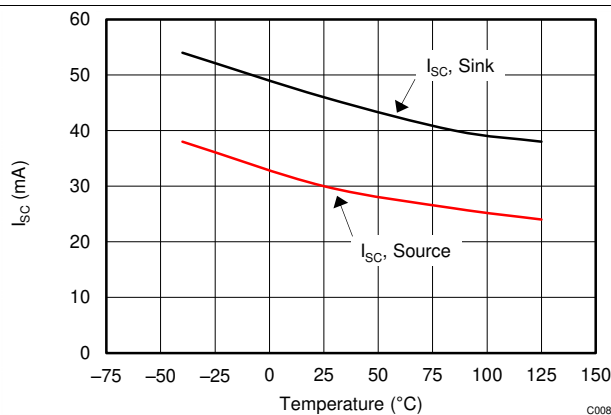
at  $T_A = 25^\circ\text{C}$ ,  $V_{CM} = V_{OUT} = \text{mid supply}$ , and  $R_L = 10\text{ k}\Omega$  (unless otherwise noted)

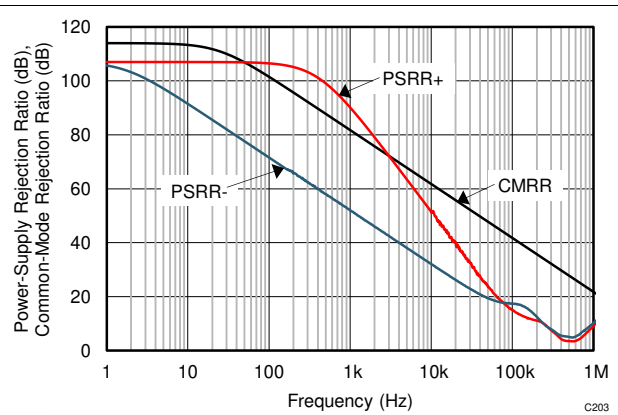
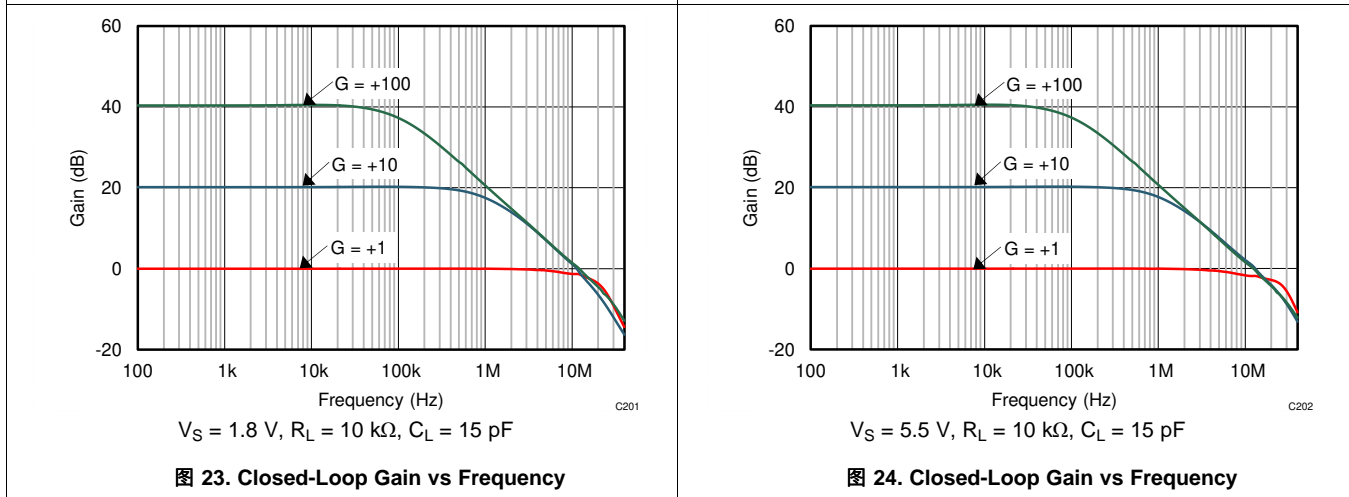
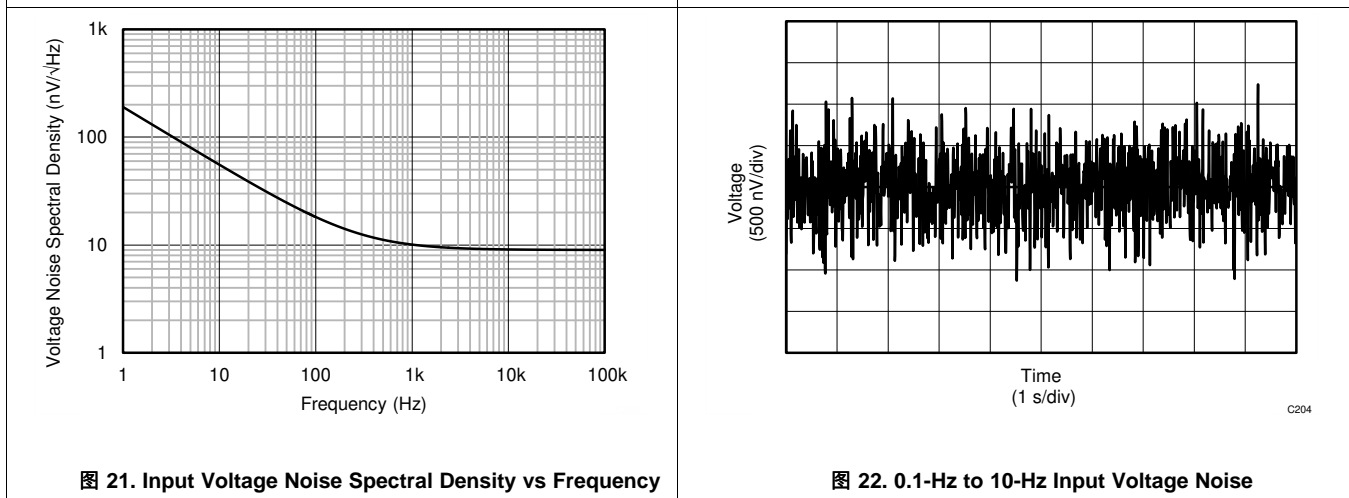
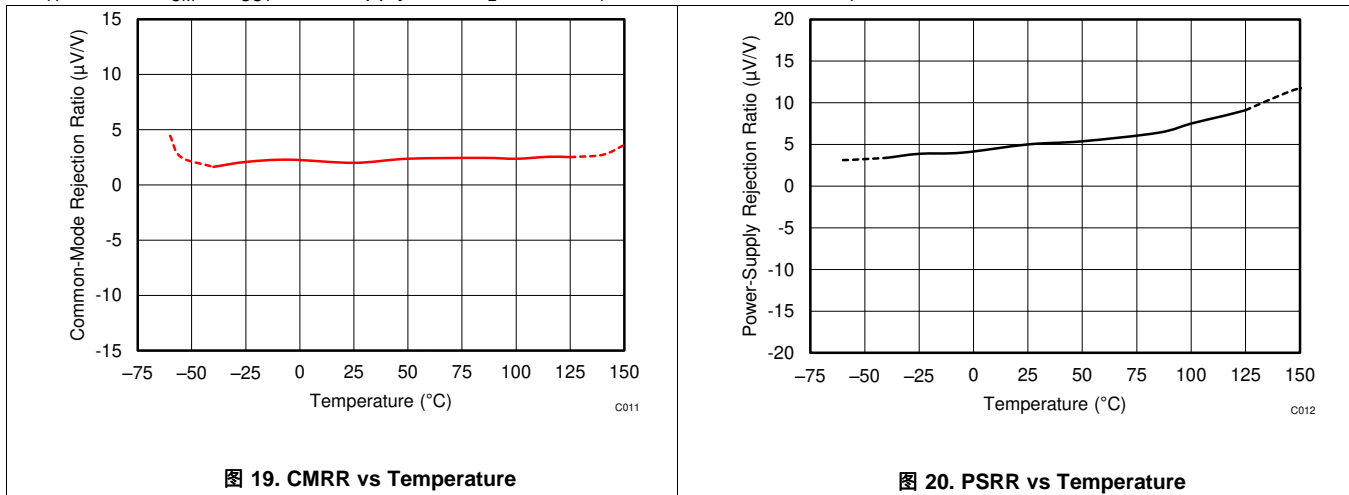

Typical Characteristics (接下页)

at  $T_A = 25^\circ\text{C}$ ,  $V_{CM} = V_{OUT} = \text{mid supply}$ , and  $R_L = 10\text{ k}\Omega$  (unless otherwise noted)

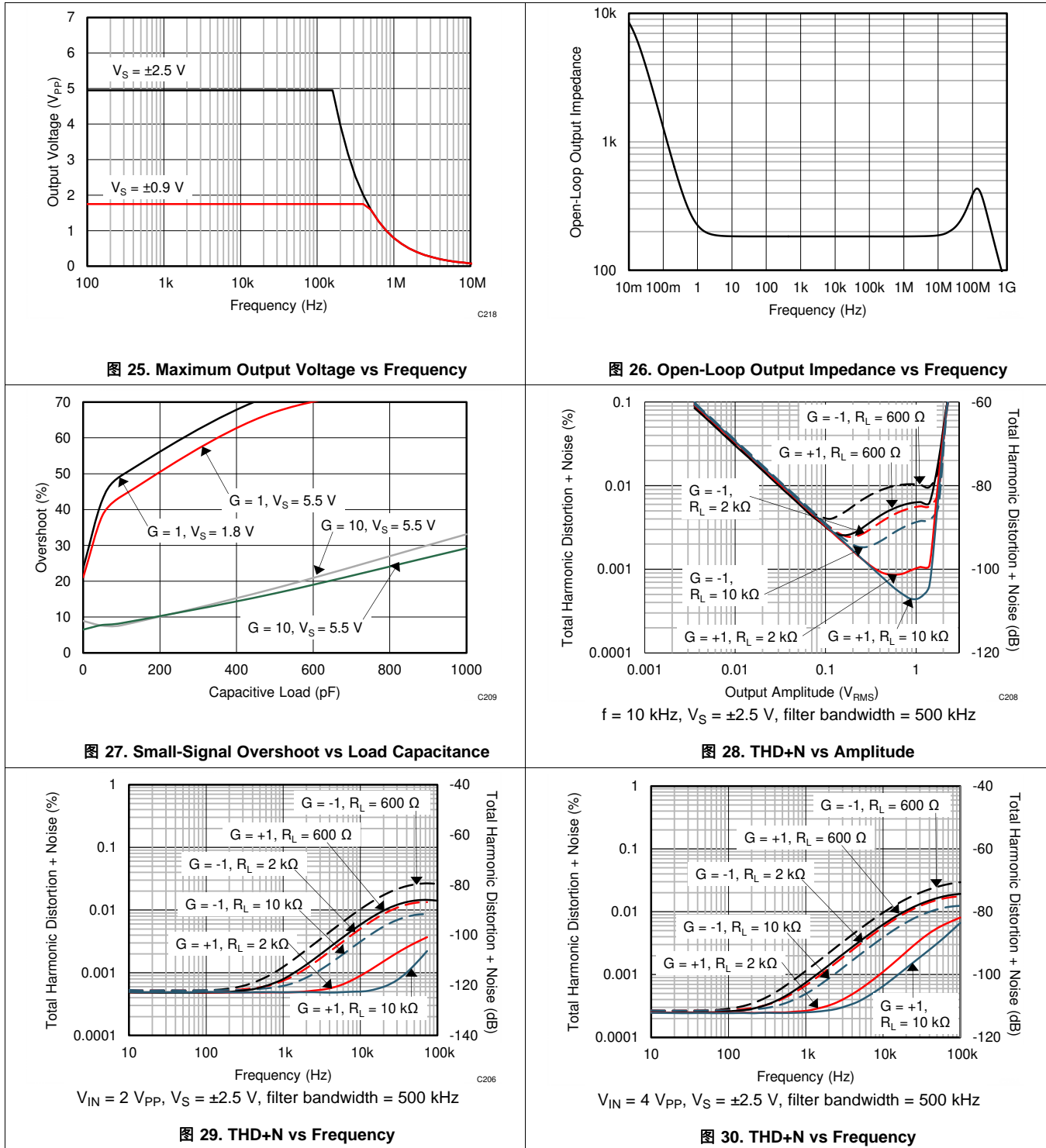

Typical Characteristics (接下页)

at  $T_A = 25^\circ\text{C}$ ,  $V_{CM} = V_{OUT} = \text{mid supply}$ , and  $R_L = 10\text{ k}\Omega$  (unless otherwise noted)

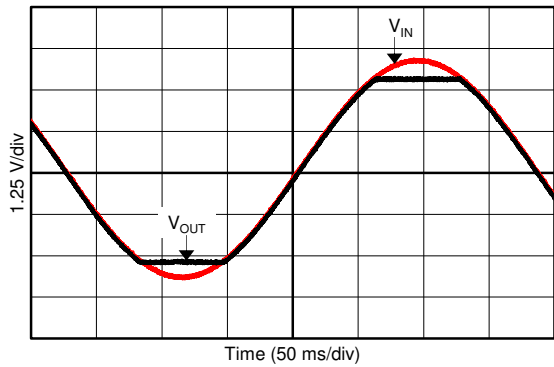

C210

图 31. No Phase Reversal

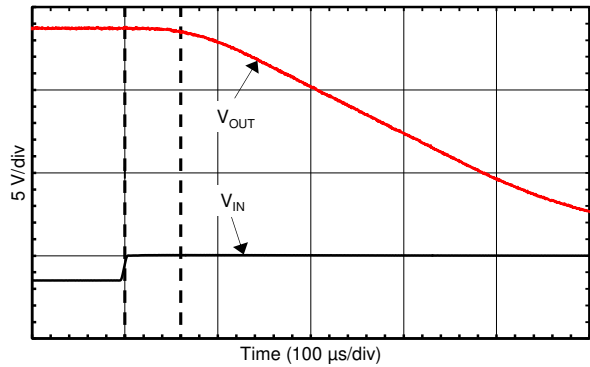

C212

图 32. Positive Overload Recovery

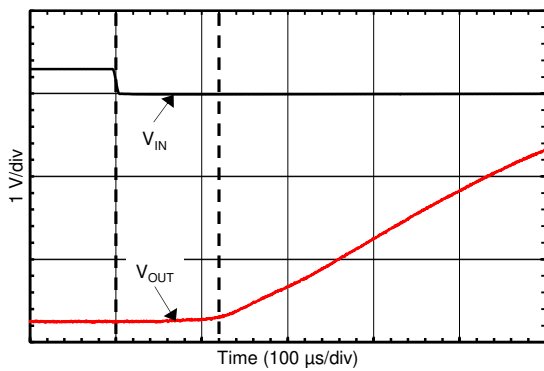

C211

图 33. Negative Overload Recovery

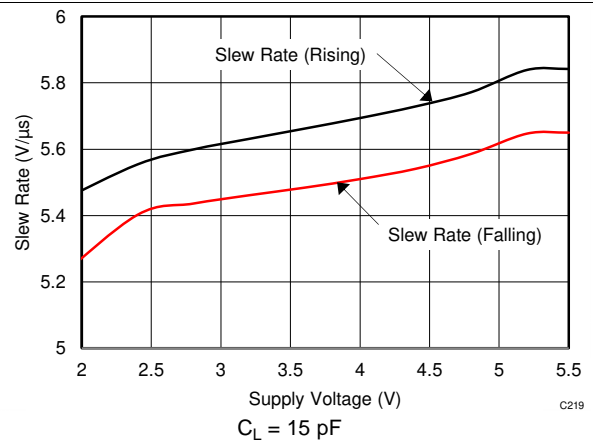

C219

图 34. Slew Rate vs Supply Voltage

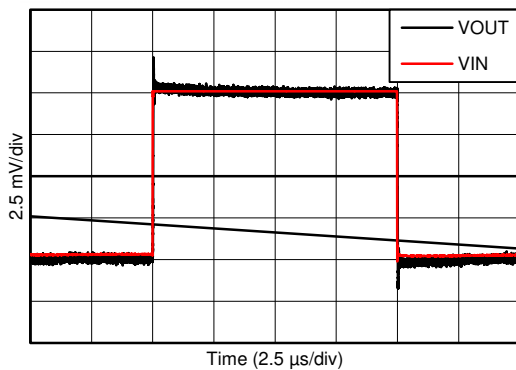

C213

$V_{IN} = 10\text{ mV}_{PP}$ ,  $G = +1$ ,  $C_L = 15\text{ pF}$

图 35. Small-Signal Step Response

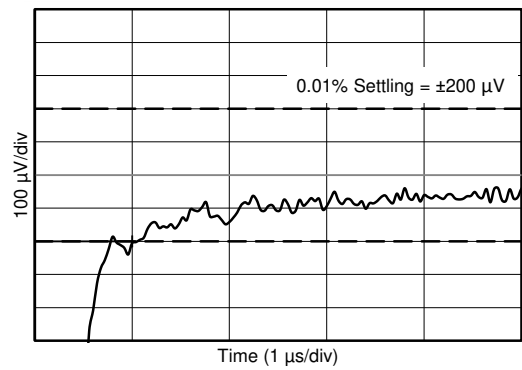

C217

$V_{IN} = 2\text{-V step}$

图 36. 0.01% Positive Settling Time

Typical Characteristics (接下页)

at  $T_A = 25^\circ\text{C}$ ,  $V_{CM} = V_{OUT} = \text{midsupply}$ , and  $R_L = 10\text{ k}\Omega$  (unless otherwise noted)

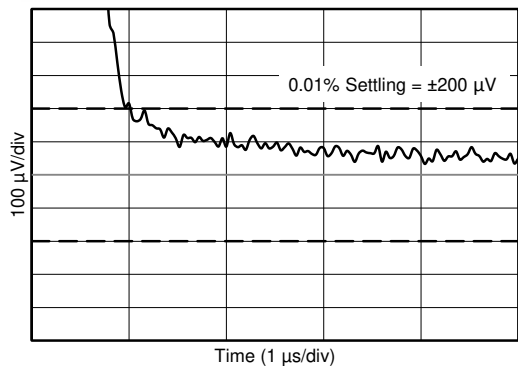

$V_{IN} = 2\text{-V step}$

C216

图 37. 0.01% Negative Settling Time

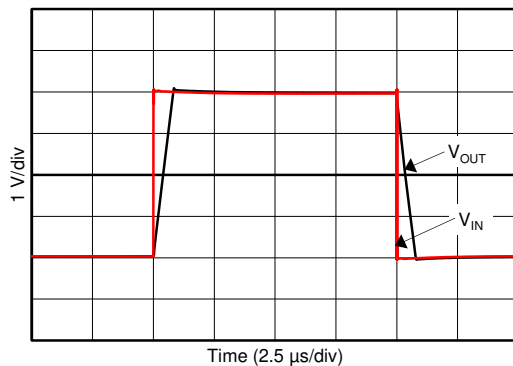

$V_{IN} = 4\text{ V}_{PP}$ ,  $G = +1$ ,  $C_L = 15\text{ pF}$

C215

图 38. Large-Signal Step Response

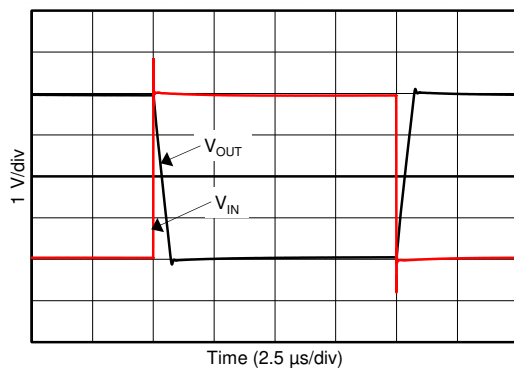

$V_{IN} = 4\text{ V}_{PP}$ ,  $G = -1$ ,  $C_L = 15\text{ pF}$

C214

图 39. Large-Signal Step Response

## 7 Detailed Description

### 7.1 Overview

The OPA325, OPA2325, and OPA4325 (OPAx325) belong to a new generation of low-noise, e-trim™ operational amplifiers that provide outstanding dc precision. The OPAx325 also have a highly linear input stage with zero-crossover distortion that delivers excellent CMRR and distortion performance across the full rail-to-rail input range. In addition, this device has a wide supply range with excellent PSRR. This feature, combined with low quiescent current, makes the OPAx325 an excellent choice for applications that are battery-powered without regulation.

### 7.2 Functional Block Diagram

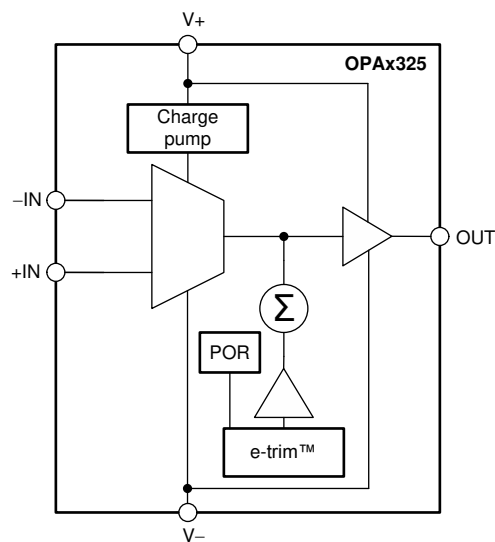



### 7.3 Feature Description

#### 7.3.1 Zero-Crossover Input Stage

Traditional complementary metal-oxide semiconductor (CMOS) rail-to-rail input amplifiers use a complementary input stage: an N-channel input differential pair in parallel with a P-channel differential pair. This configuration results in sudden change in offset voltage when the input stage transitions from the p-channel metal-oxide-semiconductor field effect transistor (PMOS) to the n-type field effect transistor (NMOS), or vice-versa, as shown in 图 40. This transition results in significant degradation of CMRR and PSRR performance of the amplifier.



图 40. Input Common-Mode Voltage vs Input Offset Voltage (Traditional Rail-to-Rail Input CMOS Amplifiers)

The OPAx325 series of amplifiers includes an internal charge pump that powers the amplifier input stage with an internal supply rail that is higher than the external power supply. The internal supply rail allows a single differential pair to operate and to be linear across the entire input common-mode voltage range, thus eliminating crossover distortion. Rail-to-rail amplifiers that use this technique to eliminate crossover distortion are called *zero-crossover amplifiers*.

The single differential pair combined with the charge pump allows the OPAx325 to provide superior CMRR across the entire common-mode input range, which extends 100 mV beyond both power-supply rails. 图 41 shows the input offset voltage versus input common-mode voltage plot for the OPAx325. Note that unlike traditional rail-to-rail CMOS amplifiers, there is no transition region for the OPAx325.

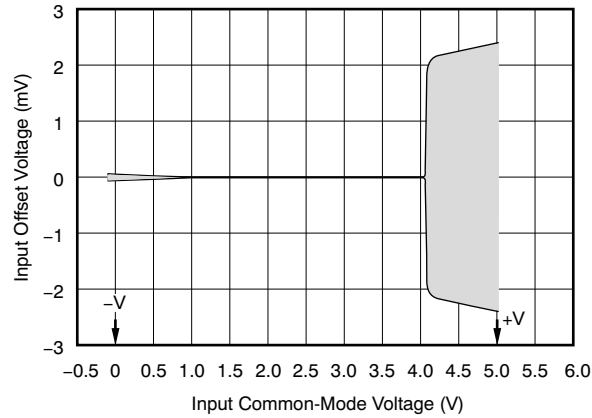

图 41. Offset Voltage vs Common-Mode Voltage (Zero-Crossover)

## Feature Description (接下页)

### 7.3.2 Low Input Offset Voltage

The OPAX325 are manufactured using TI's e-trim technology. Each amplifier is trimmed in production, thereby minimizing errors associated with input offset voltage. The e-trim technology is a TI proprietary method of trimming internal device parameters during either wafer probing or final testing. This process allows the OPAX325 to have an excellent offset specification of 150  $\mu\text{V}$  (maximum). 图 42 shows the offset voltage distribution for the OPAX325.

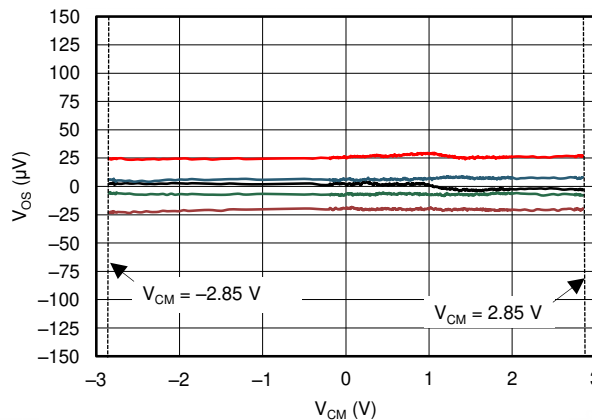

图 42. Offset Voltage Distribution

### 7.3.3 Input and ESD Protection

The OPAX325 incorporate internal electrostatic discharge (ESD) protection circuits on all pins. In the case of input and output pins, this protection primarily consists of current-steering diodes connected between the input and power-supply pins. These ESD protection diodes also provide in-circuit, input overdrive protection, as long as the current is limited to 10 mA as stated in the *Absolute Maximum Ratings* table. 图 43 shows how a series input resistor can be added to the driven input to limit the input current. The added resistor contributes thermal noise at the amplifier input; thus, keep the value to a minimum in noise-sensitive applications.

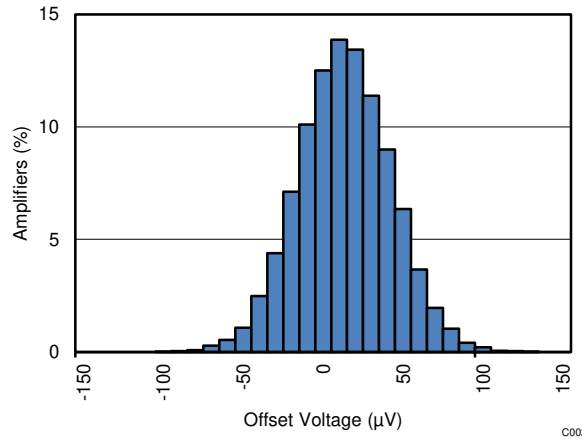

图 43. Input Current Protection

## 7.4 Device Functional Modes

The OPAX325 have a single functional mode and are operational when the power-supply voltage is greater than 2.2 V ( $\pm 1.1$  V). The maximum power-supply voltage for the OPAX325 is 5.5 V ( $\pm 2.75$  V).

## 8 Application and Implementation

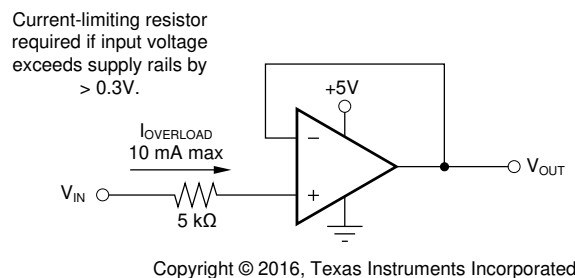
### 注

Information in the following applications sections is not part of the TI component specification, and TI does not warrant its accuracy or completeness. TI's customers are responsible for determining suitability of components for their purposes. Customers should validate and test their design implementation to confirm system functionality.

### 8.1 Application Information

The OPAx325 series features e-trim, a proprietary technique in which the offset voltage is adjusted during the final steps of manufacturing. As a result, the OPAx325 deliver excellent offset voltage (40  $\mu\text{V}$ , typical). Additionally, the amplifier boasts a fast slew rate, low drift, low noise, and excellent PSRR and  $A_{OL}$ . The OPAx325 also feature a linear input stage with zero-crossover distortion, resulting in excellent CMRR over the entire input range, which extends from 100 mV below the negative rail to 100 mV above the positive rail.

#### 8.1.1 Operating Characteristics

The OPAx325 family of amplifiers has parameters that are fully specified from 2.2 V to 5.5 V ( $\pm 1.1$  V to  $\pm 2.75$  V). Many of the specifications apply from  $-40^\circ\text{C}$  to  $+125^\circ\text{C}$ . Parameters that can exhibit significant variance with regard to operating voltage or temperature are presented in the [Typical Characteristics](#) section.

#### 8.1.2 Basic Amplifier Configurations

The OPAx325 are unity-gain stable. The devices do not exhibit output phase inversion when the input is overdriven. A typical single-supply connection is shown in [图 44](#). The OPAx325 are configured as a basic inverting amplifier with a gain of  $-10$  V/V. This single-supply connection has an output centered on the common-mode voltage,  $V_{CM}$ . For the circuit shown, this voltage is 2.5 V, but can be any value within the common-mode input voltage range.

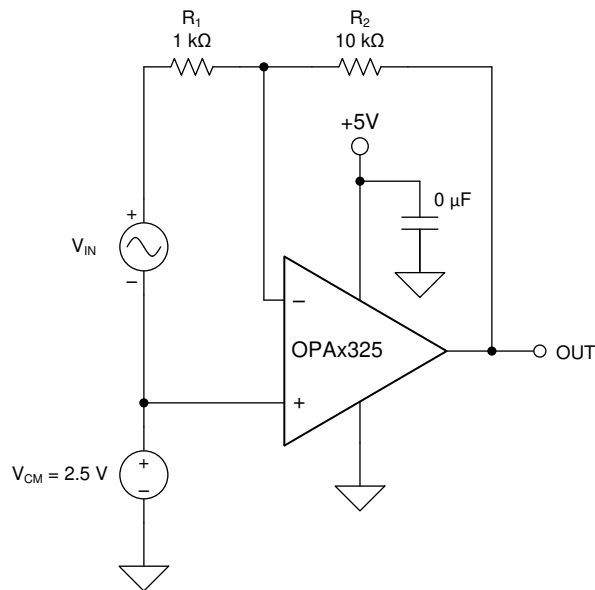

Copyright © 2017, Texas Instruments Incorporated

图 44. Basic Single-Supply Connection

## Application Information (接下页)

### 8.1.3 Driving an Analog-to-Digital Converter

The low-noise and wide-gain bandwidth of the OPAx325, combined with rail-to-rail input/output and zero-crossover distortion, make these devices an excellent input driver for ADCs. 图 45 shows the OPAx325 driving an ADC. The amplifier is connected as a unity-gain, noninverting buffer.



图 45. The OPAx325 as an Input Driver for ADCs

## 8.2 Typical Application

Operational amplifiers are commonly used as unity-gain buffers. 图 46 shows the schematic for an amplifier configured as a unity-gain buffer. If the input signal range to the amplifier is very close to the rails or includes the rails, a rail-to-rail amplifier must be used. However, regular rail-to-rail amplifiers introduce significant distortion to the signal. This design compares the distortion introduced by a typical CMOS input amplifier with that of the OPAx325 (a zero-crossover amplifier).

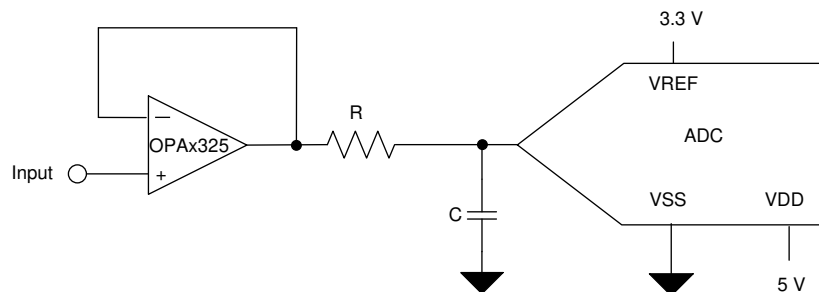

图 46. The OPAx325 Configured as a Unity-Gain Buffer Amplifier

### 8.2.1 Design Requirements

The following parameters are used for this design example:

- Gain = +1 V/V (inverting gain)
- $V_+ = 2.5\text{ V}$ ,  $V_- = -2.5\text{ V}$
- Input signal =  $4\text{ V}_{PP}$ ,  $f = 1\text{-kHz}$  sine wave

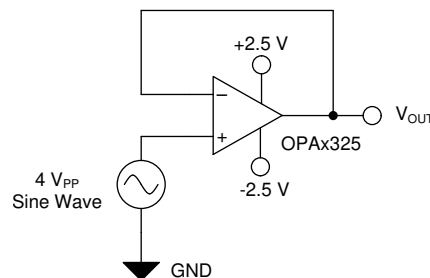
Typical Application (接下页)

8.2.2 Detailed Design Procedure

Traditional CMOS rail-to-rail input amplifiers use a complementary input stage: an N-channel input differential pair in parallel with a P-channel differential pair, as shown in 图 47.



图 47. Complementary Input Stage (Traditional Rail-to-Rail Input CMOS Amplifiers)

### Typical Application (接下页)

The N-channel pair is active for input voltages close to the positive rail, typically  $(V+) - 1\text{ V}$  to 200 mV above the positive supply, and the P-channel pair is on for inputs from 200 mV below the negative supply to approximately  $(V+) - 1\text{ V}$ . There is a small transition region, typically  $(V+) - 1.1\text{ V}$  to  $(V+) - 0.9\text{ V}$ , in which both pairs are on. This transition region is shown in 图 48 for a traditional rail-to-rail input CMOS amplifier. Within this transition region, PSRR, CMRR, offset voltage, offset drift, and THD can be degraded when compared to device operation outside of this region.

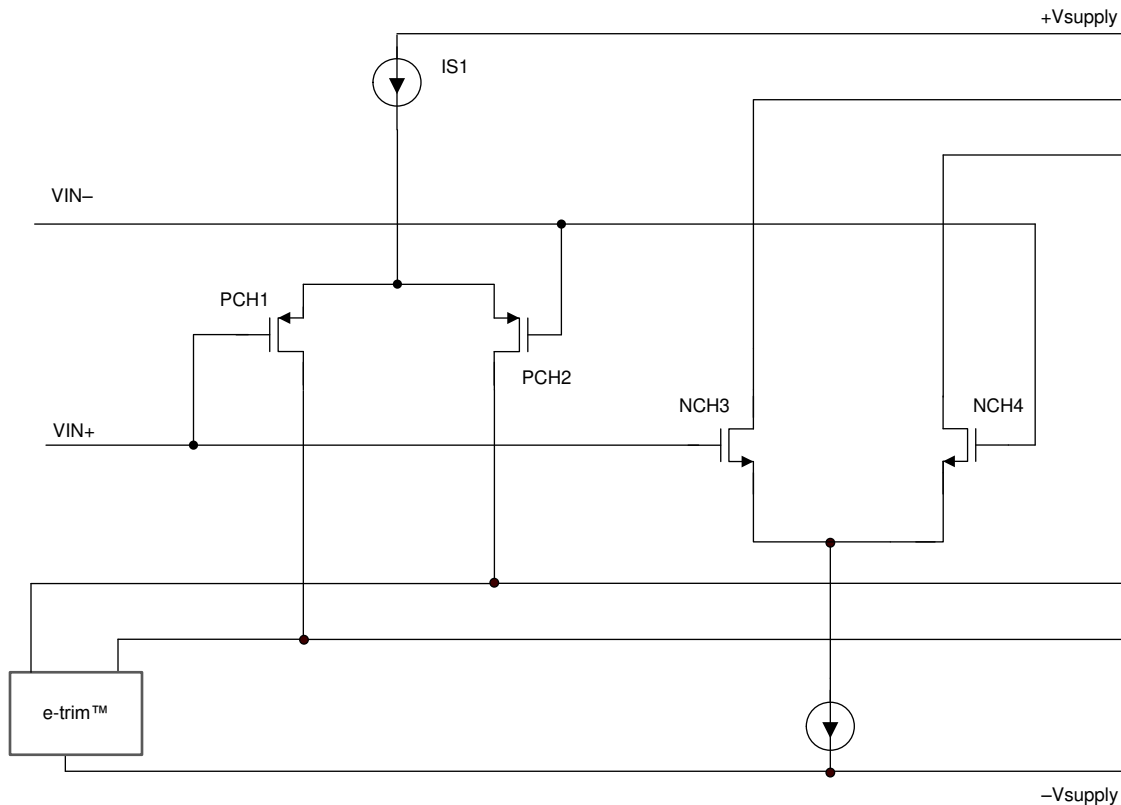

图 48. Input Offset Voltage vs Common-Mode Voltage (For Traditional Rail-to-Rail Input CMOS Amplifiers)

The OPAx325 amplifiers include an internal charge pump that powers the amplifier input stage with an internal supply rail that is higher than the external power supply. The internal supply rail allows a single differential pair to operate and to be linear across the entire input common-mode voltage range, as shown in 表 1.

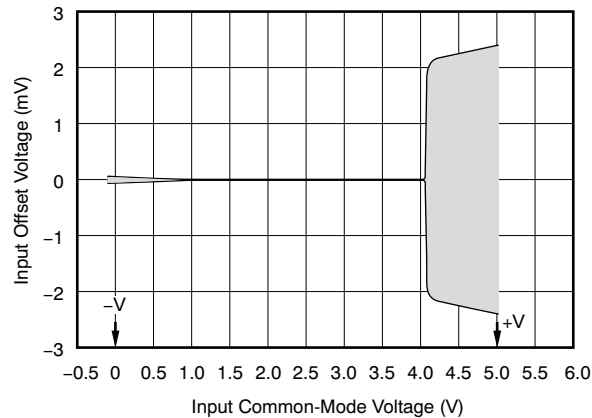

图 49. Single Differential Input Pair with a Charge Pump (Zero-Crossover)

## Typical Application (接下页)

The unique zero-crossover topology shown in 表 1 eliminates the input offset transition region, typical of most rail-to-rail input operational amplifiers. This topology allows the OPAx325 to provide superior CMRR across the entire common-mode input range that extends 100 mV beyond both power-supply rails. 图 50 shows the input offset voltage versus input common-mode voltage plot for the OPAx325.

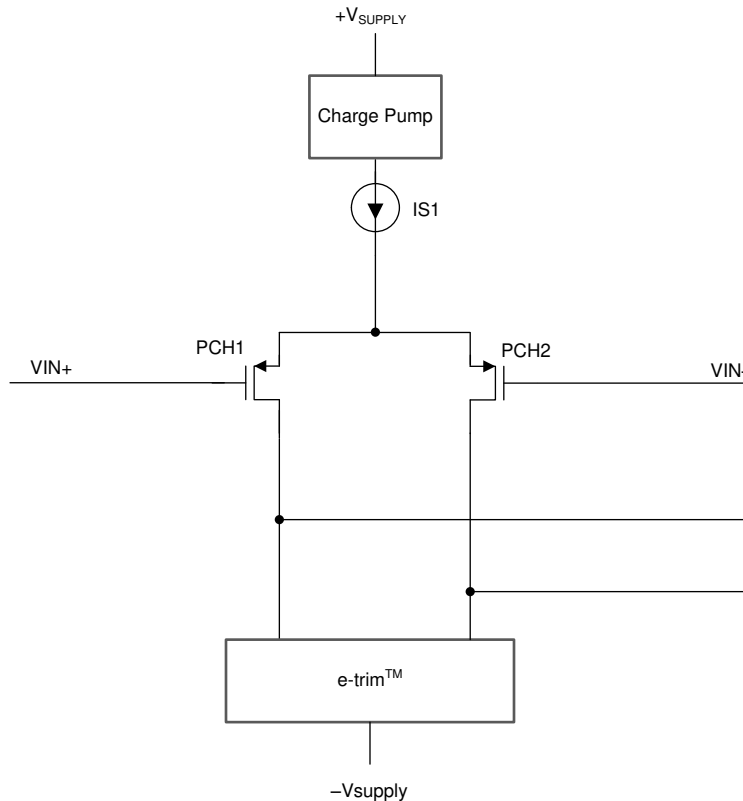

图 50. Offset Voltage vs Common-Mode Voltage (OPAx325, Zero-Crossover Amplifier)

The OPAx325 and a typical CMOS amplifier were used in identical circuits where these amplifiers were configured as a unity-gain buffer amplifier; see 图 51 and 图 52. A pure sine wave with an amplitude of 2 V (4 V<sub>PP</sub>) was given as input to the two identical circuits of 图 51 and 图 52. The outputs of these circuits were captured on a spectrum analyzer. 图 53 and 图 54 illustrate the output voltage spectrum for the OPAx325 and a typical CMOS rail-to-rail amplifier, respectively. The output of the OPAx325 has very few spurs and harmonics when compared to the typical rail-to-rail CMOS amplifier, as illustrated in 图 55.



图 51. OPAx325 as a Unity-Gain Buffer

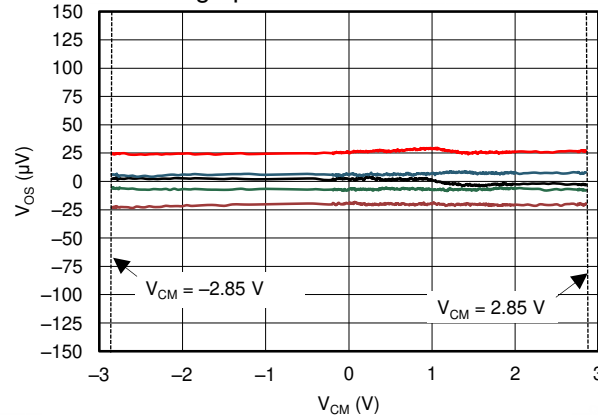

图 52. Typical CMOS Rail-to-Rail Amplifier as a Unity-Gain Buffer

Typical Application (接下页)

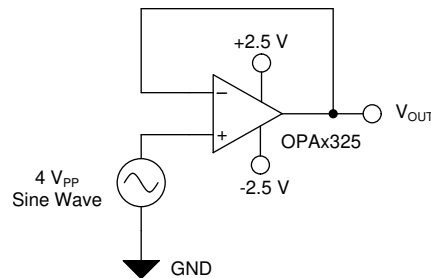
8.2.3 Application Curves



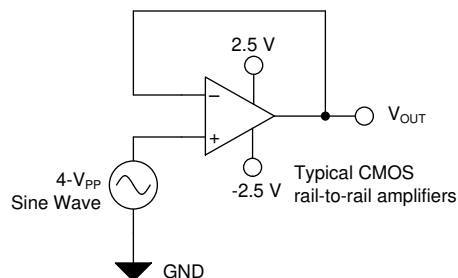
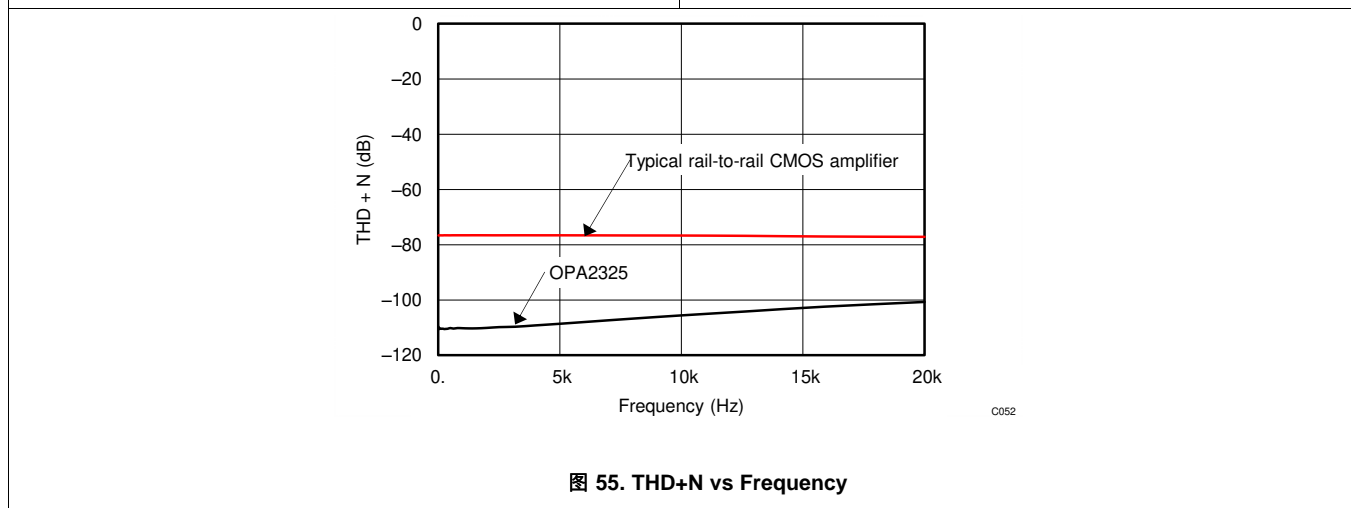
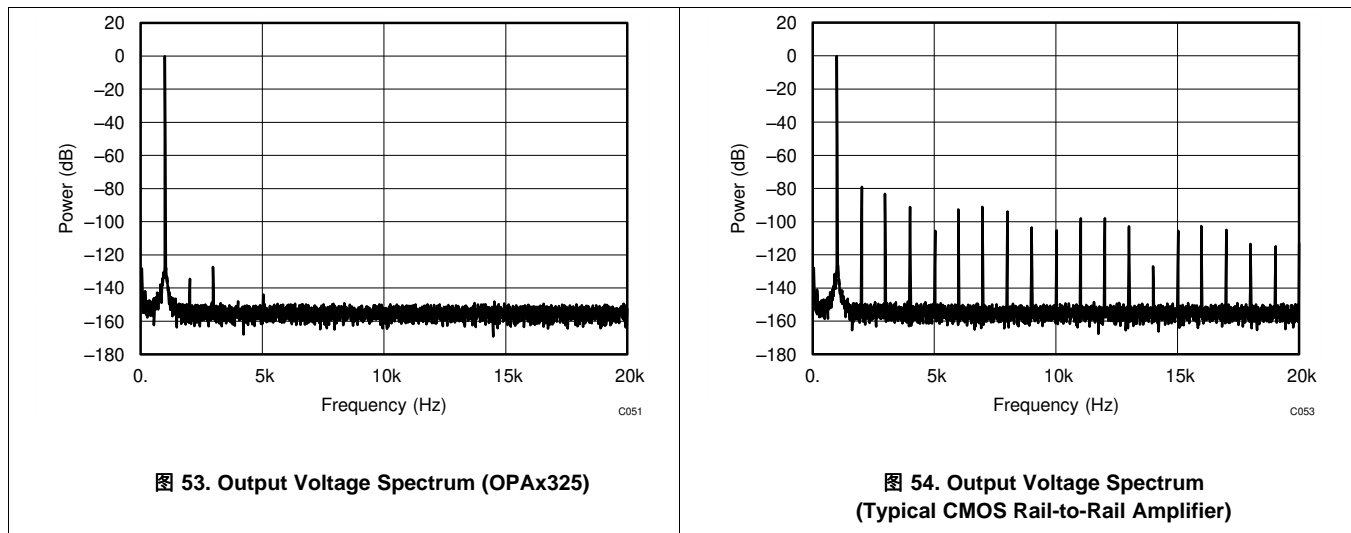

## 9 Power Supply Recommendations

The OPAx325 are specified for operation from 2.2 V to 5.5 V ( $\pm 1.1$  V to  $\pm 2.75$  V); many specifications apply from  $-40^{\circ}\text{C}$  to  $+125^{\circ}\text{C}$ . Parameters that can exhibit significant variance with regard to operating voltage or temperature are presented in the [Typical Characteristics](#) section.

## 10 Layout

### 10.1 Layout Guidelines

For best operational performance of the device, use good printed circuit board (PCB) layout practices, including:

- Noise can propagate into analog circuitry through the power pins of the circuit as a whole and of op amp itself. Bypass capacitors are used to reduce the coupled noise by providing low-impedance power sources local to the analog circuitry.
  - Connect low-ESR, 0.1- $\mu\text{F}$  ceramic bypass capacitors between each supply pin and ground, placed as close as possible to the device. A single bypass capacitor from V+ to ground is applicable for single-supply applications.
- Separate grounding for analog and digital portions of circuitry is one of the simplest and most-effective methods of noise suppression. One or more layers on multilayer PCBs are usually devoted to ground planes. A ground plane helps distribute heat and reduces electromagnetic interference (EMI) noise pickup. Make sure to physically separate digital and analog grounds, paying attention to the flow of the ground current. For more detailed information refer to, see [Circuit Board Layout Techniques](#).
- In order to reduce parasitic coupling, run the input traces as far away as possible from the supply or output traces. If these traces cannot be kept separate, crossing the sensitive trace perpendicular is much better as opposed to in parallel with the noisy trace.
- Place the external components as close as possible to the device. As illustrated in [Figure 57](#), keeping RF and RG close to the inverting input minimizes parasitic capacitance.
- Keep the length of input traces as short as possible. Always remember that the input traces are the most sensitive part of the circuit.
- Consider a driven, low-impedance guard ring around the critical traces. A guard ring can significantly reduce leakage currents from nearby traces that are at different potentials.
- For best performance, clean the PCB following board assembly.
- Any precision integrated circuit can experience performance shifts resulting from moisture ingress into the plastic package. Following any aqueous PCB cleaning process, baking the PCB assembly is recommended to remove moisture introduced into the device packaging during the cleaning process. A low-temperature, post-cleaning bake at  $85^{\circ}\text{C}$  for 30 minutes is sufficient for most circumstances.

## 10.2 Layout Example



图 56. Schematic Representation for 图 57



图 57. Layout Example

## 11 器件和文档支持

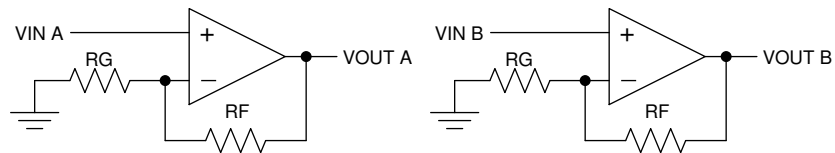
### 11.1 文档支持

#### 11.1.1 相关文档

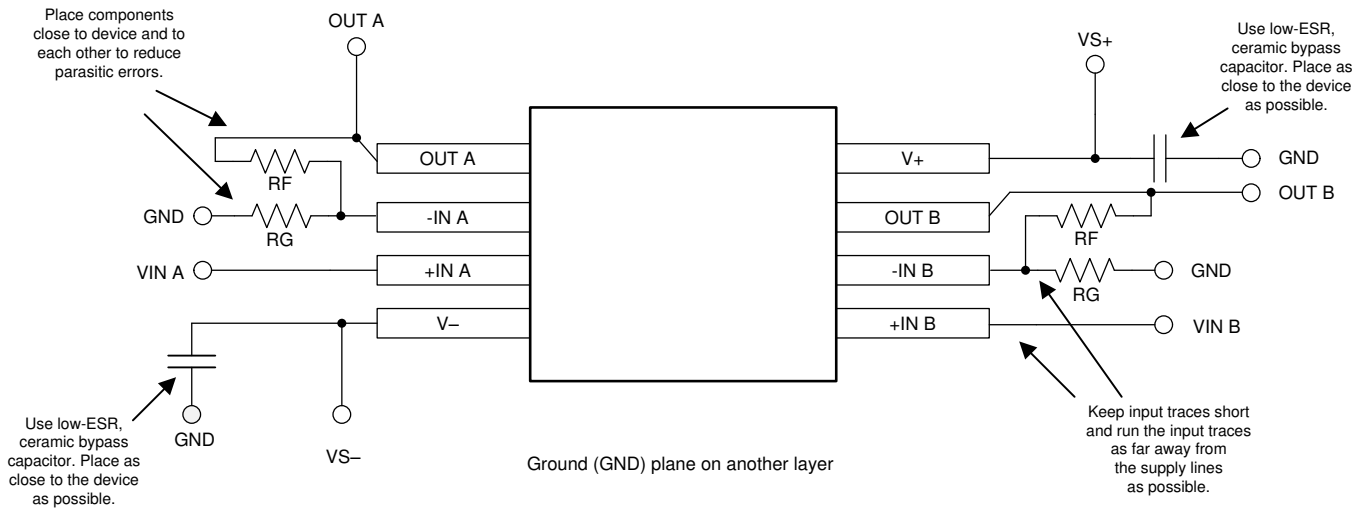
请参阅如下相关文档:

德州仪器 (TI), [《电路板布局技巧》应用报告](#)

### 11.2 相关链接

表 1 列出了快速访问链接。类别包括技术文档、支持和社区资源、工具与软件, 以及立即订购快速访问。

表 1. 相关链接

器件	产品文件夹	立即订购	技术文档	工具与软件	支持和社区
OPA325	<a href="#">单击此处</a>	<a href="#">单击此处</a>	<a href="#">单击此处</a>	<a href="#">单击此处</a>	<a href="#">单击此处</a>
OPA2325	<a href="#">单击此处</a>	<a href="#">单击此处</a>	<a href="#">单击此处</a>	<a href="#">单击此处</a>	<a href="#">单击此处</a>
OPA4325	<a href="#">单击此处</a>	<a href="#">单击此处</a>	<a href="#">单击此处</a>	<a href="#">单击此处</a>	<a href="#">单击此处</a>

### 11.3 接收文档更新通知

要接收文档更新通知, 请导航至 [TI.com.cn](http://TI.com.cn) 上的器件产品文件夹。单击右上角的 [通知我](#) 进行注册, 即可每周接收产品信息更改摘要。有关更改的详细信息, 请查看任何已修订文档中包含的修订历史记录。

### 11.4 社区资源

The following links connect to TI community resources. Linked contents are provided "AS IS" by the respective contributors. They do not constitute TI specifications and do not necessarily reflect TI's views; see TI's [Terms of Use](#).

**TI E2E™ Online Community** *TI's Engineer-to-Engineer (E2E) Community*. Created to foster collaboration among engineers. At [e2e.ti.com](http://e2e.ti.com), you can ask questions, share knowledge, explore ideas and help solve problems with fellow engineers.

**Design Support** *TI's Design Support* Quickly find helpful E2E forums along with design support tools and contact information for technical support.

### 11.5 商标

e-trim, E2E are trademarks of Texas Instruments.  
All other trademarks are the property of their respective owners.

### 11.6 静电放电警告



ESD 可能会损坏该集成电路。德州仪器 (TI) 建议通过适当的预防措施处理所有集成电路。如果不遵守正确的处理措施和安装程序, 可能会损坏集成电路。

ESD 的损坏小至导致微小的性能降级, 大至整个器件故障。精密的集成电路可能更容易受到损坏, 这是因为非常细微的参数更改都可能会导致器件与其发布的规格不相符。

### 11.7 Glossary

[SLYZ022](#) — *TI Glossary*.

This glossary lists and explains terms, acronyms, and definitions.

## 12 机械、封装和可订购信息

以下页面包含机械、封装和可订购信息。这些信息是指定器件的最新可用数据。数据如有变更, 恕不另行通知, 且不会对此文档进行修订。如需获取此数据表的浏览器版本, 请查阅左侧的导航栏。

## PACKAGING INFORMATION

Orderable Device	Status (1)	Package Type	Package Drawing	Pins	Package Qty	Eco Plan (2)	Lead finish/ Ball material (6)	MSL Peak Temp (3)	Op Temp (°C)	Device Marking (4/5)	Samples
OPA2325ID	ACTIVE	SOIC	D	8	75	RoHS & Green	NIPDAU	Level-2-260C-1 YEAR	-40 to 125	O2325	<a href="#">Samples</a>
OPA2325IDGKR	ACTIVE	VSSOP	DGK	8	2500	RoHS & Green	NIPDAUAG   SN	Level-2-260C-1 YEAR	-40 to 125	18L6	<a href="#">Samples</a>
OPA2325IDGKT	ACTIVE	VSSOP	DGK	8	250	RoHS & Green	NIPDAUAG   SN	Level-2-260C-1 YEAR	-40 to 125	18L6	<a href="#">Samples</a>
OPA2325IDR	ACTIVE	SOIC	D	8	2500	RoHS & Green	NIPDAU	Level-2-260C-1 YEAR	-40 to 125	O2325	<a href="#">Samples</a>
OPA325IDBVR	ACTIVE	SOT-23	DBV	5	3000	RoHS & Green	NIPDAU	Level-2-260C-1 YEAR	-40 to 125	1UEV	<a href="#">Samples</a>
OPA325IDBVT	ACTIVE	SOT-23	DBV	5	250	RoHS & Green	NIPDAU	Level-2-260C-1 YEAR	-40 to 125	1UEV	<a href="#">Samples</a>
OPA4325IPW	ACTIVE	TSSOP	PW	14	90	RoHS & Green	NIPDAU	Level-2-260C-1 YEAR	-40 to 125	4325	<a href="#">Samples</a>
OPA4325IPWR	ACTIVE	TSSOP	PW	14	2000	RoHS & Green	NIPDAU	Level-2-260C-1 YEAR	-40 to 125	4325	<a href="#">Samples</a>

(1) The marketing status values are defined as follows:

**ACTIVE:** Product device recommended for new designs.

**LIFEBUY:** TI has announced that the device will be discontinued, and a lifetime-buy period is in effect.

**NRND:** Not recommended for new designs. Device is in production to support existing customers, but TI does not recommend using this part in a new design.

**PREVIEW:** Device has been announced but is not in production. Samples may or may not be available.

**OBSOLETE:** TI has discontinued the production of the device.

(2) **RoHS:** TI defines "RoHS" to mean semiconductor products that are compliant with the current EU RoHS requirements for all 10 RoHS substances, including the requirement that RoHS substance do not exceed 0.1% by weight in homogeneous materials. Where designed to be soldered at high temperatures, "RoHS" products are suitable for use in specified lead-free processes. TI may reference these types of products as "Pb-Free".

**RoHS Exempt:** TI defines "RoHS Exempt" to mean products that contain lead but are compliant with EU RoHS pursuant to a specific EU RoHS exemption.

**Green:** TI defines "Green" to mean the content of Chlorine (Cl) and Bromine (Br) based flame retardants meet JS709B low halogen requirements of <=1000ppm threshold. Antimony trioxide based flame retardants must also meet the <=1000ppm threshold requirement.

(3) MSL, Peak Temp. - The Moisture Sensitivity Level rating according to the JEDEC industry standard classifications, and peak solder temperature.

(4) There may be additional marking, which relates to the logo, the lot trace code information, or the environmental category on the device.

(5) Multiple Device Markings will be inside parentheses. Only one Device Marking contained in parentheses and separated by a "~" will appear on a device. If a line is indented then it is a continuation of the previous line and the two combined represent the entire Device Marking for that device.

<sup>(6)</sup> Lead finish/Ball material - Orderable Devices may have multiple material finish options. Finish options are separated by a vertical ruled line. Lead finish/Ball material values may wrap to two lines if the finish value exceeds the maximum column width.

**Important Information and Disclaimer:**The information provided on this page represents TI's knowledge and belief as of the date that it is provided. TI bases its knowledge and belief on information provided by third parties, and makes no representation or warranty as to the accuracy of such information. Efforts are underway to better integrate information from third parties. TI has taken and continues to take reasonable steps to provide representative and accurate information but may not have conducted destructive testing or chemical analysis on incoming materials and chemicals. TI and TI suppliers consider certain information to be proprietary, and thus CAS numbers and other limited information may not be available for release.

In no event shall TI's liability arising out of such information exceed the total purchase price of the TI part(s) at issue in this document sold by TI to Customer on an annual basis.

## TAPE AND REEL INFORMATION



### QUADRANT ASSIGNMENTS FOR PIN 1 ORIENTATION IN TAPE



\*All dimensions are nominal

Device	Package Type	Package Drawing	Pins	SPQ	Reel Diameter (mm)	Reel Width W1 (mm)	A0 (mm)	B0 (mm)	K0 (mm)	P1 (mm)	W (mm)	Pin1 Quadrant
OPA2325IDGKR	VSSOP	DGK	8	2500	330.0	12.4	5.25	3.35	1.25	8.0	12.0	Q1
OPA2325IDGKT	VSSOP	DGK	8	250	330.0	12.4	5.25	3.35	1.25	8.0	12.0	Q1
OPA2325IDR	SOIC	D	8	2500	330.0	12.4	6.4	5.2	2.1	8.0	12.0	Q1
OPA325IDBVR	SOT-23	DBV	5	3000	180.0	8.4	3.23	3.17	1.37	4.0	8.0	Q3
OPA325IDBVT	SOT-23	DBV	5	250	180.0	8.4	3.23	3.17	1.37	4.0	8.0	Q3
OPA4325IPWR	TSSOP	PW	14	2000	330.0	12.4	6.9	5.6	1.6	8.0	12.0	Q1

**TAPE AND REEL BOX DIMENSIONS**

\*All dimensions are nominal

Device	Package Type	Package Drawing	Pins	SPQ	Length (mm)	Width (mm)	Height (mm)
OPA2325IDGKR	VSSOP	DGK	8	2500	366.0	364.0	50.0
OPA2325IDGKT	VSSOP	DGK	8	250	366.0	364.0	50.0
OPA2325IDR	SOIC	D	8	2500	356.0	356.0	35.0
OPA325IDBVR	SOT-23	DBV	5	3000	213.0	191.0	35.0
OPA325IDBVT	SOT-23	DBV	5	250	213.0	191.0	35.0
OPA4325IPWR	TSSOP	PW	14	2000	356.0	356.0	35.0

**TUBE**

\*All dimensions are nominal

Device	Package Name	Package Type	Pins	SPQ	L (mm)	W (mm)	T (μm)	B (mm)
OPA2325ID	D	SOIC	8	75	506.6	8	3940	4.32
OPA4325IPW	PW	TSSOP	14	90	530	10.2	3600	3.5





# EXAMPLE BOARD LAYOUT

DBV0005A

SOT-23 - 1.45 mm max height

SMALL OUTLINE TRANSISTOR



LAND PATTERN EXAMPLE  
EXPOSED METAL SHOWN  
SCALE:15X



SOLDER MASK DETAILS

4214839/K 08/2024

NOTES: (continued)

- 6. Publication IPC-7351 may have alternate designs.
- 7. Solder mask tolerances between and around signal pads can vary based on board fabrication site.

# EXAMPLE STENCIL DESIGN

DBV0005A

SOT-23 - 1.45 mm max height

SMALL OUTLINE TRANSISTOR



SOLDER PASTE EXAMPLE  
BASED ON 0.125 mm THICK STENCIL  
SCALE:15X

4214839/K 08/2024

NOTES: (continued)

8. Laser cutting apertures with trapezoidal walls and rounded corners may offer better paste release. IPC-7525 may have alternate design recommendations.
9. Board assembly site may have different recommendations for stencil design.

# DGK0008A



# PACKAGE OUTLINE

VSSOP - 1.1 mm max height

SMALL OUTLINE PACKAGE



**NOTES:**

PowerPAD is a trademark of Texas Instruments.

1. All linear dimensions are in millimeters. Any dimensions in parenthesis are for reference only. Dimensioning and tolerancing per ASME Y14.5M.
2. This drawing is subject to change without notice.
3. This dimension does not include mold flash, protrusions, or gate burrs. Mold flash, protrusions, or gate burrs shall not exceed 0.15 mm per side.
4. This dimension does not include interlead flash. Interlead flash shall not exceed 0.25 mm per side.
5. Reference JEDEC registration MO-187.

# EXAMPLE BOARD LAYOUT

DGK0008A

™ VSSOP - 1.1 mm max height

SMALL OUTLINE PACKAGE



LAND PATTERN EXAMPLE  
EXPOSED METAL SHOWN  
SCALE: 15X



SOLDER MASK DETAILS

4214862/A 04/2023

NOTES: (continued)

6. Publication IPC-7351 may have alternate designs.
7. Solder mask tolerances between and around signal pads can vary based on board fabrication site.
8. Vias are optional depending on application, refer to device data sheet. If any vias are implemented, refer to their locations shown on this view. It is recommended that vias under paste be filled, plugged or tented.
9. Size of metal pad may vary due to creepage requirement.

# EXAMPLE STENCIL DESIGN

DGK0008A

<sup>TM</sup> VSSOP - 1.1 mm max height

SMALL OUTLINE PACKAGE



SOLDER PASTE EXAMPLE  
SCALE: 15X

4214862/A 04/2023

NOTES: (continued)

11. Laser cutting apertures with trapezoidal walls and rounded corners may offer better paste release. IPC-7525 may have alternate design recommendations.
12. Board assembly site may have different recommendations for stencil design.

PW0014A



**PACKAGE OUTLINE**  
**TSSOP - 1.2 mm max height**

SMALL OUTLINE PACKAGE



4220202/B 12/2023

NOTES:

1. All linear dimensions are in millimeters. Any dimensions in parenthesis are for reference only. Dimensioning and tolerancing per ASME Y14.5M.
2. This drawing is subject to change without notice.
3. This dimension does not include mold flash, protrusions, or gate burrs. Mold flash, protrusions, or gate burrs shall not exceed 0.15 mm per side.
4. This dimension does not include interlead flash. Interlead flash shall not exceed 0.25 mm per side.
5. Reference JEDEC registration MO-153.

# EXAMPLE BOARD LAYOUT

PW0014A

TSSOP - 1.2 mm max height

SMALL OUTLINE PACKAGE



LAND PATTERN EXAMPLE  
EXPOSED METAL SHOWN  
SCALE: 10X



4220202/B 12/2023

NOTES: (continued)

- 6. Publication IPC-7351 may have alternate designs.
- 7. Solder mask tolerances between and around signal pads can vary based on board fabrication site.



# EXAMPLE STENCIL DESIGN

PW0014A

TSSOP - 1.2 mm max height

SMALL OUTLINE PACKAGE



SOLDER PASTE EXAMPLE  
BASED ON 0.125 mm THICK STENCIL  
SCALE: 10X

4220202/B 12/2023

NOTES: (continued)

8. Laser cutting apertures with trapezoidal walls and rounded corners may offer better paste release. IPC-7525 may have alternate design recommendations.
9. Board assembly site may have different recommendations for stencil design.



D0008A

# PACKAGE OUTLINE

SOIC - 1.75 mm max height

SMALL OUTLINE INTEGRATED CIRCUIT



4214825/C 02/2019

## NOTES:

- Linear dimensions are in inches [millimeters]. Dimensions in parenthesis are for reference only. Controlling dimensions are in inches. Dimensioning and tolerancing per ASME Y14.5M.
- This drawing is subject to change without notice.
- This dimension does not include mold flash, protrusions, or gate burrs. Mold flash, protrusions, or gate burrs shall not exceed .006 [0.15] per side.
- This dimension does not include interlead flash.
- Reference JEDEC registration MS-012, variation AA.

# EXAMPLE BOARD LAYOUT

D0008A

SOIC - 1.75 mm max height

SMALL OUTLINE INTEGRATED CIRCUIT



LAND PATTERN EXAMPLE  
EXPOSED METAL SHOWN  
SCALE:8X



SOLDER MASK DETAILS

4214825/C 02/2019

NOTES: (continued)

- 6. Publication IPC-7351 may have alternate designs.
- 7. Solder mask tolerances between and around signal pads can vary based on board fabrication site.

# EXAMPLE STENCIL DESIGN

D0008A

SOIC - 1.75 mm max height

SMALL OUTLINE INTEGRATED CIRCUIT



SOLDER PASTE EXAMPLE  
BASED ON .005 INCH [0.125 MM] THICK STENCIL  
SCALE:8X

4214825/C 02/2019

NOTES: (continued)

8. Laser cutting apertures with trapezoidal walls and rounded corners may offer better paste release. IPC-7525 may have alternate design recommendations.
9. Board assembly site may have different recommendations for stencil design.

## 重要声明和免责声明

TI“按原样”提供技术和可靠性数据（包括数据表）、设计资源（包括参考设计）、应用或其他设计建议、网络工具、安全信息和其他资源，不保证没有瑕疵且不做任何明示或暗示的担保，包括但不限于对适销性、某特定用途方面的适用性或不侵犯任何第三方知识产权的暗示担保。

这些资源可供使用 TI 产品进行设计的熟练开发人员使用。您将自行承担以下全部责任：(1) 针对您的应用选择合适的 TI 产品，(2) 设计、验证并测试您的应用，(3) 确保您的应用满足相应标准以及任何其他功能安全、信息安全、监管或其他要求。

这些资源如有变更，恕不另行通知。TI 授权您仅可将这些资源用于研发本资源所述的 TI 产品的应用。严禁对这些资源进行其他复制或展示。您无权使用任何其他 TI 知识产权或任何第三方知识产权。您应全额赔偿因在这些资源的使用中对 TI 及其代表造成的任何索赔、损害、成本、损失和债务，TI 对此概不负责。

TI 提供的产品受 [TI 的销售条款](#) 或 [ti.com](#) 上其他适用条款/TI 产品随附的其他适用条款的约束。TI 提供这些资源并不会扩展或以其他方式更改 TI 针对 TI 产品发布的适用的担保或担保免责声明。

TI 反对并拒绝您可能提出的任何其他或不同的条款。

邮寄地址：Texas Instruments, Post Office Box 655303, Dallas, Texas 75265  
Copyright © 2024，德州仪器 (TI) 公司