

CMOS, Rail-to-Rail, I/O OPERATIONAL AMPLIFIERS

FEATURES

- RAIL-TO-RAIL INPUT AND OUTPUT
- WIDE SUPPLY RANGE:
Single Supply: 4V to 12V
Dual Supplies: ± 2 to ± 6
- LOW QUIESCENT CURRENT: 160 μ A
- FULL-SCALE CMRR: 90dB
- LOW OFFSET: 160 μ V
- HIGH SPEED:
OPA703: 1MHz, 0.6V/ μ s
OPA704: 3MHz, 3V/ μ s
- *Micro*SIZE PACKAGES:
SOT23-5, MSOP-8, TSSOP-14
- LOW INPUT BIAS CURRENT: 1pA

APPLICATIONS

- AUTOMOTIVE APPLICATIONS:
Audio, Sensor Applications, Security Systems
- PORTABLE EQUIPMENT
- ACTIVE FILTERS
- TRANSDUCER AMPLIFIER
- TEST EQUIPMENT
- DATA ACQUISITION

DESCRIPTION

The OPA703 and OPA704 series op amps are optimized for applications requiring rail-to-rail input and output swing. Single, dual, and quad versions are offered in a variety of packages. While the quiescent current is less than 200 μ A per amplifier, the OPA703 still offers excellent dynamic performance (1MHz GBW and 0.6V/ μ s SR) and unity-gain stability. The OPA704 is optimized for gains of 5 or greater and provides 3MHz GBW and 3V/ μ s slew rate.

The OPA703 and OPA704 series are fully specified and guaranteed over the supply range of ± 2 V to ± 6 V. Input swing extends 300mV beyond the rail and the output swings to within 40mV of the rail.

The single versions (OPA703 and OPA704) are available in the *Micro*SIZE SOT23-5 and in the standard SO-8 surface-mount, as well as the DIP-8 packages. Dual versions (OPA2703 and OPA2704) are available in the MSOP-8, SO-8, and DIP-8 packages. The quad OPA4703 and OPA4704 are available in the TSSOP-14 and SO-14 packages. All are specified for operation from -40° C to $+85^{\circ}$ C.

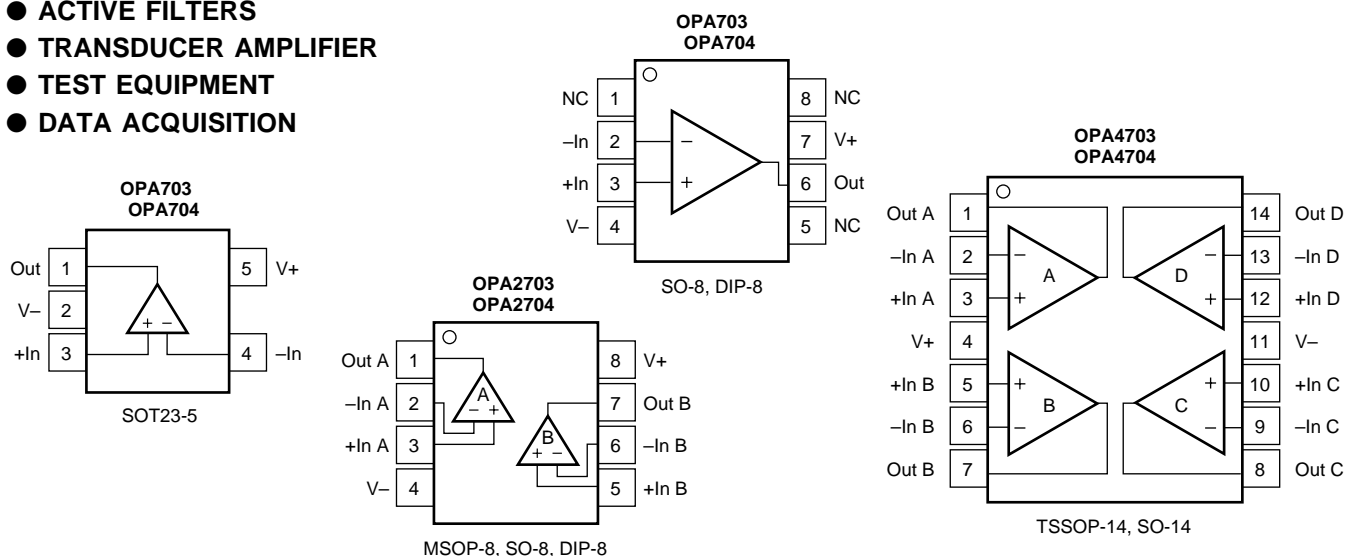

Please be aware that an important notice concerning availability, standard warranty, and use in critical applications of Texas Instruments semiconductor products and disclaimers thereto appears at the end of this data sheet.

ABSOLUTE MAXIMUM RATINGS⁽¹⁾

Supply Voltage, V+ to V-.....	13.2V
Signal Input Terminals, Voltage ⁽²⁾ (V-) -0.3V to (V+) +0.3V	
Current ⁽²⁾	10mA
Output Short-Circuit ⁽³⁾	Continuous
Operating Temperature.....	-55°C to +125°C
Storage Temperature.....	-65°C to +150°C
Junction Temperature.....	+150°C
Lead Temperature (soldering, 10s).....	+300°C

NOTES: (1) Stresses above these ratings may cause permanent damage. Exposure to absolute maximum conditions for extended periods may degrade device reliability. (2) Input terminals are diode-clamped to the power supply rails. Input signals that can swing more than 0.3V beyond the supply rails should be current-limited to 10mA or less. (3) Short-circuit to ground, one amplifier per package.



ELECTROSTATIC DISCHARGE SENSITIVITY

This integrated circuit can be damaged by ESD. Texas Instruments recommends that all integrated circuits be handled with appropriate precautions. Failure to observe proper handling and installation procedures can cause damage.

ESD damage can range from subtle performance degradation to complete device failure. Precision integrated circuits may be more susceptible to damage because very small parametric changes could cause the device not to meet its published specifications.

PACKAGE/ORDERING INFORMATION

PRODUCT	DESCRIPTION	MINIMUM RECOMMENDED GAIN	PACKAGE	PACKAGE DRAWING NUMBER	PACKAGE MARKING	ORDERING NUMBER ⁽¹⁾	TRANSPORT MEDIA
OPA703NA	Single, GBW = 1MHz	1	SOT23-5	331	A03	OPA703NA/250	Tape and Reel
"	"	"	"	"	"	OPA703NA/3K	Tape and Reel
OPA703UA	Single, GBW = 1MHz	1	SO-8	182	OPA703UA	OPA703UA	Rails
"	"	"	"	"	"	OPA703UA/2K5	Tape and Reel
OPA703PA	Single, GBW = 1MHz	1	DIP-8	006	OPA703PA	OPA703PA	Rails
OPA2703EA	Dual, GBW = 1MHz	1	MSOP-8	337	B03	OPA2703EA/250	Tape and Reel
"	"	"	"	"	"	OPA2703EA/2K5	Tape and Reel
OPA2703UA	Dual, GBW = 1MHz	1	SO-8	182	OPA2703UA	OPA2703UA	Rails
"	"	"	"	"	"	OPA2703UA/2K5	Tape and Reel
OPA2703PA	Dual, GBW = 1MHz	1	DIP-8	006	OPA2703PA	OPA2703PA	Rails
OPA4703EA	Quad, GBW = 1MHz	1	TSSOP-14	357	OPA4703EA	OPA4703EA/250	Tape and Reel
"	"	"	"	"	"	OPA4703EA/2K5	Tape and Reel
OPA4703UA	Quad, GBW = 1MHz	1	SO-14	235	OPA4703UA	OPA4703UA	Rails
"	"	"	"	"	"	OPA4703UA/2K5	Tape and Reel
OPA704NA	Single, GBW = 5MHz	5	SOT23-5	331	A04	OPA704NA/250	Tape and Reel
"	"	"	"	"	"	OPA704NA/3K	Tape and Reel
OPA704UA	Single, GBW = 5MHz	5	SO-8	182	OPA704UA	OPA704UA	Tape and Reel
"	"	"	"	"	"	OPA704UA/2K5	Tape and Reel
OPA704PA	Single, GBW = 5MHz	5	DIP-8	006	OPA704PA	OPA704PA	Rails
OPA2704EA	Dual, GBW = 5MHz	5	MSOP-8	337	B04	OPA2703EA/250	Tape and Reel
"	"	"	"	"	"	OPA2703EA/2K5	Tape and Reel
OPA2704UA	Dual, GBW = 5MHz	5	SO-8	182	OPA2704UA	OPA2704UA	Rails
"	"	"	"	"	"	OPA2704UA/2K5	Tape and Reel
OPA2704PA	Dual, GBW = 5MHz	5	DIP-8	006	OPA2704PA	OPA2704PA	Rails
OPA4704EA	Quad, GBW = 5MHz	5	TSSOP-14	357	OPA4704EA	OPA4704EA/250	Tape and Reel
"	"	"	"	"	"	OPA4704EA/2K5	Tape and Reel
OPA4704UA	Quad, GBW = 5MHz	5	SO-14	235	OPA4704UA	OPA4704UA	Rails
"	"	"	"	"	"	OPA4704UA/2K5	Tape and Reel

NOTE: (1) Models with a slash (/) are available only in Tape and Reel in the quantities indicated (e.g., /3K indicates 3000 devices per reel). Ordering 3000 pieces of "OPA703NA/3K" will get a single 3000-piece Tape and Reel.

OPA703 ELECTRICAL CHARACTERISTICS: $V_S = 4V$ to $12V$

Boldface limits apply over the specified temperature range, $T_A = -40^{\circ}C$ to $+85^{\circ}C$

At $T_A = +25^{\circ}C$, $R_L = 20k\Omega$ connected to $V_S/2$ and $V_{OUT} = V_S/2$, unless otherwise noted.

PARAMETER	CONDITION	OPA703NA, UA, PA OPA2703EA, UA, PA OPA4703EA, UA			UNITS
		MIN	TYP	MAX	
OFFSET VOLTAGE Input Offset Voltage Drift vs Power Supply Over Temperature Channel Separation, dc $f = 1kHz$	V_{OS} dV_{OS}/dT PSRR $V_S = \pm 5V, V_{CM} = 0V$ $T_A = -40^{\circ}C$ to $+85^{\circ}C$ $V_S = \pm 2V$ to $\pm 6V, V_{CM} = 0V$ $V_S = \pm 2V$ to $\pm 6V, V_{CM} = 0V$ $R_L = 20k\Omega$		± 160 ± 4 20 1 98	± 750 100 200	μV $\mu V/^{\circ}C$ $\mu V/V$ $\mu V/V$ $\mu V/V$ dB
INPUT VOLTAGE RANGE Common-Mode Voltage Range Common-Mode Rejection Ratio over Temperature over Temperature	V_{CM} CMRR $V_S = \pm 5V, (V-) - 0.3V < V_{CM} < (V+) + 0.3V$ $V_S = \pm 5V, (V-) < V_{CM} < (V+)$ $V_S = \pm 5V, (V-) - 0.3V < V_{CM} < (V+) - 2V$ $V_S = \pm 5V, (V-) < V_{CM} < (V+) - 2V$	$(V-) - 0.3$ 70 80 74	90 96	$(V+) + 0.3$ dB dB dB	V dB dB dB
INPUT BIAS CURRENT Input Bias Current Input Offset Current	I_B I_{OS} $V_S = \pm 5V, V_{CM} = 0V$ $V_S = \pm 5V, V_{CM} = 0V$		± 1 ± 0.5	± 10 ± 10	pA pA
INPUT IMPEDANCE Differential Common-Mode			$4 \cdot 10^9 \parallel 4$ $5 \cdot 10^{12} \parallel 4$		$\Omega \parallel pF$ $\Omega \parallel pF$
NOISE Input Voltage Noise, $f = 0.1Hz$ to $10Hz$ Input Voltage Noise Density, $f = 1kHz$ Current Noise Density, $f = 1kHz$	e_n i_n $V_S = \pm 5V, V_{CM} = 0V$ $V_S = \pm 5V, V_{CM} = 0V$ $V_S = \pm 5V, V_{CM} = 0V$		6 45 2.5		$\mu Vp-p$ nV/\sqrt{Hz} fA/\sqrt{Hz}
OPEN-LOOP GAIN Open-Loop Voltage Gain over Temperature over Temperature	A_{OL} $R_L = 100k\Omega, (V-)+0.1V < V_O < (V+)-0.1V$ $R_L = 20k\Omega, (V-)+0.075V < V_O < (V+)-0.075V$ $R_L = 20k\Omega, (V-)+0.075V < V_O < (V+)-0.075V$ $R_L = 5k\Omega, (V-)+0.15V < V_O < (V+)-0.15V$ $R_L = 5k\Omega, (V-)+0.15V < V_O < (V+)-0.15V$	100 96 100 96	120 110 110		dB dB dB dB
OUTPUT Voltage Output Swing from Rail over Temperature over Temperature Output Current Short-Circuit Current Capacitive Load Drive	I_{OUT} I_{SC} C_{LOAD} $R_L = 100k\Omega, A_{OL} > 80dB$ $R_L = 20k\Omega, A_{OL} > 100dB$ $R_L = 20k\Omega, A_{OL} > 96dB$ $R_L = 5k\Omega, A_{OL} > 100dB$ $R_L = 5k\Omega, A_{OL} > 96dB$ $ V_S - V_{OUT} < 1V$		40 ± 10 ± 40	75 75 150 150	mV mV mV mV mV mA mA
FREQUENCY RESPONSE Gain-Bandwidth Product Slew Rate Settling Time, 0.1% 0.01% Overload Recovery Time Total Harmonic Distortion + Noise	GBW SR t_s THD+N $C_L = 100pF$ $G = +1$ $V_S = \pm 5V, G = +1$ $V_S = \pm 5V, 5V$ Step, $G = +1$ $V_S = \pm 5V, 5V$ Step, $G = +1$ $V_{IN} \cdot \text{Gain} = V_S$ $V_S = \pm 5V, V_O = 3Vp-p, G = +1, f = 1kHz$		1 0.6 15 20 3 0.02		MHz V/ μs μs μs μs %
POWER SUPPLY Specified Voltage Range, Single Supply Specified Voltage Range, Dual Supplies Operating Voltage Range Quiescent Current (per amplifier) over Temperature	V_S V_S I_Q $I_Q = 0$	4 ± 2	3.6 to 12 160	12 ± 6	V V V μA μA
TEMPERATURE RANGE Specified Range Operating Range Storage Range Thermal Resistance SOT23-5 Surface-Mount MSOP-8 Surface-Mount TSSOP-14 Surface-Mount SO-8 Surface Mount SO-14 Surface Mount DIP-8	θ_{JA}	-40 -55 -65		85 125 150	$^{\circ}C$ $^{\circ}C$ $^{\circ}C$ $^{\circ}C/W$ $^{\circ}C/W$ $^{\circ}C/W$ $^{\circ}C/W$ $^{\circ}C/W$ $^{\circ}C/W$ $^{\circ}C/W$

OPA704 ELECTRICAL CHARACTERISTICS: $V_S = 4V$ to $12V$

Boldface limits apply over the specified temperature range, $T_A = -40^\circ\text{C}$ to $+85^\circ\text{C}$

At $T_A = +25^\circ\text{C}$, $R_L = 20\text{k}\Omega$ connected to $V_S/2$ and $V_{OUT} = V_S/2$, unless otherwise noted.

PARAMETER	CONDITION	OPA704NA, UA, PA OPA2704EA, UA, PA OPA4704EA, UA			UNITS
		MIN	TYP	MAX	
OFFSET VOLTAGE Input Offset Voltage Drift vs Power Supply Over Temperature Channel Separation, dc $f = 1\text{kHz}$	V_{OS} dV_{OS}/dT PSRR $V_S = \pm 5V, V_{CM} = 0V$ $T_A = -40^\circ\text{C}$ to $+85^\circ\text{C}$ $V_S = \pm 2V$ to $\pm 6V, V_{CM} = 0V$ $V_S = \pm 2V$ to $\pm 6V, V_{CM} = 0V$ $R_L = 20\text{k}\Omega$		± 160 ± 4 20 1 98	± 750 100 200	μV $\mu\text{V}/^\circ\text{C}$ $\mu\text{V}/\text{V}$ $\mu\text{V}/\text{V}$ $\mu\text{V}/\text{V}$ dB
INPUT VOLTAGE RANGE Common-Mode Voltage Range Common-Mode Rejection Ratio over Temperature over Temperature	V_{CM} CMRR $V_S = \pm 5V, (V-) - 0.3V < V_{CM} < (V+) + 0.3V$ $V_S = \pm 5V, (V-) < V_{CM} < (V+)$ $V_S = \pm 5V, (V-) - 0.3V < V_{CM} < (V+) - 2V$ $V_S = \pm 5V, (V-) < V_{CM} < (V+) - 2V$	$(V-) - 0.3$ 70 80 74	90 96	$(V+) + 0.3$	V dB dB dB dB
INPUT BIAS CURRENT Input Bias Current Input Offset Current	I_B I_{OS} $V_S = \pm 5V, V_{CM} = 0V$ $V_S = \pm 5V, V_{CM} = 0V$		± 1 ± 0.5	± 10 ± 10	pA pA
INPUT IMPEDANCE Differential Common-Mode			$4 \cdot 10^9 \parallel 4$ $5 \cdot 10^{12} \parallel 4$		$\Omega \parallel \text{pF}$ $\Omega \parallel \text{pF}$
NOISE Input Voltage Noise, $f = 0.1\text{Hz}$ to 10Hz Input Voltage Noise Density, $f = 1\text{kHz}$ Current Noise Density, $f = 1\text{kHz}$	e_n e_n i_n $V_S = \pm 5V, V_{CM} = 0V$ $V_S = \pm 5V, V_{CM} = 0V$ $V_S = \pm 5V, V_{CM} = 0V$		6 45 2.5		$\mu\text{Vp-p}$ $\text{nV}/\sqrt{\text{Hz}}$ $\text{fA}/\sqrt{\text{Hz}}$
OPEN-LOOP GAIN Open-Loop Voltage Gain over Temperature over Temperature	A_{OL} $R_L = 100\text{k}\Omega, (V-) + 0.1V < V_O < (V+) - 0.1V$ $R_L = 20\text{k}\Omega, (V-) + 0.075V < V_O < (V+) - 0.075V$ $R_L = 20\text{k}\Omega, (V-) + 0.075V < V_O < (V+) - 0.075V$ $R_L = 5\text{k}\Omega, (V-) + 0.15V < V_O < (V+) - 0.15V$ $R_L = 5\text{k}\Omega, (V-) + 0.15V < V_O < (V+) - 0.15V$	100 96 100 96	120 110 110		dB dB dB dB dB
OUTPUT Voltage Output Swing from Rail over Temperature over Temperature Output Current Short-Circuit Current Capacitive Load Drive	I_{OUT} I_{SC} C_{LOAD} $R_L = 100\text{k}\Omega, A_{OL} > 80\text{dB}$ $R_L = 20\text{k}\Omega, A_{OL} > 100\text{dB}$ $R_L = 20\text{k}\Omega, A_{OL} > 96\text{dB}$ $R_L = 5\text{k}\Omega, A_{OL} > 100\text{dB}$ $R_L = 5\text{k}\Omega, A_{OL} > 96\text{dB}$ $ V_S - V_{OUT} < 1V$		40 ± 10 ± 40	75 75 150 150	mV mV mV mV mA mA
FREQUENCY RESPONSE Gain-Bandwidth Product Slew Rate Settling Time, 0.1% 0.01% Overload Recovery Time Total Harmonic Distortion + Noise	GBW SR t_S THD+N $C_L = 100\text{pF}$ $G = +5$ $V_S = \pm 5V, G = +5$ $V_S = \pm 5V, 5V$ Step, $G = +5$ $V_S = \pm 5V, 5V$ Step, $G = +5$ $V_{IN} \cdot \text{Gain} = V_S$ $V_S = \pm 5V, V_O = 3V_{p-p}, G = +5, f = 1\text{kHz}$		3 3 18 21 0.6 0.025		MHz V/ μs μs μs μs %
POWER SUPPLY Specified Voltage Range, Single Supply Specified Voltage Range, Dual Supplies Operating Voltage Range Quiescent Current (per amplifier) over Temperature	V_S V_S I_Q $I_Q = 0$	4 ± 2	3.6 to 12 160	12 ± 6	V V V μA μA
TEMPERATURE RANGE Specified Range Operating Range Storage Range Thermal Resistance SOT23-5 Surface-Mount MSOP-8 Surface-Mount TSSOP-14 Surface-Mount SO-8 Surface Mount SO-14 Surface Mount DIP-8	θ_{JA}	-40 -55 -65		85 125 150	$^\circ\text{C}$ $^\circ\text{C}$ $^\circ\text{C}$ $^\circ\text{C}/\text{W}$ $^\circ\text{C}/\text{W}$ $^\circ\text{C}/\text{W}$ $^\circ\text{C}/\text{W}$ $^\circ\text{C}/\text{W}$ $^\circ\text{C}/\text{W}$ $^\circ\text{C}/\text{W}$

TYPICAL CHARACTERISTICS

At $T_A = +25^\circ\text{C}$, $V_S = \pm 5\text{V}$, and $R_L = 20\text{k}\Omega$, unless otherwise noted.

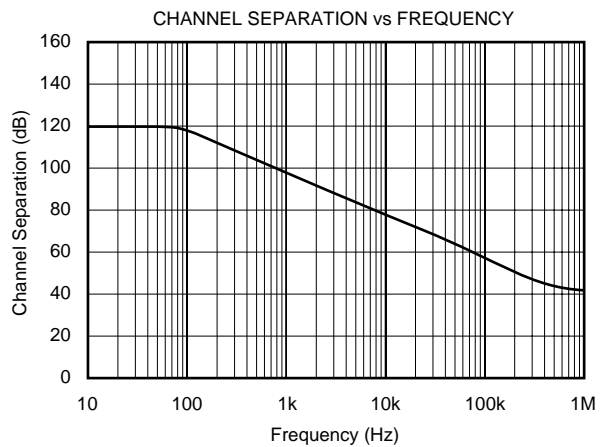
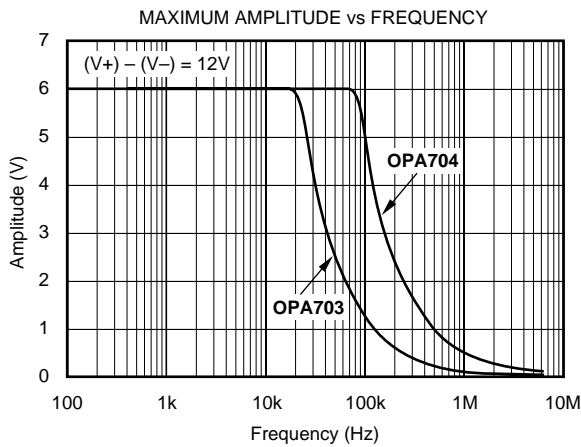
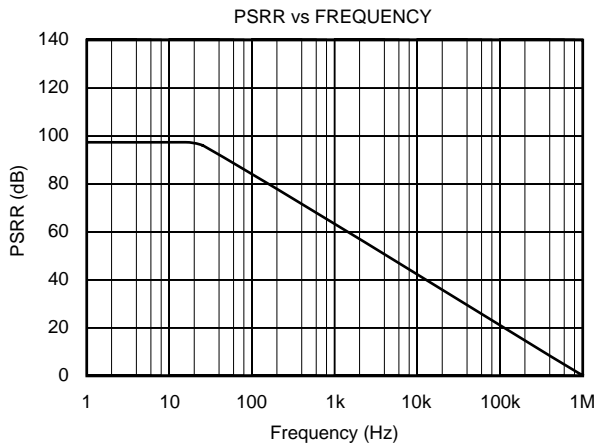
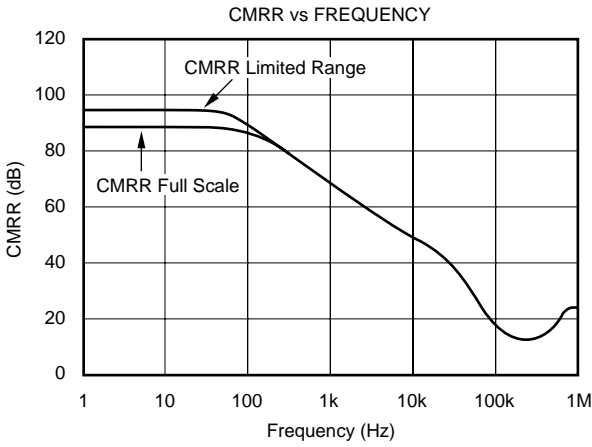
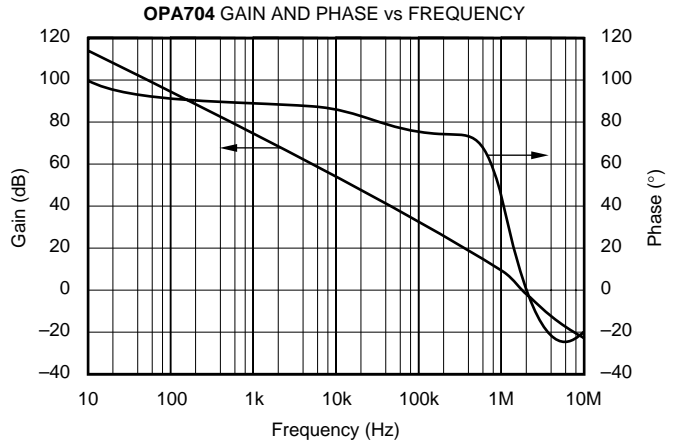
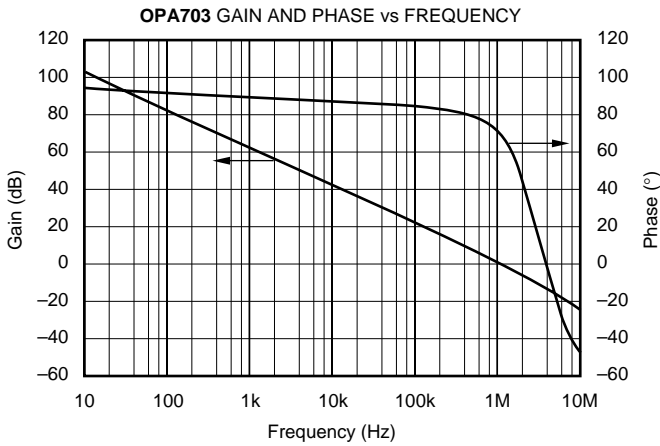

TYPICAL CHARACTERISTICS (Cont.)

At $T_A = +25^\circ\text{C}$, $V_S = \pm 5\text{V}$, and $R_L = 20\text{k}\Omega$, unless otherwise noted.

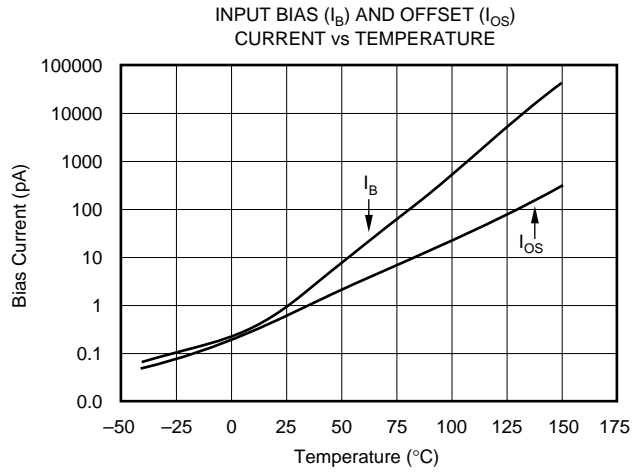
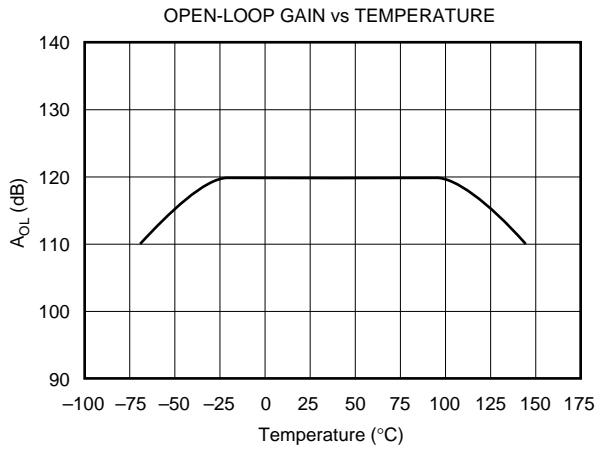
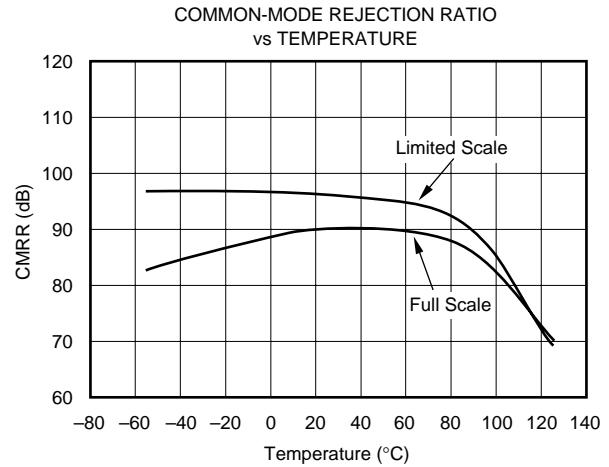
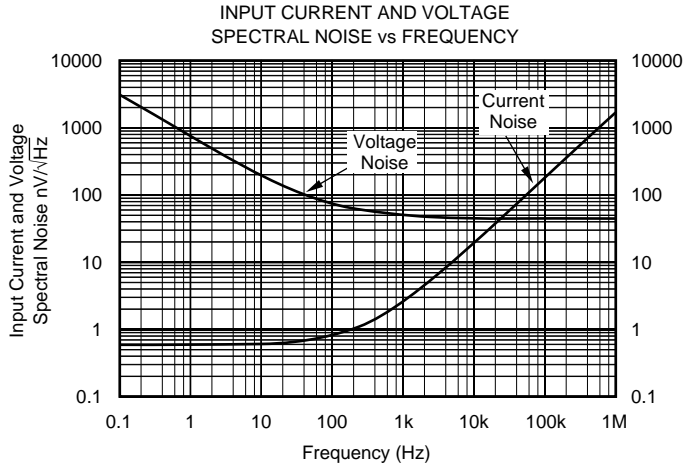

TYPICAL CHARACTERISTICS (Cont.)

At $T_A = +25^\circ\text{C}$, $V_S = \pm 5\text{V}$, and $R_L = 20\text{k}\Omega$, unless otherwise noted.

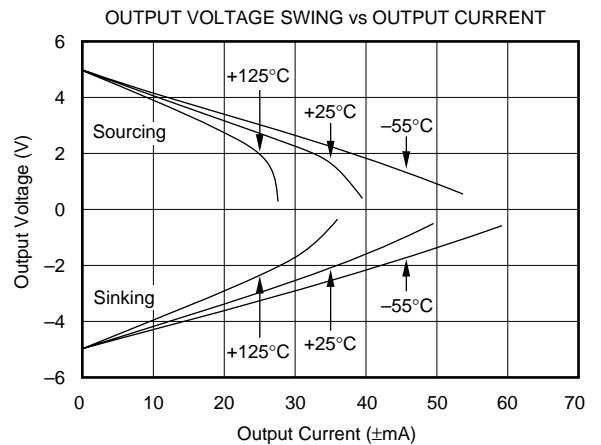
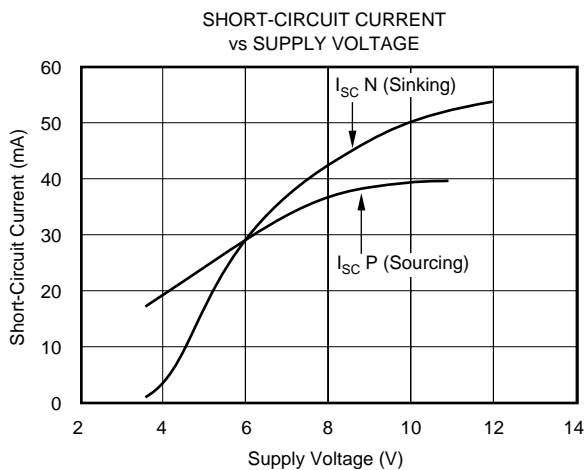
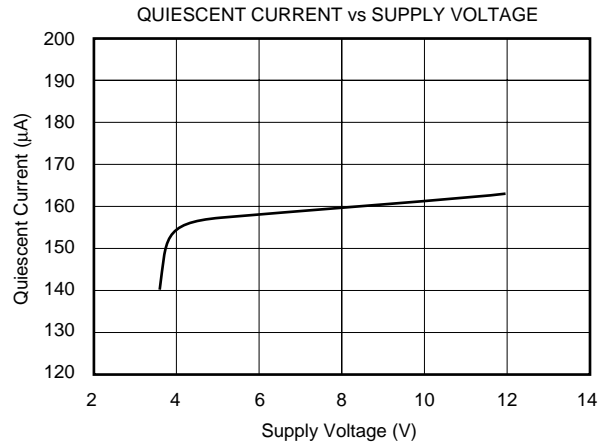
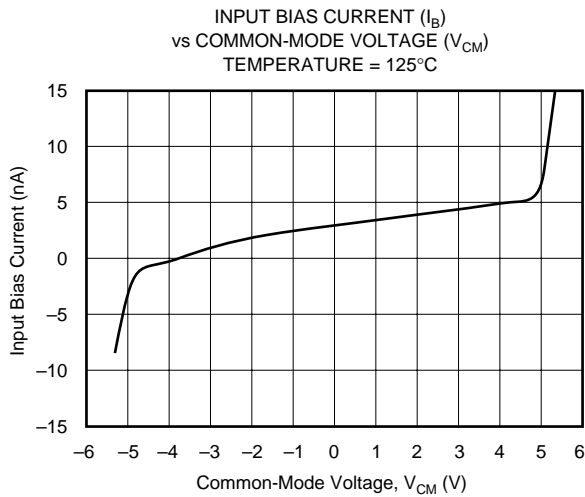
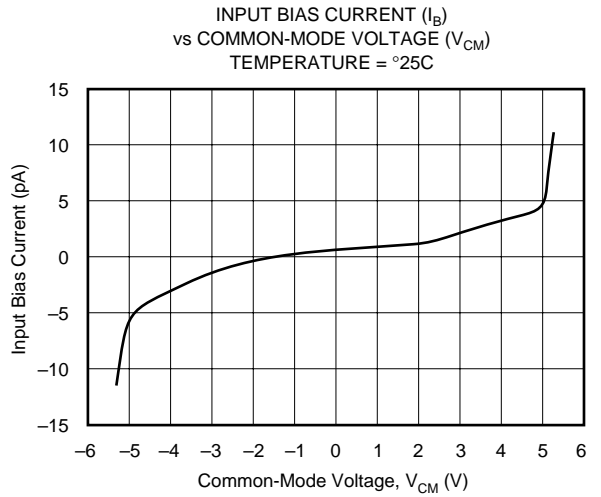

TYPICAL CHARACTERISTICS (Cont.)

At $T_A = +25^\circ\text{C}$, $V_S = \pm 5\text{V}$, and $R_L = 20\text{k}\Omega$, unless otherwise noted.



TYPICAL CHARACTERISTICS (Cont.)

At $T_A = +25^\circ\text{C}$, $V_S = \pm 5\text{V}$, and $R_L = 20\text{k}\Omega$, unless otherwise noted.

OPA703 SMALL SIGNAL STEP RESPONSE
($G = +1\text{V/V}$, $R_L = 20\text{k}\Omega$, $C_L = 100\text{pF}$)

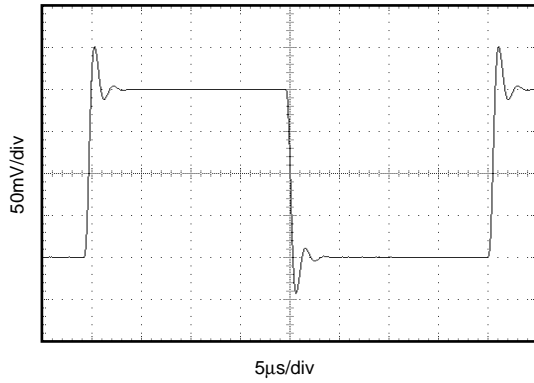

OPA704 SMALL SIGNAL STEP RESPONSE
($G = +5\text{V/V}$, $C_F = 3\text{pF}$, $R_F = 100\text{k}\Omega$,
 $C_L = 100\text{pF}$, $R_L = 20\text{k}\Omega$)

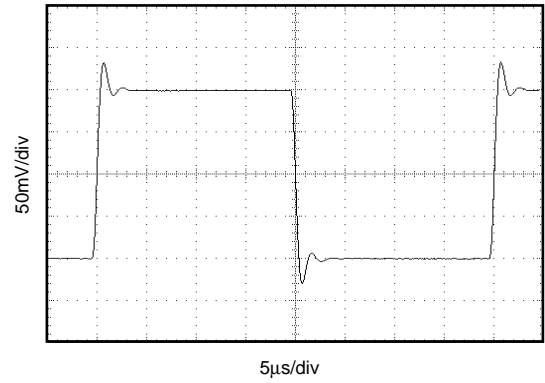

OPA703 LARGE SIGNAL STEP RESPONSE
($G = +1\text{V/V}$, $R_L = 20\text{k}\Omega$, $C_L = 100\text{pF}$)

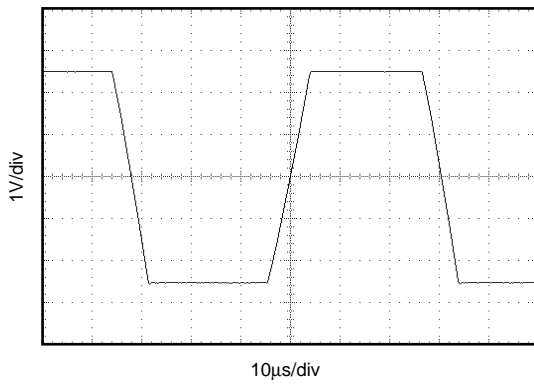

OPA704 LARGE SIGNAL STEP RESPONSE
($G = +5\text{V/V}$, $R_L = 20\text{k}\Omega$, $C_F = 3\text{pF}$, $C_L = 100\text{pF}$)

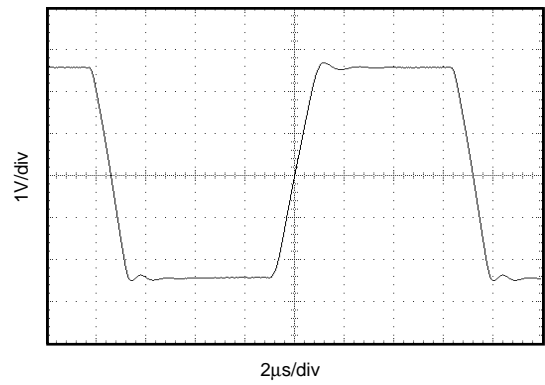

APPLICATIONS INFORMATION

OPA703 and OPA704 series op amps can operate on 160 μ A quiescent current from a single (or split) supply in the range of 4V to 12V (± 2 V to ± 6 V), making them highly versatile and easy to use. The OPA703 is unity-gain stable and offers 1MHz bandwidth and 0.6V/ μ s slew rate. The OPA704 is optimized for gains of 5 or greater with a 3MHz bandwidth and 3V/ μ s slew rate.

Rail-to-rail input and output swing helps maintain dynamic range, especially in low supply applications. Figure 1 shows the input and output waveforms for the OPA703 in unity-gain configuration. Operation is from a ± 5 V supply with a 100k Ω load connected to $V_S/2$. The input is a 10Vp-p sinusoid. Output voltage is approximately 10Vp-p.

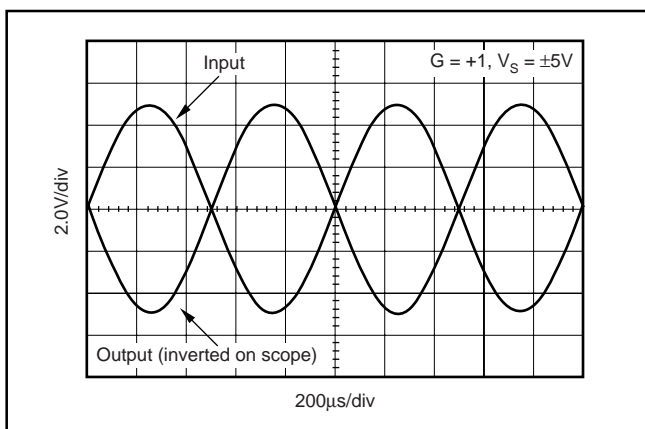

FIGURE 1. Rail-to-Rail Input and Output.

Power-supply pins should be bypassed with 1000pF ceramic capacitors in parallel with 1 μ F tantalum capacitors.

OPERATING VOLTAGE

OPA703 and OPA704 series op amps are fully specified and guaranteed from +4V to +12V over a temperature range of -40°C to $+85^{\circ}\text{C}$. Parameters that vary significantly with operating voltages or temperature are shown in the Typical Performance Curves.

RAIL-TO-RAIL INPUT

The input common-mode voltage range of the OPA703 series extends 300mV beyond the supply rails at room temperature. This is achieved with a complementary input stage—an N-channel input differential pair in parallel with a P-channel differential pair, as shown in Figure 2. The N-channel pair is active for input voltages close to the positive rail, typically $(V_+) - 2.0$ V to 300mV above the positive supply, while the P-channel pair is on for inputs from 300mV below the negative supply to approximately $(V_+) - 1.5$ V. There is a small transition region, typically $(V_+) - 2.0$ V to $(V_+) - 1.5$ V, in which both pairs are on. This 500mV transition region can vary ± 100 mV with process variation. Thus, the transition region (both stages on) can range from $(V_+) - 2.1$ V to $(V_+) - 1.4$ V on the low end, up to $(V_+) - 1.9$ V to $(V_+) - 1.6$ V on the high end. Within the 500mV transition region PSRR, CMRR, offset voltage, and offset drift, and THD may vary compared to operation outside this region.

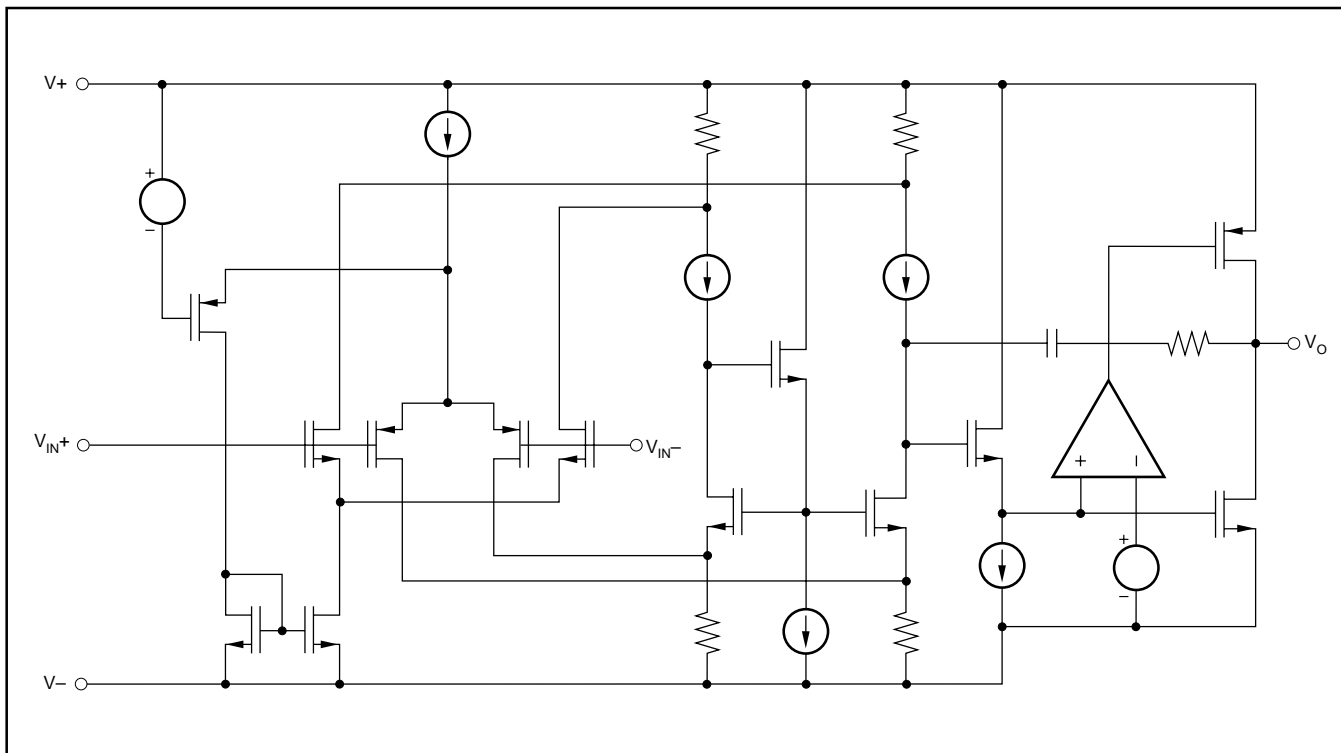

FIGURE 2. Simplified Schematic.

INPUT VOLTAGE

Device inputs are protected by ESD diodes that will conduct if the input voltages exceed the power supplies by more than approximately 300mV. Momentary voltages greater than 300mV beyond the power supply can be tolerated if the current is limited to 10mA. This is easily accomplished with an input resistor, as shown in Figure 3. Many input signals are inherently current-limited to less than 10mA; therefore, a limiting resistor is not always required. The OPA703 features no phase inversion when the inputs extend beyond supplies if the input current is limited, as seen in Figure 4.



FIGURE 3. Input Current Protection for Voltages Exceeding the Supply Voltage.



FIGURE 4. OPA703—No Phase Inversion with Inputs Greater than the Power-Supply Voltage.

RAIL-TO-RAIL OUTPUT

A class AB output stage with common-source transistors is used to achieve rail-to-rail output. This output stage is capable of driving 1kΩ loads connected to any point between V+ and ground. For light resistive loads (> 100kΩ), the output voltage can swing to 40mV from the supply rail. With moderate resistive loads (20kΩ), the output can swing to within 75mV from the supply rails while maintaining high open-loop gain (see the typical performance curve “Output Voltage Swing vs Output Current”).

CAPACITIVE LOAD AND STABILITY

The OPA703 and OPA704 series op amps can drive up to 1000pF pure capacitive load. Increasing the gain enhances the amplifier’s ability to drive greater capacitive loads (see the typical performance curve “Small Signal Overshoot vs Capacitive Load”).

One method of improving capacitive load drive in the unity-gain configuration is to insert a 10Ω to 20Ω resistor inside the feedback loop, as shown in Figure 5. This reduces ringing with large capacitive loads while maintaining DC accuracy.

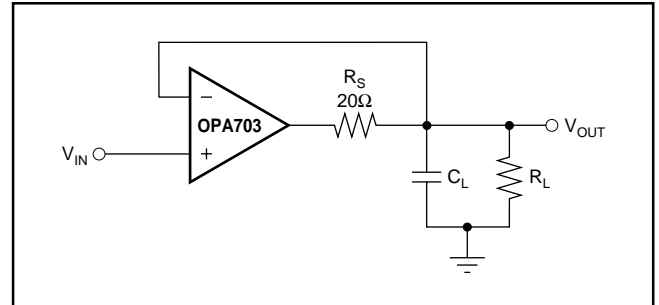

FIGURE 5. Series Resistor in Unity-Gain Buffer Configuration Improves Capacitive Load Drive.

APPLICATION CIRCUITS

Figure 6 shows a G = 5 non-inverting amplifier implemented with the OPA703 and OPA704 op amps. It demonstrates the increased speed characteristics (bandwidth, slew rate and settling time) that can be achieved with the OPA704 family when used in gains of five or greater. Some optimization of feedback capacitor value may be required to achieve best dynamic response. Circuits with closed-loop gains of less than five should use the OPA703 family for good stability and capacitive load drive. The OPA703 can be used in gains greater than five, but will not provide the increased speed benefits of the OPA704 family.

The OPA703 series op amps are optimized for driving medium-speed sampling data converters. The OPA703 op amps buffer the converter’s input capacitance and resulting charge injection while providing signal gain.

Figure 7 shows the OPA2703 in a dual-supply buffered reference configuration for the DAC7644. The DAC7644 is a 16-bit, low-power, quad-voltage output converter. Small size makes the combination ideal for automatic test equipment, data acquisition systems, and other low-power space-limited applications.

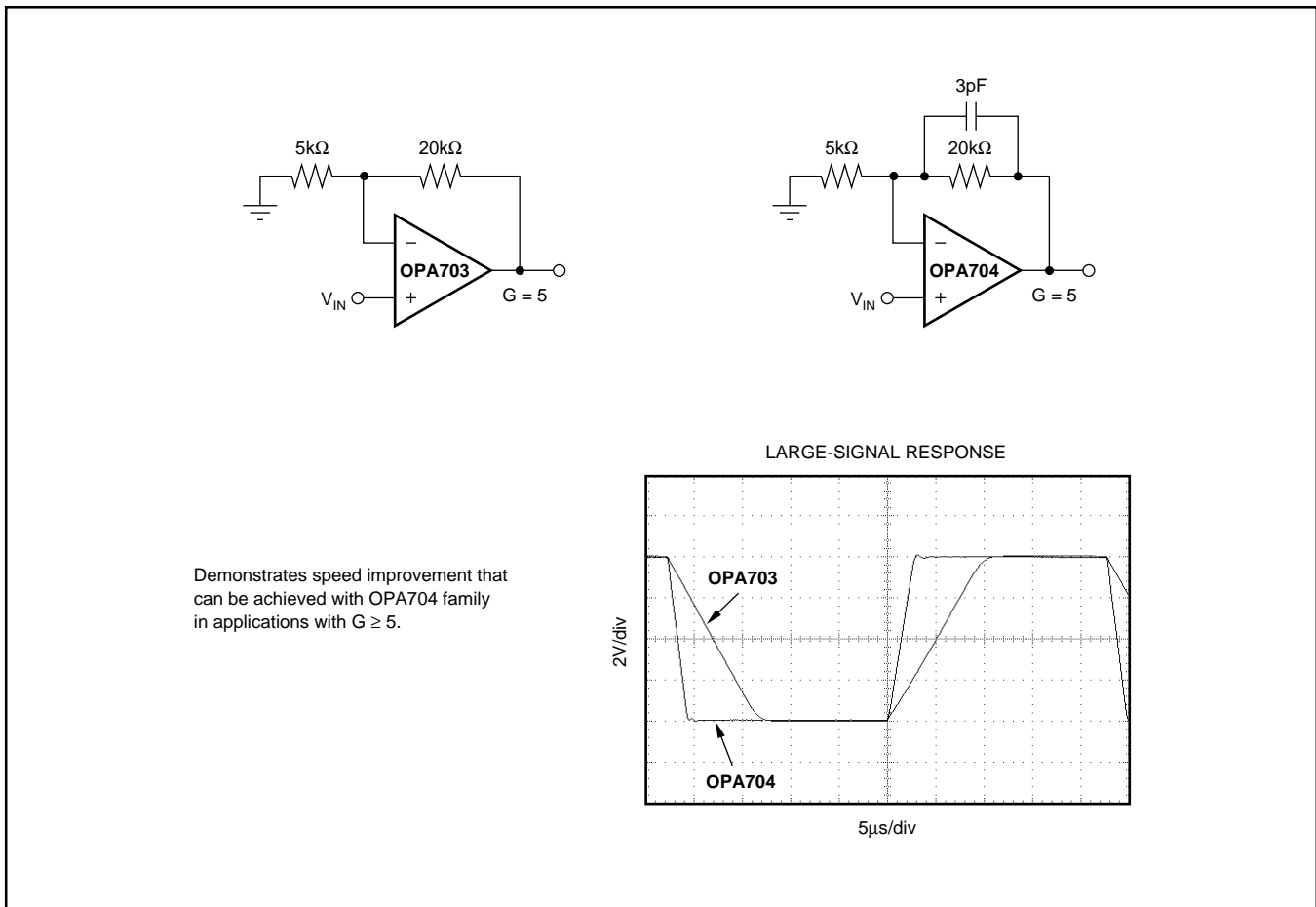

FIGURE 6. OPA704 Provides higher Speed in $G \geq 5$.

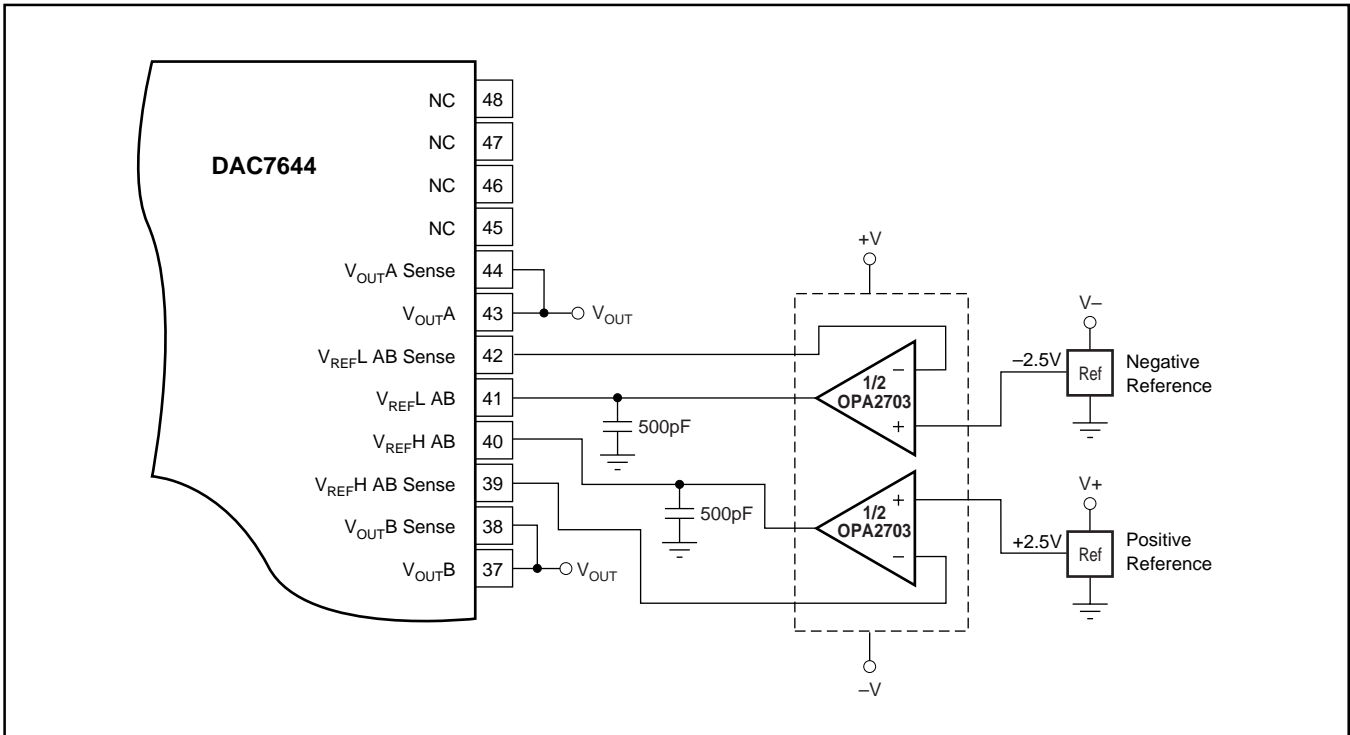

FIGURE 7. OPA703 as Dual Supply Configuration-Buffered References for the DAC7644.

PACKAGING INFORMATION

Orderable part number	Status (1)	Material type (2)	Package Pins	Package qty Carrier	RoHS (3)	Lead finish/ Ball material (4)	MSL rating/ Peak reflow (5)	Op temp (°C)	Part marking (6)
OPA2703EA/250	Active	Production	VSSOP (DGK) 8	250 SMALL T&R	Yes	Call TI Nipdauag Nipdau	Level-2-260C-1 YEAR	-40 to 85	B03
OPA2703EA/250.B	Active	Production	VSSOP (DGK) 8	250 SMALL T&R	Yes	Call TI	Level-2-260C-1 YEAR	-40 to 85	B03
OPA2703EA/2K5	Active	Production	VSSOP (DGK) 8	2500 LARGE T&R	Yes	Call TI Nipdauag Nipdau	Level-2-260C-1 YEAR	-40 to 85	B03
OPA2703EA/2K5.B	Active	Production	VSSOP (DGK) 8	2500 LARGE T&R	Yes	Call TI	Level-2-260C-1 YEAR	-40 to 85	B03
OPA2703UA	Last Time Buy	Production	SOIC (D) 8	75 TUBE	Yes	NIPDAU	Level-2-260C-1 YEAR	-40 to 85	OPA 2703UA
OPA2703UA.B	Last Time Buy	Production	SOIC (D) 8	75 TUBE	Yes	NIPDAU	Level-2-260C-1 YEAR	-40 to 85	OPA 2703UA
OPA2703UA/2K5	Active	Production	SOIC (D) 8	2500 LARGE T&R	Yes	NIPDAU	Level-2-260C-1 YEAR	-40 to 85	OPA 2703UA
OPA2703UA/2K5.B	Active	Production	SOIC (D) 8	2500 LARGE T&R	Yes	NIPDAU	Level-2-260C-1 YEAR	-40 to 85	OPA 2703UA
OPA2703UA/2K5G4	Active	Production	SOIC (D) 8	2500 LARGE T&R	Yes	NIPDAU	Level-2-260C-1 YEAR	-40 to 85	OPA 2703UA
OPA2703UAG4	Active	Production	SOIC (D) 8	75 TUBE	Yes	NIPDAU	Level-2-260C-1 YEAR	-40 to 85	OPA 2703UA
OPA2703UAG4.B	Active	Production	SOIC (D) 8	75 TUBE	Yes	NIPDAU	Level-2-260C-1 YEAR	-40 to 85	OPA 2703UA
OPA2704EA/250	Active	Production	VSSOP (DGK) 8	250 SMALL T&R	Yes	Call TI Nipdauag Nipdau	Level-2-260C-1 YEAR	-40 to 85	B04
OPA2704EA/250.B	Active	Production	VSSOP (DGK) 8	250 SMALL T&R	Yes	Call TI	Level-2-260C-1 YEAR	-40 to 85	B04
OPA2704UA	Last Time Buy	Production	SOIC (D) 8	75 TUBE	Yes	NIPDAU	Level-2-260C-1 YEAR	-40 to 85	OPA 2704UA
OPA2704UA.B	Last Time Buy	Production	SOIC (D) 8	75 TUBE	Yes	NIPDAU	Level-2-260C-1 YEAR	-40 to 85	OPA 2704UA
OPA2704UA/2K5	Active	Production	SOIC (D) 8	2500 LARGE T&R	Yes	NIPDAU	Level-2-260C-1 YEAR	-40 to 85	OPA 2704UA
OPA2704UA/2K5.B	Active	Production	SOIC (D) 8	2500 LARGE T&R	Yes	NIPDAU	Level-2-260C-1 YEAR	-40 to 85	OPA 2704UA
OPA4703EA/250	Active	Production	TSSOP (PW) 14	250 SMALL T&R	Yes	NIPDAU	Level-2-260C-1 YEAR	-40 to 85	OPA 4703EA

Orderable part number	Status (1)	Material type (2)	Package Pins	Package qty Carrier	RoHS (3)	Lead finish/ Ball material (4)	MSL rating/ Peak reflow (5)	Op temp (°C)	Part marking (6)
OPA4703EA/250.B	Active	Production	TSSOP (PW) 14	250 SMALL T&R	Yes	NIPDAU	Level-2-260C-1 YEAR	-40 to 85	OPA 4703EA
OPA4703EA/250G4	Active	Production	TSSOP (PW) 14	250 SMALL T&R	Yes	NIPDAU	Level-2-260C-1 YEAR	-40 to 85	OPA 4703EA
OPA4703EA/250G4.B	Active	Production	TSSOP (PW) 14	250 SMALL T&R	Yes	NIPDAU	Level-2-260C-1 YEAR	-40 to 85	OPA 4703EA
OPA4703EA/2K5	Active	Production	TSSOP (PW) 14	2500 LARGE T&R	Yes	NIPDAU	Level-2-260C-1 YEAR	-40 to 85	OPA 4703EA
OPA4703EA/2K5.B	Active	Production	TSSOP (PW) 14	2500 LARGE T&R	Yes	NIPDAU	Level-2-260C-1 YEAR	-40 to 85	OPA 4703EA
OPA4703EA/2K5G4	Active	Production	TSSOP (PW) 14	2500 LARGE T&R	Yes	NIPDAU	Level-2-260C-1 YEAR	-40 to 85	OPA 4703EA
OPA4703UA	Active	Production	SOIC (D) 14	50 TUBE	Yes	NIPDAU	Level-2-260C-1 YEAR	-40 to 85	OPA4703UA
OPA4703UA.B	Active	Production	SOIC (D) 14	50 TUBE	Yes	NIPDAU	Level-2-260C-1 YEAR	-40 to 85	OPA4703UA
OPA4704EA/250	Active	Production	TSSOP (PW) 14	250 SMALL T&R	Yes	NIPDAU	Level-2-260C-1 YEAR	-40 to 85	OPA 4704EA
OPA4704EA/250.B	Active	Production	TSSOP (PW) 14	250 SMALL T&R	Yes	NIPDAU	Level-2-260C-1 YEAR	-40 to 85	OPA 4704EA
OPA4704EA/250G4	Active	Production	TSSOP (PW) 14	250 SMALL T&R	Yes	NIPDAU	Level-2-260C-1 YEAR	-40 to 85	OPA 4704EA
OPA4704EA/250G4.B	Active	Production	TSSOP (PW) 14	250 SMALL T&R	Yes	NIPDAU	Level-2-260C-1 YEAR	-40 to 85	OPA 4704EA
OPA4704EA/2K5	Active	Production	TSSOP (PW) 14	2500 LARGE T&R	Yes	NIPDAU	Level-2-260C-1 YEAR	-40 to 85	OPA 4704EA
OPA4704EA/2K5.B	Active	Production	TSSOP (PW) 14	2500 LARGE T&R	Yes	NIPDAU	Level-2-260C-1 YEAR	-40 to 85	OPA 4704EA
OPA4704UA	Active	Production	SOIC (D) 14	50 TUBE	Yes	NIPDAU	Level-2-260C-1 YEAR	-40 to 85	OPA4704UA
OPA4704UA.B	Active	Production	SOIC (D) 14	50 TUBE	Yes	NIPDAU	Level-2-260C-1 YEAR	-40 to 85	OPA4704UA
OPA703NA/250	Active	Production	SOT-23 (DBV) 5	250 SMALL T&R	Yes	NIPDAU	Level-2-260C-1 YEAR	-40 to 85	A03
OPA703NA/250.B	Active	Production	SOT-23 (DBV) 5	250 SMALL T&R	Yes	NIPDAU	Level-2-260C-1 YEAR	-40 to 85	A03
OPA703NA/250G4	Active	Production	SOT-23 (DBV) 5	250 SMALL T&R	Yes	NIPDAU	Level-2-260C-1 YEAR	-40 to 85	A03
OPA703NA/3K	Active	Production	SOT-23 (DBV) 5	3000 LARGE T&R	Yes	NIPDAU	Level-2-260C-1 YEAR	-40 to 85	A03
OPA703NA/3K.B	Active	Production	SOT-23 (DBV) 5	3000 LARGE T&R	Yes	NIPDAU	Level-2-260C-1 YEAR	-40 to 85	A03
OPA703NA/3KG4	Active	Production	SOT-23 (DBV) 5	3000 LARGE T&R	Yes	NIPDAU	Level-2-260C-1 YEAR	-40 to 85	A03

Orderable part number	Status (1)	Material type (2)	Package Pins	Package qty Carrier	RoHS (3)	Lead finish/ Ball material (4)	MSL rating/ Peak reflow (5)	Op temp (°C)	Part marking (6)
OPA703PA	Active	Production	PDIP (P) 8	50 TUBE	Yes	NIPDAU	N/A for Pkg Type	-40 to 85	OPA703PA
OPA703PA.B	Active	Production	PDIP (P) 8	50 TUBE	Yes	NIPDAU	N/A for Pkg Type	-40 to 85	OPA703PA
OPA703UA	Last Time Buy	Production	SOIC (D) 8	75 TUBE	Yes	NIPDAU	Level-2-260C-1 YEAR	-40 to 85	OPA 703UA
OPA703UA.B	Last Time Buy	Production	SOIC (D) 8	75 TUBE	Yes	NIPDAU	Level-2-260C-1 YEAR	-40 to 85	OPA 703UA
OPA703UA/2K5	Active	Production	SOIC (D) 8	2500 LARGE T&R	Yes	NIPDAU	Level-2-260C-1 YEAR	-40 to 85	OPA 703UA
OPA703UA/2K5.B	Active	Production	SOIC (D) 8	2500 LARGE T&R	Yes	NIPDAU	Level-2-260C-1 YEAR	-40 to 85	OPA 703UA
OPA704NA/250	Active	Production	SOT-23 (DBV) 5	250 SMALL T&R	Yes	NIPDAU	Level-2-260C-1 YEAR	-40 to 85	A04
OPA704NA/250.B	Active	Production	SOT-23 (DBV) 5	250 SMALL T&R	Yes	NIPDAU	Level-2-260C-1 YEAR	-40 to 85	A04
OPA704NA/250G4	Active	Production	SOT-23 (DBV) 5	250 SMALL T&R	Yes	NIPDAU	Level-2-260C-1 YEAR	-40 to 85	A04
OPA704NA/3K	Active	Production	SOT-23 (DBV) 5	3000 LARGE T&R	Yes	NIPDAU	Level-2-260C-1 YEAR	-40 to 85	A04
OPA704NA/3K.B	Active	Production	SOT-23 (DBV) 5	3000 LARGE T&R	Yes	NIPDAU	Level-2-260C-1 YEAR	-40 to 85	A04
OPA704NA/3KG4	Active	Production	SOT-23 (DBV) 5	3000 LARGE T&R	Yes	NIPDAU	Level-2-260C-1 YEAR	-40 to 85	A04
OPA704UA	Last Time Buy	Production	SOIC (D) 8	75 TUBE	Yes	NIPDAU	Level-2-260C-1 YEAR	-40 to 85	OPA 704UA
OPA704UA.B	Last Time Buy	Production	SOIC (D) 8	75 TUBE	Yes	NIPDAU	Level-2-260C-1 YEAR	-40 to 85	OPA 704UA
OPA704UA/2K5	Active	Production	SOIC (D) 8	2500 LARGE T&R	Yes	NIPDAU	Level-2-260C-1 YEAR	-40 to 85	OPA 704UA
OPA704UA/2K5.B	Active	Production	SOIC (D) 8	2500 LARGE T&R	Yes	NIPDAU	Level-2-260C-1 YEAR	-40 to 85	OPA 704UA

(1) **Status:** For more details on status, see our [product life cycle](#).

(2) **Material type:** When designated, preproduction parts are prototypes/experimental devices, and are not yet approved or released for full production. Testing and final process, including without limitation quality assurance, reliability performance testing, and/or process qualification, may not yet be complete, and this item is subject to further changes or possible discontinuation. If available for ordering, purchases will be subject to an additional waiver at checkout, and are intended for early internal evaluation purposes only. These items are sold without warranties of any kind.

(3) **RoHS values:** Yes, No, RoHS Exempt. See the [TI RoHS Statement](#) for additional information and value definition.

(4) **Lead finish/Ball material:** Parts may have multiple material finish options. Finish options are separated by a vertical ruled line. Lead finish/Ball material values may wrap to two lines if the finish value exceeds the maximum column width.

(5) **MSL rating/Peak reflow:** The moisture sensitivity level ratings and peak solder (reflow) temperatures. In the event that a part has multiple moisture sensitivity ratings, only the lowest level per JEDEC standards is shown. Refer to the shipping label for the actual reflow temperature that will be used to mount the part to the printed circuit board.

(6) **Part marking:** There may be an additional marking, which relates to the logo, the lot trace code information, or the environmental category of the part.

Multiple part markings will be inside parentheses. Only one part marking contained in parentheses and separated by a "~" will appear on a part. If a line is indented then it is a continuation of the previous line and the two combined represent the entire part marking for that device.

Important Information and Disclaimer: The information provided on this page represents TI's knowledge and belief as of the date that it is provided. TI bases its knowledge and belief on information provided by third parties, and makes no representation or warranty as to the accuracy of such information. Efforts are underway to better integrate information from third parties. TI has taken and continues to take reasonable steps to provide representative and accurate information but may not have conducted destructive testing or chemical analysis on incoming materials and chemicals. TI and TI suppliers consider certain information to be proprietary, and thus CAS numbers and other limited information may not be available for release.

In no event shall TI's liability arising out of such information exceed the total purchase price of the TI part(s) at issue in this document sold by TI to Customer on an annual basis.

TAPE AND REEL INFORMATION

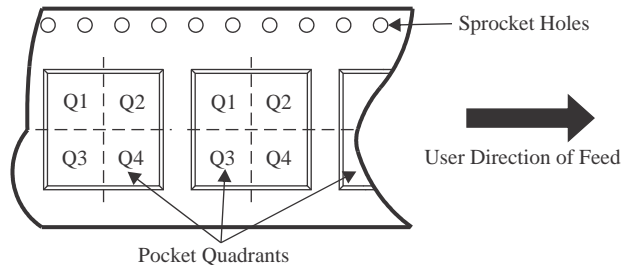
QUADRANT ASSIGNMENTS FOR PIN 1 ORIENTATION IN TAPE

*All dimensions are nominal

Device	Package Type	Package Drawing	Pins	SPQ	Reel Diameter (mm)	Reel Width W1 (mm)	A0 (mm)	B0 (mm)	K0 (mm)	P1 (mm)	W (mm)	Pin1 Quadrant
OPA2703EA/250	VSSOP	DGK	8	250	180.0	12.4	5.3	3.4	1.4	8.0	12.0	Q1
OPA2703EA/2K5	VSSOP	DGK	8	2500	330.0	12.4	5.3	3.4	1.4	8.0	12.0	Q1
OPA2703UA/2K5	SOIC	D	8	2500	330.0	12.4	6.4	5.2	2.1	8.0	12.0	Q1
OPA2704EA/250	VSSOP	DGK	8	250	180.0	12.4	5.3	3.4	1.4	8.0	12.0	Q1
OPA2704UA/2K5	SOIC	D	8	2500	330.0	12.4	6.4	5.2	2.1	8.0	12.0	Q1
OPA4703EA/250	TSSOP	PW	14	250	180.0	12.4	6.9	5.6	1.6	8.0	12.0	Q1
OPA4703EA/250G4	TSSOP	PW	14	250	180.0	12.4	6.9	5.6	1.6	8.0	12.0	Q1
OPA4703EA/2K5	TSSOP	PW	14	2500	330.0	12.4	6.9	5.6	1.6	8.0	12.0	Q1
OPA4704EA/250	TSSOP	PW	14	250	180.0	12.4	6.9	5.6	1.6	8.0	12.0	Q1
OPA4704EA/250G4	TSSOP	PW	14	250	180.0	12.4	6.9	5.6	1.6	8.0	12.0	Q1
OPA4704EA/2K5	TSSOP	PW	14	2500	330.0	12.4	6.9	5.6	1.6	8.0	12.0	Q1
OPA703NA/250	SOT-23	DBV	5	250	178.0	8.4	3.3	3.2	1.4	4.0	8.0	Q3
OPA703NA/3K	SOT-23	DBV	5	3000	178.0	8.4	3.3	3.2	1.4	4.0	8.0	Q3
OPA703UA/2K5	SOIC	D	8	2500	330.0	12.4	6.4	5.2	2.1	8.0	12.0	Q1
OPA704NA/250	SOT-23	DBV	5	250	178.0	8.4	3.3	3.2	1.4	4.0	8.0	Q3
OPA704NA/3K	SOT-23	DBV	5	3000	178.0	8.4	3.23	3.17	1.37	4.0	8.0	Q3

Device	Package Type	Package Drawing	Pins	SPQ	Reel Diameter (mm)	Reel Width W1 (mm)	A0 (mm)	B0 (mm)	K0 (mm)	P1 (mm)	W (mm)	Pin1 Quadrant
OPA704UA/2K5	SOIC	D	8	2500	330.0	12.4	6.4	5.2	2.1	8.0	12.0	Q1

TAPE AND REEL BOX DIMENSIONS

*All dimensions are nominal

Device	Package Type	Package Drawing	Pins	SPQ	Length (mm)	Width (mm)	Height (mm)
OPA2703EA/250	VSSOP	DGK	8	250	213.0	191.0	35.0
OPA2703EA/2K5	VSSOP	DGK	8	2500	353.0	353.0	32.0
OPA2703UA/2K5	SOIC	D	8	2500	353.0	353.0	32.0
OPA2704EA/250	VSSOP	DGK	8	250	213.0	191.0	35.0
OPA2704UA/2K5	SOIC	D	8	2500	353.0	353.0	32.0
OPA4703EA/250	TSSOP	PW	14	250	213.0	191.0	35.0
OPA4703EA/250G4	TSSOP	PW	14	250	213.0	191.0	35.0
OPA4703EA/2K5	TSSOP	PW	14	2500	353.0	353.0	32.0
OPA4704EA/250	TSSOP	PW	14	250	213.0	191.0	35.0
OPA4704EA/250G4	TSSOP	PW	14	250	213.0	191.0	35.0
OPA4704EA/2K5	TSSOP	PW	14	2500	353.0	353.0	32.0
OPA703NA/250	SOT-23	DBV	5	250	565.0	140.0	75.0
OPA703NA/3K	SOT-23	DBV	5	3000	565.0	140.0	75.0
OPA703UA/2K5	SOIC	D	8	2500	353.0	353.0	32.0
OPA704NA/250	SOT-23	DBV	5	250	565.0	140.0	75.0
OPA704NA/3K	SOT-23	DBV	5	3000	565.0	140.0	75.0
OPA704UA/2K5	SOIC	D	8	2500	353.0	353.0	32.0

TUBE

*All dimensions are nominal

Device	Package Name	Package Type	Pins	SPQ	L (mm)	W (mm)	T (μm)	B (mm)
OPA2703UA	D	SOIC	8	75	506.6	8	3940	4.32
OPA2703UA.B	D	SOIC	8	75	506.6	8	3940	4.32
OPA2703UAG4	D	SOIC	8	75	506.6	8	3940	4.32
OPA2703UAG4.B	D	SOIC	8	75	506.6	8	3940	4.32
OPA2704UA	D	SOIC	8	75	506.6	8	3940	4.32
OPA2704UA.B	D	SOIC	8	75	506.6	8	3940	4.32
OPA4703UA	D	SOIC	14	50	506.6	8	3940	4.32
OPA4703UA.B	D	SOIC	14	50	506.6	8	3940	4.32
OPA4704UA	D	SOIC	14	50	506.6	8	3940	4.32
OPA4704UA.B	D	SOIC	14	50	506.6	8	3940	4.32
OPA703PA	P	PDIP	8	50	506	13.97	11230	4.32
OPA703PA.B	P	PDIP	8	50	506	13.97	11230	4.32
OPA703UA	D	SOIC	8	75	506.6	8	3940	4.32
OPA703UA.B	D	SOIC	8	75	506.6	8	3940	4.32
OPA704UA	D	SOIC	8	75	506.6	8	3940	4.32
OPA704UA.B	D	SOIC	8	75	506.6	8	3940	4.32

D0014A



PACKAGE OUTLINE

SOIC - 1.75 mm max height

SMALL OUTLINE INTEGRATED CIRCUIT



NOTES:

1. All linear dimensions are in millimeters. Dimensions in parenthesis are for reference only. Dimensioning and tolerancing per ASME Y14.5M.
2. This drawing is subject to change without notice.
3. This dimension does not include mold flash, protrusions, or gate burrs. Mold flash, protrusions, or gate burrs shall not exceed 0.15 mm, per side.
4. This dimension does not include interlead flash. Interlead flash shall not exceed 0.43 mm, per side.
5. Reference JEDEC registration MS-012, variation AB.

EXAMPLE BOARD LAYOUT

D0014A

SOIC - 1.75 mm max height

SMALL OUTLINE INTEGRATED CIRCUIT



LAND PATTERN EXAMPLE
SCALE:8X



SOLDER MASK DETAILS

4220718/A 09/2016

NOTES: (continued)

- 6. Publication IPC-7351 may have alternate designs.
- 7. Solder mask tolerances between and around signal pads can vary based on board fabrication site.



D0008A

PACKAGE OUTLINE

SOIC - 1.75 mm max height

SMALL OUTLINE INTEGRATED CIRCUIT



4214825/C 02/2019

NOTES:

1. Linear dimensions are in inches [millimeters]. Dimensions in parenthesis are for reference only. Controlling dimensions are in inches. Dimensioning and tolerancing per ASME Y14.5M.
2. This drawing is subject to change without notice.
3. This dimension does not include mold flash, protrusions, or gate burrs. Mold flash, protrusions, or gate burrs shall not exceed $.006$ [0.15] per side.
4. This dimension does not include interlead flash.
5. Reference JEDEC registration MS-012, variation AA.

EXAMPLE BOARD LAYOUT

D0008A

SOIC - 1.75 mm max height

SMALL OUTLINE INTEGRATED CIRCUIT



LAND PATTERN EXAMPLE
EXPOSED METAL SHOWN
SCALE:8X



SOLDER MASK DETAILS

4214825/C 02/2019

NOTES: (continued)

- 6. Publication IPC-7351 may have alternate designs.
- 7. Solder mask tolerances between and around signal pads can vary based on board fabrication site.

EXAMPLE STENCIL DESIGN

D0008A

SOIC - 1.75 mm max height

SMALL OUTLINE INTEGRATED CIRCUIT



SOLDER PASTE EXAMPLE
BASED ON .005 INCH [0.125 MM] THICK STENCIL
SCALE:8X

4214825/C 02/2019

NOTES: (continued)

8. Laser cutting apertures with trapezoidal walls and rounded corners may offer better paste release. IPC-7525 may have alternate design recommendations.
9. Board assembly site may have different recommendations for stencil design.

P (R-PDIP-T8)

PLASTIC DUAL-IN-LINE PACKAGE



- NOTES:
- A. All linear dimensions are in inches (millimeters).
 - B. This drawing is subject to change without notice.
 - C. Falls within JEDEC MS-001 variation BA.

EXAMPLE BOARD LAYOUT

PW0014A

TSSOP - 1.2 mm max height

SMALL OUTLINE PACKAGE

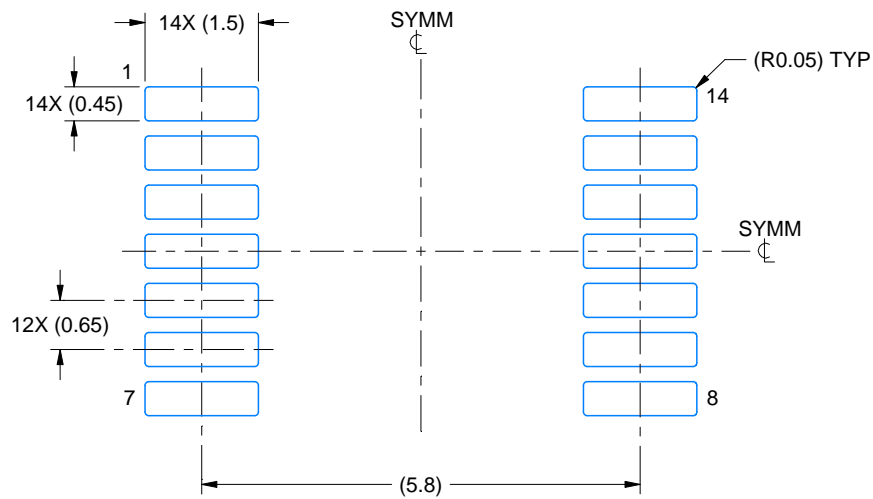

LAND PATTERN EXAMPLE
EXPOSED METAL SHOWN
SCALE: 10X



4220202/B 12/2023

NOTES: (continued)

- 6. Publication IPC-7351 may have alternate designs.
- 7. Solder mask tolerances between and around signal pads can vary based on board fabrication site.

EXAMPLE STENCIL DESIGN

PW0014A

TSSOP - 1.2 mm max height

SMALL OUTLINE PACKAGE

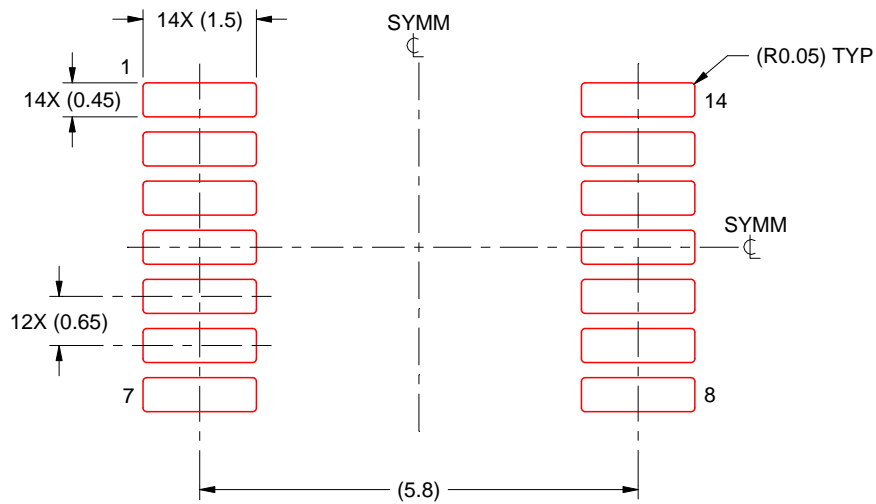

SOLDER PASTE EXAMPLE
BASED ON 0.125 mm THICK STENCIL
SCALE: 10X

4220202/B 12/2023

NOTES: (continued)

8. Laser cutting apertures with trapezoidal walls and rounded corners may offer better paste release. IPC-7525 may have alternate design recommendations.
9. Board assembly site may have different recommendations for stencil design.

EXAMPLE BOARD LAYOUT

DBV0005A

SOT-23 - 1.45 mm max height

SMALL OUTLINE TRANSISTOR



LAND PATTERN EXAMPLE
EXPOSED METAL SHOWN
SCALE:15X

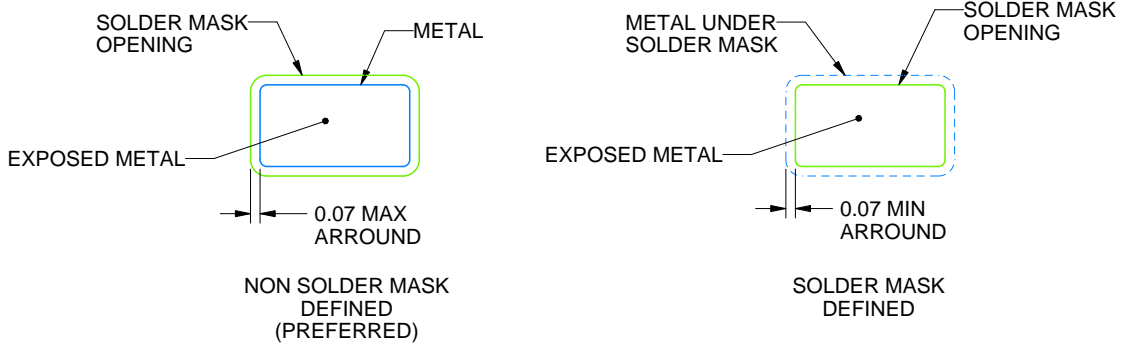

SOLDER MASK DETAILS

4214839/K 08/2024

NOTES: (continued)

- 6. Publication IPC-7351 may have alternate designs.
- 7. Solder mask tolerances between and around signal pads can vary based on board fabrication site.

EXAMPLE STENCIL DESIGN

DBV0005A

SOT-23 - 1.45 mm max height

SMALL OUTLINE TRANSISTOR



SOLDER PASTE EXAMPLE
BASED ON 0.125 mm THICK STENCIL
SCALE:15X

4214839/K 08/2024

NOTES: (continued)

8. Laser cutting apertures with trapezoidal walls and rounded corners may offer better paste release. IPC-7525 may have alternate design recommendations.
9. Board assembly site may have different recommendations for stencil design.

DGK0008A



PACKAGE OUTLINE

VSSOP - 1.1 mm max height

SMALL OUTLINE PACKAGE



4214862/A 04/2023

NOTES:

PowerPAD is a trademark of Texas Instruments.

1. All linear dimensions are in millimeters. Any dimensions in parenthesis are for reference only. Dimensioning and tolerancing per ASME Y14.5M.
2. This drawing is subject to change without notice.
3. This dimension does not include mold flash, protrusions, or gate burrs. Mold flash, protrusions, or gate burrs shall not exceed 0.15 mm per side.
4. This dimension does not include interlead flash. Interlead flash shall not exceed 0.25 mm per side.
5. Reference JEDEC registration MO-187.

EXAMPLE BOARD LAYOUT

DGK0008A

™ VSSOP - 1.1 mm max height

SMALL OUTLINE PACKAGE



LAND PATTERN EXAMPLE
EXPOSED METAL SHOWN
SCALE: 15X



SOLDER MASK DETAILS

4214862/A 04/2023

NOTES: (continued)

6. Publication IPC-7351 may have alternate designs.
7. Solder mask tolerances between and around signal pads can vary based on board fabrication site.
8. Vias are optional depending on application, refer to device data sheet. If any vias are implemented, refer to their locations shown on this view. It is recommended that vias under paste be filled, plugged or tented.
9. Size of metal pad may vary due to creepage requirement.

EXAMPLE STENCIL DESIGN

DGK0008A

TM VSSOP - 1.1 mm max height

SMALL OUTLINE PACKAGE



SOLDER PASTE EXAMPLE
SCALE: 15X

4214862/A 04/2023

NOTES: (continued)

11. Laser cutting apertures with trapezoidal walls and rounded corners may offer better paste release. IPC-7525 may have alternate design recommendations.
12. Board assembly site may have different recommendations for stencil design.

IMPORTANT NOTICE AND DISCLAIMER

TI PROVIDES TECHNICAL AND RELIABILITY DATA (INCLUDING DATASHEETS), DESIGN RESOURCES (INCLUDING REFERENCE DESIGNS), APPLICATION OR OTHER DESIGN ADVICE, WEB TOOLS, SAFETY INFORMATION, AND OTHER RESOURCES "AS IS" AND WITH ALL FAULTS, AND DISCLAIMS ALL WARRANTIES, EXPRESS AND IMPLIED, INCLUDING WITHOUT LIMITATION ANY IMPLIED WARRANTIES OF MERCHANTABILITY, FITNESS FOR A PARTICULAR PURPOSE OR NON-INFRINGEMENT OF THIRD PARTY INTELLECTUAL PROPERTY RIGHTS.

These resources are intended for skilled developers designing with TI products. You are solely responsible for (1) selecting the appropriate TI products for your application, (2) designing, validating and testing your application, and (3) ensuring your application meets applicable standards, and any other safety, security, regulatory or other requirements.

These resources are subject to change without notice. TI grants you permission to use these resources only for development of an application that uses the TI products described in the resource. Other reproduction and display of these resources is prohibited. No license is granted to any other TI intellectual property right or to any third party intellectual property right. TI disclaims responsibility for, and you fully indemnify TI and its representatives against any claims, damages, costs, losses, and liabilities arising out of your use of these resources.

TI's products are provided subject to [TI's Terms of Sale](#), [TI's General Quality Guidelines](#), or other applicable terms available either on ti.com or provided in conjunction with such TI products. TI's provision of these resources does not expand or otherwise alter TI's applicable warranties or warranty disclaimers for TI products. Unless TI explicitly designates a product as custom or customer-specified, TI products are standard, catalog, general purpose devices.

TI objects to and rejects any additional or different terms you may propose.

Copyright © 2026, Texas Instruments Incorporated

Last updated 10/2025