

## RC4558 双通道通用运算放大器

### 1 特性

- 宽共模和差分电压范围
- 无需频率补偿
- 低功耗
- 无闩锁
- 增益带宽积：4MHz 典型值
- 放大器之间的增益和相位匹配
- 低噪声：10kHz 时的典型值为  $6.5\text{nV}/\sqrt{\text{Hz}}$
- 低失真和噪声：1kHz 时为 0.0001%

### 2 应用

- AV 接收机
- 专业混音器
- 条形音箱
- 无线音箱

### 3 说明

RC4558 器件是一款双通道通用运算放大器。RC4558 器件具有宽电源电压范围 (10V 至 30V)、低噪声 ( $6.5\text{nV}/\sqrt{\text{Hz}}$ ) 和失真性能 (0.0001% THD+N)，因此可用于各种音频应用。

高共模输入电压范围和无闩锁特性使该器件非常适合电压跟随器应用。该器件的内部频率补偿可在不使用外部元件的情况下实现稳定性。

#### 封装信息 (1)

器件型号	封装	封装尺寸(2)
RC4558	D (SOIC, 8)	4.9mm × 6mm
	DGK (VSSOP, 8)	3mm × 4.9mm
	P (PDIP, 8)	9.81mm × 9.43mm
	PW (TSSOP, 8)	3mm × 6.4mm
	PS (SOP, 8)	6.2mm × 7.8mm

(1) 有关所有可用封装，请参阅节 10。

(2) 封装尺寸 (长 × 宽) 为标称值，并包括引脚 (如适用)。

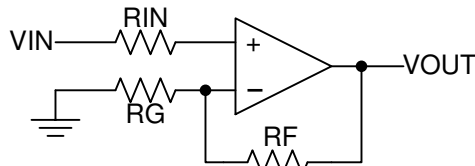

同相放大器原理图



## Table of Contents

<b>1 特性</b> .....	1	6.3 Feature Description.....	12
<b>2 应用</b> .....	1	6.4 Device Functional Modes.....	12
<b>3 说明</b> .....	1	<b>7 Application and Implementation</b> .....	13
<b>4 Pin Configuration and Functions</b> .....	3	7.1 Application Information.....	13
<b>5 Specifications</b> .....	4	7.2 Typical Application.....	13
5.1 Absolute Maximum Ratings.....	4	7.3 Power Supply Recommendations.....	16
5.2 ESD Ratings.....	4	7.4 Layout.....	16
5.3 Recommended Operating Conditions.....	4	<b>8 Device and Documentation Support</b> .....	18
5.4 Thermal Information.....	5	8.1 Trademarks.....	18
5.5 Electrical Characteristics.....	6	8.2 静电放电警告.....	18
5.6 Typical Characteristics.....	7	8.3 Glossary.....	18
<b>6 Detailed Description</b> .....	12	<b>9 Revision History</b> .....	18
6.1 Overview.....	12	<b>10 Mechanical, Packaging, and Orderable Information</b> .....	19
6.2 Functional Block Diagram.....	12		

## 4 Pin Configuration and Functions

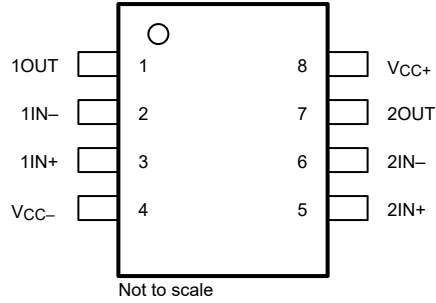

**图 4-1. D, DGK, P, PS, or PW Package  
 8-Pin SOIC, VSSOP, PDIP, TSSOP or SOP  
 (Top View)**

**表 4-1. Pin Functions**

PIN		TYPE	DESCRIPTION
NAME	NO.		
1IN+	3	I	Noninverting input
1IN -	2	I	Inverting Input
1OUT	1	O	Output
2IN+	5	I	Noninverting input
2IN -	6	I	Inverting Input
2OUT	7	O	Output
V <sub>CC+</sub>	8	—	Positive Supply
V <sub>CC-</sub>	4	—	Negative Supply

## 5 Specifications

### 5.1 Absolute Maximum Ratings

over operating ambient temperature range (unless otherwise noted)<sup>(1)</sup>

		MIN	MAX	UNIT
V <sub>CC+</sub>	Supply voltage <sup>(2)</sup>		18	V
V <sub>CC-</sub>			-18	
V <sub>ID</sub>	Differential input voltage <sup>(3)</sup>		±30	V
V <sub>I</sub>	Input voltage (any input) <sup>(2) (4)</sup>		±15	V
I <sub>O</sub>	Output Current <sup>(5)</sup>		±125	mA
T <sub>J</sub>	Operating virtual junction temperature		150	°C
T <sub>STG</sub>	Storage temperature	-65	150	°C

- (1) Operation outside the Absolute Maximum Ratings may cause permanent device damage. Absolute Maximum Ratings do not imply functional operation of the device at these or any other conditions beyond those listed under Recommended Operating Conditions. If used outside the Recommended Operating Conditions but within the Absolute Maximum Ratings, the device may not be fully functional, and this may affect device reliability, functionality, performance, and shorten the device lifetime.
- (2) All voltage values, unless otherwise noted, are with respect to the midpoint between V<sub>CC+</sub> and V<sub>CC-</sub>.
- (3) Differential voltages are at IN+ with respect to IN-.
- (4) The magnitude of the input voltage must never exceed the magnitude of the supply voltage or 15V, whichever is less.
- (5) Temperature and supply voltages must be limited to ensure that the dissipation rating is not exceeded.

### 5.2 ESD Ratings

			VALUE	UNIT
V <sub>(ESD)</sub>	Electrostatic discharge	Human-body model (HBM), per ANSI/ESDA/JEDEC JS-001 <sup>(1)</sup>	±2500	V
		Charged-device model (CDM), per ANSI/ESDA/JEDEC JS-002 <sup>(2)</sup>	±1500	

- (1) JEDEC document JEP155 states that 500V HBM allows safe manufacturing with a standard ESD control process.
- (2) JEDEC document JEP157 states that 250V CDM allows safe manufacturing with a standard ESD control process.

### 5.3 Recommended Operating Conditions

		MIN	MAX	UNIT	
V <sub>CC+</sub>	Supply voltage	5	15	V	
V <sub>CC-</sub>		-5	-15		
T <sub>A</sub>	Operating free-air temperature	RC4558	0	70	°C
		RC4558I	-40	85	

## 5.4 Thermal Information

THERMAL METRIC <sup>(1)</sup>		RC4558					Unit
		D (SOIC)	DGK (VSSOP)	P (PDIP)	PS (SOP)	PW (TSSOP)	
		8 PINS	8 PINS	8 PINS	8 PINS	8 PINS	
$R_{\theta JA}$	Junction-to-ambient thermal resistance	120.2	164.8	106	122.9	173.1	°C/W
$R_{\theta JC(top)}$	Junction-to-case (top) thermal resistance	59.6	58.8	84.9	60.1	81.8	°C/W
$R_{\theta JB}$	Junction-to-board thermal resistance	67.7	99.5	68.6	77.5	112.5	°C/W
$\psi_{JT}$	Junction-to-top characterization parameter	11.0	3.7	51.6	15.7	16.5	°C/W
$\psi_{JB}$	Junction-to-board characterization parameter	66.7	97.7	67.8	76.0	110.7	°C/W
$R_{\theta JC(bot)}$	Junction-to-case (bottom) thermal resistance	N/A	N/A	N/A	N/A	N/A	°C/W

(1) For more information about traditional and new thermal metrics, see the [Semiconductor and IC Package Thermal Metrics](#) application note.

## 5.5 Electrical Characteristics

For  $V_{CC+} = 15\text{ V}$ ,  $V_{CC-} = -15\text{ V}$  at  $T_A \approx 25^\circ\text{C}$ ,  $R_L = 2\text{ k}\Omega$  unless otherwise noted.

PARAMETER		TEST CONDITIONS <sup>(1)</sup>	$T_A$	MIN	TYP	MAX	UNIT	
$V_{OS}$	Input offset voltage	$V_O = 0\text{V}$			0.3	6	mV	
			Full range <sup>(2)</sup>			7.5		
$I_{IO}$	Input offset current	$V_O = 0\text{V}$			5	200	nA	
			Full range <sup>(2)</sup>			300		
$I_{IB}$	Input bias current	$V_O = 0\text{V}$			80	500	nA	
			Full range <sup>(2)</sup>			800		
$V_{ICR}$	Common-mode input voltage range			$\pm 12$	$\pm 14$		V	
$V_{OUT}$	Maximum output voltage swing	$R_L = 10\text{ k}\Omega$		$\pm 12$	$\pm 14.1$		V	
			Full range <sup>(2)</sup>	$\pm 10$	$\pm 13.8$			
		$R_L = 2\text{ k}\Omega$		$\pm 10$				
$A_{VD}$	Large-signal differential voltage amplification	$R_L \geq 2\text{ k}\Omega$ , $V_O = \pm 10\text{V}$		20	830		V/mV	
				86	118		dB	
			Full range <sup>(2)</sup>	15			V/mV	
			Full range <sup>(2)</sup>	83			dB	
GBW	Gain-bandwidth product	$f = 10\text{ kHz}$			4		MHz	
SSBW	Small-signal bandwidth	$V_O = 200\text{ mV}_{PP}$ , $< 1\text{ dB}$ peaking			3		MHz	
CMRR	Common-mode rejection ratio	$(V^-) + 3\text{V} < V_{ICR} < (V^+) - 3\text{V}$		70	94		dB	
	Input impedance	Common-mode		$550 \parallel 5.6$			$\text{M}\Omega \parallel \text{pF}$	
		Differential		$450 \parallel 0.8$			$\text{k}\Omega \parallel \text{pF}$	
$k_{SVS}$	Supply-voltage sensitivity ( $\Delta V_{IO}/\Delta V_{CC}$ )	$V_{CC} = \pm 5\text{V}$ to $\pm 15\text{V}$		25	150		$\mu\text{V}/\text{V}$	
			Full range <sup>(2)</sup>	76	92		dB	
$e_N$	Input voltage noise	$f = 0.1\text{ Hz}$ to $10\text{ Hz}$		0.38			$\mu\text{V}_{PP}$	
			Full range <sup>(2)</sup>	0.063			$\mu\text{V}_{RMS}$	
	Input voltage noise density		$f = 1\text{ kHz}$		7			$\text{nV}/\sqrt{\text{Hz}}$
			$f = 10\text{ kHz}$		6.5			
$I_N$	Input current noise density	$f = 1\text{ kHz}$		0.15		$\text{pA}/\sqrt{\text{Hz}}$		
THD+N	Total harmonic distortion + noise	$V_{CC} = 30\text{V}$ , $A_{VD} = 1\text{V}/\text{V}$ , $f = 1\text{ kHz}$ , $V_O = 3\text{V}_{RMS}$ , $R_L = 2\text{ k}\Omega$		0.0001			%	
			Full range <sup>(2)</sup>	120			dB	
$I_{CC}$	Supply current (both amplifiers)	$V_O = 0\text{V}$ , No load		2.5	5.6		mA	
			Full range <sup>(2)</sup>	2.65	6.6			
$V_{O1}/V_{O2}$	Crosstalk attenuation	$R_S = 1\text{ k}\Omega$ , $f = 10\text{ kHz}$ , $A_{VD} = 1\text{V}/\text{V}$		120			dB	
$t_r$	Rise time	$V_I = 20\text{ mV}$ , $C_L = 100\text{ pF}$		67			ns	
	Overshoot	$V_I = 20\text{ mV}$ , $C_L = 100\text{ pF}$		16.8			%	
SR	Slew rate	$V_{STEP} = 10\text{V}$ , $C_L = 100\text{ pF}$		1.1	2.2		$\text{V}/\mu\text{s}$	

(1) All characteristics are measured under open-loop conditions with zero common-mode input voltage, unless otherwise specified.

(2) Full range is  $0^\circ\text{C}$  to  $70^\circ\text{C}$  for RC4558 and  $-40^\circ\text{C}$  to  $85^\circ\text{C}$  for RC4558I.

## 5.6 Typical Characteristics

at  $T_A \cong 25^\circ\text{C}$ ,  $V_{CC} = 30\text{V} (\pm 15\text{V})$ ,  $V_{CM} = V_{CC} / 2$ ,  $R_L = 2\text{k}\Omega$  connected to  $V_{CC} / 2$  (unless otherwise noted)



图 5-1. Open-Loop Gain and Phase vs Frequency



图 5-2. Closed-Loop Gain vs Frequency

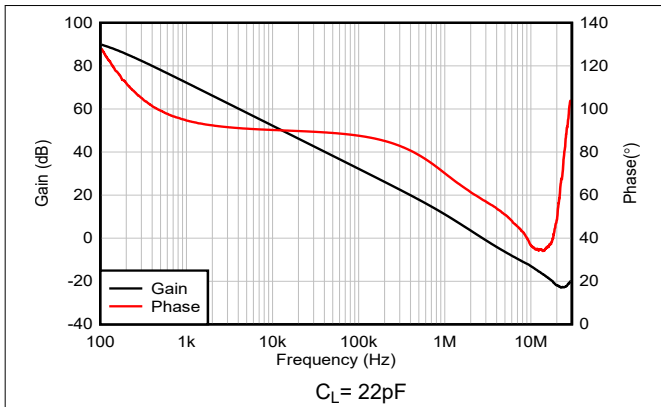

图 5-3. Supply Voltage Sensitivity vs Frequency

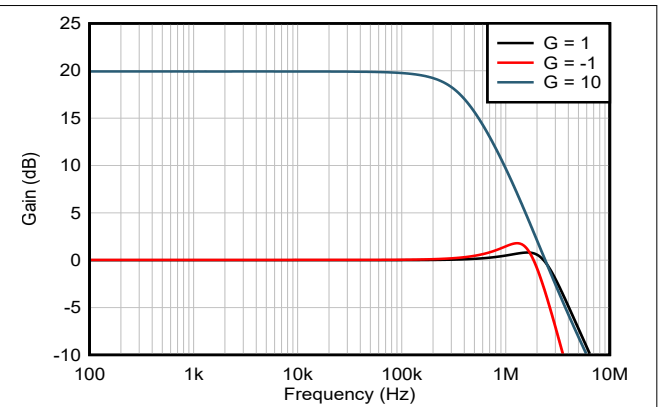

图 5-4. Common-Mode Rejection Ratio vs Frequency

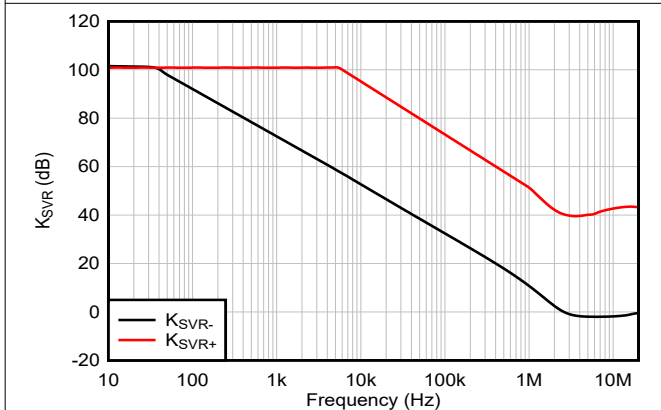

图 5-5. Input Noise Voltage vs Frequency

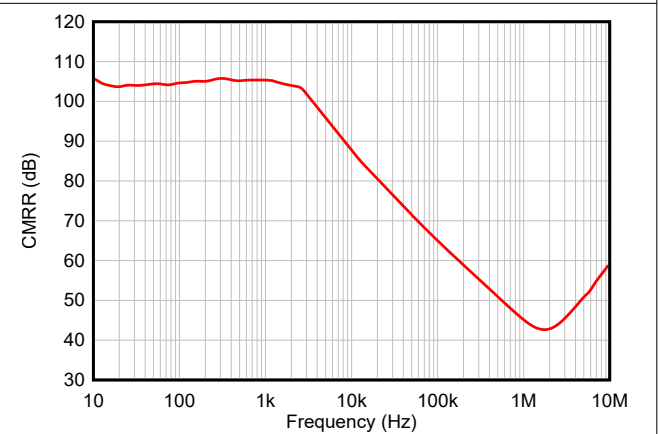

图 5-6. 0.1Hz to 10Hz Noise

D013

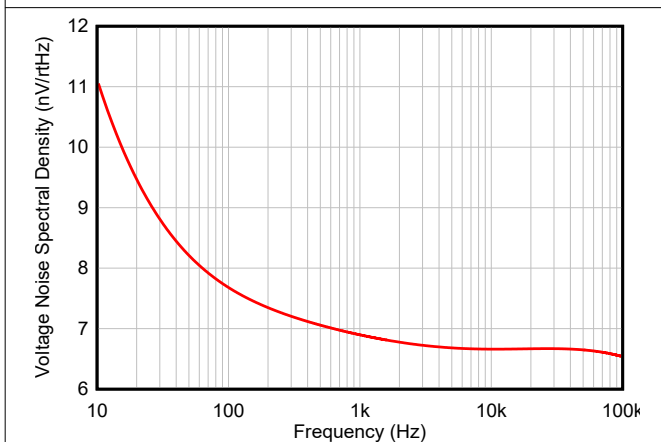

图 5-7. THD+N vs Frequency

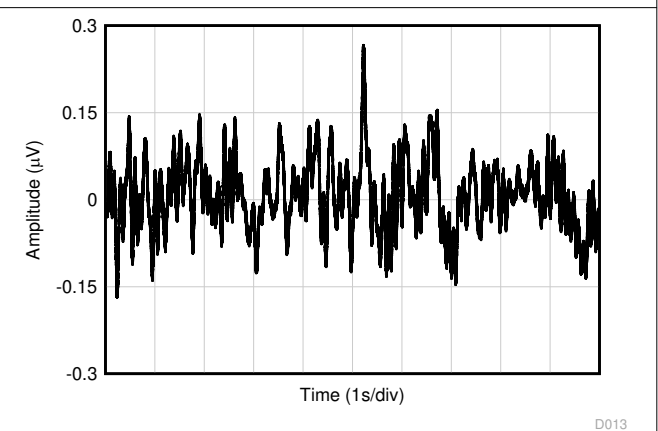

图 5-8. THD+N vs Frequency

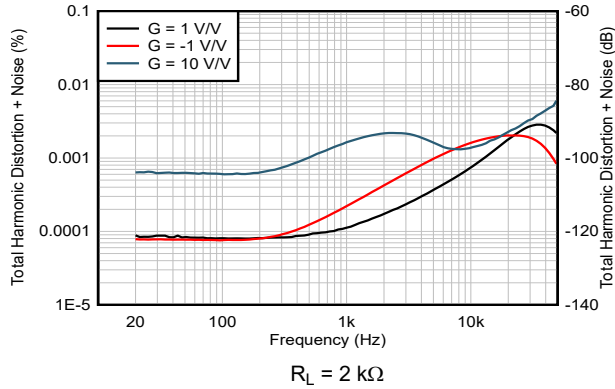

图 5-9. THD+N vs Amplitude

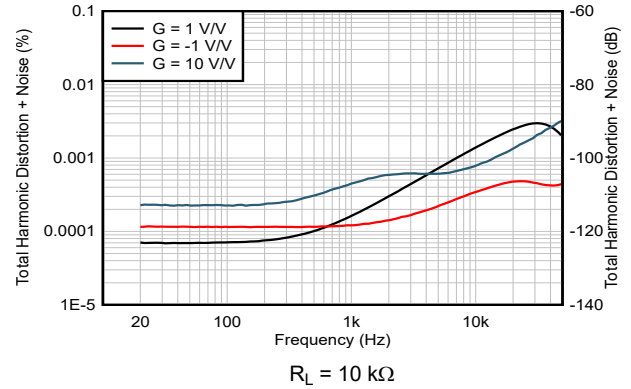

图 5-10. THD+N vs Amplitude

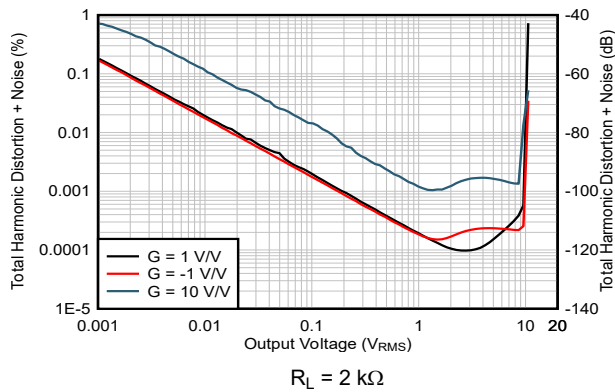

图 5-11. Open-Loop Output Impedance vs Frequency

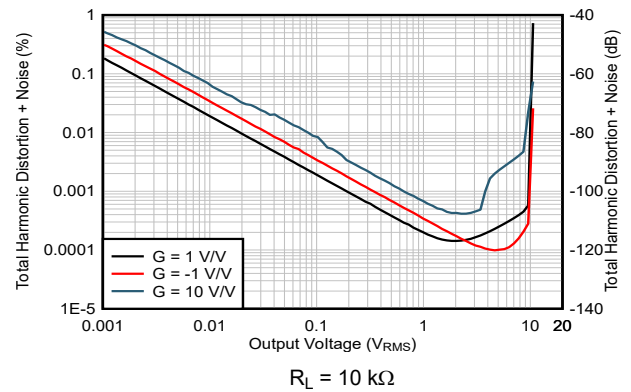

图 5-12. Output Voltage Swing vs Frequency



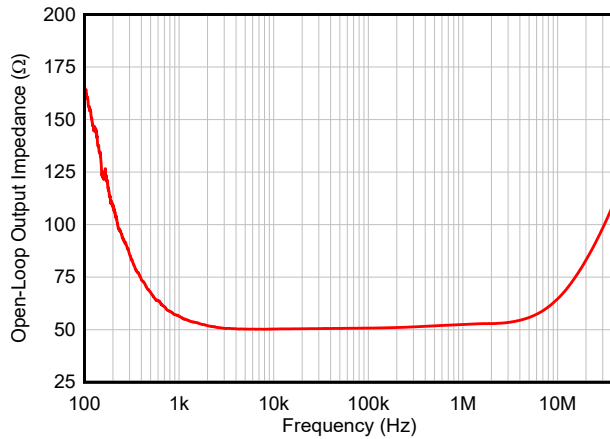

图 5-13. Large Signal Step Response

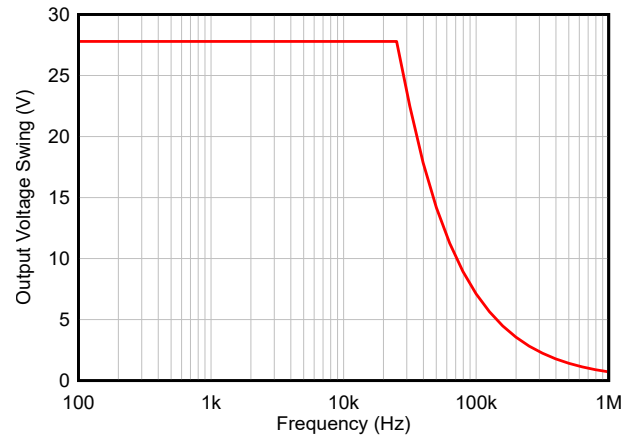

图 5-14. Small Signal Step Response

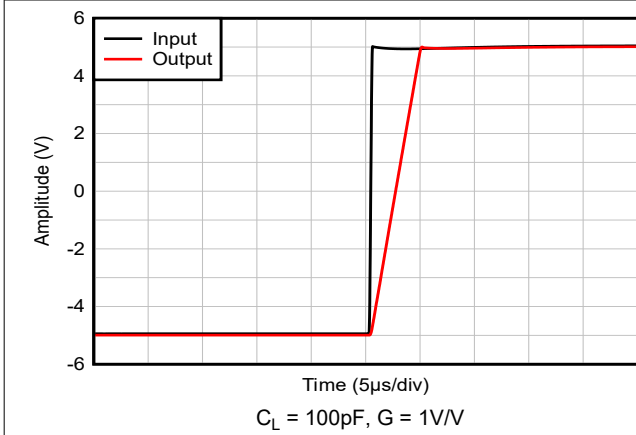

图 5-15. Crosstalk Attenuation vs Frequency

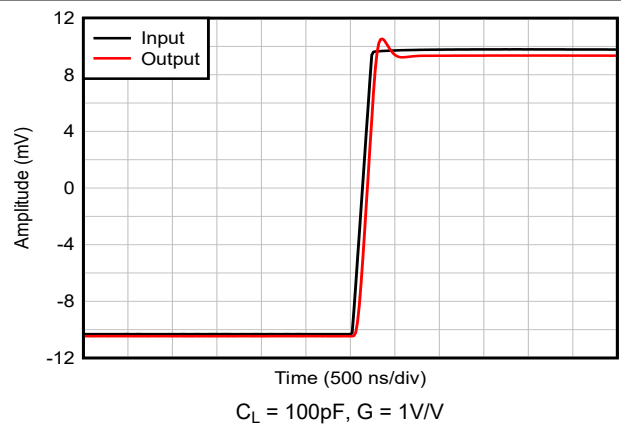

图 5-16. Maximum Output Voltage Swing vs Operating Voltage

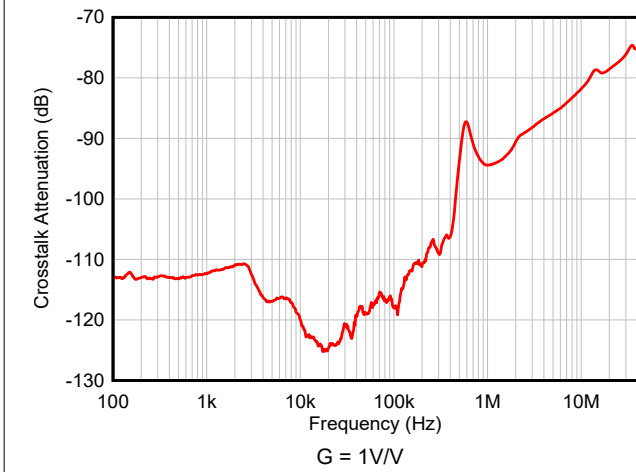

图 5-17. Output Voltage Swing vs Output Current (Sourcing)

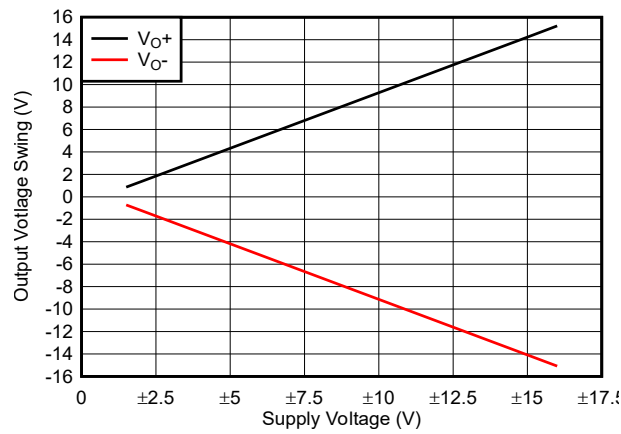

图 5-18. Output Voltage Swing vs Output Current (Sinking)

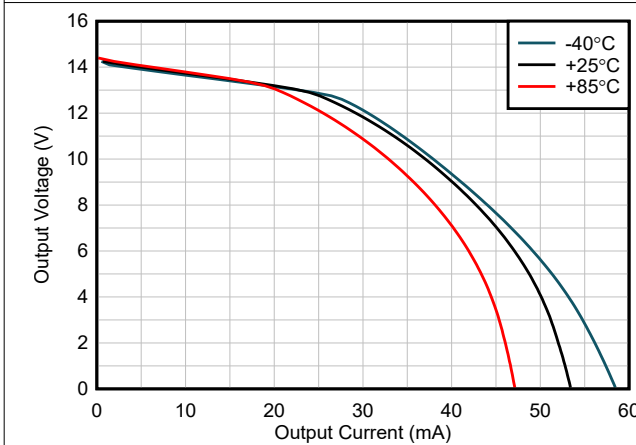

图 5-19. Offset Voltage vs Temperature

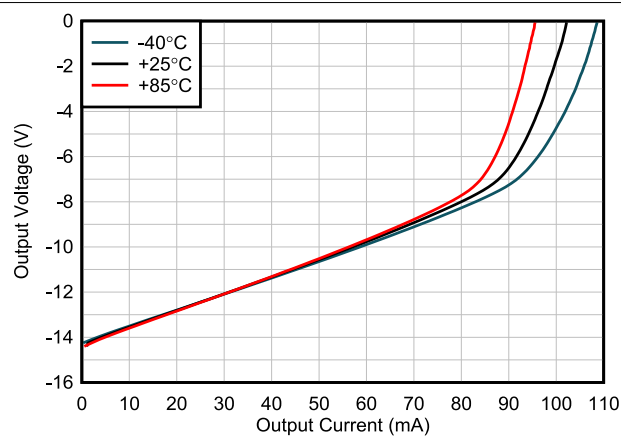

图 5-20. Bias Current vs Temperature

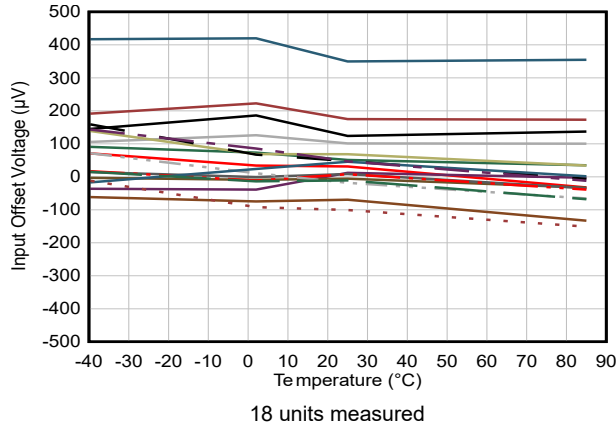

图 5-21. Positive Output Voltage Swing vs Temperature

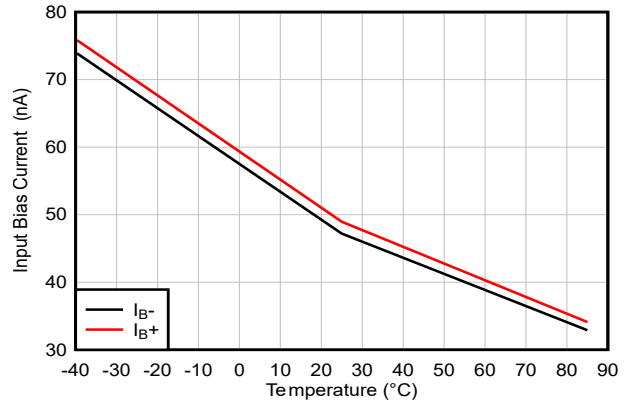

图 5-22. Negative Output Voltage Swing vs Temperature

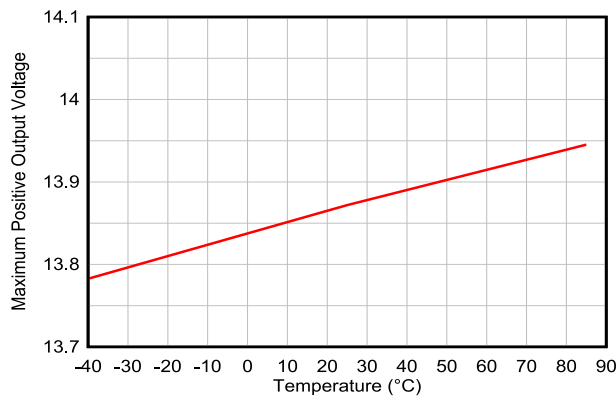

图 5-23. Common-Mode Rejection Ratio vs Temperature

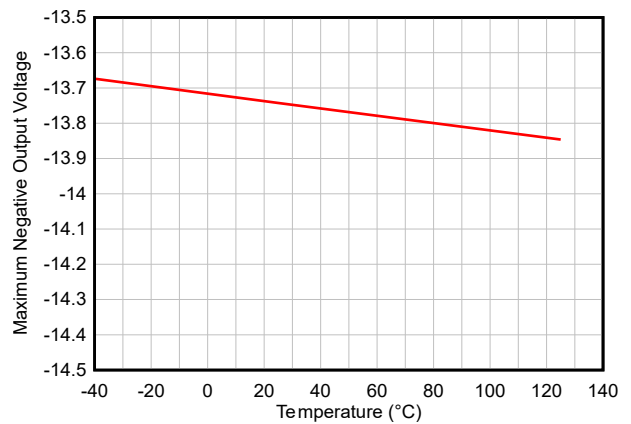

图 5-24. Power Supply Rejection Ratio vs Temperature

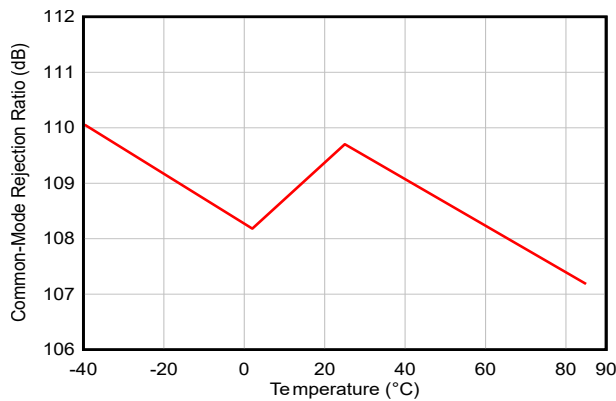

图 5-25. Supply Current vs Supply Voltage

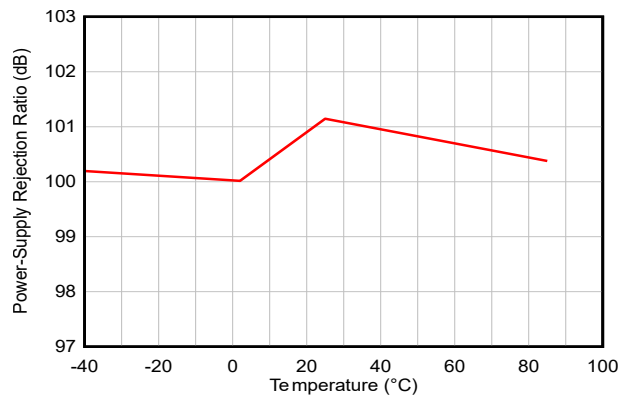

图 5-26. Supply Current vs Temperature

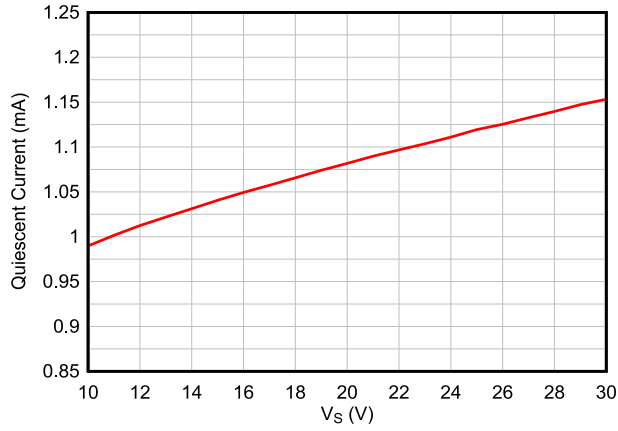

图 5-27. Open-Loop Gain vs Temperature

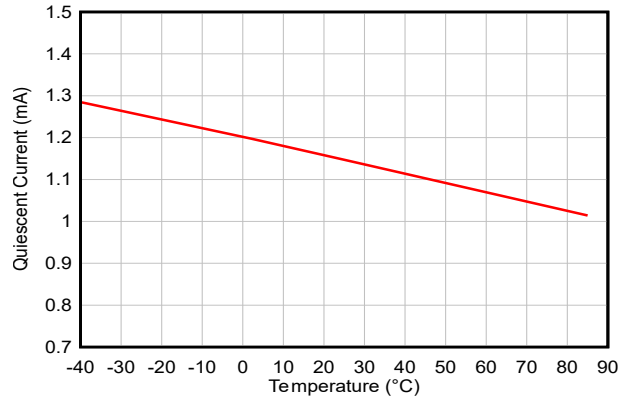

图 5-28. Short-Circuit Current vs Temperature

## 6 Detailed Description

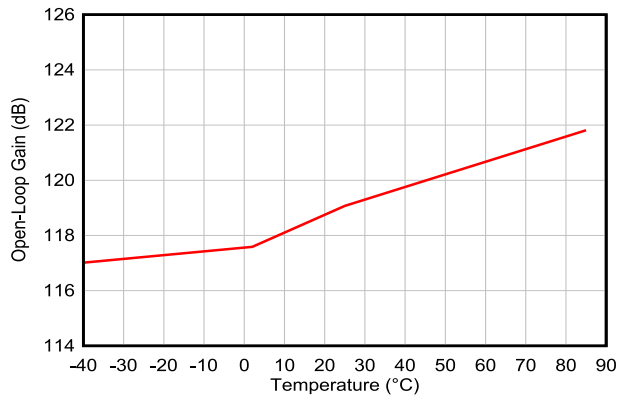
### 6.1 Overview

The RC4558 device is a dual general-purpose operational amplifier. The combination of the wide supply voltage range (10V to 30V), low noise ( $6.5\text{nV}/\sqrt{\text{Hz}}$ ), and distortion performance (0.0001% THD+N) of the device allow the RC4558 to be used in various audio applications.

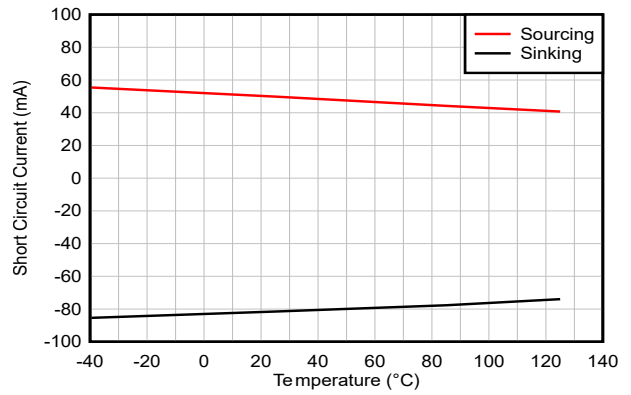
The high common-mode input voltage range and the absence of latch-up of this device are designed for voltage-follower applications. The internal frequency compensation of the device allows for stability without external components.

### 6.2 Functional Block Diagram

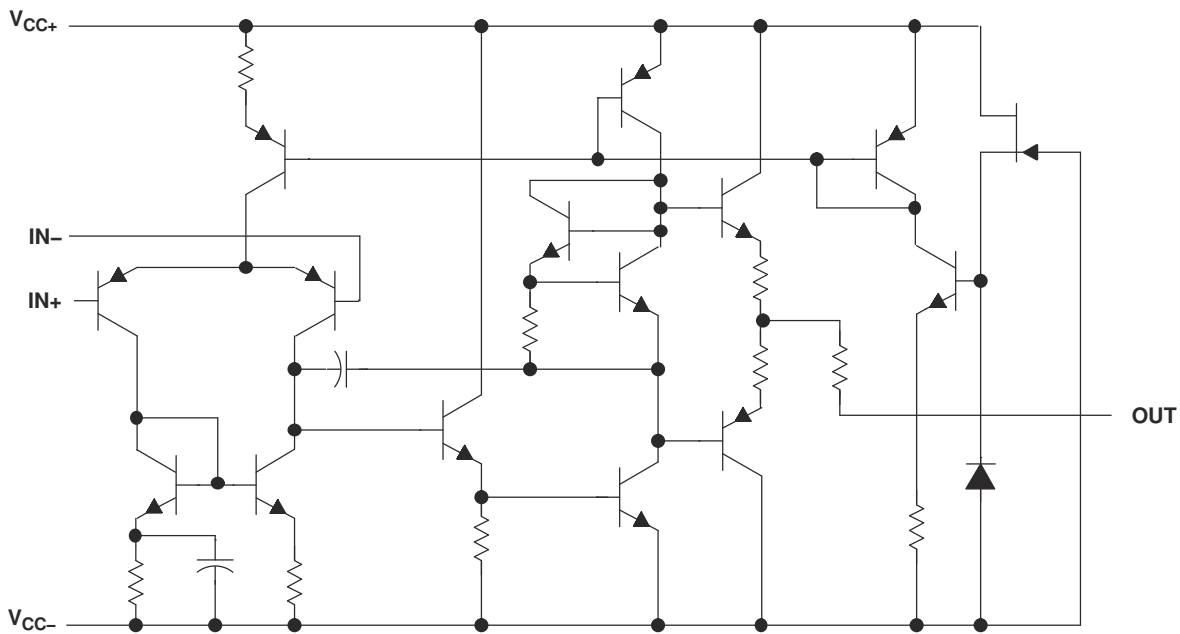

### 6.3 Feature Description

#### 6.3.1 Unity-Gain Bandwidth

The unity-gain bandwidth is the frequency up to which an amplifier with a unity gain can be operated without greatly distorting the signal. The RC4558 device has a 4MHz gain-bandwidth product.

#### 6.3.2 Common-Mode Rejection Ratio

The common-mode rejection ratio (CMRR) of an amplifier is a measure of how well the device rejects unwanted input signals common to both input leads. The CMRR is found by taking the ratio of the change in input offset voltage to the change in the input voltage, then converting the ratio to decibels. Ideally the CMRR is infinite, but in practice, amplifiers are designed to have the CMRR as high as possible. The CMRR of the RC4558 device is 94dB.

#### 6.3.3 Slew Rate

The slew rate is the rate at which an operational amplifier can change the output when there is a change on the input. The RC4558 device has a  $2.2\text{V}/\mu\text{s}$  slew rate.

### 6.4 Device Functional Modes

The RC4558 device is powered on when the supply is connected. Each of these devices can be operated as a single-supply operational amplifier or dual-supply amplifier depending on the application.

## 7 Application and Implementation

### 备注

以下应用部分中的信息不属于 TI 器件规格的范围，TI 不担保其准确性和完整性。TI 的客户应负责确定器件是否适用于其应用。客户应验证并测试其设计，以确保系统功能。

### 7.1 Application Information

The RC4558 is a dual general-purpose device that offers a wide supply range and excellent AC performance. This device operates up to 30V supply rails and offers low noise ( $6.5\text{nV}/\sqrt{\text{Hz}}$ ) and distortion performance (0.0001% THD+N). These RC4558 features are designed for both audio and industrial applications.

### 7.2 Typical Application

Some applications require differential signals. 图 7-1 shows a simple circuit to convert a single-ended input of 2V to 10V into differential output of  $\pm 8\text{V}$  on a single 15V supply. The output range is intentionally limited to maximize linearity. The circuit is composed of two amplifiers. One amplifier acts as a buffer and creates a voltage,  $V_{\text{OUT}+}$ . The second amplifier inverts the input and adds a reference voltage to generate  $V_{\text{OUT}-}$ . Both  $V_{\text{OUT}+}$  and  $V_{\text{OUT}-}$  range from 2V to 10V. The difference,  $V_{\text{DIFF}}$ , is the difference between  $V_{\text{OUT}+}$  and  $V_{\text{OUT}-}$ .



图 7-1. Schematic for Single-Ended Input to Differential Output Conversion

### 7.2.1 Design Requirements

The design requirements are as follows:

- Supply voltage: 15V
- Reference voltage: 12V
- Input: 2V to 10V
- Output differential:  $\pm 8V$

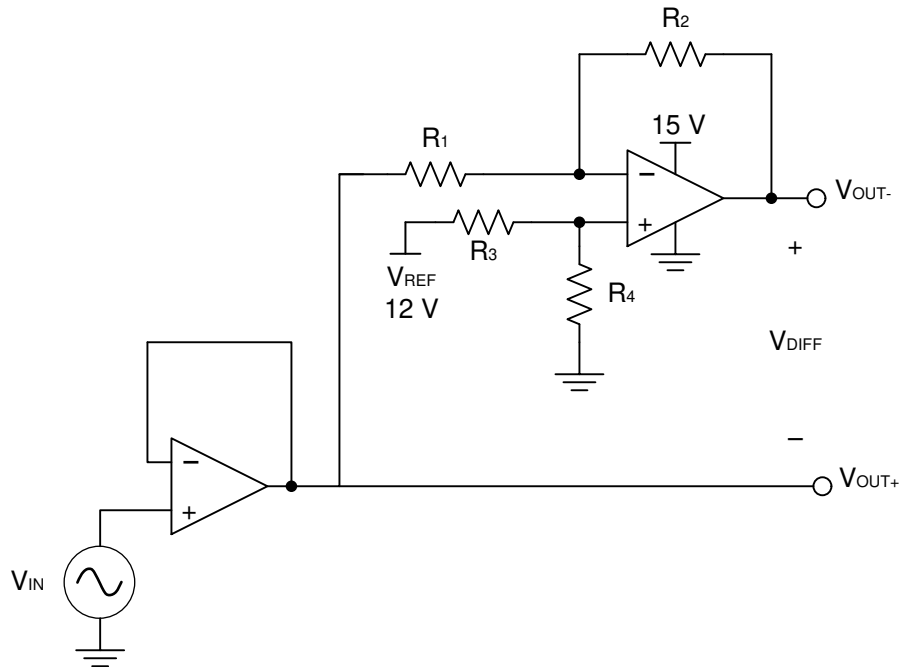
### 7.2.2 Detailed Design Procedure

The circuit in [图 7-1](#) takes a single-ended input signal,  $V_{IN}$ , and generates two output signals,  $V_{OUT+}$  and  $V_{OUT-}$ , using two amplifiers and a reference voltage,  $V_{REF}$ .  $V_{OUT+}$  is the output of the first amplifier and is a buffered version of the input signal,  $V_{IN}$  (see [方程式 1](#)).  $V_{OUT-}$  is the output of the second amplifier which uses  $V_{REF}$  to add an offset voltage to  $V_{IN}$  and feedback to add inverting gain. The transfer function for  $V_{OUT-}$  is [方程式 2](#).

$$V_{OUT+} = V_{IN} \quad (1)$$

$$V_{OUT-} = V_{REF} \times \left( \frac{R_4}{R_3 + R_4} \right) \times \left( 1 + \frac{R_2}{R_1} \right) - V_{IN} \times \frac{R_2}{R_1} \quad (2)$$

The differential output signal,  $V_{DIFF}$ , is the difference between the two single-ended output signals,  $V_{OUT+}$  and  $V_{OUT-}$ . [方程式 3](#) shows the transfer function for  $V_{DIFF}$ . By applying the conditions that  $R_1 = R_2$  and  $R_3 = R_4$ , the transfer function is simplified into [方程式 6](#). Using this configuration, the maximum input signal is equal to the reference voltage and the maximum output of each amplifier is equal to the  $V_{REF}$ . The differential output range is  $2 \times V_{REF}$ . Furthermore, the common-mode voltage is one half of  $V_{REF}$  (see [方程式 7](#)).

$$V_{DIFF} = V_{OUT+} - V_{OUT-} = V_{IN} \times \left( 1 + \frac{R_2}{R_1} \right) - V_{REF} \times \left( \frac{R_4}{R_3 + R_4} \right) \left( 1 + \frac{R_2}{R_1} \right) \quad (3)$$

$$V_{OUT+} = V_{IN} \quad (4)$$

$$V_{OUT-} = V_{REF} - V_{IN} \quad (5)$$

$$V_{DIFF} = 2 \times V_{IN} - V_{REF} \quad (6)$$

$$V_{CM} = \left( \frac{V_{OUT+} + V_{OUT-}}{2} \right) = \frac{1}{2} V_{REF} \quad (7)$$

#### 7.2.2.1 Amplifier Selection

Linearity over the input range is key for good DC accuracy. The common-mode input range and the output swing limitations determine the linearity. In general, an amplifier with rail-to-rail input and output swing is required. Bandwidth is a key concern for this design. The RC4558 device has a bandwidth of 4MHz, therefore this circuit can only process signals with frequencies of less than 4MHz.

#### 7.2.2.2 Passive Component Selection

The transfer function of  $V_{OUT-}$  is heavily reliant on resistors ( $R_1$ ,  $R_2$ ,  $R_3$ , and  $R_4$ ), therefore TI recommends to use resistors with low tolerances to maximize performance and minimize error. This design uses resistors with resistance values of

$36k\Omega$  with tolerances measured to be within 2% of these resistor values. If the noise of the system is a key parameter, the user can select smaller resistance values ( $6k\Omega$  or lower) to keep the overall system noise low and the noise from the resistors lower than the amplifier noise.

### 7.2.3 Application Curves

The measured transfer functions in 图 7-2, 图 7-3, and 图 7-4 were generated by sweeping the input voltage from 0V to 12V. However, this design must only be used between 2V and 10V for optimum linearity.



图 7-2. Differential Output Voltage Node vs Input Voltage



图 7-3. Positive Output Voltage Node vs Input Voltage

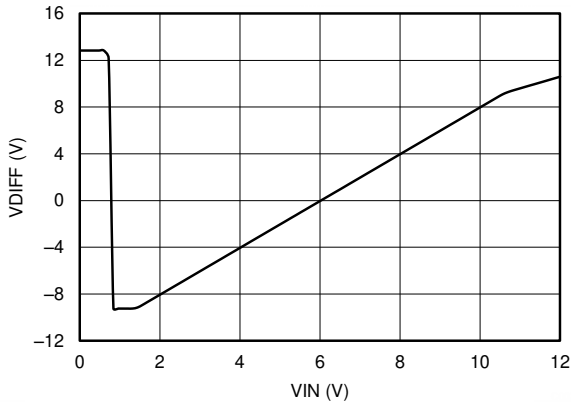

图 7-4. Positive Output Voltage Node vs Input Voltage

## 7.3 Power Supply Recommendations

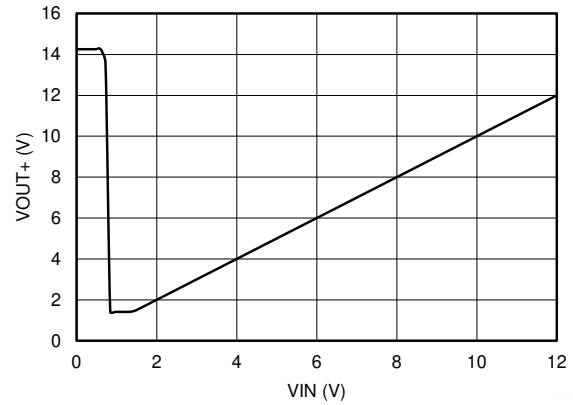
The RC4558 device is specified for  $\pm 5\text{V}$  to  $\pm 15\text{V}$  operation; many specifications apply for  $-0^\circ\text{C}$  to  $70^\circ\text{C}$ . The [Typical Characteristics](#) section presents parameters that can exhibit significant variance with regard to operating voltage or temperature.

小心

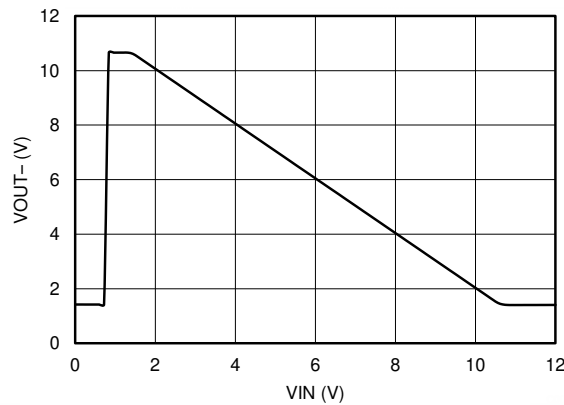
Supply voltages outside of the  $\pm 18\text{V}$  range can permanently damage the device (see the [Absolute Maximum Ratings](#)).

Place  $0.1\ \mu\text{F}$  bypass capacitors close to the power-supply pins to reduce errors coupling in from noisy or high impedance power supplies. For more detailed information on bypass capacitor placement, refer to the [Layout Guidelines](#).

## 7.4 Layout

### 7.4.1 Layout Guidelines

For best operational performance of the device, use good printed circuit board (PCB) layout practices, including:

- Noise can propagate into analog circuitry through the operational amplifier and the power pins of the circuit as a whole. Bypass capacitors are used to reduce the coupled noise by providing low impedance power sources local to the analog circuitry.
  - Connect low-ESR,  $0.1\ \mu\text{F}$  ceramic bypass capacitors between each supply pin and ground, placed as close to the device as possible. A single bypass capacitor from  $V+$  to ground is applicable for single-supply applications.
- Separating grounding for analog and digital portions of circuitry is one of the simplest and most effective methods of noise suppression. One or more layers on multilayer PCBs are usually devoted to ground planes. A ground plane helps distribute heat and reduces EMI noise pickup. Make sure to physically separate digital and analog grounds, paying attention to the flow of the ground current.
- To reduce parasitic coupling, run the input traces as far away from the supply or output traces as possible. If it is not possible to keep the traces separate, it is much better to cross the sensitive trace perpendicular as opposed to in parallel with the noisy trace.
- Place the external components as close to the device as possible. Keeping  $R_F$  and  $R_G$  close to the inverting input minimizes parasitic capacitance, as shown in [Layout Example](#).
- Keep the length of input traces as short as possible. Always remember that the input traces are the most sensitive part of the circuit.
- Consider a driven, low-impedance guard ring around the critical traces. A guard ring can significantly reduce leakage currents from nearby traces that are at different potentials.

### 7.4.2 Layout Example



图 7-5. Operational Amplifier Schematic for Noninverting Configuration



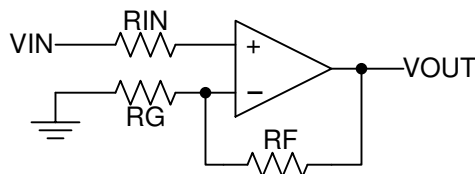
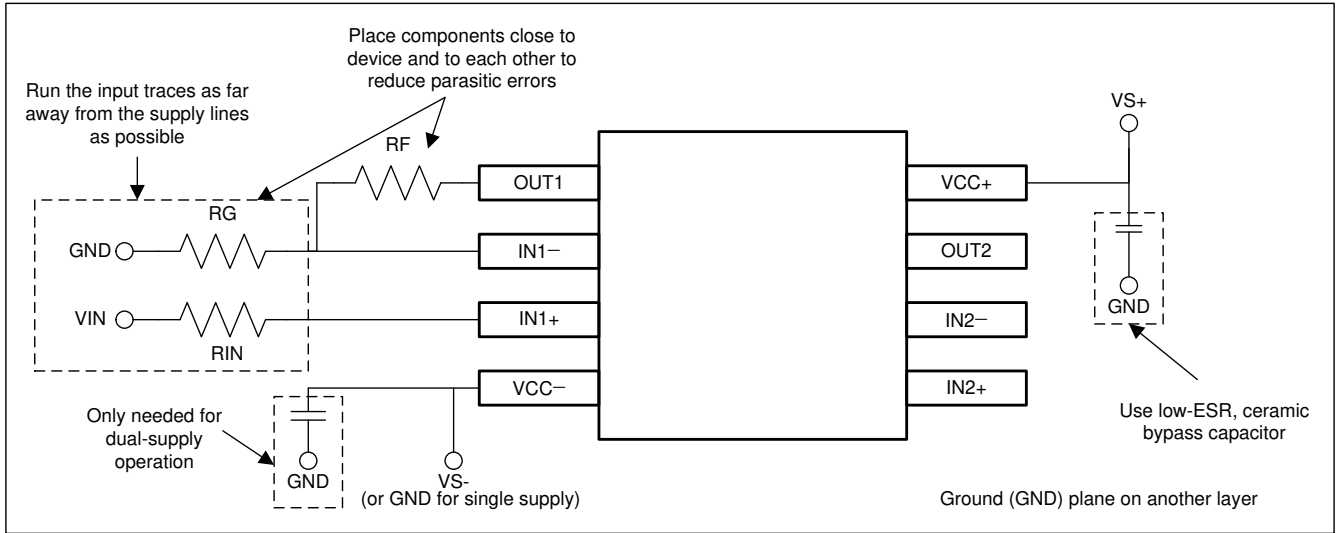

**图 7-6. Operational Amplifier Board Layout for Noninverting Configuration**

## 8 Device and Documentation Support

### 8.1 Trademarks

所有商标均为其各自所有者的财产。

### 8.2 静电放电警告



静电放电 (ESD) 会损坏这个集成电路。德州仪器 (TI) 建议通过适当的预防措施处理所有集成电路。如果不遵守正确的处理和安装程序，可能会损坏集成电路。

ESD 的损坏小至导致微小的性能降级，大至整个器件故障。精密的集成电路可能更容易受到损坏，这是因为非常细微的参数更改都可能会导致器件与其发布的规格不相符。

### 8.3 Glossary

[SLYZ022](#) — *TI Glossary*.

This glossary lists and explains terms, acronyms and definitions.

## 9 Revision History

Changes from Revision G (November 2014) to Revision H (October 2024)	Page
• 更新了特性、应用、说明、详细说明、特性说明、详细设计过程和布局指南部分，用于反映“规格”部分中列出的更改.....	1
• 将器件信息表更改为封装信息.....	1
• Removed <i>Duration of output short circuit to ground</i> specification and added maximum output current of $\pm 125\text{mA}$ in <i>Absolute Maximum Ratings</i> table.....	4
• Updated <i>Handling Ratings</i> table to <i>ESD Ratings</i> table.....	4
• Updated <i>Thermal Information</i> table.....	5
• Changed the typical <i>input offset voltage</i> value from: 0.5mV to 0.3mV in the <i>Electrical Characteristics</i> table....	6
• Changed the typical <i>Input bias current</i> value from: 150nA to 80nA in the <i>Electrical Characteristics</i> table.....	6
• Changed the typical <i>maximum output voltage swing</i> value at $R_L = 10\text{k}\Omega$ from $\pm 14\text{V}$ to $\pm 14.1\text{V}$ in the <i>Electrical Characteristics</i> table.....	6
• Changed the typical <i>maximum output voltage swing</i> value at $R_L = 2\text{k}\Omega$ from: $\pm 13\text{V}$ to $\pm 13.8\text{V}$ in the <i>Electrical Characteristics</i> table.....	6
• Changed the typical <i>large-signal differential voltage amplification</i> value from: 300V/mV to 830V/mV in the <i>Electrical Characteristics</i> table.....	6
• Added line items for the <i>large-signal voltage amplification</i> parameter to show values in dB units in the <i>Electrical Characteristics</i> table.....	6
• Changed <i>unity gain-bandwidth</i> parameter to <i>gain-bandwidth product</i> and changed the typical value from: 3MHz to 4MHz in the <i>Electrical Characteristics</i> table.....	6
• Added the <i>small-signal bandwidth</i> parameter in the <i>Electrical Characteristics</i> table.....	6
• Added test condition to the <i>common-mode rejection ratio</i> parameter in the <i>Electrical Characteristics</i> table....	6
• Changed the typical <i>common-mode rejection ratio</i> value from: 90dB to 94dB in the <i>Electrical Characteristics</i> table.....	6
• Removed the minimum limit for the <i>input resistance</i> parameter in the <i>Electrical Characteristics</i> table.....	6
• Updated the <i>input resistance</i> parameter to <i>input impedance</i> to better reflect device characteristics in the <i>Electrical Characteristics</i> table.....	6
• Changed the test condition of the <i>supply-voltage sensitivity</i> parameter from: $V_{CC} = \pm 15\text{V}$ to $\pm 9\text{V}$ to $V_{CC} = \pm 5\text{V}$ to $\pm 15\text{V}$ in the <i>Electrical Characteristics</i> table.....	6
• Updated the typical <i>supply-voltage sensitivity</i> value from: 30 $\mu\text{V/V}$ to 25 $\mu\text{V/V}$ in the <i>Electrical Characteristics</i> table.....	6
• Added line items for <i>supply-voltage sensitivity</i> parameter to show values in dB units in the <i>Electrical Characteristics</i> table.....	6

- Added *input voltage noise* parameter to the *Electrical Characteristics* table.....6
- Changed test conditions of *equivalent input noise voltage (closed loop)* parameter to  $f = 1$  kHz in the *Electrical Characteristics* table..... 6
- Changed typical *equivalent input noise voltage (closed loop)* at  $f = 1$  kHz from  $8 \text{ nV}/\sqrt{\text{Hz}}$  to  $7 \text{ nV}/\sqrt{\text{Hz}}$  in the *Electrical Characteristics* table..... 6
- Changed *equivalent input noise voltage (closed loop)* specification to *input voltage noise density* in the *Electrical Characteristics* table..... 6
- Added  $f = 10$  kHz test condition to *equivalent input noise voltage (closed loop)* specification in the *Electrical Characteristics* table..... 6
- Added the *input current noise density* parameter to the *Electrical Characteristics* table.....6
- Removed the *total power dissipation* parameter in the *Electrical Characteristics* table..... 6
- Changed  $T_A \text{ min}$  and  $T_A \text{ max}$  conditions for supply current to one full range temperature condition in the *Electrical Characteristics* table..... 6
- Changed the typical *supply current (both amplifiers)* value at full temperature range from: 3 mA to 2.65 mA in the *Electrical Characteristics* table..... 6
- Changed the test condition for the *crosstalk attenuation* parameter from *Open loop &  $A_{VD} = 100 \text{ V/V}$*  to  $A_{VD} = 1\text{V/V}$  in the *Electrical Characteristics* table.....6
- Changed the typical *crosstalk attenuation* value from: 105dB to 120 dB in the *Electrical Characteristics* table 6
- Changed the *rise time* typical value from: 0.13 ns to 67 ns in the *Electrical Characteristics* table.....6
- Changed the *overshoot* typical value from: 5% to 16.8% in the *Electrical Characteristics* table.....6
- Changed the *slew rate* typical value from:  $1.7\text{V}/\mu\text{s}$  to  $2.2\text{V}/\mu\text{s}$  in the *Electrical Characteristics* table..... 6
- Changed and added graphs to the *Typical Characteristics* section.....7

**Changes from Revision F (September 2010) to Revision G (November 2014)**

**Page**

- 添加了应用、器件信息表、处理等级表、特性说明部分、器件功能模式、应用和实施部分、电源相关建议部分、布局部分、器件和文档支持部分以及机械、封装和可订购信息部分..... 1
- 删除了订购信息表..... 1

**10 Mechanical, Packaging, and Orderable Information**

The following pages include mechanical packaging and orderable information. This information is the most current data available for the designated devices. This data is subject to change without notice and revision of this document. For browser based versions of this data sheet, refer to the left hand navigation.

**PACKAGING INFORMATION**

Orderable Device	Status (1)	Package Type	Package Drawing	Pins	Package Qty	Eco Plan (2)	Lead finish/ Ball material (6)	MSL Peak Temp (3)	Op Temp (°C)	Device Marking (4/5)	Samples
RC4558D	OBSOLETE	SOIC	D	8		TBD	Call TI	Call TI	0 to 70	RC4558	
RC4558DGKR	ACTIVE	VSSOP	DGK	8	2500	RoHS & Green	NIPDAU   NIPDAUAG	Level-1-260C-UNLIM	0 to 70	(YRP, YRS, YRU)	<a href="#">Samples</a>
RC4558DGKRG4	ACTIVE	VSSOP	DGK	8	2500	TBD	Call TI	Call TI	0 to 70		<a href="#">Samples</a>
RC4558DR	ACTIVE	SOIC	D	8	2500	RoHS & Green	NIPDAU   SN	Level-1-260C-UNLIM	0 to 70	RC4558	<a href="#">Samples</a>
RC4558DRG3	OBSOLETE	SOIC	D	8		TBD	Call TI	Call TI	0 to 70	RC4558	
RC4558DRG4	OBSOLETE	SOIC	D	8		TBD	Call TI	Call TI	0 to 70	RC4558	
RC4558ID	OBSOLETE	SOIC	D	8		TBD	Call TI	Call TI	-40 to 85	R4558I	
RC4558IDGKR	ACTIVE	VSSOP	DGK	8	2500	RoHS & Green	NIPDAU	Level-1-260C-UNLIM	-40 to 85	(YSP, YSS, YSU)	<a href="#">Samples</a>
RC4558IDR	ACTIVE	SOIC	D	8	2500	RoHS & Green	NIPDAU	Level-1-260C-UNLIM	-40 to 85	R4558I	<a href="#">Samples</a>
RC4558IP	ACTIVE	PDIP	P	8	50	RoHS & Green	NIPDAU	N / A for Pkg Type	-40 to 85	RC4558IP	<a href="#">Samples</a>
RC4558IPW	OBSOLETE	TSSOP	PW	8		TBD	Call TI	Call TI	-40 to 85	R4558I	
RC4558IPWR	ACTIVE	TSSOP	PW	8	2000	RoHS & Green	NIPDAU   SN	Level-1-260C-UNLIM	-40 to 85	R4558I	<a href="#">Samples</a>
RC4558P	ACTIVE	PDIP	P	8	50	RoHS & Green	NIPDAU	N / A for Pkg Type	0 to 70	RC4558P	<a href="#">Samples</a>
RC4558PSR	ACTIVE	SO	PS	8	2000	RoHS & Green	NIPDAU	Level-1-260C-UNLIM	0 to 70	R4558	<a href="#">Samples</a>
RC4558PSRG4	ACTIVE	SO	PS	8	2000	RoHS & Green	NIPDAU	Level-1-260C-UNLIM	0 to 70	R4558	<a href="#">Samples</a>
RC4558PW	OBSOLETE	TSSOP	PW	8		TBD	Call TI	Call TI	0 to 70	R4558	
RC4558PWR	ACTIVE	TSSOP	PW	8	2000	RoHS & Green	NIPDAU   SN	Level-1-260C-UNLIM	0 to 70	R4558	<a href="#">Samples</a>

(1) The marketing status values are defined as follows:

**ACTIVE:** Product device recommended for new designs.

**LIFEBUY:** TI has announced that the device will be discontinued, and a lifetime-buy period is in effect.

**NRND:** Not recommended for new designs. Device is in production to support existing customers, but TI does not recommend using this part in a new design.

**PREVIEW:** Device has been announced but is not in production. Samples may or may not be available.

**OBSOLETE:** TI has discontinued the production of the device.

(2) **RoHS:** TI defines "RoHS" to mean semiconductor products that are compliant with the current EU RoHS requirements for all 10 RoHS substances, including the requirement that RoHS substance do not exceed 0.1% by weight in homogeneous materials. Where designed to be soldered at high temperatures, "RoHS" products are suitable for use in specified lead-free processes. TI may reference these types of products as "Pb-Free".

**RoHS Exempt:** TI defines "RoHS Exempt" to mean products that contain lead but are compliant with EU RoHS pursuant to a specific EU RoHS exemption.

**Green:** TI defines "Green" to mean the content of Chlorine (Cl) and Bromine (Br) based flame retardants meet JS709B low halogen requirements of  $\leq 1000$ ppm threshold. Antimony trioxide based flame retardants must also meet the  $\leq 1000$ ppm threshold requirement.

(3) MSL, Peak Temp. - The Moisture Sensitivity Level rating according to the JEDEC industry standard classifications, and peak solder temperature.

(4) There may be additional marking, which relates to the logo, the lot trace code information, or the environmental category on the device.

(5) Multiple Device Markings will be inside parentheses. Only one Device Marking contained in parentheses and separated by a "~" will appear on a device. If a line is indented then it is a continuation of the previous line and the two combined represent the entire Device Marking for that device.

(6) Lead finish/Ball material - Orderable Devices may have multiple material finish options. Finish options are separated by a vertical ruled line. Lead finish/Ball material values may wrap to two lines if the finish value exceeds the maximum column width.

**Important Information and Disclaimer:** The information provided on this page represents TI's knowledge and belief as of the date that it is provided. TI bases its knowledge and belief on information provided by third parties, and makes no representation or warranty as to the accuracy of such information. Efforts are underway to better integrate information from third parties. TI has taken and continues to take reasonable steps to provide representative and accurate information but may not have conducted destructive testing or chemical analysis on incoming materials and chemicals. TI and TI suppliers consider certain information to be proprietary, and thus CAS numbers and other limited information may not be available for release.

In no event shall TI's liability arising out of such information exceed the total purchase price of the TI part(s) at issue in this document sold by TI to Customer on an annual basis.

## TAPE AND REEL INFORMATION



### QUADRANT ASSIGNMENTS FOR PIN 1 ORIENTATION IN TAPE



\*All dimensions are nominal

Device	Package Type	Package Drawing	Pins	SPQ	Reel Diameter (mm)	Reel Width W1 (mm)	A0 (mm)	B0 (mm)	K0 (mm)	P1 (mm)	W (mm)	Pin1 Quadrant
RC4558DGKR	VSSOP	DGK	8	2500	330.0	12.4	5.3	3.4	1.4	8.0	12.0	Q1
RC4558DGKR	VSSOP	DGK	8	2500	330.0	12.4	5.3	3.3	1.3	8.0	12.0	Q1
RC4558DGKR	VSSOP	DGK	8	2500	330.0	12.4	5.3	3.4	1.4	8.0	12.0	Q1
RC4558DR	SOIC	D	8	2500	330.0	12.4	6.4	5.2	2.1	8.0	12.0	Q1
RC4558IDGKR	VSSOP	DGK	8	2500	330.0	12.4	5.3	3.3	1.3	8.0	12.0	Q1
RC4558IDGKR	VSSOP	DGK	8	2500	330.0	12.4	5.3	3.4	1.4	8.0	12.0	Q1
RC4558IDR	SOIC	D	8	2500	330.0	12.4	6.4	5.2	2.1	8.0	12.0	Q1
RC4558IPWR	TSSOP	PW	8	2000	330.0	12.4	7.0	3.6	1.6	8.0	12.0	Q1
RC4558PSR	SO	PS	8	2000	330.0	16.4	8.35	6.6	2.4	12.0	16.0	Q1
RC4558PWR	TSSOP	PW	8	2000	330.0	12.4	7.0	3.6	1.6	8.0	12.0	Q1
RC4558PWR	TSSOP	PW	8	2000	330.0	12.4	7.0	3.6	1.6	8.0	12.0	Q1

**TAPE AND REEL BOX DIMENSIONS**

\*All dimensions are nominal

Device	Package Type	Package Drawing	Pins	SPQ	Length (mm)	Width (mm)	Height (mm)
RC4558DGKR	VSSOP	DGK	8	2500	364.0	364.0	27.0
RC4558DGKR	VSSOP	DGK	8	2500	370.0	355.0	55.0
RC4558DGKR	VSSOP	DGK	8	2500	358.0	335.0	35.0
RC4558DR	SOIC	D	8	2500	353.0	353.0	32.0
RC4558IDGKR	VSSOP	DGK	8	2500	370.0	355.0	55.0
RC4558IDGKR	VSSOP	DGK	8	2500	358.0	335.0	35.0
RC4558IDR	SOIC	D	8	2500	340.5	338.1	20.6
RC4558IPWR	TSSOP	PW	8	2000	356.0	356.0	35.0
RC4558PSR	SO	PS	8	2000	356.0	356.0	35.0
RC4558PWR	TSSOP	PW	8	2000	356.0	356.0	35.0
RC4558PWR	TSSOP	PW	8	2000	364.0	364.0	27.0

**TUBE**

\*All dimensions are nominal

Device	Package Name	Package Type	Pins	SPQ	L (mm)	W (mm)	T (μm)	B (mm)
RC4558IP	P	PDIP	8	50	506	13.97	11230	4.32
RC4558P	P	PDIP	8	50	506	13.97	11230	4.32





D0008A

# PACKAGE OUTLINE

SOIC - 1.75 mm max height

SMALL OUTLINE INTEGRATED CIRCUIT



4214825/C 02/2019

NOTES:

1. Linear dimensions are in inches [millimeters]. Dimensions in parenthesis are for reference only. Controlling dimensions are in inches. Dimensioning and tolerancing per ASME Y14.5M.
2. This drawing is subject to change without notice.
3. This dimension does not include mold flash, protrusions, or gate burrs. Mold flash, protrusions, or gate burrs shall not exceed  $.006$  [0.15] per side.
4. This dimension does not include interlead flash.
5. Reference JEDEC registration MS-012, variation AA.

# EXAMPLE BOARD LAYOUT

D0008A

SOIC - 1.75 mm max height

SMALL OUTLINE INTEGRATED CIRCUIT



LAND PATTERN EXAMPLE  
 EXPOSED METAL SHOWN  
 SCALE:8X



SOLDER MASK DETAILS

4214825/C 02/2019

NOTES: (continued)

- 6. Publication IPC-7351 may have alternate designs.
- 7. Solder mask tolerances between and around signal pads can vary based on board fabrication site.

# EXAMPLE STENCIL DESIGN

D0008A

SOIC - 1.75 mm max height

SMALL OUTLINE INTEGRATED CIRCUIT



SOLDER PASTE EXAMPLE  
BASED ON .005 INCH [0.125 MM] THICK STENCIL  
SCALE:8X

4214825/C 02/2019

NOTES: (continued)

8. Laser cutting apertures with trapezoidal walls and rounded corners may offer better paste release. IPC-7525 may have alternate design recommendations.
9. Board assembly site may have different recommendations for stencil design.

# MECHANICAL DATA

PS (R-PDSO-G8)

PLASTIC SMALL-OUTLINE PACKAGE



- NOTES:
- A. All linear dimensions are in millimeters.
  - B. This drawing is subject to change without notice.
  - C. Body dimensions do not include mold flash or protrusion, not to exceed 0,15.

PS (R-PDSO-G8)

PLASTIC SMALL OUTLINE



- NOTES:
- A. All linear dimensions are in millimeters.
  - B. This drawing is subject to change without notice.
  - C. Publication IPC-7351 is recommended for alternate designs.
  - D. Laser cutting apertures with trapezoidal walls and also rounding corners will offer better paste release. Customers should contact their board assembly site for stencil design recommendations. Refer to IPC-7525 for other stencil recommendations.
  - E. Customers should contact their board fabrication site for solder mask tolerances between and around signal pads.

P (R-PDIP-T8)

PLASTIC DUAL-IN-LINE PACKAGE

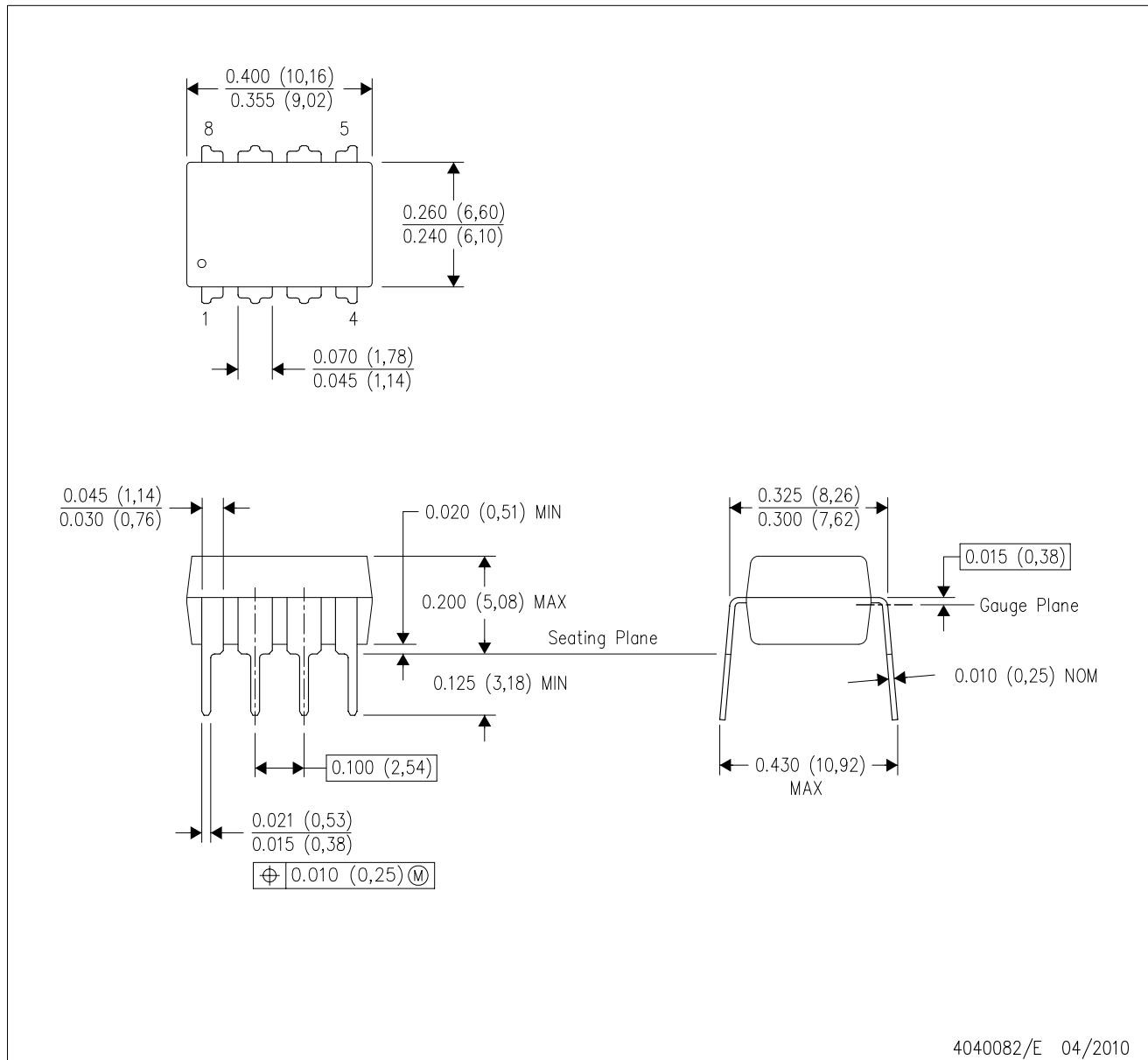

- NOTES:
- A. All linear dimensions are in inches (millimeters).
  - B. This drawing is subject to change without notice.
  - C. Falls within JEDEC MS-001 variation BA.

PW0008A



**PACKAGE OUTLINE**  
**TSSOP - 1.2 mm max height**

SMALL OUTLINE PACKAGE



4221848/A 02/2015

NOTES:

1. All linear dimensions are in millimeters. Any dimensions in parenthesis are for reference only. Dimensioning and tolerancing per ASME Y14.5M.
2. This drawing is subject to change without notice.
3. This dimension does not include mold flash, protrusions, or gate burrs. Mold flash, protrusions, or gate burrs shall not exceed 0.15 mm per side.
4. This dimension does not include interlead flash. Interlead flash shall not exceed 0.25 mm per side.
5. Reference JEDEC registration MO-153, variation AA.

# EXAMPLE BOARD LAYOUT

PW0008A

TSSOP - 1.2 mm max height

SMALL OUTLINE PACKAGE



LAND PATTERN EXAMPLE  
SCALE:10X



SOLDER MASK DETAILS  
NOT TO SCALE

4221848/A 02/2015

NOTES: (continued)

- 6. Publication IPC-7351 may have alternate designs.
- 7. Solder mask tolerances between and around signal pads can vary based on board fabrication site.



# EXAMPLE STENCIL DESIGN

PW0008A

TSSOP - 1.2 mm max height

SMALL OUTLINE PACKAGE



SOLDER PASTE EXAMPLE  
BASED ON 0.125 mm THICK STENCIL  
SCALE:10X

4221848/A 02/2015

NOTES: (continued)

8. Laser cutting apertures with trapezoidal walls and rounded corners may offer better paste release. IPC-7525 may have alternate design recommendations.
9. Board assembly site may have different recommendations for stencil design.

# DGK0008A



# PACKAGE OUTLINE

VSSOP - 1.1 mm max height

SMALL OUTLINE PACKAGE



4214862/A 04/2023

**NOTES:**

PowerPAD is a trademark of Texas Instruments.

1. All linear dimensions are in millimeters. Any dimensions in parenthesis are for reference only. Dimensioning and tolerancing per ASME Y14.5M.
2. This drawing is subject to change without notice.
3. This dimension does not include mold flash, protrusions, or gate burrs. Mold flash, protrusions, or gate burrs shall not exceed 0.15 mm per side.
4. This dimension does not include interlead flash. Interlead flash shall not exceed 0.25 mm per side.
5. Reference JEDEC registration MO-187.

# EXAMPLE BOARD LAYOUT

DGK0008A

™ VSSOP - 1.1 mm max height

SMALL OUTLINE PACKAGE



LAND PATTERN EXAMPLE  
EXPOSED METAL SHOWN  
SCALE: 15X



SOLDER MASK DETAILS

4214862/A 04/2023

NOTES: (continued)

6. Publication IPC-7351 may have alternate designs.
7. Solder mask tolerances between and around signal pads can vary based on board fabrication site.
8. Vias are optional depending on application, refer to device data sheet. If any vias are implemented, refer to their locations shown on this view. It is recommended that vias under paste be filled, plugged or tented.
9. Size of metal pad may vary due to creepage requirement.

# EXAMPLE STENCIL DESIGN

DGK0008A

<sup>TM</sup> VSSOP - 1.1 mm max height

SMALL OUTLINE PACKAGE



SOLDER PASTE EXAMPLE  
SCALE: 15X

4214862/A 04/2023

NOTES: (continued)

11. Laser cutting apertures with trapezoidal walls and rounded corners may offer better paste release. IPC-7525 may have alternate design recommendations.
12. Board assembly site may have different recommendations for stencil design.

## 重要声明和免责声明

TI“按原样”提供技术和可靠性数据（包括数据表）、设计资源（包括参考设计）、应用或其他设计建议、网络工具、安全信息和其他资源，不保证没有瑕疵且不做任何明示或暗示的担保，包括但不限于对适销性、某特定用途方面的适用性或不侵犯任何第三方知识产权的暗示担保。

这些资源可供使用 TI 产品进行设计的熟练开发人员使用。您将自行承担以下全部责任：(1) 针对您的应用选择合适的 TI 产品，(2) 设计、验证并测试您的应用，(3) 确保您的应用满足相应标准以及任何其他功能安全、信息安全、监管或其他要求。

这些资源如有变更，恕不另行通知。TI 授权您仅可将这些资源用于研发本资源所述的 TI 产品的应用。严禁对这些资源进行其他复制或展示。您无权使用任何其他 TI 知识产权或任何第三方知识产权。您应全额赔偿因在这些资源的使用中对 TI 及其代表造成的任何索赔、损害、成本、损失和债务，TI 对此概不负责。

TI 提供的产品受 [TI 的销售条款](#) 或 [ti.com](#) 上其他适用条款/TI 产品随附的其他适用条款的约束。TI 提供这些资源并不会扩展或以其他方式更改 TI 针对 TI 产品发布的适用的担保或担保免责声明。

TI 反对并拒绝您可能提出的任何其他或不同的条款。

邮寄地址：Texas Instruments, Post Office Box 655303, Dallas, Texas 75265

Copyright © 2024，德州仪器 (TI) 公司