

## SN74AHC1G14 单通道施密特触发反相器门

### 1 特性

- 工作电压范围为 2V 至 5.5V
- 5V 时  $t_{pd}$  最大值为 10ns
- 低功耗,  $I_{CC}$  最大值为 10 $\mu$ A
- 5V 下的输出驱动为  $\pm 8$ mA
- 闩锁性能超过 250mA, 符合 JESD 17 规范

### 2 应用

- 条形码扫描器
- 电缆解决方案
- 电子书
- 嵌入式个人电脑 (PC)
- 现场变送器: 温度或压力传感器
- 指纹识别
- HVAC: 暖通空调
- 网络附属存储 (NAS)
- 服务器主板和电源装置 (PSU)
- 软件定义无线电 (SDR)
- 电视: 高清电视 (HDTV)、LCD 电视和数字电视
- 视频通信系统
- 无线数据访问卡、耳机、键盘、鼠标和局域网 (LAN) 卡

### 3 说明

SN74AHC1G14 器件是一个单通道反相器门。该器件执行布尔函数

$$Y = \bar{A}$$

#### 封装信息

器件型号	封装 <sup>(1)</sup>	封装尺寸 <sup>(2)</sup>	封装尺寸 <sup>(3)</sup>
SN74AHC1G14	DBV ( SOT-23 , 5 )	2.8mm x 2.8mm	2.9mm x 1.6mm
	DCK ( SC-70 , 5 )	2mm x 2.1mm	2mm x 1.25mm
	DRL ( SOT-553 , 5 )	1.6mm x 1.6mm	1.6mm x 1.2mm

- (1) 如需了解所有可用封装, 请参阅数据表末尾的可订购产品附录。
- (2) 封装尺寸 (长 x 宽) 为标称值, 并包括引脚 (如适用)。
- (3) 封装尺寸 (长 x 宽) 为标称值, 不包括引脚。

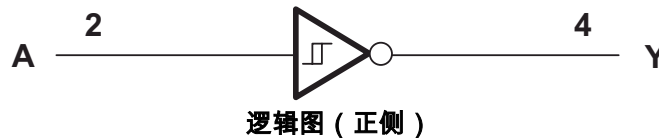

## Table of Contents

<b>1 特性</b> .....	1	7.2 Functional Block Diagram.....	8
<b>2 应用</b> .....	1	7.3 Feature Description.....	8
<b>3 说明</b> .....	1	7.4 Device Functional Modes.....	8
<b>4 Pin Configuration and Functions</b> .....	3	<b>8 Application and Implementation</b> .....	9
<b>5 Specifications</b> .....	4	8.1 Application Information.....	9
5.1 Absolute Maximum Ratings.....	4	8.2 Typical Application.....	9
5.2 ESD Ratings.....	4	8.3 Power Supply Recommendations.....	10
5.3 Recommended Operating Conditions.....	4	8.4 Layout.....	10
5.4 Thermal Information.....	5	<b>9 Device and Documentation Support</b> .....	12
5.5 Electrical Characteristics.....	5	9.1 Documentation Support (Analog).....	12
5.6 Switching Characteristics, $V_{CC} = 3.3\text{ V} \pm 0.3\text{ V}$ .....	6	9.2 支持资源.....	12
5.7 Switching Characteristics, $V_{CC} = 5\text{ V} \pm 0.5\text{ V}$ .....	6	9.3 Trademarks.....	12
5.8 Operating Characteristics.....	6	9.4 静电放电警告.....	12
5.9 Typical Characteristics.....	6	9.5 术语表.....	12
<b>6 Parameter Measurement Information</b> .....	7	<b>10 Revision History</b> .....	12
<b>7 Detailed Description</b> .....	8	<b>11 Mechanical, Packaging, and Orderable Information</b> .....	12
7.1 Overview.....	8		

## 4 Pin Configuration and Functions



图 4-1. DBV Package 5-Pin SOT-23 Top View



图 4-2. DCK Package 5-Pin SC70 Top View

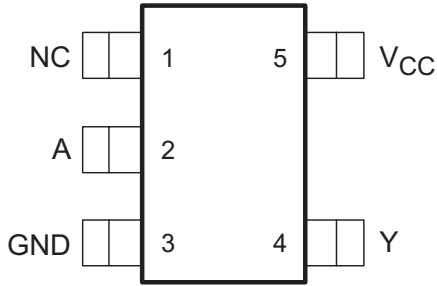

图 4-3. DRL Package 5-Pin SOT Top View

表 4-1. Pin Functions

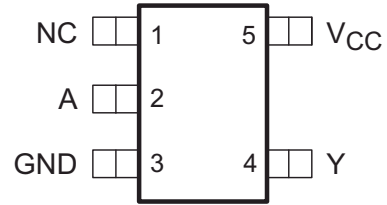
PIN		TYPE <sup>(1)</sup>	DESCRIPTION
NO.	NAME		
1	NC	—	No connect
2	A	I	Data Input
3	GND	—	Ground
4	Y	O	Data Output
5	VCC	—	Power

(1) Signal Types: I = Input, O = Output, I/O = Input or Output

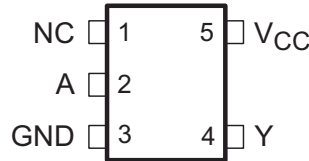
## 5 Specifications

### 5.1 Absolute Maximum Ratings

over operating free-air temperature range (unless otherwise noted)<sup>(1)</sup>

		MIN	MAX	UNIT	
V <sub>CC</sub>	Supply voltage	−0.5	7	V	
V <sub>I</sub>	Input voltage <sup>(2)</sup>	−0.5	7	V	
V <sub>O</sub>	Output voltage <sup>(2)</sup>	−0.5	V <sub>CC</sub> + 0.5	V	
I <sub>IK</sub>	Input clamp current	V <sub>I</sub> < 0		−20	mA
I <sub>OK</sub>	Output clamp current	V <sub>O</sub> < 0 or V <sub>O</sub> > V <sub>CC</sub>		±20	mA
I <sub>O</sub>	Continuous output current	V <sub>O</sub> = 0 to V <sub>CC</sub>		±25	mA
Continuous current through V <sub>CC</sub> or GND				±50	mA
T <sub>J</sub>	Maximum junction temperature			150	°C
T <sub>stg</sub>	Storage temperature	−65	150	°C	

- (1) Stresses beyond those listed under *Absolute Maximum Ratings* may cause permanent damage to the device. These are stress ratings only, and functional operation of the device at these or any other conditions beyond those indicated under *Recommended Operating Conditions* is not implied. Exposure to absolute-maximum-rated conditions for extended periods may affect device reliability.
- (2) The input and output voltage ratings may be exceeded if the input and output current ratings are observed.

### 5.2 ESD Ratings

		VALUE	UNIT
V <sub>(ESD)</sub>	Electrostatic discharge	Human body model (HBM), per ANSI/ESDA/JEDEC JS-001, all pins <sup>(1)</sup>	±1500
		Charged-device model (CDM), per JEDEC specification JESD22-C101, all pins <sup>(2)</sup>	±1000

- (1) JEDEC document JEP155 states that 500-V HBM allows safe manufacturing with a standard ESD control process.
- (2) JEDEC document JEP157 states that 250-V CDM allows safe manufacturing with a standard ESD control process.

### 5.3 Recommended Operating Conditions

over operating free-air temperature range (unless otherwise noted)<sup>(1)</sup>

		MIN	MAX	UNIT
V <sub>CC</sub>	Supply voltage	2	5.5	V
V <sub>I</sub>	Input voltage	0	5.5	V
V <sub>O</sub>	Output voltage	0	V <sub>CC</sub>	V
I <sub>OH</sub>	High-level output current	V <sub>CC</sub> = 2 V	−50	μA
		V <sub>CC</sub> = 3.3 V ± 0.3 V	−4	mA
		V <sub>CC</sub> = 5 V ± 0.5 V	−8	
I <sub>OL</sub>	Low-level output current	V <sub>CC</sub> = 2 V	50	μA
		V <sub>CC</sub> = 3.3 V ± 0.3 V	4	mA
		V <sub>CC</sub> = 5 V ± 0.5 V	8	
T <sub>A</sub>	Operating free-air temperature	−40	125	°C

- (1) All unused inputs of the device must be held at V<sub>CC</sub> or GND to ensure proper device operation. Refer to the TI application report, *Implications of Slow or Floating CMOS Inputs*, [SCBA004](#).

## 5.4 Thermal Information

THERMAL METRIC <sup>(1)</sup>		SN74AHC1G14			UNIT
		DBV (SOT-23)	DCK (SC70)	DRL (SOT)	
		5 PINS	5 PINS	5 PINS	
R <sub>θJA</sub>	Junction-to-ambient thermal resistance	278	289.2	271.8	°C/W
R <sub>θJC(top)</sub>	Junction-to-case (top) thermal resistance	180.5	205.8	116.6	°C/W
R <sub>θJB</sub>	Junction-to-board thermal resistance	184.4	176.2	89.9	°C/W
ψ <sub>JT</sub>	Junction-to-top characterization parameter	115.4	117.6	17.3	°C/W
ψ <sub>JB</sub>	Junction-to-board characterization parameter	183.4	175.1	89.4	°C/W
R <sub>θJC(bot)</sub>	Junction-to-case (bot) thermal resistance	N/A	N/A	N/A	°C/W

(1) For more information about traditional and new thermal metrics, see the *Semiconductor and IC Package Thermal Metrics* application report, [SPRA953](#).

## 5.5 Electrical Characteristics

over operating free-air temperature range (unless otherwise noted)

PARAMETER	TEST CONDITIONS	V <sub>CC</sub>	T <sub>A</sub> = 25°C			T <sub>A</sub> = -40°C to 85°C			RECOMMENDED T <sub>A</sub> = -40°C to 125°C			UNIT	
			MIN	TYP	MAX	MIN	TYP	MAX	MIN	TYP	MAX		
V <sub>T+</sub>	Positive-going input threshold voltage	3 V	1.2		2.2	1.2		2.2	1.2		2.2	V	
		4.5 V	1.75		3.15	1.75		3.15	1.75		3.15		
		5.5 V	2.15		3.85	2.15		2.85	2.15		3.85		
V <sub>T-</sub>	Negative-going input threshold voltage	3 V	0.9		1.9	0.9		1.9	0.9		1.9	V	
		4.5 V	1.35		2.75	1.35		2.75	1.35		2.75		
		5.5 V	1.65		3.35	1.65		3.35	1.65		3.35		
ΔV <sub>T</sub>	Hysteresis (V <sub>T+</sub> – V <sub>T-</sub> )	3 V	0.3		1.2	0.3		1.2	0.25		1.2	V	
		4.5 V	0.4		1.4	0.4		1.4	0.35		1.4		
		5.5 V	0.5		1.6	0.5		1.6	0.45		1.6		
V <sub>OH</sub>	High level output voltage	I <sub>OH</sub> = -50 μA	2 V	1.9		2	1.9		2	1.9		2	V
			3 V	2.9		3	2.9		3	2.9		3	
			4.5 V	4.4		4.5	4.4		4.5	4.4		4.5	
		I <sub>OH</sub> = -4 mA	3 V	2.58		2.58	2.48		2.48	2.4		2.4	
		I <sub>OL</sub> = -8 mA	4.5 V	3.94		3.94	3.8		3.8	3.7		3.7	
V <sub>OL</sub>	Low level output voltage	I <sub>OH</sub> = 50 μA	2 V			0.1			0.1			0.1	V
			3 V			0.1			0.1			0.1	
			4.5 V			0.1			0.1			0.1	
		I <sub>OH</sub> = 4 mA	3 V			0.36			0.44			0.55	
		I <sub>OL</sub> = 8 mA	4.5 V			0.36			0.44			0.55	
I <sub>I</sub>	Input leakage current	V <sub>I</sub> = 5.5 V or GND	0 V to 5.5 V								±0.1	±1	μA
I <sub>CC</sub>	Supply current	V <sub>I</sub> = V <sub>CC</sub> or GND, I <sub>O</sub> = 0	5.5 V								1	10	μA
C <sub>i</sub>	Input Capacitance	V <sub>I</sub> = V <sub>CC</sub> or GND	5 V			2					10	10	pF

## 5.6 Switching Characteristics, $V_{CC} = 3.3\text{ V} \pm 0.3\text{ V}$

over recommended operating free-air temperature range (unless otherwise noted) (see [Load Circuit and Voltage Waveforms](#))

PARAMETER	FROM (INPUT)	TO (OUTPUT)	OUTPUT CAPACITANCE	$T_A = 25^\circ\text{C}$		$T_A = -40^\circ\text{C to } 85^\circ\text{C}$		RECOMMENDED $T_A = -40^\circ\text{C to } 125^\circ\text{C}$		UNIT
				TYP	MAX	MIN	MAX	MIN	MAX	
$t_{PLH}$	A	Y	$C_L = 15\text{ pF}$	8.3	12.8	1	15	1	16	ns
$t_{PHL}$				8.3	12.8	1	15	1	16	ns
$t_{PLH}$	A	Y	$C_L = 50\text{ pF}$	10.8	16.3	1	18.5	1	19.5	ns
$t_{PHL}$				10.8	16.3	1	18.5	1	19.5	ns

## 5.7 Switching Characteristics, $V_{CC} = 5\text{ V} \pm 0.5\text{ V}$

over recommended operating free-air temperature range (unless otherwise noted) (see [Load Circuit and Voltage Waveforms](#))

PARAMETER	FROM (INPUT)	TO (OUTPUT)	OUTPUT CAPACITANCE	$T_A = 25^\circ\text{C}$		$T_A = -40^\circ\text{C to } 85^\circ\text{C}$		RECOMMENDED $T_A = -40^\circ\text{C to } 125^\circ\text{C}$		UNIT
				TYP	MAX	MIN	MAX	MIN	MAX	
$t_{PLH}$	A or B	Y	$C_L = 15\text{ pF}$	5.5	8.6	1	10	1	11	ns
$t_{PHL}$				5.5	8.6	1	10	1	11	ns
$t_{PLH}$	A or B	Y	$C_L = 50\text{ pF}$	7	10.6	1	12	1	11	ns
$t_{PHL}$				7	10.6	1	12	1	11	ns

## 5.8 Operating Characteristics

$V_{CC} = 5\text{ V}$ ,  $T_A = 25^\circ\text{C}$

PARAMETER	TEST CONDITIONS	TYP	UNIT
$C_{pd}$ Power dissipation capacitance	No load, $f = 1\text{ MHz}$	9	pF

## 5.9 Typical Characteristics

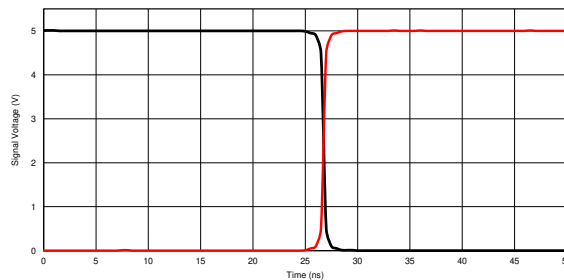

$T_A = 25^\circ\text{C}$ ,  $V_A = 5\text{ V}$

图 5-1. Response Time vs Output Voltage

## 6 Parameter Measurement Information

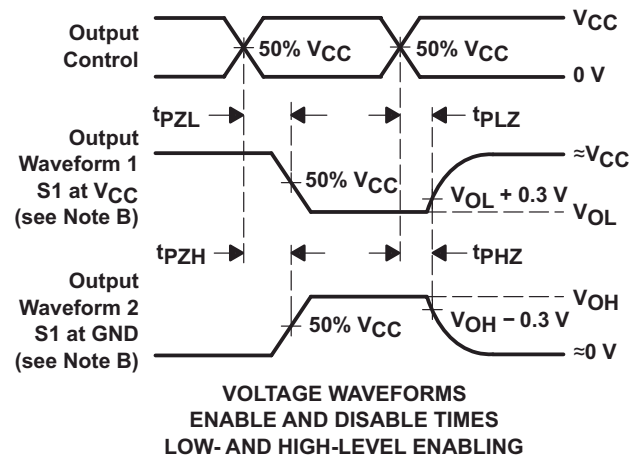
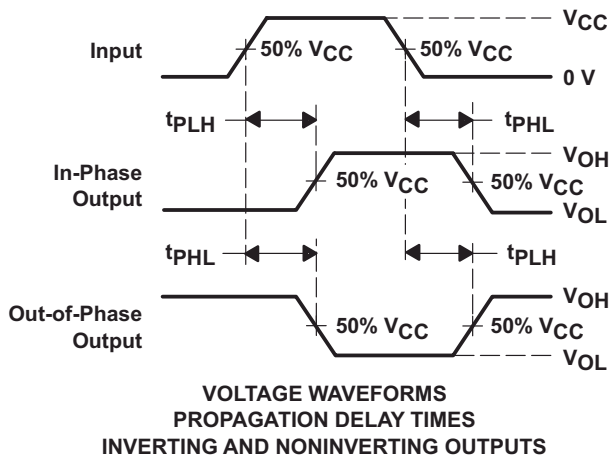
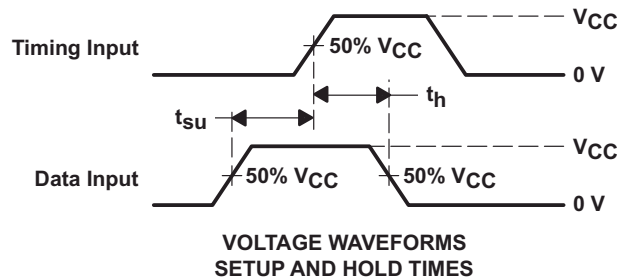
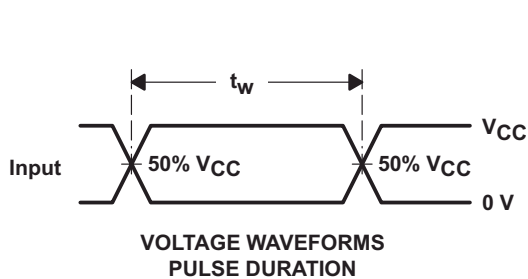
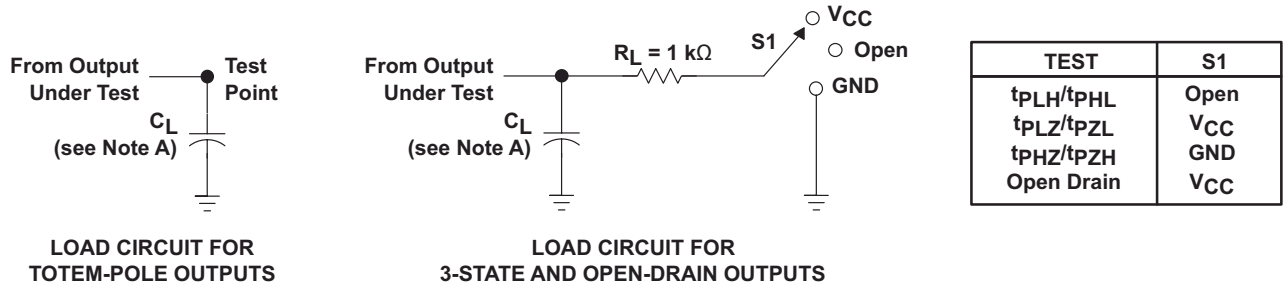

- A.  $C_L$  includes probe and jig capacitance.
- B. Waveform 1 is for an output with internal conditions such that the output is low except when disabled by the output control. Waveform 2 is for an output with internal conditions such that the output is high except when disabled by the output control.
- C. All input pulses are supplied by generators having the following characteristics:  $PRR \leq 1$  MHz,  $Z_O = 50 \Omega$ ,  $t_r \leq 3$  ns,  $t_f \leq 3$  ns.
- D. The outputs are measured one at a time with one input transition per measurement.
- E. All parameters and waveforms are not applicable to all devices.

图 6-1. Load Circuit and Voltage Waveforms

## 7 Detailed Description

### 7.1 Overview

The SN74AHC1G14 device is a single inverter gate. The device performs the Boolean function  $Y = \bar{A}$ .

The device functions as an independent inverter gate, but because of the Schmitt action, gates may have different input threshold levels for positive- ( $V_{T+}$ ) and negative-going ( $V_{T-}$ ) signals.

### 7.2 Functional Block Diagram



图 7-1. Logic Diagram (Positive Side)

### 7.3 Feature Description

The SN74AHC1G14 device has a wide operating  $V_{CC}$  range of 2 V to 5.5 V, which allows it to be used in a broad range of systems. The low propagation delay allows fast switching and higher speeds of operation. In addition, the low-power consumption makes this device a good choice for portable and battery power-sensitive applications.

### 7.4 Device Functional Modes

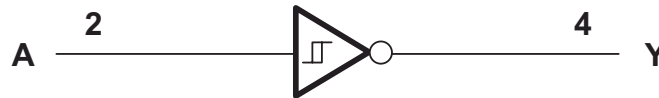
表 7-1 lists the functional modes for SN74AHC1G14.

表 7-1. Function Table

INPUT <sup>(1)</sup> A	OUTPUT <sup>(2)</sup> Y
H	L
L	H

- (1) H = High Voltage Level, L = Low Voltage Level, X = Don't Care
- (2) H = Driving High, L = Driving Low, Z = High Impedance State



## 8 Application and Implementation

### 备注

以下应用部分中的信息不属于 TI 器件规格的范围，TI 不担保其准确性和完整性。TI 的客户应负责确定器件是否适用于其应用。客户应验证并测试其设计，以确保系统功能。

### 8.1 Application Information

Physically interactive interface elements like push buttons or rotary knobs offer simple and easy ways to interact with an electronic system. Many of these physical interface elements often have issues with bouncing, or where the physical conductive contact can connect and disconnect multiple times during a button push or release. This bouncing can cause one or more faulty transient signals to be passed during this transitional period. These faulty signals can be observed in many common applications, for example, a television remote with bouncing error can adjust the TV channel multiple times despite the button being pushed only once. To mitigate these faulty signals, we can use a Schmitt-trigger, or a device with hysteresis, to remove these faulty signals. Hysteresis allows a device to *remember* its history, and in this case, the SN74AHC1G14 uses this memory to debounce the signal of the physical element, or filter the faulty transient signals and pass only the valid signal each time the element is used. In this example, we show a push-button signal passed through an SN74AHC1G14 that is debounced and inverted to the microprocessor for push detection.

### 8.2 Typical Application



图 8-1. Switch Debouncer

#### 8.2.1 Design Requirements

The SN74AHC1G14 device uses CMOS technology and has balanced output drive. Take care to avoid bus contention because it can drive currents that would exceed maximum limits. The SN74AHC1G14 allows for performing logical Boolean functions with hysteresis using digital signals. All input signals must remain as close as possible to either 0 V or VCC for optimal operation.

## 8.2.2 Detailed Design Procedure

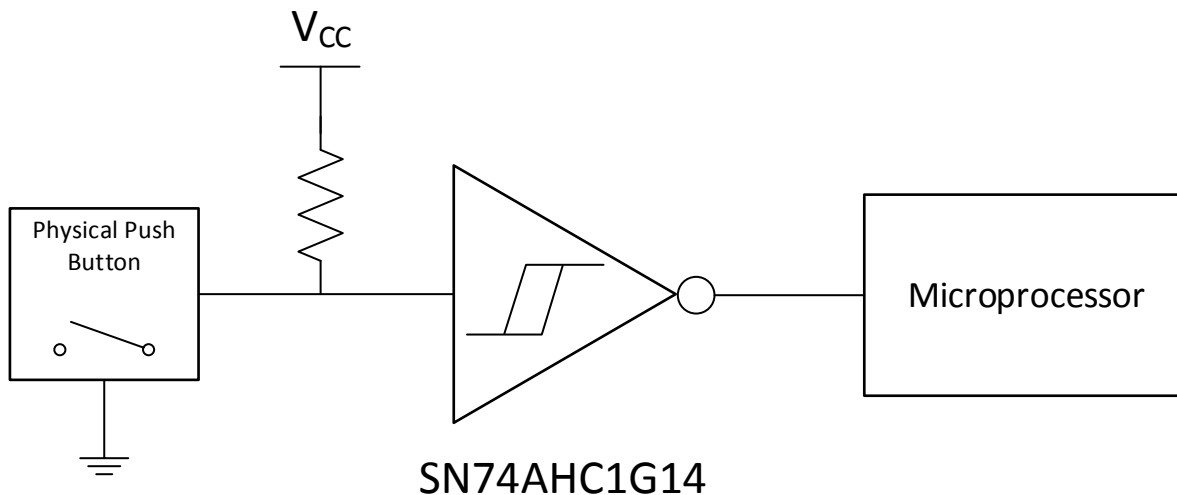
- Recommended input conditions:
  - For rise time and fall time specifications, see  $\Delta t/\Delta v$  in the [# 5.3](#) table.
  - For specified high and low levels, see  $V_{IH}$  and  $V_{IL}$  in the [# 5.3](#) table.
  - Inputs and outputs are overvoltage tolerant and can therefore go as high as 5.5 V at any valid  $V_{CC}$ .
- Recommended output conditions:
  - Load currents must not exceed  $\pm 50$  mA.
- Frequency selection criterion:
  - The effects of frequency upon the power consumption of the device can be studied in *CMOS Power Consumption and CPD Calculation*, [SCAA035](#).
  - Added trace resistance and capacitance can reduce maximum frequency capability; follow the layout practices listed in the [# 8.4.1](#) section.

## 8.2.3 Application Curves

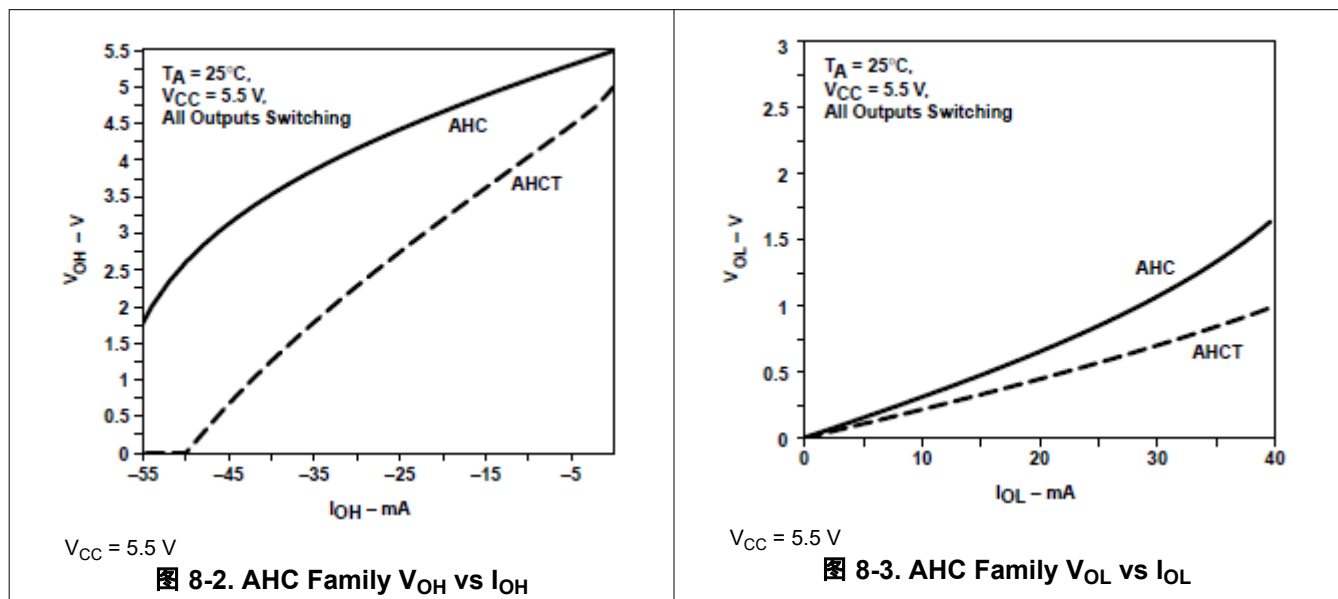

## 8.3 Power Supply Recommendations

The power supply can be any voltage between the minimum and maximum supply voltage rating listed in the [# 5.3](#) table.

Each  $V_{CC}$  terminal must have a good bypass capacitor to prevent power disturbance. For devices with a single supply, a 0.1- $\mu\text{F}$  bypass capacitor is recommended. If multiple pins are labeled  $V_{CC}$ , then a 0.01- $\mu\text{F}$  or 0.022- $\mu\text{F}$  capacitor is recommended for each  $V_{CC}$  because the  $V_{CC}$  pins are tied together internally. For devices with dual-supply pins operating at different voltages, for example  $V_{CC}$  and  $V_{DD}$ , a 0.1- $\mu\text{F}$  bypass capacitor is recommended for each supply pin. To reject different frequencies of noise, use multiple bypass capacitors in parallel. Capacitors with values of 0.1  $\mu\text{F}$  and 1  $\mu\text{F}$  are commonly used in parallel. The bypass capacitor must be installed as close as possible to the power terminal for best results.

## 8.4 Layout

### 8.4.1 Layout Guidelines

Reflections and matching are closely related to the loop antenna theory but are different enough to be discussed separately from the theory. When a PCB trace turns a corner at a  $90^\circ$  angle, a reflection can occur. A reflection occurs primarily because of the change of width of the trace. At the apex of the turn, the trace width increases to 1.414 times the width. This increase upsets the transmission-line characteristics, especially the distributed

capacitance and self-inductance of the trace, which results in the reflection. Not all PCB traces can be straight; therefore some traces must turn corners. 图 8-4 shows progressively better techniques of rounding corners. Only the last example (BEST) maintains constant trace width and minimizes reflections.

**8.4.1.1 Layout Example**



图 8-4. Trace Example

## 9 Device and Documentation Support

### 9.1 Documentation Support (Analog)

#### 9.1.1 Related Documentation

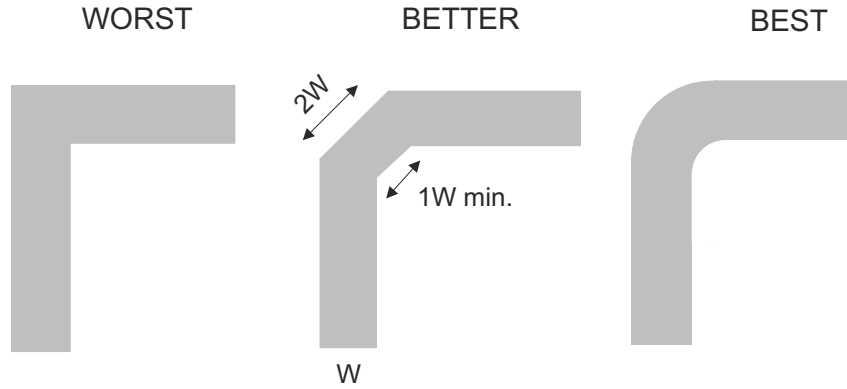
For related documentation see the following:

- *Implications of Slow or Floating CMOS Inputs*, [SCBA004](#)
- *CMOS Power Consumption and CPD Calculation*, [SCAA035](#)
- *Selecting the Right Texas Instruments Signal Switch*, [SZZA030](#)

### 9.2 支持资源

[TI E2E™ 中文支持论坛](#) 是工程师的重要参考资料，可直接从专家处获得快速、经过验证的解答和设计帮助。搜索现有解答或提出自己的问题，获得所需的快速设计帮助。

链接的内容由各个贡献者“按原样”提供。这些内容并不构成 TI 技术规范，并且不一定反映 TI 的观点；请参阅 TI 的[使用条款](#)。

### 9.3 Trademarks

TI E2E™ is a trademark of Texas Instruments.  
所有商标均为其各自所有者的财产。

### 9.4 静电放电警告



静电放电 (ESD) 会损坏这个集成电路。德州仪器 (TI) 建议通过适当的预防措施处理所有集成电路。如果不遵守正确的处理和安装程序，可能会损坏集成电路。

ESD 的损坏小至导致微小的性能降级，大至整个器件故障。精密的集成电路可能更容易受到损坏，这是因为非常细微的参数更改都可能会导致器件与其发布的规格不相符。

### 9.5 术语表

#### TI 术语表

本术语表列出并解释了术语、首字母缩略词和定义。

## 10 Revision History

注：以前版本的页码可能与当前版本的页码不同

Changes from Revision R (October 2023) to Revision S (February 2024)	Page
• Updated thermal values for DBV package from R $\theta$ JA = 225.7 to 278, R $\theta$ JC(top) = 160.3 to 180.5, R $\theta$ JB = 59.4 to 184.4, $\Psi$ JT = 41.0 to 115.4, $\Psi$ JB = 58.7 to 183.4, R $\theta$ JC(bot) = N/A, all values in °C/W .....	5

Changes from Revision Q (February 2014) to Revision R (October 2023)	Page
• 更新了整个文档中的表格、图和交叉参考的编号格式.....	1
• Updated thermal values for DCK package: R $\theta$ JA = 287.6 to 289.2, all values in °C/W .....	5
• Added thermal values for DCK package: R $\theta$ JC(top) = 205.8, R $\theta$ JB = 176.2, $\Psi$ JT = 117.6, $\Psi$ JB = 175.1, R $\theta$ JC(bot) = N/A, all values in °C/W .....	5

## 11 Mechanical, Packaging, and Orderable Information

The following pages include mechanical packaging and orderable information. This information is the most current data available for the designated devices. This data is subject to change without notice and revision of this document. For browser based versions of this data sheet, refer to the left hand navigation.

**PACKAGING INFORMATION**

Orderable Device	Status (1)	Package Type	Package Drawing	Pins	Package Qty	Eco Plan (2)	Lead finish/ Ball material (6)	MSL Peak Temp (3)	Op Temp (°C)	Device Marking (4/5)	Samples
SN74AHC1G14DBVR	ACTIVE	SOT-23	DBV	5	3000	RoHS & Green	SN	Level-1-260C-UNLIM	-40 to 125	(38SH, A143, A14G, A14J, A14L, A14S)	<a href="#">Samples</a>
SN74AHC1G14DBVRE4	ACTIVE	SOT-23	DBV	5	3000	RoHS & Green	NIPDAU	Level-1-260C-UNLIM	-40 to 125	(3C1F, A14G)	<a href="#">Samples</a>
SN74AHC1G14DBVRG4	ACTIVE	SOT-23	DBV	5	3000	RoHS & Green	NIPDAU	Level-1-260C-UNLIM	-40 to 125	(3C1F, A14G)	<a href="#">Samples</a>
SN74AHC1G14DBVT	OBSOLETE	SOT-23	DBV	5		TBD	Call TI	Call TI	-40 to 125	(A143, A14G, A14J, A14S)	
SN74AHC1G14DCK3	ACTIVE	SC70	DCK	5	3000	RoHS & Non-Green	SNBI	Level-1-260C-UNLIM	-40 to 125	AFY	<a href="#">Samples</a>
SN74AHC1G14DCKR	ACTIVE	SC70	DCK	5	3000	RoHS & Green	SN	Level-1-260C-UNLIM	-40 to 125	(1R9, AF3, AFG, AFJ, AFL, AFS)	<a href="#">Samples</a>
SN74AHC1G14DCKRG4	ACTIVE	SC70	DCK	5	3000	RoHS & Green	Call TI	Call TI	-40 to 125	AF3	<a href="#">Samples</a>
SN74AHC1G14DCKT	OBSOLETE	SC70	DCK	5		TBD	Call TI	Call TI	-40 to 125	(AF3, AFG, AFJ, AFS)	
SN74AHC1G14DCKTE4	ACTIVE	SC70	DCK	5	250	RoHS & Green	NIPDAU	Level-1-260C-UNLIM	-40 to 125	AF3	<a href="#">Samples</a>
SN74AHC1G14DCKTG4	ACTIVE	SC70	DCK	5	250	RoHS & Green	NIPDAU	Level-1-260C-UNLIM	-40 to 125	AF3	<a href="#">Samples</a>
SN74AHC1G14DRLR	ACTIVE	SOT-5X3	DRL	5	4000	RoHS & Green	NIPDAUAG	Level-1-260C-UNLIM	-40 to 125	AFS	<a href="#">Samples</a>
SN74AHC1G14DRLRG4	ACTIVE	SOT-5X3	DRL	5	4000	RoHS & Green	NIPDAUAG	Level-1-260C-UNLIM	-40 to 125	AFS	<a href="#">Samples</a>

(1) The marketing status values are defined as follows:

**ACTIVE:** Product device recommended for new designs.

**LIFEBUY:** TI has announced that the device will be discontinued, and a lifetime-buy period is in effect.

**NRND:** Not recommended for new designs. Device is in production to support existing customers, but TI does not recommend using this part in a new design.

**PREVIEW:** Device has been announced but is not in production. Samples may or may not be available.

**OBSOLETE:** TI has discontinued the production of the device.

(2) **RoHS:** TI defines "RoHS" to mean semiconductor products that are compliant with the current EU RoHS requirements for all 10 RoHS substances, including the requirement that RoHS substance do not exceed 0.1% by weight in homogeneous materials. Where designed to be soldered at high temperatures, "RoHS" products are suitable for use in specified lead-free processes. TI may reference these types of products as "Pb-Free".

**RoHS Exempt:** TI defines "RoHS Exempt" to mean products that contain lead but are compliant with EU RoHS pursuant to a specific EU RoHS exemption.

**Green:** TI defines "Green" to mean the content of Chlorine (Cl) and Bromine (Br) based flame retardants meet JS709B low halogen requirements of  $\leq 1000$ ppm threshold. Antimony trioxide based flame retardants must also meet the  $\leq 1000$ ppm threshold requirement.

- (3) MSL, Peak Temp. - The Moisture Sensitivity Level rating according to the JEDEC industry standard classifications, and peak solder temperature.
- (4) There may be additional marking, which relates to the logo, the lot trace code information, or the environmental category on the device.
- (5) Multiple Device Markings will be inside parentheses. Only one Device Marking contained in parentheses and separated by a "~" will appear on a device. If a line is indented then it is a continuation of the previous line and the two combined represent the entire Device Marking for that device.
- (6) Lead finish/Ball material - Orderable Devices may have multiple material finish options. Finish options are separated by a vertical ruled line. Lead finish/Ball material values may wrap to two lines if the finish value exceeds the maximum column width.

**Important Information and Disclaimer:** The information provided on this page represents TI's knowledge and belief as of the date that it is provided. TI bases its knowledge and belief on information provided by third parties, and makes no representation or warranty as to the accuracy of such information. Efforts are underway to better integrate information from third parties. TI has taken and continues to take reasonable steps to provide representative and accurate information but may not have conducted destructive testing or chemical analysis on incoming materials and chemicals. TI and TI suppliers consider certain information to be proprietary, and thus CAS numbers and other limited information may not be available for release.

In no event shall TI's liability arising out of such information exceed the total purchase price of the TI part(s) at issue in this document sold by TI to Customer on an annual basis.

**OTHER QUALIFIED VERSIONS OF SN74AHC1G14 :**

- Automotive : [SN74AHC1G14-Q1](#)

NOTE: Qualified Version Definitions:

- Automotive - Q100 devices qualified for high-reliability automotive applications targeting zero defects

**TAPE AND REEL INFORMATION**

**QUADRANT ASSIGNMENTS FOR PIN 1 ORIENTATION IN TAPE**

\*All dimensions are nominal

Device	Package Type	Package Drawing	Pins	SPQ	Reel Diameter (mm)	Reel Width W1 (mm)	A0 (mm)	B0 (mm)	K0 (mm)	P1 (mm)	W (mm)	Pin1 Quadrant
SN74AHC1G14DBVR	SOT-23	DBV	5	3000	180.0	8.4	3.2	3.2	1.4	4.0	8.0	Q3
SN74AHC1G14DBVRG4	SOT-23	DBV	5	3000	178.0	9.0	3.23	3.17	1.37	4.0	8.0	Q3
SN74AHC1G14DCKR	SC70	DCK	5	3000	180.0	8.4	2.3	2.5	1.2	4.0	8.0	Q3
SN74AHC1G14DCKTG4	SC70	DCK	5	250	178.0	9.2	2.4	2.4	1.22	4.0	8.0	Q3
SN74AHC1G14DRLR	SOT-5X3	DRL	5	4000	180.0	8.4	1.98	1.78	0.69	4.0	8.0	Q3

## TAPE AND REEL BOX DIMENSIONS



\*All dimensions are nominal

Device	Package Type	Package Drawing	Pins	SPQ	Length (mm)	Width (mm)	Height (mm)
SN74AHC1G14DBVR	SOT-23	DBV	5	3000	210.0	185.0	35.0
SN74AHC1G14DBVRG4	SOT-23	DBV	5	3000	180.0	180.0	18.0
SN74AHC1G14DCKR	SC70	DCK	5	3000	210.0	185.0	35.0
SN74AHC1G14DCKTG4	SC70	DCK	5	250	180.0	180.0	18.0
SN74AHC1G14DRLR	SOT-5X3	DRL	5	4000	202.0	201.0	28.0



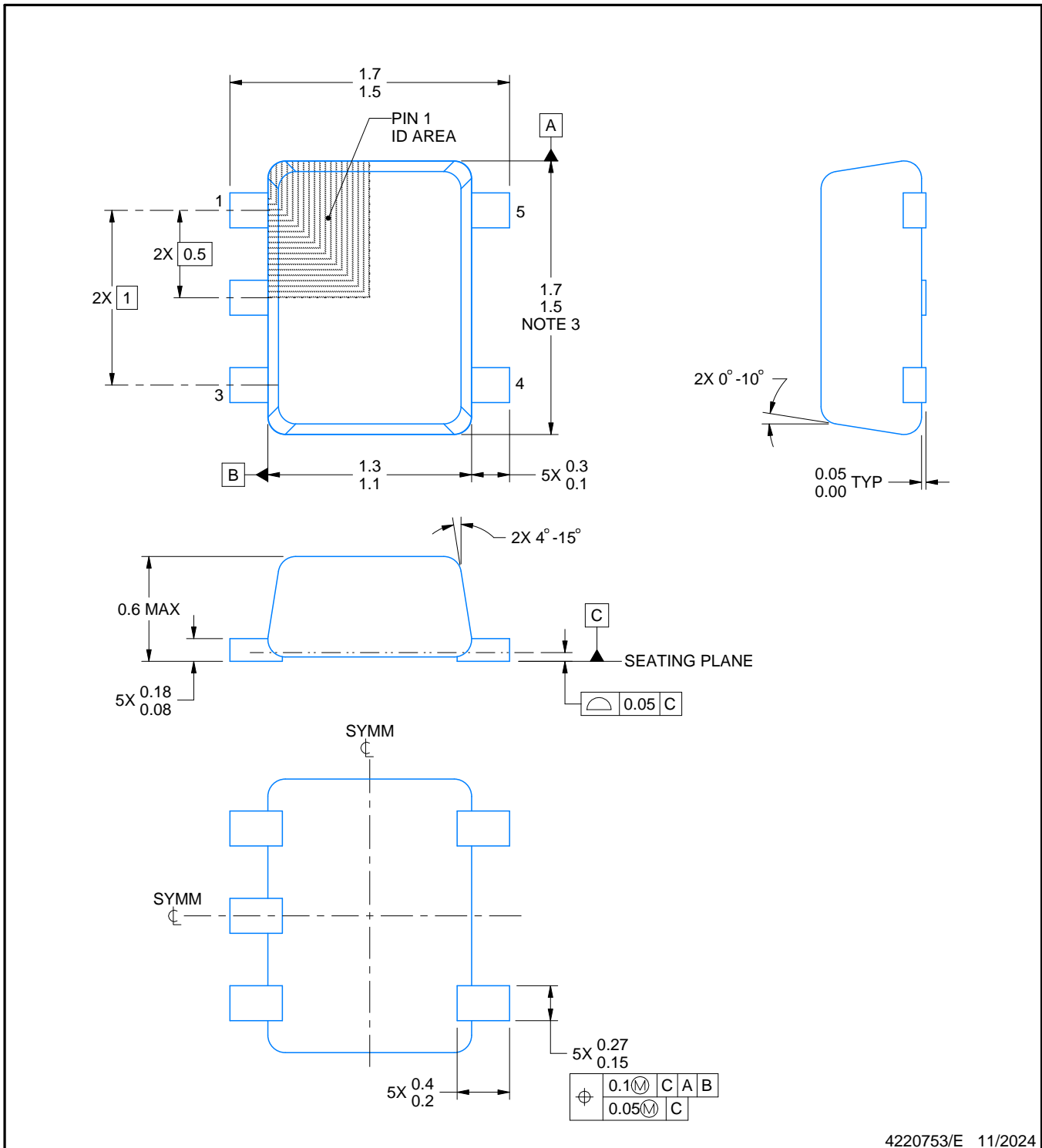
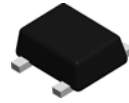

4220753/E 11/2024

NOTES:

1. All linear dimensions are in millimeters. Any dimensions in parenthesis are for reference only. Dimensioning and tolerancing per ASME Y14.5M.
2. This drawing is subject to change without notice.
3. This dimension does not include mold flash, protrusions, or gate burrs. Mold flash, protrusions, or gate burrs shall not exceed 0.15 mm per side.
4. Reference JEDEC registration MO-293 Variation UAAD-1

# EXAMPLE BOARD LAYOUT

DRL0005A

SOT - 0.6 mm max height

PLASTIC SMALL OUTLINE

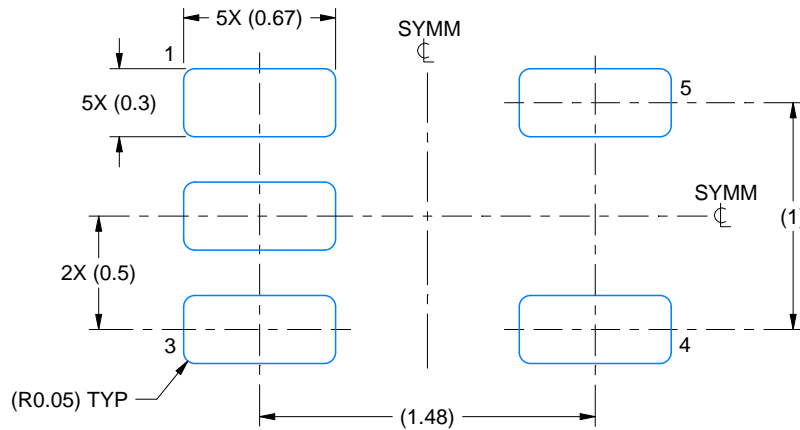

LAND PATTERN EXAMPLE  
SCALE:30X

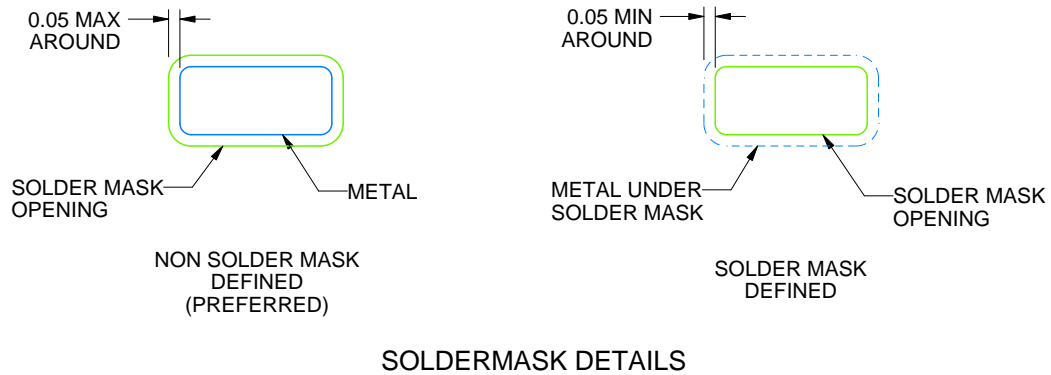

SOLDERMASK DETAILS

4220753/E 11/2024

NOTES: (continued)

- 5. Publication IPC-7351 may have alternate designs.
- 6. Solder mask tolerances between and around signal pads can vary based on board fabrication site.

# EXAMPLE STENCIL DESIGN

DRL0005A

SOT - 0.6 mm max height

PLASTIC SMALL OUTLINE

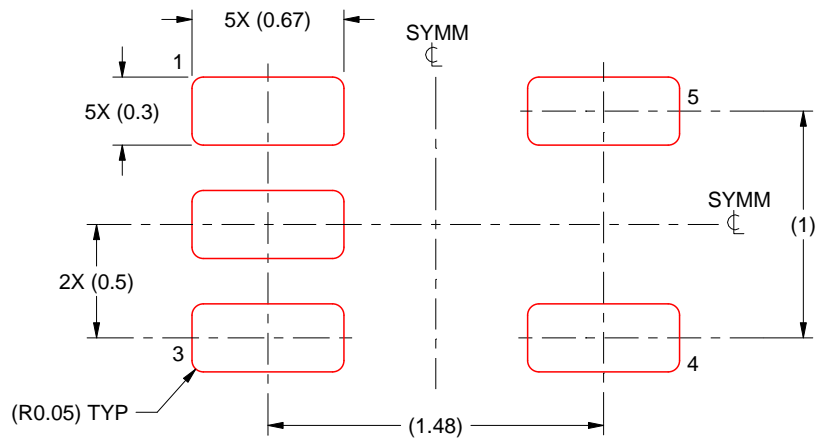

SOLDER PASTE EXAMPLE  
BASED ON 0.1 mm THICK STENCIL  
SCALE:30X

4220753/E 11/2024

NOTES: (continued)

7. Laser cutting apertures with trapezoidal walls and rounded corners may offer better paste release. IPC-7525 may have alternate design recommendations.
8. Board assembly site may have different recommendations for stencil design.

# DCK0005A



# PACKAGE OUTLINE

SOT - 1.1 max height

SMALL OUTLINE TRANSISTOR

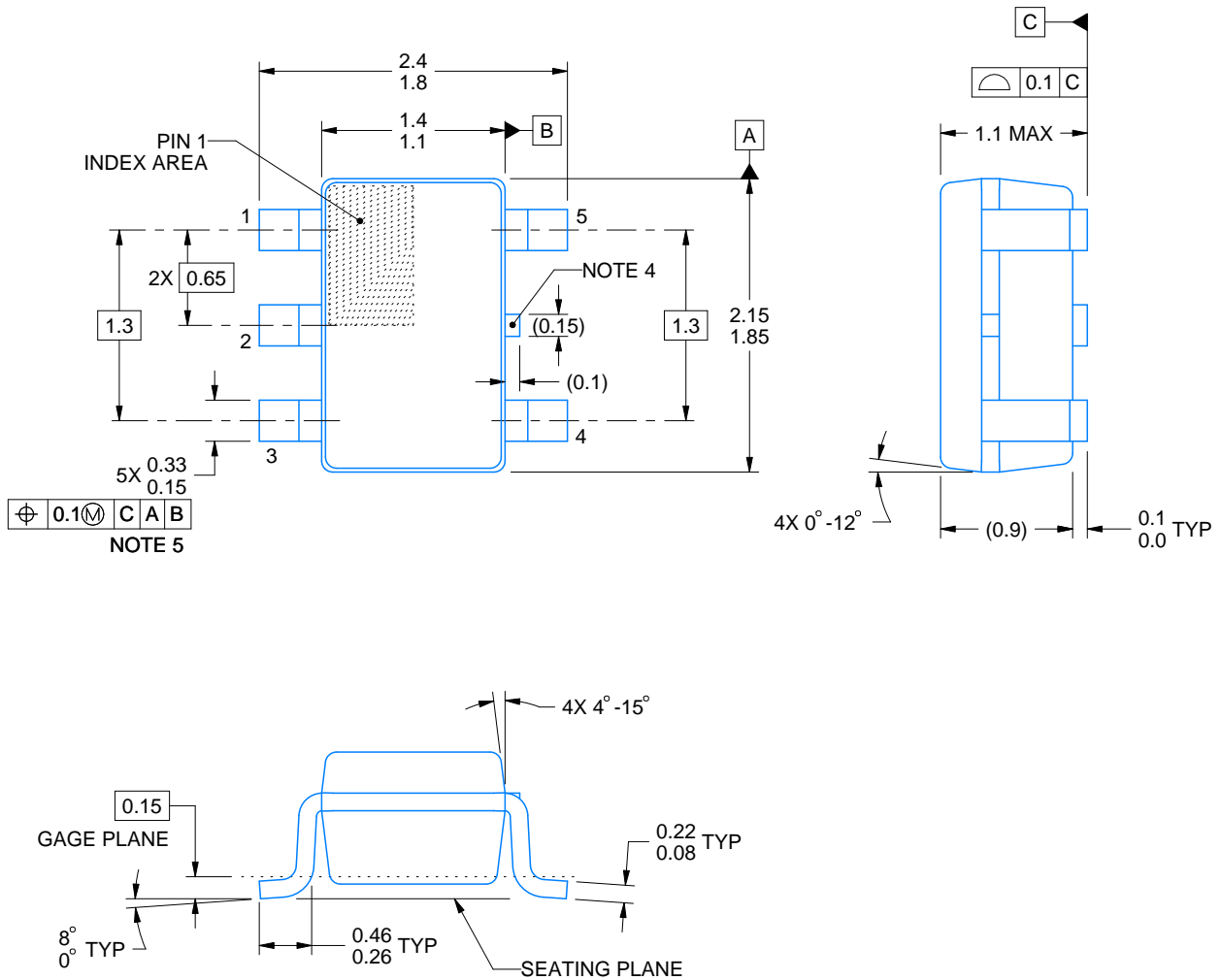

4214834/G 11/2024

**NOTES:**

1. All linear dimensions are in millimeters. Any dimensions in parenthesis are for reference only. Dimensioning and tolerancing per ASME Y14.5M.
2. This drawing is subject to change without notice.
3. Reference JEDEC MO-203.
4. Support pin may differ or may not be present.
5. Lead width does not comply with JEDEC.
6. Body dimensions do not include mold flash, protrusions, or gate burrs. Mold flash, protrusions, or gate burrs shall not exceed 0.25mm per side

# EXAMPLE BOARD LAYOUT

DCK0005A

SOT - 1.1 max height

SMALL OUTLINE TRANSISTOR



LAND PATTERN EXAMPLE  
EXPOSED METAL SHOWN  
SCALE:18X

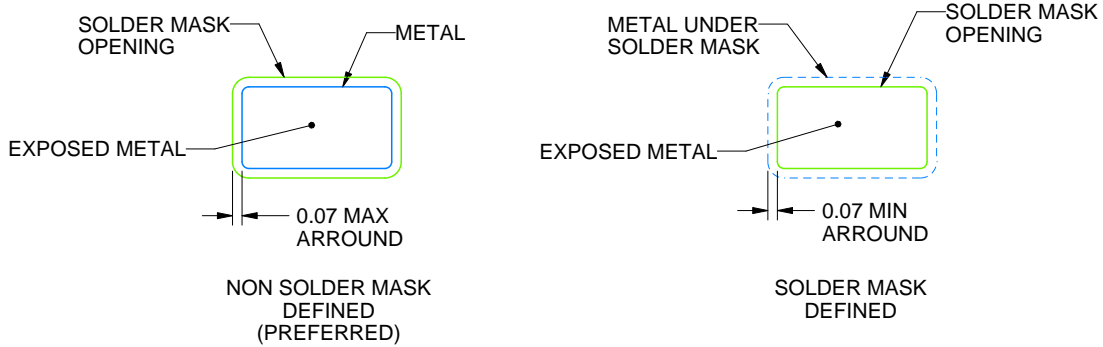

SOLDER MASK DETAILS

4214834/G 11/2024

NOTES: (continued)

- 7. Publication IPC-7351 may have alternate designs.
- 8. Solder mask tolerances between and around signal pads can vary based on board fabrication site.

# EXAMPLE STENCIL DESIGN

DCK0005A

SOT - 1.1 max height

SMALL OUTLINE TRANSISTOR



SOLDER PASTE EXAMPLE  
BASED ON 0.125 THICK STENCIL  
SCALE: 18X

4214834/G 11/2024

NOTES: (continued)

9. Laser cutting apertures with trapezoidal walls and rounded corners may offer better paste release. IPC-7525 may have alternate design recommendations.
10. Board assembly site may have different recommendations for stencil design.

# DBV0005A



## PACKAGE OUTLINE

SOT-23 - 1.45 mm max height

SMALL OUTLINE TRANSISTOR

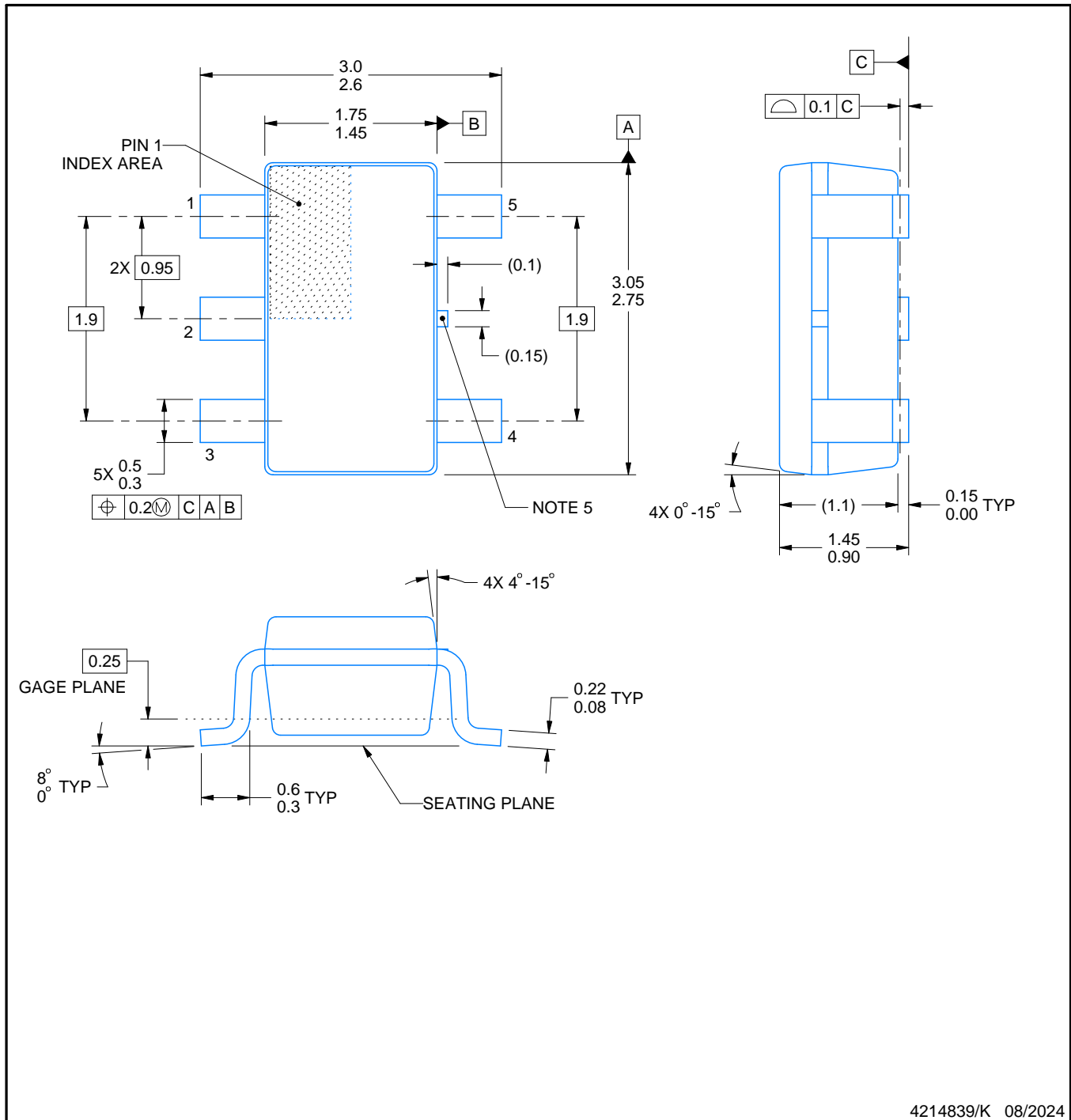

### NOTES:

1. All linear dimensions are in millimeters. Any dimensions in parenthesis are for reference only. Dimensioning and tolerancing per ASME Y14.5M.
2. This drawing is subject to change without notice.
3. Reference JEDEC MO-178.
4. Body dimensions do not include mold flash, protrusions, or gate burrs. Mold flash, protrusions, or gate burrs shall not exceed 0.25 mm per side.
5. Support pin may differ or may not be present.

# EXAMPLE BOARD LAYOUT

DBV0005A

SOT-23 - 1.45 mm max height

SMALL OUTLINE TRANSISTOR



LAND PATTERN EXAMPLE  
EXPOSED METAL SHOWN  
SCALE:15X



SOLDER MASK DETAILS

4214839/K 08/2024

NOTES: (continued)

- 6. Publication IPC-7351 may have alternate designs.
- 7. Solder mask tolerances between and around signal pads can vary based on board fabrication site.



# EXAMPLE STENCIL DESIGN

DBV0005A

SOT-23 - 1.45 mm max height

SMALL OUTLINE TRANSISTOR



SOLDER PASTE EXAMPLE  
BASED ON 0.125 mm THICK STENCIL  
SCALE:15X

4214839/K 08/2024

NOTES: (continued)

8. Laser cutting apertures with trapezoidal walls and rounded corners may offer better paste release. IPC-7525 may have alternate design recommendations.
9. Board assembly site may have different recommendations for stencil design.

## 重要通知和免责声明

TI“按原样”提供技术和可靠性数据（包括数据表）、设计资源（包括参考设计）、应用或其他设计建议、网络工具、安全信息和其他资源，不保证没有瑕疵且不做任何明示或暗示的担保，包括但不限于对适销性、某特定用途方面的适用性或不侵犯任何第三方知识产权的暗示担保。

这些资源可供使用 TI 产品进行设计的熟练开发人员使用。您将自行承担以下全部责任：(1) 针对您的应用选择合适的 TI 产品，(2) 设计、验证并测试您的应用，(3) 确保您的应用满足相应标准以及任何其他功能安全、信息安全、监管或其他要求。

这些资源如有变更，恕不另行通知。TI 授权您仅可将这些资源用于研发本资源所述的 TI 产品的相关应用。严禁以其他方式对这些资源进行复制或展示。您无权使用任何其他 TI 知识产权或任何第三方知识产权。您应全额赔偿因在这些资源的使用中对 TI 及其代表造成的任何索赔、损害、成本、损失和债务，TI 对此概不负责。

TI 提供的产品受 [TI 的销售条款](#) 或 [ti.com](#) 上其他适用条款/TI 产品随附的其他适用条款的约束。TI 提供这些资源并不会扩展或以其他方式更改 TI 针对 TI 产品发布的适用的担保或担保免责声明。

TI 反对并拒绝您可能提出的任何其他或不同的条款。

邮寄地址：Texas Instruments, Post Office Box 655303, Dallas, Texas 75265  
版权所有 © 2025，德州仪器 (TI) 公司