

# SN74AHCT244Q 具有三态输出的八路缓冲器/驱动器

## 1 特性

- Q 器件满足汽车性能要求
- 可支持客户特殊配置控制与重大变更批准
- EPIC™ (增强性能植入式 CMOS) 工艺
- 输入兼容 TTL 电压；闩锁性能超过 250mA，符合 JESD 17 规范

## 2 说明

该八路缓冲器/驱动器专门设计用于提高三态存储器地址驱动器、时钟驱动器以及总线导向接收器和发送器的性能和密度。

### 封装信息

器件型号	封装 <sup>1</sup>	封装尺寸 (标称值)
SN74AHCT244Q	DW (SOIC, 20)	12.80mm × 7.50mm
	PW (TSSOP, 20)	6.5mm × 4.4mm

1. 如需了解所有可用封装，请参阅数据表末尾的可订购产品附录。

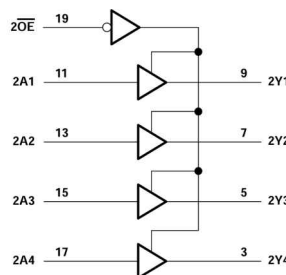
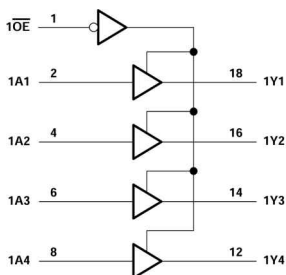

## Table of Contents

<b>1 特性</b> .....	1	5.5 Switching Characteristics.....	5
<b>2 说明</b> .....	1	5.6 Noise Characteristics.....	6
<b>3 Revision History</b> .....	2	5.7 Operating Characteristics.....	6
<b>4 Pin Configuration and Functions</b> .....	3	<b>6 Parameter Measurement Information</b> .....	7
<b>5 Specifications</b> .....	4	<b>7 Detailed Description</b> .....	8
5.1 Absolute Maximum Ratings.....	4	7.1 Overview.....	8
5.2 Recommended Operating Conditions.....	4	7.2 Functional Block Diagram.....	8
5.3 Thermal Information.....	4	7.3 Device Functional Modes.....	8
5.4 Electrical Characteristics.....	5		

### 3 Revision History

注：以前版本的页码可能与当前版本的页码不同

<b>Changes from Revision * (February 2002) to Revision A (May 2023)</b>	<b>Page</b>
• 添加了封装信息表、引脚功能表和热性能信息表.....	1

## 4 Pin Configuration and Functions



图 4-1. DW or PW Package (Top View)

### Pin Functions

PIN		I/O1	DESCRIPTION
Name	NO.		
1OE	1	I	Bank 1, output enable, active low
1A1	2	I	Bank 1, channel 1 input
2Y4	3	O	Bank 2, channel 4 output
1A2	4	I	Bank 1, channel 2 input
2Y3	5	O	Bank 2, channel 3 output
1A3	6	I	Bank 1, channel 3 input
2Y2	7	O	Bank 2, channel 2 output
1A4	8	I	Bank 1, channel 4 input
2Y1	9	O	Bank 2, channel 1 output
GND	10	—	Ground
2A1	11	I	Bank 2, channel 1 input
1Y4	12	O	Bank 1, channel 4 output
2A2	13	I	Bank 2, channel 2 input
1Y3	14	O	Bank 1, channel 3 output
2A3	15	I	Bank 2, channel 3 input
1Y2	16	O	Bank 1, channel 2 output
2A4	17	I	Bank 2, channel 4 input
1Y1	18	O	Bank 1, channel 1 output
2OE	19	I	Bank 2, output enable, active low
V <sub>CC</sub>	20	—	Positive supply

## 5 Specifications

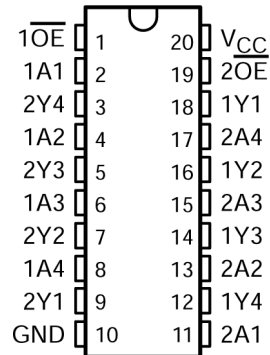
### 5.1 Absolute Maximum Ratings

over operating free-air temperature range (unless otherwise noted)<sup>(1)</sup>

		MIN	MAX	UNIT
V <sub>CC</sub>	Supply voltage range	- 0.5	7	V
V <sub>I</sub> <sup>(1)</sup>	Input voltage range	- 0.5	7	V
V <sub>O</sub> <sup>(1)</sup>	Output voltage range	- 0.5	V <sub>CC</sub> + 0.5	V
I <sub>IK</sub>	Input clamp current (V <sub>I</sub> < 0)		- 20	mA
I <sub>OK</sub>	Output clamp current (V <sub>O</sub> < 0 or V <sub>O</sub> > V <sub>CC</sub> )		±20	mA
I <sub>O</sub>	Continuous output current (V <sub>O</sub> = 0 to V <sub>CC</sub> )		±25	mA
	Continuous current through V <sub>CC</sub> or GND		±75	mA
T <sub>stg</sub>	Storage temperature range	- 65	150	°C

- Stresses beyond those listed under “absolute maximum ratings” may cause permanent damage to the device. These are stress ratings only, and functional operation of the device at these or any other conditions beyond those indicated under “recommended operating conditions” is not implied. Exposure to absolute-maximum-rated conditions for extended periods may affect device reliability.
- The input and output voltage ratings may be exceeded if the input and output current ratings are observed.

### 5.2 Recommended Operating Conditions

(see [Note 1](#))

		MIN	MAX	UNIT
V <sub>CC</sub>	Supply voltage	4.5	5.5	V
V <sub>IH</sub>	High-level input voltage	2		V
V <sub>IL</sub>	Low-level input voltage		0.8	V
V <sub>I</sub>	Input voltage	0	5.5	V
V <sub>O</sub>	Output voltage	0	V <sub>CC</sub>	V
I <sub>OH</sub>	High-level output current		- 8	mA
I <sub>OL</sub>	Low-level output current		8	mA
T <sub>A</sub>	Operating free-air temperature	- 40	125	°C

- All unused inputs of the device must be held at V<sub>CC</sub> or GND to ensure proper device operation. Refer to the TI application report, *Implications of Slow or Floating CMOS Inputs*, literature number SCBA004.

### 5.3 Thermal Information

THERMAL METRIC <sup>(1)</sup>	SN74AHCT244Q		UNIT	
	DW (SOIC)	PW (TSSOP)		
	20 PINS	20 PINS		
R <sub>θJA</sub>	Junction-to-ambient thermal resistance	58	83	°C/W

- For more information about traditional and new thermal metrics, see [Semiconductor and IC Package Thermal Metrics](#).

## 5.4 Electrical Characteristics

over recommended operating free-air temperature range (unless otherwise noted)

PARAMETER	TEST CONDITIONS	V <sub>CC</sub>	T <sub>A</sub> = 25°C			MIN	MAX	UNIT
			MIN	TYP	MAX			
V <sub>OH</sub>	I <sub>OH</sub> = -50 μA	4.5 V	4.4	4.5		4.4		V
	I <sub>OH</sub> = -8 mA					3.8		
V <sub>OL</sub>	I <sub>OL</sub> = 50 μA	4.5 V			0.1		0.1	V
	I <sub>OL</sub> = 8 mA				0.36		0.44	
I <sub>OZ</sub>	V <sub>O</sub> = V <sub>CC</sub> or GND	5.5 V			±0.25		±2.5	μA
I <sub>I</sub>	V <sub>I</sub> = 5.5 V or GND	0 V to 5.5 V			±0.1		±1	μA
I <sub>CC</sub>	V <sub>I</sub> = V <sub>CC</sub> or GND, I <sub>O</sub> = 0	5.5 V			4		40	μA
ΔI <sub>CC</sub> <sup>(1)</sup>	One input at 3.4 V, Other inputs at V <sub>CC</sub> or GND	5.5 V			1.35		1.5	mA
C <sub>i</sub>	V <sub>I</sub> = V <sub>CC</sub> or GND	5 V		2.5	10			pF
C <sub>O</sub>	V <sub>O</sub> = V <sub>CC</sub> or gnd	5 V		3				pF

(1) This is the increase in supply current for each input at one of the specified TTL voltage levels rather than 0 V or V<sub>CC</sub>.

## 5.5 Switching Characteristics

over recommended operating free-air temperature range, V<sub>CC</sub> = 5 V ± 0.5 V (unless otherwise noted) (see [Fig 6-1](#))

PARAMETER	FROM (INPUT)	TO (OUTPUT)	LOAD CAPACITANCE	T <sub>A</sub> = 25°C			MIN	MAX	UNIT
				MIN	TYP	MAX			
t <sub>PLH</sub>	A	Y	C <sub>L</sub> = 15 pF		5.4	7.4	1	8.5	ns
t <sub>PHL</sub>					5.4	7.4	1	8.5	
t <sub>PZH</sub>	OE	Y	C <sub>L</sub> = 15 pF		7.7	10.4	1	12	ns
t <sub>PZL</sub>					7.7	10.4	1	12	
t <sub>PHZ</sub>	OE	Y	C <sub>L</sub> = 15 pF		5	9.4	1	10	ns
t <sub>PLZ</sub>					5	9.4	1	10	
t <sub>PLH</sub>	A	Y	C <sub>L</sub> = 50 pF		5.9	8.4	1	9.5	ns
t <sub>PHL</sub>					5.9	8.4	1	9.5	
t <sub>PZH</sub>	OE	Y	C <sub>L</sub> = 50 pF		8.2	11.4	1	13	ns
t <sub>PZL</sub>					8.2	11.4	1	13	
t <sub>PHZ</sub>	OE	Y	C <sub>L</sub> = 50 pF		8.8	11.4	1	13	ns
t <sub>PLZ</sub>					8.8	11.4	1	13	
t <sub>sk(o)</sub>			C <sub>L</sub> = 50 pF			1		ns	

## 5.6 Noise Characteristics

$V_{CC} = 5\text{ V}$ ,  $C_L = 50\text{ pF}$ ,  $T_A = 25^\circ\text{C}$  (see [Note 1](#))

PARAMETER		MIN	TYP	MAX	UNIT
$V_{OH(V)}$	Quiet output, minimum dynamic $V_{OH}$		4.1		V
$V_{IH(D)}$	High-level dynamic input voltage	2			V
$V_{IL(D)}$	Low-level dynamic input voltage			0.8	V

(1) Characteristics are for surface-mount packages only.

## 5.7 Operating Characteristics

$V_{CC} = 5\text{ V}$ ,  $T_A = 25^\circ\text{C}$

PARAMETER	TEST CONDITIONS	TYP	UNIT
$C_{pd}$	No load, $f = 1\text{ MHz}$	8.2	pF

## 6 Parameter Measurement Information

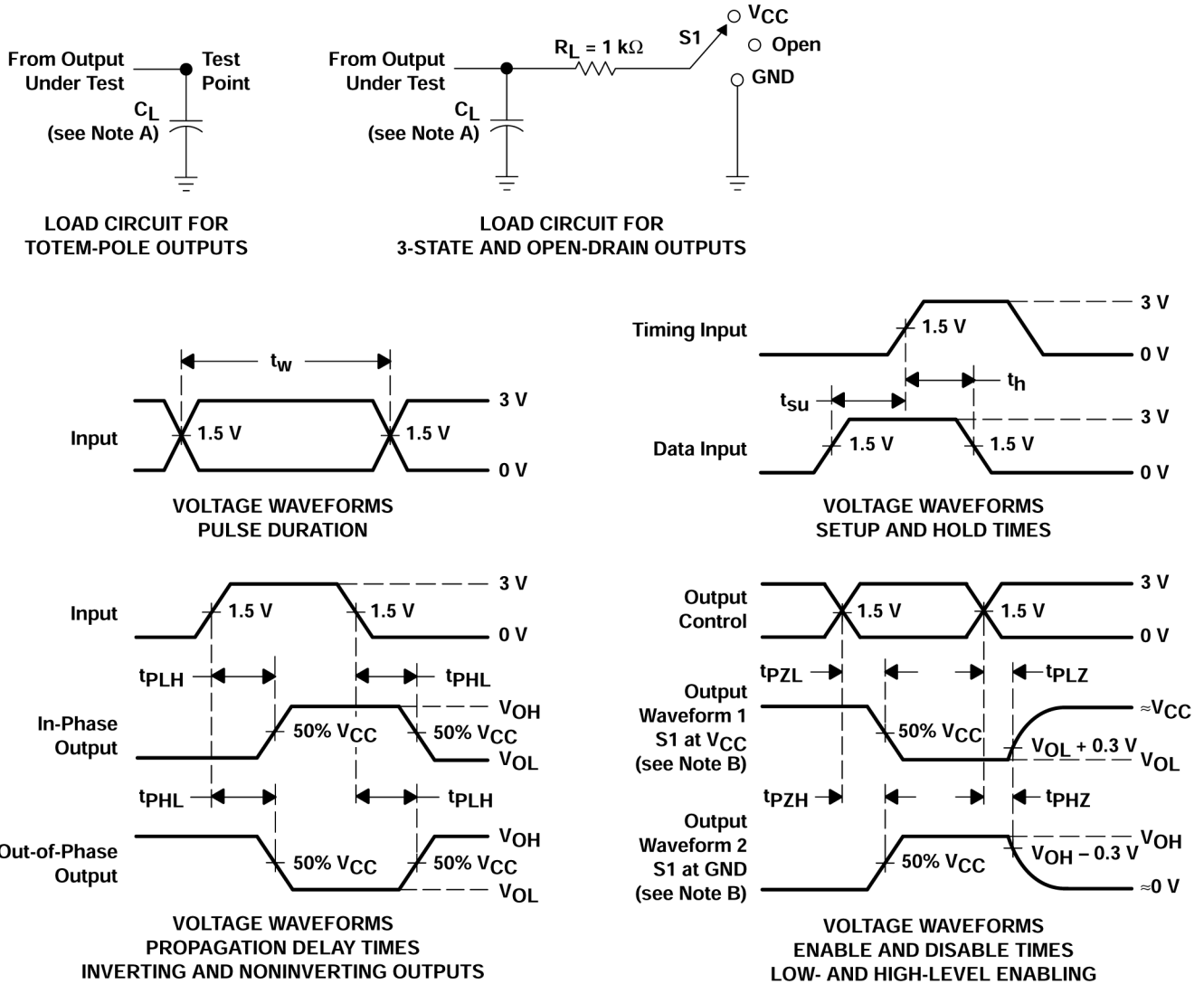

- A.  $C_L$  includes probe and jig capacitance.
- B. Waveform 1 is for an output with internal conditions such that the output is low except when disabled by the output control. Waveform 2 is for an output with internal conditions such that the output is high except when disabled by the output control.
- C. All input pulses are supplied by generators having the following characteristics:  $PRR \leq 1$  MHz,  $Z_O = 50 \Omega$ ,  $t_r \leq 3$  ns,  $t_f \leq 3$  ns.
- D. The outputs are measured one at a time with one input transition per measurement.

图 6-1. Load Circuit and Voltage Waveforms

TEST	S1
$t_{PLH}/t_{PHL}$	Open
$t_{PLZ}/t_{PZL}$	$V_{CC}$
$t_{PHZ}/t_{PZH}$	GND
Open Drain	$V_{CC}$

## 7 Detailed Description

### 7.1 Overview

The SN74AHCT244Q is organized as two 4-bit buffers/line drivers with separate output-enable ( $\overline{OE}$ ) inputs. When  $\overline{OE}$  is low, the device passes data from the A inputs to the Y outputs. When  $\overline{OE}$  is high, the outputs are in the high-impedance state.

To ensure the high-impedance state during power up or power down,  $\overline{OE}$  should be tied to  $V_{CC}$  through a pullup resistor; the minimum value of the resistor is determined by the current-sinking capability of the driver.

### 7.2 Functional Block Diagram



图 7-1. Logic Diagram (Positive Logic)

This symbol is in accordance with ANSI/IEEE Std 91-1984 and IEC Publication 617-12.

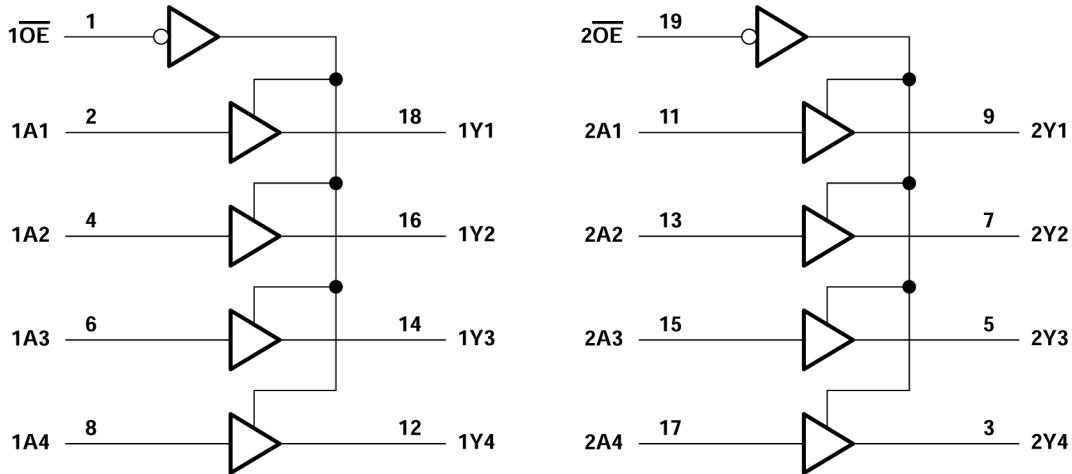

图 7-2. Logic Symbol

### 7.3 Device Functional Modes

表 7-1. Function Table (Each 4-Bit Buffer/driver)

INPUTS		OUTPUT Y
$\overline{OE}$	A	
L	H	H
L	L	L
H	X	Z

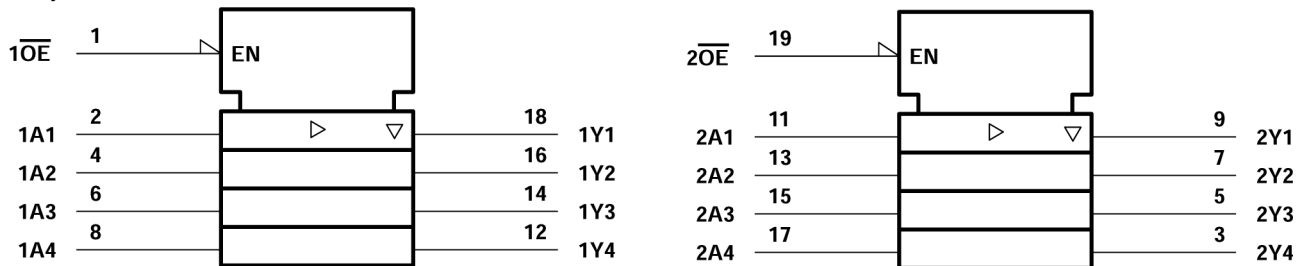

**PACKAGING INFORMATION**

Orderable Device	Status (1)	Package Type	Package Drawing	Pins	Package Qty	Eco Plan (2)	Lead finish/ Ball material (6)	MSL Peak Temp (3)	Op Temp (°C)	Device Marking (4/5)	Samples
SN74AHCT244QDWR	ACTIVE	SOIC	DW	20	2000	RoHS & Green	NIPDAU	Level-1-260C-UNLIM	-40 to 125	AHCT244Q	<a href="#">Samples</a>
SN74AHCT244QPWR	ACTIVE	TSSOP	PW	20	2000	RoHS & Green	NIPDAU	Level-1-260C-UNLIM	-40 to 125	HB244Q	<a href="#">Samples</a>
SN74AHCT244QPWRG4	ACTIVE	TSSOP	PW	20	2000	RoHS & Green	NIPDAU	Level-1-260C-UNLIM		HB244Q	<a href="#">Samples</a>

(1) The marketing status values are defined as follows:

**ACTIVE:** Product device recommended for new designs.

**LIFEBUY:** TI has announced that the device will be discontinued, and a lifetime-buy period is in effect.

**NRND:** Not recommended for new designs. Device is in production to support existing customers, but TI does not recommend using this part in a new design.

**PREVIEW:** Device has been announced but is not in production. Samples may or may not be available.

**OBSOLETE:** TI has discontinued the production of the device.

(2) **RoHS:** TI defines "RoHS" to mean semiconductor products that are compliant with the current EU RoHS requirements for all 10 RoHS substances, including the requirement that RoHS substance do not exceed 0.1% by weight in homogeneous materials. Where designed to be soldered at high temperatures, "RoHS" products are suitable for use in specified lead-free processes. TI may reference these types of products as "Pb-Free".

**RoHS Exempt:** TI defines "RoHS Exempt" to mean products that contain lead but are compliant with EU RoHS pursuant to a specific EU RoHS exemption.

**Green:** TI defines "Green" to mean the content of Chlorine (Cl) and Bromine (Br) based flame retardants meet JS709B low halogen requirements of <=1000ppm threshold. Antimony trioxide based flame retardants must also meet the <=1000ppm threshold requirement.

(3) MSL, Peak Temp. - The Moisture Sensitivity Level rating according to the JEDEC industry standard classifications, and peak solder temperature.

(4) There may be additional marking, which relates to the logo, the lot trace code information, or the environmental category on the device.

(5) Multiple Device Markings will be inside parentheses. Only one Device Marking contained in parentheses and separated by a "~" will appear on a device. If a line is indented then it is a continuation of the previous line and the two combined represent the entire Device Marking for that device.

(6) Lead finish/Ball material - Orderable Devices may have multiple material finish options. Finish options are separated by a vertical ruled line. Lead finish/Ball material values may wrap to two lines if the finish value exceeds the maximum column width.

**Important Information and Disclaimer:**The information provided on this page represents TI's knowledge and belief as of the date that it is provided. TI bases its knowledge and belief on information provided by third parties, and makes no representation or warranty as to the accuracy of such information. Efforts are underway to better integrate information from third parties. TI has taken and continues to take reasonable steps to provide representative and accurate information but may not have conducted destructive testing or chemical analysis on incoming materials and chemicals. TI and TI suppliers consider certain information to be proprietary, and thus CAS numbers and other limited information may not be available for release.

In no event shall TI's liability arising out of such information exceed the total purchase price of the TI part(s) at issue in this document sold by TI to Customer on an annual basis.

**TAPE AND REEL INFORMATION**

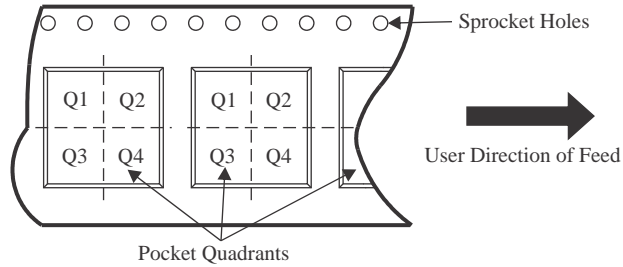
**QUADRANT ASSIGNMENTS FOR PIN 1 ORIENTATION IN TAPE**

\*All dimensions are nominal

Device	Package Type	Package Drawing	Pins	SPQ	Reel Diameter (mm)	Reel Width W1 (mm)	A0 (mm)	B0 (mm)	K0 (mm)	P1 (mm)	W (mm)	Pin1 Quadrant
SN74AHCT244QDWR	SOIC	DW	20	2000	330.0	24.4	10.8	13.3	2.7	12.0	24.0	Q1
SN74AHCT244QPWR	TSSOP	PW	20	2000	330.0	16.4	6.95	7.1	1.6	8.0	16.0	Q1
SN74AHCT244QPWR	TSSOP	PW	20	2000	330.0	16.4	6.95	7.0	1.4	8.0	16.0	Q1
SN74AHCT244QPWRG4	TSSOP	PW	20	2000	330.0	16.4	6.95	7.0	1.4	8.0	16.0	Q1

## TAPE AND REEL BOX DIMENSIONS



\*All dimensions are nominal

Device	Package Type	Package Drawing	Pins	SPQ	Length (mm)	Width (mm)	Height (mm)
SN74AHCT244QDWR	SOIC	DW	20	2000	367.0	367.0	45.0
SN74AHCT244QPWR	TSSOP	PW	20	2000	356.0	356.0	35.0
SN74AHCT244QPWR	TSSOP	PW	20	2000	353.0	353.0	32.0
SN74AHCT244QPWRG4	TSSOP	PW	20	2000	356.0	356.0	35.0

# DW0020A



# PACKAGE OUTLINE

## SOIC - 2.65 mm max height

SOIC



4220724/A 05/2016

**NOTES:**

1. All linear dimensions are in millimeters. Dimensions in parenthesis are for reference only. Dimensioning and tolerancing per ASME Y14.5M.
2. This drawing is subject to change without notice.
3. This dimension does not include mold flash, protrusions, or gate burrs. Mold flash, protrusions, or gate burrs shall not exceed 0.15 mm per side.
4. This dimension does not include interlead flash. Interlead flash shall not exceed 0.43 mm per side.
5. Reference JEDEC registration MS-013.

# EXAMPLE BOARD LAYOUT

DW0020A

SOIC - 2.65 mm max height

SOIC



LAND PATTERN EXAMPLE  
SCALE:6X



SOLDER MASK DETAILS

4220724/A 05/2016

NOTES: (continued)

- 6. Publication IPC-7351 may have alternate designs.
- 7. Solder mask tolerances between and around signal pads can vary based on board fabrication site.

# EXAMPLE STENCIL DESIGN

DW0020A

SOIC - 2.65 mm max height

SOIC



SOLDER PASTE EXAMPLE  
BASED ON 0.125 mm THICK STENCIL  
SCALE:6X

4220724/A 05/2016

NOTES: (continued)

8. Laser cutting apertures with trapezoidal walls and rounded corners may offer better paste release. IPC-7525 may have alternate design recommendations.
9. Board assembly site may have different recommendations for stencil design.

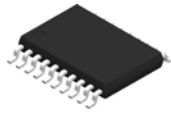

**NOTES:**

1. All linear dimensions are in millimeters. Any dimensions in parenthesis are for reference only. Dimensioning and tolerancing per ASME Y14.5M.
2. This drawing is subject to change without notice.
3. This dimension does not include mold flash, protrusions, or gate burrs. Mold flash, protrusions, or gate burrs shall not exceed 0.15 mm per side.
4. This dimension does not include interlead flash. Interlead flash shall not exceed 0.25 mm per side.
5. Reference JEDEC registration MO-153.



# EXAMPLE BOARD LAYOUT

PW0020A

TSSOP - 1.2 mm max height

SMALL OUTLINE PACKAGE



LAND PATTERN EXAMPLE  
EXPOSED METAL SHOWN  
SCALE: 10X



SOLDER MASK DETAILS

4220206/A 02/2017

NOTES: (continued)

- 6. Publication IPC-7351 may have alternate designs.
- 7. Solder mask tolerances between and around signal pads can vary based on board fabrication site.

# EXAMPLE STENCIL DESIGN

PW0020A

TSSOP - 1.2 mm max height

SMALL OUTLINE PACKAGE



SOLDER PASTE EXAMPLE  
BASED ON 0.125 mm THICK STENCIL  
SCALE: 10X

4220206/A 02/2017

NOTES: (continued)

8. Laser cutting apertures with trapezoidal walls and rounded corners may offer better paste release. IPC-7525 may have alternate design recommendations.
9. Board assembly site may have different recommendations for stencil design.

## 重要通知和免责声明

TI“按原样”提供技术和可靠性数据（包括数据表）、设计资源（包括参考设计）、应用或其他设计建议、网络工具、安全信息和其他资源，不保证没有瑕疵且不做任何明示或暗示的担保，包括但不限于对适销性、某特定用途方面的适用性或不侵犯任何第三方知识产权的暗示担保。

这些资源可供使用 TI 产品进行设计的熟练开发人员使用。您将自行承担以下全部责任：(1) 针对您的应用选择合适的 TI 产品，(2) 设计、验证并测试您的应用，(3) 确保您的应用满足相应标准以及任何其他功能安全、信息安全、监管或其他要求。

这些资源如有变更，恕不另行通知。TI 授权您仅可将这些资源用于研发本资源所述的 TI 产品的相关应用。严禁以其他方式对这些资源进行复制或展示。您无权使用任何其他 TI 知识产权或任何第三方知识产权。您应全额赔偿因在这些资源的使用中对 TI 及其代表造成的任何索赔、损害、成本、损失和债务，TI 对此概不负责。

TI 提供的产品受 [TI 的销售条款](#) 或 [ti.com](#) 上其他适用条款/TI 产品随附的其他适用条款的约束。TI 提供这些资源并不会扩展或以其他方式更改 TI 针对 TI 产品发布的适用的担保或担保免责声明。

TI 反对并拒绝您可能提出的任何其他或不同的条款。

邮寄地址：Texas Instruments, Post Office Box 655303, Dallas, Texas 75265  
版权所有 © 2025，德州仪器 (TI) 公司