

SN74AUC1G32 Single 2-Input Positive-OR Gate

1 Features

- Latch-Up Performance Exceeds 100 mA Per JESD 78, Class II
- ESD Protection Exceeds JESD 22
 - 2000-V Human-Body Model (A114-A)
 - 1000-V Charged-Device Model (C101)
- Available in the Texas Instruments NanoFree™ Package
- Optimized for 1.8-V Operation and Is 3.6-V I/O Tolerant to Support Mixed-Mode Signal Operation
- I_{off} Partial-Power-Down Mode and Back Drive Protection
- Sub-1-V Operable
- Max t_{pd} of 2.4 ns at 1.8 V
- Low Power Consumption, 10- μ A Maximum I_{CC}
- ± 8 -mA Output Drive at 1.8 V

2 Applications

- AV Receiver
- Audio Dock: Portable
- Blu-ray Player and Home Theater
- Embedded PC
- MP3 Player/Recorder (Portable Audio)
- Personal Digital Assistant (PDA)
- Power: Telecom/Server AC/DC Supply: Single Controller: Analog and Digital
- Solid State Drive (SSD): Client and Enterprise
- TV: LCD/Digital and High-Definition (HDTV)
- Tablet: Enterprise
- Video Analytics: Server
- Wireless Headset, Keyboard, and Mouse

3 Description

This single 2-input positive-OR gate is operational at 0.8-V to 2.7-V V_{CC} , but is designed specifically for 1.65-V to 1.95-V V_{CC} operation.

The SN74AUC1G32 device performs the Boolean function $Y = A + B$ or $Y = \overline{A} \cdot \overline{B}$ in positive logic.

NanoFree™ package technology is a major breakthrough in IC packaging concepts, using the die as the package.

This device is fully specified for partial-power-down applications using I_{off} . The I_{off} circuitry disables the outputs, preventing damaging current backflow through the device when it is powered down.

For more information about AUC Little Logic devices, see [Applications of Texas Instruments AUC Sub-1-V Little Logic Devices](#), SCEA027.

Device Information⁽¹⁾

PART NUMBER	PACKAGE	BODY SIZE (NOM)
SN74AUC1G32DBV	SOT-23 (5)	2.90 mm × 1.60 mm
SN74AUC1G32DCK	SC70 (5)	2.00 mm × 1.25 mm
SN74AUC1G32DRL	SOT-5X3 (5)	1.60 mm × 1.20 mm
SN74AUC1G32YZP	DSBGA (5)	1.39 mm × 0.89 mm

(1) For all available packages, see the orderable addendum at the end of the data sheet.

Logic Diagram (Positive Logic)



Table of Contents

1 Features	1	6.8 Operating Characteristics.....	6
2 Applications	1	7 Parameter Measurement Information	7
3 Description	1	8 Detailed Description	8
4 Revision History	2	8.1 Functional Block Diagram	8
5 Pin Configuration and Functions	3	8.2 Device Functional Modes.....	8
6 Specifications	4	9 Device and Documentation Support	9
6.1 Absolute Maximum Ratings	4	9.1 Documentation Support	9
6.2 ESD Ratings	4	9.2 Receiving Notification of Documentation Updates....	9
6.3 Recommended Operating Conditions	4	9.3 Community Resources.....	9
6.4 Thermal Information	5	9.4 Trademarks	9
6.5 Electrical Characteristics.....	5	9.5 Electrostatic Discharge Caution	9
6.6 Switching Characteristics: $C_L = 15$ pF	5	9.6 Glossary	9
6.7 Switching Characteristics: $C_L = 30$ pF	5	10 Mechanical, Packaging, and Orderable Information	9

4 Revision History

NOTE: Page numbers for previous revisions may differ from page numbers in the current version.

Changes from Revision O (September 2009) to Revision P	Page
• Added <i>Application</i> section, <i>Pin Configuration and Functions</i> section, <i>ESD Ratings</i> table, <i>Feature Description</i> section, <i>Device Functional Modes</i> , <i>Application and Implementation Power Supply Recommendations</i> section, <i>Layout</i> section, <i>Device and Documentation Support</i> section, and <i>Mechanical, Packaging, and Orderable Information</i> section.	1
• Deleted <i>Ordering Information</i> table, see <i>Mechanical, Packaging, and Orderable Information</i> at the end of the data sheet.	1
• Deleted DRY package throughout data sheet.....	1

Changes from Revision N (September 2001) to Revision O	Page
• Updated document to new TI data sheet format - no specification changes.	1
• Removed <i>Ordering Information</i>	1

5 Pin Configuration and Functions

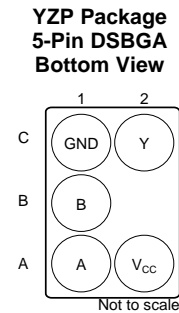
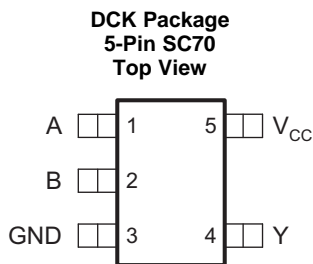
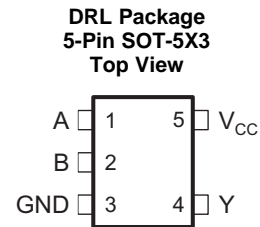
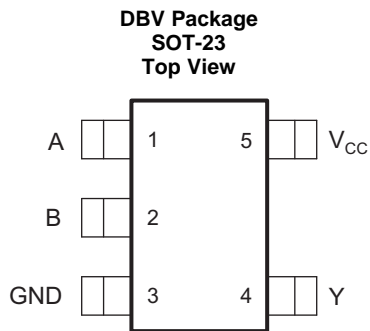

See mechanical drawings for dimensions.

NC No internal connections

Pin Functions

NAME	PIN		I/O	DESCRIPTION
	DBV, DCK, DRL	YZP		
A	1	A1	I	Input A
B	2	B1	I	Input B
GND	3	C1	—	Ground
V _{CC}	5	A2	—	Positive Supply
Y	4	C2	O	Output Y

6 Specifications

6.1 Absolute Maximum Ratings

 over operating free-air temperature range (unless otherwise noted)⁽¹⁾

		MIN	MAX	UNIT
V _{CC}	Supply voltage	-0.5	3.6	V
V _I	Input voltage ⁽²⁾	-0.5	3.6	V
V _O	Voltage range applied to any output in the high-impedance or power-off state ⁽²⁾	-0.5	3.6	V
V _O	Output voltage range ⁽²⁾	-0.5	V _{CC} + 0.5	V
I _{IK}	Input clamp current	V _I < 0	-50	mA
I _{OK}	Output clamp current	V _O < 0	-50	mA
I _O	Continuous output current		±20	mA
	Continuous current through V _{CC} or GND		±100	mA
T _{stg}	Storage temperature	-65	150	°C

- (1) Stresses beyond those listed under *Absolute Maximum Ratings* may cause permanent damage to the device. These are stress ratings only, which do not imply functional operation of the device at these or any other conditions beyond those indicated under *Recommended Operating Conditions*. Exposure to absolute-maximum-rated conditions for extended periods may affect device reliability.
- (2) The input negative-voltage and output voltage ratings may be exceeded if the input and output current ratings are observed.

6.2 ESD Ratings

		VALUE	UNIT
V _(ESD)	Electrostatic discharge	Human body model (HBM), per ANSI/ESDA/JEDEC JS-001 ⁽¹⁾	±2000
		Charged device model (CDM), per JEDEC specification JESD22-C101 ⁽²⁾	±1000

- (1) JEDEC document JEP155 states that 500-V HBM allows safe manufacturing with a standard ESD control process.
- (2) JEDEC document JEP157 states that 250-V CDM allows safe manufacturing with a standard ESD control process.

6.3 Recommended Operating Conditions

 See ⁽¹⁾

		MIN	MAX	UNIT
V _{CC}	Supply voltage	0.8	2.7	V
V _I	Input voltage	0	3.6	V
V _O	Output voltage	0	V _{CC}	V
V _{IH}	High-level input voltage	V _{CC} = 0.8 V	V _{CC}	V
		V _{CC} = 1.1 V to 1.95 V	0.65 × V _{CC}	
		V _{CC} = 2.3 V to 2.7 V	1.7	
V _{IL}	Low-level input voltage	V _{CC} = 0.8 V	0	V
		V _{CC} = 1.1 V to 1.95 V	0.35 × V _{CC}	
		V _{CC} = 2.3 V to 2.7 V	0.7	
I _{OH}	High-level output current	V _{CC} = 0.8 V	-0.7	mA
		V _{CC} = 1.1 V	-3	
		V _{CC} = 1.4 V	-5	
		V _{CC} = 1.65 V	-8	
		V _{CC} = 2.3 V	-9	
I _{OL}	Low-level output current	V _{CC} = 0.8 V	0.7	mA
		V _{CC} = 1.1 V	3	
		V _{CC} = 1.4 V	5	
		V _{CC} = 1.65 V	8	
		V _{CC} = 2.3 V	9	
Δt/Δv	Input transition rise or fall rate		20	ns/V

- (1) All unused inputs of the device must be held at V_{CC} or GND to ensure proper device operation. See [Implications of Slow or Floating CMOS Inputs](#), SCBA004.

Recommended Operating Conditions (continued)

See ⁽¹⁾

		MIN	MAX	UNIT
T _A	Operating free-air temperature	-40	85	°C

6.4 Thermal Information

THERMAL METRIC ⁽¹⁾	SN74AUC1G32				UNIT
	DBV	DCK	DRL	YZP	
	5 PINS	5 PINS	5 PINS	5 PINS	
R _{θJA}	Junction-to-ambient thermal resistance				°C/W
	206	252	142	132	

(1) For more information about traditional and new thermal metrics, see the [Semiconductor and IC Package Thermal Metrics](#) application report.

6.5 Electrical Characteristics

over recommended operating free-air temperature range (unless otherwise noted)

PARAMETER	TEST CONDITIONS	V _{CC}	MIN	TYP ⁽¹⁾	MAX	UNIT
V _{OH}	I _{OH} = -100 μA	0.8 V to 2.7 V	V _{CC} - 0.1			V
	I _{OH} = -0.7 mA	0.8 V	0.55			
	I _{OH} = -3 mA	1.1 V	0.8			
	I _{OH} = -5 mA	1.4 V	1			
	I _{OH} = -8 mA	1.65 V	1.2			
	I _{OH} = -9 mA	2.3 V	1.8			
V _{OL}	I _{OL} = 100 μA	0.8 V to 2.7 V	0.2			V
	I _{OL} = 0.7 mA	0.8 V	0.25			
	I _{OL} = 3 mA	1.1 V	0.3			
	I _{OL} = 5 mA	1.4 V	0.4			
	I _{OL} = 8 mA	1.65 V	0.45			
	I _{OL} = 9 mA	2.3 V	0.6			
I _I	A or B input V _I = V _{CC} or GND	0 to 2.7 V	±5			μA
I _{off}	V _I or V _O = 2.7 V	0	±10			μA
I _{CC}	V _I = V _{CC} or GND, I _O = 0	0.8 V to 2.7 V	10			μA
C _i	V _I = V _{CC} or GND	2.5 V	4			pF

(1) All typical values are at T_A = 25°C.

6.6 Switching Characteristics: C_L = 15 pF

over recommended operating free-air temperature range, C_L = 15 pF (unless otherwise noted) (see [Figure 1](#))

PARAMETER	FROM (INPUT)	TO (OUTPUT)	V _{CC} = 0.8 V	V _{CC} = 1.2 V ± 0.1 V		V _{CC} = 1.5 V ± 0.1 V		V _{CC} = 1.8 V ± 0.15 V			V _{CC} = 2.5 V ± 0.2 V		UNIT
			TYP	MIN	MAX	MIN	MAX	MIN	TYP	MAX	MIN	MAX	
t _{pd}	A or B	Y	4.8	1	3.5	0.6	2.3	0.5	0.9	1.5	0.3	1.4	ns

6.7 Switching Characteristics: C_L = 30 pF

over recommended operating free-air temperature range, C_L = 30 pF (unless otherwise noted) (see [Figure 1](#))

PARAMETER	FROM (INPUT)	TO (OUTPUT)	V _{CC} = 1.8 V ± 0.15 V			V _{CC} = 2.5 V ± 0.2 V		UNIT
			MIN	TYP	MAX	MIN	MAX	
t _{pd}	A or B	Y	0.8	1.4	2.4	0.6	2.1	ns

SN74AUC1G32

SCES377P –SEPTEMBER 2001–REVISED JUNE 2017

www.ti.com
6.8 Operating Characteristics
 $T_A = 25^\circ\text{C}$

PARAMETER	TEST CONDITIONS	$V_{CC} = 0.8\text{ V}$	$V_{CC} = 1.2\text{ V}$	$V_{CC} = 1.5\text{ V}$	$V_{CC} = 1.8\text{ V}$	$V_{CC} = 2.5\text{ V}$	UNIT
		TYP	TYP	TYP	TYP	TYP	
C_{pd} Power dissipation capacitance	$f = 10\text{ MHz}$	14	14	15	15	20	pF

7 Parameter Measurement Information

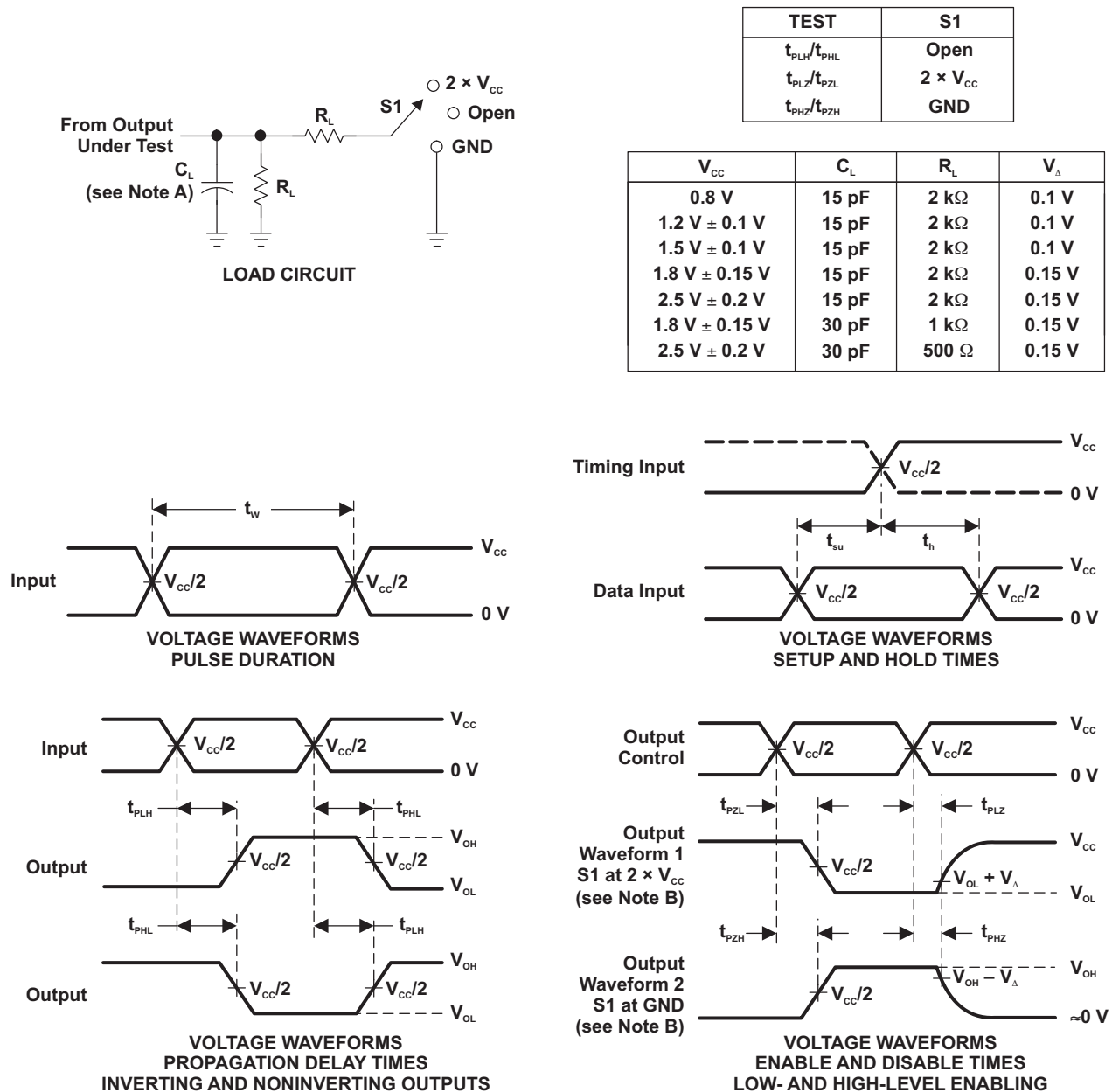

- NOTES: A. C_L includes probe and jig capacitance.
 B. Waveform 1 is for an output with internal conditions such that the output is low, except when disabled by the output control. Waveform 2 is for an output with internal conditions such that the output is high, except when disabled by the output control.
 C. All input pulses are supplied by generators having the following characteristics: PRR \leq 10 MHz, $Z_o = 50 \Omega$, slew rate ≥ 1 V/ns.
 D. The outputs are measured one at a time, with one transition per measurement.
 E. t_{PLZ} and t_{PHZ} are the same as t_{dis} .
 F. t_{PZL} and t_{PZH} are the same as t_{en} .
 G. t_{PLH} and t_{PHL} are the same as t_{pd} .
 H. All parameters and waveforms are not applicable to all devices.

Figure 1. Load Circuit and Voltage Waveforms

8 Detailed Description

8.1 Functional Block Diagram



Figure 2. Logic Diagram (Positive Logic)

8.2 Device Functional Modes

Table 1 lists the functional modes of SN74AUC1G32.

**Table 1. Function Table
(Each Inverter)**

INPUTS		OUTPUT Y
A	B	
H	X	H
X	H	H
L	L	L

9 Device and Documentation Support

9.1 Documentation Support

9.1.1 Related Documentation

For related documentation see the following:

- [Applications of Texas Instruments AUC Sub-1-V Little Logic Devices](#), SCEA027
- [Implications of Slow or Floating CMOS Inputs](#), SCBA004

9.2 Receiving Notification of Documentation Updates

To receive notification of documentation updates, navigate to the device product folder on ti.com. In the upper right corner, click on *Alert me* to register and receive a weekly digest of any product information that has changed. For change details, review the revision history included in any revised document.

9.3 Community Resources

The following links connect to TI community resources. Linked contents are provided "AS IS" by the respective contributors. They do not constitute TI specifications and do not necessarily reflect TI's views; see TI's [Terms of Use](#).

TI E2E™ Online Community *TI's Engineer-to-Engineer (E2E) Community*. Created to foster collaboration among engineers. At e2e.ti.com, you can ask questions, share knowledge, explore ideas and help solve problems with fellow engineers.

Design Support *TI's Design Support* Quickly find helpful E2E forums along with design support tools and contact information for technical support.

9.4 Trademarks

NanoFree, E2E are trademarks of Texas Instruments.
All other trademarks are the property of their respective owners.

9.5 Electrostatic Discharge Caution



This integrated circuit can be damaged by ESD. Texas Instruments recommends that all integrated circuits be handled with appropriate precautions. Failure to observe proper handling and installation procedures can cause damage.

ESD damage can range from subtle performance degradation to complete device failure. Precision integrated circuits may be more susceptible to damage because very small parametric changes could cause the device not to meet its published specifications.

9.6 Glossary

[SLYZ022](#) — *TI Glossary*.

This glossary lists and explains terms, acronyms, and definitions.

10 Mechanical, Packaging, and Orderable Information

The following pages include mechanical, packaging, and orderable information. This information is the most current data available for the designated devices. This data is subject to change without notice and revision of this document. For browser-based versions of this data sheet, refer to the left-hand navigation.

PACKAGING INFORMATION

Orderable part number	Status (1)	Material type (2)	Package Pins	Package qty Carrier	RoHS (3)	Lead finish/ Ball material (4)	MSL rating/ Peak reflow (5)	Op temp (°C)	Part marking (6)
SN74AUC1G32DBVR	Active	Production	SOT-23 (DBV) 5	3000 LARGE T&R	Yes	NIPDAU SN	Level-1-260C-UNLIM	-40 to 85	(U32F, U32R)
SN74AUC1G32DBVR.B	Active	Production	SOT-23 (DBV) 5	3000 LARGE T&R	Yes	NIPDAU	Level-1-260C-UNLIM	-40 to 85	(U32F, U32R)
SN74AUC1G32DBVRG4	Active	Production	SOT-23 (DBV) 5	3000 LARGE T&R	Yes	NIPDAU	Level-1-260C-UNLIM	-40 to 85	U32F
SN74AUC1G32DBVRG4.B	Active	Production	SOT-23 (DBV) 5	3000 LARGE T&R	Yes	NIPDAU	Level-1-260C-UNLIM	-40 to 85	U32F
SN74AUC1G32DCKR	Active	Production	SC70 (DCK) 5	3000 LARGE T&R	Yes	NIPDAU	Level-1-260C-UNLIM	-40 to 85	(UG5, UGF, UGR)
SN74AUC1G32DCKR.B	Active	Production	SC70 (DCK) 5	3000 LARGE T&R	Yes	NIPDAU	Level-1-260C-UNLIM	-40 to 85	(UG5, UGF, UGR)
SN74AUC1G32DCKRG4	Active	Production	SC70 (DCK) 5	3000 LARGE T&R	Yes	NIPDAU	Level-1-260C-UNLIM	-40 to 85	(UG5, UGF, UGR)
SN74AUC1G32DRLR	Active	Production	SOT-5X3 (DRL) 5	4000 LARGE T&R	Yes	NIPDAUAG	Level-1-260C-UNLIM	-40 to 85	(UG7, UGR)
SN74AUC1G32DRLR.B	Active	Production	SOT-5X3 (DRL) 5	4000 LARGE T&R	Yes	NIPDAUAG	Level-1-260C-UNLIM	-40 to 85	(UG7, UGR)
SN74AUC1G32YZPR	Active	Production	DSBGA (YZP) 5	3000 LARGE T&R	Yes	SNAGCU	Level-1-260C-UNLIM	-40 to 85	UGN
SN74AUC1G32YZPR.B	Active	Production	DSBGA (YZP) 5	3000 LARGE T&R	Yes	SNAGCU	Level-1-260C-UNLIM	-40 to 85	UGN

(1) **Status:** For more details on status, see our [product life cycle](#).

(2) **Material type:** When designated, preproduction parts are prototypes/experimental devices, and are not yet approved or released for full production. Testing and final process, including without limitation quality assurance, reliability performance testing, and/or process qualification, may not yet be complete, and this item is subject to further changes or possible discontinuation. If available for ordering, purchases will be subject to an additional waiver at checkout, and are intended for early internal evaluation purposes only. These items are sold without warranties of any kind.

(3) **RoHS values:** Yes, No, RoHS Exempt. See the [TI RoHS Statement](#) for additional information and value definition.

(4) **Lead finish/Ball material:** Parts may have multiple material finish options. Finish options are separated by a vertical ruled line. Lead finish/Ball material values may wrap to two lines if the finish value exceeds the maximum column width.

(5) **MSL rating/Peak reflow:** The moisture sensitivity level ratings and peak solder (reflow) temperatures. In the event that a part has multiple moisture sensitivity ratings, only the lowest level per JEDEC standards is shown. Refer to the shipping label for the actual reflow temperature that will be used to mount the part to the printed circuit board.

(6) **Part marking:** There may be an additional marking, which relates to the logo, the lot trace code information, or the environmental category of the part.

Multiple part markings will be inside parentheses. Only one part marking contained in parentheses and separated by a "~" will appear on a part. If a line is indented then it is a continuation of the previous line and the two combined represent the entire part marking for that device.

Important Information and Disclaimer: The information provided on this page represents TI's knowledge and belief as of the date that it is provided. TI bases its knowledge and belief on information provided by third parties, and makes no representation or warranty as to the accuracy of such information. Efforts are underway to better integrate information from third parties. TI has taken and continues to take reasonable steps to provide representative and accurate information but may not have conducted destructive testing or chemical analysis on incoming materials and chemicals. TI and TI suppliers consider certain information to be proprietary, and thus CAS numbers and other limited information may not be available for release.

In no event shall TI's liability arising out of such information exceed the total purchase price of the TI part(s) at issue in this document sold by TI to Customer on an annual basis.

TAPE AND REEL INFORMATION

QUADRANT ASSIGNMENTS FOR PIN 1 ORIENTATION IN TAPE



*All dimensions are nominal

Device	Package Type	Package Drawing	Pins	SPQ	Reel Diameter (mm)	Reel Width W1 (mm)	A0 (mm)	B0 (mm)	K0 (mm)	P1 (mm)	W (mm)	Pin1 Quadrant
SN74AUC1G32DBVR	SOT-23	DBV	5	3000	180.0	8.4	3.2	3.2	1.4	4.0	8.0	Q3
SN74AUC1G32DBVRG4	SOT-23	DBV	5	3000	180.0	8.4	3.2	3.2	1.4	4.0	8.0	Q3
SN74AUC1G32DBVRG4	SOT-23	DBV	5	3000	178.0	9.0	3.23	3.17	1.37	4.0	8.0	Q3
SN74AUC1G32DCKR	SC70	DCK	5	3000	180.0	8.4	2.47	2.3	1.25	4.0	8.0	Q3
SN74AUC1G32DCKR	SC70	DCK	5	3000	178.0	9.0	2.4	2.5	1.2	4.0	8.0	Q3
SN74AUC1G32DCKR	SC70	DCK	5	3000	178.0	9.2	2.4	2.4	1.22	4.0	8.0	Q3
SN74AUC1G32DRLR	SOT-5X3	DRL	5	4000	180.0	8.4	1.98	1.78	0.69	4.0	8.0	Q3
SN74AUC1G32YZPR	DSBGA	YZP	5	3000	178.0	9.2	1.02	1.52	0.63	4.0	8.0	Q1

TAPE AND REEL BOX DIMENSIONS

*All dimensions are nominal

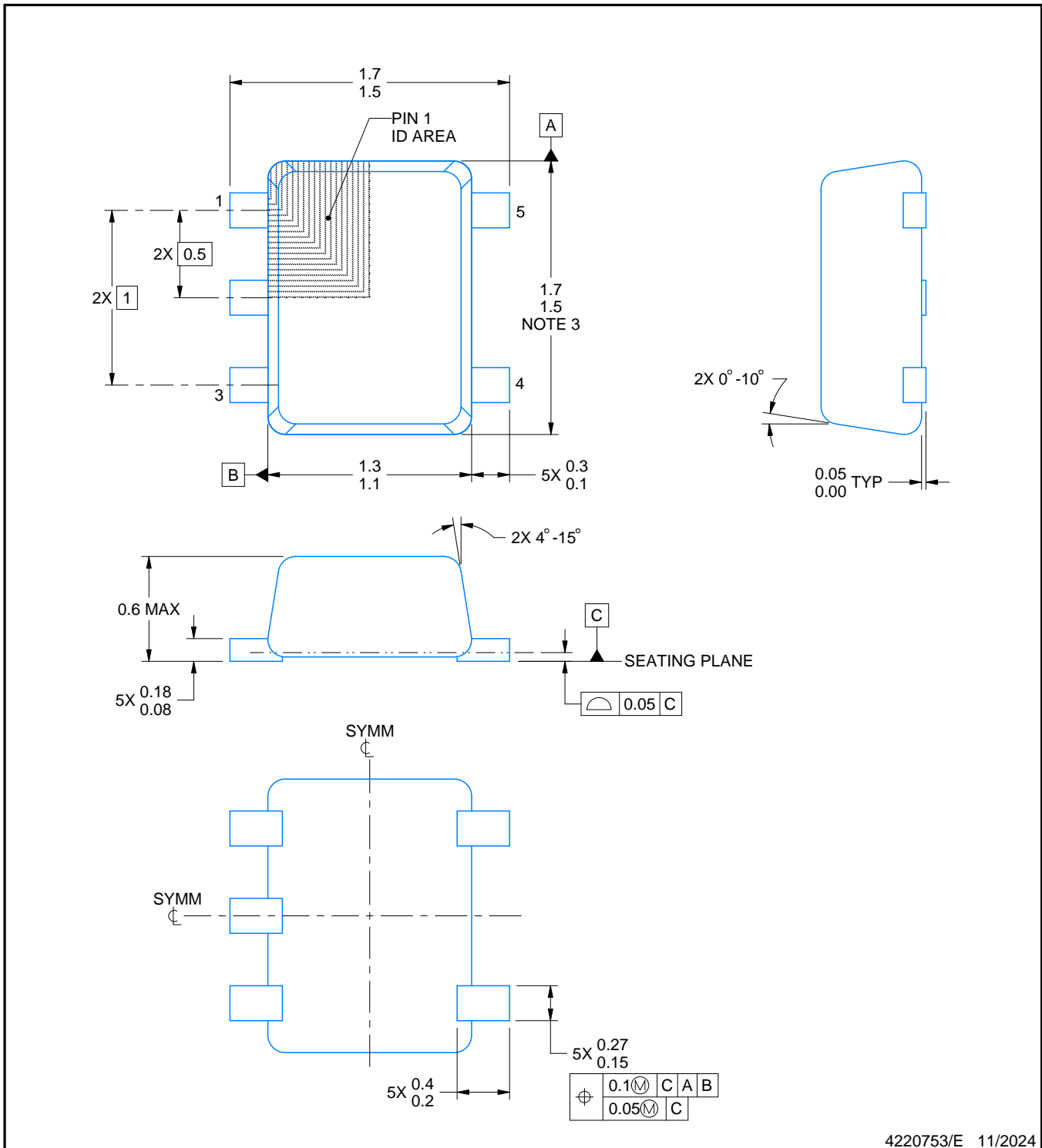
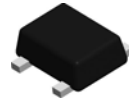
Device	Package Type	Package Drawing	Pins	SPQ	Length (mm)	Width (mm)	Height (mm)
SN74AUC1G32DBVR	SOT-23	DBV	5	3000	210.0	185.0	35.0
SN74AUC1G32DBVRG4	SOT-23	DBV	5	3000	210.0	185.0	35.0
SN74AUC1G32DBVRG4	SOT-23	DBV	5	3000	180.0	180.0	18.0
SN74AUC1G32DCKR	SC70	DCK	5	3000	202.0	201.0	28.0
SN74AUC1G32DCKR	SC70	DCK	5	3000	180.0	180.0	18.0
SN74AUC1G32DCKR	SC70	DCK	5	3000	180.0	180.0	18.0
SN74AUC1G32DRLR	SOT-5X3	DRL	5	4000	202.0	201.0	28.0
SN74AUC1G32YZPR	DSBGA	YZP	5	3000	220.0	220.0	35.0



4220753/E 11/2024

NOTES:

1. All linear dimensions are in millimeters. Any dimensions in parenthesis are for reference only. Dimensioning and tolerancing per ASME Y14.5M.
2. This drawing is subject to change without notice.
3. This dimension does not include mold flash, protrusions, or gate burrs. Mold flash, protrusions, or gate burrs shall not exceed 0.15 mm per side.
4. Reference JEDEC registration MO-293 Variation UAAD-1

EXAMPLE BOARD LAYOUT

DRL0005A

SOT - 0.6 mm max height

PLASTIC SMALL OUTLINE

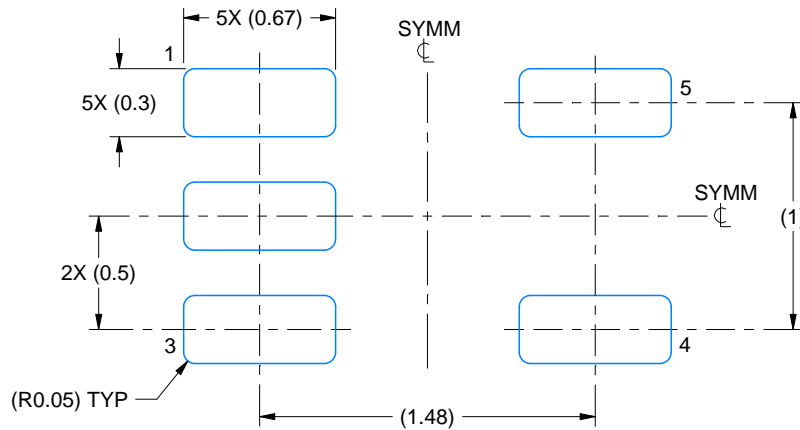

LAND PATTERN EXAMPLE
SCALE:30X

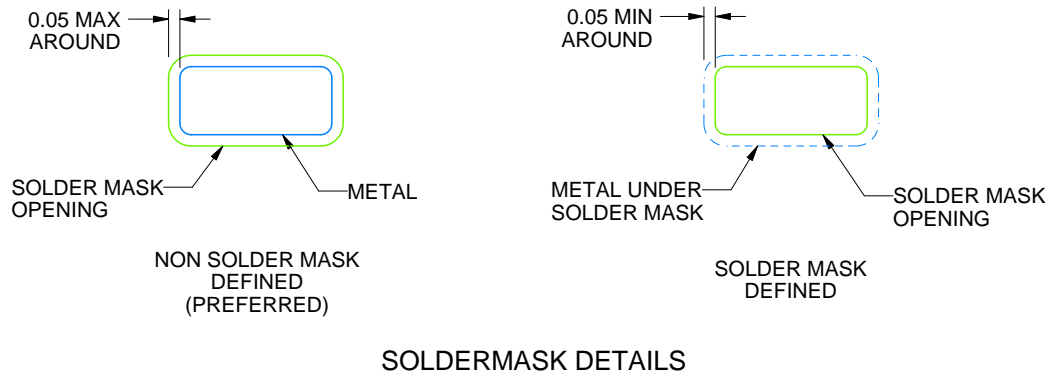

SOLDERMASK DETAILS

4220753/E 11/2024

NOTES: (continued)

- 5. Publication IPC-7351 may have alternate designs.
- 6. Solder mask tolerances between and around signal pads can vary based on board fabrication site.

EXAMPLE STENCIL DESIGN

DRL0005A

SOT - 0.6 mm max height

PLASTIC SMALL OUTLINE

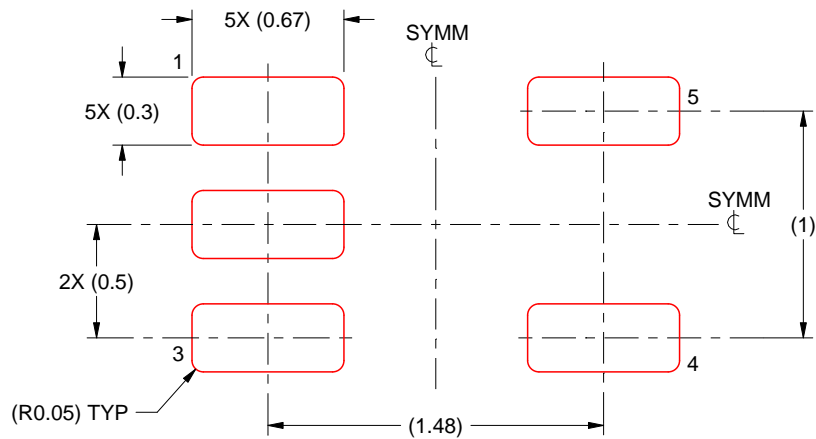

SOLDER PASTE EXAMPLE
BASED ON 0.1 mm THICK STENCIL
SCALE:30X

4220753/E 11/2024

NOTES: (continued)

7. Laser cutting apertures with trapezoidal walls and rounded corners may offer better paste release. IPC-7525 may have alternate design recommendations.
8. Board assembly site may have different recommendations for stencil design.

EXAMPLE BOARD LAYOUT

YZP0005

DSBGA - 0.5 mm max height

DIE SIZE BALL GRID ARRAY

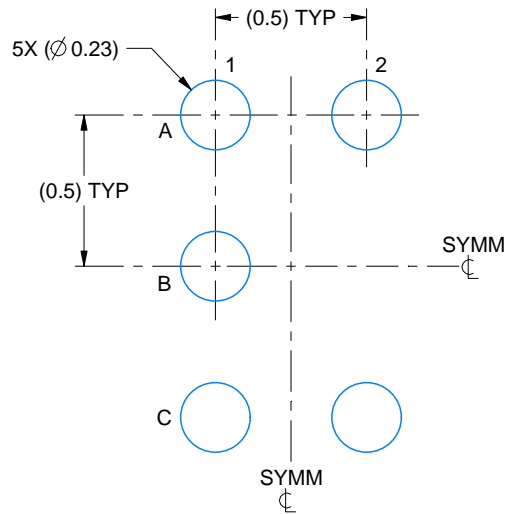

LAND PATTERN EXAMPLE
SCALE:40X

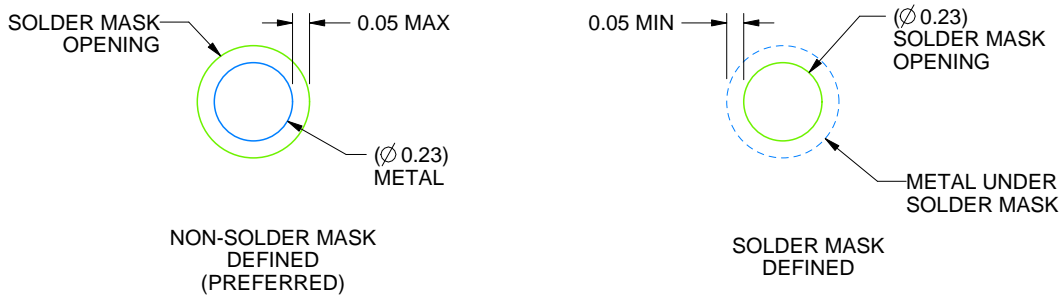

SOLDER MASK DETAILS
NOT TO SCALE

4219492/A 05/2017

NOTES: (continued)

3. Final dimensions may vary due to manufacturing tolerance considerations and also routing constraints. For more information, see Texas Instruments literature number SNVA009 (www.ti.com/lit/snva009).

EXAMPLE STENCIL DESIGN

YZP0005

DSBGA - 0.5 mm max height

DIE SIZE BALL GRID ARRAY

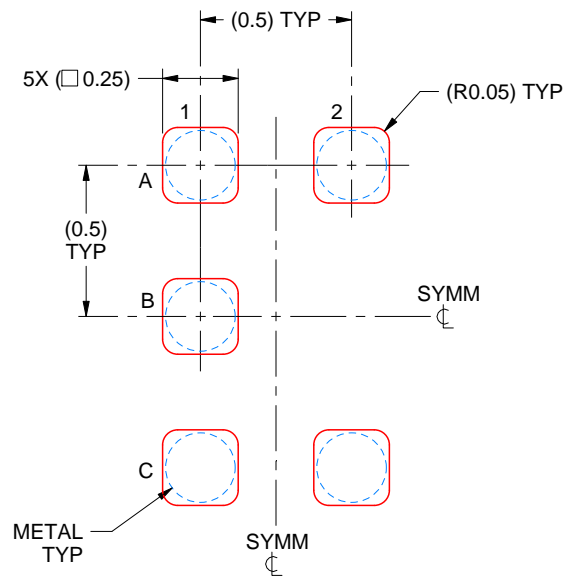

SOLDER PASTE EXAMPLE
BASED ON 0.1 mm THICK STENCIL
SCALE:40X

4219492/A 05/2017

NOTES: (continued)

4. Laser cutting apertures with trapezoidal walls and rounded corners may offer better paste release.

DCK0005A



PACKAGE OUTLINE

SOT - 1.1 max height

SMALL OUTLINE TRANSISTOR

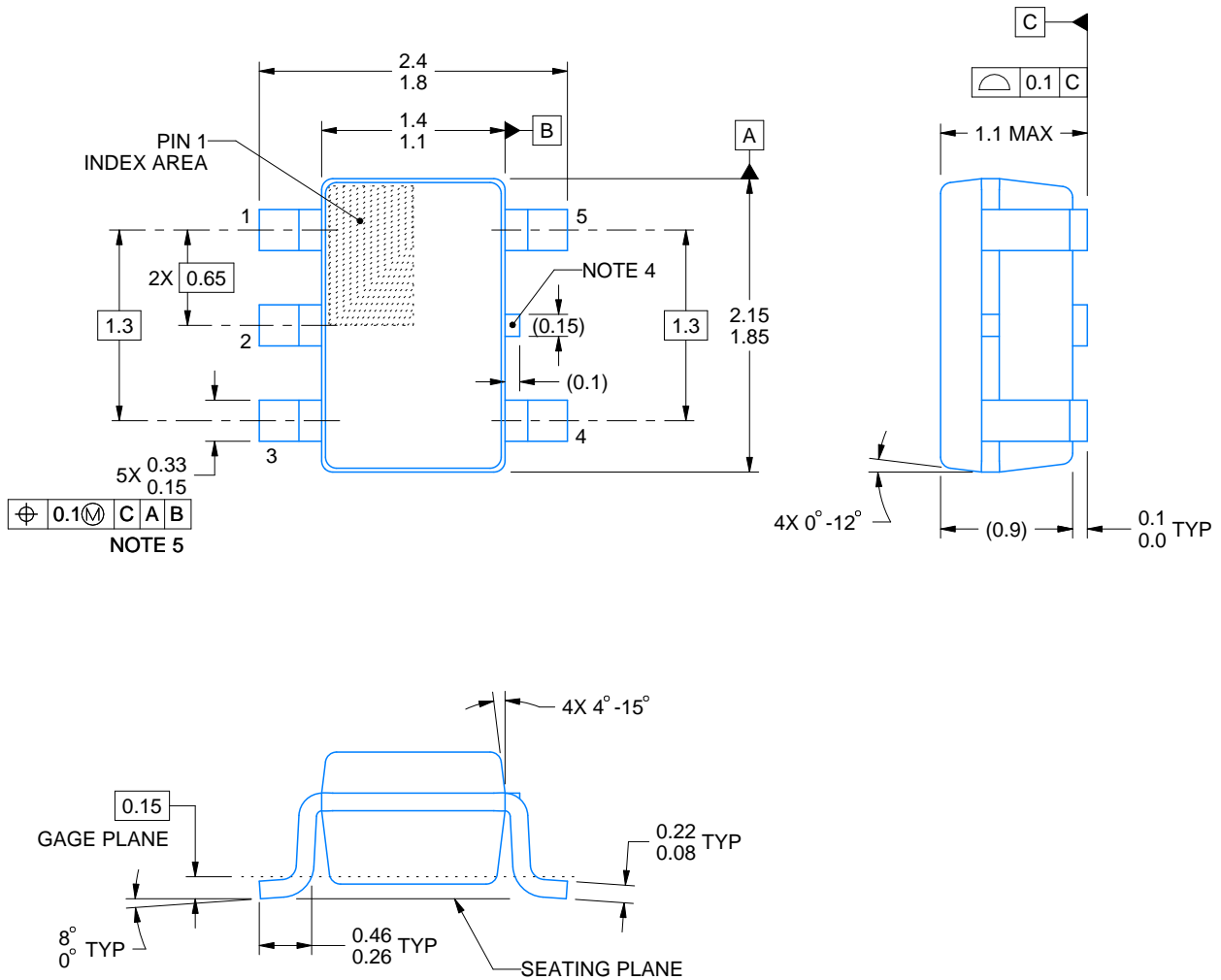

4214834/G 11/2024

NOTES:

1. All linear dimensions are in millimeters. Any dimensions in parenthesis are for reference only. Dimensioning and tolerancing per ASME Y14.5M.
2. This drawing is subject to change without notice.
3. Reference JEDEC MO-203.
4. Support pin may differ or may not be present.
5. Lead width does not comply with JEDEC.
6. Body dimensions do not include mold flash, protrusions, or gate burrs. Mold flash, protrusions, or gate burrs shall not exceed 0.25mm per side



LAND PATTERN EXAMPLE
EXPOSED METAL SHOWN
SCALE:18X



SOLDER MASK DETAILS

4214834/G 11/2024

NOTES: (continued)

7. Publication IPC-7351 may have alternate designs.
8. Solder mask tolerances between and around signal pads can vary based on board fabrication site.

EXAMPLE STENCIL DESIGN

DCK0005A

SOT - 1.1 max height

SMALL OUTLINE TRANSISTOR



SOLDER PASTE EXAMPLE
BASED ON 0.125 THICK STENCIL
SCALE: 18X

4214834/G 11/2024

NOTES: (continued)

9. Laser cutting apertures with trapezoidal walls and rounded corners may offer better paste release. IPC-7525 may have alternate design recommendations.
10. Board assembly site may have different recommendations for stencil design.

EXAMPLE BOARD LAYOUT

DBV0005A

SOT-23 - 1.45 mm max height

SMALL OUTLINE TRANSISTOR



LAND PATTERN EXAMPLE
EXPOSED METAL SHOWN
SCALE:15X



SOLDER MASK DETAILS

4214839/K 08/2024

NOTES: (continued)

6. Publication IPC-7351 may have alternate designs.
7. Solder mask tolerances between and around signal pads can vary based on board fabrication site.

EXAMPLE STENCIL DESIGN

DBV0005A

SOT-23 - 1.45 mm max height

SMALL OUTLINE TRANSISTOR



SOLDER PASTE EXAMPLE
BASED ON 0.125 mm THICK STENCIL
SCALE:15X

4214839/K 08/2024

NOTES: (continued)

8. Laser cutting apertures with trapezoidal walls and rounded corners may offer better paste release. IPC-7525 may have alternate design recommendations.
9. Board assembly site may have different recommendations for stencil design.

IMPORTANT NOTICE AND DISCLAIMER

TI PROVIDES TECHNICAL AND RELIABILITY DATA (INCLUDING DATASHEETS), DESIGN RESOURCES (INCLUDING REFERENCE DESIGNS), APPLICATION OR OTHER DESIGN ADVICE, WEB TOOLS, SAFETY INFORMATION, AND OTHER RESOURCES "AS IS" AND WITH ALL FAULTS, AND DISCLAIMS ALL WARRANTIES, EXPRESS AND IMPLIED, INCLUDING WITHOUT LIMITATION ANY IMPLIED WARRANTIES OF MERCHANTABILITY, FITNESS FOR A PARTICULAR PURPOSE OR NON-INFRINGEMENT OF THIRD PARTY INTELLECTUAL PROPERTY RIGHTS.

These resources are intended for skilled developers designing with TI products. You are solely responsible for (1) selecting the appropriate TI products for your application, (2) designing, validating and testing your application, and (3) ensuring your application meets applicable standards, and any other safety, security, regulatory or other requirements.

These resources are subject to change without notice. TI grants you permission to use these resources only for development of an application that uses the TI products described in the resource. Other reproduction and display of these resources is prohibited. No license is granted to any other TI intellectual property right or to any third party intellectual property right. TI disclaims responsibility for, and you fully indemnify TI and its representatives against any claims, damages, costs, losses, and liabilities arising out of your use of these resources.

TI's products are provided subject to [TI's Terms of Sale](#), [TI's General Quality Guidelines](#), or other applicable terms available either on ti.com or provided in conjunction with such TI products. TI's provision of these resources does not expand or otherwise alter TI's applicable warranties or warranty disclaimers for TI products. Unless TI explicitly designates a product as custom or customer-specified, TI products are standard, catalog, general purpose devices.

TI objects to and rejects any additional or different terms you may propose.

Copyright © 2026, Texas Instruments Incorporated

Last updated 10/2025