

SN74AUP1G125 Low-Power Single Bus Buffer Gate With 3-State Output

1 Features

- Available in the Texas Instruments NanoStar™ Package
- Low Static-Power Consumption ($I_{CC} = 0.9 \mu\text{A}$ Maximum)
- Low Dynamic-Power Consumption ($C_{pd} = 4 \text{ pF}$ Typical at 3.3 V)
- Low Input Capacitance ($C_I = 1.5 \text{ pF}$ Typical)
- Low Noise – Overshoot and Undershoot $< 10\%$ of V_{CC}
- Input-Disable Feature Allows Floating Input Conditions
- I_{off} Supports Partial-Power-Down Mode Operation
- Input Hysteresis Allows Slow Input Transition and Better Switching Noise Immunity at Input
- Wide Operating V_{CC} Range of 0.8 V to 3.6 V
- 3.6-V I/O Tolerant to Support Mixed-Mode Signal Operation
- $t_{pd} = 4.6 \text{ ns}$ Maximum at 3.3 V

2 Applications

- Audio Dock: Portable
- BluRay™ Players and Home Theaters
- Personal Digital Assistant (PDA)
- Power: Telecom/Server AC/DC Supply: Single Controller: Analog and Digital
- Solid-State Drive (SSD): Client and Enterprise
- TV: LCD/Digital and High-Definition (HDTV)
- Tablet: Enterprise
- Wireless Headsets, Keyboards, and Mice

3 Description

The SN74AUP1G125 bus buffer gate is a single line driver with a 3-state output. The output is disabled when the output-enable ($\overline{\text{OE}}$) input is high. This device has the input-disable feature, which allows floating input signals.

To ensure the high-impedance state during power up or power down, $\overline{\text{OE}}$ must be tied to V_{CC} through a pullup resistor; the minimum value of the resistor is determined by the current-sinking capability of the driver.

Device Information⁽¹⁾

PART NUMBER	PACKAGE	BODY SIZE (NOM)
SN74AUP1G125DBV	SOT-23 (5)	2.90 mm x 1.60 mm
SN74AUP1G125DCK	SC70 (5)	2.00 mm x 1.25 mm
SN74AUP1G125DRL	SOT (5)	1.60 mm x 1.20 mm
SN74AUP1G125DRY	SON (6)	1.45 mm x 1.00 mm
SN74AUP1G125DSF		1.00 mm x 1.00 mm
SN74AUP1G125YFP	DSBGA (6)	0.76 mm x 1.16 mm
SN74AUP1G125YZP	DSBGA (5)	0.89 mm x 1.39 mm
SN74AUP1G125YZT	DSBGA (5)	0.89 mm x 1.39 mm
SN74AUP1G125DPW	X2SON (5)	0.80 mm x 0.80 mm

(1) For all available packages, see the orderable addendum at the end of the data sheet.

Simplified Schematic

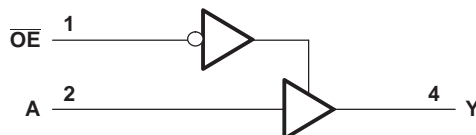

Table of Contents

1 Features	1	8.1 Overview	15
2 Applications	1	8.2 Functional Block Diagram	15
3 Description	1	8.3 Feature Description	15
4 Revision History	2	8.4 Device Functional Modes	16
5 Pin Configuration and Functions	3	9 Application and Implementation	17
6 Specifications	4	9.1 Application Information	17
6.1 Absolute Maximum Ratings	4	9.2 Typical Application	17
6.2 ESD Ratings	4	10 Power Supply Recommendations	18
6.3 Recommended Operating Conditions	5	11 Layout	18
6.4 Thermal Information	5	11.1 Layout Guidelines	18
6.5 Electrical Characteristics, $T_A = 25^\circ\text{C}$	6	11.2 Layout Example	18
6.6 Electrical Characteristics, $T_A = -40^\circ\text{C}$ to $+85^\circ\text{C}$	7	12 Device and Documentation Support	20
6.7 Switching Characteristics, $C_L = 5\text{ pF}$	8	12.1 Documentation Support	20
6.8 Switching Characteristics, $C_L = 10\text{ pF}$	9	12.2 Receiving Notification of Documentation Updates	20
6.9 Switching Characteristics, $C_L = 15\text{ pF}$	10	12.3 Community Resources	20
6.10 Switching Characteristics, $C_L = 30\text{ pF}$	11	12.4 Trademarks	20
6.11 Operating Characteristics	12	12.5 Electrostatic Discharge Caution	20
6.12 Typical Characteristics	12	12.6 Glossary	20
7 Parameter Measurement Information	13	13 Mechanical, Packaging, and Orderable Information	20
8 Detailed Description	15		

4 Revision History

NOTE: Page numbers for previous revisions may differ from page numbers in the current version.

Changes from Revision M (December 2015) to Revision N	Page
• Added DPW (X2SON) package	1
• Deleted <i>Device Comparison</i> table, see <i>Mechanical, Packaging, and Orderable Information</i> section at the end of the data sheet	1
• Changed <i>Simplified Schematic</i> with a new schematic	1
• Added column for X2SON (DPW) package and separated columns for DSBGA packages in <i>Pin Functions</i> table	3
• Changed values in the <i>Thermal Information</i> table to align with JEDEC standards	5
• Added <i>Balanced High-Drive CMOS Push-Pull Outputs, Standard CMOS Inputs, Clamp Diodes, Partial Power Down (I_{off}), and Over-voltage Tolerant Inputs</i>	15
• Added <i>Trace Example</i> and revised <i>Layout Guidelines</i>	18
• Added <i>Receiving Notification of Documentation Updates</i> section	20

Changes from Revision L (February 2013) to Revision M	Page
• Added <i>Applications</i> section, <i>Device Information</i> table, <i>Pin Configuration and Functions</i> section, <i>ESD Ratings</i> table, <i>Thermal Information</i> table, <i>Typical Characteristics</i> section, <i>Feature Description</i> section, <i>Device Functional Modes</i> , <i>Application and Implementation</i> section, <i>Power Supply Recommendations</i> section, <i>Layout</i> section, <i>Device and Documentation Support</i> section, and <i>Mechanical, Packaging, and Orderable Information</i> section	1

Changes from Revision K (November 2012) to Revision L	Page
• Changed \bar{Y} to Y for pin 4 in DSF Package pin out	3

5 Pin Configuration and Functions

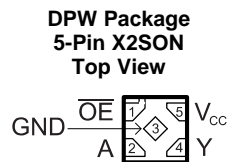
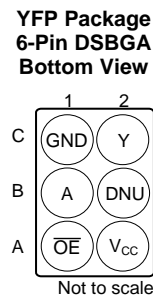
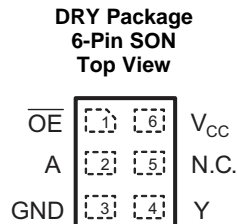
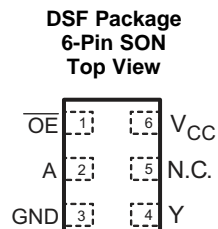
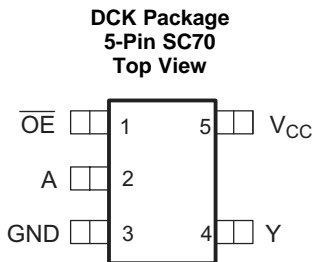
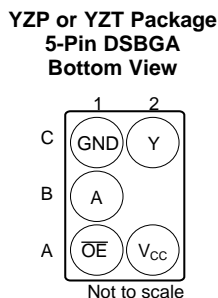
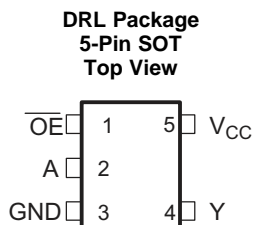
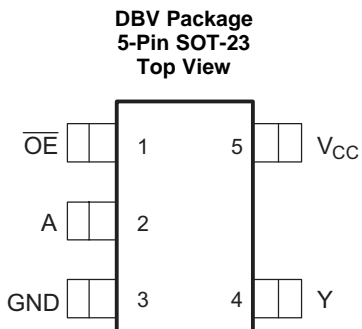

Pin Functions

NAME	PIN				I/O	DESCRIPTION
	SOT-23 (DBV), SC70 (DCK), SOT (DRL), X2SON (DPW)	SON (DRY or DSF)	DSBGA (YZP or YZT)	DSBGA (YFP)		
A	2	2	B1	B1	I	Input
DNU	—	—	—	B2	—	Do not use
GND	3	3	C1	C1	—	Ground
N.C.	—	5	—	—	—	No connection
$\overline{\text{OE}}$	1	1	A1	A1	I	Output enable (active low)
V_{CC}	5	6	A2	A2	—	Positive supply
Y	4	4	C2	C2	O	Output

6 Specifications

6.1 Absolute Maximum Ratings

over operating free-air temperature range (unless otherwise noted)⁽¹⁾

		MIN	MAX	UNIT
V_{CC}	Supply voltage	-0.5	4.6	V
V_I	Input voltage ⁽²⁾	-0.5	4.6	V
V_O	Voltage applied to any output in the high-impedance or power-off state ⁽²⁾	-0.5	4.6	V
V_O	Output voltage in the high or low state ⁽²⁾	-0.5	$V_{CC} + 0.5$	V
I_{IK}	Input clamp current	$V_I < 0$	-50	mA
I_{OK}	Output clamp current	$V_O < 0$	-50	mA
I_O	Continuous output current		± 20	mA
	Continuous current through V_{CC} or GND		± 50	mA
T_J	Junction temperature		150	°C
T_{stg}	Storage temperature	-65	150	°C

- (1) Stresses beyond those listed under *Absolute Maximum Ratings* may cause permanent damage to the device. These are stress ratings only, and functional operation of the device at these or any other conditions beyond those indicated under *Recommended Operating Conditions* is not implied. Exposure to absolute-maximum-rated conditions for extended periods may affect device reliability.
- (2) The input negative-voltage and output voltage ratings may be exceeded if the input and output current ratings are observed.

6.2 ESD Ratings

		VALUE	UNIT
$V_{(ESD)}$	Electrostatic discharge	Human body model (HBM), per ANSI/ESDA/JEDEC JS-001 ⁽¹⁾	2000
		Charged-device model (CDM), per JEDEC specification JESD22-C101 ⁽²⁾	1000

- (1) JEDEC document JEP155 states that 500-V HBM allows safe manufacturing with a standard ESD control process.
- (2) JEDEC document JEP157 states that 250-V CDM allows safe manufacturing with a standard ESD control process.

6.3 Recommended Operating Conditions

 See ⁽¹⁾

		MIN	MAX	UNIT
V _{CC}	Supply voltage	0.8	3.6	V
V _{IH}	High-level input voltage	V _{CC} = 0.8 V	V _{CC}	3.6
		V _{CC} = 1.1 V to 1.95 V	0.65 × V _{CC}	3.6
		V _{CC} = 2.3 V to 2.7 V	1.6	3.6
		V _{CC} = 3 V to 3.6 V	2	3.6
V _{IL}	Low-level input voltage	V _{CC} = 0.8 V	0	0
		V _{CC} = 1.1 V to 1.95 V	0	0.35 × V _{CC}
		V _{CC} = 2.3 V to 2.7 V	0	0.7
		V _{CC} = 3 V to 3.6 V	0	0.9
V _O	Output voltage	Active state	0	V _{CC}
		3-state	0	3.6
I _{OH}	High-level output current	V _{CC} = 0.8 V		–20
		V _{CC} = 1.1 V		–1.1
		V _{CC} = 1.4 V		–1.7
		V _{CC} = 1.65 V		–1.9
		V _{CC} = 2.3 V		–3.1
		V _{CC} = 3 V		–4
I _{OL}	Low-level output current	V _{CC} = 0.8 V		20
		V _{CC} = 1.1 V		1.1
		V _{CC} = 1.4 V		1.7
		V _{CC} = 1.65 V		1.9
		V _{CC} = 2.3 V		3.1
		V _{CC} = 3 V		4
Δt/Δv	Input transition rise or fall rate	V _{CC} = 0.8 V to 3.6 V		200
T _A	Operating free-air temperature	–40	85	°C

(1) All unused inputs of the device must be held at V_{CC} or GND to ensure proper device operation. See the TI application report, [Implications of Slow of Floating CMOS Inputs](#), SCBA004.

6.4 Thermal Information

THERMAL METRIC ⁽¹⁾	SN74AUP1G125								UNIT	
	DCK (SC70)	DBV (SOT-23)	DRL (SOT)	DRY (SON)	DSF (SON)	YFP (DSBGA)	YZP (DSBGA)	DPW (X2SON)		
	5 PINS	5 PINS	5 PINS	6 PINS	6 PINS	6 PINS	5 PINS	5 PINS		
R _{θJA}	Junction-to-ambient thermal resistance	303.6	230.5	295.1	342.1	377.1	125.4	146.2	504.3	°C/W
R _{θJC(top)}	Junction-to-case (top) thermal resistance	203.8	172.7	131.0	233.1	187.7	1.9	1.4	234.9	°C/W
R _{θJB}	Junction-to-board thermal resistance	100.9	62.2	143.9	206.7	236.6	37.2	39.3	370.3	°C/W
Ψ _{θJt}	Junction-to-top characterization parameter	76.1	49.3	14.7	63.4	29.0	0.5	0.7	44.5	°C/W
Ψ _{θJB}	Junction-to-board characterization parameter	99.3	61.6	144.4	206.7	236.3	37.5	39.8	369.7	°C/W
R _{θJC(bot)}	Junction-to-case (bottom) thermal resistance	N/A	N/A	N/A	N/A	N/A	N/A	N/A	165.2	°C/W

(1) For more information about traditional and new thermal metrics, see the [Semiconductor and IC Package Thermal Metrics](#) application report.

6.5 Electrical Characteristics, $T_A = 25^\circ\text{C}$

PARAMETER		TEST CONDITIONS	V_{CC}	MIN	TYP	MAX	UNIT
V_{OH}		$I_{OH} = -20 \mu\text{A}$	0.8 V to 3.6 V	$V_{CC} - 0.1$			V
		$I_{OH} = -1.1 \text{ mA}$	1.1 V	$0.75 \times V_{CC}$			
		$I_{OH} = -1.7 \text{ mA}$	1.4 V	1.11			
		$I_{OH} = -1.9 \text{ mA}$	1.65 V	1.32			
		$I_{OH} = -2.3 \text{ mA}$	2.3 V	2.05			
		$I_{OH} = -3.1 \text{ mA}$		1.9			
		$I_{OH} = -2.7 \text{ mA}$	3 V	2.72			
		$I_{OH} = -4 \text{ mA}$		2.6			
V_{OL}		$I_{OL} = 20 \mu\text{A}$	0.8 V to 3.6 V			0.1	V
		$I_{OL} = 1.1 \text{ mA}$	1.1 V			$0.3 \times V_{CC}$	
		$I_{OL} = 1.7 \text{ mA}$	1.4 V			0.31	
		$I_{OL} = 1.9 \text{ mA}$	1.65 V			0.31	
		$I_{OL} = 2.3 \text{ mA}$	2.3 V			0.31	
		$I_{OL} = 3.1 \text{ mA}$				0.44	
		$I_{OL} = 2.7 \text{ mA}$	3 V			0.31	
		$I_{OL} = 4 \text{ mA}$				0.44	
I_I	A or \overline{OE} input	$V_I = \text{GND to } 3.6 \text{ V}$	0 V to 3.6 V			0.1	μA
I_{off}		V_I or $V_O = 0 \text{ V to } 3.6 \text{ V}$	0 V			0.2	μA
ΔI_{off}		V_I or $V_O = 0 \text{ V to } 3.6 \text{ V}$	0 V to 0.2 V			0.2	μA
I_{OZ}		$V_O = V_{CC}$ or GND	3.6 V			0.1	μA
I_{CC}		$V_I = \text{GND or } (V_{CC} \text{ to } 3.6 \text{ V}),$ $\overline{OE} = \text{GND}, I_O = 0$	0.8 V to 3.6 V			0.5	μA
ΔI_{CC}	A input	$V_I = V_{CC} - 0.6 \text{ V}^{(1)},$ $I_O = 0$	3.3 V			40	μA
	\overline{OE} input					110	
	All inputs	$V_I = \text{GND to } 3.6 \text{ V},$ $\overline{OE} = V_{CC}^{(2)}$	0.8 V to 3.6 V			0	
C_I		$V_I = V_{CC}$ or GND	0 V		1.5		pF
			3.6 V		1.5		
C_O		$V_O = V_{CC}$ or GND	3.6 V		3		pF

(1) One input at $V_{CC} - 0.6 \text{ V}$, other input at V_{CC} or GND

(2) To show I_{CC} is very low when the input-disable feature is enabled

6.6 Electrical Characteristics, $T_A = -40^\circ\text{C}$ to $+85^\circ\text{C}$

PARAMETER		TEST CONDITIONS	V_{CC}	MIN	TYP	MAX	UNIT
V_{OH}		$I_{OH} = -20\ \mu\text{A}$	0.8 V to 3.6 V	$V_{CC} - 0.1$			V
		$I_{OH} = -1.1\ \text{mA}$	1.1 V	$0.7 \times V_{CC}$			
		$I_{OH} = -1.7\ \text{mA}$	1.4 V	1.03			
		$I_{OH} = -1.9\ \text{mA}$	1.65 V	1.3			
		$I_{OH} = -2.3\ \text{mA}$	2.3 V	1.97			
		$I_{OH} = -3.1\ \text{mA}$		1.85			
		$I_{OH} = -2.7\ \text{mA}$	3 V	2.67			
		$I_{OH} = -4\ \text{mA}$		2.55			
V_{OL}		$I_{OL} = 20\ \mu\text{A}$	0.8 V to 3.6 V			0.1	V
		$I_{OL} = 1.1\ \text{mA}$	1.1 V			$0.3 \times V_{CC}$	
		$I_{OL} = 1.7\ \text{mA}$	1.4 V			0.37	
		$I_{OL} = 1.9\ \text{mA}$	1.65 V			0.35	
		$I_{OL} = 2.3\ \text{mA}$	2.3 V			0.33	
		$I_{OL} = 3.1\ \text{mA}$				0.45	
		$I_{OL} = 2.7\ \text{mA}$	3 V			0.33	
		$I_{OL} = 4\ \text{mA}$				0.45	
I_I	A or \overline{OE} input	$V_I = \text{GND}$ to 3.6 V	0 V to 3.6 V			0.5	μA
I_{off}		V_I or $V_O = 0\ \text{V}$ to 3.6 V	0 V			0.6	μA
ΔI_{off}		V_I or $V_O = 0\ \text{V}$ to 3.6 V	0 V to 0.2 V			0.6	μA
I_{OZ}		$V_O = V_{CC}$ or GND	3.6 V			0.5	μA
I_{CC}		$V_I = \text{GND}$ or (V_{CC} to 3.6 V), $\overline{OE} = \text{GND}$, $I_O = 0$	0.8 V to 3.6 V			0.9	μA
ΔI_{CC}	A input	$V_I = V_{CC} - 0.6\ \text{V}^{(1)}$, $I_O = 0$	3.3 V			50	μA
	\overline{OE} input					120	
	All inputs	$V_I = \text{GND}$ to 3.6 V, $\overline{OE} = V_{CC}^{(2)}$	0.8 V to 3.6 V			0	

(1) One input at $V_{CC} - 0.6\ \text{V}$, other input at V_{CC} or GND

(2) To show I_{CC} is very low when the input-disable feature is enabled

6.7 Switching Characteristics, $C_L = 5$ pF

 over recommended operating free-air temperature range, $C_L = 5$ pF (unless otherwise noted) (see [Figure 2](#) and [Figure 3](#))

PARAMETER	FROM (INPUT)	TO (OUTPUT)	V_{CC}	T_A	MIN	TYP	MAX	UNIT
t_{pd}	A	Y	0.8 V	$T_A = 25^\circ\text{C}$		18.1		ns
			$1.2\text{ V} \pm 0.1\text{ V}$	$T_A = 25^\circ\text{C}$	4.3	7.4	12.6	
				$T_A = -40^\circ\text{C to } +85^\circ\text{C}$	2.7		15.3	
			$1.5\text{ V} \pm 0.1\text{ V}$	$T_A = 25^\circ\text{C}$	3.3	5.2	8.5	
				$T_A = -40^\circ\text{C to } +85^\circ\text{C}$	1		10.2	
			$1.8\text{ V} \pm 0.15\text{ V}$	$T_A = 25^\circ\text{C}$	2.6	4.1	6.8	
				$T_A = -40^\circ\text{C to } +85^\circ\text{C}$	1.3		8.3	
			$2.5\text{ V} \pm 0.2\text{ V}$	$T_A = 25^\circ\text{C}$	2	2.9	4.7	
				$T_A = -40^\circ\text{C to } +85^\circ\text{C}$	1.1		5.8	
			$3.3\text{ V} \pm 0.3\text{ V}$	$T_A = 25^\circ\text{C}$	1.7	2.4	3.8	
				$T_A = -40^\circ\text{C to } +85^\circ\text{C}$	1		4.6	
			t_{en}	$\overline{\text{OE}}$	Y	0.8 V	$T_A = 25^\circ\text{C}$	
$1.2\text{ V} \pm 0.1\text{ V}$	$T_A = 25^\circ\text{C}$	5.1				9.3	15.9	
	$T_A = -40^\circ\text{C to } +85^\circ\text{C}$	3.6					19.2	
$1.5\text{ V} \pm 0.1\text{ V}$	$T_A = 25^\circ\text{C}$	4.1				6.6	10.5	
	$T_A = -40^\circ\text{C to } +85^\circ\text{C}$	2.5					12.7	
$1.8\text{ V} \pm 0.15\text{ V}$	$T_A = 25^\circ\text{C}$	3.2				5.3	8.7	
	$T_A = -40^\circ\text{C to } +85^\circ\text{C}$	2.1					10.3	
$2.5\text{ V} \pm 0.2\text{ V}$	$T_A = 25^\circ\text{C}$	2.5				3.8	6	
	$T_A = -40^\circ\text{C to } +85^\circ\text{C}$	1.6					7.2	
$3.3\text{ V} \pm 0.3\text{ V}$	$T_A = 25^\circ\text{C}$	2.1				3.2	4.9	
	$T_A = -40^\circ\text{C to } +85^\circ\text{C}$	1.4					5.9	
t_{dis}	$\overline{\text{OE}}$	Y				0.8 V	$T_A = 25^\circ\text{C}$	
			$1.2\text{ V} \pm 0.1\text{ V}$	$T_A = 25^\circ\text{C}$	2.4	4.1	6.9	
				$T_A = -40^\circ\text{C to } +85^\circ\text{C}$	2.2		7.7	
			$1.5\text{ V} \pm 0.1\text{ V}$	$T_A = 25^\circ\text{C}$	1.8	2.9	4.5	
				$T_A = -40^\circ\text{C to } +85^\circ\text{C}$	1.7		5.1	
			$1.8\text{ V} \pm 0.15\text{ V}$	$T_A = 25^\circ\text{C}$	1	2.9	4.3	
				$T_A = -40^\circ\text{C to } +85^\circ\text{C}$	1.5		4.7	
			$2.5\text{ V} \pm 0.2\text{ V}$	$T_A = 25^\circ\text{C}$	1	1.8	2.7	
				$T_A = -40^\circ\text{C to } +85^\circ\text{C}$	1		3.3	
			$3.3\text{ V} \pm 0.3\text{ V}$	$T_A = 25^\circ\text{C}$	1.2	2.2	3.2	
				$T_A = -40^\circ\text{C to } +85^\circ\text{C}$	1.1		4	

6.8 Switching Characteristics, $C_L = 10$ pF

 over recommended operating free-air temperature range, $C_L = 10$ pF (unless otherwise noted) (see [Figure 2](#) and [Figure 3](#))

PARAMETER	FROM (INPUT)	TO (OUTPUT)	V_{CC}	T_A	MIN	TYP	MAX	UNIT
t_{pd}	A or B	Y	0.8 V	$T_A = 25^\circ\text{C}$		20.5		ns
			$1.2\text{ V} \pm 0.1\text{ V}$	$T_A = 25^\circ\text{C}$	4.6	8.4	13.7	
				$T_A = -40^\circ\text{C to } +85^\circ\text{C}$	3.6		16.6	
			$1.5\text{ V} \pm 0.1\text{ V}$	$T_A = 25^\circ\text{C}$	3.5	5.9	9.3	
				$T_A = -40^\circ\text{C to } +85^\circ\text{C}$	2.4		11.1	
			$1.8\text{ V} \pm 0.15\text{ V}$	$T_A = 25^\circ\text{C}$	3.9	4.7	7.5	
				$T_A = -40^\circ\text{C to } +85^\circ\text{C}$	1.3		9.1	
			$2.5\text{ V} \pm 0.2\text{ V}$	$T_A = 25^\circ\text{C}$	2.3	3.4	5.3	
				$T_A = -40^\circ\text{C to } +85^\circ\text{C}$	1.6		6.4	
			$3.3\text{ V} \pm 0.3\text{ V}$	$T_A = 25^\circ\text{C}$	2.1	2.8	4.3	
				$T_A = -40^\circ\text{C to } +85^\circ\text{C}$	1.4		5.2	
			t_{en}	$\overline{\text{OE}}$	Y	0.8 V	$T_A = 25^\circ\text{C}$	
$1.2\text{ V} \pm 0.1\text{ V}$	$T_A = 25^\circ\text{C}$	4.9				10.2	16.8	
	$T_A = -40^\circ\text{C to } +85^\circ\text{C}$	4.4					20.2	
$1.5\text{ V} \pm 0.1\text{ V}$	$T_A = 25^\circ\text{C}$	3.9				7.3	11.2	
	$T_A = -40^\circ\text{C to } +85^\circ\text{C}$	3.3					13.5	
$1.8\text{ V} \pm 0.15\text{ V}$	$T_A = 25^\circ\text{C}$	3.4				5.8	9.2	
	$T_A = -40^\circ\text{C to } +85^\circ\text{C}$	2.7					11	
$2.5\text{ V} \pm 0.2\text{ V}$	$T_A = 25^\circ\text{C}$	2.5				4.3	6.4	
	$T_A = -40^\circ\text{C to } +85^\circ\text{C}$	2.1					7.8	
$3.3\text{ V} \pm 0.3\text{ V}$	$T_A = 25^\circ\text{C}$	2.1				3.7	5.4	
	$T_A = -40^\circ\text{C to } +85^\circ\text{C}$	1.9					6.4	
t_{dis}	$\overline{\text{OE}}$	Y				0.8 V	$T_A = 25^\circ\text{C}$	
			$1.2\text{ V} \pm 0.1\text{ V}$	$T_A = 25^\circ\text{C}$	3.8	6.6	11.7	
				$T_A = -40^\circ\text{C to } +85^\circ\text{C}$	1.2		14	
			$1.5\text{ V} \pm 0.1\text{ V}$	$T_A = 25^\circ\text{C}$	2.2	4.7	7.9	
				$T_A = -40^\circ\text{C to } +85^\circ\text{C}$	1.3		9.3	
			$1.8\text{ V} \pm 0.15\text{ V}$	$T_A = 25^\circ\text{C}$	2.4	4.4	6.4	
				$T_A = -40^\circ\text{C to } +85^\circ\text{C}$	2.2		7.5	
			$2.5\text{ V} \pm 0.2\text{ V}$	$T_A = 25^\circ\text{C}$	1.3	3.1	4.9	
				$T_A = -40^\circ\text{C to } +85^\circ\text{C}$	1.2		5.4	
			$3.3\text{ V} \pm 0.3\text{ V}$	$T_A = 25^\circ\text{C}$	1.9	3.4	5	
				$T_A = -40^\circ\text{C to } +85^\circ\text{C}$	1.9		5.6	

6.9 Switching Characteristics, $C_L = 15\text{ pF}$

 over recommended operating free-air temperature range, $C_L = 15\text{ pF}$ (unless otherwise noted) (see [Figure 2](#) and [Figure 3](#))

PARAMETER	FROM (INPUT)	TO (OUTPUT)	V_{CC}	T_A	MIN	TYP	MAX	UNIT
t_{pd}	A or B	Y	0.8 V	$T_A = 25^\circ\text{C}$	22.5			ns
			$1.2\text{ V} \pm 0.1\text{ V}$	$T_A = 25^\circ\text{C}$	5.8	9.3	15.1	
				$T_A = -40^\circ\text{C to } +85^\circ\text{C}$	4.3	17.9		
			$1.5\text{ V} \pm 0.1\text{ V}$	$T_A = 25^\circ\text{C}$	4.4	6.6	10.2	
				$T_A = -40^\circ\text{C to } +85^\circ\text{C}$	3	12.1		
			$1.8\text{ V} \pm 0.15\text{ V}$	$T_A = 25^\circ\text{C}$	3.5	5.3	8.3	
				$T_A = -40^\circ\text{C to } +85^\circ\text{C}$	2.3	9.9		
			$2.5\text{ V} \pm 0.2\text{ V}$	$T_A = 25^\circ\text{C}$	2.7	3.9	5.8	
				$T_A = -40^\circ\text{C to } +85^\circ\text{C}$	1.9	7		
			$3.3\text{ V} \pm 0.3\text{ V}$	$T_A = 25^\circ\text{C}$	2.4	3.2	4.7	
				$T_A = -40^\circ\text{C to } +85^\circ\text{C}$	1.8	5.7		
			t_{en}	\overline{OE}	Y	0.8 V	$T_A = 25^\circ\text{C}$	
$1.2\text{ V} \pm 0.1\text{ V}$	$T_A = 25^\circ\text{C}$	7				11.3	18.1	
	$T_A = -40^\circ\text{C to } +85^\circ\text{C}$	5.4				21.4		
$1.5\text{ V} \pm 0.1\text{ V}$	$T_A = 25^\circ\text{C}$	5.5				8.1	12.2	
	$T_A = -40^\circ\text{C to } +85^\circ\text{C}$	4.1				14.5		
$1.8\text{ V} \pm 0.15\text{ V}$	$T_A = 25^\circ\text{C}$	4.3				6.5	10.1	
	$T_A = -40^\circ\text{C to } +85^\circ\text{C}$	3.3				12		
$2.5\text{ V} \pm 0.2\text{ V}$	$T_A = 25^\circ\text{C}$	3.4				4.8	7.1	
	$T_A = -40^\circ\text{C to } +85^\circ\text{C}$	2.6				8.4		
$3.3\text{ V} \pm 0.3\text{ V}$	$T_A = 25^\circ\text{C}$	2.9				4.1	5.9	
	$T_A = -40^\circ\text{C to } +85^\circ\text{C}$	2.3				6.9		
t_{dis}	\overline{OE}	Y				0.8 V	$T_A = 25^\circ\text{C}$	14
			$1.2\text{ V} \pm 0.1\text{ V}$	$T_A = 25^\circ\text{C}$	3.7	5.8	8.2	
				$T_A = -40^\circ\text{C to } +85^\circ\text{C}$	3.3	11		
			$1.5\text{ V} \pm 0.1\text{ V}$	$T_A = 25^\circ\text{C}$	5.5	3.9	5.9	
				$T_A = -40^\circ\text{C to } +85^\circ\text{C}$	2.1	8		
			$1.8\text{ V} \pm 0.15\text{ V}$	$T_A = 25^\circ\text{C}$	3.3	4.5	6.6	
				$T_A = -40^\circ\text{C to } +85^\circ\text{C}$	2.9	7.4		
			$2.5\text{ V} \pm 0.2\text{ V}$	$T_A = 25^\circ\text{C}$	2.3	3.2	4.3	
				$T_A = -40^\circ\text{C to } +85^\circ\text{C}$	1.8	5.1		
			$3.3\text{ V} \pm 0.3\text{ V}$	$T_A = 25^\circ\text{C}$	2.4	4.8	6.2	
				$T_A = -40^\circ\text{C to } +85^\circ\text{C}$	3.1	6.7		

6.10 Switching Characteristics, $C_L = 30$ pF

over recommended operating free-air temperature range, $C_L = 30$ pF (unless otherwise noted) (see [Figure 2](#) and [Figure 3](#))

PARAMETER	FROM (INPUT)	TO (OUTPUT)	V_{CC}	T_A	MIN	TYP	MAX	UNIT
t_{pd}	A or B	Y	0.8 V	$T_A = 25^\circ\text{C}$		29		ns
			$1.2\text{ V} \pm 0.1\text{ V}$	$T_A = 25^\circ\text{C}$	7.4	12	18.7	
				$T_A = -40^\circ\text{C to } +85^\circ\text{C}$	6.6		21.4	
			$1.5\text{ V} \pm 0.1\text{ V}$	$T_A = 25^\circ\text{C}$	5.7	8.6	12.5	
				$T_A = -40^\circ\text{C to } +85^\circ\text{C}$	4.9		14.7	
			$1.8\text{ V} \pm 0.15\text{ V}$	$T_A = 25^\circ\text{C}$	4.8	6.9	10.1	
				$T_A = -40^\circ\text{C to } +85^\circ\text{C}$	3.1		12	
			$2.5\text{ V} \pm 0.2\text{ V}$	$T_A = 25^\circ\text{C}$	3.9	5.1	7.2	
				$T_A = -40^\circ\text{C to } +85^\circ\text{C}$	3.3		8.7	
			$3.3\text{ V} \pm 0.3\text{ V}$	$T_A = 25^\circ\text{C}$	3.5	4.8	6	
				$T_A = -40^\circ\text{C to } +85^\circ\text{C}$	3		7	
			t_{en}	\overline{OE}	Y	0.8 V	$T_A = 25^\circ\text{C}$	
$1.2\text{ V} \pm 0.1\text{ V}$	$T_A = 25^\circ\text{C}$	8.8				14.1	21.8	
	$T_A = -40^\circ\text{C to } +85^\circ\text{C}$	7.4					25.5	
$1.5\text{ V} \pm 0.1\text{ V}$	$T_A = 25^\circ\text{C}$	6.9				10.1	14.6	
	$T_A = -40^\circ\text{C to } +85^\circ\text{C}$	5.6					17.4	
$1.8\text{ V} \pm 0.15\text{ V}$	$T_A = 25^\circ\text{C}$	5.6				8.1	12	
	$T_A = -40^\circ\text{C to } +85^\circ\text{C}$	4.7					14.1	
$2.5\text{ V} \pm 0.2\text{ V}$	$T_A = 25^\circ\text{C}$	4.3				6.1	8.5	
	$T_A = -40^\circ\text{C to } +85^\circ\text{C}$	3.8					10	
$3.3\text{ V} \pm 0.3\text{ V}$	$T_A = 25^\circ\text{C}$	3.7				5.2	7.1	
	$T_A = -40^\circ\text{C to } +85^\circ\text{C}$	3.4					8.3	
t_{dis}	\overline{OE}	Y				0.8 V	$T_A = 25^\circ\text{C}$	
			$1.2\text{ V} \pm 0.1\text{ V}$	$T_A = 25^\circ\text{C}$	5.8	10	16	
				$T_A = -40^\circ\text{C to } +85^\circ\text{C}$	3.7		16	
			$1.5\text{ V} \pm 0.1\text{ V}$	$T_A = 25^\circ\text{C}$	5.7	7.7	10.9	
				$T_A = -40^\circ\text{C to } +85^\circ\text{C}$	1		10.7	
			$1.8\text{ V} \pm 0.15\text{ V}$	$T_A = 25^\circ\text{C}$	4.5	7.7	9.8	
				$T_A = -40^\circ\text{C to } +85^\circ\text{C}$	4.4		12.5	
			$2.5\text{ V} \pm 0.2\text{ V}$	$T_A = 25^\circ\text{C}$	3.9	5.6	7.4	
				$T_A = -40^\circ\text{C to } +85^\circ\text{C}$	3.2		9	
			$3.3\text{ V} \pm 0.3\text{ V}$	$T_A = 25^\circ\text{C}$	3.3	8.4	10.7	
				$T_A = -40^\circ\text{C to } +85^\circ\text{C}$	6.6		10.8	

6.11 Operating Characteristics

T_A = 25°C

PARAMETER		TEST CONDITIONS	V _{CC}	TYP	UNIT	
C _{pd}	Power dissipation capacitance	Outputs enabled	f = 10 MHz	0.8 V	3.8	pF
				1.2 V ± 0.1 V	3.8	
				1.5 V ± 0.1 V	3.7	
				1.8 V ± 0.15 V	3.8	
				2.5 V ± 0.2 V	3.9	
	Outputs disabled	f = 10 MHz	0.8 V	0		
			1.2 V ± 0.1 V	0		
			1.5 V ± 0.1 V	0		
			1.8 V ± 0.15 V	0		
			2.5 V ± 0.2 V	0		
			3.3 V ± 0.3 V	0		

6.12 Typical Characteristics

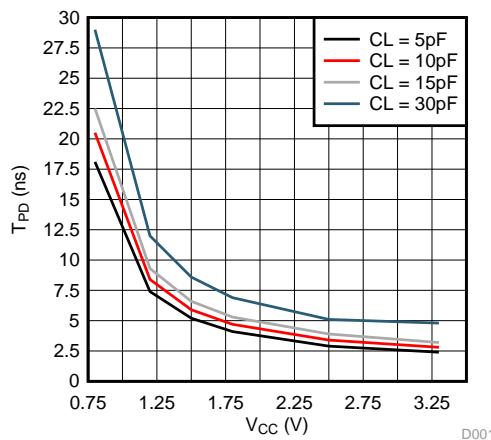
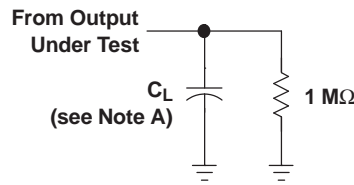

Figure 1. Propagation Delay vs. Supply Voltage and Load Capacitance

7 Parameter Measurement Information



LOAD CIRCUIT

	$V_{CC} = 0.8\text{ V}$	$V_{CC} = 1.2\text{ V} \pm 0.1\text{ V}$	$V_{CC} = 1.5\text{ V} \pm 0.1\text{ V}$	$V_{CC} = 1.8\text{ V} \pm 0.15\text{ V}$	$V_{CC} = 2.5\text{ V} \pm 0.2\text{ V}$	$V_{CC} = 3.3\text{ V} \pm 0.3\text{ V}$
C_L	5, 10, 15, 30 pF	5, 10, 15, 30 pF	5, 10, 15, 30 pF	5, 10, 15, 30 pF	5, 10, 15, 30 pF	5, 10, 15, 30 pF
V_M	$V_{CC}/2$	$V_{CC}/2$	$V_{CC}/2$	$V_{CC}/2$	$V_{CC}/2$	$V_{CC}/2$
V_I	V_{CC}	V_{CC}	V_{CC}	V_{CC}	V_{CC}	V_{CC}

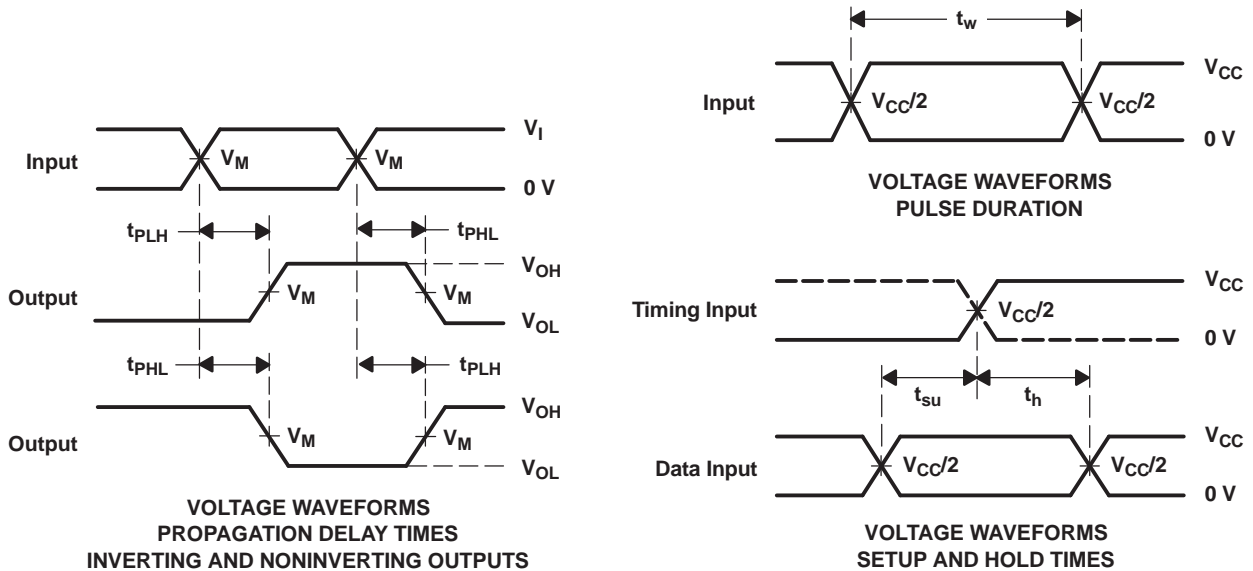

- NOTES: A. C_L includes probe and jig capacitance.
 B. All input pulses are supplied by generators having the following characteristics: $PRR \leq 10\text{ MHz}$, $Z_O = 50\ \Omega$, $t_r/t_f = 3\text{ ns}$.
 C. The outputs are measured one at a time, with one transition per measurement.
 D. t_{PLH} and t_{PHL} are the same as t_{pd} .
 E. All parameters and waveforms are not applicable to all devices.

Figure 2. Load Circuit and Voltage Waveforms

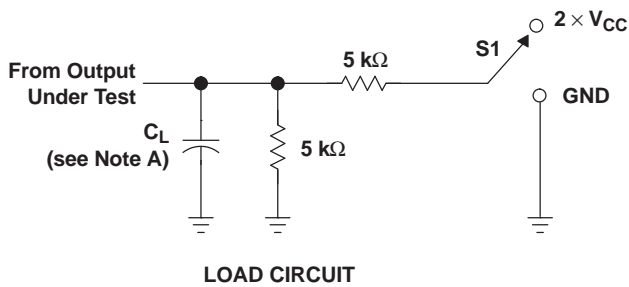
Parameter Measurement Information (continued)

TEST	S1
t_{PLZ}/t_{PZL}	$2 \times V_{CC}$
t_{PHZ}/t_{PZH}	GND

	$V_{CC} = 0.8 \text{ V}$	$V_{CC} = 1.2 \text{ V}$ $\pm 0.1 \text{ V}$	$V_{CC} = 1.5 \text{ V}$ $\pm 0.1 \text{ V}$	$V_{CC} = 1.8 \text{ V}$ $\pm 0.15 \text{ V}$	$V_{CC} = 2.5 \text{ V}$ $\pm 0.2 \text{ V}$	$V_{CC} = 3.3 \text{ V}$ $\pm 0.3 \text{ V}$
C_L	5, 10, 15, 30 pF	5, 10, 15, 30 pF	5, 10, 15, 30 pF	5, 10, 15, 30 pF	5, 10, 15, 30 pF	5, 10, 15, 30 pF
V_M	$V_{CC}/2$	$V_{CC}/2$	$V_{CC}/2$	$V_{CC}/2$	$V_{CC}/2$	$V_{CC}/2$
V_I	V_{CC}	V_{CC}	V_{CC}	V_{CC}	V_{CC}	V_{CC}
V_{Δ}	0.1 V	0.1 V	0.1 V	0.15 V	0.15 V	0.3 V

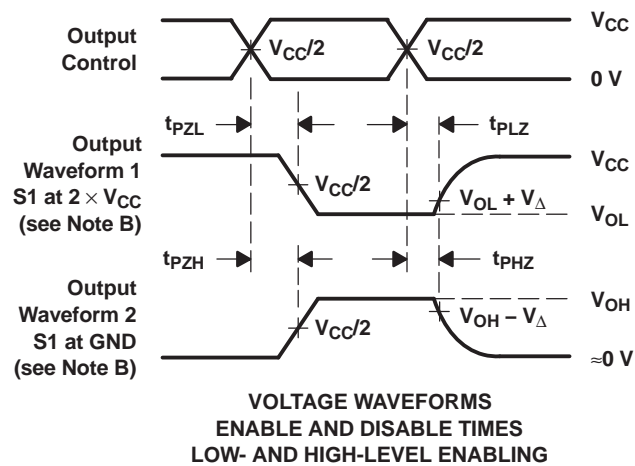

- NOTES:
- C_L includes probe and jig capacitance.
 - Waveform 1 is for an output with internal conditions such that the output is low, except when disabled by the output control. Waveform 2 is for an output with internal conditions such that the output is high, except when disabled by the output control.
 - All input pulses are supplied by generators having the following characteristics: $PRR \leq 10 \text{ MHz}$, $Z_O = 50 \Omega$, $t_r/t_f = 3 \text{ ns}$.
 - The outputs are measured one at a time, with one transition per measurement.
 - t_{PLZ} and t_{PHZ} are the same as t_{dis} .
 - t_{PZL} and t_{PZH} are the same as t_{en} .
 - All parameters and waveforms are not applicable to all devices.

Figure 3. Load Circuit and Voltage Waveforms (Enable and Disable Times)

8 Detailed Description

8.1 Overview

The AUP family is TI's premier solution to the industry's low-power needs in battery-powered portable applications. This family of devices is specified for low static and dynamic power consumption across the entire V_{CC} range of 0.8 V to 3.6 V, resulting in an increased battery life. This product also maintains excellent signal integrity (see [Figure 2](#) and [Figure 3](#)).

The SN74AUP1G125 device contains one buffer gate device with output enable control and performs the Boolean function $Y = A$. This device is fully specified for partial-power-down applications using I_{off} . The I_{off} circuitry disables the outputs when the device is powered down. This inhibits current backflow into the device, which prevents damage to the device.

To assure the high-impedance state during power up or power down, \overline{OE} must be tied to V_{CC} through a pullup resistor; the minimum value of the resistor is determined by the current-sinking capability of the driver.

8.2 Functional Block Diagram

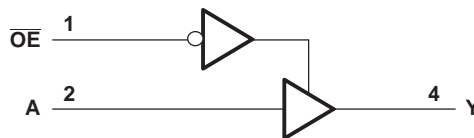

8.3 Feature Description

8.3.1 Balanced High-Drive CMOS Push-Pull Outputs

A balanced output allows the device to sink and source similar currents. The high drive capability of this device creates fast edges into light loads so routing and load conditions should be considered to prevent ringing. Additionally, the outputs of this device are capable of driving larger currents than the device can sustain without being damaged. It is important for the power output of the device to be limited to avoid thermal runaway and damage due to over-current. The electrical and thermal limits defined in the [Absolute Maximum Ratings](#) table must be followed at all times.

8.3.2 Standard CMOS Inputs

Standard CMOS inputs are high impedance and are typically modelled as a resistor in parallel with the input capacitance given in the [Electrical Characteristics, \$T_A = 25^\circ\text{C}\$](#) table. The worst case resistance is calculated with the maximum input voltage, given in the [Absolute Maximum Ratings](#) table, and the maximum input leakage current, given in the [Electrical Characteristics, \$T_A = 25^\circ\text{C}\$](#) table, using ohm's law ($R = V \div I$).

Signals applied to the inputs need to have fast edge rates, as defined by $\Delta t/\Delta v$ in the [Recommended Operating Conditions](#) table to avoid excessive currents and oscillations. If a slow or noisy input signal is required, a device with a Schmitt-trigger input should be used to condition the input signal prior to the standard CMOS input.

8.3.3 Clamp Diodes

The inputs and outputs to this device have negative clamping diodes.

CAUTION

Voltages beyond the values specified in the [Absolute Maximum Ratings](#) table can cause damage to the device. The input negative-voltage and output voltage ratings may be exceeded if the input and output clamp-current ratings are observed.

Feature Description (continued)

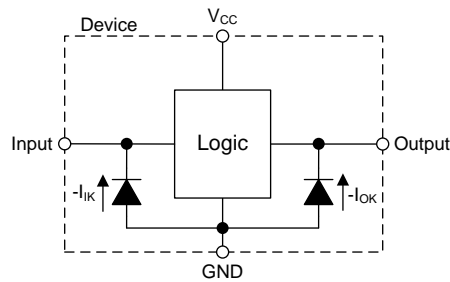

Figure 4. Electrical Placement of Clamping Diodes for Each Input and Output

8.3.4 Partial Power Down (I_{off})

The inputs and outputs for this device enter a high impedance state when the supply voltage is 0 V. The maximum leakage into or out of any input or output pin on the device is specified by I_{off} in the *Electrical Characteristics*, $T_A = 25^\circ\text{C}$ table.

8.3.5 Over-voltage Tolerant Inputs

Input signals to this device can be driven above the supply voltage so long as they remain below the maximum input voltage value specified in the *Absolute Maximum Ratings* table.

8.4 Device Functional Modes

Table 1 lists the functional modes for SN74AUP1G125.

Table 1. Function Table

INPUTS		OUTPUT
$\overline{\text{OE}}$	A	Y
L	H	H
L	L	L
H	X	Hi-Z

9 Application and Implementation

NOTE

Information in the following applications sections is not part of the TI component specification, and TI does not warrant its accuracy or completeness. TI's customers are responsible for determining suitability of components for their purposes. Customers should validate and test their design implementation to confirm system functionality.

9.1 Application Information

The SN74AUP1G125 device is a high-drive CMOS device that is used as an output enabled buffer with a high output drive, such as an LED application. The device can produce 24 mA of drive current at 3.3 V, which is ideal for driving multiple outputs and good for high-speed applications up to 100 MHz. The inputs are 5.5-V tolerant, allowing it to translate down to V_{CC} .

9.2 Typical Application

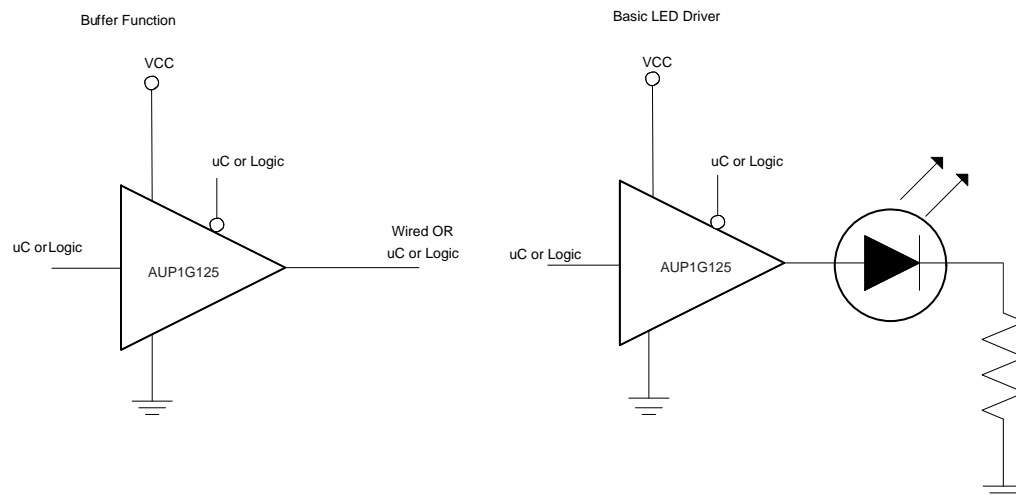

Figure 5. Application Schematic

9.2.1 Design Requirements

This device uses CMOS technology and has balanced output drive. Take care to avoid bus contention because it can drive currents that would exceed maximum limits. The high drive also creates fast edges into light loads so routing and load conditions should be considered to prevent ringing.

9.2.2 Detailed Design Procedure

1. Recommended Input Conditions
 - Rise time and fall time specs. See $(\Delta t/\Delta V)$ in the [Recommended Operating Conditions](#) table.
 - Specified high and low levels. See $(V_{IH}$ and $V_{IL})$ in the [Recommended Operating Conditions](#) table.
 - Inputs are overvoltage tolerant allowing them to go as high as $(V_I \text{ max})$ in the [Recommended Operating Conditions](#) table at any valid V_{CC} .
2. Recommended Output Conditions
 - Load currents should not exceed $(I_O \text{ max})$ per output and should not exceed (Continuous current through V_{CC} or GND) total current for the part. These limits are located in the [Absolute Maximum Ratings](#) table.
 - Outputs should not be pulled above V_{CC} .

Typical Application (continued)

9.2.3 Application Curve

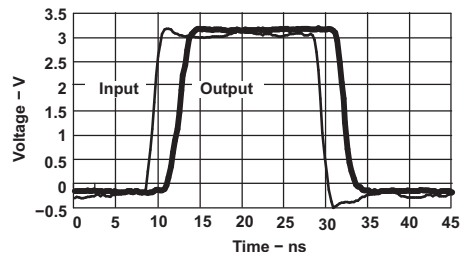

Figure 6. Switching Characteristics at 25 MHz

10 Power Supply Recommendations

The power supply can be any voltage between the minimum and maximum supply voltage rating located in the [Recommended Operating Conditions](#) table.

The VCC pin must have a good bypass capacitor to prevent power disturbance. TI recommends to use a 0.1- μ F capacitor for this device. It is ok to parallel multiple bypass caps to reject different frequencies of noise. 0.1- μ F and 1- μ F capacitors are commonly used in parallel. Install the bypass capacitor as close to the power pin as possible for best results.

11 Layout

11.1 Layout Guidelines

When using multiple bit logic devices, inputs should not float. In many cases, functions or parts of functions of digital logic devices are unused. Some examples are when only two inputs of a triple-input AND gate are used, or when only 3 of the 4-buffer gates are used. Such input pins should not be left unconnected because the undefined voltages at the outside connections result in undefined operational states.

Specified in [Figure 7](#) are rules that must be observed under all circumstances. All unused inputs of digital logic devices must be connected to a high or low bias to prevent the inputs from floating. The logic level that should be applied to any particular unused input depends on the function of the device. The inputs should be tied to GND or V_{CC}, whichever makes more sense or is more convenient.

Even low data rate digital signals can have high frequency signal components due to fast edge rates. When a printed-circuit board (PCB) trace turns a corner at a 90° angle, a reflection can occur. A reflection occurs primarily because of the change of width of the trace. At the apex of the turn, the trace width increases to 1.414 times the width. This increase upsets the transmission-line characteristics, especially the distributed capacitance and self-inductance of the trace which results in the reflection. Not all PCB traces can be straight and therefore some traces must turn corners. [Figure 8](#) shows progressively better techniques of rounding corners. Only the last example (BEST) maintains constant trace width and minimizes reflections.

11.2 Layout Example

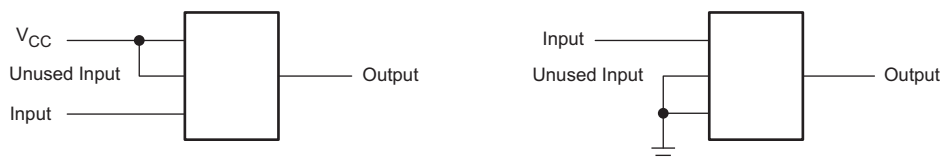

Figure 7. Proper Multi-Gate Input Termination Diagram

Layout Example (continued)

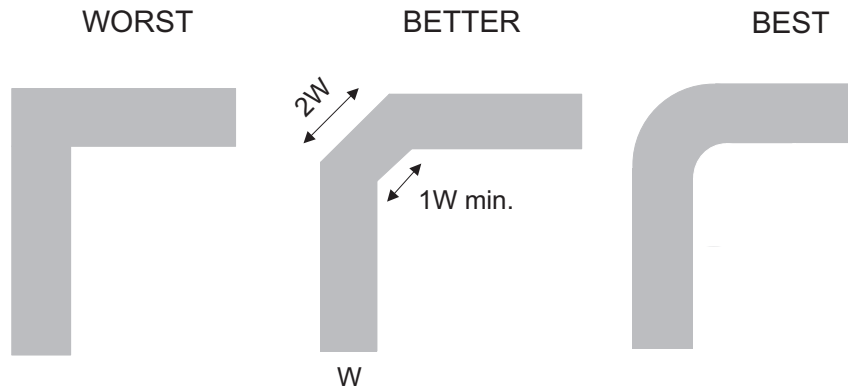

Figure 8. Trace Example

12 Device and Documentation Support

12.1 Documentation Support

12.1.1 Related Documentation

For related documentation, see the following:

[Implications of Slow or Floating CMOS Inputs](#), SCBA004

12.2 Receiving Notification of Documentation Updates

To receive notification of documentation updates, navigate to the device product folder on ti.com. In the upper right corner, click on *Alert me* to register and receive a weekly digest of any product information that has changed. For change details, review the revision history included in any revised document.

12.3 Community Resources

The following links connect to TI community resources. Linked contents are provided "AS IS" by the respective contributors. They do not constitute TI specifications and do not necessarily reflect TI's views; see TI's [Terms of Use](#).

TI E2E™ Online Community *TI's Engineer-to-Engineer (E2E) Community*. Created to foster collaboration among engineers. At e2e.ti.com, you can ask questions, share knowledge, explore ideas and help solve problems with fellow engineers.

Design Support *TI's Design Support* Quickly find helpful E2E forums along with design support tools and contact information for technical support.

12.4 Trademarks

NanoStar, E2E are trademarks of Texas Instruments.
BluRay is a trademark of Blu-ray Disc Association (BDA).
All other trademarks are the property of their respective owners.

12.5 Electrostatic Discharge Caution



These devices have limited built-in ESD protection. The leads should be shorted together or the device placed in conductive foam during storage or handling to prevent electrostatic damage to the MOS gates.

12.6 Glossary

[SLYZ022](#) — *TI Glossary*.

This glossary lists and explains terms, acronyms, and definitions.

13 Mechanical, Packaging, and Orderable Information

The following pages include mechanical, packaging, and orderable information. This information is the most current data available for the designated devices. This data is subject to change without notice and revision of this document. For browser-based versions of this data sheet, refer to the left-hand navigation.

PACKAGING INFORMATION

Orderable part number	Status (1)	Material type (2)	Package Pins	Package qty Carrier	RoHS (3)	Lead finish/ Ball material (4)	MSL rating/ Peak reflow (5)	Op temp (°C)	Part marking (6)
74AUP1G125DCKRG4	Active	Production	SC70 (DCK) 5	3000 LARGE T&R	Yes	NIPDAU	Level-1-260C-UNLIM	-40 to 85	HM5
74AUP1G125DCKRG4.B	Active	Production	SC70 (DCK) 5	3000 LARGE T&R	Yes	NIPDAU	Level-1-260C-UNLIM	-40 to 85	HM5
SN74AUP1G125DBVR	Active	Production	SOT-23 (DBV) 5	3000 LARGE T&R	Yes	NIPDAU SN	Level-1-260C-UNLIM	-40 to 85	H25R
SN74AUP1G125DBVR.B	Active	Production	SOT-23 (DBV) 5	3000 LARGE T&R	Yes	NIPDAU	Level-1-260C-UNLIM	-40 to 85	H25R
SN74AUP1G125DBVT	Active	Production	SOT-23 (DBV) 5	250 SMALL T&R	Yes	NIPDAU SN	Level-1-260C-UNLIM	-40 to 85	H25R
SN74AUP1G125DBVT.B	Active	Production	SOT-23 (DBV) 5	250 SMALL T&R	Yes	NIPDAU	Level-1-260C-UNLIM	-40 to 85	H25R
SN74AUP1G125DCKR	Active	Production	SC70 (DCK) 5	3000 LARGE T&R	Yes	NIPDAU SN	Level-1-260C-UNLIM	-40 to 85	(HM5, HMF, HMK, HM R)
SN74AUP1G125DCKR.B	Active	Production	SC70 (DCK) 5	3000 LARGE T&R	Yes	SN	Level-1-260C-UNLIM	-40 to 85	(HM5, HMF, HMK, HM R)
SN74AUP1G125DCKT	Active	Production	SC70 (DCK) 5	250 SMALL T&R	Yes	NIPDAU	Level-1-260C-UNLIM	-40 to 85	(HM5, HMR)
SN74AUP1G125DCKT.B	Active	Production	SC70 (DCK) 5	250 SMALL T&R	Yes	NIPDAU	Level-1-260C-UNLIM	-40 to 85	(HM5, HMR)
SN74AUP1G125DCKTG4	Active	Production	SC70 (DCK) 5	250 SMALL T&R	Yes	NIPDAU	Level-1-260C-UNLIM	-40 to 85	HM5
SN74AUP1G125DCKTG4.B	Active	Production	SC70 (DCK) 5	250 SMALL T&R	Yes	NIPDAU	Level-1-260C-UNLIM	-40 to 85	HM5
SN74AUP1G125DPWR	Active	Production	X2SON (DPW) 5	3000 LARGE T&R	Yes	NIPDAU	Level-1-260C-UNLIM	-40 to 85	(B, B1)
SN74AUP1G125DPWR.B	Active	Production	X2SON (DPW) 5	3000 LARGE T&R	Yes	NIPDAU	Level-1-260C-UNLIM	-40 to 85	(B, B1)
SN74AUP1G125DRLR	Active	Production	SOT-5X3 (DRL) 5	4000 LARGE T&R	Yes	NIPDAU NIPDAUAG	Level-1-260C-UNLIM	-40 to 85	(HM7, HMR)
SN74AUP1G125DRLR.B	Active	Production	SOT-5X3 (DRL) 5	4000 LARGE T&R	Yes	NIPDAUAG	Level-1-260C-UNLIM	-40 to 85	(HM7, HMR)
SN74AUP1G125DRYR	Active	Production	SON (DRY) 6	5000 LARGE T&R	Yes	NIPDAU NIPDAUAG	Level-1-260C-UNLIM	-40 to 85	HM
SN74AUP1G125DRYR.B	Active	Production	SON (DRY) 6	5000 LARGE T&R	Yes	NIPDAUAG	Level-1-260C-UNLIM	-40 to 85	HM
SN74AUP1G125DRYRG4	Active	Production	SON (DRY) 6	5000 LARGE T&R	Yes	NIPDAU	Level-1-260C-UNLIM	-40 to 85	HM
SN74AUP1G125DRYRG4.B	Active	Production	SON (DRY) 6	5000 LARGE T&R	Yes	NIPDAU	Level-1-260C-UNLIM	-40 to 85	HM
SN74AUP1G125DSFR	Active	Production	SON (DSF) 6	5000 LARGE T&R	Yes	NIPDAU NIPDAUAG	Level-1-260C-UNLIM	-40 to 85	HM
SN74AUP1G125DSFR.B	Active	Production	SON (DSF) 6	5000 LARGE T&R	Yes	NIPDAU	Level-1-260C-UNLIM	-40 to 85	HM
SN74AUP1G125DSFRG4	Active	Production	SON (DSF) 6	5000 LARGE T&R	Yes	NIPDAU	Level-1-260C-UNLIM	-40 to 85	HM
SN74AUP1G125DSFRG4.B	Active	Production	SON (DSF) 6	5000 LARGE T&R	Yes	NIPDAU	Level-1-260C-UNLIM	-40 to 85	HM
SN74AUP1G125YFPR	Active	Production	DSBGA (YFP) 6	3000 LARGE T&R	Yes	SNAGCU	Level-1-260C-UNLIM	-	HMN
SN74AUP1G125YFPR.B	Active	Production	DSBGA (YFP) 6	3000 LARGE T&R	Yes	SNAGCU	Level-1-260C-UNLIM	-40 to 85	HMN
SN74AUP1G125YZPR	Active	Production	DSBGA (YZP) 5	3000 LARGE T&R	Yes	SNAGCU	Level-1-260C-UNLIM	-40 to 85	HMN
SN74AUP1G125YZPR.B	Active	Production	DSBGA (YZP) 5	3000 LARGE T&R	Yes	SNAGCU	Level-1-260C-UNLIM	-40 to 85	HMN

- (1) **Status:** For more details on status, see our [product life cycle](#).
- (2) **Material type:** When designated, preproduction parts are prototypes/experimental devices, and are not yet approved or released for full production. Testing and final process, including without limitation quality assurance, reliability performance testing, and/or process qualification, may not yet be complete, and this item is subject to further changes or possible discontinuation. If available for ordering, purchases will be subject to an additional waiver at checkout, and are intended for early internal evaluation purposes only. These items are sold without warranties of any kind.
- (3) **RoHS values:** Yes, No, RoHS Exempt. See the [TI RoHS Statement](#) for additional information and value definition.
- (4) **Lead finish/Ball material:** Parts may have multiple material finish options. Finish options are separated by a vertical ruled line. Lead finish/Ball material values may wrap to two lines if the finish value exceeds the maximum column width.
- (5) **MSL rating/Peak reflow:** The moisture sensitivity level ratings and peak solder (reflow) temperatures. In the event that a part has multiple moisture sensitivity ratings, only the lowest level per JEDEC standards is shown. Refer to the shipping label for the actual reflow temperature that will be used to mount the part to the printed circuit board.
- (6) **Part marking:** There may be an additional marking, which relates to the logo, the lot trace code information, or the environmental category of the part.

Multiple part markings will be inside parentheses. Only one part marking contained in parentheses and separated by a "~" will appear on a part. If a line is indented then it is a continuation of the previous line and the two combined represent the entire part marking for that device.

Important Information and Disclaimer: The information provided on this page represents TI's knowledge and belief as of the date that it is provided. TI bases its knowledge and belief on information provided by third parties, and makes no representation or warranty as to the accuracy of such information. Efforts are underway to better integrate information from third parties. TI has taken and continues to take reasonable steps to provide representative and accurate information but may not have conducted destructive testing or chemical analysis on incoming materials and chemicals. TI and TI suppliers consider certain information to be proprietary, and thus CAS numbers and other limited information may not be available for release.

In no event shall TI's liability arising out of such information exceed the total purchase price of the TI part(s) at issue in this document sold by TI to Customer on an annual basis.

TAPE AND REEL INFORMATION

QUADRANT ASSIGNMENTS FOR PIN 1 ORIENTATION IN TAPE

*All dimensions are nominal

Device	Package Type	Package Drawing	Pins	SPQ	Reel Diameter (mm)	Reel Width W1 (mm)	A0 (mm)	B0 (mm)	K0 (mm)	P1 (mm)	W (mm)	Pin1 Quadrant
74AUP1G125DCKRG4	SC70	DCK	5	3000	178.0	9.2	2.4	2.4	1.22	4.0	8.0	Q3
SN74AUP1G125DBVR	SOT-23	DBV	5	3000	180.0	8.4	3.2	3.2	1.4	4.0	8.0	Q3
SN74AUP1G125DBVT	SOT-23	DBV	5	250	180.0	8.4	3.2	3.2	1.4	4.0	8.0	Q3
SN74AUP1G125DBVT	SOT-23	DBV	5	250	180.0	8.4	3.2	3.2	1.4	4.0	8.0	Q3
SN74AUP1G125DCKR	SC70	DCK	5	3000	178.0	8.4	2.25	2.45	1.2	4.0	8.0	Q3
SN74AUP1G125DCKT	SC70	DCK	5	250	180.0	8.4	2.47	2.3	1.25	4.0	8.0	Q3
SN74AUP1G125DCKT	SC70	DCK	5	250	178.0	9.2	2.4	2.4	1.22	4.0	8.0	Q3
SN74AUP1G125DCKTG4	SC70	DCK	5	250	178.0	9.2	2.4	2.4	1.22	4.0	8.0	Q3
SN74AUP1G125DPWR	X2SON	DPW	5	3000	178.0	8.4	0.91	0.91	0.5	2.0	8.0	Q3
SN74AUP1G125DPWR	X2SON	DPW	5	3000	180.0	8.4	0.91	0.91	0.5	2.0	8.0	Q3
SN74AUP1G125DRLR	SOT-5X3	DRL	5	4000	180.0	8.4	1.98	1.78	0.69	4.0	8.0	Q3
SN74AUP1G125DRYR	SON	DRY	6	5000	180.0	9.5	1.15	1.6	0.75	4.0	8.0	Q1
SN74AUP1G125DRYRG4	SON	DRY	6	5000	180.0	9.5	1.15	1.6	0.75	4.0	8.0	Q1
SN74AUP1G125DSFR	SON	DSF	6	5000	180.0	8.4	1.16	1.16	0.5	4.0	8.0	Q2
SN74AUP1G125DSFRG4	SON	DSF	6	5000	180.0	8.4	1.16	1.16	0.5	4.0	8.0	Q2
SN74AUP1G125YFPR	DSBGA	YFP	6	3000	178.0	9.2	0.89	1.29	0.62	4.0	8.0	Q1

Device	Package Type	Package Drawing	Pins	SPQ	Reel Diameter (mm)	Reel Width W1 (mm)	A0 (mm)	B0 (mm)	K0 (mm)	P1 (mm)	W (mm)	Pin1 Quadrant
SN74AUP1G125YZPR	DSBGA	YZP	5	3000	178.0	9.2	1.02	1.52	0.63	4.0	8.0	Q1

TAPE AND REEL BOX DIMENSIONS

*All dimensions are nominal

Device	Package Type	Package Drawing	Pins	SPQ	Length (mm)	Width (mm)	Height (mm)
74AUP1G125DCKRG4	SC70	DCK	5	3000	180.0	180.0	18.0
SN74AUP1G125DBVR	SOT-23	DBV	5	3000	210.0	185.0	35.0
SN74AUP1G125DBVT	SOT-23	DBV	5	250	210.0	185.0	35.0
SN74AUP1G125DBVT	SOT-23	DBV	5	250	210.0	185.0	35.0
SN74AUP1G125DCKR	SC70	DCK	5	3000	208.0	191.0	35.0
SN74AUP1G125DCKT	SC70	DCK	5	250	202.0	201.0	28.0
SN74AUP1G125DCKT	SC70	DCK	5	250	180.0	180.0	18.0
SN74AUP1G125DCKTG4	SC70	DCK	5	250	180.0	180.0	18.0
SN74AUP1G125DPWR	X2SON	DPW	5	3000	205.0	200.0	33.0
SN74AUP1G125DPWR	X2SON	DPW	5	3000	210.0	185.0	35.0
SN74AUP1G125DRLR	SOT-5X3	DRL	5	4000	202.0	201.0	28.0
SN74AUP1G125DRYR	SON	DRY	6	5000	184.0	184.0	19.0
SN74AUP1G125DRYRG4	SON	DRY	6	5000	184.0	184.0	19.0
SN74AUP1G125DSFR	SON	DSF	6	5000	210.0	185.0	35.0
SN74AUP1G125DSFRG4	SON	DSF	6	5000	210.0	185.0	35.0
SN74AUP1G125YFPR	DSBGA	YFP	6	3000	220.0	220.0	35.0
SN74AUP1G125YZPR	DSBGA	YZP	5	3000	220.0	220.0	35.0

DRL0005A

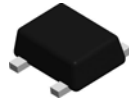

PACKAGE OUTLINE

SOT - 0.6 mm max height

PLASTIC SMALL OUTLINE

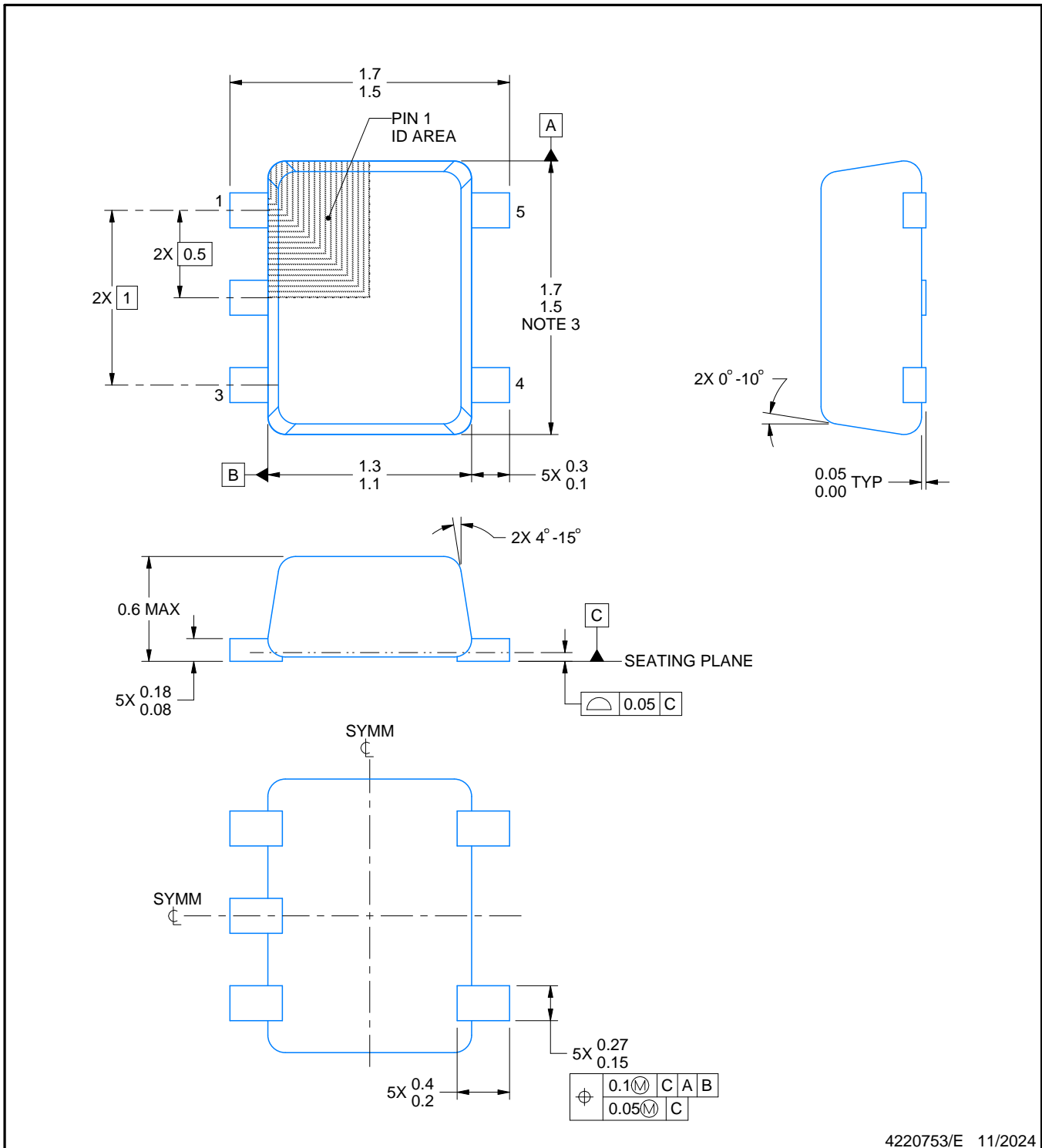

4220753/E 11/2024

NOTES:

1. All linear dimensions are in millimeters. Any dimensions in parenthesis are for reference only. Dimensioning and tolerancing per ASME Y14.5M.
2. This drawing is subject to change without notice.
3. This dimension does not include mold flash, protrusions, or gate burrs. Mold flash, protrusions, or gate burrs shall not exceed 0.15 mm per side.
4. Reference JEDEC registration MO-293 Variation UAAD-1

EXAMPLE BOARD LAYOUT

DRL0005A

SOT - 0.6 mm max height

PLASTIC SMALL OUTLINE

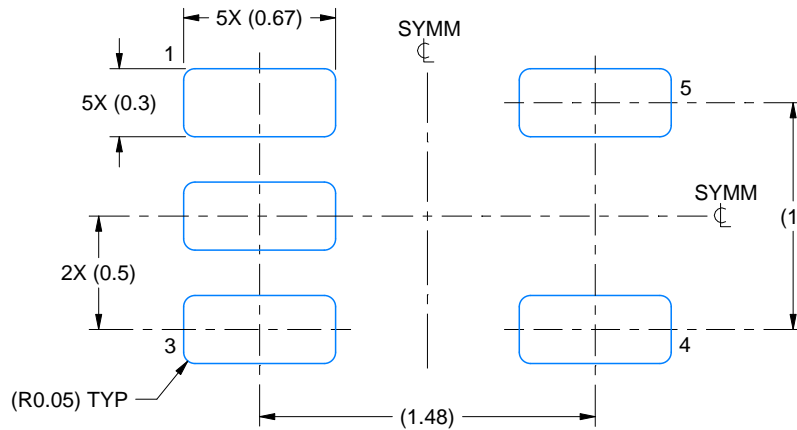

LAND PATTERN EXAMPLE
SCALE:30X

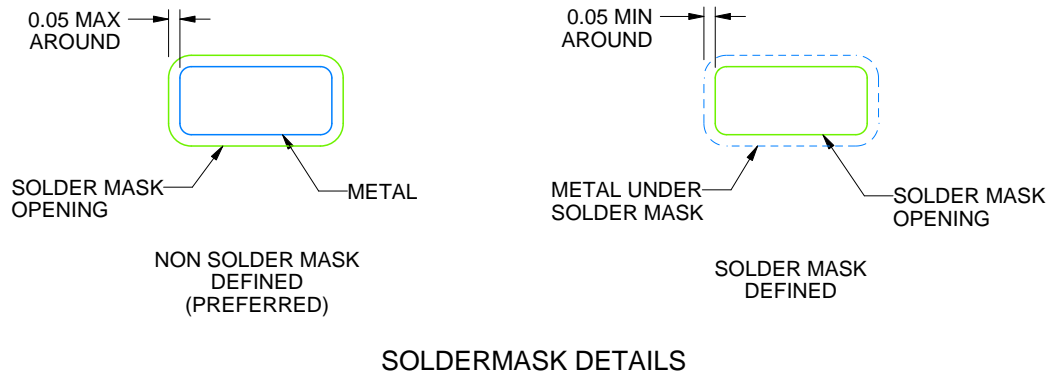

SOLDERMASK DETAILS

4220753/E 11/2024

NOTES: (continued)

- 5. Publication IPC-7351 may have alternate designs.
- 6. Solder mask tolerances between and around signal pads can vary based on board fabrication site.

EXAMPLE STENCIL DESIGN

DRL0005A

SOT - 0.6 mm max height

PLASTIC SMALL OUTLINE

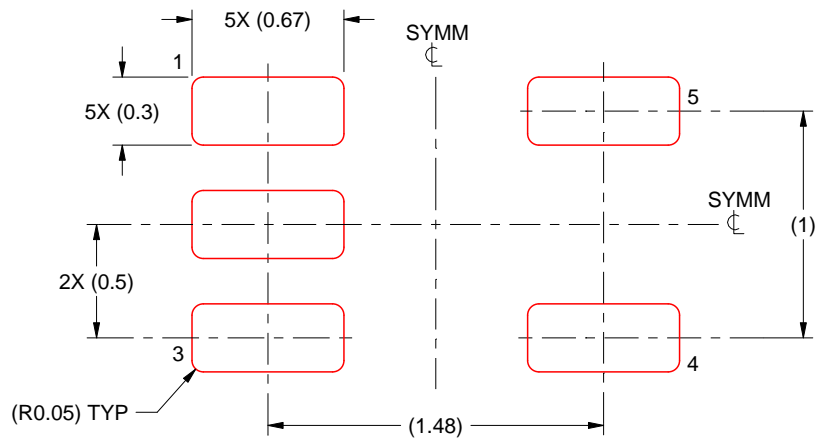

SOLDER PASTE EXAMPLE
BASED ON 0.1 mm THICK STENCIL
SCALE:30X

4220753/E 11/2024

NOTES: (continued)

7. Laser cutting apertures with trapezoidal walls and rounded corners may offer better paste release. IPC-7525 may have alternate design recommendations.
8. Board assembly site may have different recommendations for stencil design.

GENERIC PACKAGE VIEW

DPW 5

X2SON - 0.4 mm max height

PLASTIC SMALL OUTLINE - NO LEAD



Images above are just a representation of the package family, actual package may vary.
Refer to the product data sheet for package details.

4211218-3/D

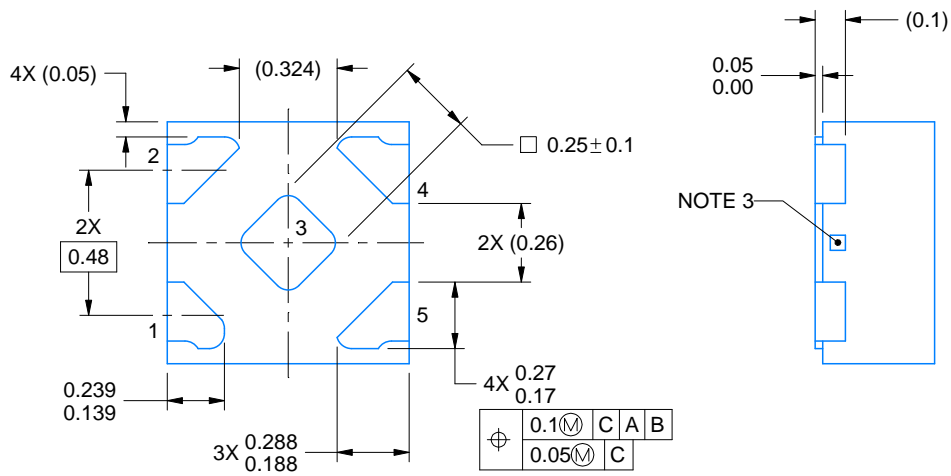
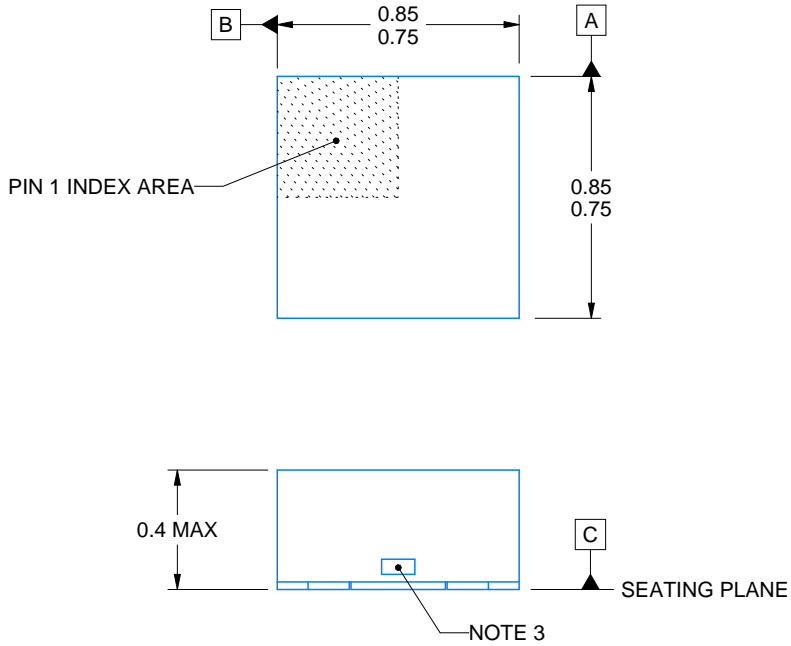

4223102/D 03/2022

NOTES:

1. All linear dimensions are in millimeters. Any dimensions in parenthesis are for reference only. Dimensioning and tolerancing per ASME Y14.5M.
2. This drawing is subject to change without notice.
3. The size and shape of this feature may vary.

EXAMPLE BOARD LAYOUT

DPW0005A

X2SON - 0.4 mm max height

PLASTIC SMALL OUTLINE - NO LEAD

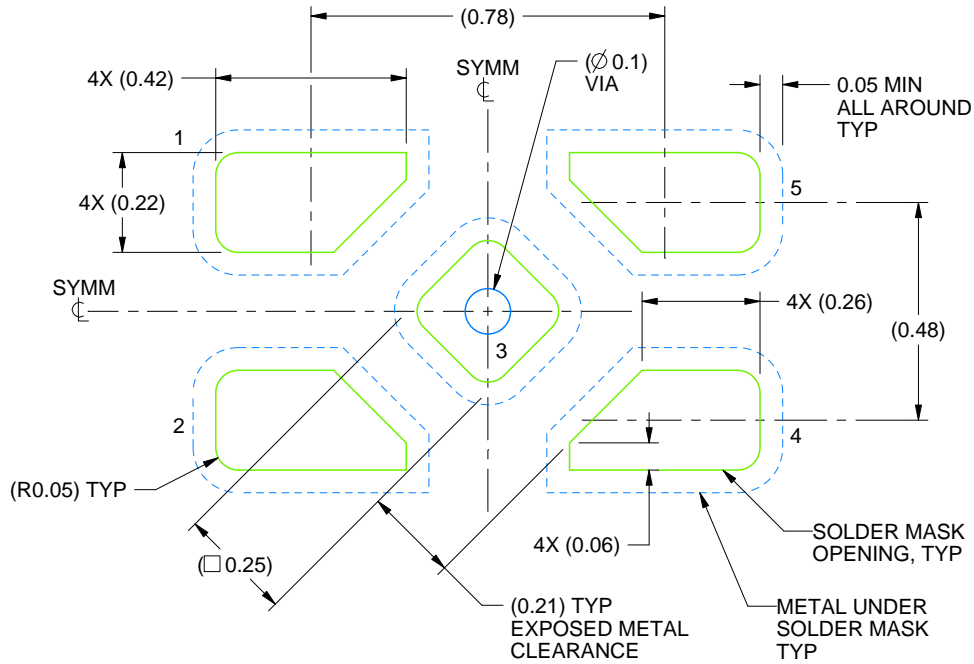

LAND PATTERN EXAMPLE
SOLDER MASK DEFINED
SCALE:60X

4223102/D 03/2022

NOTES: (continued)

4. This package is designed to be soldered to a thermal pad on the board. For more information, refer to QFN/SON PCB application note in literature No. SLUA271 (www.ti.com/lit/slua271).

EXAMPLE STENCIL DESIGN

DPW0005A

X2SON - 0.4 mm max height

PLASTIC SMALL OUTLINE - NO LEAD



SOLDER PASTE EXAMPLE
BASED ON 0.1 mm THICK STENCIL

EXPOSED PAD 3
92% PRINTED SOLDER COVERAGE BY AREA UNDER PACKAGE
SCALE:100X

4223102/D 03/2022

NOTES: (continued)

5. Laser cutting apertures with trapezoidal walls and rounded corners may offer better paste release. IPC-7525 may have alternate design recommendations.

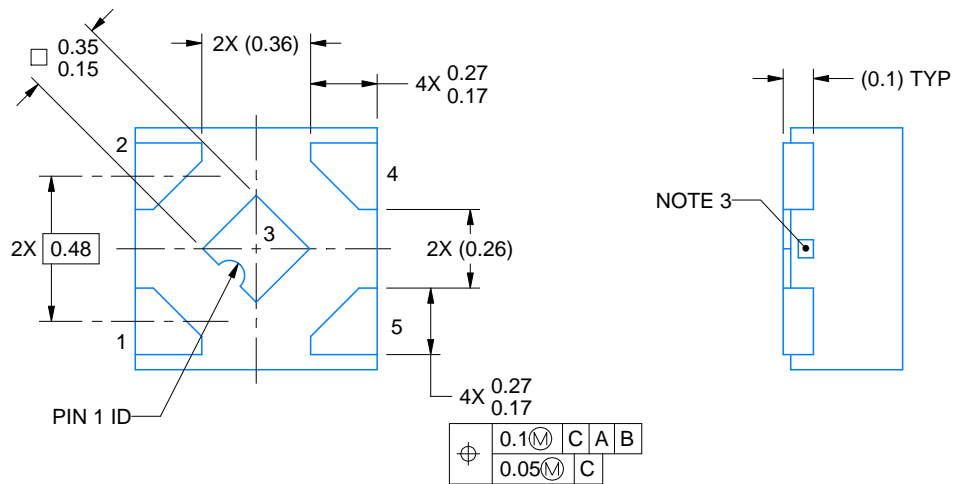
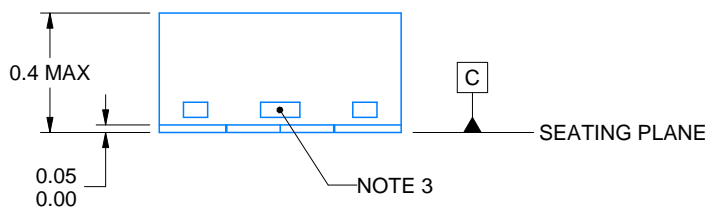
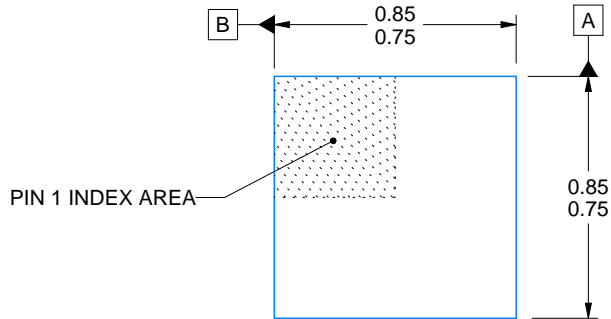
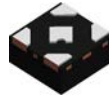

4228233/D 09/2023

NOTES:

1. All linear dimensions are in millimeters. Any dimensions in parenthesis are for reference only. Dimensioning and tolerancing per ASME Y14.5M.
2. This drawing is subject to change without notice.
3. The size and shape of this feature may vary.

EXAMPLE BOARD LAYOUT

DPW0005B

X2SON - 0.4 mm max height

PLASTIC SMALL OUTLINE - NO LEAD

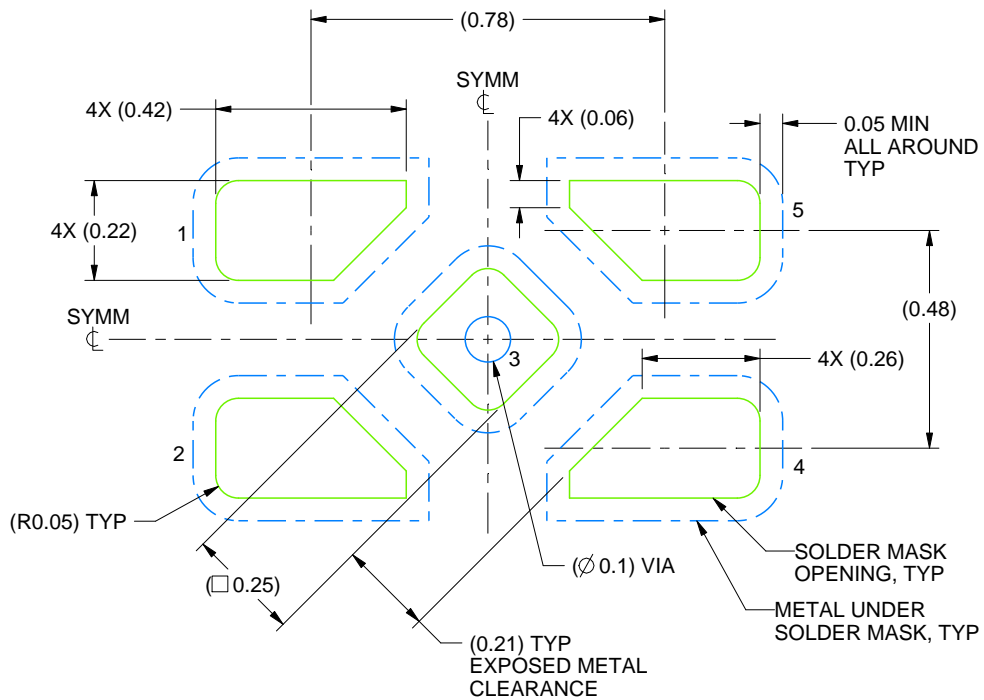

LAND PATTERN EXAMPLE
SOLDER MASK DEFINED
SCALE:60X

4228233/D 09/2023

NOTES: (continued)

4. This package is designed to be soldered to a thermal pad on the board. For more information, refer to QFN/SON PCB application note in literature No. SLUA271 (www.ti.com/lit/sluea271).

EXAMPLE STENCIL DESIGN

DPW0005B

X2SON - 0.4 mm max height

PLASTIC SMALL OUTLINE - NO LEAD

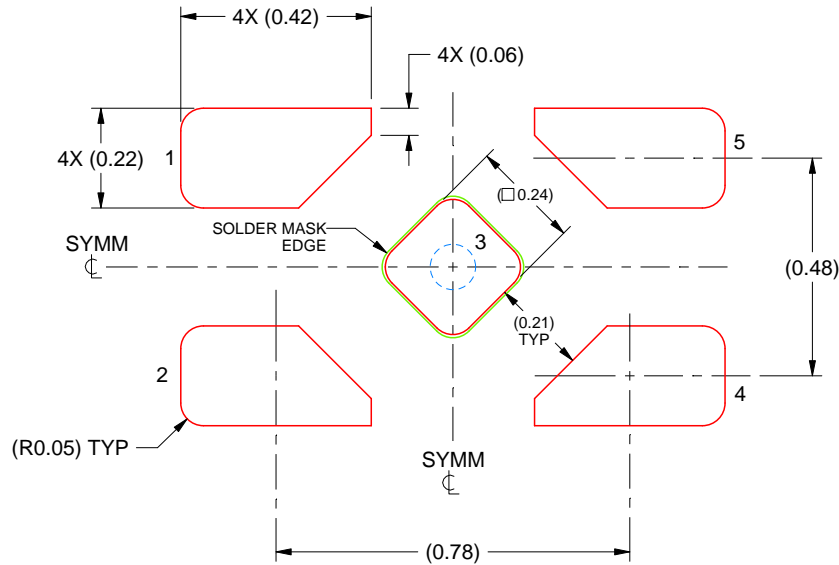

SOLDER PASTE EXAMPLE
BASED ON 0.1 mm THICK STENCIL

EXPOSED PAD 5
92% PRINTED SOLDER COVERAGE BY AREA UNDER PACKAGE
SCALE:60X

4228233/D 09/2023

NOTES: (continued)

5. Laser cutting apertures with trapezoidal walls and rounded corners may offer better paste release. IPC-7525 may have alternate design recommendations.

YZP0005



PACKAGE OUTLINE

DSBGA - 0.5 mm max height

DIE SIZE BALL GRID ARRAY

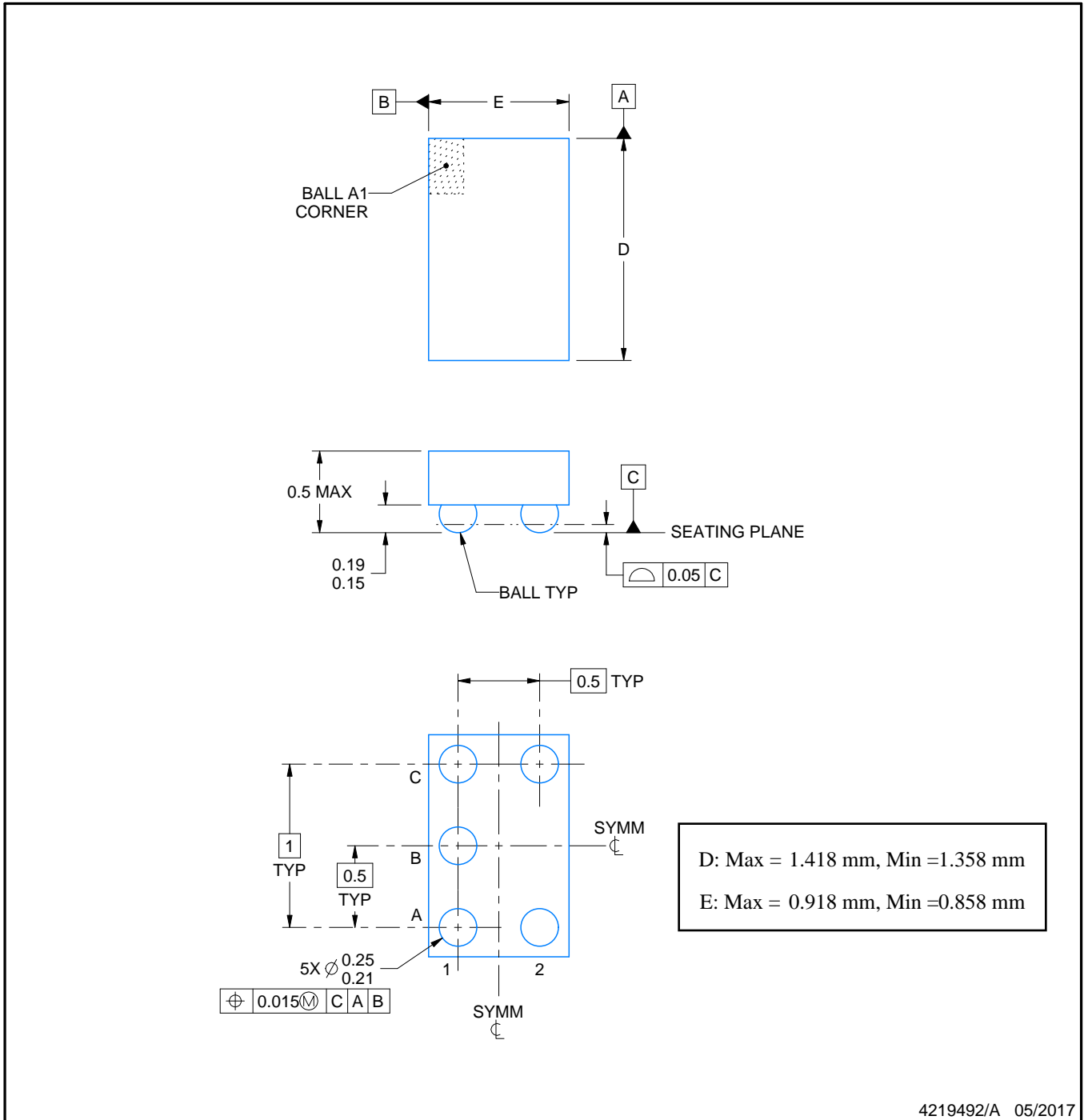

4219492/A 05/2017

NOTES:

- 1. All linear dimensions are in millimeters. Any dimensions in parenthesis are for reference only. Dimensioning and tolerancing per ASME Y14.5M.
- 2. This drawing is subject to change without notice.

EXAMPLE BOARD LAYOUT

YZP0005

DSBGA - 0.5 mm max height

DIE SIZE BALL GRID ARRAY



LAND PATTERN EXAMPLE
SCALE:40X



SOLDER MASK DETAILS
NOT TO SCALE

4219492/A 05/2017

NOTES: (continued)

3. Final dimensions may vary due to manufacturing tolerance considerations and also routing constraints. For more information, see Texas Instruments literature number SNVA009 (www.ti.com/lit/snva009).

EXAMPLE STENCIL DESIGN

YZP0005

DSBGA - 0.5 mm max height

DIE SIZE BALL GRID ARRAY

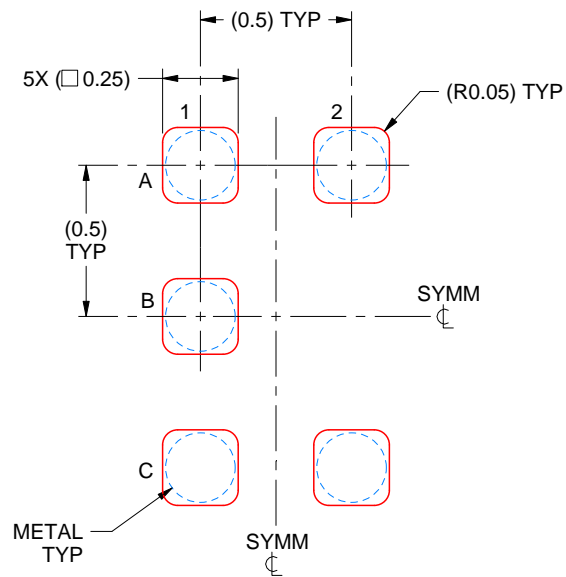

SOLDER PASTE EXAMPLE
BASED ON 0.1 mm THICK STENCIL
SCALE:40X

4219492/A 05/2017

NOTES: (continued)

4. Laser cutting apertures with trapezoidal walls and rounded corners may offer better paste release.

YFP0006

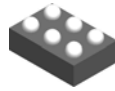

PACKAGE OUTLINE

DSBGA - 0.5 mm max height

DIE SIZE BALL GRID ARRAY

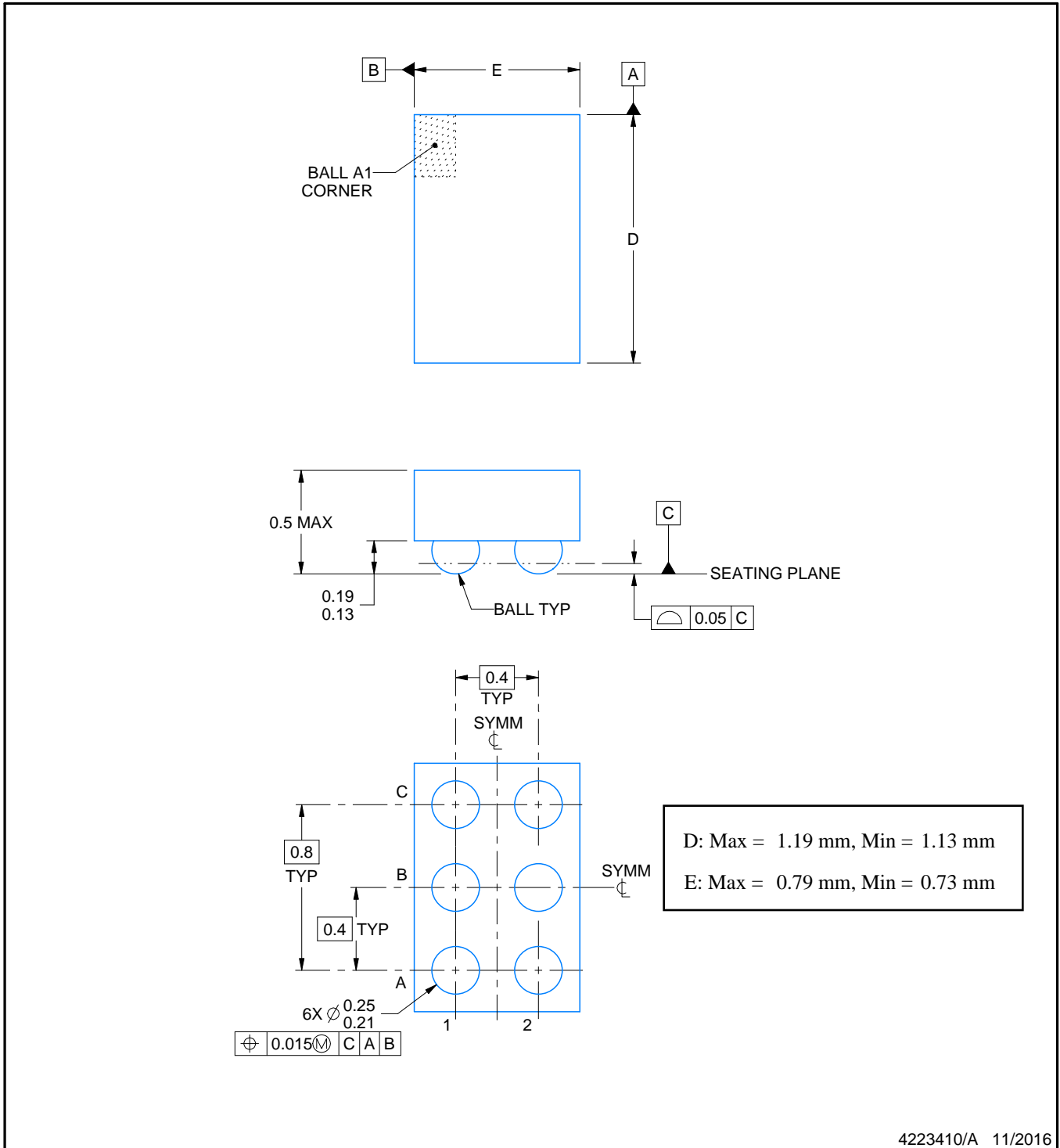

4223410/A 11/2016

NOTES:

1. All linear dimensions are in millimeters. Any dimensions in parenthesis are for reference only. Dimensioning and tolerancing per ASME Y14.5M.
2. This drawing is subject to change without notice.

EXAMPLE BOARD LAYOUT

YFP0006

DSBGA - 0.5 mm max height

DIE SIZE BALL GRID ARRAY



LAND PATTERN EXAMPLE
SCALE:50X

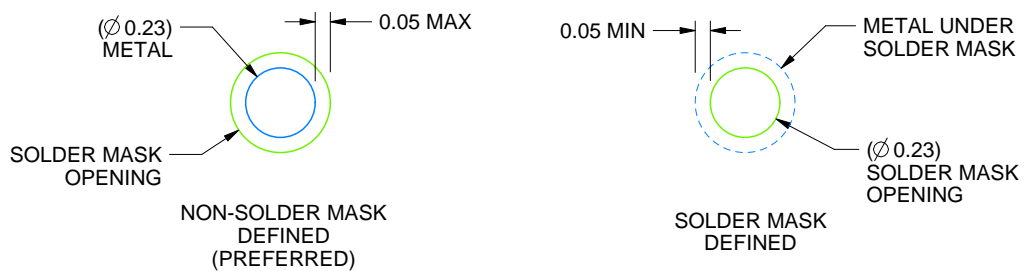

SOLDER MASK DETAILS
NOT TO SCALE

4223410/A 11/2016

NOTES: (continued)

- Final dimensions may vary due to manufacturing tolerance considerations and also routing constraints. For more information, see Texas Instruments literature number SNVA009 (www.ti.com/lit/snva009).

EXAMPLE STENCIL DESIGN

YFP0006

DSBGA - 0.5 mm max height

DIE SIZE BALL GRID ARRAY

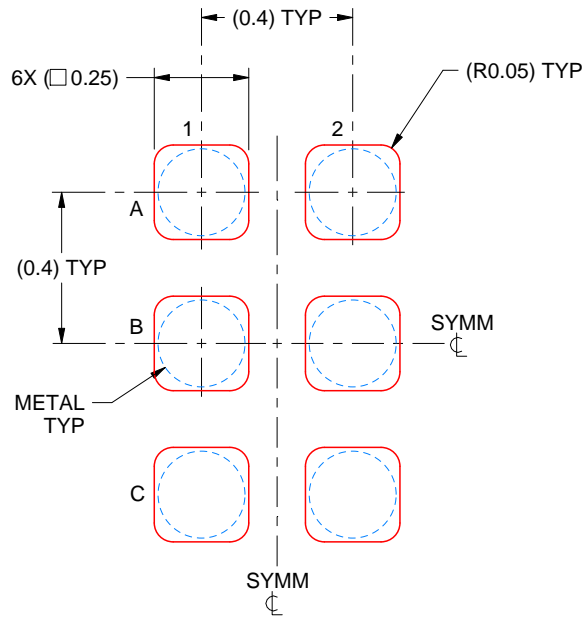

SOLDER PASTE EXAMPLE
BASED ON 0.1 mm THICK STENCIL
SCALE:50X

4223410/A 11/2016

NOTES: (continued)

4. Laser cutting apertures with trapezoidal walls and rounded corners may offer better paste release.

DCK0005A



PACKAGE OUTLINE

SOT - 1.1 max height

SMALL OUTLINE TRANSISTOR

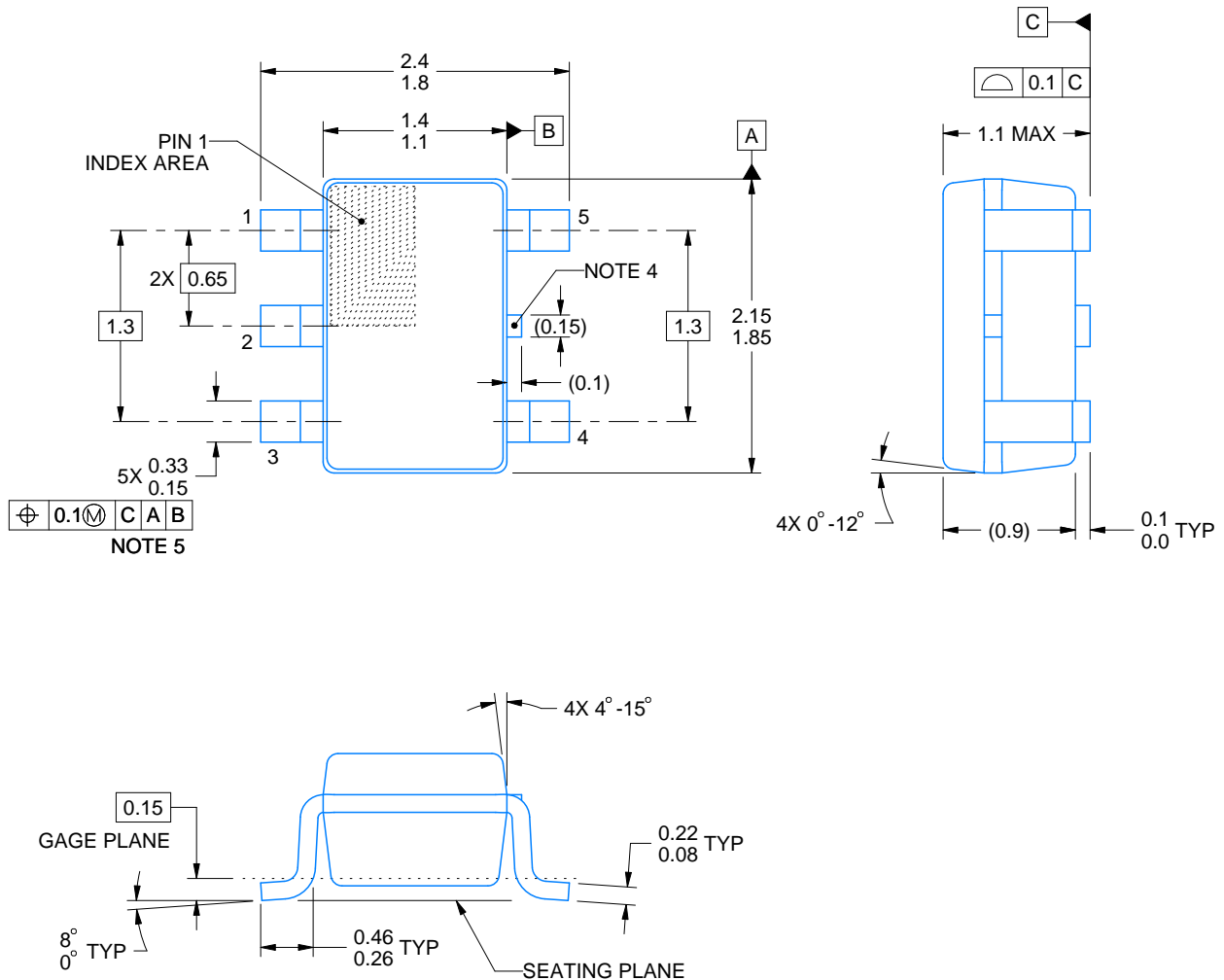

4214834/G 11/2024

NOTES:

1. All linear dimensions are in millimeters. Any dimensions in parenthesis are for reference only. Dimensioning and tolerancing per ASME Y14.5M.
2. This drawing is subject to change without notice.
3. Reference JEDEC MO-203.
4. Support pin may differ or may not be present.
5. Lead width does not comply with JEDEC.
6. Body dimensions do not include mold flash, protrusions, or gate burrs. Mold flash, protrusions, or gate burrs shall not exceed 0.25mm per side

EXAMPLE BOARD LAYOUT

DCK0005A

SOT - 1.1 max height

SMALL OUTLINE TRANSISTOR

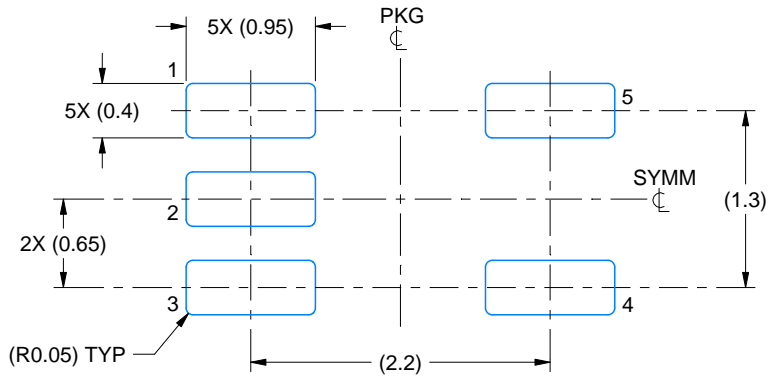

LAND PATTERN EXAMPLE
EXPOSED METAL SHOWN
SCALE:18X

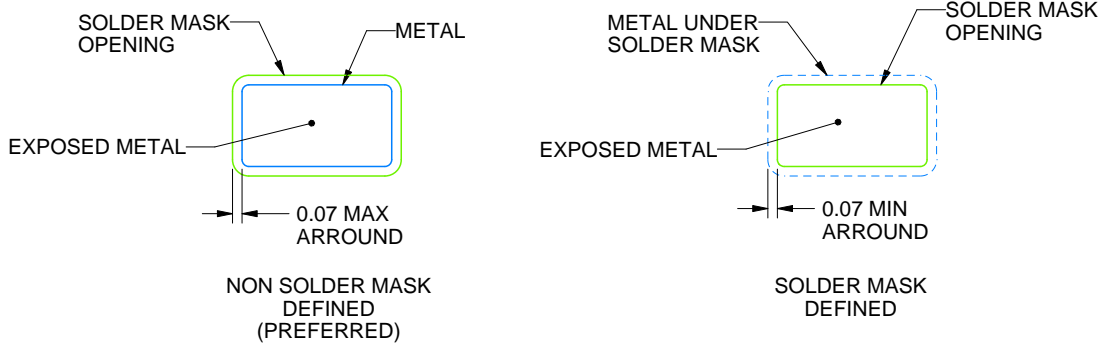

SOLDER MASK DETAILS

4214834/G 11/2024

NOTES: (continued)

- 7. Publication IPC-7351 may have alternate designs.
- 8. Solder mask tolerances between and around signal pads can vary based on board fabrication site.

EXAMPLE STENCIL DESIGN

DCK0005A

SOT - 1.1 max height

SMALL OUTLINE TRANSISTOR

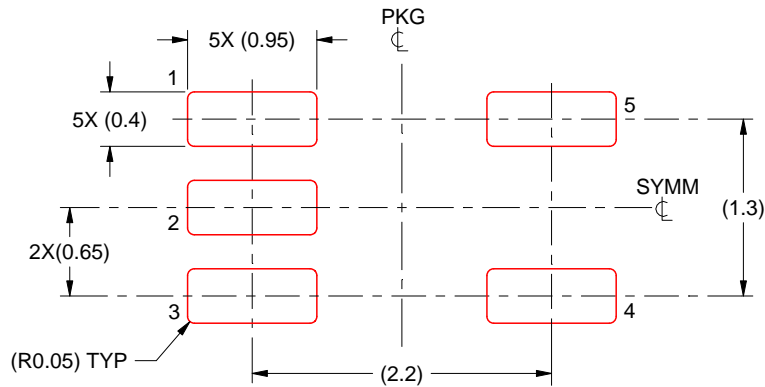

SOLDER PASTE EXAMPLE
BASED ON 0.125 THICK STENCIL
SCALE: 18X

4214834/G 11/2024

NOTES: (continued)

9. Laser cutting apertures with trapezoidal walls and rounded corners may offer better paste release. IPC-7525 may have alternate design recommendations.
10. Board assembly site may have different recommendations for stencil design.

EXAMPLE BOARD LAYOUT

DBV0005A

SOT-23 - 1.45 mm max height

SMALL OUTLINE TRANSISTOR



LAND PATTERN EXAMPLE
EXPOSED METAL SHOWN
SCALE:15X



SOLDER MASK DETAILS

4214839/K 08/2024

NOTES: (continued)

- 6. Publication IPC-7351 may have alternate designs.
- 7. Solder mask tolerances between and around signal pads can vary based on board fabrication site.

EXAMPLE STENCIL DESIGN

DBV0005A

SOT-23 - 1.45 mm max height

SMALL OUTLINE TRANSISTOR



SOLDER PASTE EXAMPLE
BASED ON 0.125 mm THICK STENCIL
SCALE:15X

4214839/K 08/2024

NOTES: (continued)

8. Laser cutting apertures with trapezoidal walls and rounded corners may offer better paste release. IPC-7525 may have alternate design recommendations.
9. Board assembly site may have different recommendations for stencil design.

GENERIC PACKAGE VIEW

DRY 6

USON - 0.6 mm max height

PLASTIC SMALL OUTLINE - NO LEAD



Images above are just a representation of the package family, actual package may vary.
Refer to the product data sheet for package details.

4207181/G

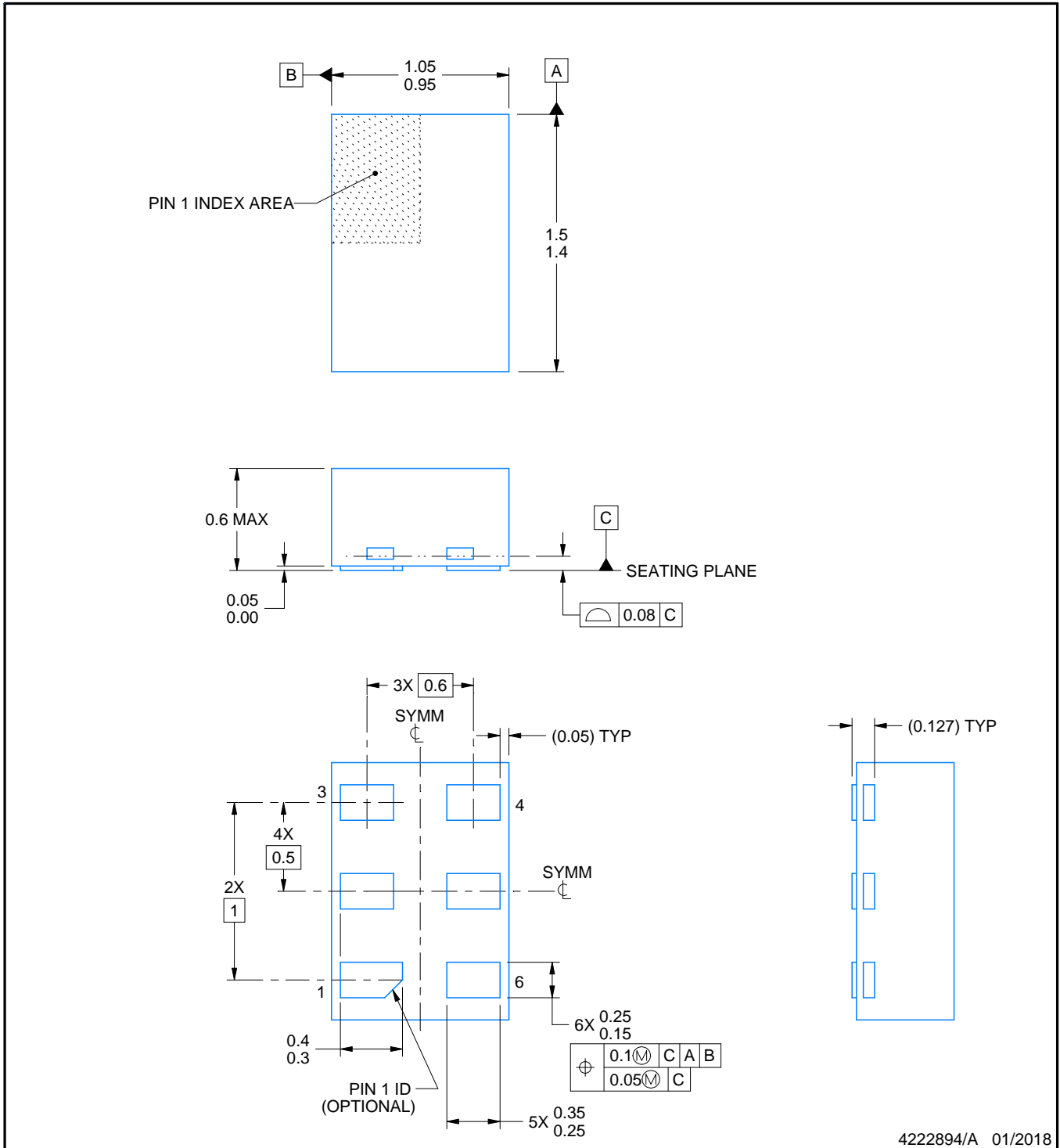

NOTES:

1. All linear dimensions are in millimeters. Any dimensions in parenthesis are for reference only. Dimensioning and tolerancing per ASME Y14.5M.
2. This drawing is subject to change without notice.

EXAMPLE BOARD LAYOUT

DRY0006A

USON - 0.6 mm max height

PLASTIC SMALL OUTLINE - NO LEAD



LAND PATTERN EXAMPLE
1:1 RATIO WITH PKG SOLDER PADS
EXPOSED METAL SHOWN
SCALE:40X



SOLDER MASK DETAILS

4222894/A 01/2018

NOTES: (continued)

3. For more information, see QFN/SON PCB application report in literature No. SLUA271 (www.ti.com/lit/slue271).

EXAMPLE STENCIL DESIGN

DRY0006A

USON - 0.6 mm max height

PLASTIC SMALL OUTLINE - NO LEAD

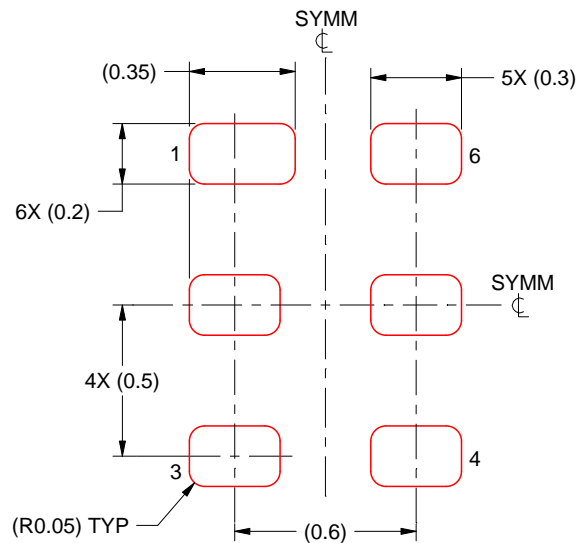

SOLDER PASTE EXAMPLE
BASED ON 0.075 - 0.1 mm THICK STENCIL
SCALE:40X

4222894/A 01/2018

NOTES: (continued)

4. Laser cutting apertures with trapezoidal walls and rounded corners may offer better paste release. IPC-7525 may have alternate design recommendations.

EXAMPLE BOARD LAYOUT

DSF0006A

X2SON - 0.4 mm max height

PLASTIC SMALL OUTLINE - NO LEAD



LAND PATTERN EXAMPLE
EXPOSED METAL SHOWN
SCALE:40X



SOLDER MASK DETAILS

4220597/B 06/2022

NOTES: (continued)

4. For more information, see Texas Instruments literature number SLUA271 (www.ti.com/lit/slua271).

EXAMPLE STENCIL DESIGN

DSF0006A

X2SON - 0.4 mm max height

PLASTIC SMALL OUTLINE - NO LEAD



SOLDER PASTE EXAMPLE
BASED ON 0.09 mm THICK STENCIL

PRINTED SOLDER COVERAGE BY AREA UNDER PACKAGE
SCALE:40X

4220597/B 06/2022

4. Laser cutting apertures with trapezoidal walls and rounded corners may offer better paste release. IPC-7525 may have alternate design recommendations.

IMPORTANT NOTICE AND DISCLAIMER

TI PROVIDES TECHNICAL AND RELIABILITY DATA (INCLUDING DATASHEETS), DESIGN RESOURCES (INCLUDING REFERENCE DESIGNS), APPLICATION OR OTHER DESIGN ADVICE, WEB TOOLS, SAFETY INFORMATION, AND OTHER RESOURCES "AS IS" AND WITH ALL FAULTS, AND DISCLAIMS ALL WARRANTIES, EXPRESS AND IMPLIED, INCLUDING WITHOUT LIMITATION ANY IMPLIED WARRANTIES OF MERCHANTABILITY, FITNESS FOR A PARTICULAR PURPOSE OR NON-INFRINGEMENT OF THIRD PARTY INTELLECTUAL PROPERTY RIGHTS.

These resources are intended for skilled developers designing with TI products. You are solely responsible for (1) selecting the appropriate TI products for your application, (2) designing, validating and testing your application, and (3) ensuring your application meets applicable standards, and any other safety, security, regulatory or other requirements.

These resources are subject to change without notice. TI grants you permission to use these resources only for development of an application that uses the TI products described in the resource. Other reproduction and display of these resources is prohibited. No license is granted to any other TI intellectual property right or to any third party intellectual property right. TI disclaims responsibility for, and you fully indemnify TI and its representatives against any claims, damages, costs, losses, and liabilities arising out of your use of these resources.

TI's products are provided subject to [TI's Terms of Sale](#), [TI's General Quality Guidelines](#), or other applicable terms available either on [ti.com](#) or provided in conjunction with such TI products. TI's provision of these resources does not expand or otherwise alter TI's applicable warranties or warranty disclaimers for TI products. Unless TI explicitly designates a product as custom or customer-specified, TI products are standard, catalog, general purpose devices.

TI objects to and rejects any additional or different terms you may propose.

Copyright © 2026, Texas Instruments Incorporated

Last updated 10/2025