

## SN74LV1T126 具有三态输出 CMOS 逻辑电平转换器的单电源单路缓冲器门

### 1 特性

- $V_{CC}$  为 5V、3.3V、2.5V 和 1.8V 的单电源电压转换器
- 工作电压范围为 1.8V 至 5.5V
- 升压转换：
  - 1.8V  $V_{CC}$  时，1.2V<sup>(1)</sup> 至 1.8V
  - 2.5V  $V_{CC}$  时 1.5V<sup>(1)</sup> 至 2.5V
  - 3.3V  $V_{CC}$  时，1.8V<sup>(1)</sup> 至 3.3V
  - 5.0V  $V_{CC}$  时，3.3V 至 5.0V
- 降压转换：
  - 1.8V  $V_{CC}$  时，3.3V 至 1.8V
  - 2.5V  $V_{CC}$  时，3.3V 至 2.5V
  - 3.3V  $V_{CC}$  时，5.0V 至 3.3V
- 逻辑输出以  $V_{CC}$  为基准
- 输出驱动：
  - 电压为 5V 时，输出驱动为 8mA
  - 电压为 3.3V 时，输出驱动为 7mA
  - 电压为 1.8V 时，输出驱动为 3mA
- 3.3V  $V_{CC}$  时，频率高达 50MHz
- 输入引脚可耐受 5V 电压

- -40°C 至 125°C 工作温度范围
- 闩锁性能超过 250mA，符合 JESD 17 规范
- 支持标准逻辑引脚排列
- 与 AUP1G 和 LVC1G 系列兼容的 CMOS 输出 B<sup>1</sup>

### 2 应用

- 电信
- 便携式应用
- 服务器
- PC 和笔记本电脑

### 3 说明

SN74LV1T126 是一款具有低输入阈值的单路缓冲器门，可支持电压转换应用。

#### 封装信息

| 器件型号        | 封装 <sup>(1)</sup> | 封装尺寸 <sup>(2)</sup> | 封装尺寸 <sup>(3)</sup> |
|-------------|-------------------|---------------------|---------------------|
| SN74LV1T126 | DBV ( SOT-23, 5 ) | 2.90mm x 2.8mm      | 2.9mm x 1.6mm       |
|             | DCK ( SC70, 5 )   | 2.00mm x 2.1mm      | 2mm x 1.25mm        |

- (1) 更多相关信息，请参阅第 12 节。
- (2) 封装尺寸 (长 × 宽) 为标称值，并包括引脚 (如适用)。
- (3) 封装尺寸 (长 × 宽) 为标称值，不包括引脚。

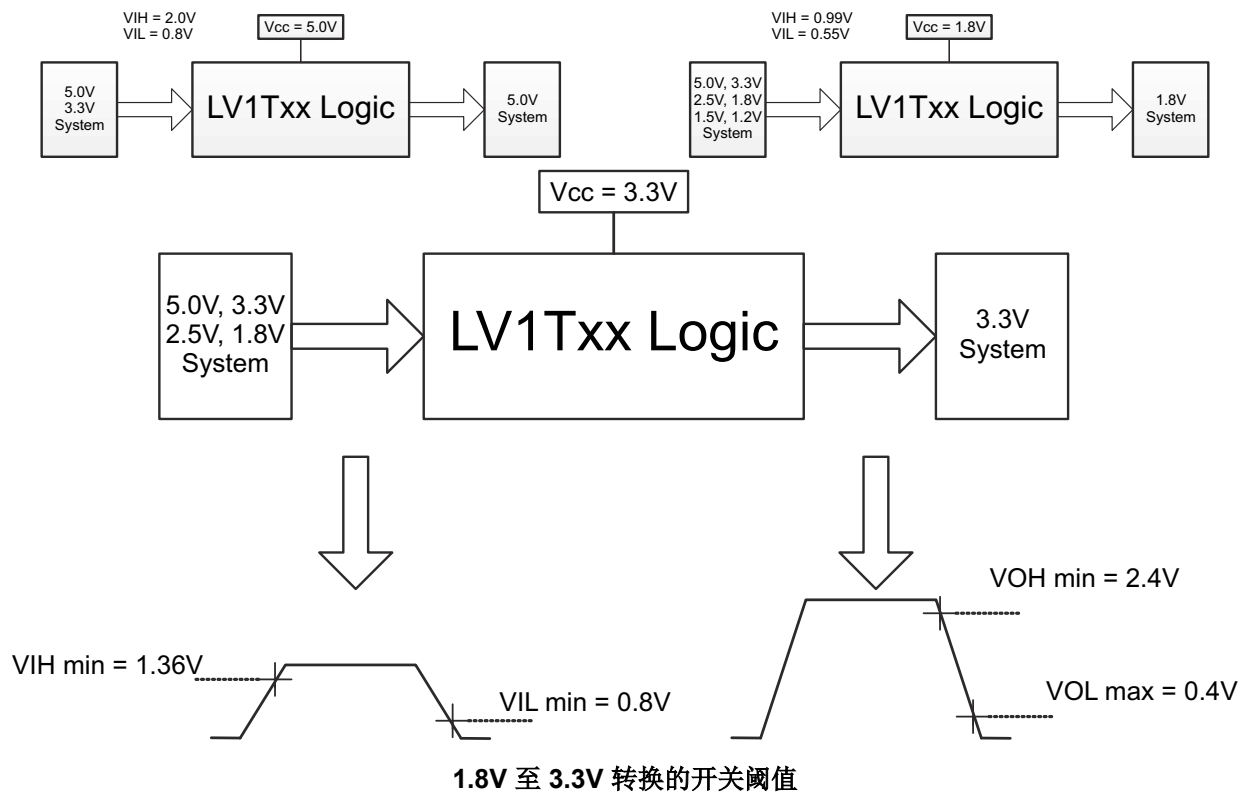

<sup>1</sup> 请参考较低  $V_{CC}$  条件下的  $V_{IH}/V_{IL}$  和输出驱动。



## Table of Contents

|  |           |  |           |
|--|-----------|--|-----------|
| <b>1 特性</b> .....                                | <b>1</b>  | <b>8.2 Functional Block Diagram</b> .....                        | <b>11</b> |
| <b>2 应用</b> .....                                | <b>1</b>  | <b>8.3 Feature Description</b> .....                             | <b>11</b> |
| <b>3 说明</b> .....                                | <b>1</b>  | <b>8.4 Device Functional Modes</b> .....                         | <b>14</b> |
| <b>4 Related Products</b> .....                  | <b>3</b>  | <b>9 应用信息免责声明</b> .....  | <b>16</b> |
| <b>5 Pin Configuration and Functions</b> .....   | <b>4</b>  | 9.1 Power Supply Recommendations.....                            | 16        |
| <b>6 Specifications</b> .....                    | <b>5</b>  | 9.2 Layout.....  | 16        |
| 6.1 Absolute Maximum Ratings.....                | 5         | <b>10 Device and Documentation Support</b> .....                 | <b>17</b> |
| 6.2 ESD Ratings.....                             | 5         | 10.1 Documentation Support (Analog).....                         | 17        |
| 6.3 Recommended Operating Conditions.....        | 5         | 10.2 接收文档更新通知.....   | 17        |
| 6.4 Thermal Information.....                     | 6         | 10.3 支持资源.....   | 17        |
| 6.5 Electrical Characteristics.....              | 6         | 10.4 Trademarks.....   | 17        |
| 6.6 Switching Characteristics.....               | 7         | 10.5 静电放电警告.....   | 17        |
| 6.7 Operating Characteristics.....               | 8         | 10.6 术语表.....  | 17        |
| 6.8 Typical Characteristics.....                 | 9         | <b>11 Revision History</b> .....                                 | <b>17</b> |
| <b>7 Parameter Measurement Information</b> ..... | <b>10</b> | <b>12 Mechanical, Packaging, and Orderable Information</b> ..... | <b>18</b> |
| <b>8 Detailed Description</b> .....              | <b>11</b> |  |           |
| 8.1 Overview.....                                | 11        |  |           |

## 4 Related Products

| DEVICE      | PACKAGE  | DESCRIPTION                                    |
|-------------|----------|--|
| SN74LV1T00  | DCK, DBV | 2-Input Positive-NAND Gate                     |
| SN74LV1T02  | DCK, DBV | 2-Input Positive-NOR Gate                      |
| SN74LV1T04  | DCK, DBV | Inverter Gate                                  |
| SN74LV1T08  | DCK, DBV | 2-Input Positive-AND Gate                      |
| SN74LV1T17  | DCK, DBV | Single Schmitt-Trigger Buffer Gate             |
| SN74LV1T14  | DCK, DBV | Single Schmitt-Trigger Inverter Gate           |
| SN74LV1T32  | DCK, DBV | 2-Input Positive-OR Gate                       |
| SN74LV1T34  | DCK, DBV | Single Buffer Gate                             |
| SN74LV1T86  | DCK, DBV | Single 2-Input Exclusive-Or Gate               |
| SN74LV1T125 | DCK, DBV | Single Buffer Gate with 3-state Output         |
| SN74LV1T126 | DCK, DBV | Single Buffer Gate with 3-state Output         |
| SN74LV4T125 | RGY, PW  | Quadruple Bus Buffer Gate With 3-State Outputs |

## 5 Pin Configuration and Functions



图 5-1. DCK or DBV Package, 5-Pin SC70 or SOT-23 (Top View)

表 5-1. Pin Functions

| PIN             |     | TYPE <sup>(1)</sup> | DESCRIPTION                |
|-----------------|-----|---------------------|----------------------------|
| NAME            | NO. |                     |                            |
| OE              | 1   | I                   | Output enable, active high |
| A               | 2   | I                   | Input A                    |
| GND             | 3   | G                   | Ground                     |
| Y               | 4   | O                   | Output Y                   |
| V <sub>CC</sub> | 5   | P                   | Positive supply            |

(1) I = Input, O = Output, I/O = Input or Output, G = Ground, P = Power.

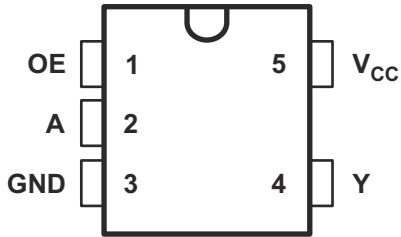
## 6 Specifications

### 6.1 Absolute Maximum Ratings

over operating free-air temperature range (unless otherwise noted)<sup>(1)</sup>

|                  |   | MIN  | MAX                   | UNIT    |
|------------------|---|--|-----------------------|---------|
| V <sub>CC</sub>  | Supply voltage range  | - 0.5  | 7.0                   | V       |
| V <sub>I</sub>   | Input voltage range <sup>(2)</sup>  | - 0.5  | 7.0                   | V       |
| V <sub>O</sub>   | Voltage range applied to any output in the high-impedance or power-off state <sup>(2)</sup> | - 0.5  | 4.6                   | V       |
|                  | Voltage range applied to any output in the high or low state <sup>(2)</sup>                 | - 0.5  | V <sub>CC</sub> + 0.5 |         |
| I <sub>IK</sub>  | Input clamp current   | V <sub>I</sub> < 0                                     |                       | - 20 mA |
| I <sub>OK</sub>  | Output clamp current  | V <sub>O</sub> < 0 or V <sub>O</sub> > V <sub>CC</sub> |                       | ±20 mA  |
| I <sub>O</sub>   | Continuous output current   |  |                       | ±25 mA  |
|                  | Continuous current through V <sub>CC</sub> or GND   |  |                       | ±50 mA  |
| T <sub>J</sub>   | Junction temperature  |  |                       | 150 °C  |
| T <sub>stg</sub> | Storage temperature   | - 65   | 150                   | °C      |

- (1) Stresses beyond those listed under *Absolute Maximum Ratings* may cause permanent damage to the device. These are stress ratings only, and functional operation of the device at these or any other conditions beyond those indicated under *Recommended Operating Conditions* is not implied. Exposure to absolute-maximum-rated conditions for extended periods may affect device reliability.
- (2) The input negative-voltage and output voltage ratings may be exceeded if the input and output current ratings are observed.

### 6.2 ESD Ratings

|                    |                         | VALUE   | UNIT  |
|--------------------|-------------------------|---|-------|
| V <sub>(ESD)</sub> | Electrostatic discharge | Human-body model (HBM), per ANSI/ESDA/JEDEC JS-001 <sup>(1)</sup>     | ±2000 |
|                    |                         | Machine Model (MM), per JEDEC specification                           | ±200  |
|                    |                         | Charged-device model (CDM), per ANSI/ESDA/JEDEC JS-002 <sup>(2)</sup> | ±1000 |

- (1) JEDEC document JEP155 states that 500-V HBM allows safe manufacturing with a standard ESD control process.
- (2) JEDEC document JEP157 states that 250-V CDM allows safe manufacturing with a standard ESD control process.

### 6.3 Recommended Operating Conditions

over operating free-air temperature range (unless otherwise noted)<sup>(1)</sup>

|                 |                                    | MIN                              | MAX             | UNIT |
|-----------------|------------------------------------|----------------------------------|-----------------|------|
| V <sub>CC</sub> | Supply voltage                     | 1.6                              | 5.5             | V    |
| V <sub>I</sub>  | Input voltage                      | 0                                | 5.5             | V    |
| V <sub>O</sub>  | Output voltage                     | 0                                | V <sub>CC</sub> | V    |
| I <sub>OH</sub> | High-level output current          | V <sub>CC</sub> = 1.8 V          |                 | - 3  |
|                 |                                    | V <sub>CC</sub> = 2.5 V          |                 | - 5  |
|                 |                                    | V <sub>CC</sub> = 3.3 V          |                 | - 7  |
|                 |                                    | V <sub>CC</sub> = 5.0 V          |                 | - 8  |
| I <sub>OL</sub> | Low-level output current           | V <sub>CC</sub> = 1.8 V          |                 | 3    |
|                 |                                    | V <sub>CC</sub> = 2.5 V          |                 | 5    |
|                 |                                    | V <sub>CC</sub> = 3.3 V          |                 | 7    |
|                 |                                    | V <sub>CC</sub> = 5.0 V          |                 | 8    |
| Δt/Δv           | Input transition rise or fall rate | V <sub>CC</sub> = 1.8 V          |                 | 20   |
|                 |                                    | V <sub>CC</sub> = 3.3 V or 2.5 V |                 | 20   |
|                 |                                    | V <sub>CC</sub> = 5.0 V          |                 | 20   |

over operating free-air temperature range (unless otherwise noted) <sup>(1)</sup>

|                |                                | MIN  | MAX | UNIT |
|----------------|--------------------------------|------|-----|------|
| T <sub>A</sub> | Operating free-air temperature | - 40 | 125 | °C   |

(1) All unused inputs of the device must be held at V<sub>CC</sub> or GND to ensure proper device operation. Refer to the TI application report, *Implications of Slow or Floating CMOS Inputs*, literature number [SCBA004](#).

## 6.4 Thermal Information

| THERMAL METRIC <sup>(1)</sup> |  | DBV    | DCK    | UNIT |
|-------------------------------|--|--------|--------|------|
|                               |  | 5 PINS | 5 PINS |      |
| R <sub>θJA</sub>              | Junction-to-ambient thermal resistance | 278    | 289.2  | °C/W |

(1) For more information about traditional and new thermal metrics, see the *IC Package Thermal Metrics* application report, [SPRA953](#).

## 6.5 Electrical Characteristics

over recommended operating free-air temperature range (unless otherwise noted)

| PARAMETER                | TEST CONDITIONS           | V <sub>CC</sub>                                  | T <sub>A</sub> = 25°C           |                       |     | T <sub>A</sub> = - 40°C to +125°C |     |       | UNIT  |
|--------------------------|---------------------------|--|---------------------------------|-----------------------|-----|-----------------------------------|-----|-------|-------|
|                          |                           |  | MIN                             | TYP                   | MAX | MIN                               | TYP | MAX   |       |
| V <sub>IH</sub>          | High-level input voltage  | V <sub>CC</sub> = 1.65 V to 1.8 V                | 0.95                            |                       |     | 1                                 |     |       | V     |
|                          |                           | V <sub>CC</sub> = 2.0 V                          | 0.99                            |                       |     | 1.03                              |     |       |       |
|                          |                           | V <sub>CC</sub> = 2.25 V to 2.5 V                | 1.145                           |                       |     | 1.18                              |     |       |       |
|                          |                           | V <sub>CC</sub> = 2.75 V                         | 1.22                            |                       |     | 1.25                              |     |       |       |
|                          |                           | V <sub>CC</sub> = 3 V to 3.3 V                   | 1.37                            |                       |     | 1.39                              |     |       |       |
|                          |                           | V <sub>CC</sub> = 3.6 V                          | 1.47                            |                       |     | 1.48                              |     |       |       |
|                          |                           | V <sub>CC</sub> = 4.5 V to 5.0 V                 | 2.02                            |                       |     | 2.03                              |     |       |       |
|                          |                           | V <sub>CC</sub> = 5.5 V                          | 2.1                             |                       |     | 2.11                              |     |       |       |
| V <sub>IL</sub>          | Low-level input voltage   | V <sub>CC</sub> = 1.65 V to 2.0 V                |                                 |                       |     |                                   |     | 0.57  | 0.55  |
|                          |                           | V <sub>CC</sub> = 2.25 V to 2.75 V               |                                 |                       |     |                                   |     | 0.75  | 0.71  |
|                          |                           | V <sub>CC</sub> = 3 V to 3.6 V                   |                                 |                       |     |                                   |     | 0.8   | 0.65  |
|                          |                           | V <sub>CC</sub> = 4.5 V to 5.5 V                 |                                 |                       |     |                                   |     | 0.8   | 0.8   |
| V <sub>OH</sub>          | High-level output voltage | I <sub>OH</sub> = - 20 μA                        | 1.65 V to 5.5 V                 | V <sub>CC</sub> - 0.1 |     | V <sub>CC</sub> - 0.1             |     |       |       |
|                          |                           | I <sub>OH</sub> = - 2.0 mA                       | 1.65 V                          | 1.28                  |     | 1.21                              |     |       |       |
|                          |                           |  | 1.8 V                           | 1.5                   |     | 1.45                              |     |       |       |
|                          |                           | I <sub>OH</sub> = - 3 mA                         | 2.3 V                           | 2                     |     | 1.93                              |     |       |       |
|                          |                           | I <sub>OH</sub> = - 3 mA                         | 2.5 V                           | 2.25                  |     | 2.15                              |     |       |       |
|                          |                           | I <sub>OH</sub> = - 3.0 mA                       | 3.0 V                           | 2.78                  |     | 2.7                               |     |       |       |
|                          |                           |  |                                 | 2.6                   |     | 2.49                              |     |       |       |
|                          |                           | I <sub>OH</sub> = - 5.5 mA                       | 3.3 V                           | 2.9                   |     | 2.8                               |     |       |       |
|                          |                           | I <sub>OH</sub> = - 4 mA                         | 4.5 V                           | 4.2                   |     | 4.1                               |     |       |       |
| 4.1                      |                           |  |                                 | 3.95                  |     |                                   |     |       |       |
| I <sub>OH</sub> = - 8 mA | 5.0 V                     | 4.6  |                                 | 4.5                   |     |                                   |     |       |       |
| V <sub>OL</sub>          | Low-level output voltage  | I <sub>OL</sub> = 20 μA                          | 1.65 V to 5.5 V                 |                       |     |                                   |     | 0.1   | 0.1   |
|                          |                           | I <sub>OL</sub> = 2 mA                           | 1.65 V                          |                       |     |                                   |     | 0.2   | 0.25  |
|                          |                           | I <sub>OL</sub> = 3 mA                           | 2.3 V                           |                       |     |                                   |     | 0.15  | 0.2   |
|                          |                           | I <sub>OL</sub> = 3 mA                           | 3.0 V                           | 0.11                  |     | 0.15                              |     |       |       |
|                          |                           |  |                                 | 0.21                  |     | 0.252                             |     |       |       |
|                          |                           | I <sub>OL</sub> = 5.5 mA                         |                                 |                       |     | 0.21                              |     | 0.252 |       |
|                          |                           | I <sub>OL</sub> = 4 mA                           | 4.5 V                           |                       |     | 0.15                              |     | 0.2   |       |
| I <sub>OL</sub> = 8 mA   |                           |  |                                 | 0.3                   |     | 0.35                              |     |       |       |
| I <sub>I</sub>           | Input leakage current     | A input; V <sub>I</sub> = 0 V or V <sub>CC</sub> | 0 V, 1.8 V, 2.5 V, 3.3 V, 5.5 V |                       |     |                                   |     | 0.1   | ±1 μA |

over recommended operating free-air temperature range (unless otherwise noted)

| PARAMETER        | TEST CONDITIONS  | V <sub>CC</sub> | T <sub>A</sub> = 25°C |     |      | T <sub>A</sub> = -40°C to +125°C |     |     | UNIT |
|------------------|--|-----------------|-----------------------|-----|------|----------------------------------|-----|-----|------|
|                  |  |                 | MIN                   | TYP | MAX  | MIN                              | TYP | MAX |      |
| I <sub>CC</sub>  | Static supply current<br>V <sub>I</sub> = 0 V or V <sub>CC</sub> ,<br>I <sub>O</sub> = 0; open on loading                        | 5.0 V           |                       |     | 1    |                                  |     | 10  | μA   |
|                  |  | 3.3 V           |                       |     | 1    |                                  |     | 10  |      |
|                  |  | 2.5 V           |                       |     | 1    |                                  |     | 10  |      |
|                  |  | 1.8 V           |                       |     | 1    |                                  |     | 10  |      |
| ΔI <sub>CC</sub> | Additional static supply current<br>One input at 0.3 V or 3.4 V,<br>Other inputs at 0 or V <sub>CC</sub> ,<br>I <sub>O</sub> = 0 | 5.5 V           |                       |     | 1.35 |                                  |     | 1.5 | mA   |
|                  |  | 1.8 V           |                       |     | 10   |                                  |     | 10  | μA   |
| C <sub>i</sub>   | Input capacitance<br>V <sub>I</sub> = V <sub>CC</sub> or GND   | 3.3 V           |                       | 2   | 10   |                                  | 2   | 10  | pF   |
| C <sub>o</sub>   | Output capacitance<br>V <sub>O</sub> = V <sub>CC</sub> or GND  | 3.3 V           |                       | 2.5 |      |                                  | 2.5 |     | pF   |

## 6.6 Switching Characteristics

over operating free-air temperature range (unless otherwise noted)

| PARAMETER                           | FROM (INPUT) | TO (OUTPUT) | FREQUENCY (TYP) | V <sub>CC</sub> | C <sub>L</sub> | T <sub>A</sub> = 25°C |      |     | T <sub>A</sub> = -65°C to 125°C |      |     | UNIT |
|-------------------------------------|--------------|-------------|-----------------|-----------------|----------------|-----------------------|------|-----|---------------------------------|------|-----|------|
|                                     |              |             |                 |                 |                | MIN                   | TYP  | MAX | MIN                             | TYP  | MAX |      |
| t <sub>pd</sub>                     | Any In       | Y           | DC to 50 MHz    | 5.0 V           | 15 pF          | 2.7                   | 5.5  |     | 3.4                             | 6.5  | ns  |      |
|                                     |              |             |                 |                 | 30 pF          | 3.0                   | 6.5  |     | 4.1                             | 7.5  |     |      |
|                                     |              |             | DC to 25 MHz    | 3.3 V           | 15 pF          | 4.0                   | 7.0  |     | 5.0                             | 8.0  | ns  |      |
|                                     |              |             |                 |                 | 30 pF          | 4.9                   | 8.0  |     | 6.0                             | 9.0  |     |      |
|                                     |              |             | DC to 15 MHz    | 2.5 V           | 15 pF          | 5.8                   | 8.5  |     | 6.8                             | 9.5  | ns  |      |
|                                     |              |             |                 |                 | 30 pF          | 6.5                   | 9.5  |     | 7.5                             | 10.5 |     |      |
| DC to 15 MHz                        | 1.8 V        | 15 pF       | 10.5            | 13.0            |                | 11.8                  | 14.0 | ns  |                                 |      |     |      |
|                                     |              | 30 pF       | 12.0            | 14.5            |                | 12.0                  | 15.5 |     |                                 |      |     |      |
| t <sub>PZH</sub> , t <sub>PZL</sub> | OE           | Y           | DC to 50 MHz    | 5.0 V           | 15 pF          | 3.0                   | 5.0  |     | 3.5                             | 6.0  | ns  |      |
|                                     |              |             |                 |                 | 30 pF          | 4.3                   | 6.5  |     | 4.9                             | 7.5  |     |      |
|                                     |              |             | DC to 25 MHz    | 3.3 V           | 15 pF          | 4.0                   | 6.5  |     | 4.5                             | 7.5  | ns  |      |
|                                     |              |             |                 |                 | 30 pF          | 5.0                   | 8.0  |     | 6.5                             | 9.0  |     |      |
|                                     |              |             | DC to 25 MHz    | 2.5 V           | 15 pF          | 5.5                   | 8.0  |     | 6.1                             | 9.0  | ns  |      |
|                                     |              |             |                 |                 | 30 pF          | 7.0                   | 10.0 |     | 8.5                             | 11.0 |     |      |
| DC to 15 MHz                        | 1.8 V        | 15 pF       | 9.0             | 12.0            |                | 9.85                  | 13.0 | ns  |                                 |      |     |      |
|                                     |              | 30 pF       | 12.5            | 15.0            |                | 13.5                  | 16.0 |     |                                 |      |     |      |
| t <sub>PHZ</sub> , t <sub>PLZ</sub> | OE           | Y           | DC to 50 MHz    | 5.0 V           | 15 pF          | 4.2                   | 6.5  |     | 4.5                             | 7.0  | ns  |      |
|                                     |              |             |                 |                 | 30 pF          | 4.8                   | 8.0  |     | 5.0                             | 8.5  |     |      |
|                                     |              |             | DC to 25 MHz    | 3.3 V           | 15 pF          | 4.5                   | 7.0  |     | 5.0                             | 8.0  | ns  |      |
|                                     |              |             |                 |                 | 30 pF          | 5.0                   | 8.0  |     | 5.5                             | 9.0  |     |      |
|                                     |              |             | DC to 25 MHz    | 2.5 V           | 15 pF          | 5.0                   | 11.0 |     | 6.0                             | 9.0  | ns  |      |
|                                     |              |             |                 |                 | 30 pF          | 6.0                   | 9.0  |     | 7.0                             | 10.0 |     |      |
| DC to 15 MHz                        | 1.8 V        | 15 pF       | 8.0             | 10.0            |                | 8.5                   | 11.0 | ns  |                                 |      |     |      |
|                                     |              | 30 pF       | 8.5             | 11.0            |                | 9.5                   | 12.0 |     |                                 |      |     |      |

## 6.7 Operating Characteristics

$T_A = 25^\circ\text{C}$

| PARAMETER                              | TEST CONDITIONS      | $V_{CC}$           | TYP | UNIT |
|--|----------------------|--------------------|-----|------|
| $C_{pd}$ Power dissipation capacitance | f = 1 MHz and 10 MHz | 1.8 V $\pm$ 0.15 V | 14  | pF   |
|  |                      | 2.5 V $\pm$ 0.2 V  | 14  |      |
|  |                      | 3.3 V $\pm$ 0.3 V  | 14  |      |
|  |                      | 5.5 V $\pm$ 0.5 V  | 14  |      |



## 6.8 Typical Characteristics

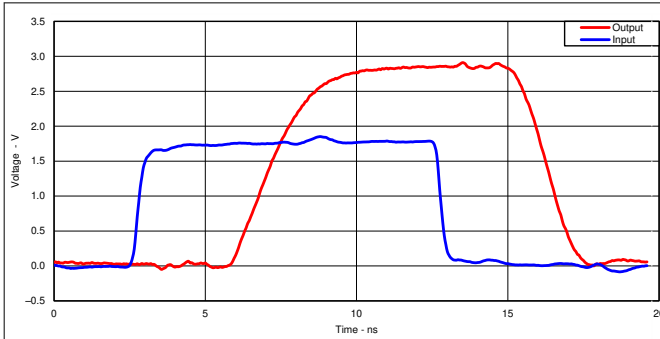

**图 6-1. Switching Characteristics at 50 MHz**  
**Excellent Signal Integrity**  
**(1.8 V to 3.3 V at 3.3-V  $V_{CC}$ )**

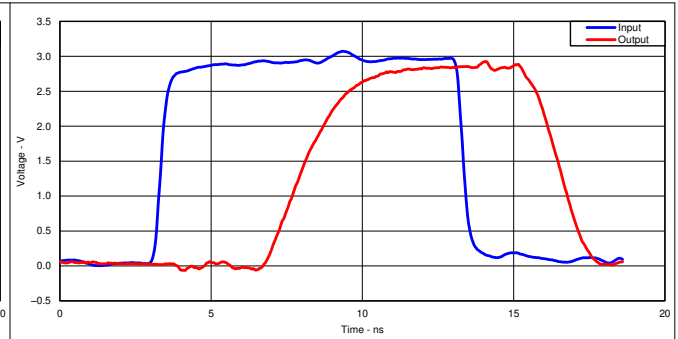

**图 6-2. Switching Characteristics at 50 MHz**  
**Excellent Signal Integrity**  
**(3.3 V to 3.3 V at 3.3-V  $V_{CC}$ )**

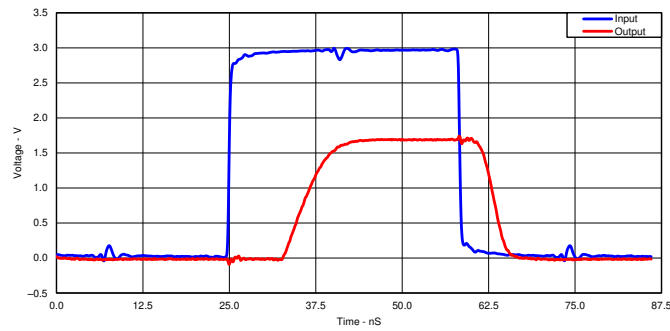

**图 6-3. Switching Characteristics at 15 MHz**  
**Excellent Signal Integrity**  
**(3.3 V to 1.8 V at 1.8-V  $V_{CC}$ )**

## 7 Parameter Measurement Information

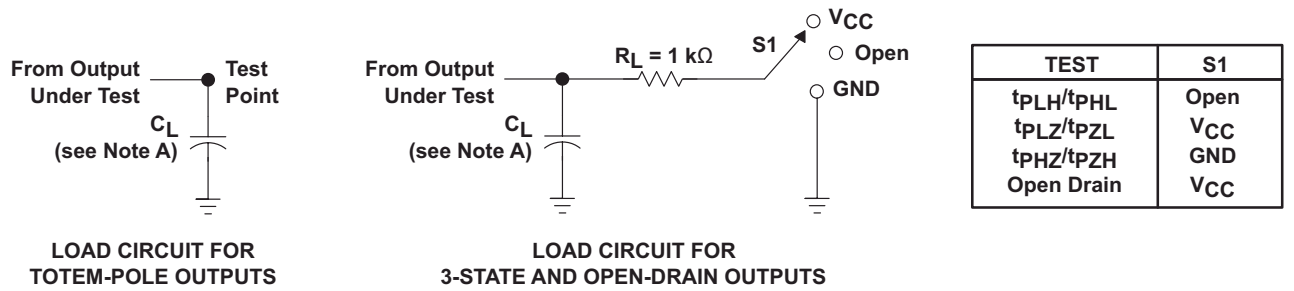

LOAD CIRCUIT FOR TOTEM-POLE OUTPUTS

LOAD CIRCUIT FOR 3-STATE AND OPEN-DRAIN OUTPUTS

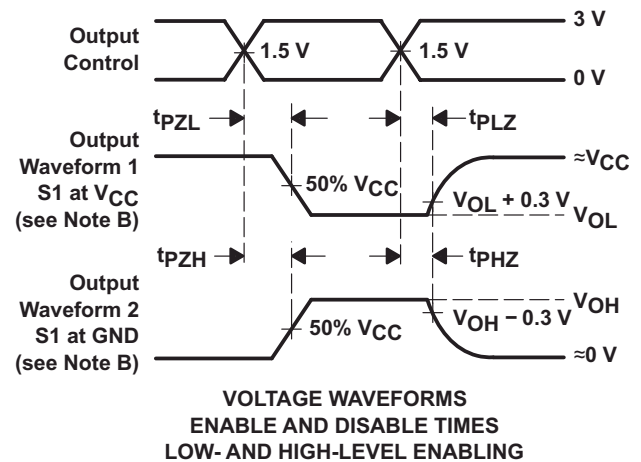
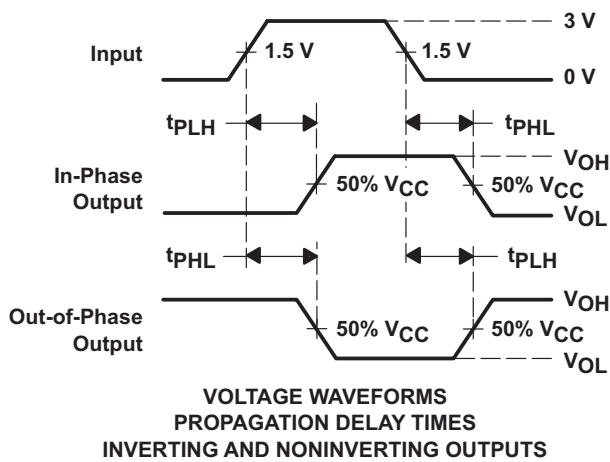
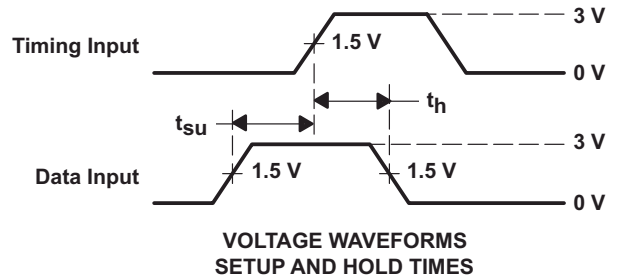
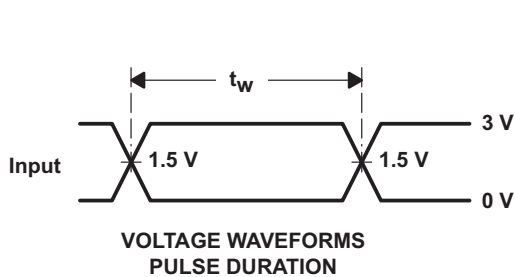

- NOTES: A.  $C_L$  includes probe and jig capacitance.  
 B. Waveform 1 is for an output with internal conditions such that the output is low, except when disabled by the output control. Waveform 2 is for an output with internal conditions such that the output is high, except when disabled by the output control.  
 C. All input pulses are supplied by generators having the following characteristics:  $PRR \leq 1 \text{ MHz}$ ,  $Z_O = 50 \Omega$ ,  $t_r \leq 3 \text{ ns}$ ,  $t_f \leq 3 \text{ ns}$ .  
 D. The outputs are measured one at a time, with one input transition per measurement.  
 E. All parameters and waveforms are not applicable to all devices.

图 7-1. Load Circuit and Voltage Waveforms

## 8 Detailed Description

### 8.1 Overview

The SN74LV1T126 device is a low-voltage CMOS gate logic that operates at a wider voltage range for industrial, portable, telecom, and automotive applications. The output level is referenced to the supply voltage and is able to support 1.8-V, 2.5-V, 3.3-V, and 5-V CMOS levels. The input is designed with a lower threshold circuit to match 1.8 V input logic at  $V_{CC} = 3.3$  V and can be used in 1.8 V to 3.3 V level-up translation. In addition, the 5 V tolerant input pins enable down translation (that is, 3.3 V to 2.5 V output at  $V_{CC} = 2.5$  V). The wide  $V_{CC}$  range of 1.8 V to 5.5 V allows generation of desired output levels to connect to controllers or processors. The SN74LV1T126 device is designed with current-drive capability of 8 mA to reduce line reflections, overshoot, and undershoot caused by high-drive outputs.

### 8.2 Functional Block Diagram



图 8-1. Logic Diagram

### 8.3 Feature Description

#### 8.3.1 Clamp Diode Structure

The outputs to this device have both positive and negative clamping diodes, and the inputs to this device have negative clamping diodes only as depicted in 图 8-2.

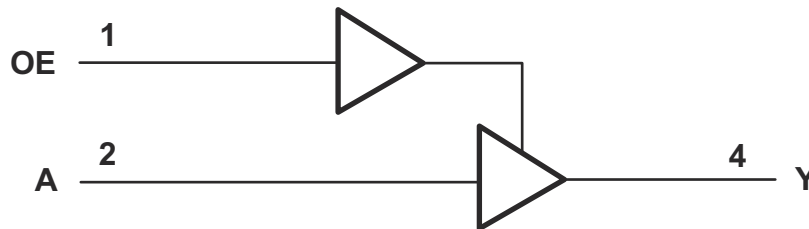
小心

Voltages beyond the values specified in the *Absolute Maximum Ratings* table can cause damage to the device. The input and output voltage ratings may be exceeded if the input and output clamp-current ratings are observed.



图 8-2. Electrical Placement of Clamping Diodes for Each Input and Output

#### 8.3.2 Balanced CMOS Push-Pull Outputs

This device includes balanced CMOS push-pull outputs. The term *balanced* indicates that the device can sink and source similar currents. The drive capability of this device may create fast edges into light loads so routing and load conditions should be considered to prevent ringing. Additionally, the outputs of this device are capable of driving larger currents than the device can sustain without being damaged. It is important for the output power of the device to be limited to avoid damage due to overcurrent. The electrical and thermal limits defined in the *Absolute Maximum Ratings* must be followed at all times.

Unused push-pull CMOS outputs should be left disconnected.

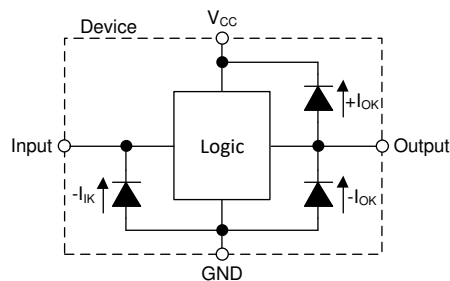
### 8.3.3 LVxT Enhanced Input Voltage

The SN74LV1T126 belongs to TI's LVxT family of Logic devices with integrated voltage level translation. This family of devices was designed with reduced input voltage thresholds to support up-translation, and inputs tolerant of signals with up to 5.5 V levels to support down-translation. The output voltage will always be referenced to the supply voltage ( $V_{CC}$ ), as described in the *Electrical Characteristics* table. To ensure proper functionality, input signals must remain at or below the specified  $V_{IH(MIN)}$  level for a HIGH input state, and at or below the specified  $V_{IL(MAX)}$  for a LOW input state. 图 8-3 shows the typical  $V_{IH}$  and  $V_{IL}$  levels for the LVxT family of devices, as well as the voltage levels for standard CMOS devices for comparison.

The inputs are high impedance and are typically modeled as a resistor in parallel with the input capacitance given in the *Electrical Characteristics*. The worst case resistance is calculated with the maximum input voltage, given in the *Absolute Maximum Ratings*, and the maximum input leakage current, given in the *Electrical Characteristics*, using Ohm's law ( $R = V \div I$ ).

The inputs require that input signals transition between valid logic states quickly, as defined by the input transition time or rate in the *Recommended Operating Conditions* table. Failing to meet this specification will result in excessive power consumption and could cause oscillations. More details can be found in the *Implications of Slow or Floating CMOS Inputs* application report.

Do not leave inputs floating at any time during operation. Unused inputs must be terminated at  $V_{CC}$  or GND. If a system will not be actively driving an input at all times, a pull-up or pull-down resistor can be added to provide a valid input voltage during these times. The resistor value will depend on multiple factors; however, a 10-k $\Omega$  resistor is recommended and will typically meet all requirements.



图 8-3. LVxT Input Voltage Levels

#### 8.3.3.1 Down Translation

Signals can be translated down using the SN74LV1T126. The voltage applied at the  $V_{CC}$  will determine the output voltage and the input thresholds as described in the *Recommended Operating Conditions* and *Electrical Characteristics* tables.

When connected to a high-impedance input, the output voltage will be approximately  $V_{CC}$  in the HIGH state, and 0 V in the LOW state. Ensure that the input signals in the HIGH state are between  $V_{IH(MIN)}$  and 5.5 V, and input signals in the LOW state are lower than  $V_{IL(MAX)}$  as shown in 图 8-3.

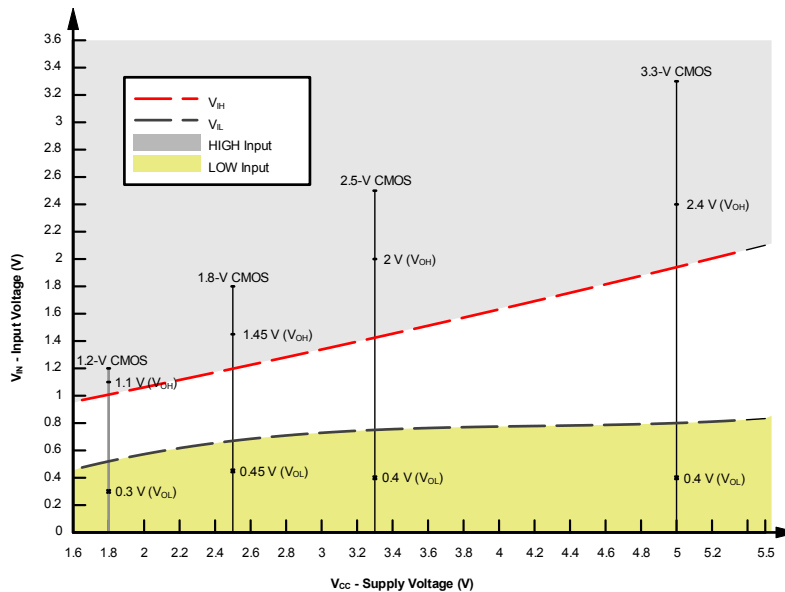
For example, standard CMOS inputs for devices operating at 5.0 V, 3.3 V or 2.5 V can be down-translated to match 1.8 V CMOS signals when operating from 1.8-V  $V_{CC}$ . See 图 8-4.

#### Down Translation Combinations:

- 1.8-V  $V_{CC}$  - Inputs from 2.5 V, 3.3 V, and 5.0 V
- 2.5-V  $V_{CC}$  - Inputs from 3.3 V and 5.0 V
- 3.3-V  $V_{CC}$  - Inputs from 5.0 V

#### 8.3.3.2 Up Translation

Input signals can be up translated using the SN74LV1T126. The voltage applied at  $V_{CC}$  will determine the output voltage and the input thresholds as described in the *Recommended Operating Conditions* and *Electrical Characteristics* tables. When connected to a high-impedance input, the output voltage will be approximately  $V_{CC}$  in the HIGH state, and 0 V in the LOW state.

The inputs have reduced thresholds that allow for input high-state levels which are much lower than standard values. For example, standard CMOS inputs for a device operating at a 5-V supply will have a  $V_{IH(MIN)}$  of 3.5 V. For the SN74LV1T126,  $V_{IH(MIN)}$  with a 5-V supply is only 2 V, which would allow for up-translation from a typical 2.5-V to 5-V signals.

Ensure that the input signals in the HIGH state are above  $V_{IH(MIN)}$  and input signals in the LOW state are lower than  $V_{IL(MAX)}$  as shown in 图 8-4.

#### Up Translation Combinations:

- 1.8-V  $V_{CC}$  - Inputs from 1.2 V
- 2.5-V  $V_{CC}$  - Inputs from 1.8 V
- 3.3-V  $V_{CC}$  - Inputs from 1.8 V and 2.5 V
- 5.0-V  $V_{CC}$  - Inputs from 2.5 V and 3.3 V



图 8-4. LVxT Up and Down Translation Example

## 8.4 Device Functional Modes

### Function Tables

| INPUT (1)<br>(LOWER LEVEL INPUT) |   | OUTPUT (2)<br>( $V_{CC}$ CMOS) |
|----------------------------------|---|--------------------------------|
| OE <sup>(3)</sup>                | A | Y                              |
| H                                | H | H                              |
| H                                | L | L                              |
| L                                | X | Z                              |

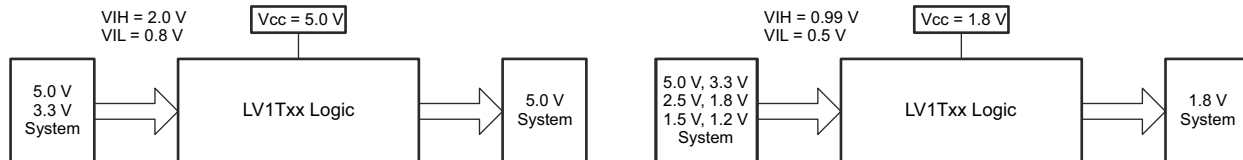
- (1) H = High Voltage Level, L = Low Voltage Level, X = Do not Care, Z = High Impedance  
 (2) H = Driving High, L = Driving Low, Z = High Impedance State  
 (3) Not recommend to float OE pin for signal oscillation.

| SUPPLY $V_{CC} = 3.3$ V      |   |                            |
|------------------------------|---|----------------------------|
| INPUT<br>(LOWER LEVEL INPUT) |   | OUTPUT<br>( $V_{CC}$ CMOS) |
| A                            | B | Y                          |

| SUPPLY $V_{CC} = 3.3\text{ V}$  |  |
|---|--|
| INPUT<br>(LOWER LEVEL INPUT)  | OUTPUT<br>( $V_{CC}$ CMOS)   |
| $V_{IH}(\text{min}) = 1.35\text{ V}$<br>$V_{IL}(\text{max}) = 0.8\text{ V}$ | $V_{OH}(\text{min}) = 2.9\text{ V}$<br>$V_{OL}(\text{max}) = 0.2\text{ V}$ |

## 9 应用信息免责声明

---

### 备注

以下应用部分中的信息不属于 TI 器件规格的范围，TI 不担保其准确性和完整性。TI 的客户应负责确定器件是否适用于其应用。客户应验证并测试其设计，以确保系统功能。

---

### 9.1 Power Supply Recommendations

The power supply can be any voltage between the minimum and maximum supply voltage rating located in the *Recommended Operating Conditions*. Each  $V_{CC}$  terminal should have a good bypass capacitor to prevent power disturbance. A 0.1- $\mu$ F capacitor is recommended for this device. It is acceptable to parallel multiple bypass caps to reject different frequencies of noise. The 0.1- $\mu$ F and 1- $\mu$ F capacitors are commonly used in parallel. The bypass capacitor should be installed as close to the power terminal as possible for best results, as shown in the following layout example.

### 9.2 Layout

#### 9.2.1 Layout Guidelines

When using multiple-input and multiple-channel logic devices inputs must not ever be left floating. In many cases, functions or parts of functions of digital logic devices are unused; for example, when only two inputs of a triple-input AND gate are used or only 3 of the 4 buffer gates are used. Such unused input pins must not be left unconnected because the undefined voltages at the outside connections result in undefined operational states. All unused inputs of digital logic devices must be connected to a logic high or logic low voltage, as defined by the input voltage specifications, to prevent them from floating. The logic level that must be applied to any particular unused input depends on the function of the device. Generally, the inputs are tied to GND or  $V_{CC}$ , whichever makes more sense for the logic function or is more convenient.



## 10 Device and Documentation Support

### 10.1 Documentation Support (Analog)

#### 10.1.1 Related Documentation

For related documentation, see the following:

- Texas Instruments, [CMOS Power Consumption and Cpd Calculation application note](#)
- Texas Instruments, [Designing With Logic application note](#)
- Texas Instruments, [Thermal Characteristics of Standard Linear and Logic \(SLL\) Packages and Devices application note](#)
- Texas Instruments, [Implications of Slow or Floating CMOS Inputs application note](#)

### 10.2 接收文档更新通知

要接收文档更新通知，请导航至 [ti.com](http://ti.com) 上的器件产品文件夹。点击 [通知](#) 进行注册，即可每周接收产品信息更改摘要。有关更改的详细信息，请查看任何已修订文档中包含的修订历史记录。

### 10.3 支持资源

[TI E2E™ 中文支持论坛](#) 是工程师的重要参考资料，可直接从专家处获得快速、经过验证的解答和设计帮助。搜索现有解答或提出自己的问题，获得所需的快速设计帮助。

链接的内容由各个贡献者“按原样”提供。这些内容并不构成 TI 技术规范，并且不一定反映 TI 的观点；请参阅 TI 的 [使用条款](#)。

### 10.4 Trademarks

TI E2E™ is a trademark of Texas Instruments.

所有商标均为其各自所有者的财产。

### 10.5 静电放电警告



静电放电 (ESD) 会损坏这个集成电路。德州仪器 (TI) 建议通过适当的预防措施处理所有集成电路。如果不遵守正确的处理和安装程序，可能会损坏集成电路。

ESD 的损坏小至导致微小的性能降级，大至整个器件故障。精密的集成电路可能更容易受到损坏，这是因为非常细微的参数更改都可能会导致器件与其发布的规格不相符。

### 10.6 术语表

[TI 术语表](#) 本术语表列出并解释了术语、首字母缩略词和定义。

## 11 Revision History

注：以前版本的页码可能与当前版本的页码不同

| Changes from Revision C (October 2023) to Revision D (February 2024)           | Page |
|--|------|
| • Updated R <sup>θ</sup> JA values: DBV = 206 to 278, all values in °C/W ..... | 6    |

| Changes from Revision B (June 2022) to Revision C (October 2023)                 | Page |
|--|------|
| • 向 <a href="#">封装信息</a> 表中添加了封装尺寸 .....   | 1    |
| • Updated R <sup>θ</sup> JA values: DCK = 252 to 289.2, all values in °C/W ..... | 6    |

## 12 Mechanical, Packaging, and Orderable Information

The following pages include mechanical, packaging, and orderable information. This information is the most current data available for the designated devices. This data is subject to change without notice and revision of this document. For browser-based versions of this data sheet, refer to the left-hand navigation.

**PACKAGING INFORMATION**

| Orderable Device  | Status<br>(1) | Package Type | Package Drawing | Pins | Package Qty | Eco Plan<br>(2) | Lead finish/<br>Ball material<br>(6) | MSL Peak Temp<br>(3) | Op Temp (°C) | Device Marking<br>(4/5)        | Samples                 |
|-------------------|---------------|--------------|-----------------|------|-------------|-----------------|--------------------------------------|----------------------|--------------|--------------------------------|-------------------------|
| SN74LV1T126DBVR   | ACTIVE        | SOT-23       | DBV             | 5    | 3000        | RoHS & Green    | NIPDAU   SN                          | Level-1-260C-UNLIM   | -40 to 125   | (39TH, 3CHF, NEN3, NENJ, NENS) | <a href="#">Samples</a> |
| SN74LV1T126DBVRG4 | ACTIVE        | SOT-23       | DBV             | 5    | 3000        | RoHS & Green    | NIPDAU                               | Level-1-260C-UNLIM   | -40 to 125   | NEN3                           | <a href="#">Samples</a> |
| SN74LV1T126DCKR   | ACTIVE        | SC70         | DCK             | 5    | 3000        | RoHS & Green    | SN                                   | Level-1-260C-UNLIM   | -40 to 125   | (1R1, WN3, WNJ, WNS)           | <a href="#">Samples</a> |
| SN74LV1T126DCKRG4 | ACTIVE        | SC70         | DCK             | 5    | 3000        | RoHS & Green    | NIPDAU                               | Level-1-260C-UNLIM   |              | WN3                            | <a href="#">Samples</a> |

(1) The marketing status values are defined as follows:

**ACTIVE:** Product device recommended for new designs.

**LIFEBUY:** TI has announced that the device will be discontinued, and a lifetime-buy period is in effect.

**NRND:** Not recommended for new designs. Device is in production to support existing customers, but TI does not recommend using this part in a new design.

**PREVIEW:** Device has been announced but is not in production. Samples may or may not be available.

**OBSOLETE:** TI has discontinued the production of the device.

(2) **RoHS:** TI defines "RoHS" to mean semiconductor products that are compliant with the current EU RoHS requirements for all 10 RoHS substances, including the requirement that RoHS substance do not exceed 0.1% by weight in homogeneous materials. Where designed to be soldered at high temperatures, "RoHS" products are suitable for use in specified lead-free processes. TI may reference these types of products as "Pb-Free".

**RoHS Exempt:** TI defines "RoHS Exempt" to mean products that contain lead but are compliant with EU RoHS pursuant to a specific EU RoHS exemption.

**Green:** TI defines "Green" to mean the content of Chlorine (Cl) and Bromine (Br) based flame retardants meet JS709B low halogen requirements of <=1000ppm threshold. Antimony trioxide based flame retardants must also meet the <=1000ppm threshold requirement.

(3) MSL, Peak Temp. - The Moisture Sensitivity Level rating according to the JEDEC industry standard classifications, and peak solder temperature.

(4) There may be additional marking, which relates to the logo, the lot trace code information, or the environmental category on the device.

(5) Multiple Device Markings will be inside parentheses. Only one Device Marking contained in parentheses and separated by a "~" will appear on a device. If a line is indented then it is a continuation of the previous line and the two combined represent the entire Device Marking for that device.

(6) Lead finish/Ball material - Orderable Devices may have multiple material finish options. Finish options are separated by a vertical ruled line. Lead finish/Ball material values may wrap to two lines if the finish value exceeds the maximum column width.

**Important Information and Disclaimer:**The information provided on this page represents TI's knowledge and belief as of the date that it is provided. TI bases its knowledge and belief on information provided by third parties, and makes no representation or warranty as to the accuracy of such information. Efforts are underway to better integrate information from third parties. TI has taken and

continues to take reasonable steps to provide representative and accurate information but may not have conducted destructive testing or chemical analysis on incoming materials and chemicals. TI and TI suppliers consider certain information to be proprietary, and thus CAS numbers and other limited information may not be available for release.

In no event shall TI's liability arising out of such information exceed the total purchase price of the TI part(s) at issue in this document sold by TI to Customer on an annual basis.

**OTHER QUALIFIED VERSIONS OF SN74LV1T126 :**

- Automotive : [SN74LV1T126-Q1](#)

NOTE: Qualified Version Definitions:

- Automotive - Q100 devices qualified for high-reliability automotive applications targeting zero defects

## TAPE AND REEL INFORMATION



### QUADRANT ASSIGNMENTS FOR PIN 1 ORIENTATION IN TAPE



\*All dimensions are nominal

| Device            | Package Type | Package Drawing | Pins | SPQ  | Reel Diameter (mm) | Reel Width W1 (mm) | A0 (mm) | B0 (mm) | K0 (mm) | P1 (mm) | W (mm) | Pin1 Quadrant |
|-------------------|--------------|-----------------|------|------|--------------------|--------------------|---------|---------|---------|---------|--------|---------------|
| SN74LV1T126DBVR   | SOT-23       | DBV             | 5    | 3000 | 178.0              | 9.0                | 3.3     | 3.2     | 1.4     | 4.0     | 8.0    | Q3            |
| SN74LV1T126DBVR   | SOT-23       | DBV             | 5    | 3000 | 180.0              | 8.4                | 3.2     | 3.2     | 1.4     | 4.0     | 8.0    | Q3            |
| SN74LV1T126DBVRG4 | SOT-23       | DBV             | 5    | 3000 | 178.0              | 9.2                | 3.3     | 3.23    | 1.55    | 4.0     | 8.0    | Q3            |
| SN74LV1T126DCKR   | SC70         | DCK             | 5    | 3000 | 180.0              | 8.4                | 2.3     | 2.5     | 1.2     | 4.0     | 8.0    | Q3            |
| SN74LV1T126DCKRG4 | SC70         | DCK             | 5    | 3000 | 178.0              | 9.2                | 2.4     | 2.4     | 1.22    | 4.0     | 8.0    | Q3            |

## TAPE AND REEL BOX DIMENSIONS



\*All dimensions are nominal

| Device            | Package Type | Package Drawing | Pins | SPQ  | Length (mm) | Width (mm) | Height (mm) |
|-------------------|--------------|-----------------|------|------|-------------|------------|-------------|
| SN74LV1T126DBVR   | SOT-23       | DBV             | 5    | 3000 | 180.0       | 180.0      | 18.0        |
| SN74LV1T126DBVR   | SOT-23       | DBV             | 5    | 3000 | 210.0       | 185.0      | 35.0        |
| SN74LV1T126DBVRG4 | SOT-23       | DBV             | 5    | 3000 | 180.0       | 180.0      | 18.0        |
| SN74LV1T126DCKR   | SC70         | DCK             | 5    | 3000 | 210.0       | 185.0      | 35.0        |
| SN74LV1T126DCKRG4 | SC70         | DCK             | 5    | 3000 | 180.0       | 180.0      | 18.0        |

# DCK0005A



# PACKAGE OUTLINE

SOT - 1.1 max height

SMALL OUTLINE TRANSISTOR

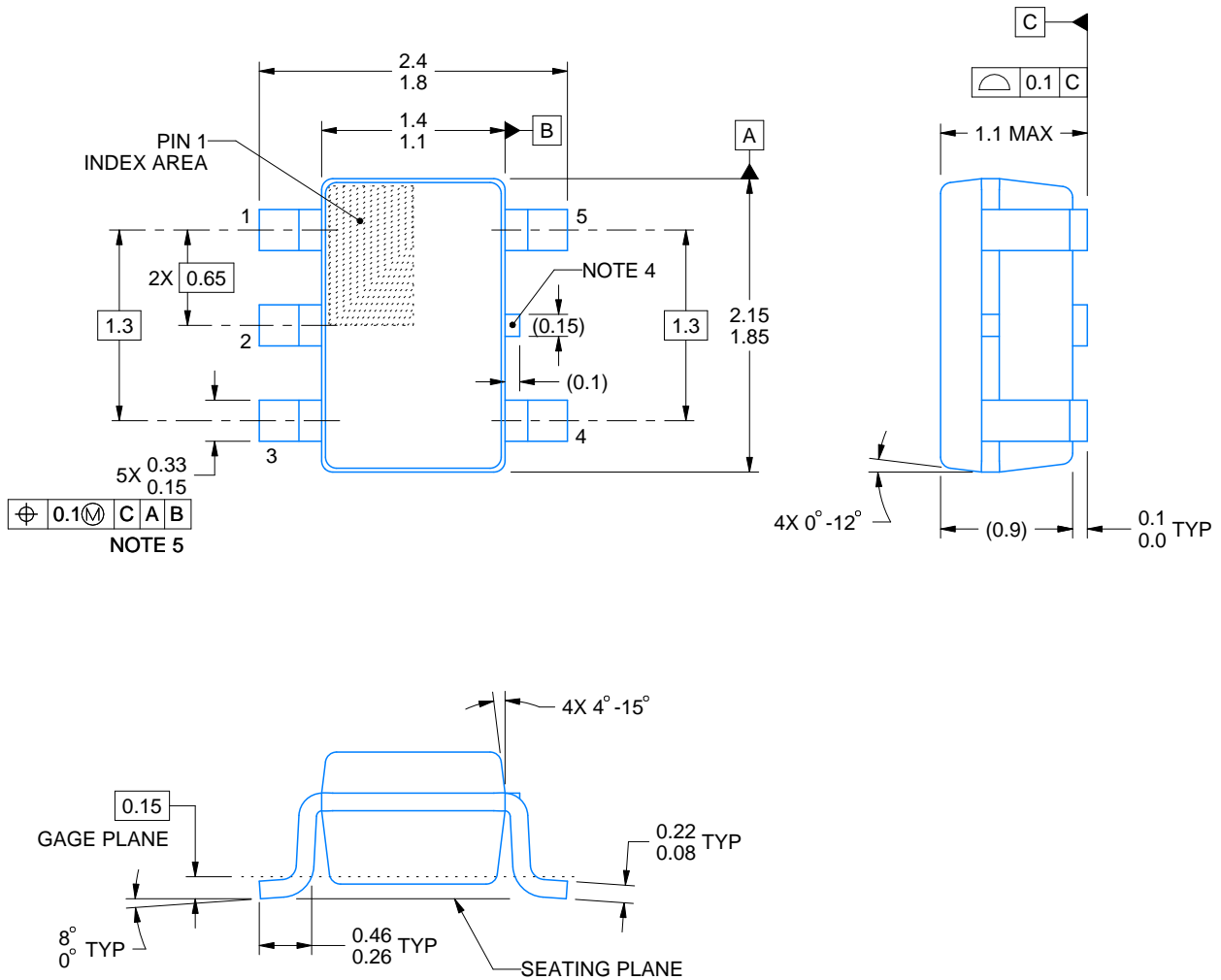

4214834/G 11/2024

**NOTES:**

1. All linear dimensions are in millimeters. Any dimensions in parenthesis are for reference only. Dimensioning and tolerancing per ASME Y14.5M.
2. This drawing is subject to change without notice.
3. Reference JEDEC MO-203.
4. Support pin may differ or may not be present.
5. Lead width does not comply with JEDEC.
6. Body dimensions do not include mold flash, protrusions, or gate burrs. Mold flash, protrusions, or gate burrs shall not exceed 0.25mm per side

# EXAMPLE BOARD LAYOUT

DCK0005A

SOT - 1.1 max height

SMALL OUTLINE TRANSISTOR



LAND PATTERN EXAMPLE  
EXPOSED METAL SHOWN  
SCALE:18X

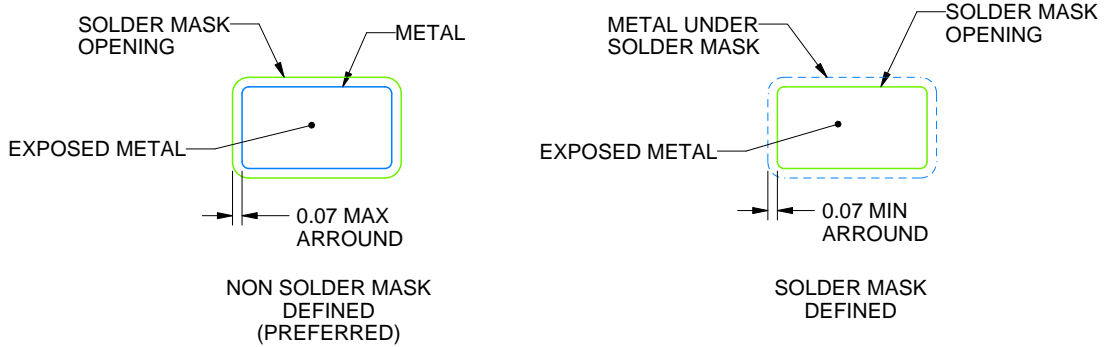

SOLDER MASK DETAILS

4214834/G 11/2024

NOTES: (continued)

- 7. Publication IPC-7351 may have alternate designs.
- 8. Solder mask tolerances between and around signal pads can vary based on board fabrication site.



# EXAMPLE STENCIL DESIGN

DCK0005A

SOT - 1.1 max height

SMALL OUTLINE TRANSISTOR



SOLDER PASTE EXAMPLE  
BASED ON 0.125 THICK STENCIL  
SCALE: 18X

4214834/G 11/2024

NOTES: (continued)

9. Laser cutting apertures with trapezoidal walls and rounded corners may offer better paste release. IPC-7525 may have alternate design recommendations.
10. Board assembly site may have different recommendations for stencil design.



# EXAMPLE BOARD LAYOUT

DBV0005A

SOT-23 - 1.45 mm max height

SMALL OUTLINE TRANSISTOR



LAND PATTERN EXAMPLE  
EXPOSED METAL SHOWN  
SCALE:15X



SOLDER MASK DETAILS

4214839/K 08/2024

NOTES: (continued)

- 6. Publication IPC-7351 may have alternate designs.
- 7. Solder mask tolerances between and around signal pads can vary based on board fabrication site.

# EXAMPLE STENCIL DESIGN

DBV0005A

SOT-23 - 1.45 mm max height

SMALL OUTLINE TRANSISTOR



SOLDER PASTE EXAMPLE  
BASED ON 0.125 mm THICK STENCIL  
SCALE:15X

4214839/K 08/2024

NOTES: (continued)

8. Laser cutting apertures with trapezoidal walls and rounded corners may offer better paste release. IPC-7525 may have alternate design recommendations.
9. Board assembly site may have different recommendations for stencil design.

## 重要通知和免责声明

TI“按原样”提供技术和可靠性数据（包括数据表）、设计资源（包括参考设计）、应用或其他设计建议、网络工具、安全信息和其他资源，不保证没有瑕疵且不做任何明示或暗示的担保，包括但不限于对适销性、某特定用途方面的适用性或不侵犯任何第三方知识产权的暗示担保。

这些资源可供使用 TI 产品进行设计的熟练开发人员使用。您将自行承担以下全部责任：(1) 针对您的应用选择合适的 TI 产品，(2) 设计、验证并测试您的应用，(3) 确保您的应用满足相应标准以及任何其他功能安全、信息安全、监管或其他要求。

这些资源如有变更，恕不另行通知。TI 授权您仅可将这些资源用于研发本资源所述的 TI 产品的相关应用。严禁以其他方式对这些资源进行复制或展示。您无权使用任何其他 TI 知识产权或任何第三方知识产权。您应全额赔偿因在这些资源的使用中对 TI 及其代表造成的任何索赔、损害、成本、损失和债务，TI 对此概不负责。

TI 提供的产品受 [TI 的销售条款](#) 或 [ti.com](#) 上其他适用条款/TI 产品随附的其他适用条款的约束。TI 提供这些资源并不会扩展或以其他方式更改 TI 针对 TI 产品发布的适用的担保或担保免责声明。

TI 反对并拒绝您可能提出的任何其他或不同的条款。

邮寄地址：Texas Instruments, Post Office Box 655303, Dallas, Texas 75265  
版权所有 © 2025，德州仪器 (TI) 公司