

THS402x 2GHz、10V/V 稳定增益、低噪声高速放大器

1 特性

- 超低 1.2nV/√Hz 电压噪声
- 高速：
 - 2GHz 增益带宽积
 - 470V/μs 压摆率
 - 30ns 稳定时间 (0.1%)
- 在增益 $\geq 10\text{V/V}$ 时保持稳定
- 输出驱动， $I_O = 200\text{mA}$ (典型值)
- 极低失真：
 - THD = -68dBc ($f = 1\text{MHz}$, $R_L = 150\Omega$)
- 宽电压范围的电源：
 - $V_{CC} = \pm 4.5\text{V}$ 至 $\pm 16\text{V}$
- THS4021 上的失调电压归零引脚

2 应用

- 超声波扫描仪
- 源测量单元 (SMU)
- 电源品质测定器

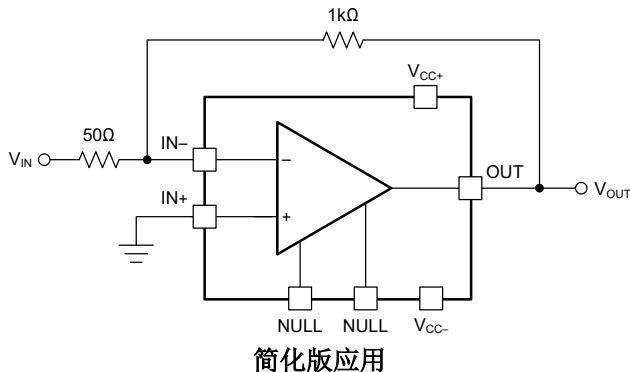

3 说明

THS4021 和 THS4022 (THS402x) 是超低电压噪声、高速电压反馈放大器，非常适合需要低电压噪声的应用（包括通信和成像）。单通道放大器 THS4021 和双通道放大器 THS4022 可提供卓越的交流性能，闭环带宽为 290MHz，压摆率为 470V/μs，稳定时间为 30ns (0.1%)，增益为 10V/V。THS402x 在增益为 10V/V 或更高以及 -9V/V 或更低时保持稳定。这些放大器具有 200mA 的高驱动能力，每个放大器只消耗 7.5mA 的电源电流。THS402x 在 $f = 1\text{MHz}$ 时总谐波失真 (THD) 为 -68dBc，专为需要低失真的应用而设计。

器件信息

| 器件型号 | 放大器 | 封装 ⁽¹⁾ |
|---------|-----|--------------------------------|
| THS4021 | 一个 | D (SOIC, 8) DGN (HVSSOP, 8) |
| THS4022 | 两个 | DGN (HVSSOP, 8) |

(1) 有关更多信息，请参阅节 10。

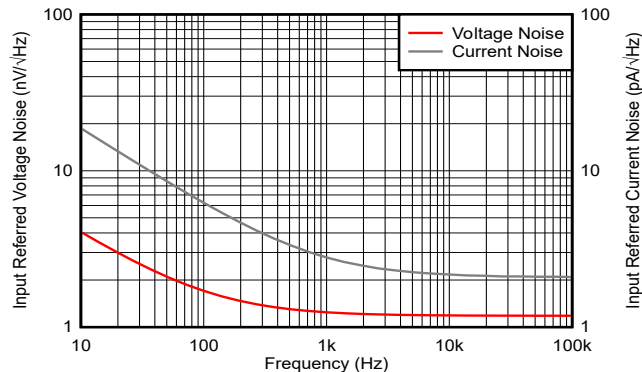

电压噪声和电流噪声与频率间的关系



Table of Contents

| | | | |
|---|----|--|----|
| 1 特性 | 1 | 6.2 Functional Block Diagram..... | 21 |
| 2 应用 | 1 | 6.3 Feature Description..... | 22 |
| 3 说明 | 1 | 6.4 Device Functional Modes..... | 22 |
| 4 Pin Configuration and Functions | 3 | 7 Application and Implementation | 23 |
| 5 Specifications | 4 | 7.1 Application Information..... | 23 |
| 5.1 Absolute Maximum Ratings..... | 4 | 7.2 Power Supply Recommendations..... | 24 |
| 5.2 ESD Ratings..... | 4 | 7.3 Layout..... | 24 |
| 5.3 Recommended Operating Conditions..... | 4 | 8 Device and Documentation Support | 27 |
| 5.4 Thermal Information - THS4021..... | 5 | 8.1 Documentation Support..... | 27 |
| 5.5 Thermal Information - THS4022..... | 5 | 8.2 接收文档更新通知..... | 27 |
| 5.6 Electrical Characteristics - THS4021D and THS4022DGN..... | 6 | 8.3 支持资源..... | 27 |
| 5.7 Electrical Characteristics - THS4021DGN..... | 8 | 8.4 Trademarks..... | 27 |
| 5.8 Typical Characteristics: THS4021D and THS4022DGN..... | 10 | 8.5 静电放电警告..... | 27 |
| 5.9 Typical Characteristics: THS4021DGN..... | 16 | 8.6 术语表..... | 27 |
| 6 Detailed Description | 21 | 9 Revision History | 27 |
| 6.1 Overview..... | 21 | 10 Mechanical, Packaging, and Orderable Information | 28 |

4 Pin Configuration and Functions



图 4-1. THS4021: D Package, 8-Pin SOIC, or DGN Package, 8-pin HVSSOP (Top View)

表 4-1. Pin Functions: THS4021

| PIN | | TYPE | DESCRIPTION |
|------------------|------|--------|-----------------------|
| NAME | NO. | | |
| IN - | 2 | Input | Inverting input |
| IN+ | 3 | Input | Noninverting input |
| NC | 5 | — | No connection |
| NULL | 1, 8 | Input | Voltage offset adjust |
| OUT | 6 | Output | Output of amplifier |
| V _{CC-} | 4 | — | Negative power supply |
| V _{CC+} | 7 | — | Positive power supply |

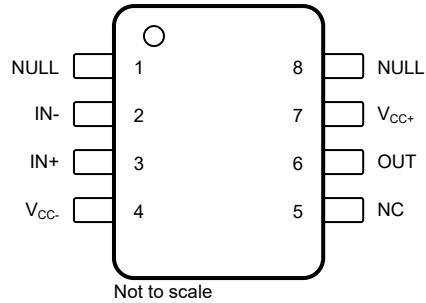

图 4-2. THS4022: DGN Package, 8-pin HVSSOP (Top View)

表 4-2. Pin Functions: THS4022

| PIN | | TYPE | DESCRIPTION |
|------------------|-----|--------|------------------------------|
| NAME | NO. | | |
| 1IN - | 2 | Input | Channel 1 inverting input |
| 1IN+ | 3 | Input | Channel 1 noninverting input |
| 1OUT | 1 | Output | Channel 1 output |
| 2IN - | 6 | Input | Channel 2 inverting input |
| 2IN+ | 5 | Input | Channel 2 noninverting input |
| 2OUT | 7 | Output | Channel 2 output |
| V _{CC-} | 4 | — | Negative power supply |
| V _{CC+} | 8 | — | Positive power supply |

5 Specifications

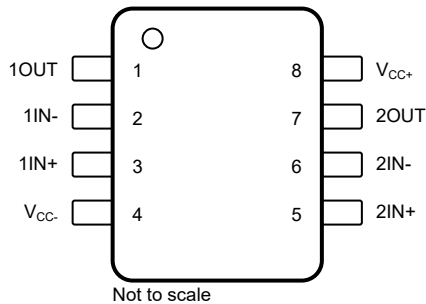
5.1 Absolute Maximum Ratings

over operating free-air temperature range (unless otherwise noted)⁽¹⁾

| | | MIN | MAX | UNIT | |
|-------------------------------------|--|----------|------------------|------|----|
| V _{CC- to V_{CC+}} | Supply voltage | | 33 | V | |
| V _I | Input voltage | | ±V _{CC} | V | |
| I _O | Output current ⁽²⁾ | | 240 | mA | |
| V _{IO} | Differential input voltage | | ±1.5 | V | |
| I _{IN} | Continuous input current | | 10 | mA | |
| T _J | Maximum junction temperature | | 150 | °C | |
| T _A | Operating free-air temperature | C-suffix | 0 | 70 | °C |
| | | I-suffix | - 40 | 85 | |
| T _{stg} | Storage temperature | - 65 | 150 | °C | |
| | Lead temperature 1.6 mm (1/16 inch) from case for 10 seconds | | 300 | °C | |

- (1) Operation outside the *Absolute Maximum Ratings* may cause permanent device damage. *Absolute Maximum Ratings* do not imply functional operation of the device at these or any other conditions beyond those listed under *Recommended Operating Conditions*. If used outside the *Recommended Operating Conditions* but within the *Absolute Maximum Ratings*, the device may not be fully functional, and this may affect device reliability, functionality, performance, and shorten the device lifetime.
- (2) When continuously operating at any output current, do not exceed the maximum junction temperature. Keep the output current less than the absolute maximum rating regardless of time interval.

5.2 ESD Ratings

| | | VALUE | UNIT | |
|--------------------|-------------------------|--|-------|---|
| V _(ESD) | Electrostatic discharge | Human body model (HBM), per ANSI/ESDA/ JEDEC JS-001, all pins ⁽¹⁾ | ±1000 | V |
| | | Charged device model (CDM), per JEDEC specification JESD22-C101 ⁽²⁾ | ±1000 | |

- (1) JEDEC document JEP155 states that 500-V HBM allows safe manufacturing with a standard ESD control process.
- (2) JEDEC document JEP157 states that 250-V CDM allows safe manufacturing with a standard ESD control process.

5.3 Recommended Operating Conditions

over operating free-air temperature range (unless otherwise noted)

| | | MIN | NOM | MAX | UNIT | |
|-----------------|--------------------------------|---------------|------|-----|------|----|
| V _{CC} | Supply voltage | Dual-supply | ±4.5 | ±15 | ±16 | V |
| | | Single-supply | 9 | 30 | 32 | |
| T _A | Operating free-air temperature | C-suffix | 0 | 25 | 70 | °C |
| | | I-suffix | - 40 | 25 | 85 | |

5.4 Thermal Information - THS4021

| THERMAL METRIC ⁽¹⁾ | | THS4021 | | UNIT |
|-------------------------------|--|----------|--------------|------|
| | | D (SOIC) | DGN (HVSSOP) | |
| | | 8 PINS | 8 PINS | |
| $R_{\theta JA}$ | Junction-to-ambient thermal resistance | 124.5 | 58.4 | °C/W |
| $R_{\theta JC(top)}$ | Junction-to-case (top) thermal resistance | 65.0 | 4.7 | °C/W |
| $R_{\theta JB}$ | Junction-to-board thermal resistance | 72.2 | N/A | °C/W |
| Ψ_{JT} | Junction-to-top characterization parameter | 13.6 | N/A | °C/W |
| Ψ_{JB} | Junction-to-board characterization parameter | 71.4 | N/A | °C/W |
| $R_{\theta JC(bot)}$ | Junction-to-case (bottom) thermal resistance | N/A | N/A | °C/W |

(1) For more information about traditional and new thermal metrics, see the [Semiconductor and IC Package Thermal Metrics](#) application report.

5.5 Thermal Information - THS4022

| THERMAL METRIC ⁽¹⁾ | | THS4022 | UNIT |
|-------------------------------|--|--------------|------|
| | | DGN (HVSSOP) | |
| | | 8 PINS | |
| $R_{\theta JA}$ | Junction-to-ambient thermal resistance | 52 | °C/W |
| $R_{\theta JC(top)}$ | Junction-to-case (top) thermal resistance | 75.2 | °C/W |
| $R_{\theta JB}$ | Junction-to-board thermal resistance | 24.5 | °C/W |
| Ψ_{JT} | Junction-to-top characterization parameter | 4 | °C/W |
| Ψ_{JB} | Junction-to-board characterization parameter | 24.5 | °C/W |
| $R_{\theta JC(bot)}$ | Junction-to-case (bottom) thermal resistance | 9.1 | °C/W |

(1) For more information about traditional and new thermal metrics, see the [Semiconductor and IC Package Thermal Metrics](#) application report.

5.6 Electrical Characteristics - THS4021D and THS4022DGN

at $T_A = 25^\circ\text{C}$, $V_{CC} = \pm 15\text{ V}$, and $R_L = 150\ \Omega$ (unless otherwise noted)

| PARAMETER | | TEST CONDITIONS | | MIN | TYP | MAX | UNIT |
|---|---|--|--|------|------|-----|------------------------------|
| DYNAMIC PERFORMANCE | | | | | | | |
| BW | Small-signal bandwidth (-3 dB) | Gain = 10 | $V_{CC} = \pm 15\text{ V}$ | | 290 | | MHz |
| | | | $V_{CC} = \pm 5\text{ V}$ | | 250 | | |
| | | Gain = 20 | $V_{CC} = \pm 15\text{ V}$ | | 110 | | |
| | | | $V_{CC} = \pm 5\text{ V}$ | | 100 | | |
| | Bandwidth for 0.1-dB flatness | Gain = 10 | $V_{CC} = \pm 15\text{ V}$ | | 17 | | |
| Full-power bandwidth ⁽¹⁾ | $V_{O(pp)} = 20\text{ V}, V_{CC} = \pm 15\text{ V}$ | | | 7.5 | | | |
| | $V_{O(pp)} = 5\text{ V}, V_{CC} = \pm 5\text{ V}$ | | | 23.6 | | | |
| SR | Slew rate ⁽²⁾ | Gain = 10 | $V_{CC} = \pm 15\text{ V}, 20\text{-V step}$ | | 470 | | V/ μs |
| | | | $V_{CC} = \pm 5\text{ V}, 5\text{-V step}$ | | 370 | | |
| t_s | Settling time to 0.1% | Gain = -10 | $V_{CC} = \pm 15\text{ V}, 5\text{-V step}$ | | 30 | | ns |
| | | | $V_{CC} = \pm 5\text{ V}, 2\text{-V step}$ | | 30 | | |
| | Settling time to 0.01% | Gain = -10 | $V_{CC} = \pm 15\text{ V}, 5\text{-V step}$ | | 160 | | |
| | | | $V_{CC} = \pm 5\text{ V}, 2\text{-V step}$ | | 160 | | |
| NOISE AND DISTORTION PERFORMANCE | | | | | | | |
| THD | Total harmonic distortion | $V_{O(pp)} = 2\text{ V}, f = 1\text{ MHz},$ gain = 10, $V_{CC} = \pm 15\text{ V}$ | $R_L = 1\text{ k}\Omega$ | | -68 | | dBc |
| | | | $R_L = 1\text{ k}\Omega$ | | -77 | | |
| | | $V_{O(pp)} = 2\text{ V}, f = 1\text{ MHz},$ gain = 10, $V_{CC} = \pm 5\text{ V}$ | $R_L = 1\text{ k}\Omega$ | | -69 | | |
| | | | $R_L = 1\text{ k}\Omega$ | | -78 | | |
| V_n | Input voltage noise | $V_{CC} = \pm 5\text{ V or } \pm 15\text{ V}, f > 10\text{ kHz}$ | | | 1.2 | | nV/ $\sqrt{\text{Hz}}$ |
| I_n | Input current noise | $V_{CC} = \pm 5\text{ V or } \pm 15\text{ V}, f > 10\text{ kHz}$ | | | 2.3 | | pA/ $\sqrt{\text{Hz}}$ |
| | Differential gain error | Gain = 10, NTSC, 40 IRE modulation, $\pm 100\text{ IRE ramp}$ | $V_{CC} = \pm 15$ | | 0.02 | | % |
| | | | $V_{CC} = \pm 5\text{ V}$ | | 0.02 | | |
| | Differential phase error | Gain = 10, NTSC, 40 IRE modulation, $\pm 100\text{ IRE ramp}$ | $V_{CC} = \pm 15$ | | 0.08 | | ° |
| | | | $V_{CC} = \pm 5\text{ V}$ | | 0.06 | | |
| X_T | Channel-to-channel crosstalk (THS4022 only) | $V_{CC} = \pm 5\text{ V or } \pm 15\text{ V}, f = 1\text{ MHz}$ | | | -54 | | dBc |
| DC PERFORMANCE | | | | | | | |
| | Open-loop gain | $V_{CC} = \pm 15\text{ V}, V_O = \pm 10\text{ V},$ $R_L = 1\text{ k}\Omega$ | $T_A = 25^\circ\text{C}$ | 92 | 100 | | dB |
| | | | $T_A = \text{full range}$ | 91 | | | |
| | | $V_{CC} = \pm 5\text{ V}, V_O = \pm 2.5\text{ V},$ $R_L = 1\text{ k}\Omega$ | $T_A = 25^\circ\text{C}$ | 86 | 98 | | |
| | | | $T_A = \text{full range}$ | 84 | | | |
| V_{OS} | Input offset voltage | $V_{CC} = \pm 5\text{ V or } \pm 15\text{ V}$ | $T_A = 25^\circ\text{C}$ | | 0.3 | 2 | mV |
| | | | $T_A = \text{full range}$ | | | 3 | |
| | Offset voltage drift | $V_{CC} = \pm 5\text{ V or } \pm 15\text{ V}, T_A = \text{full range}$ | | | 2 | | $\mu\text{V}/^\circ\text{C}$ |
| I_{IB} | Input bias current | $V_{CC} = \pm 5\text{ V or } \pm 15\text{ V}$ | $T_A = 25^\circ\text{C}$ | | 9 | 20 | μA |
| | | | $T_A = \text{full range}$ | | | 33 | μA |
| I_{OS} | Input offset current | $V_{CC} = \pm 5\text{ V or } \pm 15\text{ V}$ | $T_A = 25^\circ\text{C}$ | | 30 | 250 | nA |
| | | | $T_A = \text{full range}$ | | | 400 | nA |
| | Input offset current drift | $V_{CC} = \pm 5\text{ V or } \pm 15\text{ V}, T_A = \text{full range}$ | | | 0.2 | | nA/ $^\circ\text{C}$ |

5.6 Electrical Characteristics - THS4021D and THS4022DGN (续)

at $T_A = 25^\circ\text{C}$, $V_{CC} = \pm 15\text{ V}$, and $R_L = 150\ \Omega$ (unless otherwise noted)

| PARAMETER | | TEST CONDITIONS | | MIN | TYP | MAX | UNIT |
|-------------------------------|----------------------------------|--|---------------------------|---------------------------|------------|------------|------------|
| INPUT CHARACTERISTICS | | | | | | | |
| V_{ICR} | Common-mode input voltage | $V_{CC} = \pm 15\text{ V}$ | | ± 13.8 | ± 14.3 | | V |
| | | $V_{CC} = \pm 5\text{ V}$ | | ± 3.8 | ± 4.3 | | |
| $CMRR$ | Common-mode rejection ratio | $V_{CC} = \pm 15\text{ V}$, $V_{ICR} = \pm 12\text{ V}$ | $T_A = 25^\circ\text{C}$ | 95 | | | dB |
| | | | $T_A = \text{full range}$ | 74 | | | |
| | | $V_{CC} = \pm 5\text{ V}$, $V_{ICR} = \pm 2.5\text{ V}$ | $T_A = 25^\circ\text{C}$ | 100 | | | |
| | | | $T_A = \text{full range}$ | 85 | | | |
| r_i | Input resistance | | | | 1 | | M Ω |
| C_i | Input capacitance | | | | 1.5 | | pF |
| OUTPUT CHARACTERISTICS | | | | | | | |
| V_O | Output voltage swing | $V_{CC} = \pm 15\text{ V}$, $R_L = 250\ \Omega$ | | ± 12 | ± 12.9 | | V |
| | | $V_{CC} = \pm 5\text{ V}$, $R_L = 150\ \Omega$ | | ± 3 | ± 3.5 | | |
| | | $V_{CC} = \pm 15\text{ V}$, $R_L = 1\text{ k}\Omega$ | | ± 13 | ± 13.6 | | |
| | | $V_{CC} = \pm 5\text{ V}$, $R_L = 1\text{ k}\Omega$ | | ± 3.4 | ± 3.8 | | |
| I_O | Output current | $V_{CC} = \pm 15\text{ V}$, $R_L = 10\ \Omega$ | | 80 | 200 | | mA |
| | | $V_{CC} = \pm 5\text{ V}$, $R_L = 10\ \Omega$ | | 50 | 160 | | |
| R_O | Output resistance ⁽³⁾ | Open-loop | | | 5 | | Ω |
| POWER SUPPLY | | | | | | | |
| V_{CC} | Supply voltage | Dual supply | | ± 4.5 | | ± 16.5 | V |
| | | Single supply | | 9 | | 33 | |
| I_{CC} | Supply current (per amplifier) | $V_{CC} = \pm 15\text{ V}$ | $T_A = 25^\circ\text{C}$ | 7.5 | | 10 | mA |
| | | | $T_A = \text{full range}$ | | | 11 | |
| | | $V_{CC} = \pm 5\text{ V}$ | $T_A = 25^\circ\text{C}$ | 6.5 | | 9 | |
| | | | $T_A = \text{full range}$ | | | 10.5 | |
| PSRR | Power-supply rejection ratio | $V_{CC} = \pm 5\text{ V}$ or $\pm 15\text{ V}$ | | $T_A = 25^\circ\text{C}$ | 95 | | dB |
| | | | | $T_A = \text{full range}$ | 80 | | |

- (1) Full-power bandwidth = slew rate / [$\pi V_{O(P-P)}$].
- (2) Slew rate is measured from an output level range of 25% to 75%.
- (3) Keep junction temperature less than the absolute maximum rating when the output is heavily loaded or shorted; see also [节 5.1](#).

5.7 Electrical Characteristics - THS4021DGN

at $T_A = 25^\circ\text{C}$, $V_{CC} = \pm 15\text{ V}$, $R_L = 150\ \Omega$ (unless otherwise noted)

| PARAMETER | | TEST CONDITIONS | | MIN | TYP | MAX | UNIT |
|-------------------------------------|-------------------------------------|---|--|-----|------|------------------------|------------------------------|
| DYNAMIC PERFORMANCE | | | | | | | |
| BW | Small-signal bandwidth (-3 dB) | Gain = 10 | $V_{CC} = \pm 15\text{ V}$ | | 350 | | MHz |
| | | | $V_{CC} = \pm 5\text{ V}$ | | 280 | | |
| | | Gain = 20 | $V_{CC} = \pm 15\text{ V}$ | | 80 | | |
| | | | $V_{CC} = \pm 5\text{ V}$ | | 70 | | |
| | Bandwidth for 0.1-dB flatness | Gain = 10 | $V_{CC} = \pm 15\text{ V}$ | | 17 | | |
| | | $V_{CC} = \pm 5\text{ V}$ | | 17 | | | |
| | Full-power bandwidth ⁽¹⁾ | $V_{O(pp)} = 20\text{ V}$, $V_{CC} = \pm 15\text{ V}$ | | | 3.7 | | |
| | | $V_{O(pp)} = 5\text{ V}$, $V_{CC} = \pm 5\text{ V}$ | | | 11.8 | | |
| SR | Slew rate ⁽²⁾ | Gain = 10 | $V_{CC} = \pm 15\text{ V}$, 10-V step | | 470 | | V/ μs |
| | | | $V_{CC} = \pm 5\text{ V}$, 5-V step | | 370 | | |
| t_s | Settling time to 0.1% | Gain = -10 | $V_{CC} = \pm 15\text{ V}$, 5-V step | | 40 | | ns |
| | | | $V_{CC} = \pm 5\text{ V}$, 2-V step | | 50 | | |
| | Settling time to 0.01% | Gain = -10 | $V_{CC} = \pm 15\text{ V}$, 5-V step | | 145 | | |
| | | | $V_{CC} = \pm 5\text{ V}$, 2-V step | | 150 | | |
| NOISE/DISTORTION PERFORMANCE | | | | | | | |
| THD | Total harmonic distortion | $V_{O(pp)} = 2\text{ V}$, $f = 1\text{ MHz}$, gain = 2, $V_{CC} = \pm 15\text{ V}$ | $R_L = 1\text{ k}\Omega$ | | -68 | | dBc |
| | | | | | -77 | | |
| | | | $R_L = 1\text{ k}\Omega$ | | -69 | | |
| | | | | | -78 | | |
| V_n | Input voltage noise | $V_{CC} = \pm 5\text{ V}$ or $\pm 15\text{ V}$, $f > 10\text{ kHz}$ | | | 1.5 | nV/ $\sqrt{\text{Hz}}$ | |
| I_n | Input current noise | $V_{CC} = \pm 5\text{ V}$ or $\pm 15\text{ V}$, $f > 10\text{ kHz}$ | | | 2 | pA/ $\sqrt{\text{Hz}}$ | |
| | Differential gain error | Gain = 2, NTSC, 40 IRE modulation, $\pm 100\text{ IRE}$ ramp | $V_{CC} = \pm 15$ | | 0.02 | | % |
| | | | $V_{CC} = \pm 5\text{ V}$ | | 0.02 | | |
| | Differential phase error | Gain = 2, NTSC, 40 IRE modulation, $\pm 100\text{ IRE}$ ramp | $V_{CC} = \pm 15$ | | 0.08 | | ° |
| | | | $V_{CC} = \pm 5\text{ V}$ | | 0.06 | | |
| DC PERFORMANCE | | | | | | | |
| | Open-loop gain | $V_{CC} = \pm 15\text{ V}$, $V_O = \pm 10\text{ V}$, $R_L = 1\text{ k}\Omega$ | $T_A = 25^\circ\text{C}$ | 40 | 60 | | V/mV |
| | | | $T_A = \text{full range}$ | 35 | | | |
| | | $V_{CC} = \pm 5\text{ V}$, $V_O = \pm 2.5\text{ V}$, $R_L = 250\ \Omega$ | $T_A = 25^\circ\text{C}$ | 20 | 35 | | |
| | | | $T_A = \text{full range}$ | 15 | | | |
| V_{OS} | Input offset voltage | $V_{CC} = \pm 5\text{ V}$ or $\pm 15\text{ V}$ | $T_A = 25^\circ\text{C}$ | | 0.5 | 2 | mV |
| | | | $T_A = \text{full range}$ | | | 3 | |
| | Offset voltage drift | $V_{CC} = \pm 5\text{ V}$ or $\pm 15\text{ V}$ | $T_A = \text{full range}$ | | 15 | | $\mu\text{V}/^\circ\text{C}$ |
| I_{IB} | Input bias current | $V_{CC} = \pm 5\text{ V}$ or $\pm 15\text{ V}$ | $T_A = 25^\circ\text{C}$ | | 3 | 6 | μA |
| | | | $T_A = \text{full range}$ | | | 6 | |
| I_{OS} | Input offset current | $V_{CC} = \pm 5\text{ V}$ or $\pm 15\text{ V}$ | $T_A = 25^\circ\text{C}$ | | 30 | 250 | nA |
| | | | $T_A = \text{full range}$ | | | 400 | |
| | Input offset current drift | $T_A = \text{full range}$ | | | 0.3 | | nA/ $^\circ\text{C}$ |

5.7 Electrical Characteristics - THS4021DGN (续)

at $T_A = 25^\circ\text{C}$, $V_{CC} = \pm 15\text{ V}$, $R_L = 150\ \Omega$ (unless otherwise noted)

| PARAMETER | | TEST CONDITIONS | | MIN | TYP | MAX | UNIT |
|-------------------------------|--------------------------------------|--|----------------------------|------------|------------|------------|------------|
| INPUT CHARACTERISTICS | | | | | | | |
| V_{ICR} | Common-mode input voltage | $V_{CC} = \pm 15\text{ V}$ | | ± 13.8 | ± 14.3 | | V |
| | | $V_{CC} = \pm 5\text{ V}$ | | ± 3.8 | ± 4.3 | | |
| CMRR | Common-mode rejection ratio | $V_{CC} = \pm 15\text{ V}$, $V_{ICR} = \pm 12\text{ V}$, $T_A = \text{full range}$ | | 74 | 95 | | dB |
| r_i | Input resistance | | | | 1 | | M Ω |
| C_i | Input capacitance | | | | 1.5 | | pF |
| OUTPUT CHARACTERISTICS | | | | | | | |
| V_O | Output voltage swing | $V_{CC} = \pm 15\text{ V}$, $R_L = 250\ \Omega$ | | ± 12 | ± 12.5 | | V |
| | | $V_{CC} = \pm 5\text{ V}$, $R_L = 150\ \Omega$ | | ± 3 | ± 3.3 | | |
| | | $V_{CC} = \pm 15\text{ V}$, $R_L = 150\ \Omega$ | | ± 13 | ± 13.5 | | |
| | | $V_{CC} = \pm 5\text{ V}$, $R_L = 150\ \Omega$ | | ± 3.4 | ± 3.8 | | |
| I_O | Output current | $R_L = 20\ \Omega$ | $V_{CC} = \pm 15\text{ V}$ | 80 | 100 | | mA |
| | | | $V_{CC} = \pm 5\text{ V}$ | 50 | 75 | | |
| I_{SC} | Short-circuit current ⁽³⁾ | $V_{CC} = \pm 15\text{ V}$ | | | 150 | | mA |
| R_O | Output resistance ⁽³⁾ | Open loop | | | 13 | | Ω |
| POWER SUPPLY | | | | | | | |
| V_{CC} | Supply voltage | Dual supply | | ± 4.5 | | ± 16.5 | V |
| | | Single supply | | 9 | | 33 | |
| I_{CC} | Supply current (per amplifier) | $V_{CC} = \pm 15\text{ V}$ | $T_A = 25^\circ\text{C}$ | | 7.8 | 10 | mA |
| | | | $T_A = \text{full range}$ | | | 11 | |
| | | $V_{CC} = \pm 5\text{ V}$ | $T_A = 25^\circ\text{C}$ | | 6.7 | 9 | |
| | | | $T_A = \text{full range}$ | | | 10.5 | |
| PSRR | Power-supply rejection ratio | $V_{CC} = \pm 5\text{ V}$ or $\pm 15\text{ V}$, $T_A = \text{full range}$ | | 80 | 95 | | dB |

(1) Full-power bandwidth = slew rate / $2\pi V_{O(\text{Peak})}$.

(2) Slew rate is measured from an output level range of 25% to 75%.

(3) Keep junction temperature less than the absolute maximum rating when the output is heavily loaded or shorted; see also [节 5.1](#).

5.8 Typical Characteristics: THS4021D and THS4022DGN

at $T_A = 25^\circ\text{C}$, $V_{CC} = \pm 15\text{ V}$, gain = +10 V/V, $R_L = 150\ \Omega$, and $R_F = 220\ \Omega$ (unless otherwise noted)



图 5-1. Frequency Response vs Feedback Resistance



图 5-2. Frequency Response vs Feedback Resistance

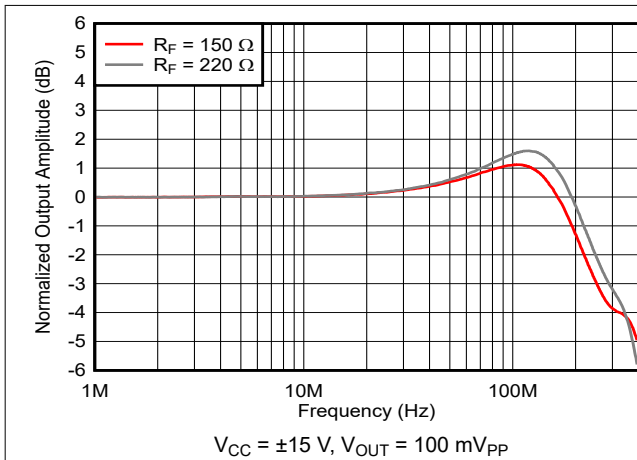

图 5-3. Frequency Response vs Gain

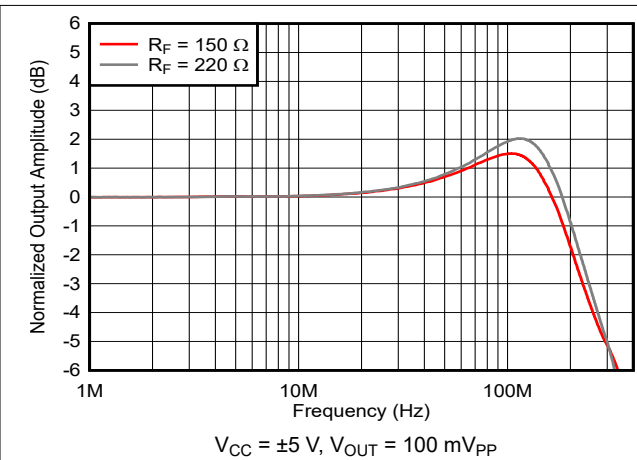

图 5-4. Frequency Response vs Gain

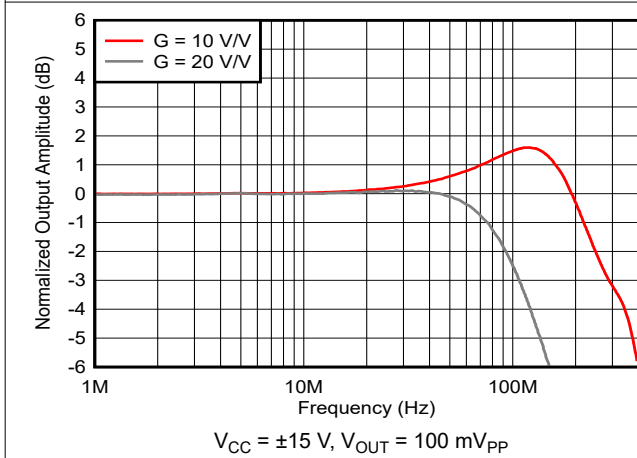

图 5-5. Large-Signal Frequency Response

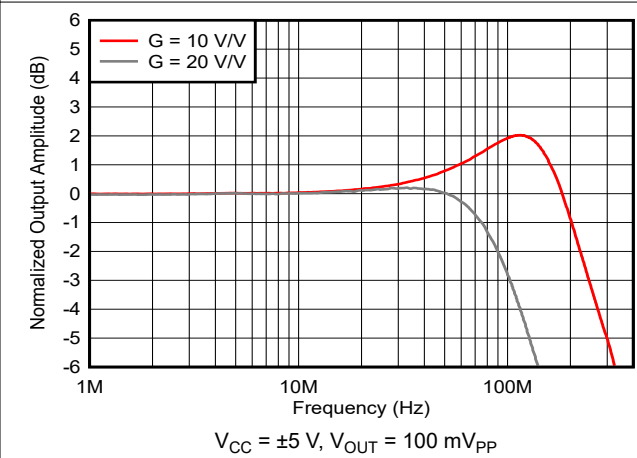

图 5-6. Large-Signal Frequency Response

5.8 Typical Characteristics: THS4021D and THS4022DGN (continued)

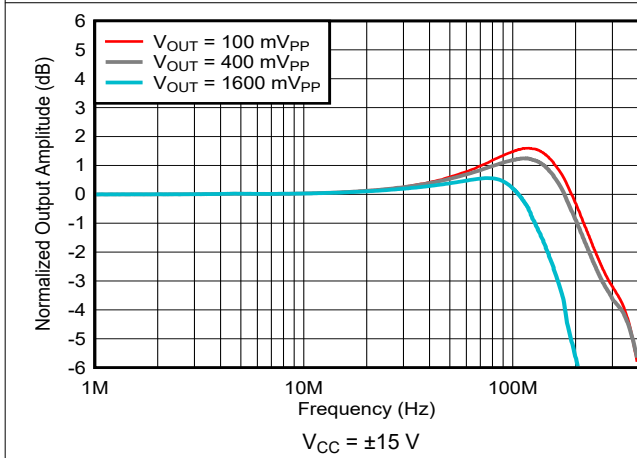
at $T_A = 25^\circ\text{C}$, $V_{CC} = \pm 15\text{ V}$, gain = +10 V/V, $R_L = 150\ \Omega$, and $R_F = 220\ \Omega$ (unless otherwise noted)

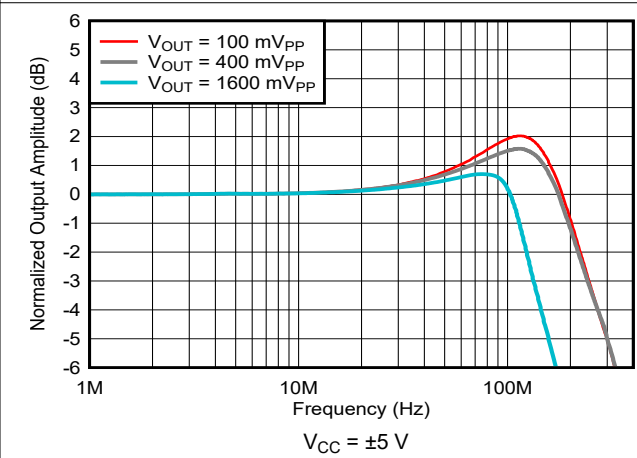
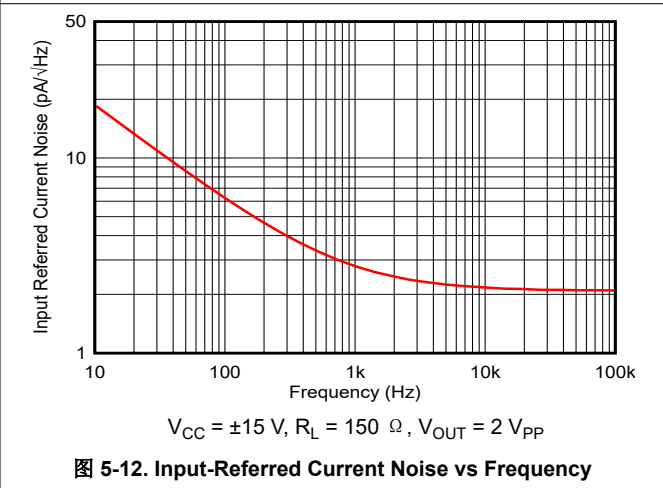
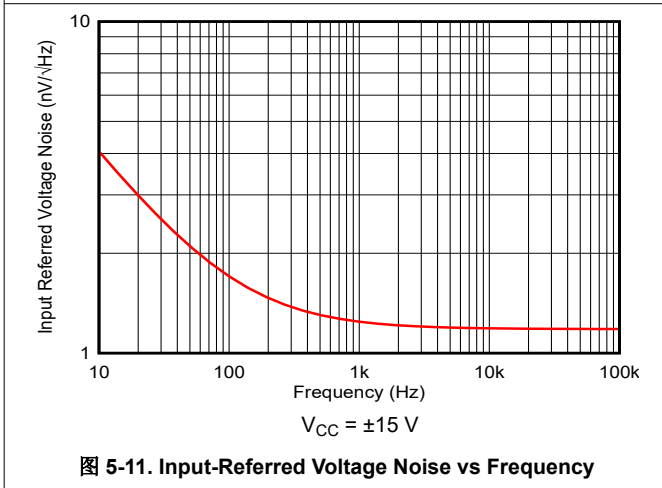
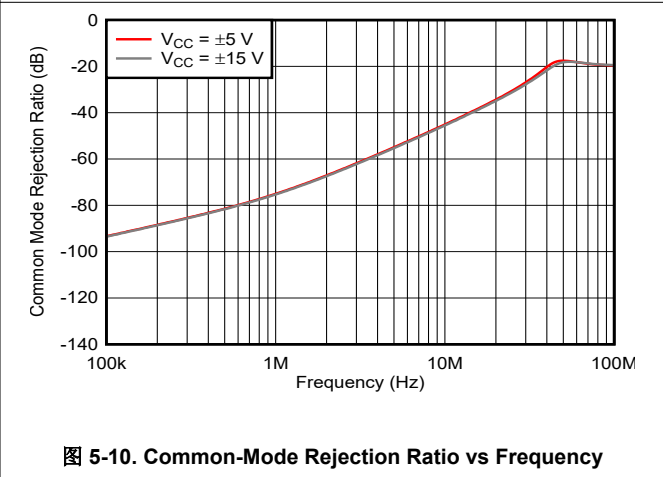
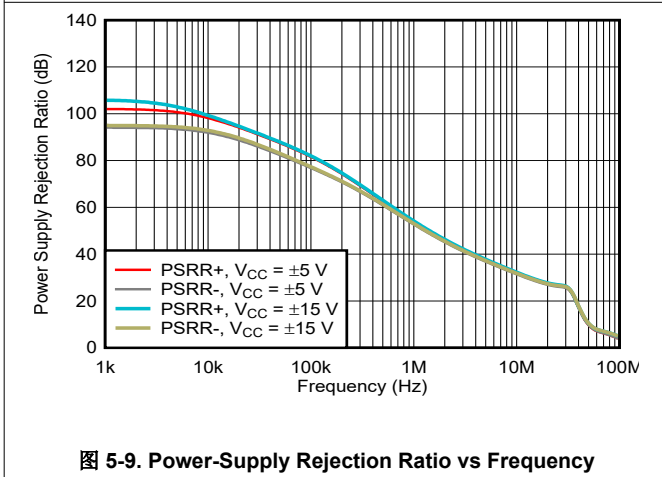
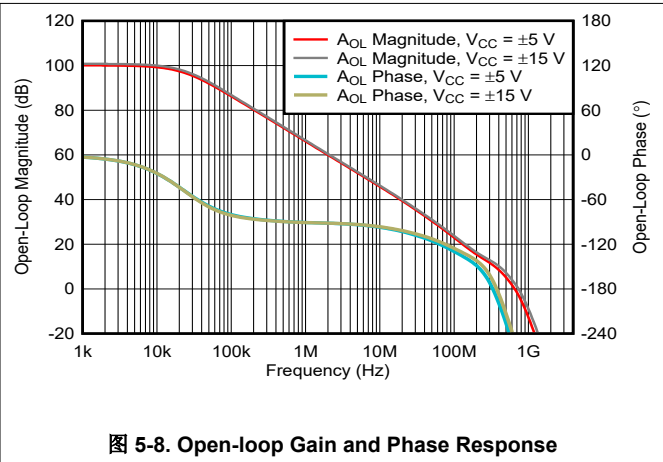
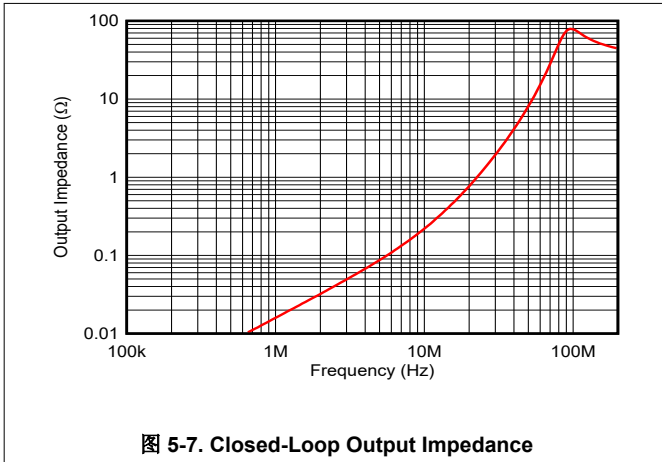

5.8 Typical Characteristics: THS4021D and THS4022DGN (continued)

at $T_A = 25^\circ\text{C}$, $V_{CC} = \pm 15\text{ V}$, gain = +10 V/V, $R_L = 150\ \Omega$, and $R_F = 220\ \Omega$ (unless otherwise noted)

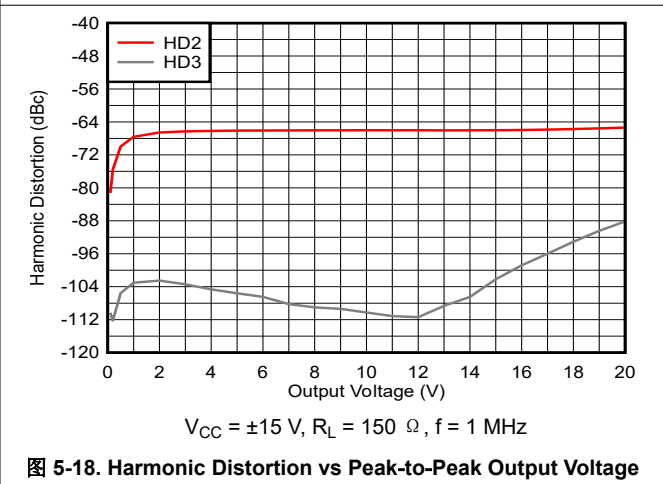
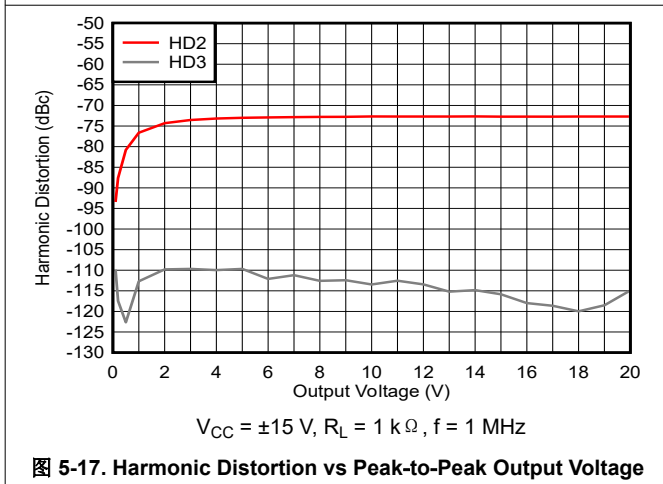
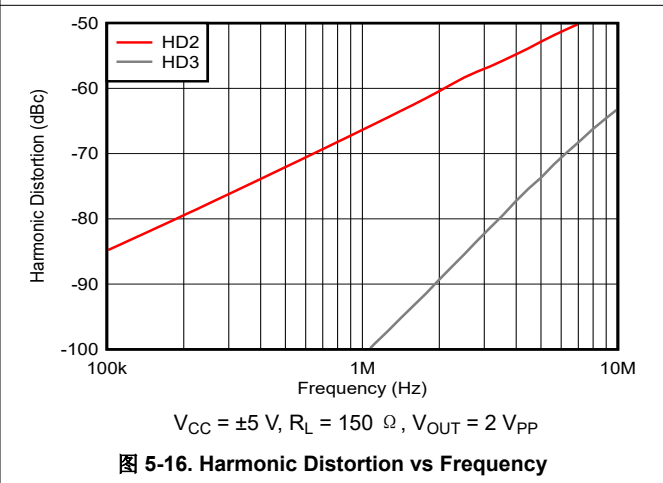
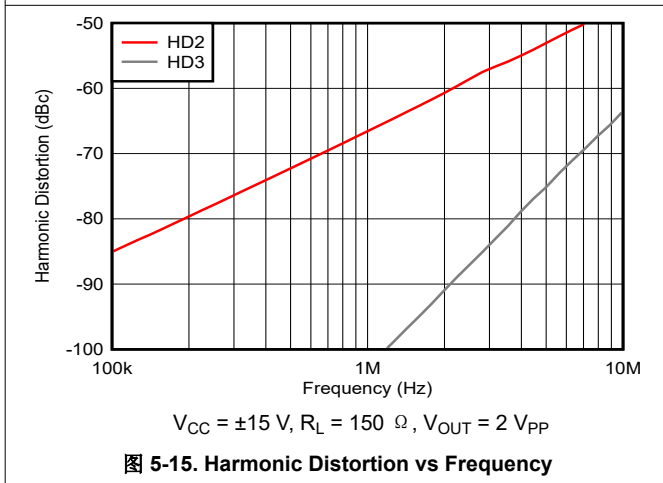
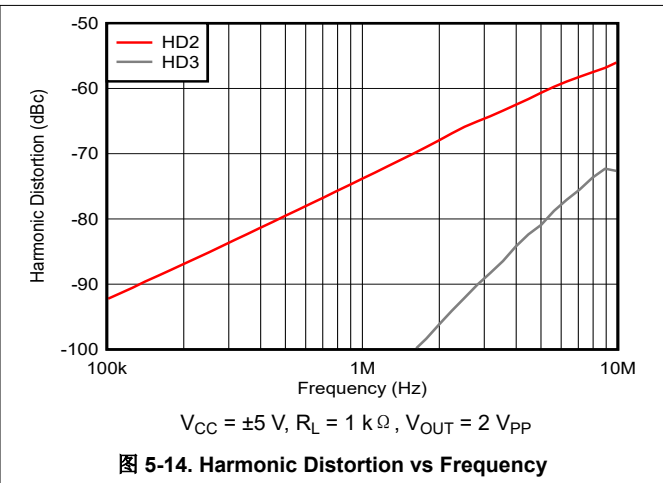
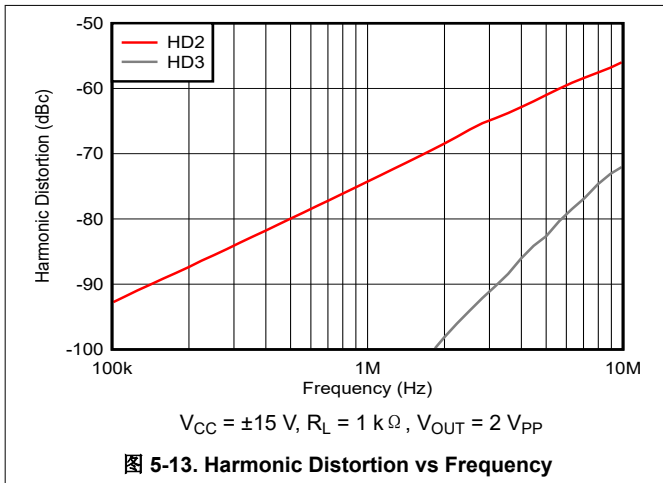

5.8 Typical Characteristics: THS4021D and THS4022DGN (continued)

at $T_A = 25^\circ\text{C}$, $V_{CC} = \pm 15\text{ V}$, gain = +10 V/V, $R_L = 150\ \Omega$, and $R_F = 220\ \Omega$ (unless otherwise noted)



图 5-19. Total Harmonic Distortion vs Frequency



图 5-20. Crosstalk vs Frequency

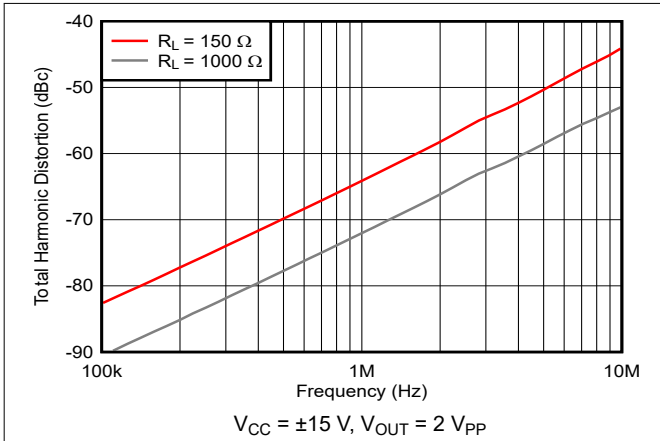

图 5-21. 1-V Step Response

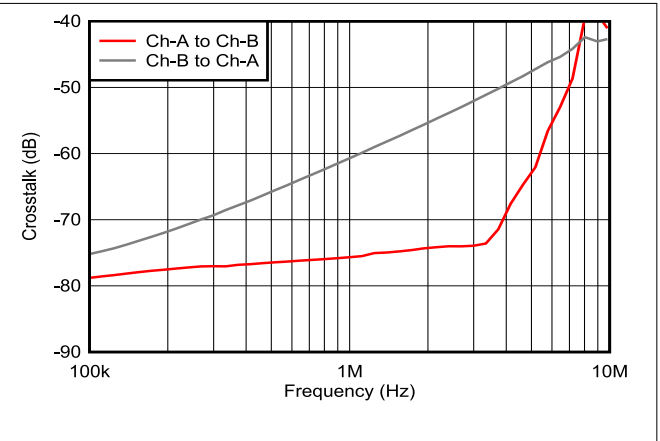

图 5-22. 5-V Step Response

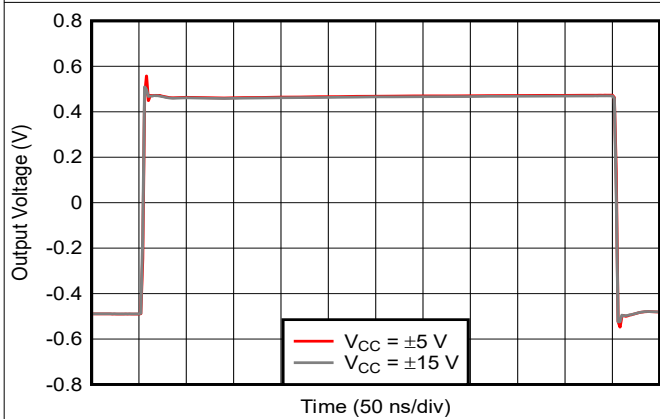

图 5-23. 10-V Step Response

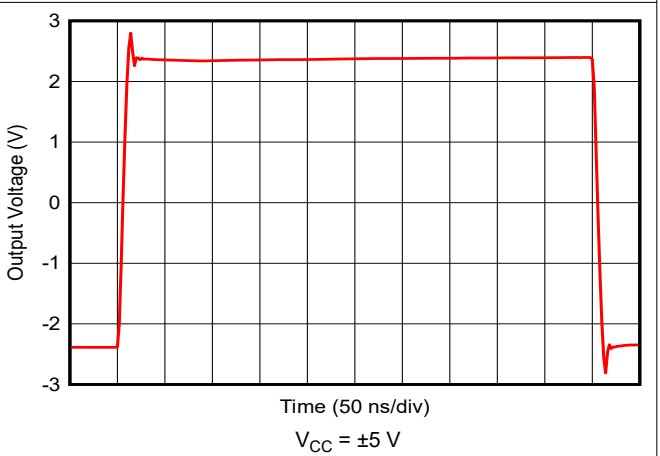

图 5-24. Input Offset Voltage vs Ambient Temperature

5.8 Typical Characteristics: THS4021D and THS4022DGN (continued)

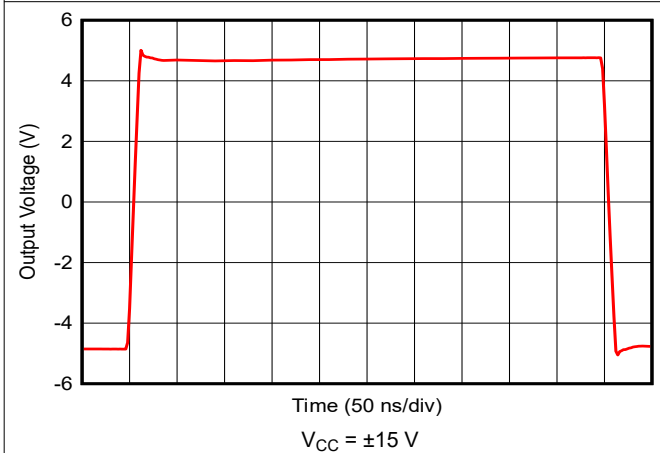
at $T_A = 25^\circ\text{C}$, $V_{CC} = \pm 15\text{ V}$, gain = +10 V/V, $R_L = 150\ \Omega$, and $R_F = 220\ \Omega$ (unless otherwise noted)

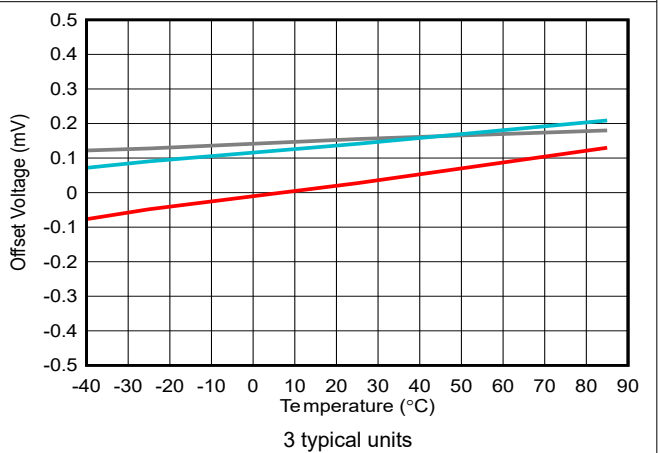

图 5-25. Voltage Offset Distribution



图 5-26. Input Offset Current vs Ambient Temperature

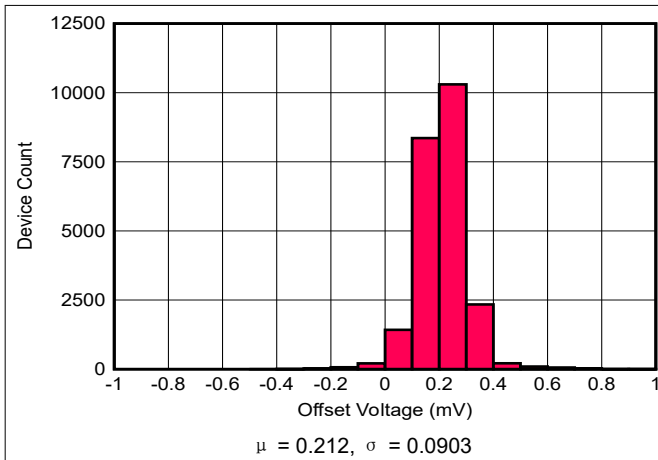

图 5-27. Input Offset Current vs Ambient Temperature

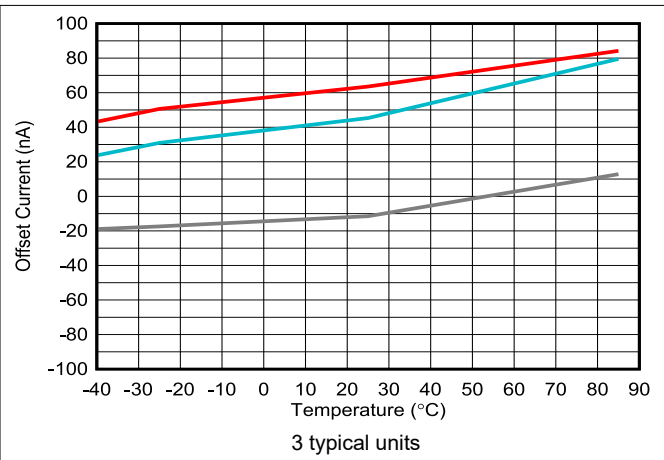

图 5-28. Offset Voltage vs Output Voltage

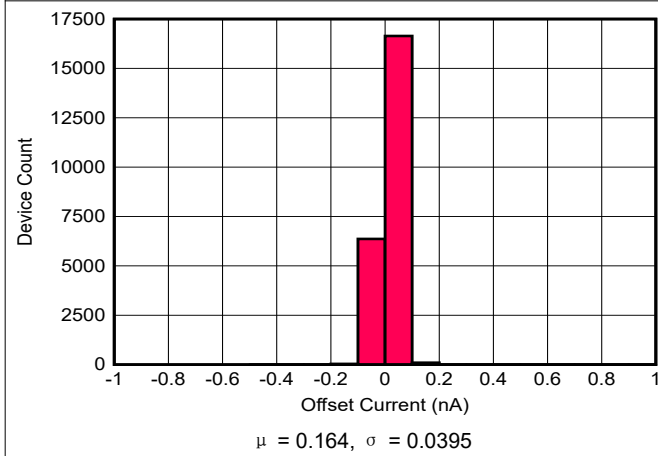

图 5-29. Maximum Output Voltage Swing vs Ambient Temperature

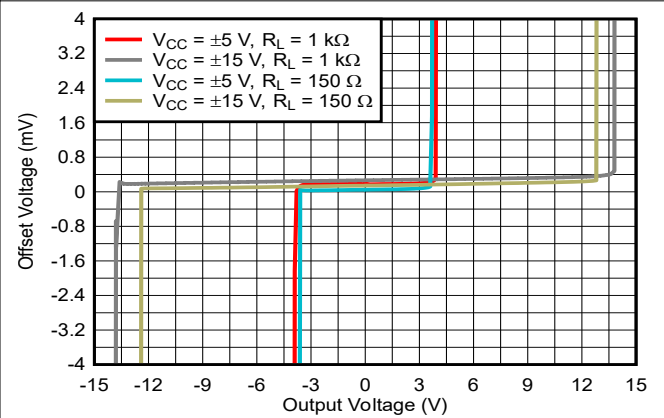

图 5-30. Output Swing vs Load Current

5.8 Typical Characteristics: THS4021D and THS4022DGN (continued)

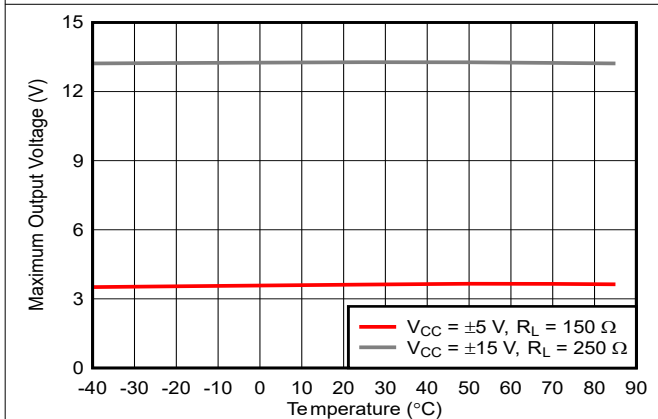
at $T_A = 25^\circ\text{C}$, $V_{CC} = \pm 15\text{ V}$, gain = +10 V/V, $R_L = 150\ \Omega$, and $R_F = 220\ \Omega$ (unless otherwise noted)

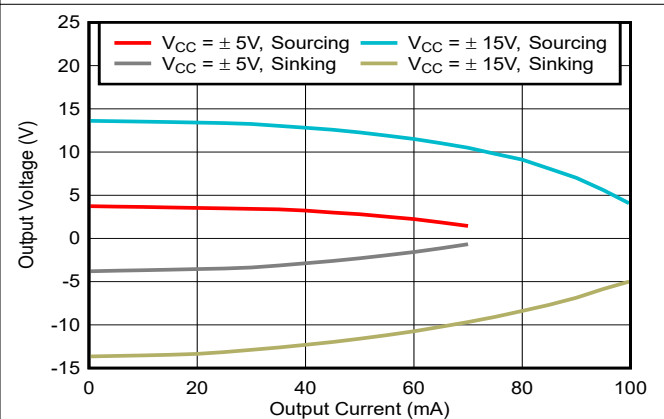

图 5-31. Supply Current vs Ambient Temperature

5.9 Typical Characteristics: THS4021DGN



图 5-32. Open Loop Gain and Phase Response vs Frequency

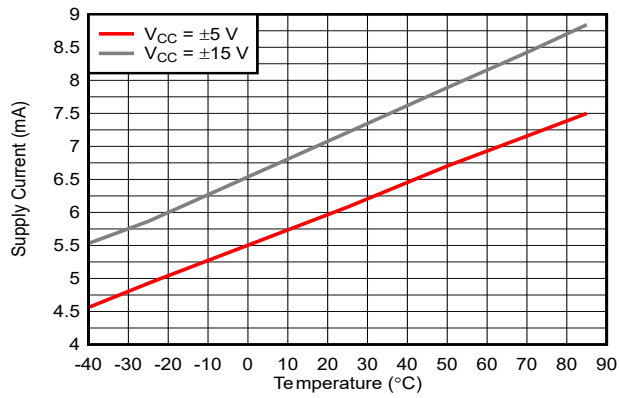

图 5-33. Total Harmonic Distortion vs Frequency

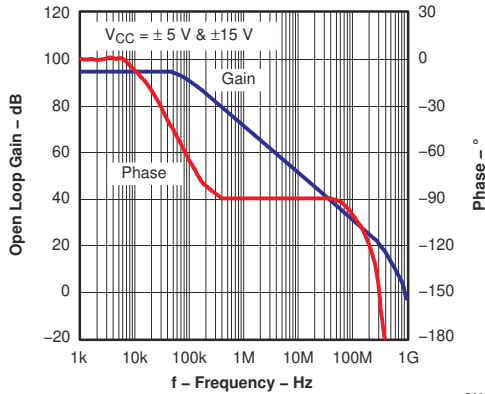

图 5-34. Distortion vs Output Voltage

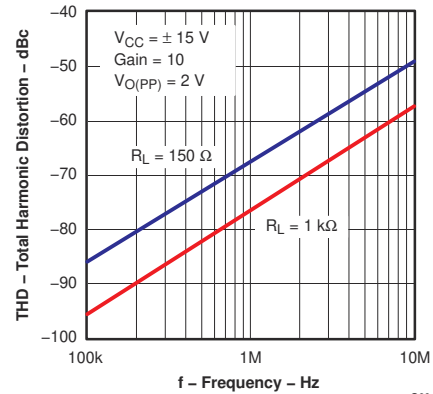

图 5-35. Distortion vs Output Voltage

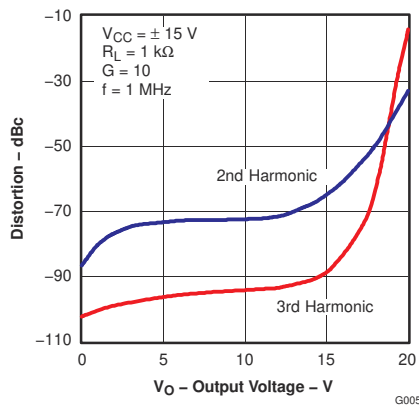

图 5-36. Distortion vs Frequency

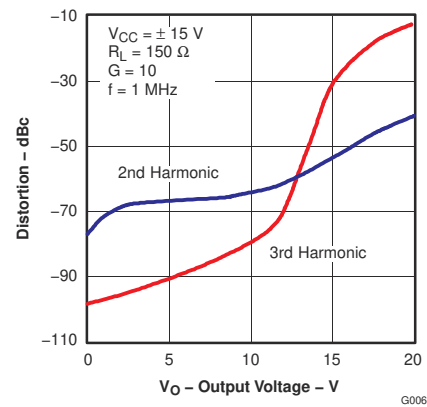

图 5-37. Distortion vs Frequency

5.9 Typical Characteristics: THS4021DGN (continued)

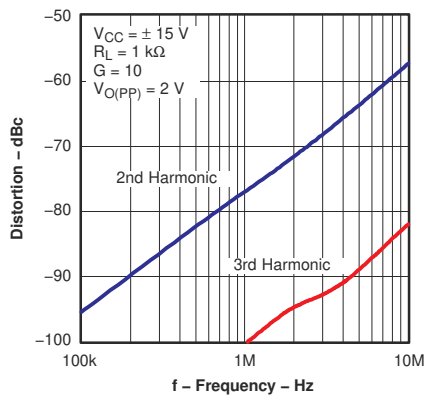

图 5-38. Distortion vs Frequency

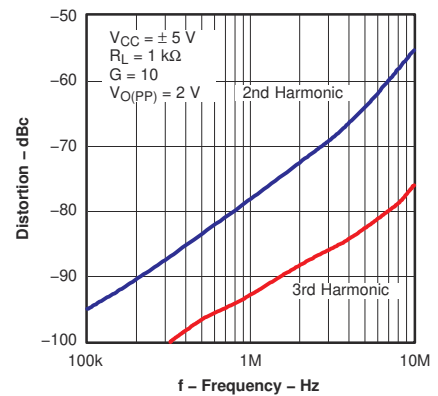

图 5-39. Distortion vs Frequency

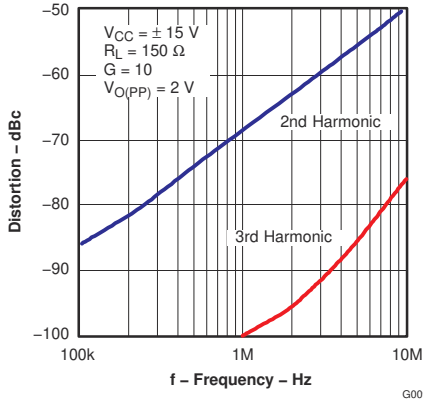

图 5-40. Output Amplitude vs Frequency

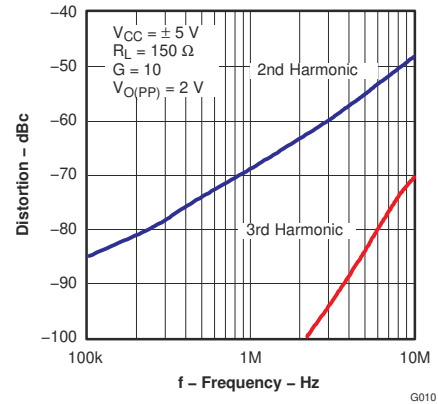

图 5-41. Output Amplitude vs Frequency

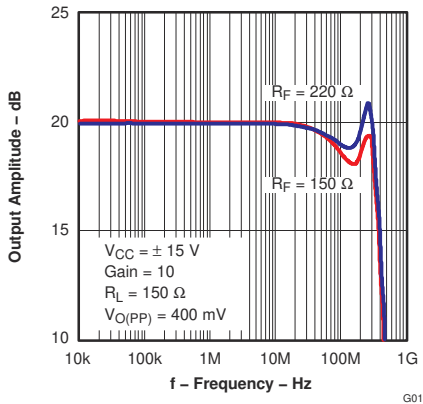

图 5-42. Output Amplitude vs Frequency

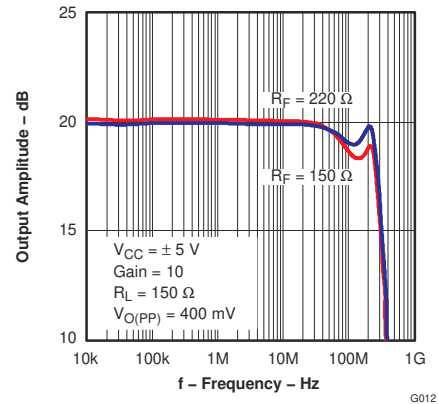

图 5-43. Output Amplitude vs Frequency

5.9 Typical Characteristics: THS4021DGN (continued)

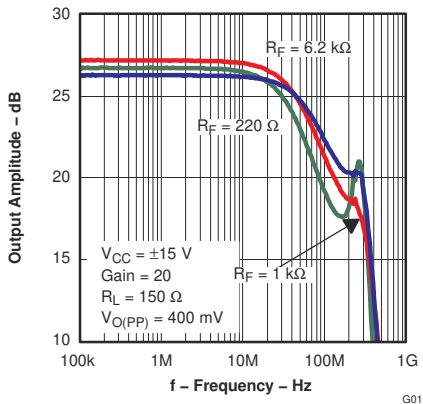

图 5-44. 1-V Step Response

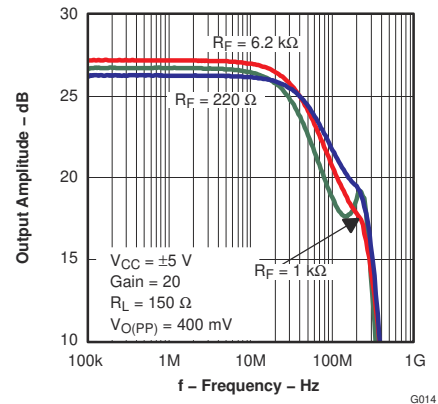

图 5-45. 5-V Step Response

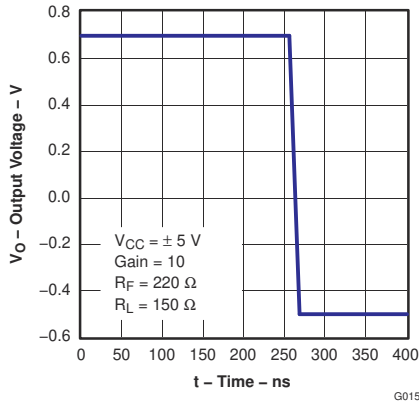

图 5-46. 1-V Step Response

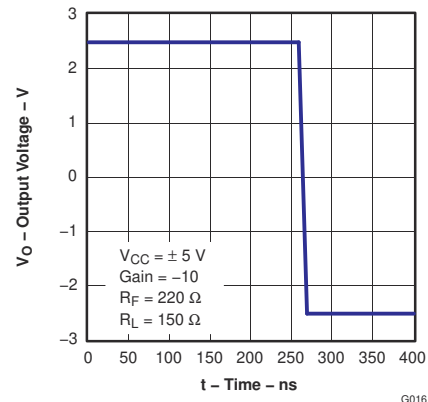

图 5-47. 10-V Step Response

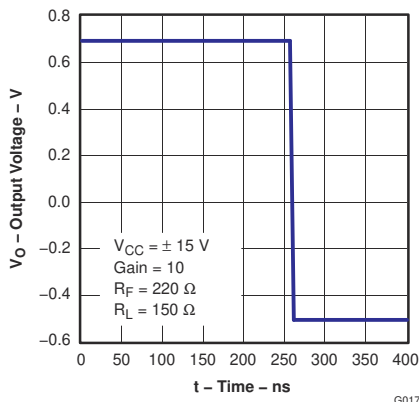

图 5-48. Input Offset Voltage vs Free-air Temperature

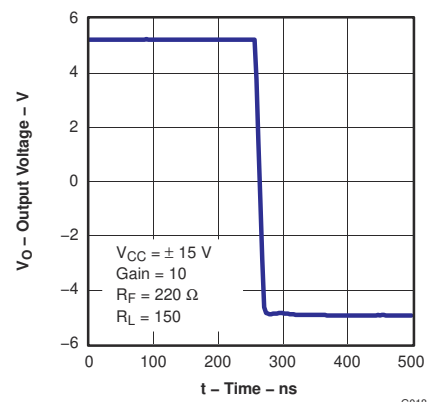

图 5-49. Input Bias Current vs Free-air Temperature

5.9 Typical Characteristics: THS4021DGN (continued)

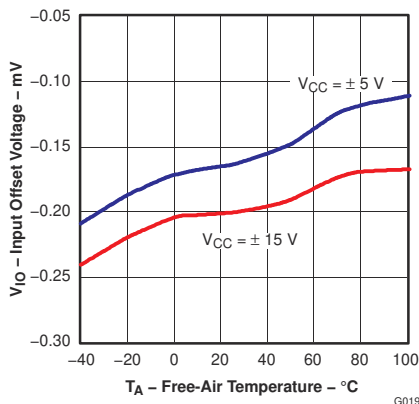

图 5-50. Output Voltage vs Supply Voltage

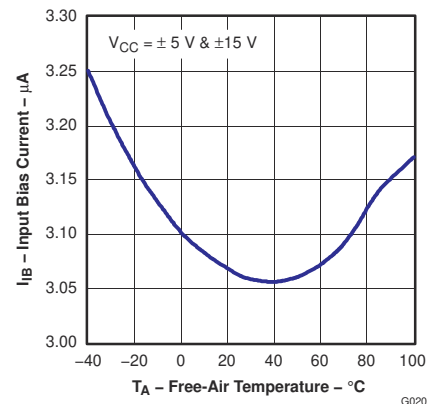

图 5-51. Common-mode Input Voltage vs Supply Voltage

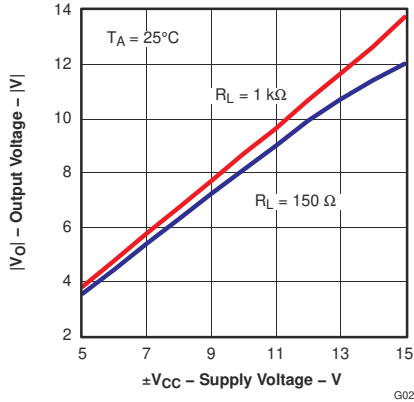

图 5-52. Output Voltage vs Free-air Temperature

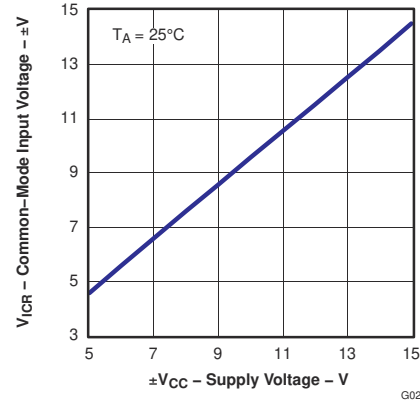

图 5-53. Supply Current vs Supply Voltage

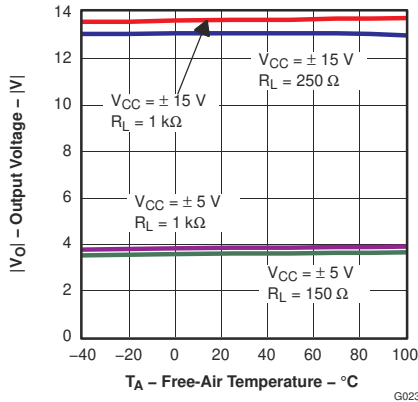

图 5-54. Voltage and Current Noise vs Frequency

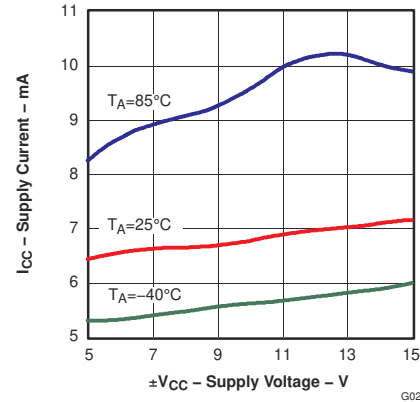

图 5-55. Power Supply Rejection Ratio vs Frequency

5.9 Typical Characteristics: THS4021DGN (continued)

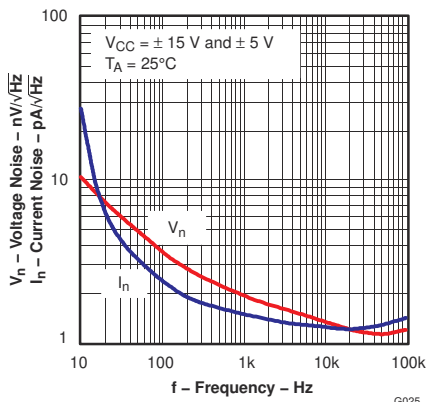

图 5-56. Common Mode Rejection Ratio vs Frequency

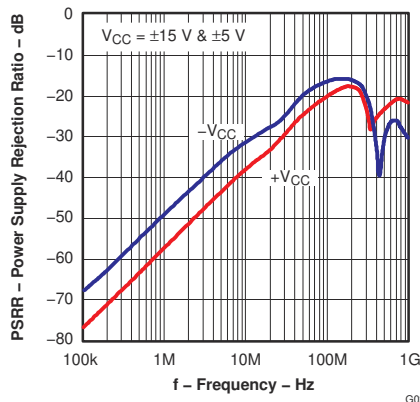
6 Detailed Description

6.1 Overview

The THS402x are high-speed operational amplifiers configured in a decompensated voltage-feedback architecture. The THS402x are stable with gain configurations of 10 V/V or greater. These amplifiers are built using a greater than 30-V, complementary, bipolar process with NPN and PNP transistors possessing an f_T of several GHz. This configuration results in exceptionally high-performance amplifiers with wide bandwidth, high slew rate, fast settling time, and low distortion.

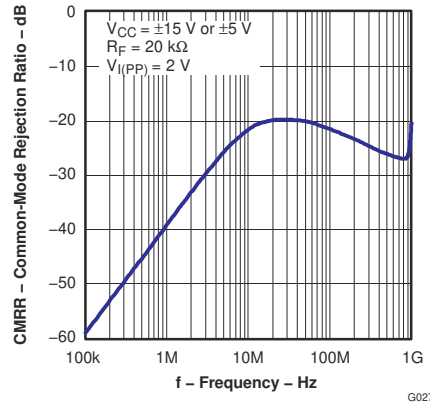
6.2 Functional Block Diagram



图 6-1. THS4021: Single Channel



图 6-2. THS4022: Dual Channel

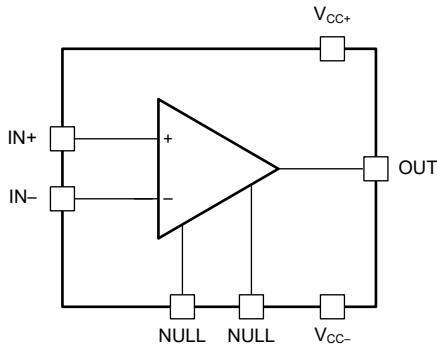

S0276-01

图 6-3. THS4021 Simplified Schematic

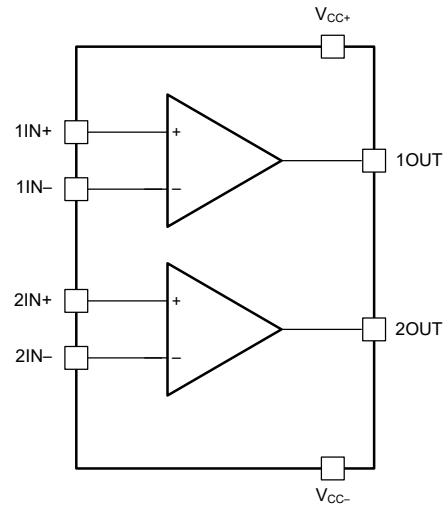
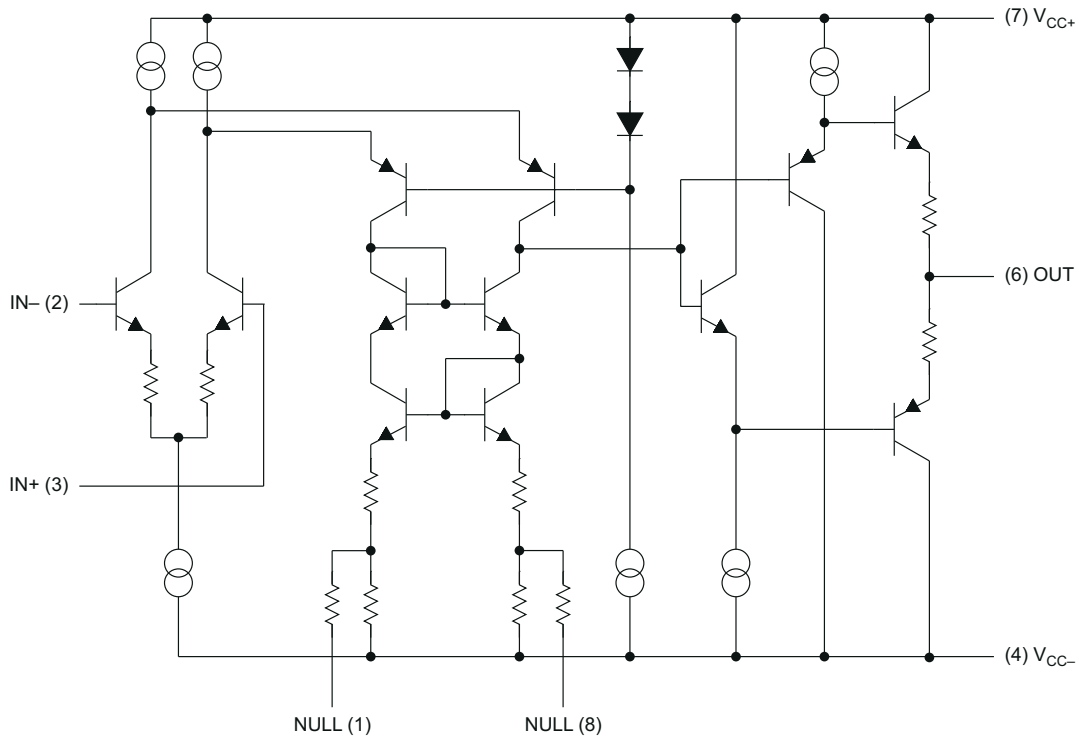
6.3 Feature Description

6.3.1 Offset Nulling

The THS402x have a very low input offset voltage for high-speed amplifiers. However, if additional correction is required, an offset nulling function has been provided on the THS4021. To adjust the input offset voltage, place a potentiometer between pin 1 and pin 8 of the device, and tie the wiper to the negative supply. 图 6-4 shows this feature.



图 6-4. Offset Nulling Schematic

6.4 Device Functional Modes

The THS402x family has a single functional mode and can be used with both single-supply or split power-supply configurations. The power-supply voltage must be greater than 9 V (± 4.5 V) and less than 33 V (± 16.5 V).

7 Application and Implementation

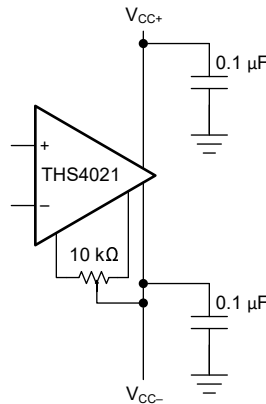
备注

以下应用部分中的信息不属于 TI 器件规格的范围，TI 不担保其准确性和完整性。TI 的客户应负责确定器件是否适用于其应用。客户应验证并测试其设计，以确保系统功能。

7.1 Application Information

7.1.1 Driving a Capacitive Load

The THS402x are internally compensated to maximize bandwidth and slew-rate performance. To maintain stability, take additional precautions when driving capacitive loads with a high-performance amplifier. As a result of the internal compensation, significant capacitive loading directly on the output node decreases the device phase margin, and potentially lead to high-frequency ringing or oscillations. Therefore, for capacitive loads greater than 10 pF, place an isolation resistor in series with the output of the amplifier. 图 7-1 shows this configuration. For most applications, a minimum resistance of 20 Ω is recommended. In 75- Ω transmission systems, setting the series resistor value to 75 Ω is a beneficial choice because this value isolates any capacitance loading and provides source impedance matching.



图 7-1. Driving a Capacitive Load

7.1.2 General Configuration

When receiving low-level signals, limiting the bandwidth of the incoming signals into the system is often required. 图 7-2 shows how the simplest way to accomplish this limiting is to place an RC filter at the noninverting pin of the amplifier.

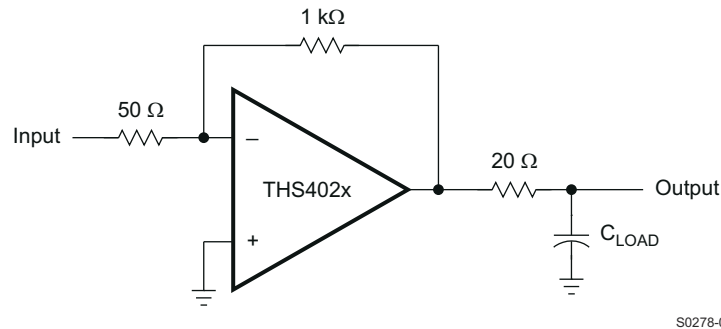

图 7-2. Single-Pole Low-Pass Filter

7.2 Power Supply Recommendations

The THS402x devices are designed to operate on power supplies ranging from ± 4.5 V to ± 16 V (single-ended supplies of 9 V to 32 V). Use a power-supply accuracy of 5% or better. When operated on a board with high-speed digital signals, make sure to provide isolation between digital signal noise and the analog input pins. The THS4021 and THS4022 are connected to the positive power supply (V_{CC+}) through pin 7 and pin 8, respectively. Both devices use pin 4 for the negative power supply (V_{CC-}). Decouple each supply pin to GND as close to the device as possible.

7.3 Layout

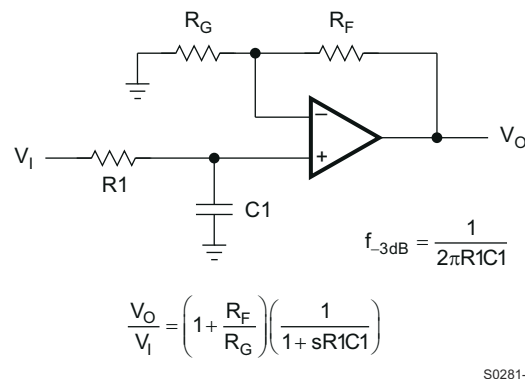
7.3.1 Layout Guidelines

To achieve the levels of high-frequency performance of the THS402x, follow proper printed-circuit board (PCB), high-frequency design techniques. The following is a general set of guidelines. In addition, a THS402x evaluation board is available to use as a guide for layout or for evaluating the device performance.

- **Ground planes**—make sure that the ground plane used on the board provides all components with a low-inductive ground connection. However, in the areas of the amplifier inputs and output, the ground plane can be removed to minimize stray capacitance.
- **Proper power-supply decoupling**—use a 6.8- μ F tantalum capacitor in parallel with a 0.1- μ F ceramic capacitor on each supply pin. Sharing the tantalum capacitor among several amplifiers is possible depending on the application, but always use a 0.1- μ F ceramic capacitor on the supply pin of every amplifier. In addition, place the 0.1- μ F capacitor as close as possible to the supply pin. As this distance increases, the inductance in the connecting trace makes the capacitor less effective. Strive for distances of less than 0.1 inch (2.54 mm) between the device power pins and the ceramic capacitors.
- **Short trace runs or compact part placements**—optimum high-frequency performance is achieved when stray series inductance has been minimized. To realize this, make the circuit layout as compact as possible, thereby minimizing the length of all trace runs. Pay particular attention to the inputs of the amplifier, keeping the trace lengths as short as possible. This layout helps to minimize stray capacitance at the input of the amplifier.

7.3.1.1 General PowerPAD™ Integrated Circuit Package Design Considerations

The THS402x is available in a thermally-enhanced DGN package, which is a member of the PowerPAD™ integrated circuit package family. 图 7-3 a and 图 7-3 b show that this package is constructed using a downset leadframe upon which the die is mounted. 图 7-3 c that this arrangement results in the leadframe being exposed as a thermal pad on the underside of the package. Because this thermal pad has direct thermal contact with the die, excellent thermal performance can be achieved by providing a good thermal path away from the thermal pad.

The PowerPAD integrated circuit package allows for both assembly and thermal management in one manufacturing operation. During the surface-mount solder operation (when the leads are being soldered), the thermal pad can also be soldered to a copper area underneath the package. Through the use of thermal paths within this copper area, heat can be conducted away from the package into either a ground plane or other heat dissipating device.

The PowerPAD integrated circuit package represents a breakthrough in combining the small area and ease of assembly of the surface mount with the previously awkward mechanical methods of heat sinking.

More complete details of the PowerPAD installation process and thermal management techniques are found in [PowerPAD Thermally-Enhanced Package](#). This document is found on the TI website (www.ti.com) by searching on the keyword PowerPAD. The document can also be ordered through your local TI sales office; refer to SLMA002 when ordering.

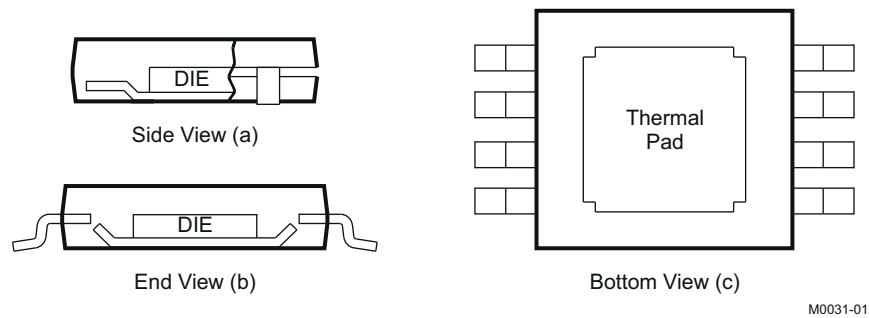

NOTE: The thermal pad (PowerPAD integrated circuit package) is electrically isolated from all other pins and can be connected to any potential from V_{CC-} to V_{CC+} . Typically, the thermal pad is connected to the ground plane because this plane tends to physically be the largest and is able to dissipate the most amount of heat.

图 7-3. Views of Thermally-enhanced DGN Package

7.3.2 Layout Example

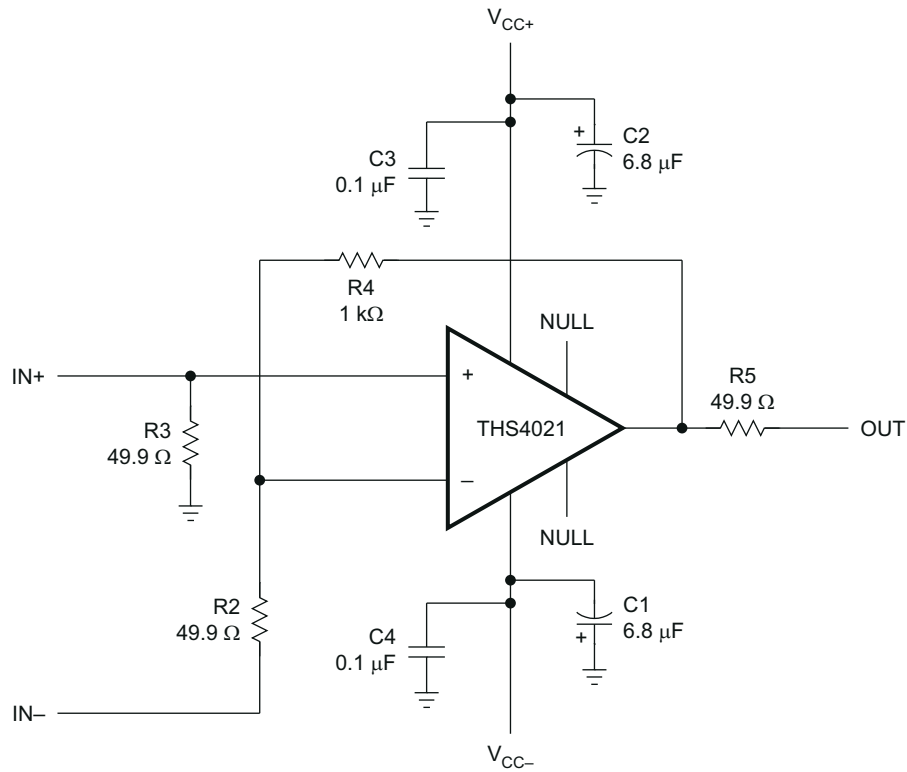

S0282-01



图 7-4. Layout Recommendations

8 Device and Documentation Support

TI offers an extensive line of development tools. Tools and software to evaluate the performance of the device, generate code, and develop solutions are listed below.

8.1 Documentation Support

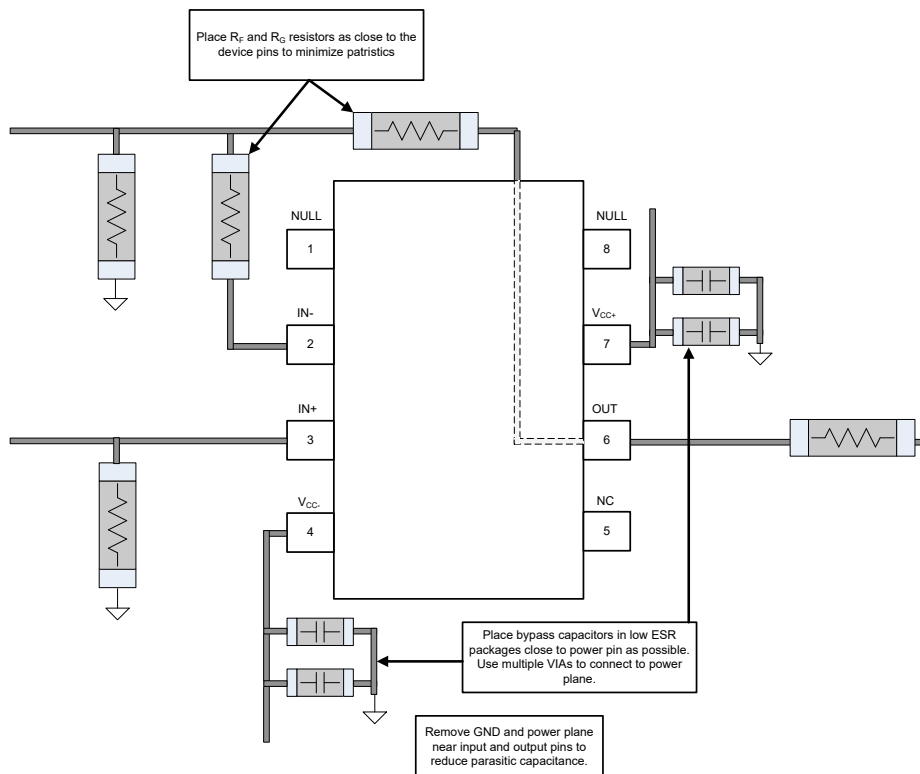
8.1.1 Related Documentation

For related documentation, see the following:

- Texas Instruments, [Noise Analysis in Operational Amplifier Circuits application report](#)
- Texas Instruments, [PowerPAD Thermally Enhanced Package application report](#)
- Texas Instruments, [THS4021 High-Speed Operational Amplifier Evaluation Module user's guide](#)
- Texas Instruments, [THS4022 Dual High-Speed Operational Amplifier Evaluation Module user's guide](#)

8.2 接收文档更新通知

要接收文档更新通知，请导航至 [ti.com](https://www.ti.com) 上的器件产品文件夹。点击 [通知](#) 进行注册，即可每周接收产品信息更改摘要。有关更改的详细信息，请查看任何已修订文档中包含的修订历史记录。

8.3 支持资源

[TI E2E™ 中文支持论坛](#) 是工程师的重要参考资料，可直接从专家处获得快速、经过验证的解答和设计帮助。搜索现有解答或提出自己的问题，获得所需的快速设计帮助。

链接的内容由各个贡献者“按原样”提供。这些内容并不构成 TI 技术规范，并且不一定反映 TI 的观点；请参阅 TI 的 [使用条款](#)。

8.4 Trademarks

PowerPAD™ and TI E2E™ are trademarks of Texas Instruments.

所有商标均为其各自所有者的财产。

8.5 静电放电警告



静电放电 (ESD) 会损坏这个集成电路。德州仪器 (TI) 建议通过适当的预防措施处理所有集成电路。如果不遵守正确的处理和安装程序，可能会损坏集成电路。

ESD 的损坏小至导致微小的性能降级，大至整个器件故障。精密的集成电路可能更容易受到损坏，这是因为非常细微的参数更改都可能会导致器件与其发布的规格不相符。

8.6 术语表

[TI 术语表](#) 本术语表列出并解释了术语、首字母缩略词和定义。

9 Revision History

注：以前版本的页码可能与当前版本的页码不同

| Changes from Revision E (March 2024) to Revision F (July 2024) | Page |
|---|-------------|
| • Deleted Total harmonic distortion + noise and Intermodulation distortion specifications from <i>Electrical Characteristics: THS4021D and THS4022DGN</i> | 6 |

| Changes from Revision D (May 2023) to Revision E (March 2024) | Page |
|--|-------------|
| • 从文档中删除了 THS4022 D 封装..... | 1 |
| • 更新了 <i>简化版应用</i> 图以显示正确的引脚名称..... | 1 |
| • 更新了 <i>说明</i> 中的闭环带宽和电源电流..... | 1 |
| • Updated <i>Thermal Information: THS4022</i> | 5 |

- Changed title of *Electrical Characteristics: THS4021 (D Package)* to *Electrical Characteristics: THS4021D and THS4022DGN* 6
 - Changed Channel-to-channel crosstalk from - 60 dB to - 54 dB in *Electrical Characteristics THS4021D and THS4022DGNB* 6
 - Changed title of *Electrical Characteristics: THS4021 (DGN Package) and THS4022 (D and DGN Packages)* to *Electrical Characteristics: THS4021DGN* 8
 - Changed title of *Typical Characteristics: THS4021 (D Package)* to *Typical Characteristics: THS4021D and THS4022DGN* 10
 - Changed V_{CC} from ± 5 V to ± 15 V in *Typical Characteristics: THS4021D and THS4022DGN* 10
 - Updated *Power-Supply Rejection Ratio vs Frequency* figure legend in *Typical Characteristics: THS4021D and THS4022DGN* 10
 - Changed title of *Typical Characteristics: THS4021 (DGN Package) and THS4022 (D and DGN Packages)* to *Typical Characteristics: THS4021DGN* 16
 - Updated *Crosstalk vs Frequency* figure and moved to *Typical Characteristics: THS4021D and THS4022DGN* 16
-

10 Mechanical, Packaging, and Orderable Information

The following pages include mechanical, packaging, and orderable information. This information is the most current data available for the designated devices. This data is subject to change without notice and revision of this document. For browser-based versions of this data sheet, refer to the left-hand navigation.

PACKAGING INFORMATION

| Orderable Device | Status (1) | Package Type | Package Drawing | Pins | Package Qty | Eco Plan (2) | Lead finish/ Ball material (6) | MSL Peak Temp (3) | Op Temp (°C) | Device Marking (4/5) | Samples |
|------------------|---------------|--------------|-----------------|------|-------------|-----------------|--------------------------------------|----------------------|--------------|-------------------------|-------------------------|
| THS4021CD | OBSOLETE | SOIC | D | 8 | | TBD | Call TI | Call TI | 0 to 70 | 4021C | |
| THS4021CDGN | ACTIVE | HVSSOP | DGN | 8 | 80 | RoHS & Green | NIPDAU | Level-1-260C-UNLIM | 0 to 70 | ACK | Samples |
| THS4021CDGNR | ACTIVE | HVSSOP | DGN | 8 | 2500 | RoHS & Green | NIPDAU | Level-1-260C-UNLIM | 0 to 70 | ACK | Samples |
| THS4021ID | OBSOLETE | SOIC | D | 8 | | TBD | Call TI | Call TI | -40 to 85 | 4021I | |
| THS4021IDGN | ACTIVE | HVSSOP | DGN | 8 | 80 | RoHS & Green | NIPDAU | Level-1-260C-UNLIM | -40 to 85 | ACL | Samples |
| THS4021IDGNR | ACTIVE | HVSSOP | DGN | 8 | 2500 | RoHS & Green | NIPDAU | Level-1-260C-UNLIM | -40 to 85 | ACL | Samples |
| THS4021IDR | ACTIVE | SOIC | D | 8 | 2500 | RoHS & Green | NIPDAU | Level-1-260C-UNLIM | -40 to 85 | 4021I | Samples |
| THS4022CD | ACTIVE | SOIC | D | 8 | 75 | RoHS & Green | NIPDAU | Level-1-260C-UNLIM | 0 to 70 | 4022C | Samples |
| THS4022ID | ACTIVE | SOIC | D | 8 | 75 | RoHS & Green | NIPDAU | Level-1-260C-UNLIM | -40 to 85 | 4022I | Samples |
| THS4022IDGNR | ACTIVE | HVSSOP | DGN | 8 | 2500 | RoHS & Green | NIPDAU | Level-2-260C-1 YEAR | -40 to 85 | ACB | Samples |

(1) The marketing status values are defined as follows:

ACTIVE: Product device recommended for new designs.

LIFEBUY: TI has announced that the device will be discontinued, and a lifetime-buy period is in effect.

NRND: Not recommended for new designs. Device is in production to support existing customers, but TI does not recommend using this part in a new design.

PREVIEW: Device has been announced but is not in production. Samples may or may not be available.

OBSOLETE: TI has discontinued the production of the device.

(2) **RoHS:** TI defines "RoHS" to mean semiconductor products that are compliant with the current EU RoHS requirements for all 10 RoHS substances, including the requirement that RoHS substance do not exceed 0.1% by weight in homogeneous materials. Where designed to be soldered at high temperatures, "RoHS" products are suitable for use in specified lead-free processes. TI may reference these types of products as "Pb-Free".

RoHS Exempt: TI defines "RoHS Exempt" to mean products that contain lead but are compliant with EU RoHS pursuant to a specific EU RoHS exemption.

Green: TI defines "Green" to mean the content of Chlorine (Cl) and Bromine (Br) based flame retardants meet JS709B low halogen requirements of <=1000ppm threshold. Antimony trioxide based flame retardants must also meet the <=1000ppm threshold requirement.

(3) MSL, Peak Temp. - The Moisture Sensitivity Level rating according to the JEDEC industry standard classifications, and peak solder temperature.

(4) There may be additional marking, which relates to the logo, the lot trace code information, or the environmental category on the device.

⁽⁵⁾ Multiple Device Markings will be inside parentheses. Only one Device Marking contained in parentheses and separated by a "~" will appear on a device. If a line is indented then it is a continuation of the previous line and the two combined represent the entire Device Marking for that device.

⁽⁶⁾ Lead finish/Ball material - Orderable Devices may have multiple material finish options. Finish options are separated by a vertical ruled line. Lead finish/Ball material values may wrap to two lines if the finish value exceeds the maximum column width.

Important Information and Disclaimer:The information provided on this page represents TI's knowledge and belief as of the date that it is provided. TI bases its knowledge and belief on information provided by third parties, and makes no representation or warranty as to the accuracy of such information. Efforts are underway to better integrate information from third parties. TI has taken and continues to take reasonable steps to provide representative and accurate information but may not have conducted destructive testing or chemical analysis on incoming materials and chemicals. TI and TI suppliers consider certain information to be proprietary, and thus CAS numbers and other limited information may not be available for release.

In no event shall TI's liability arising out of such information exceed the total purchase price of the TI part(s) at issue in this document sold by TI to Customer on an annual basis.

TAPE AND REEL INFORMATION

QUADRANT ASSIGNMENTS FOR PIN 1 ORIENTATION IN TAPE

*All dimensions are nominal

| Device | Package Type | Package Drawing | Pins | SPQ | Reel Diameter (mm) | Reel Width W1 (mm) | A0 (mm) | B0 (mm) | K0 (mm) | P1 (mm) | W (mm) | Pin1 Quadrant |
|--------------|--------------|-----------------|------|------|--------------------|--------------------|---------|---------|---------|---------|--------|---------------|
| THS4021CDGNR | HVSSOP | DGN | 8 | 2500 | 330.0 | 12.4 | 5.3 | 3.4 | 1.4 | 8.0 | 12.0 | Q1 |
| THS4021IDGNR | HVSSOP | DGN | 8 | 2500 | 330.0 | 12.4 | 5.3 | 3.4 | 1.4 | 8.0 | 12.0 | Q1 |
| THS4021IDR | SOIC | D | 8 | 2500 | 330.0 | 12.4 | 6.4 | 5.2 | 2.1 | 8.0 | 12.0 | Q1 |
| THS4021IDR | SOIC | D | 8 | 2500 | 330.0 | 12.4 | 6.4 | 5.2 | 2.1 | 8.0 | 12.0 | Q1 |
| THS4022IDGNR | HVSSOP | DGN | 8 | 2500 | 330.0 | 12.4 | 5.3 | 3.4 | 1.4 | 8.0 | 12.0 | Q1 |
| THS4022IDGNR | HVSSOP | DGN | 8 | 2500 | 330.0 | 12.4 | 5.3 | 3.4 | 1.4 | 8.0 | 12.0 | Q1 |

TAPE AND REEL BOX DIMENSIONS

*All dimensions are nominal

| Device | Package Type | Package Drawing | Pins | SPQ | Length (mm) | Width (mm) | Height (mm) |
|--------------|--------------|-----------------|------|------|-------------|------------|-------------|
| THS4021CDGNR | HVSSOP | DGN | 8 | 2500 | 358.0 | 335.0 | 35.0 |
| THS4021IDGNR | HVSSOP | DGN | 8 | 2500 | 358.0 | 335.0 | 35.0 |
| THS4021IDR | SOIC | D | 8 | 2500 | 350.0 | 350.0 | 43.0 |
| THS4021IDR | SOIC | D | 8 | 2500 | 356.0 | 356.0 | 35.0 |
| THS4022IDGNR | HVSSOP | DGN | 8 | 2500 | 353.0 | 353.0 | 32.0 |
| THS4022IDGNR | HVSSOP | DGN | 8 | 2500 | 350.0 | 350.0 | 43.0 |

TUBE

*All dimensions are nominal

| Device | Package Name | Package Type | Pins | SPQ | L (mm) | W (mm) | T (μm) | B (mm) |
|-----------|--------------|--------------|------|-----|--------|--------|--------|--------|
| THS4022CD | D | SOIC | 8 | 75 | 505.46 | 6.76 | 3810 | 4 |
| THS4022ID | D | SOIC | 8 | 75 | 505.46 | 6.76 | 3810 | 4 |

GENERIC PACKAGE VIEW

DGN 8

PowerPAD™ HVSSOP - 1.1 mm max height

3 x 3, 0.65 mm pitch

SMALL OUTLINE PACKAGE

This image is a representation of the package family, actual package may vary.
Refer to the product data sheet for package details.



4225482/B



4225481/A 11/2019

NOTES:

PowerPAD is a trademark of Texas Instruments.

1. All linear dimensions are in millimeters. Any dimensions in parenthesis are for reference only. Dimensioning and tolerancing per ASME Y14.5M.
2. This drawing is subject to change without notice.
3. This dimension does not include mold flash, protrusions, or gate burrs. Mold flash, protrusions, or gate burrs shall not exceed 0.15 mm per side.
4. This dimension does not include interlead flash. Interlead flash shall not exceed 0.25 mm per side.
5. Reference JEDEC registration MO-187.

EXAMPLE BOARD LAYOUT

DGN0008D

PowerPAD™ VSSOP - 1.1 mm max height

SMALL OUTLINE PACKAGE



LAND PATTERN EXAMPLE
EXPOSED METAL SHOWN
SCALE: 15X



SOLDER MASK DETAILS

4225481/A 11/2019

NOTES: (continued)

6. Publication IPC-7351 may have alternate designs.
7. Solder mask tolerances between and around signal pads can vary based on board fabrication site.
8. Vias are optional depending on application, refer to device data sheet. If any vias are implemented, refer to their locations shown on this view. It is recommended that vias under paste be filled, plugged or tented.
9. Size of metal pad may vary due to creepage requirement.

EXAMPLE STENCIL DESIGN

DGN0008D

PowerPAD™ VSSOP - 1.1 mm max height

SMALL OUTLINE PACKAGE



SOLDER PASTE EXAMPLE
EXPOSED PAD 9:
100% PRINTED SOLDER COVERAGE BY AREA
SCALE: 15X

| STENCIL THICKNESS | SOLDER STENCIL OPENING |
|-------------------|------------------------|
| 0.1 | 1.76 X 2.11 |
| 0.125 | 1.57 X 1.89 (SHOWN) |
| 0.15 | 1.43 X 1.73 |
| 0.175 | 1.33 X 1.60 |

4225481/A 11/2019

NOTES: (continued)

10. Laser cutting apertures with trapezoidal walls and rounded corners may offer better paste release. IPC-7525 may have alternate design recommendations.
11. Board assembly site may have different recommendations for stencil design.

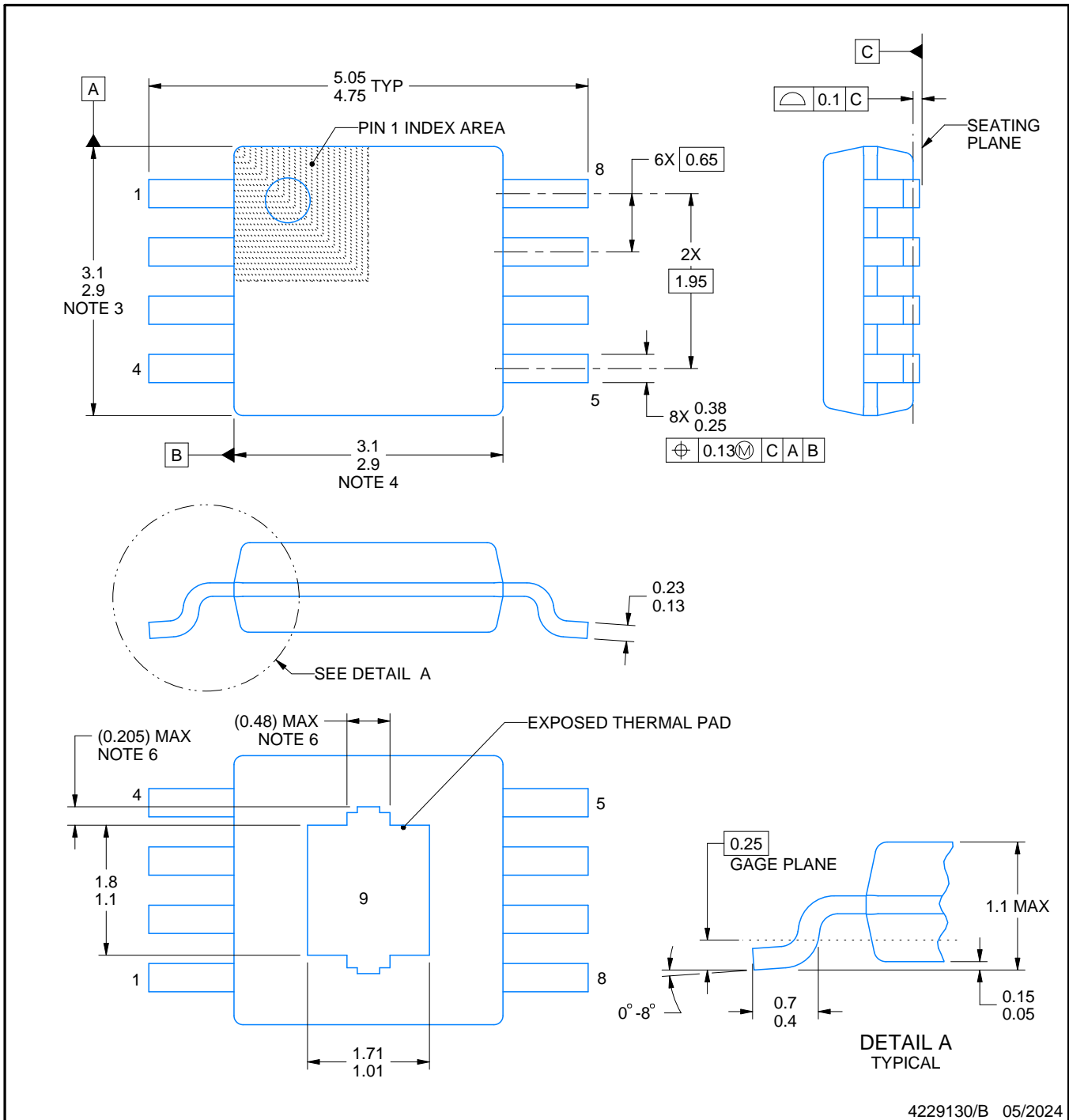

4229130/B 05/2024

NOTES:

PowerPAD is a trademark of Texas Instruments.

1. All linear dimensions are in millimeters. Any dimensions in parenthesis are for reference only. Dimensioning and tolerancing per ASME Y14.5M.
2. This drawing is subject to change without notice.
3. This dimension does not include mold flash, protrusions, or gate burrs. Mold flash, protrusions, or gate burrs shall not exceed 0.15 mm per side.
4. This dimension does not include interlead flash. Interlead flash shall not exceed 0.25 mm per side.
5. Reference JEDEC registration MO-187.
6. Features may differ or may not be present.

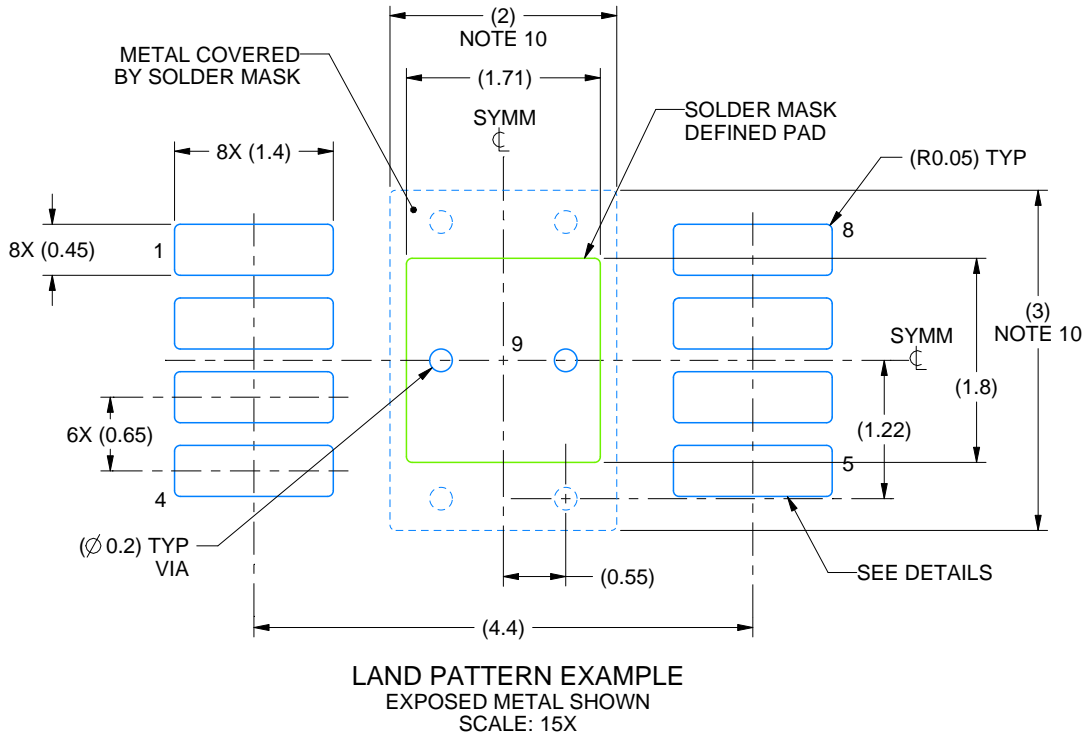

LAND PATTERN EXAMPLE
EXPOSED METAL SHOWN
SCALE: 15X

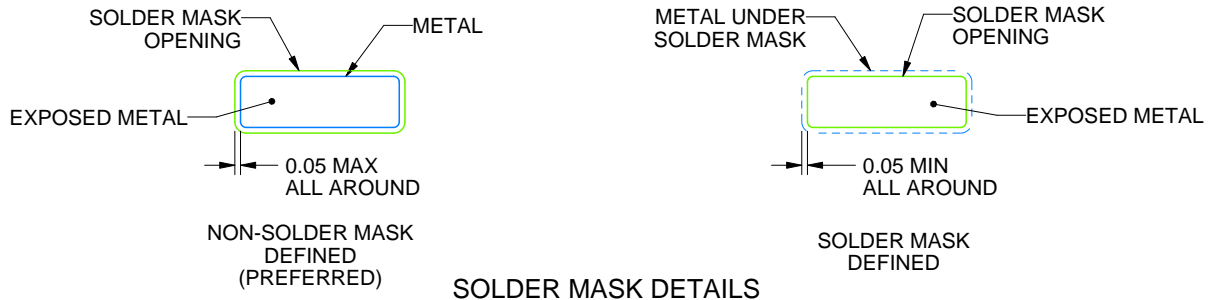

SOLDER MASK DETAILS

4229130/B 05/2024

NOTES: (continued)

- 7. Publication IPC-7351 may have alternate designs.
- 8. Solder mask tolerances between and around signal pads can vary based on board fabrication site.
- 9. Vias are optional depending on application, refer to device data sheet. If any vias are implemented, refer to their locations shown on this view. It is recommended that vias under paste be filled, plugged or tented.
- 10. Size of metal pad may vary due to creepage requirement.

EXAMPLE STENCIL DESIGN

DGN0008H

PowerPAD™ VSSOP - 1.1 mm max height

SMALL OUTLINE PACKAGE

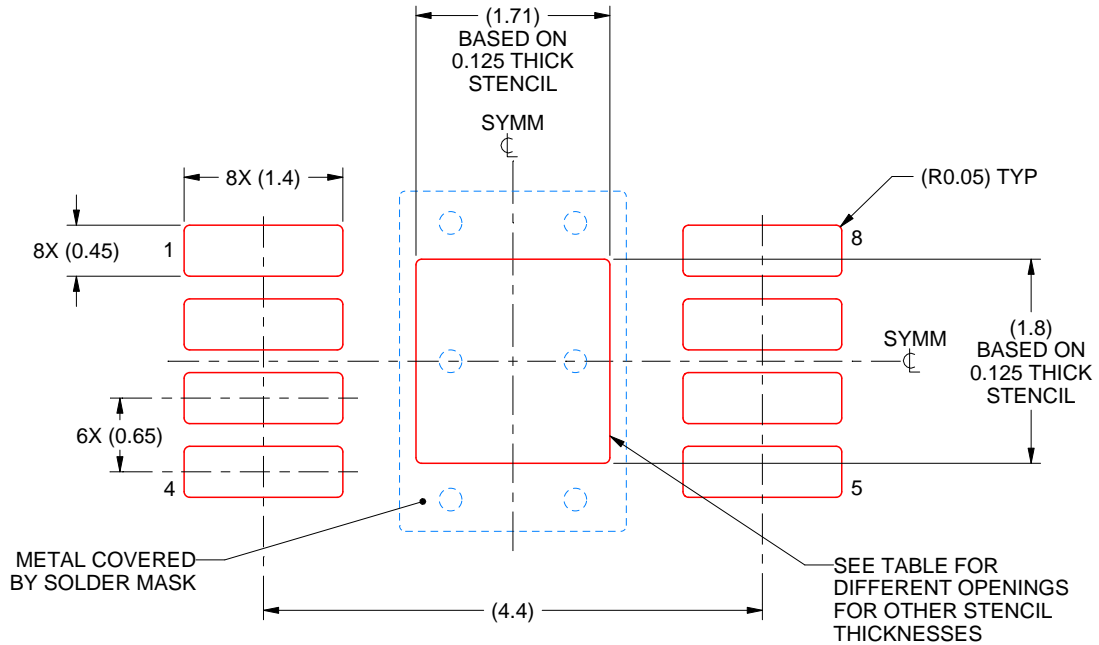

SOLDER PASTE EXAMPLE
EXPOSED PAD 9:
100% PRINTED SOLDER COVERAGE BY AREA
SCALE: 15X

| STENCIL THICKNESS | SOLDER STENCIL OPENING |
|-------------------|------------------------|
| 0.1 | 1.91 X 2.01 |
| 0.125 | 1.71 X 1.80 (SHOWN) |
| 0.15 | 1.56 X 1.64 |
| 0.175 | 1.45 X 1.52 |

4229130/B 05/2024

NOTES: (continued)

11. Laser cutting apertures with trapezoidal walls and rounded corners may offer better paste release. IPC-7525 may have alternate design recommendations.
12. Board assembly site may have different recommendations for stencil design.



D0008A

PACKAGE OUTLINE

SOIC - 1.75 mm max height

SMALL OUTLINE INTEGRATED CIRCUIT



NOTES:

1. Linear dimensions are in inches [millimeters]. Dimensions in parenthesis are for reference only. Controlling dimensions are in inches. Dimensioning and tolerancing per ASME Y14.5M.
2. This drawing is subject to change without notice.
3. This dimension does not include mold flash, protrusions, or gate burrs. Mold flash, protrusions, or gate burrs shall not exceed $.006$ [0.15] per side.
4. This dimension does not include interlead flash.
5. Reference JEDEC registration MS-012, variation AA.

EXAMPLE BOARD LAYOUT

D0008A

SOIC - 1.75 mm max height

SMALL OUTLINE INTEGRATED CIRCUIT



LAND PATTERN EXAMPLE
 EXPOSED METAL SHOWN
 SCALE:8X



SOLDER MASK DETAILS

4214825/C 02/2019

NOTES: (continued)

- 6. Publication IPC-7351 may have alternate designs.
- 7. Solder mask tolerances between and around signal pads can vary based on board fabrication site.

EXAMPLE STENCIL DESIGN

D0008A

SOIC - 1.75 mm max height

SMALL OUTLINE INTEGRATED CIRCUIT



SOLDER PASTE EXAMPLE
BASED ON .005 INCH [0.125 MM] THICK STENCIL
SCALE:8X

4214825/C 02/2019

NOTES: (continued)

8. Laser cutting apertures with trapezoidal walls and rounded corners may offer better paste release. IPC-7525 may have alternate design recommendations.
9. Board assembly site may have different recommendations for stencil design.

重要声明和免责声明

TI“按原样”提供技术和可靠性数据（包括数据表）、设计资源（包括参考设计）、应用或其他设计建议、网络工具、安全信息和其他资源，不保证没有瑕疵且不做任何明示或暗示的担保，包括但不限于对适销性、某特定用途方面的适用性或不侵犯任何第三方知识产权的暗示担保。

这些资源可供使用 TI 产品进行设计的熟练开发人员使用。您将自行承担以下全部责任：(1) 针对您的应用选择合适的 TI 产品，(2) 设计、验证并测试您的应用，(3) 确保您的应用满足相应标准以及任何其他功能安全、信息安全、监管或其他要求。

这些资源如有变更，恕不另行通知。TI 授权您仅可将这些资源用于研发本资源所述的 TI 产品的应用。严禁对这些资源进行其他复制或展示。您无权使用任何其他 TI 知识产权或任何第三方知识产权。您应全额赔偿因在这些资源的使用中对 TI 及其代表造成的任何索赔、损害、成本、损失和债务，TI 对此概不负责。

TI 提供的产品受 [TI 的销售条款](#) 或 [ti.com](#) 上其他适用条款/TI 产品随附的其他适用条款的约束。TI 提供这些资源并不会扩展或以其他方式更改 TI 针对 TI 产品发布的适用的担保或担保免责声明。

TI 反对并拒绝您可能提出的任何其他或不同的条款。

邮寄地址：Texas Instruments, Post Office Box 655303, Dallas, Texas 75265
Copyright © 2024，德州仪器 (TI) 公司