

## TL07xx 低噪声 FET 输入运算放大器

### 1 特性

- 高压摆率：20V/ $\mu$ s ( TL07xH, 典型值 )
- 低失调电压：1mV ( TL07xH, 典型值 )
- 低失调电压漂移：2  $\mu$ V/ $^{\circ}$ C
- 低功耗：940  $\mu$ A/通道 ( TL07xH, 典型值 )
- 宽共模和差分电压范围
  - 共模输入电压范围包括  $V_{CC+}$
- 低输入偏置和失调电流
- 低噪声：
  - $f = 1\text{kHz}$  时,  $V_n = 37\text{nV}/\sqrt{\text{Hz}}$  ( 典型值 )
- 输出短路保护
- 低总计谐波失真：0.003% ( 典型值 )
- 宽电源电压：
  - $\pm 2.25\text{V}$  至  $\pm 20\text{V}$ , 4.5V 至 40V

### 2 应用

- 太阳能：串式和中央逆变器
- 电机驱动器：交流和伺服驱动控制及功率级模块
- 单相在线式 UPS
- 三相 UPS
- 专业音频混合器
- 电池测试设备

### 3 说明

TL071H、TL072H 和 TL074H (TL07xH) 系列器件是业界通用的 TL071、TL072 和 TL074 (TL07x) 器件的下一代版本。这些器件为成本敏感型应用提供了卓越的价值，其特性包括低失调电压 ( 1mV, 典型值 )、高压摆率 (20V/ $\mu$ s) 和正电源的共模输入。

得益于高 ESD ( 1.5kV, HBM )、集成 EMI 和射频滤波器以及  $-40^{\circ}\text{C}$  至  $+125^{\circ}\text{C}$  的完整工作温度范围，TL07xH 器件可用于要求苛刻的应用。

#### 器件信息

器件型号 <sup>(1)</sup>	通道数	封装
TL071x	单通道	D ( SOIC , 8 )
		DBV ( SOT-23 , 5 )
		DCK ( SC70 , 5 )
		P ( PDIP , 8 )
		PS ( SO , 8 )
TL072x	双通道	D ( SOIC , 8 )
		DDF ( SOT-23-THIN , 8 )
		P ( PDIP , 8 )
		PW ( TSSOP , 8 )
TL072M <sup>(2)</sup>	双通道	FK ( LCCC , 20 )
		JG ( CDIP , 8 )
		U ( CFP , 10 )
TL074x	四通道	D ( SOIC , 14 )
		DB ( SSOP , 14 )
		DYY ( SOT-23-THIN , 14 )
		N ( PDIP , 14 )
		NS ( SOP , 14 )
TL074M <sup>(2)</sup>	四通道	PW ( TSSOP , 14 )
		FK ( LCCC , 20 )
		J ( CDIP , 14 )
		W ( CFP , 14 )

(1) 有关更多信息，请参阅节 11。

(2) 带有后缀 M 的器件具有更宽的工作温度范围： $-55^{\circ}\text{C}$  至  $+125^{\circ}\text{C}$ 。

TL071 for PS Package (SO, 8) Only

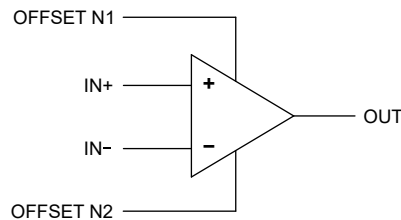

TL071 (Each Amplifier)  
TL072 (Each Amplifier)  
TL074 (Each Amplifier)

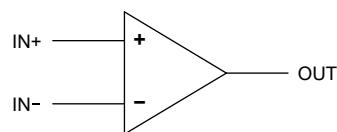

逻辑符号



## 内容

<b>1 特性</b> .....	<b>1</b>	<b>7 详细说明</b> .....	<b>30</b>
<b>2 应用</b> .....	<b>1</b>	7.1 概述.....	30
<b>3 说明</b> .....	<b>1</b>	7.2 功能方框图.....	30
<b>4 引脚配置和功能</b> .....	<b>3</b>	7.3 特性说明.....	30
<b>5 规格</b> .....	<b>10</b>	7.4 器件功能模式.....	30
5.1 绝对最大额定值.....	10	<b>8 应用和实现</b> .....	<b>31</b>
5.2 ESD 等级.....	10	8.1 应用信息.....	31
5.3 建议运行条件.....	11	8.2 典型应用.....	31
5.4 单通道器件的热性能信息.....	11	8.3 电源相关建议.....	33
5.5 双通道器件的热性能信息.....	11	8.4 布局.....	33
5.6 四通道器件的热性能信息.....	12	<b>9 器件和文档支持</b> .....	<b>35</b>
5.7 TL07xH 的电气特性.....	13	9.1 器件支持.....	35
5.8 TL07xC、TL07xAC、TL07xBC、TL07xI、 TL07xM 的电气特性 ( 直流 ) .....	16	9.2 接收文档更新通知.....	35
5.9 TL07xC、TL07xAC、TL07xBC、TL07xI、 TL07xM 的电气特性 ( 交流 ) .....	17	9.3 支持资源.....	35
5.10 典型特性：TL07xH.....	18	9.4 商标.....	35
5.11 典型特性：除 TL07xH 之外的所有器件.....	25	9.5 静电放电警告.....	35
<b>6 参数测量信息</b> .....	<b>29</b>	9.6 术语表.....	35
		<b>10 修订历史记录</b> .....	<b>35</b>
		<b>11 机械、封装和可订购信息</b> .....	<b>36</b>

## 4 引脚配置和功能



图 4-1. TL071H DBV 封装，5 引脚 SOT-23  
(顶视图)



图 4-2. TL071H DCK 封装，5 引脚 SC70  
(顶视图)

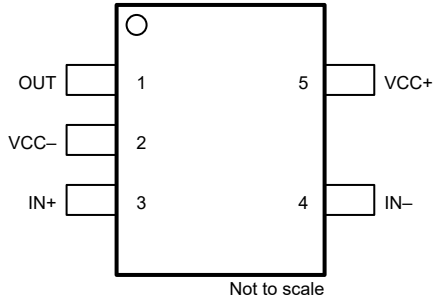

图 4-3. TL071x D 封装，8 引脚 SOIC  
和 P 封装，8 引脚 PDIP  
(顶视图)

表 4-1. 引脚功能：TL071x

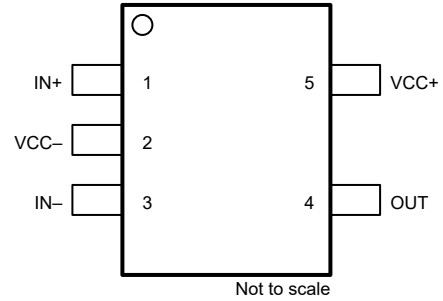
名称	引脚				类型	说明
	DBV (SOT-23)	DCK (SC70)	D (SOIC)	P (PDIP)		
IN -	4	3	2	2	输入	反相输入
IN+	3	1	3	3	输入	同相输入
NC	—	—	8	8	—	不连接
NC	—	—	1	1	—	不连接
NC	—	—	5	5	—	不连接
OUT	1	4	6	6	输出	输出
VCC -	2	2	4	4	—	电源
VCC+	5	5	7	7	—	电源

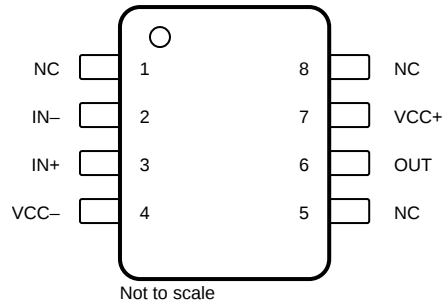

图 4-4. TL071C PS 封装，8 引脚 SO  
 ( 顶视图 )

表 4-2. 引脚功能：TL071C

引脚		类型	说明
名称	编号		
IN -	2	输入	反相输入
IN+	3	输入	同相输入
NC	8	—	不连接
OFFSET N1	1	—	输入偏移调整
OFFSET N2	5	—	输入偏移调整
OUT	6	输出	输出
VCC -	4	—	电源
VCC+	7	—	电源



图 4-5. TL072x D、DDF、JG、P、PS 和 PW 封装，  
 8 引脚 SOIC、SOT-23-THIN、CDIP、PDIP、SO 和 TSSOP  
 ( 顶视图 )

表 4-3. 引脚功能 : TL072x

引脚		类型	说明
名称	编号		
1IN -	2	输入	反相输入
1IN+	3	输入	同相输入
1OUT	1	输出	输出
2IN -	6	输入	反相输入
2IN+	5	输入	同相输入
2OUT	7	输出	输出
VCC -	4	—	电源
VCC+	8	—	电源

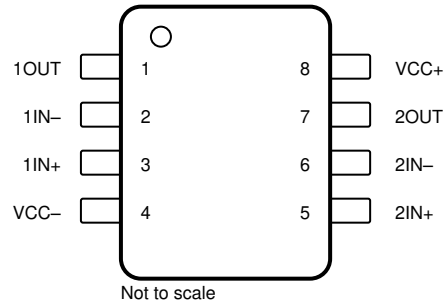

图 4-6. TL072M U 封装，10 引脚 CFP  
(顶视图)

表 4-4. 引脚功能：TL072M

引脚		类型	说明
名称	编号		
1IN -	3	输入	反相输入
1IN+	4	输入	同相输入
1OUT	2	输出	输出
2IN -	7	输入	反相输入
2IN+	6	输入	同相输入
2OUT	8	输出	输出
NC	1、10	—	不连接
VCC -	5	—	电源
VCC+	9	—	电源

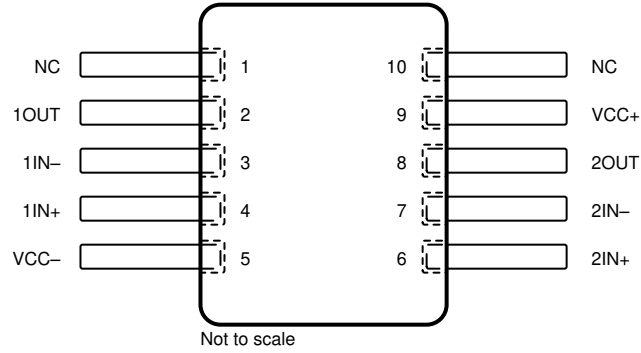

图 4-7. TL072M FK 封装，20 引脚 LCCC  
(顶视图)

表 4-5. 引脚功能：TL072M

引脚		类型	说明
名称	编号		
1IN -	5	输入	反相输入
1IN+	7	输入	同相输入
1OUT	2	输出	输出
2IN -	15	输入	反相输入
2IN+	12	输入	同相输入
2OUT	17	输出	输出
NC	1、3、4、6、 8、9、11、 13、14、16、 18、19	—	不连接
VCC -	10	—	电源
VCC+	20	—	电源



图 4-8. TL074x D、DYY、J、N、NS、PW 和 W 封装，  
 14 引脚 SOIC、SOT-23-THIN、CDIP、PDIP、SOP、TSSOP 和 CFP  
 (顶视图)

表 4-6. 引脚功能：TL074x

引脚		类型	说明
名称	编号		
1IN -	2	输入	反相输入
1IN+	3	输入	同相输入
1OUT	1	输出	输出
2IN -	6	输入	反相输入
2IN+	5	输入	同相输入
2OUT	7	输出	输出
3IN -	9	输入	反相输入
3IN+	10	输入	同相输入
3OUT	8	输出	输出
4IN -	13	输入	反相输入
4IN+	12	输入	同相输入
4OUT	14	输出	输出
VCC -	11	—	电源
VCC+	4	—	电源

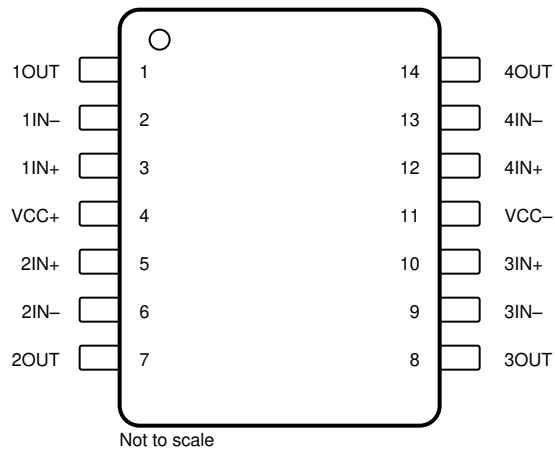

图 4-9. TL074M FK 封装，20 引脚 LCCC  
(顶视图)

表 4-7. 引脚功能：TL074M

引脚		类型	说明
名称	编号		
1IN -	3	输入	反相输入
1IN+	4	输入	同相输入
1OUT	2	输出	输出
2IN -	9	输入	反相输入
2IN+	8	输入	同相输入
2OUT	10	输出	输出
3IN -	13	输入	反相输入
3IN+	14	输入	同相输入
3OUT	12	输出	输出
4IN -	19	输入	反相输入
4IN+	18	输入	同相输入
4OUT	20	输出	输出
NC	1、5、7、 11、15、17	—	不连接
VCC -	16	—	电源
VCC+	6	—	电源

## 5 规格

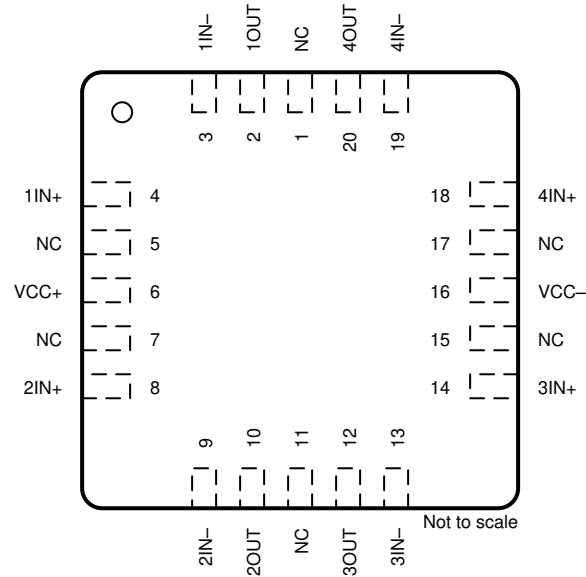
### 备注

TLV07xx 系列已将新裸片制造过渡到一种现代工艺。

此新裸片采用 H 后缀。

带有不同后缀的裸片要么较旧、要么较新；另请参阅 节 9.1.1。

节 5.7 和 节 5.10 描述了新裸片的性能。

节 5.8、节 5.9 和 节 5.11 描述了旧裸片的性能。

### 5.1 绝对最大额定值

在工作环境温度范围内测得 (除非另有说明) <sup>(1)</sup>

			最小值	最大值	单位
电源电压, $V_S = (V+) - (V-)$	所有 NS 和 PS 封装; 所有 TL07xM 器件		-0.3	36	V
	所有其他器件		0	42	
信号输入引脚	共模电压 <sup>(2)</sup>	所有 NS 和 PS 封装; 所有 TL07xM 器件	$(V_{CC-}) - 0.3$	$(V_{CC-}) + 36$	V
		所有其他器件	$(V_{CC-}) - 0.5$	$(V_{CC+}) + 0.5$	
	差分电压 <sup>(2)</sup>	所有 NS 和 PS 封装; 所有 TL07xM 器件 <sup>(3)</sup>	$(V_{CC-}) - 0.3$	$(V_{CC-}) + 36$	V
		所有其他器件		$V_S + 0.2$	
电流 <sup>(2)</sup>	所有 NS 和 PS 封装; 所有 TL07xM 器件			50	mA
	所有其他器件			10	
输出短路 <sup>(4)</sup>			持续		
工作环境温度, $T_A$			-55	150	°C
结温, $T_J$				150	°C
60 秒内的管壳温度 - FK 封装				260	°C
10 秒内距离外壳 1.8mm ( 1/16 英寸 ) 的引线温度				300	°C
贮存温度, $T_{stg}$			-65	150	°C

- 应力超出绝对最大额定值下面列出的值时可能会对器件造成永久损坏。这些列出的值仅仅是应力等级, 并不表示器件在这些条件下以及在建议工作条件以外的任何其他条件下能够正常运行。长时间处于绝对最大额定条件下可能会影响器件的可靠性。
- 在所有新裸片上, 输入引脚均被二极管钳制至两个电源轨。对于摆幅超过电源导轨 0.5V 的输入信号, 应将其电流限制在 10mA 或者更低。
- 差动电压仅受输入电压限制。
- 接地短路, 每个封装对应一个放大器。

### 5.2 ESD 等级

			值	单位
$V_{(ESD)}$	静电放电	人体放电模型 (HBM), 符合 ANSI/ESDA/JEDEC JS-001 标准 <sup>(1)</sup>	±2000	V
		充电器件模型 (CDM), 符合 JEDEC 规范 JESD22-C101 <sup>(2)</sup>	±1000	

- JEDEC 文档 JEP155 指出: 500V HBM 可通过标准 ESD 控制流程实现安全生产。
- JEDEC 文档 JEP157 指出: 250V CDM 能够在标准 ESD 控制流程下安全生产。

### 5.3 建议运行条件

在工作环境温度范围内测得（除非另有说明）

			最小值	最大值	单位
V <sub>S</sub>	电源电压, (V <sub>CC+</sub> ) - (V <sub>CC-</sub> )	所有 NS 和 PS 封装; 所有 TL07xM 器件 <sup>(1)</sup>	10	30	V
		所有其他器件	4.5	40	
V <sub>I</sub>	输入电压	所有 NS 和 PS 封装; 所有 TL07xM 器件	(V <sub>CC-</sub> ) + 2	(V <sub>CC+</sub> ) + 0.1	V
		所有其他器件	(V <sub>CC-</sub> ) + 4	(V <sub>CC+</sub> ) + 0.1	
T <sub>A</sub>	额定温度 <sup>(2)</sup>	TL07xM	-55	125	°C
		TL07xH	-40	125	
		TL07xI	-40	85	
		TL07xC	0	70	

- (1) V<sub>CC+</sub> 和 V<sub>CC-</sub> 不要求具有相同的幅度，只要总 V<sub>S</sub> (V<sub>CC+</sub> - V<sub>CC-</sub>) 介于 10V 与 30V 之间即可。  
 (2) 另请参阅节 9.1.1。

### 5.4 单通道器件的热性能信息

热指标 <sup>(1)</sup>		TL071xx					单位
		D (SOIC)	DCK (SC70)	DBV (SOT-23)	P (PDIP)	PS (SO)	
		8 引脚	5 引脚	5 引脚	8 引脚	8 引脚	
R <sub>θJA</sub>	结至环境热阻	158.8	217.5	212.2	85	95	°C/W
R <sub>θJC(top)</sub>	结至外壳 (顶部) 热阻	98.6	113.1	111.1	-	-	°C/W
R <sub>θJB</sub>	结至电路板热阻	102.3	63.8	79.4	-	-	°C/W
ψ <sub>JT</sub>	结至顶部特征参数	45.8	34.8	51.8	-	-	°C/W
ψ <sub>JB</sub>	结至电路板特征参数	101.5	63.5	79.0	-	-	°C/W
R <sub>θJC(bot)</sub>	结至外壳 (底部) 热阻	不适用	不适用	不适用	不适用	不适用	°C/W

- (1) 有关新旧热指标的信息，请参阅 [半导体和 IC 封装热指标](#) 应用报告。

### 5.5 双通道器件的热性能信息

热指标 <sup>(1)</sup>		TL072xx								单位
		D (SOIC)	DDF (SOT-23)	FK (LCCC)	JG (CDIP)	P (PDIP)	PS (SO)	PW (TSSOP)	U (CFP)	
		8 引脚	8 引脚	20 引脚	8 引脚	8 引脚	8 引脚	8 引脚	10 引脚	
R <sub>θJA</sub>	结至环境热阻	147.8	181.5	-	-	85	95	200.3	169.8	°C/W
R <sub>θJC(top)</sub>	结至外壳 (顶部) 热阻	88.2	112.5	5.61	15.05	-	-	89.4	62.1	°C/W
R <sub>θJB</sub>	结至电路板热阻	91.4	98.2	-	-	-	-	131.0	176.2	°C/W
ψ <sub>JT</sub>	结至顶部特征参数	36.8	17.2	-	-	-	-	22.2	48.4	°C/W
ψ <sub>JB</sub>	结至电路板特征参数	90.6	97.6	-	-	-	-	129.3	144.1	°C/W
R <sub>θJC(bot)</sub>	结至外壳 (底部) 热阻	不适用	不适用	-	-	-	-	不适用	5.4	°C/W

- (1) 有关新旧热指标的信息，请参阅 [半导体和 IC 封装热指标](#) 应用报告。

## 5.6 四通道器件的热性能信息

热指标 <sup>(1)</sup>		TL074xx								单位
		D (SOIC)	DYY (SOT-23)	FK (TSSOP)	J (TSSOP)	N (TSSOP)	NS (TSSOP)	PW (TSSOP)	W (TSSOP)	
		14 引脚	14 引脚	20 引脚	14 引脚	14 引脚	14 引脚	14 引脚	14 引脚	
R <sub>θJA</sub>	结至环境热阻	114.2	153.2	-	-	80	76	-	128.8	°C/W
R <sub>θJC(top)</sub>	结至外壳 ( 顶部 ) 热阻	70.3	88.7	5.61	14.5	-	-	14.5	56.1	°C/W
R <sub>θJB</sub>	结至电路板热阻	70.2	65.4	-	-	-	-	-	127.6	°C/W
ψ <sub>JT</sub>	结至顶部特征参数	28.8	9.5	-	-	-	-	-	29	°C/W
ψ <sub>JB</sub>	结至电路板特征参数	69.8	65.0	-	-	-	-	-	106.1	°C/W
R <sub>θJC(bot)</sub>	结至外壳 ( 底部 ) 热阻	不适用	不适用	-	-	-	-	-	0.5	°C/W

(1) 有关新旧热指标的信息，请参阅 [半导体和 IC 封装热指标](#) 应用报告。

## 5.7 TL07xH 的电气特性

$V_S = (V_{CC+}) - (V_{CC-}) = 4.5V$  至  $40V$  ( $\pm 2.25V$  至  $\pm 20V$ ) ,  $T_A = 25^\circ C$  ,  $R_L = 10k\Omega$  连接至  $V_S / 2$  ,  $V_{CM} = V_S / 2$  , 且  $V_{OUT} = V_S / 2$  (除非另有说明)

参数		测试条件		最小值	典型值	最大值	单位
<b>失调电压</b>							
$V_{OS}$	输入失调电压				$\pm 1$	$\pm 4$	mV
				$T_A = -40^\circ C$ 至 $+125^\circ C$		$\pm 5$	
$dV_{OS}/dT$	输入失调电压漂移			$T_A = -40^\circ C$ 至 $+125^\circ C$	$\pm 2$		$\mu V/^\circ C$
PSRR	输入失调电压与电源间的关系	$V_S = 5V$ 至 $40V$ , $V_{CM} = V_S / 2$	$T_A = -40^\circ C$ 至 $+125^\circ C$		$\pm 1$	$\pm 10$	$\mu V/V$
				通道隔离	$f = 0Hz$		10
<b>输入偏置电流</b>							
$I_B$	输入偏置电流				$\pm 1$	$\pm 120$	pA
				DCK 和 DBV 封装	$\pm 1$	$\pm 300$	pA
				$T_A = -40^\circ C$ 至 $+125^\circ C^{(1)}$		$\pm 5$	nA
$I_{OS}$	输入失调电流				$\pm 0.5$	$\pm 120$	pA
				DCK 和 DBV 封装	$\pm 0.5$	$\pm 250$	pA
				$T_A = -40^\circ C$ 至 $+125^\circ C^{(1)}$		$\pm 5$	nA
<b>噪声</b>							
$E_N$	输入电压噪声	$f = 0.1Hz$ 至 $10Hz$			9.2		$\mu V_{PP}$
					1.4		$\mu V_{RMS}$
$e_N$	输入电压噪声密度	$f = 1kHz$			37		$nV/\sqrt{Hz}$
		$f = 10kHz$			21		
$i_N$	输入电流噪声	$f = 1kHz$			80		$fA/\sqrt{Hz}$
<b>输入电压范围</b>							
$V_{CM}$	共模电压			$(V_{CC-}) + 1.5$		$(V_{CC+})$	V
CMRR	共模抑制比	$V_S = 40V$ , $(V_{CC-}) + 2.5V < V_{CM} < (V_{CC+}) - 1.5V$			100	105	dB
			$T_A = -40^\circ C$ 至 $+125^\circ C$		95		dB
		$V_S = 40V$ , $(V_{CC-}) + 2.5V < V_{CM} < (V_{CC+})$			90	105	dB
			$T_A = -40^\circ C$ 至 $+125^\circ C$		80		dB
<b>输入电容</b>							
$Z_{ID}$	差分				$100 \parallel 2$		$M\Omega \parallel pF$
$Z_{ICM}$	共模				$6 \parallel 1$		$T\Omega \parallel pF$
<b>开环增益</b>							
$A_{OL}$	开环电压增益	$V_S = 40V$ , $V_{CM} = V_S / 2$ , $(V_{CC-}) + 0.3V < V_O < (V_{CC+}) - 0.3V$	$T_A = -40^\circ C$ 至 $+125^\circ C$	118	125		dB
$A_{OL}$	开环电压增益	$V_S = 40V$ , $V_{CM} = V_S / 2$ , $R_L = 2k\Omega$ , $(V_{CC-}) + 1.2V < V_O < (V_{CC+}) - 1.2V$	$T_A = -40^\circ C$ 至 $+125^\circ C$	115	120		dB
<b>频率响应</b>							
GBW	增益带宽积				5.25		MHz
SR	压摆率	$V_S = 40V$ , $G = +1$ , $C_L = 20pF$			20		$V/\mu s$
$t_s$	稳定时间	精度达到 0.1% , $V_S = 40V$ , $V_{STEP} = 10V$ , $G = +1$ , $C_L = 20pF$			0.63		$\mu s$
		精度达到 0.1% , $V_S = 40V$ , $V_{STEP} = 2V$ , $G = +1$ , $C_L = 20pF$			0.56		
		精度达到 0.01% , $V_S = 40V$ , $V_{STEP} = 10V$ , $G = +1$ , $C_L = 20pF$			0.91		
		精度达到 0.01% , $V_S = 40V$ , $V_{STEP} = 2V$ , $G = +1$ , $C_L = 20pF$			0.48		

## 5.7 TL07xH 的电气特性 (续)

$V_S = (V_{CC+}) - (V_{CC-}) = 4.5V$  至  $40V$  ( $\pm 2.25V$  至  $\pm 20V$ ) ,  $T_A = 25^\circ C$  ,  $R_L = 10k\Omega$  连接至  $V_S / 2$  ,  $V_{CM} = V_S / 2$  , 且  $V_{OUT} = V_S / 2$  (除非另有说明)

参数		测试条件	最小值	典型值	最大值	单位
	相位裕度	$G = +1$ , $R_L = 10k\Omega$ , $C_L = 20pF$		56		°
	过载恢复时间	$V_{IN} \times \text{增益} > V_S$		300		ns
THD+N	总谐波失真 + 噪声	$V_S = 40V$ , $V_O = 6V_{RMS}$ , $G = +1$ , $f = 1kHz$		0.00012		%
EMIRR	EMI 抑制比	$f = 1GHz$		53		dB

## 5.7 TL07xH 的电气特性 (续)

$V_S = (V_{CC+}) - (V_{CC-}) = 4.5V$  至  $40V$  ( $\pm 2.25V$  至  $\pm 20V$ ) ,  $T_A = 25^\circ C$  ,  $R_L = 10k\Omega$  连接至  $V_S / 2$  ,  $V_{CM} = V_S / 2$  , 且  $V_{OUT} = V_S / 2$  (除非另有说明)

参数		测试条件		最小值	典型值	最大值	单位	
<b>输出</b>								
	相对于电源轨的电压输出摆幅	正电源轨余量	$V_S = 40V, R_L = 10k\Omega$		115	210	mV	
			$V_S = 40V, R_L = 2k\Omega$		520	965		
		负电源轨余量	$V_S = 40V, R_L = 10k\Omega$		105	215		
			$V_S = 40V, R_L = 2k\Omega$		500	1030		
$I_{SC}$	短路电流				$\pm 26$		mA	
$C_{LOAD}$	容性负载驱动				300		pF	
$Z_O$	开环输出阻抗	$f = 1MHz, I_O = 0A$			125		$\Omega$	
<b>电源</b>								
$I_Q$	每个放大器的静态电流	$I_O = 0A$	$T_A = -40^\circ C$ 至 $+125^\circ C$			937.5	1125	$\mu A$
					$I_O = 0A, (TL071H)$		960	
		$I_O = 0A$					1130	
		$I_O = 0A, (TL072H)$					1143	
		$I_O = 0A, (TL071H)$					1160	
	导通时间	$T_A = 25^\circ C, V_S = 40V, V_S$ 升降速率 $> 0.3V/\mu s$			60		$\mu s$	

(1) 根据表征结果指定最大  $I_B$  和  $I_{OS}$  数据。

### 5.8 TL07xC、TL07xAC、TL07xBC、TL07xI、TL07xM 的电气特性 ( 直流 )

$V_S = (V_{CC+}) - (V_{CC-}) = \pm 15V$ ,  $T_A = 25^\circ C$  时 ( 除非另有说明 )

参数		测试条件 <sup>(1) (2)</sup>		最小值	典型值	最大值	单位	
<b>DC</b>								
$V_{OS}$	输入失调电压	$V_O = 0V$ $R_S = 50 \Omega$	TL07xC			3	10	mV
				$T_A = \text{完整范围}$				
			TL07xAC			3	6	
				$T_A = \text{完整范围}$				
			TL07xBC			2	3	
				$T_A = \text{完整范围}$				
			TL07xI			3	6	
$T_A = \text{完整范围}$					8			
TL071M、TL072M			3	6				
	$T_A = \text{完整范围}$				9			
TL074M			3	9				
	$T_A = \text{完整范围}$				15			
$dV_{OS}/dT$	输入失调电压漂移	$V_O = 0V$ , $R_S = 50 \Omega$	$T_A = \text{完整范围}$		$\pm 18$		$\mu V/^\circ C$	
$I_{OS}$	输入失调电流	$V_O = 0V$	TL07xC		5	100	pA	
				$T_A = \text{完整范围}$				10
			TL07xAC、TL07xBC、 TL07xI		5	100	pA	
			TL07xM		5	100	pA	
				$T_A = \text{完整范围}$				20
$I_B$	输入偏置电流	$V_O = 0V$	TL07xC、TL07xAC、 TL07xBC、TL07xI		65	200	pA	
				$T_A = \text{完整范围}$				7
			TL071M、TL072M		65	200	pA	
				$T_A = \text{完整范围}$				50
TL074M		65	200	pA				
	$T_A = \text{完整范围}$				20	nA		
$V_{CM}$	共模电压			$\pm 11$	-12 至 15		V	
$V_{OM}$	最大峰值输出电压摆幅	$R_L = 10k \Omega$	$T_A = \text{完整范围}$		$\pm 12$	$\pm 13.5$	V	
		$R_L \geq 10k \Omega$			$\pm 12$			
		$R_L \geq 2k \Omega$			$\pm 10$			
$A_{OL}$	开环电压增益	$V_O = 0V$	TL07xC		25	200	V/mV	
				$T_A = \text{完整范围}$				
			TL07xAC、TL07xBC、 TL07xI		50	200		
				$T_A = \text{完整范围}$				
TL07xM		35	200					
	$T_A = \text{完整范围}$				15			
GBW	增益带宽积	所有 NS 和 PS 封装；所有 TL07xM 器件			3		MHz	
		所有其他器件			5.25			
$R_{ID}$	共模输入电阻				1		$T \Omega$	
CMRR	共模抑制比	$V_{IC} = V_{ICR(min)}$ $V_O = 0V$ $R_S = 50 \Omega$	TL07xC		70	100	dB	
			TL07xAC、TL07xBC、 TL07xI		75	100		
			TL07xM		80	86		
PSRR	输入失调电压与电源间的关系	$V_S = \pm 9V \text{ 至 } \pm 18V$ $V_O = 0V$ $R_S = 50 \Omega$	TL07xC		70	100	dB	
			TL07xAC、TL07xBC、 TL07xI		80	100		
			TL07xM		80	86		

## 5.8 TL07xC、TL07xAC、TL07xBC、TL07xI、TL07xM 的电气特性 ( 直流 ) ( 续 )

$V_S = (V_{CC+}) - (V_{CC-}) = \pm 15V$  ,  $T_A = 25^\circ C$  时 ( 除非另有说明 )

参数		测试条件 <sup>(1) (2)</sup>	最小值	典型值	最大值	单位
$I_Q$	每个放大器的静态电流	$V_O = 0V$ , 空载		1.4	2.5	mA
	通道隔离	$f = 0Hz$		1		$\mu V/V$

(1) 除非另有说明, 否则所有特性均在开环条件下以零共模电压测定。

(2) 对于 TL07xC、TL07xAC 和 TL07xBC, 完整范围为  $T_A = 0^\circ C$  至  $70^\circ C$  ; 对于 TL07xI,  $T_A = -40^\circ C$  至  $+85^\circ C$  ; 对于 TL07xM,  $T_A = -55^\circ C$  至  $+125^\circ C$ 。

## 5.9 TL07xC、TL07xAC、TL07xBC、TL07xI、TL07xM 的电气特性 ( 交流 )

$V_S = (V_{CC+}) - (V_{CC-}) = \pm 15V$  ,  $T_A = 25^\circ C$  时 ( 除非另有说明 )

参数		测试条件		最小值	典型值	最大值	单位	
<b>AC</b>								
SR	压摆率	$V_I = 10V$ , $C_L = 100pF$ , $R_L = 2k\Omega$	TL07xM	5	20		$V/\mu s$	
			TL07xC、TL07xAC、 TL07xBC、TL07xI	8	20		$V/\mu s$	
$t_S$	稳定时间	$V_I = 20V$ , $C_L = 100pF$ , $R_L = 2k\Omega$			0.1		$\mu s$	
					20%			
$e_N$	输入电压噪声密度	所有 PS 和 NS 封装 , 所有 TL07xM 器件	$R_S = 20\Omega$ , $f = 1kHz$		18		$nV/\sqrt{Hz}$	
			所有其他器件	$f = 1kHz$		37		$nV/\sqrt{Hz}$
				$f = 10kHz$		21		
$E_N$	输入电压噪声	所有 PS 和 NS 封装 , 所有 TL07xM 器件	$R_S = 20\Omega$ , $f = 10Hz$ 至 $10kHz$		4		$\mu V_{RMS}$	
			所有其他器件	$f = 0.1Hz$ 至 $10Hz$		1.4		$\mu V_{RMS}$
$i_N$	输入电流噪声	$R_S = 20\Omega$ , $f = 1kHz$			10		$fA/\sqrt{Hz}$	
	相位裕度	TL07xC、TL07xAC、 TL07xBC、TL07xI	$G = +1$ , $R_L = 10k\Omega$ , $C_L = 20pF$		56		°	
	过载恢复时间	$V_{IN} \times \text{增益} > V_S$			300		ns	
THD+N	总谐波失真 + 噪声	所有 PS 和 NS 封装 , 所有 TL07xM 器件	$V_O = 6V_{RMS}$ , $R_L \geq 2k\Omega$ , $f = 1kHz$ , $G = +1$ , $R_S \leq 1k\Omega$		0.003		%	
			所有其他器件	$V_S = 40V$ , $V_O = 6V_{RMS}$ , $G = +1$ , $f = 1kHz$		0.00012		%
EMIRR	EMI 抑制比	TL07xC、TL07xAC、 TL07xBC、TL07xI	$f = 1GHz$		53		dB	
$Z_O$	开环输出阻抗	TL07xC、TL07xAC、 TL07xBC、TL07xI	$f = 1MHz$ , $I_O = 0A$		125		$\Omega$	

## 5.10 典型特性：TL07xH

$T_A = 25^\circ\text{C}$ ,  $V_S = 40\text{V} (\pm 20\text{V})$ ,  $V_{CM} = V_S/2$ ,  $R_{LOAD} = 10\text{k}\Omega$  连接至  $V_S/2$ , 且  $C_L = 20\text{pF}$  (除非另外说明)

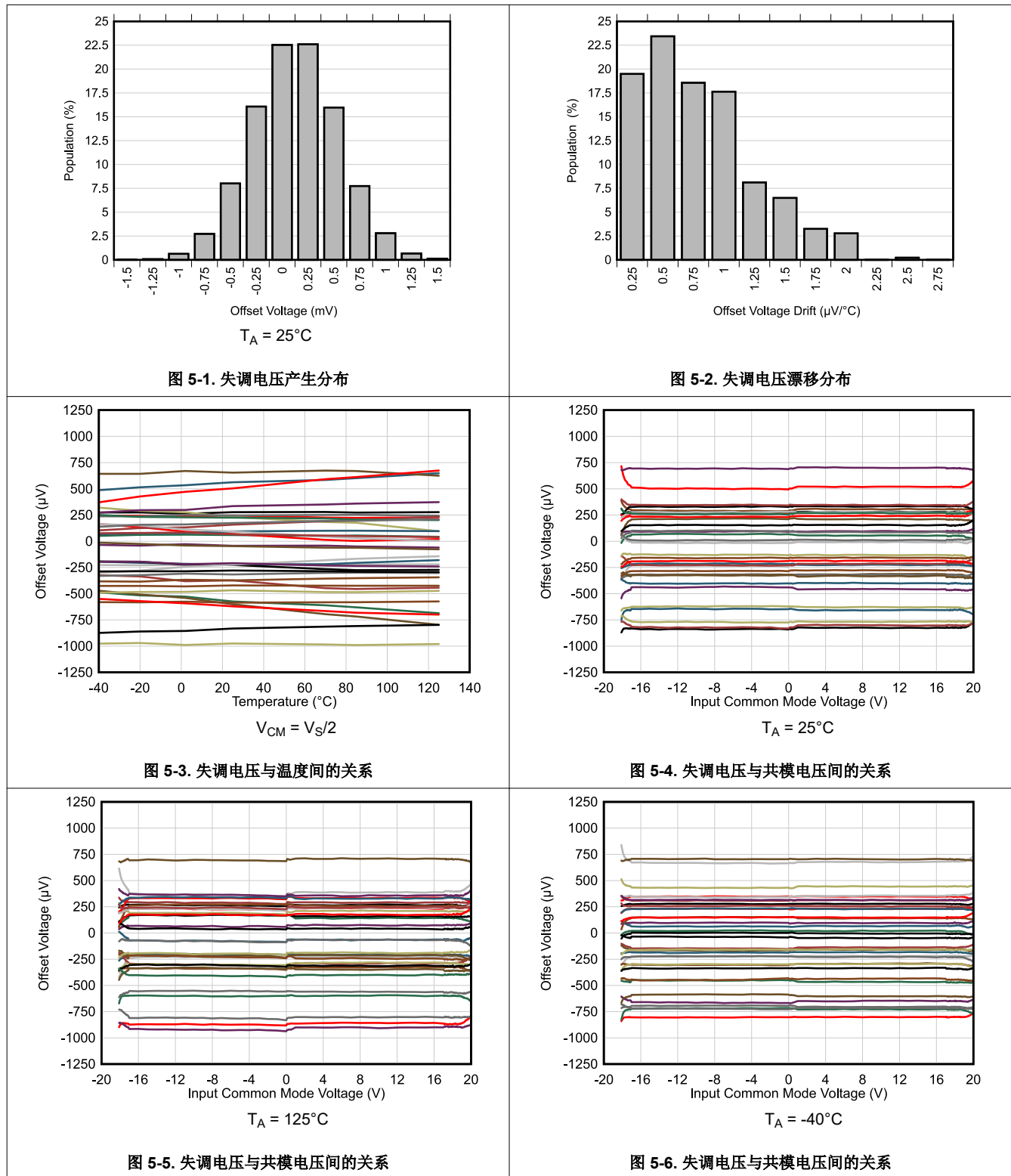

### 5.10 典型特性：TL07xH（续）

$T_A = 25^\circ\text{C}$ ,  $V_S = 40\text{V} (\pm 20\text{V})$ ,  $V_{CM} = V_S/2$ ,  $R_{LOAD} = 10\text{k}\Omega$  连接至  $V_S/2$ , 且  $C_L = 20\text{pF}$  (除非另外说明)



图 5-7. 失调电压与电源间的关系



图 5-8. 开环增益和相位与频率间的关系

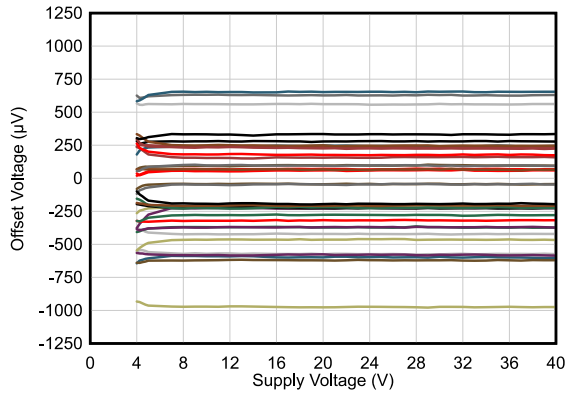

图 5-9. 闭环增益与频率间的关系

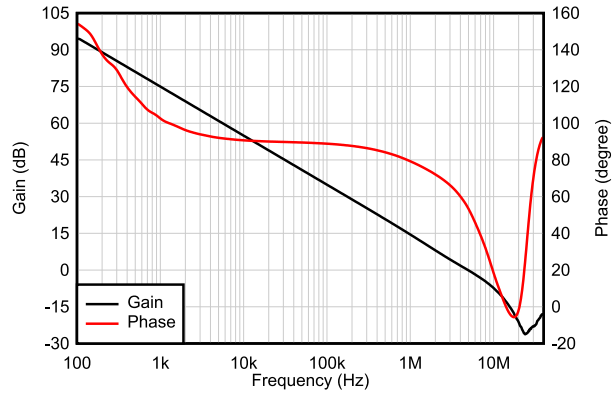

图 5-10. 输入偏置电流与共模电压间的关系

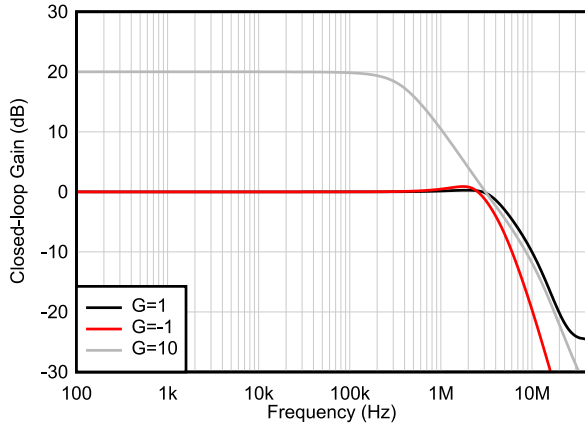

图 5-11. 输入偏置电流与温度间的关系

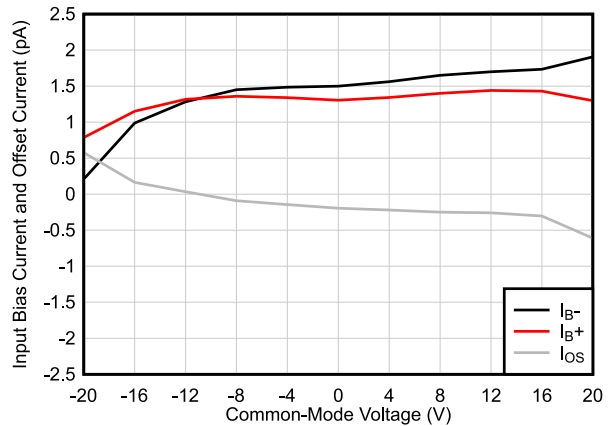

图 5-12. 输出电压摆幅与输出电流（拉电流）间的关系

### 5.10 典型特性：TL07xH（续）

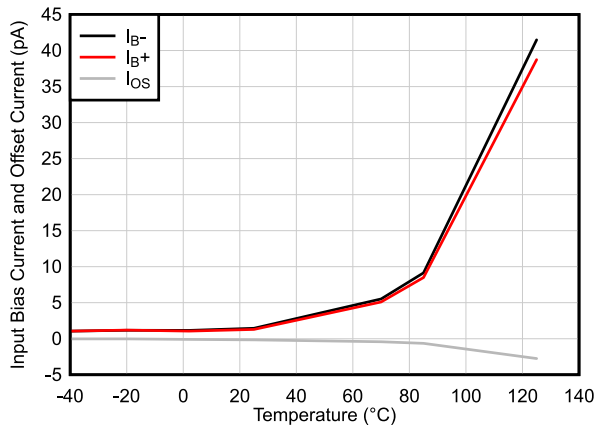
$T_A = 25^\circ\text{C}$ ,  $V_S = 40\text{V} (\pm 20\text{V})$ ,  $V_{CM} = V_S/2$ ,  $R_{LOAD} = 10\text{k}\Omega$  连接至  $V_S/2$ , 且  $C_L = 20\text{pF}$  (除非另外说明)

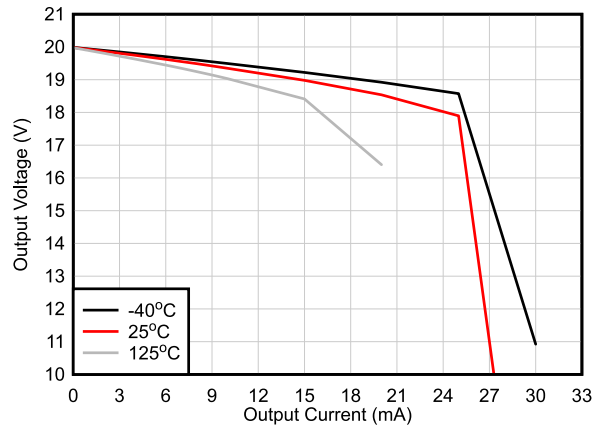

图 5-13. 输出电压摆幅与输出电流（灌电流）间的关系



图 5-14. CMRR 和 PSRR 与频率间的关系

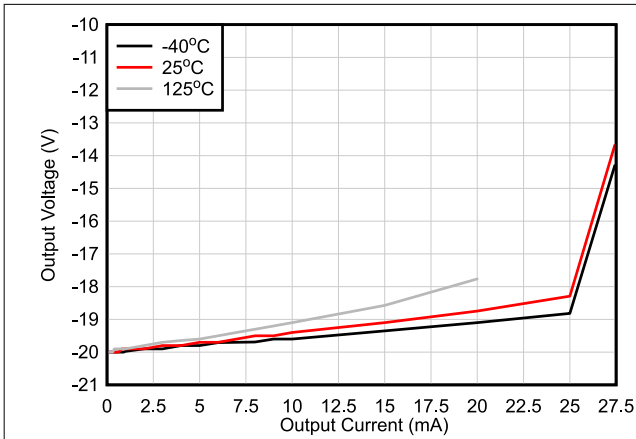

图 5-15. CMRR 与温度间的关系 (dB)

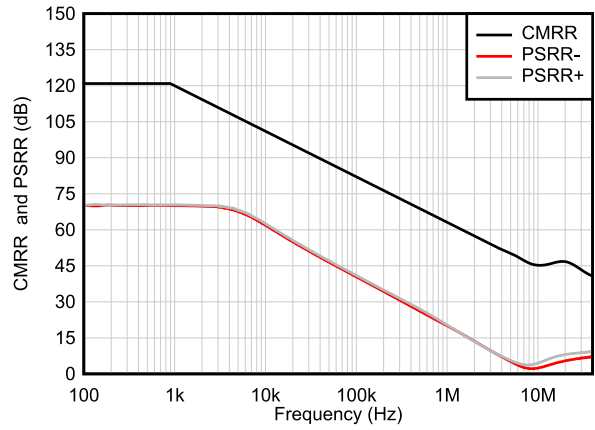

图 5-16. PSRR 与温度间的关系 (dB)

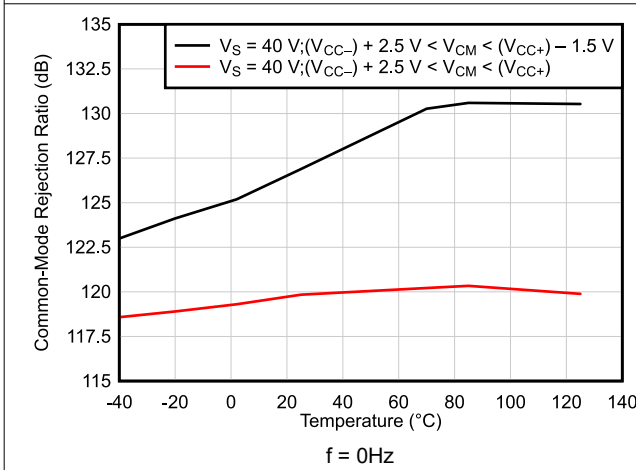

图 5-17. 0.1Hz 至 10Hz 噪声

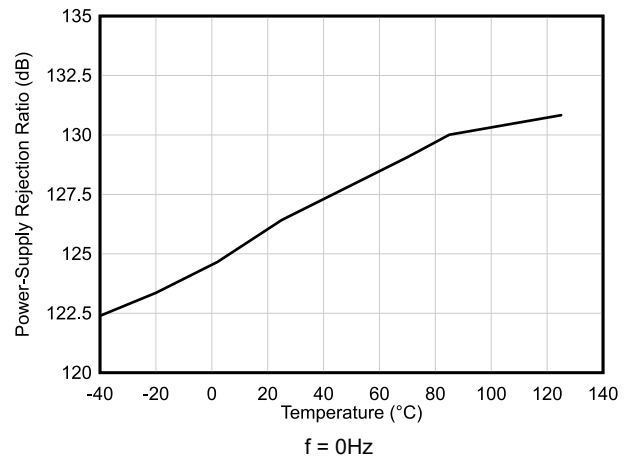

图 5-18. 输入电压噪声频谱密度与频率间的关系

### 5.10 典型特性：TL07xH（续）

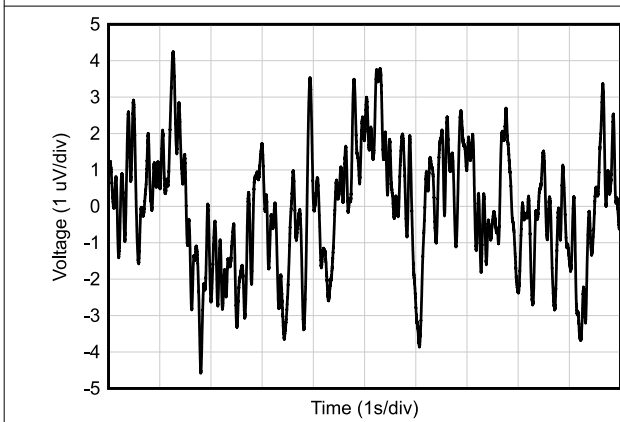
$T_A = 25^\circ\text{C}$ ,  $V_S = 40\text{V} (\pm 20\text{V})$ ,  $V_{CM} = V_S/2$ ,  $R_{LOAD} = 10\text{k}\Omega$  连接至  $V_S/2$ , 且  $C_L = 20\text{pF}$  (除非另外说明)

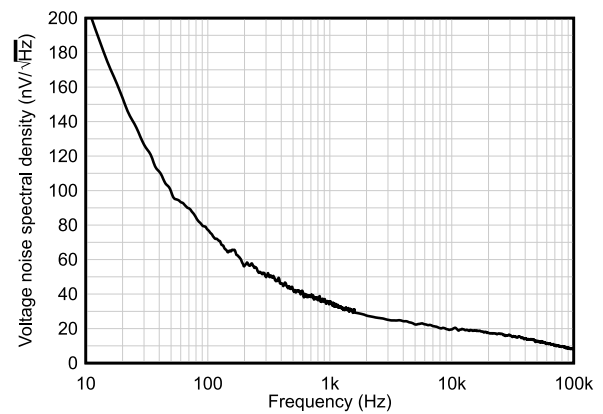

图 5-19. 静态电流与电源电压间的关系



图 5-20. 静态电流与温度间的关系

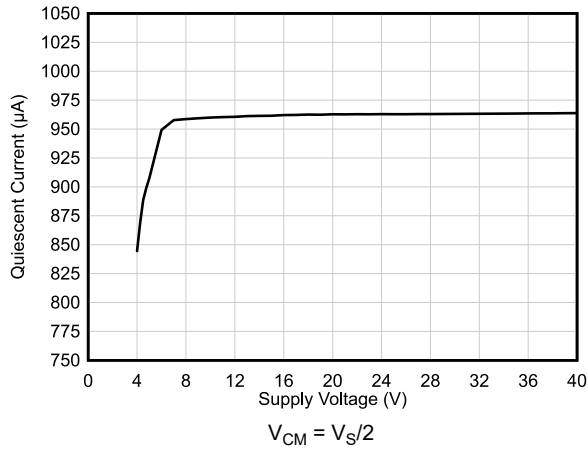

图 5-21. 开环电压增益与温度

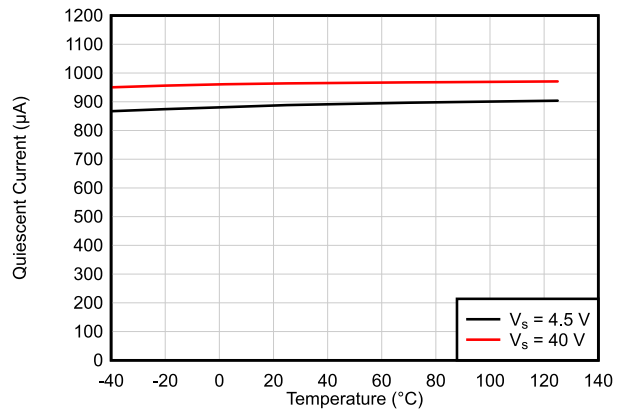

图 5-22. 开环输出阻抗与频率间的关系

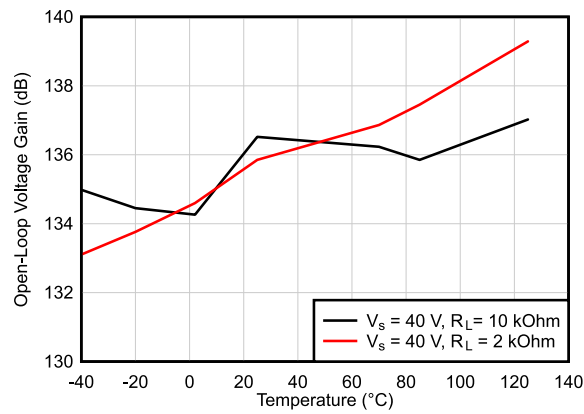

图 5-23. 小信号过冲与容性负载间的关系

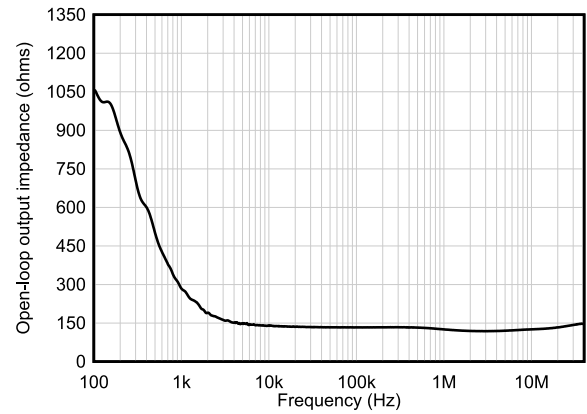

图 5-24. 小信号过冲与容性负载间的关系

### 5.10 典型特性：TL07xH（续）

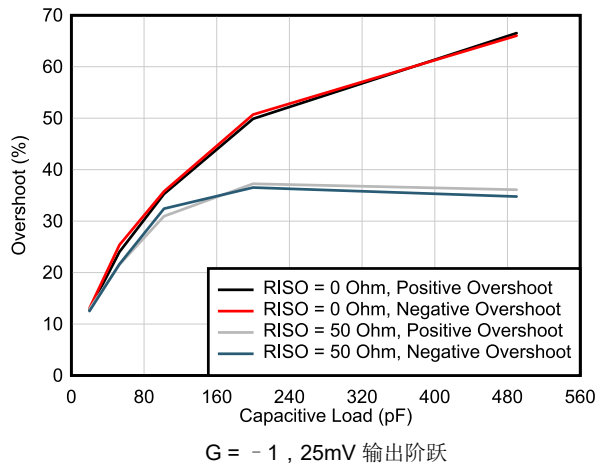
$T_A = 25^\circ\text{C}$ ,  $V_S = 40\text{V} (\pm 20\text{V})$ ,  $V_{CM} = V_S/2$ ,  $R_{LOAD} = 10\text{k}\Omega$  连接至  $V_S/2$ , 且  $C_L = 20\text{pF}$  (除非另外说明)

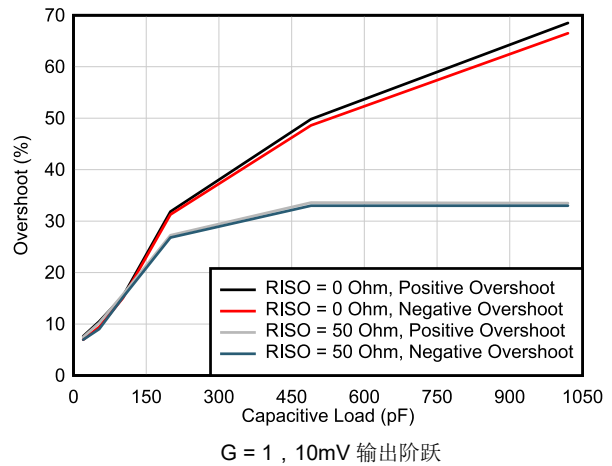

图 5-25. 相位裕度与容性负载间的关系



$V_S = \pm 10\text{V}$ ,  $V_{IN} = V_{OUT}$

图 5-26. 无相位反转

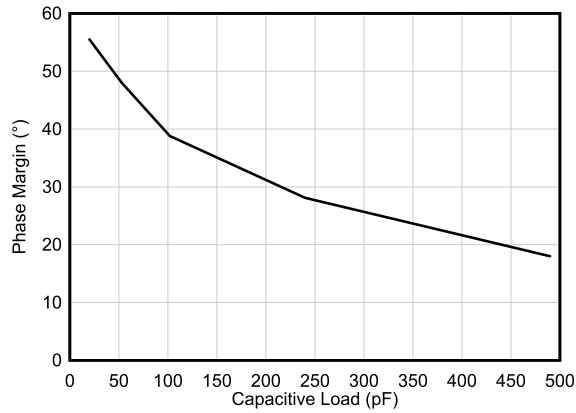
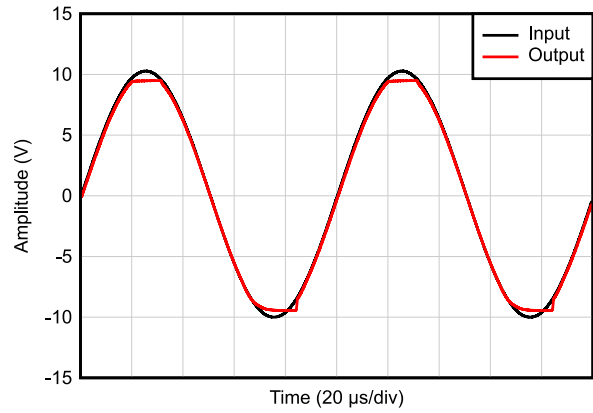
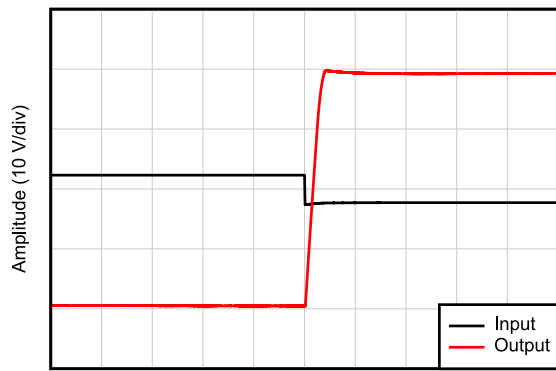

$G = -10$

图 5-27. 正过载恢复

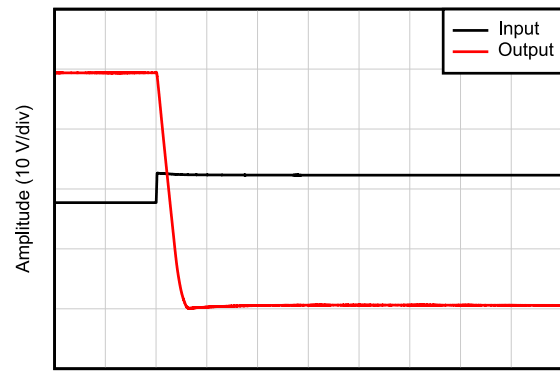

$G = -10$

图 5-28. 负过载恢复

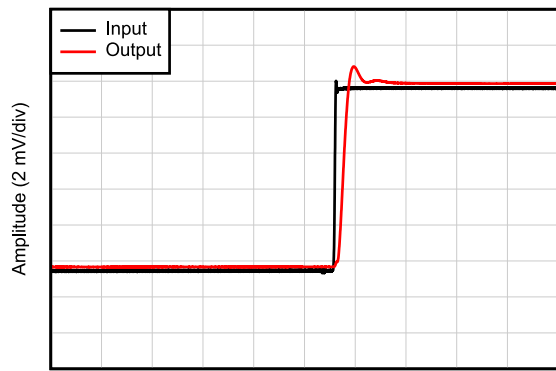

$C_L = 20\text{pF}$ ,  $G = 1$ , 10mV 阶跃响应

图 5-29. 小信号阶跃响应，上升

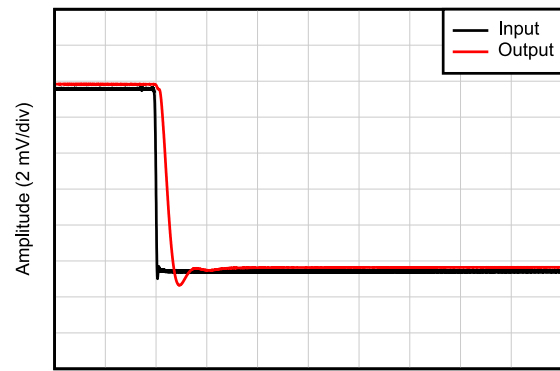

$C_L = 20\text{pF}$ ,  $G = 1$ , 10mV 阶跃响应

图 5-30. 小信号阶跃响应，下降

### 5.10 典型特性：TL07xH（续）

$T_A = 25^\circ\text{C}$ ,  $V_S = 40\text{V} (\pm 20\text{V})$ ,  $V_{CM} = V_S/2$ ,  $R_{LOAD} = 10\text{k}\Omega$  连接至  $V_S/2$ , 且  $C_L = 20\text{pF}$  (除非另外说明)

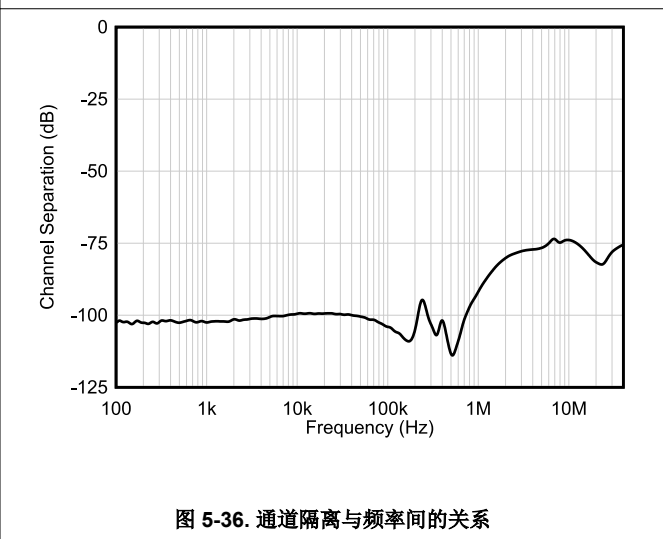
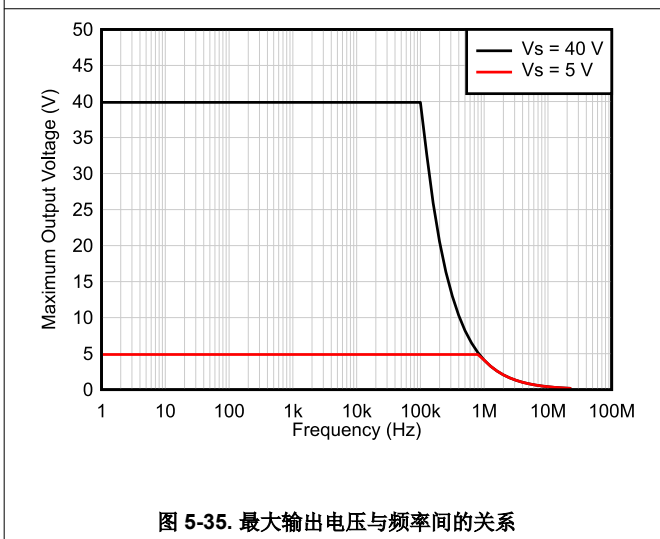
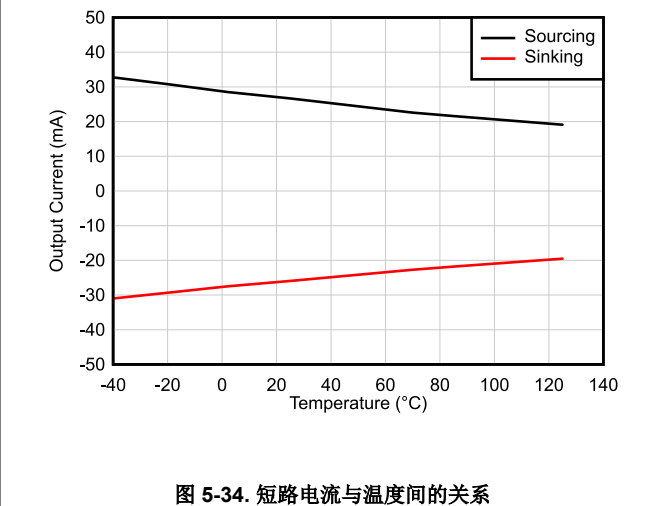
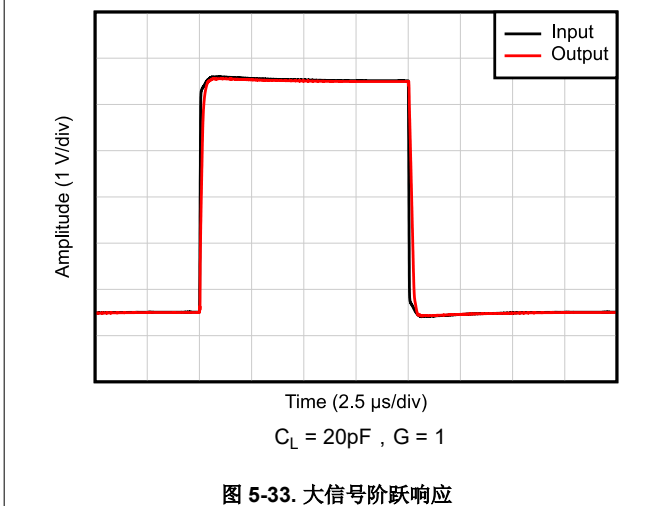
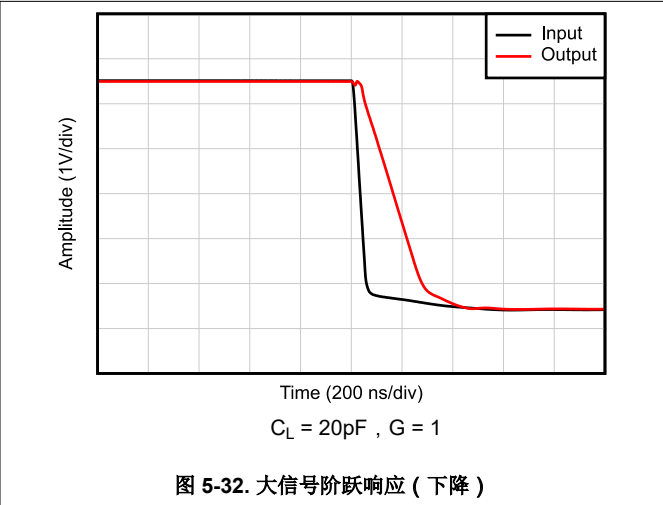
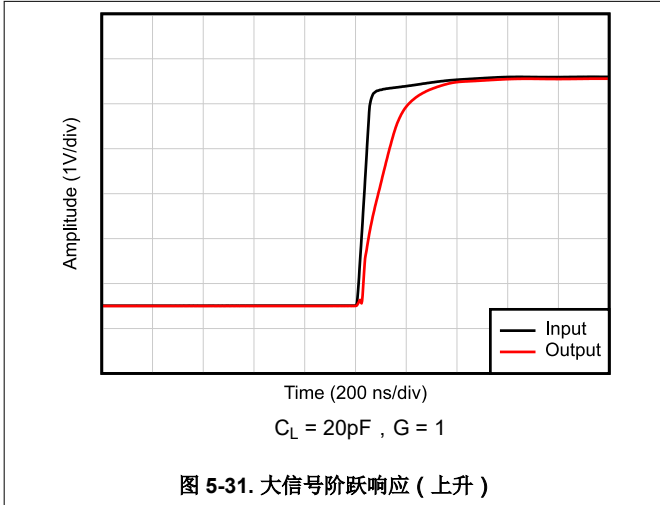

## 5.10 典型特性：TL07xH（续）

$T_A = 25^\circ\text{C}$ ， $V_S = 40\text{V} (\pm 20\text{V})$ ， $V_{CM} = V_S/2$ ， $R_{LOAD} = 10\text{k}\Omega$  连接至  $V_S/2$ ，且  $C_L = 20\text{pF}$ （除非另外说明）



图 5-37. EMIRR（电磁干扰抑制比）与频率间的关系

5.11 典型特性：除 TL07xH 之外的所有器件



图 5-38. 输入偏置电流与自然通风温度间的关系

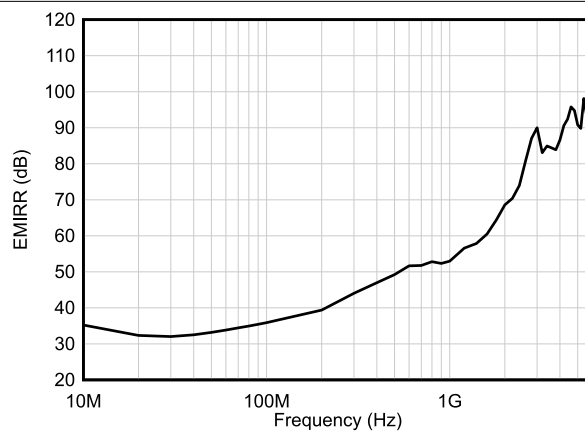

图 5-39. 最大峰值输出电压与频率间的关系

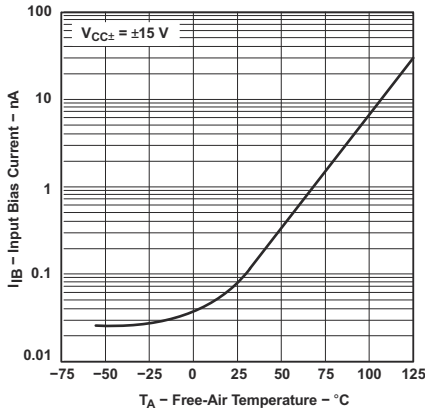

图 5-40. 最大峰值输出电压与频率间的关系

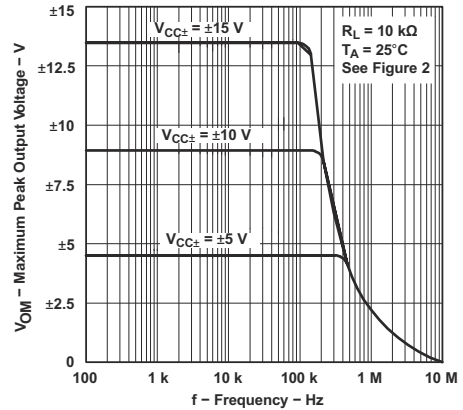

图 5-41. 最大峰值输出电压与频率间的关系

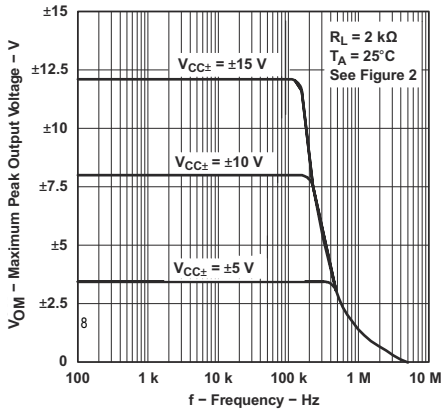

图 5-42. 最大峰值输出电压与自然通风温度间的关系

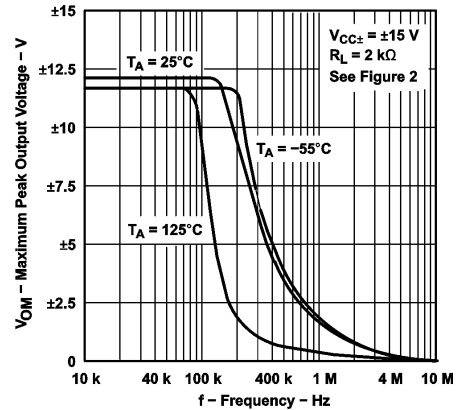

图 5-43. 最大峰值输出电压与负载电阻间的关系

5.11 典型特性：除 TL07xH 之外的所有器件（续）

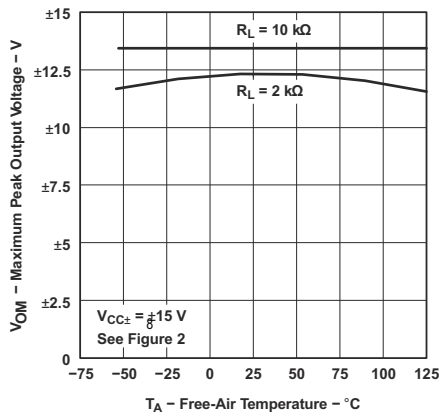

图 5-44. 最大峰值输出电压与电源电压间的关系

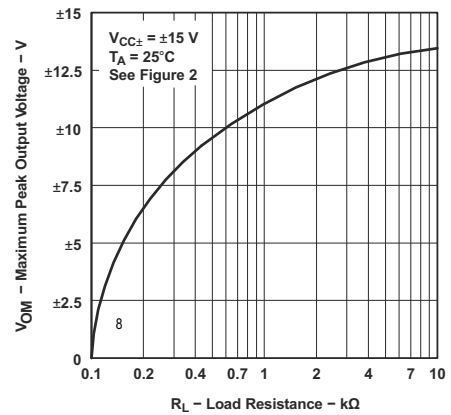

图 5-45. 大信号差分电压放大与自然通风温度间的关系

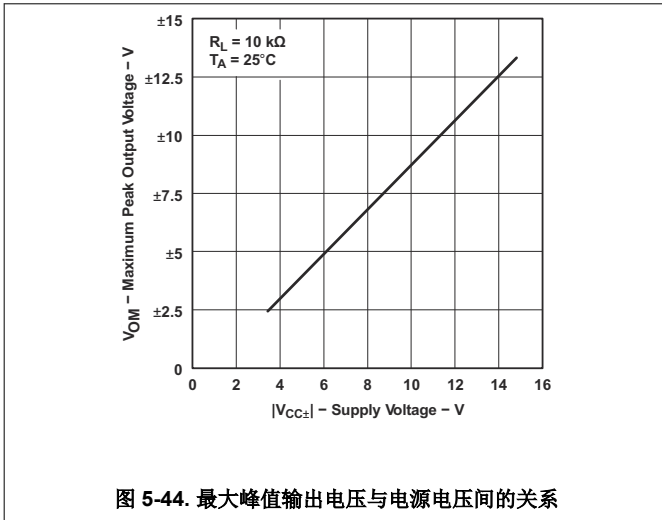

图 5-46. 大信号差分电压放大和相移与频率间的关系

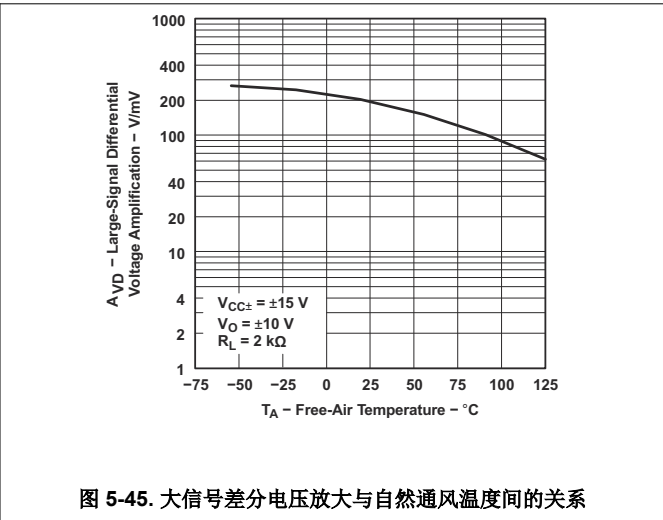

图 5-47. 归一化单位增益带宽和相移与自然通风温度间的关系

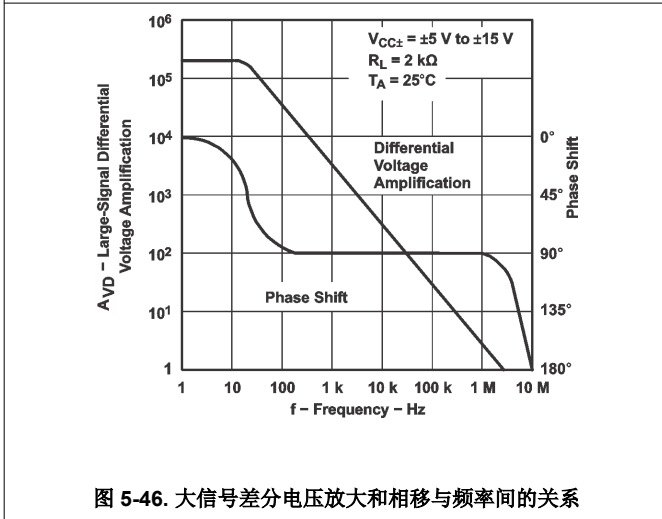

图 5-48. 共模抑制比与自然通风温度间的关系

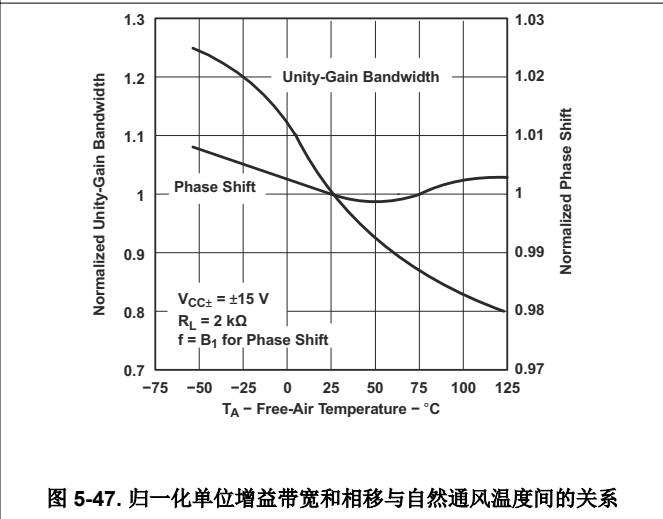

图 5-49. 每个放大器的电源电流与电源电压间的关系

5.11 典型特性：除 TL07xH 之外的所有器件（续）

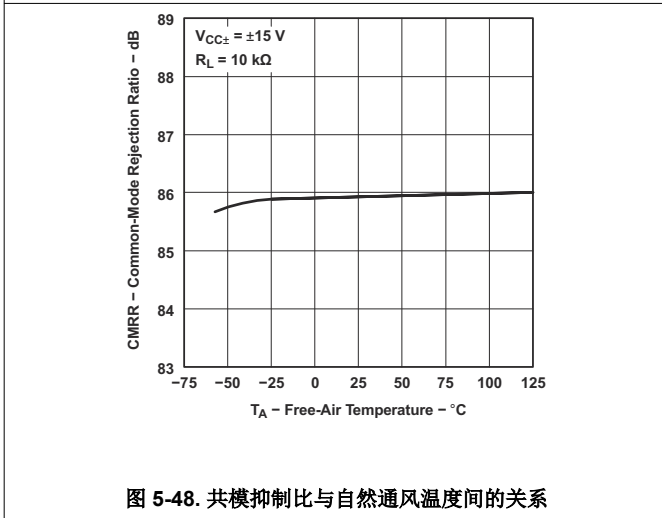

图 5-50. 每个放大器的电源电流与自然通风温度间的关系

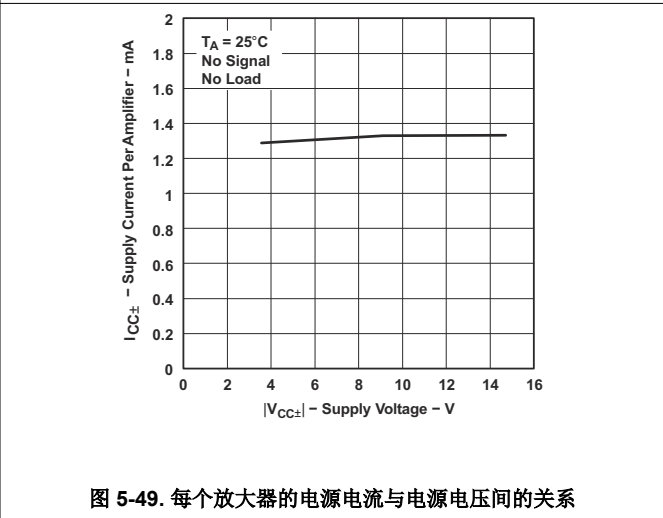

图 5-51. 总功率耗散与自然通风温度间的关系

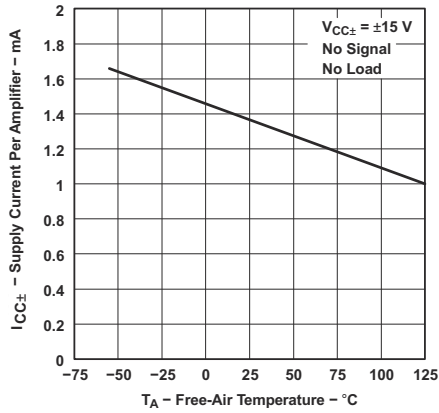

图 5-52. 归一化转换率与自然通风温度间的关系

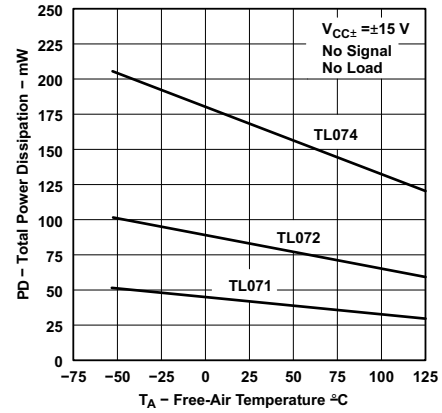

图 5-53. 等效输入噪声电压与频率间的关系

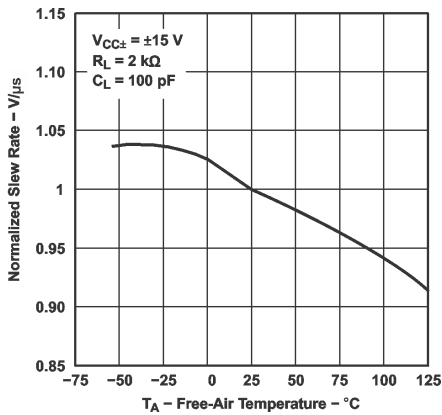

图 5-54. 总谐波失真与频率间的关系

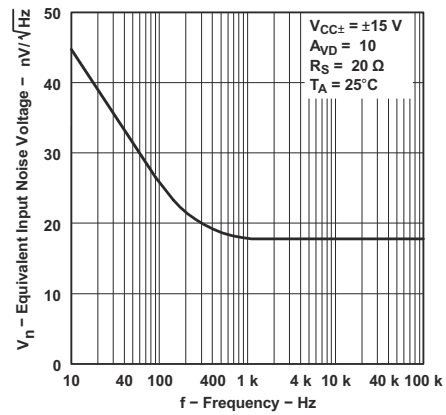

图 5-55. 电压输出器大信号脉冲响应

### 5.11 典型特性：除 TL07xH 之外的所有器件（续）

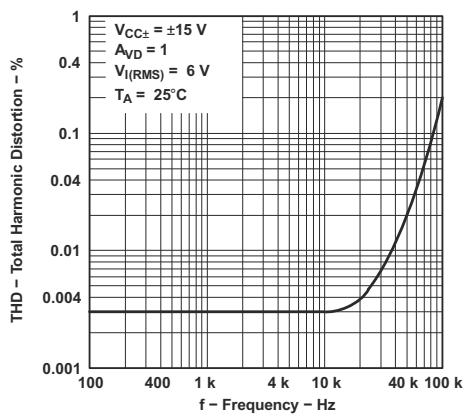

图 5-56. 输出电压与经历时间的关系

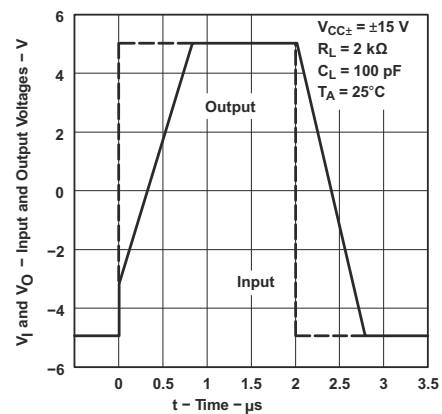

图 5-57.  $V_{IO}$  与  $V_{CM}$  间的关系

## 6 参数测量信息

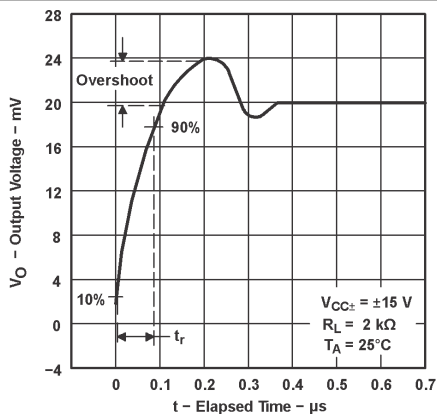

图 6-1. 单位增益放大器

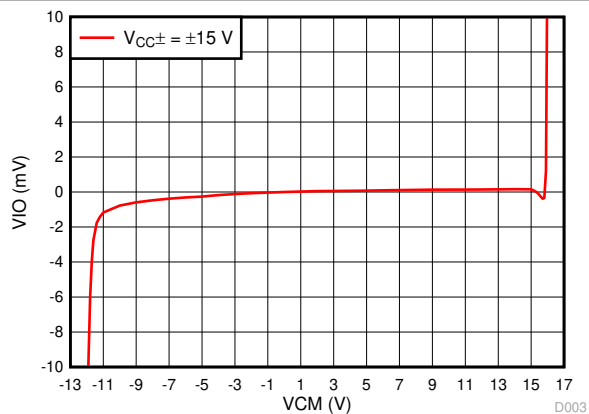

图 6-2. 10 倍增益反相放大器

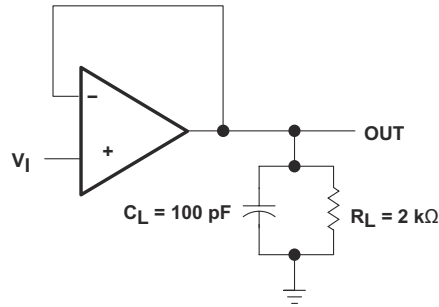

图 6-3. 仅适用于 PS 封装 (SO, 8) 的输入偏移电压调零电路

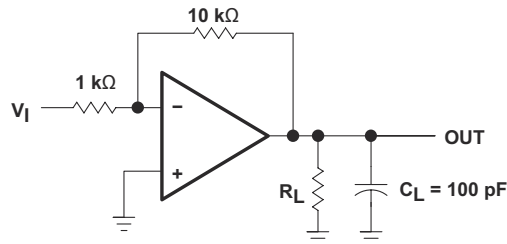

## 8 应用和实现

### 备注

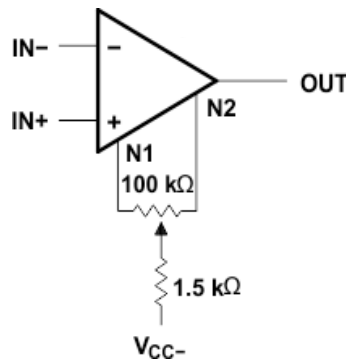
以下应用部分中的信息不属于 TI 器件规格的范围，TI 不担保其准确性和完整性。TI 的客户应负责确定器件是否适用于其应用。客户应验证并测试其设计，以确保系统功能。

### 8.1 应用信息

运算放大器的典型应用是反相放大器。该放大器在输入端接受正电压，然后使电压变为负电压。该放大器以相同的方式使负输入电压变为正电压。

### 8.2 典型应用

#### 8.2.1 反相放大器



图 8-1. 反相放大器

##### 8.2.1.1 设计要求

所选用的电源电压必须大于输入电压范围和输出范围。例如，此应用将  $\pm 0.5V$  的信号扩展到了  $\pm 1.8V$ 。将电源设置在  $\pm 12V$  就足以满足此应用的要求。

##### 8.2.1.2 详细设计过程

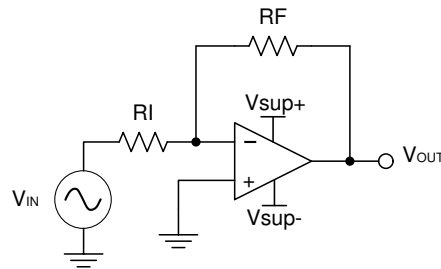
确定反相放大器需要的增益：

$$A_V = \frac{V_{OUT}}{V_{IN}} \quad (1)$$

$$A_V = \frac{1.8}{-0.5} = -3.6 \quad (2)$$

确定所需增益后，选择  $R_I$  或  $R_F$  的阻值。由于放大器电路使用毫安级电流，因此需要选择千欧姆级阻值。此示例使用的  $R_I$  为  $10k\Omega$ ，这意味着对  $R_F$  使用  $36k\Omega$ 。增益通过 [方程式 3](#) 确定。

$$A_V = -\frac{R_F}{R_I} \quad (3)$$

### 8.2.1.3 应用曲线



图 8-2. 反相放大器的输入和输出电压

## 8.3 电源相关建议

### 小心

单电源的电源电压超过 36V 或双电源的电源电压范围超出  $\pm 18V$  可能会对器件造成损坏 ( 请参阅节 5.1 )。

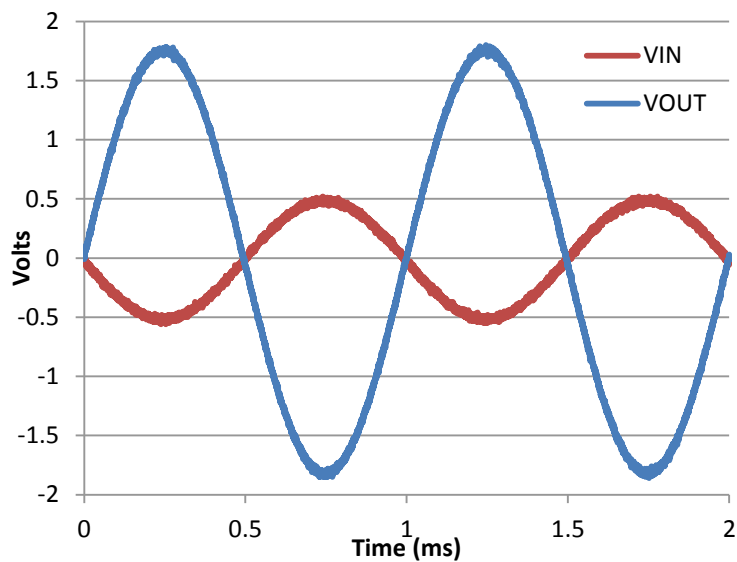
将 0.1  $\mu F$  旁路电容器置于电源引脚附近，可减少从高噪声电源或高阻抗电源中耦合进来的误差。有关旁路电容器放置的更多详细信息，请参阅节 8.4。

## 8.4 布局

### 8.4.1 布局指南

为了实现器件的出色工作性能，请采用良好的 PCB 布局实践，包括：

- 噪声可通过全部电路电源引脚以及运算放大器自身传入模拟电路。旁路电容器用于为局部模拟电路提供低阻抗电源，从而降低耦合噪声。
  - 在每个电源引脚和接地端之间连接低 ESR 0.1 $\mu F$  陶瓷旁路电容器，放置位置尽量靠近器件。从  $V_{CC+}$  到接地端的单个旁路电容器适用于单通道电源应用。
- 将电路中的模拟部分和数字部分单独接地是最简单、最有效的噪声抑制方法之一。多层 PCB 上的一层或多层通常专门用于作为接地平面。接地层有助于散热和减少 EMI 噪声拾取。请小心地对数字接地和模拟接地进行物理隔离，同时应注意接地电流。
- 为了减少寄生耦合，应让输入走线尽可能远离电源或输出走线。如果无法这么做，最好让敏感走线与有噪声的走线垂直相交，而不是平行。
- 外部元件应尽量靠近器件放置。使 RF 和 RG 接近反相输入可尽可能减小寄生电容；另请参阅节 8.4.2。
- 尽可能缩短输入走线的长度。切记，输入布线是电路中最敏感的部分。
- 考虑在关键布线周围设定驱动型低阻抗保护环。这样可显著减少附近布线在不同电势下产生的漏电流。

### 8.4.2 布局示例



图 8-3. 同相配置的运算放大器电路板布局



图 8-4. 同相配置的运算放大器原理图

## 9 器件和文档支持

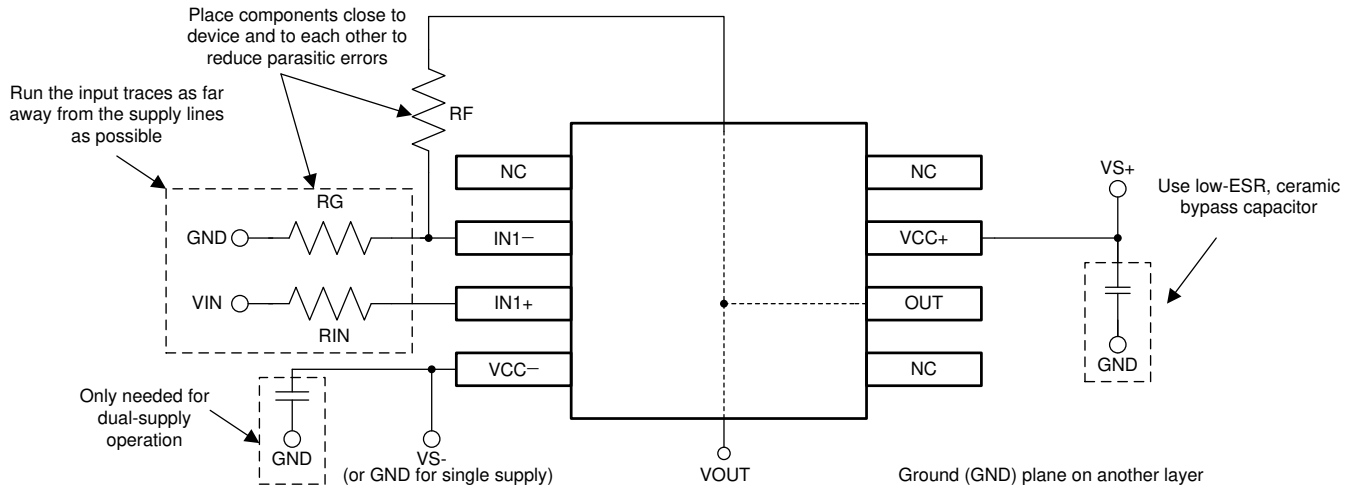
### 9.1 器件支持

#### 9.1.1 器件命名规则

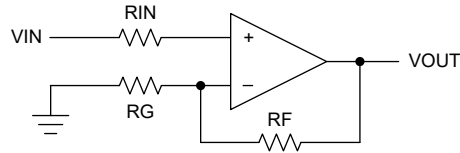
表 9-1. 器件命名规则

器件型号	定义
TL07xyzzzzzz	x 是通道数
	如果 $y = H$ ，则裸片采用最新流程制造 (CSO : RFB)。节 5.7 和 节 5.10 描述了新裸片的性能。
	如果 $y \neq H$ 且 $y \neq M$ ，则裸片采用传统流程制造 (CSO: SFAB) 或采用最新流程 (CSO: RFB)。节 5.8、节 5.9 和 节 5.11 描述了原始裸片的性能。节 5.7 和 节 5.10 描述了新裸片的性能。
	如果 $y = M$ ，则该器件适用于 $-55^{\circ}\text{C}$ 到 $+125^{\circ}\text{C}$ 的工作温度范围。裸片采用传统工艺流程 (CSO:SFAB) 制造。z 所代表的字母和数字表示分级和封装选项，其说明见 节 5.8 以及数据表末尾的 封装选项附录。

### 9.2 接收文档更新通知

要接收文档更新通知，请导航至 [ti.com](https://www.ti.com) 上的器件产品文件夹。点击 [通知](#) 进行注册，即可每周接收产品信息更改摘要。有关更改的详细信息，请查看任何已修订文档中包含的修订历史记录。

### 9.3 支持资源

[TI E2E™ 中文支持论坛](#) 是工程师的重要参考资料，可直接从专家处获得快速、经过验证的解答和设计帮助。搜索现有解答或提出自己的问题，获得所需的快速设计帮助。

链接的内容由各个贡献者“按原样”提供。这些内容并不构成 TI 技术规范，并且不一定反映 TI 的观点；请参阅 TI 的 [使用条款](#)。

### 9.4 商标

TI E2E™ is a trademark of Texas Instruments.

所有商标均为其各自所有者的财产。

### 9.5 静电放电警告



静电放电 (ESD) 会损坏这个集成电路。德州仪器 (TI) 建议通过适当的预防措施处理所有集成电路。如果不遵守正确的处理和安装程序，可能会损坏集成电路。

ESD 的损坏小至导致微小的性能降级，大至整个器件故障。精密的集成电路可能更容易受到损坏，这是因为非常细微的参数更改都可能会导致器件与其发布的规格不相符。

### 9.6 术语表

[TI 术语表](#) 本术语表列出并解释了术语、首字母缩略词和定义。

## 10 修订历史记录

注：以前版本的页码可能与当前版本的页码不同

Changes from Revision V (April 2023) to Revision W (July 2025)	Page
• 删除了除 PS ( SO , 8 ) 封装之外所有封装中对修整功能的引用.....	1
• 将 特性 中的 $V_n$ 从 $18\text{nV}/\sqrt{\text{Hz}}$ 更改为 $37\text{nV}/\sqrt{\text{Hz}}$ .....	1
• 更新了 器件信息表，以便与 封装选项附录一致.....	1
• 更新了首页图像，以显示哪个器件仅使用 PS 封装.....	1
• 更新了 引脚配置和功能，以表明只有 PS 封装 ( PDIP , 8 ) 具有修整功能.....	3

• 添加了有关新旧裸片的注释.....	10
• 删除了图 5-19, <i>THD+N</i> 比与频率间的关系 和图 5-20, <i>THD+N</i> 与输出振幅间的关系 .....	18
• 向图 7-3 的标题添加了“仅适用于 PS 封装 ( SO , 8 ) ” .....	29
• 删除了 单位增益缓冲器 和 系统示例 部分 .....	31
• 从 详细设计过程 中删除了公式 1.....	31
• 从 详细设计过程 中删除了“这可确保器件不会消耗过多电流。” .....	31
• 添加了 器件命名规则表.....	35

---

### Changes from Revision U (December 2022) to Revision V (April 2023)

Page

• 更新了概述、功能方框图和特性说明 部分.....	30
----------------------------	----

---

## 11 机械、封装和可订购信息

以下页面包含机械、封装和可订购信息。这些信息是指定器件的最新可用数据。数据如有变更，恕不另行通知，且不会对此文档进行修订。如需获取此数据表的浏览器版本，请查阅左侧的导航栏。

**PACKAGING INFORMATION**

Orderable part number	Status (1)	Material type (2)	Package   Pins	Package qty   Carrier	RoHS (3)	Lead finish/ Ball material (4)	MSL rating/ Peak reflow (5)	Op temp (°C)	Part marking (6)
<a href="#">81023052A</a>	Active	Production	LCCC (FK)   20	55   TUBE	No	SNPB	N/A for Pkg Type	-55 to 125	81023052A TL072MFKB
<a href="#">8102305HA</a>	Active	Production	CFP (U)   10	25   TUBE	No	SNPB	N/A for Pkg Type	-55 to 125	8102305HA TL072M
<a href="#">8102305PA</a>	Active	Production	CDIP (JG)   8	50   TUBE	No	SNPB	N/A for Pkg Type	-55 to 125	8102305PA TL072M
<a href="#">81023062A</a>	Active	Production	LCCC (FK)   20	55   TUBE	No	SNPB	N/A for Pkg Type	-55 to 125	81023062A TL074MFKB
<a href="#">8102306CA</a>	Active	Production	CDIP (J)   14	25   TUBE	No	SNPB	N/A for Pkg Type	-55 to 125	8102306CA TL074MJB
<a href="#">8102306DA</a>	Active	Production	CFP (W)   14	25   TUBE	No	SNPB	N/A for Pkg Type	-55 to 125	8102306DA TL074MWB
<a href="#">JM38510/11905BPA</a>	Active	Production	CDIP (JG)   8	50   TUBE	No	SNPB	N/A for Pkg Type	-55 to 125	JM38510 /11905BPA
JM38510/11905BPA.A	Active	Production	CDIP (JG)   8	50   TUBE	No	SNPB	N/A for Pkg Type	-55 to 125	JM38510 /11905BPA
<a href="#">M38510/11905BPA</a>	Active	Production	CDIP (JG)   8	50   TUBE	No	SNPB	N/A for Pkg Type	-55 to 125	JM38510 /11905BPA
<a href="#">TL071ACDR</a>	Active	Production	SOIC (D)   8	2500   LARGE T&R	Yes	NIPDAU	Level-1-260C-UNLIM	0 to 70	071AC
TL071ACDR.A	Active	Production	SOIC (D)   8	2500   LARGE T&R	Yes	NIPDAU	Level-1-260C-UNLIM	0 to 70	071AC
<a href="#">TL071ACP</a>	Active	Production	PDIP (P)   8	50   TUBE	Yes	NIPDAU	N/A for Pkg Type	0 to 70	TL071ACP
TL071ACP.A	Active	Production	PDIP (P)   8	50   TUBE	Yes	NIPDAU	N/A for Pkg Type	0 to 70	TL071ACP
<a href="#">TL071BCDR</a>	Active	Production	SOIC (D)   8	2500   LARGE T&R	Yes	NIPDAU	Level-1-260C-UNLIM	0 to 70	071BC
TL071BCDR.A	Active	Production	SOIC (D)   8	2500   LARGE T&R	Yes	NIPDAU	Level-1-260C-UNLIM	0 to 70	071BC
<a href="#">TL071BCP</a>	Active	Production	PDIP (P)   8	50   TUBE	Yes	NIPDAU	N/A for Pkg Type	0 to 70	TL071BCP
TL071BCP.A	Active	Production	PDIP (P)   8	50   TUBE	Yes	NIPDAU	N/A for Pkg Type	0 to 70	TL071BCP
<a href="#">TL071CDR</a>	Active	Production	SOIC (D)   8	2500   LARGE T&R	Yes	NIPDAU	Level-1-260C-UNLIM	0 to 70	TL071C
TL071CDR.A	Active	Production	SOIC (D)   8	2500   LARGE T&R	Yes	NIPDAU	Level-1-260C-UNLIM	0 to 70	TL071C
TL071CDRE4	Active	Production	SOIC (D)   8	2500   LARGE T&R	-	Call TI	Call TI	0 to 70	
TL071CDRG4	Active	Production	SOIC (D)   8	2500   LARGE T&R	-	Call TI	Call TI	0 to 70	
<a href="#">TL071CP</a>	Active	Production	PDIP (P)   8	50   TUBE	Yes	NIPDAU	N/A for Pkg Type	0 to 70	TL071CP

Orderable part number	Status (1)	Material type (2)	Package   Pins	Package qty   Carrier	RoHS (3)	Lead finish/ Ball material (4)	MSL rating/ Peak reflow (5)	Op temp (°C)	Part marking (6)
TL071CP.A	Active	Production	PDIP (P)   8	50   TUBE	Yes	NIPDAU	N/A for Pkg Type	0 to 70	TL071CP
TL071CPE4	Active	Production	PDIP (P)   8	50   TUBE	-	Call TI	Call TI	0 to 70	
<a href="#">TL071CPSR</a>	Active	Production	SO (PS)   8	2000   LARGE T&R	Yes	NIPDAU	Level-1-260C-UNLIM	0 to 70	T071
TL071CPSR.A	Active	Production	SO (PS)   8	2000   LARGE T&R	Yes	NIPDAU	Level-1-260C-UNLIM	0 to 70	T071
<a href="#">TL071HIDBVR</a>	Active	Production	SOT-23 (DBV)   5	3000   LARGE T&R	Yes	NIPDAU   SN	Level-1-260C-UNLIM	-40 to 125	T71V
TL071HIDBVR.A	Active	Production	SOT-23 (DBV)   5	3000   LARGE T&R	Yes	SN	Level-1-260C-UNLIM	-40 to 125	T71V
TL071HIDBVRG4	Active	Production	SOT-23 (DBV)   5	3000   LARGE T&R	Yes	NIPDAU	Level-1-260C-UNLIM	-40 to 125	T71V
TL071HIDBVRG4.A	Active	Production	SOT-23 (DBV)   5	3000   LARGE T&R	Yes	NIPDAU	Level-1-260C-UNLIM	-40 to 125	T71V
<a href="#">TL071HIDCKR</a>	Active	Production	SC70 (DCK)   5	3000   LARGE T&R	Yes	SN	Level-1-260C-UNLIM	-40 to 125	1IO
TL071HIDCKR.A	Active	Production	SC70 (DCK)   5	3000   LARGE T&R	Yes	SN	Level-1-260C-UNLIM	-40 to 125	1IO
<a href="#">TL071HIDR</a>	Active	Production	SOIC (D)   8	3000   LARGE T&R	Yes	NIPDAU	Level-1-260C-UNLIM	-40 to 125	TL071D
TL071HIDR.A	Active	Production	SOIC (D)   8	3000   LARGE T&R	Yes	NIPDAU	Level-1-260C-UNLIM	-40 to 125	TL071D
<a href="#">TL071IDR</a>	Active	Production	SOIC (D)   8	2500   LARGE T&R	Yes	NIPDAU	Level-1-260C-UNLIM	-40 to 85	TL071I
TL071IDR.A	Active	Production	SOIC (D)   8	2500   LARGE T&R	Yes	NIPDAU	Level-1-260C-UNLIM	-40 to 85	TL071I
TL071IDR1G4	Active	Production	SOIC (D)   8	2500   LARGE T&R	Yes	NIPDAU	Level-1-260C-UNLIM	-40 to 85	TL071I
TL071IDR1G4.A	Active	Production	SOIC (D)   8	2500   LARGE T&R	Yes	NIPDAU	Level-1-260C-UNLIM	-40 to 85	TL071I
TL071IDRG4	Active	Production	SOIC (D)   8	2500   LARGE T&R	-	Call TI	Call TI	-40 to 85	
<a href="#">TL071IP</a>	Active	Production	PDIP (P)   8	50   TUBE	Yes	NIPDAU	N/A for Pkg Type	-40 to 85	TL071IP
TL071IP.A	Active	Production	PDIP (P)   8	50   TUBE	Yes	NIPDAU	N/A for Pkg Type	-40 to 85	TL071IP
<a href="#">TL072ACDR</a>	Active	Production	SOIC (D)   8	2500   LARGE T&R	Yes	NIPDAU	Level-1-260C-UNLIM	0 to 70	072AC
TL072ACDR.A	Active	Production	SOIC (D)   8	2500   LARGE T&R	Yes	NIPDAU	Level-1-260C-UNLIM	0 to 70	072AC
TL072ACDRE4	Active	Production	SOIC (D)   8	2500   LARGE T&R	Yes	NIPDAU	Level-1-260C-UNLIM	0 to 70	072AC
TL072ACDRG4	Active	Production	SOIC (D)   8	2500   LARGE T&R	Yes	NIPDAU	Level-1-260C-UNLIM	0 to 70	072AC
<a href="#">TL072ACP</a>	Active	Production	PDIP (P)   8	50   TUBE	Yes	NIPDAU	N/A for Pkg Type	0 to 70	TL072ACP
TL072ACP.A	Active	Production	PDIP (P)   8	50   TUBE	Yes	NIPDAU	N/A for Pkg Type	0 to 70	TL072ACP
TL072ACPE4	Active	Production	PDIP (P)   8	50   TUBE	-	Call TI	Call TI	0 to 70	
TL072ACPS	Active	Production	SO (PS)   8	80   TUBE	Yes	NIPDAU	Level-1-260C-UNLIM	0 to 70	T072A
TL072ACPS.A	Active	Production	SO (PS)   8	80   TUBE	Yes	NIPDAU	Level-1-260C-UNLIM	0 to 70	T072A
<a href="#">TL072BCD</a>	Obsolete	Production	SOIC (D)   8	-	-	Call TI	Call TI	0 to 70	072BC
<a href="#">TL072BCDR</a>	Active	Production	SOIC (D)   8	2500   LARGE T&R	Yes	NIPDAU	Level-1-260C-UNLIM	0 to 70	072BC
TL072BCDR.A	Active	Production	SOIC (D)   8	2500   LARGE T&R	Yes	NIPDAU	Level-1-260C-UNLIM	0 to 70	072BC

Orderable part number	Status (1)	Material type (2)	Package   Pins	Package qty   Carrier	RoHS (3)	Lead finish/ Ball material (4)	MSL rating/ Peak reflow (5)	Op temp (°C)	Part marking (6)
<a href="#">TL072BCP</a>	Active	Production	PDIP (P)   8	50   TUBE	Yes	NIPDAU	N/A for Pkg Type	0 to 70	TL072BCP
TL072BCP.A	Active	Production	PDIP (P)   8	50   TUBE	Yes	NIPDAU	N/A for Pkg Type	0 to 70	TL072BCP
<a href="#">TL072CDR</a>	Active	Production	SOIC (D)   8	2500   LARGE T&R	Yes	NIPDAU	Level-1-260C-UNLIM	0 to 70	TL072C
TL072CDR.A	Active	Production	SOIC (D)   8	2500   LARGE T&R	Yes	NIPDAU	Level-1-260C-UNLIM	0 to 70	TL072C
<a href="#">TL072CP</a>	Active	Production	PDIP (P)   8	50   TUBE	Yes	NIPDAU	N/A for Pkg Type	0 to 70	TL072CP
TL072CP.A	Active	Production	PDIP (P)   8	50   TUBE	Yes	NIPDAU	N/A for Pkg Type	0 to 70	TL072CP
<a href="#">TL072CPS</a>	Active	Production	SO (PS)   8	80   TUBE	Yes	NIPDAU	Level-1-260C-UNLIM	0 to 70	T072
TL072CPS.A	Active	Production	SO (PS)   8	80   TUBE	Yes	NIPDAU	Level-1-260C-UNLIM	0 to 70	T072
<a href="#">TL072CPSR</a>	Active	Production	SO (PS)   8	2000   LARGE T&R	Yes	NIPDAU	Level-1-260C-UNLIM	0 to 70	T072
TL072CPSR.A	Active	Production	SO (PS)   8	2000   LARGE T&R	Yes	NIPDAU	Level-1-260C-UNLIM	0 to 70	T072
TL072CPSRG4	Active	Production	SO (PS)   8	2000   LARGE T&R	Yes	NIPDAU	Level-1-260C-UNLIM	0 to 70	T072
<a href="#">TL072CPWR</a>	Active	Production	TSSOP (PW)   8	2000   LARGE T&R	Yes	NIPDAU	Level-1-260C-UNLIM	0 to 70	T072
TL072CPWR.A	Active	Production	TSSOP (PW)   8	2000   LARGE T&R	Yes	NIPDAU	Level-1-260C-UNLIM	0 to 70	T072
TL072CPWRE4	Active	Production	TSSOP (PW)   8	2000   LARGE T&R	-	Call TI	Call TI	0 to 70	
TL072CPWRG4	Active	Production	TSSOP (PW)   8	2000   LARGE T&R	-	Call TI	Call TI	0 to 70	
<a href="#">TL072HIDDFR</a>	Active	Production	SOT-23-THIN (DDF)   8	3000   LARGE T&R	Yes	NIPDAU	Level-1-260C-UNLIM	-40 to 125	O72F
TL072HIDDFR.A	Active	Production	SOT-23-THIN (DDF)   8	3000   LARGE T&R	Yes	NIPDAU	Level-1-260C-UNLIM	-40 to 125	O72F
<a href="#">TL072HIDR</a>	Active	Production	SOIC (D)   8	3000   LARGE T&R	Yes	NIPDAU	Level-1-260C-UNLIM	-40 to 125	TL072D
TL072HIDR.A	Active	Production	SOIC (D)   8	3000   LARGE T&R	Yes	NIPDAU	Level-1-260C-UNLIM	-40 to 125	TL072D
<a href="#">TL072HIPWR</a>	Active	Production	TSSOP (PW)   8	3000   LARGE T&R	Yes	NIPDAU	Level-1-260C-UNLIM	-40 to 125	072HPW
TL072HIPWR.A	Active	Production	TSSOP (PW)   8	3000   LARGE T&R	Yes	NIPDAU	Level-1-260C-UNLIM	-40 to 125	072HPW
<a href="#">TL072IDR</a>	Active	Production	SOIC (D)   8	2500   LARGE T&R	Yes	NIPDAU	Level-1-260C-UNLIM	-40 to 85	TL072I
TL072IDR.A	Active	Production	SOIC (D)   8	2500   LARGE T&R	Yes	NIPDAU	Level-1-260C-UNLIM	-40 to 85	TL072I
<a href="#">TL072IP</a>	Active	Production	PDIP (P)   8	50   TUBE	Yes	NIPDAU	N/A for Pkg Type	-40 to 85	TL072IP
TL072IP.A	Active	Production	PDIP (P)   8	50   TUBE	Yes	NIPDAU	N/A for Pkg Type	-40 to 85	TL072IP
TL072IPE4	Active	Production	PDIP (P)   8	50   TUBE	-	Call TI	Call TI	-40 to 85	
<a href="#">TL072MFKB</a>	Active	Production	LCCC (FK)   20	55   TUBE	No	SNPB	N/A for Pkg Type	-55 to 125	81023052A TL072MFKB
TL072MFKB.A	Active	Production	LCCC (FK)   20	55   TUBE	No	SNPB	N/A for Pkg Type	-55 to 125	81023052A TL072MFKB
<a href="#">TL072MJG</a>	Active	Production	CDIP (JG)   8	50   TUBE	No	SNPB	N/A for Pkg Type	-55 to 125	TL072MJG

Orderable part number	Status (1)	Material type (2)	Package   Pins	Package qty   Carrier	RoHS (3)	Lead finish/ Ball material (4)	MSL rating/ Peak reflow (5)	Op temp (°C)	Part marking (6)
TL072MJG.A	Active	Production	CDIP (JG)   8	50   TUBE	No	SNPB	N/A for Pkg Type	-55 to 125	TL072MJG
<a href="#">TL072MJGB</a>	Active	Production	CDIP (JG)   8	50   TUBE	No	SNPB	N/A for Pkg Type	-55 to 125	8102305PA TL072M
TL072MJGB.A	Active	Production	CDIP (JG)   8	50   TUBE	No	SNPB	N/A for Pkg Type	-55 to 125	8102305PA TL072M
<a href="#">TL072MUB</a>	Active	Production	CFP (U)   10	25   TUBE	No	SNPB	N/A for Pkg Type	-55 to 125	8102305HA TL072M
TL072MUB.A	Active	Production	CFP (U)   10	25   TUBE	No	SNPB	N/A for Pkg Type	-55 to 125	8102305HA TL072M
<a href="#">TL074ACD</a>	Obsolete	Production	SOIC (D)   14	-	-	Call TI	Call TI	0 to 70	TL074AC
<a href="#">TL074ACDR</a>	Active	Production	SOIC (D)   14	2500   LARGE T&R	Yes	NIPDAU	Level-1-260C-UNLIM	0 to 70	TL074AC
TL074ACDR.A	Active	Production	SOIC (D)   14	2500   LARGE T&R	Yes	NIPDAU	Level-1-260C-UNLIM	0 to 70	TL074AC
<a href="#">TL074ACN</a>	Active	Production	PDIP (N)   14	25   TUBE	Yes	NIPDAU	N/A for Pkg Type	0 to 70	TL074ACN
TL074ACN.A	Active	Production	PDIP (N)   14	25   TUBE	Yes	NIPDAU	N/A for Pkg Type	0 to 70	TL074ACN
<a href="#">TL074ACNSR</a>	Active	Production	SOP (NS)   14	2000   LARGE T&R	Yes	NIPDAU	Level-1-260C-UNLIM	0 to 70	TL074A
TL074ACNSR.A	Active	Production	SOP (NS)   14	2000   LARGE T&R	Yes	NIPDAU	Level-1-260C-UNLIM	0 to 70	TL074A
<a href="#">TL074BCD</a>	Obsolete	Production	SOIC (D)   14	-	-	Call TI	Call TI	0 to 70	TL074BC
<a href="#">TL074BCDR</a>	Active	Production	SOIC (D)   14	2500   LARGE T&R	Yes	NIPDAU	Level-1-260C-UNLIM	0 to 70	TL074BC
TL074BCDR.A	Active	Production	SOIC (D)   14	2500   LARGE T&R	Yes	NIPDAU	Level-1-260C-UNLIM	0 to 70	TL074BC
TL074BCDRE4	Active	Production	SOIC (D)   14	2500   LARGE T&R	Yes	NIPDAU	Level-1-260C-UNLIM	0 to 70	TL074BC
TL074BCDRG4	Active	Production	SOIC (D)   14	2500   LARGE T&R	Yes	NIPDAU	Level-1-260C-UNLIM	0 to 70	TL074BC
<a href="#">TL074BCN</a>	Active	Production	PDIP (N)   14	25   TUBE	Yes	NIPDAU	N/A for Pkg Type	0 to 70	TL074BCN
TL074BCN.A	Active	Production	PDIP (N)   14	25   TUBE	Yes	NIPDAU	N/A for Pkg Type	0 to 70	TL074BCN
<a href="#">TL074CD</a>	Obsolete	Production	SOIC (D)   14	-	-	Call TI	Call TI	0 to 70	TL074C
<a href="#">TL074CDBR</a>	Active	Production	SSOP (DB)   14	2000   LARGE T&R	Yes	NIPDAU	Level-1-260C-UNLIM	0 to 70	T074
TL074CDBR.A	Active	Production	SSOP (DB)   14	2000   LARGE T&R	Yes	NIPDAU	Level-1-260C-UNLIM	0 to 70	T074
<a href="#">TL074CDR</a>	Active	Production	SOIC (D)   14	2500   LARGE T&R	Yes	NIPDAU	Level-1-260C-UNLIM	0 to 70	TL074C
TL074CDR.A	Active	Production	SOIC (D)   14	2500   LARGE T&R	Yes	NIPDAU	Level-1-260C-UNLIM	0 to 70	TL074C
<a href="#">TL074CDRG4</a>	Active	Production	SOIC (D)   14	2500   LARGE T&R	Yes	NIPDAU	Level-1-260C-UNLIM	0 to 70	TL074C
TL074CDRG4.A	Active	Production	SOIC (D)   14	2500   LARGE T&R	Yes	NIPDAU	Level-1-260C-UNLIM	0 to 70	TL074C
<a href="#">TL074CN</a>	Active	Production	PDIP (N)   14	25   TUBE	Yes	NIPDAU	N/A for Pkg Type	0 to 70	TL074CN
TL074CN.A	Active	Production	PDIP (N)   14	25   TUBE	Yes	NIPDAU	N/A for Pkg Type	0 to 70	TL074CN

Orderable part number	Status (1)	Material type (2)	Package   Pins	Package qty   Carrier	RoHS (3)	Lead finish/ Ball material (4)	MSL rating/ Peak reflow (5)	Op temp (°C)	Part marking (6)
<a href="#">TL074CNSR</a>	Active	Production	SOP (NS)   14	2000   LARGE T&R	Yes	NIPDAU	Level-1-260C-UNLIM	0 to 70	TL074
TL074CNSR.A	Active	Production	SOP (NS)   14	2000   LARGE T&R	Yes	NIPDAU	Level-1-260C-UNLIM	0 to 70	TL074
<a href="#">TL074CPW</a>	Obsolete	Production	TSSOP (PW)   14	-	-	Call TI	Call TI	0 to 70	T074
<a href="#">TL074CPWR</a>	Active	Production	TSSOP (PW)   14	2000   LARGE T&R	Yes	NIPDAU	Level-1-260C-UNLIM	0 to 70	T074
TL074CPWR.A	Active	Production	TSSOP (PW)   14	2000   LARGE T&R	Yes	NIPDAU	Level-1-260C-UNLIM	0 to 70	T074
TL074CPWRE4	Active	Production	TSSOP (PW)   14	2000   LARGE T&R	Yes	NIPDAU	Level-1-260C-UNLIM	0 to 70	T074
TL074CPWRG4	Active	Production	TSSOP (PW)   14	2000   LARGE T&R	Yes	NIPDAU	Level-1-260C-UNLIM	0 to 70	T074
<a href="#">TL074HIDR</a>	Active	Production	SOIC (D)   14	2500   LARGE T&R	Yes	NIPDAU	Level-1-260C-UNLIM	-40 to 125	TL074HID
TL074HIDR.A	Active	Production	SOIC (D)   14	2500   LARGE T&R	Yes	NIPDAU	Level-1-260C-UNLIM	-40 to 125	TL074HID
TL074HIDRG4	Active	Production	SOIC (D)   14	2500   LARGE T&R	Yes	NIPDAU	Level-1-260C-UNLIM	-40 to 125	TL074HID
TL074HIDRG4.A	Active	Production	SOIC (D)   14	2500   LARGE T&R	Yes	NIPDAU	Level-1-260C-UNLIM	-40 to 125	TL074HID
<a href="#">TL074HIDYYR</a>	Active	Production	SOT-23-THIN (DYY)   14	3000   LARGE T&R	Yes	NIPDAU	Level-1-260C-UNLIM	-40 to 125	T074HDYY
TL074HIDYYR.A	Active	Production	SOT-23-THIN (DYY)   14	3000   LARGE T&R	Yes	NIPDAU	Level-1-260C-UNLIM	-40 to 125	T074HDYY
<a href="#">TL074HIPWR</a>	Active	Production	TSSOP (PW)   14	2000   LARGE T&R	Yes	NIPDAU	Level-1-260C-UNLIM	-40 to 125	TL074PW
TL074HIPWR.A	Active	Production	TSSOP (PW)   14	2000   LARGE T&R	Yes	NIPDAU	Level-1-260C-UNLIM	-40 to 125	TL074PW
<a href="#">TL074ID</a>	Obsolete	Production	SOIC (D)   14	-	-	Call TI	Call TI	-40 to 85	TL074I
<a href="#">TL074IDR</a>	Active	Production	SOIC (D)   14	2500   LARGE T&R	Yes	NIPDAU	Level-1-260C-UNLIM	-40 to 85	TL074I
TL074IDR.A	Active	Production	SOIC (D)   14	2500   LARGE T&R	Yes	NIPDAU	Level-1-260C-UNLIM	-40 to 85	TL074I
TL074IDRE4	Active	Production	SOIC (D)   14	2500   LARGE T&R	Yes	NIPDAU	Level-1-260C-UNLIM	-40 to 85	TL074I
TL074IDRG4	Active	Production	SOIC (D)   14	2500   LARGE T&R	Yes	NIPDAU	Level-1-260C-UNLIM	-40 to 85	TL074I
<a href="#">TL074IN</a>	Active	Production	PDIP (N)   14	25   TUBE	Yes	NIPDAU	N/A for Pkg Type	-40 to 85	TL074IN
TL074IN.A	Active	Production	PDIP (N)   14	25   TUBE	Yes	NIPDAU	N/A for Pkg Type	-40 to 85	TL074IN
TL074ING4	Active	Production	PDIP (N)   14	25   TUBE	Yes	NIPDAU	N/A for Pkg Type	-40 to 85	TL074IN
TL074ING4.A	Active	Production	PDIP (N)   14	25   TUBE	Yes	NIPDAU	N/A for Pkg Type	-40 to 85	TL074IN
<a href="#">TL074MFK</a>	Active	Production	LCCC (FK)   20	55   TUBE	No	SNPB	N/A for Pkg Type	-55 to 125	TL074MFK
TL074MFK.A	Active	Production	LCCC (FK)   20	55   TUBE	No	SNPB	N/A for Pkg Type	-55 to 125	TL074MFK
TL074MFKB	Active	Production	LCCC (FK)   20	55   TUBE	No	SNPB	N/A for Pkg Type	-55 to 125	81023062A TL074MFKB
TL074MFKB.A	Active	Production	LCCC (FK)   20	55   TUBE	No	SNPB	N/A for Pkg Type	-55 to 125	81023062A TL074MFKB

Orderable part number	Status (1)	Material type (2)	Package   Pins	Package qty   Carrier	RoHS (3)	Lead finish/ Ball material (4)	MSL rating/ Peak reflow (5)	Op temp (°C)	Part marking (6)
<a href="#">TL074MJ</a>	Active	Production	CDIP (J)   14	25   TUBE	No	SNPB	N/A for Pkg Type	-55 to 125	TL074MJ
TL074MJ.A	Active	Production	CDIP (J)   14	25   TUBE	No	SNPB	N/A for Pkg Type	-55 to 125	TL074MJ
<a href="#">TL074MJB</a>	Active	Production	CDIP (J)   14	25   TUBE	No	SNPB	N/A for Pkg Type	-55 to 125	8102306CA TL074MJB
TL074MJB.A	Active	Production	CDIP (J)   14	25   TUBE	No	SNPB	N/A for Pkg Type	-55 to 125	8102306CA TL074MJB
<a href="#">TL074MWB</a>	Active	Production	CFP (W)   14	25   TUBE	No	SNPB	N/A for Pkg Type	-55 to 125	8102306DA TL074MWB
TL074MWB.A	Active	Production	CFP (W)   14	25   TUBE	No	SNPB	N/A for Pkg Type	-55 to 125	8102306DA TL074MWB

(1) **Status:** For more details on status, see our [product life cycle](#).

(2) **Material type:** When designated, preproduction parts are prototypes/experimental devices, and are not yet approved or released for full production. Testing and final process, including without limitation quality assurance, reliability performance testing, and/or process qualification, may not yet be complete, and this item is subject to further changes or possible discontinuation. If available for ordering, purchases will be subject to an additional waiver at checkout, and are intended for early internal evaluation purposes only. These items are sold without warranties of any kind.

(3) **RoHS values:** Yes, No, RoHS Exempt. See the [TI RoHS Statement](#) for additional information and value definition.

(4) **Lead finish/Ball material:** Parts may have multiple material finish options. Finish options are separated by a vertical ruled line. Lead finish/Ball material values may wrap to two lines if the finish value exceeds the maximum column width.

(5) **MSL rating/Peak reflow:** The moisture sensitivity level ratings and peak solder (reflow) temperatures. In the event that a part has multiple moisture sensitivity ratings, only the lowest level per JEDEC standards is shown. Refer to the shipping label for the actual reflow temperature that will be used to mount the part to the printed circuit board.

(6) **Part marking:** There may be an additional marking, which relates to the logo, the lot trace code information, or the environmental category of the part.

Multiple part markings will be inside parentheses. Only one part marking contained in parentheses and separated by a "~" will appear on a part. If a line is indented then it is a continuation of the previous line and the two combined represent the entire part marking for that device.

**Important Information and Disclaimer:** The information provided on this page represents TI's knowledge and belief as of the date that it is provided. TI bases its knowledge and belief on information provided by third parties, and makes no representation or warranty as to the accuracy of such information. Efforts are underway to better integrate information from third parties. TI has taken and continues to take reasonable steps to provide representative and accurate information but may not have conducted destructive testing or chemical analysis on incoming materials and chemicals. TI and TI suppliers consider certain information to be proprietary, and thus CAS numbers and other limited information may not be available for release.

In no event shall TI's liability arising out of such information exceed the total purchase price of the TI part(s) at issue in this document sold by TI to Customer on an annual basis.

**OTHER QUALIFIED VERSIONS OF TL072, TL072M, TL074, TL074M :**

- Catalog : [TL072](#), [TL074](#)
- Enhanced Product : [TL072-EP](#), [TL072-EP](#), [TL074-EP](#), [TL074-EP](#)
- Military : [TL072M](#), [TL074M](#)

NOTE: Qualified Version Definitions:

- Catalog - TI's standard catalog product
- Enhanced Product - Supports Defense, Aerospace and Medical Applications
- Military - QML certified for Military and Defense Applications

**TAPE AND REEL INFORMATION**

**QUADRANT ASSIGNMENTS FOR PIN 1 ORIENTATION IN TAPE**

\*All dimensions are nominal

Device	Package Type	Package Drawing	Pins	SPQ	Reel Diameter (mm)	Reel Width W1 (mm)	A0 (mm)	B0 (mm)	K0 (mm)	P1 (mm)	W (mm)	Pin1 Quadrant
TL071ACDR	SOIC	D	8	2500	330.0	12.4	6.4	5.2	2.1	8.0	12.0	Q1
TL071BCDR	SOIC	D	8	2500	330.0	12.4	6.4	5.2	2.1	8.0	12.0	Q1
TL071CDR	SOIC	D	8	2500	330.0	12.4	6.4	5.2	2.1	8.0	12.0	Q1
TL071CPSR	SO	PS	8	2000	330.0	16.4	8.35	6.6	2.4	12.0	16.0	Q1
TL071HIDBVR	SOT-23	DBV	5	3000	180.0	8.4	3.2	3.2	1.4	4.0	8.0	Q3
TL071HIDBVRG4	SOT-23	DBV	5	3000	180.0	8.4	3.2	3.2	1.4	4.0	8.0	Q3
TL071HIDCKR	SC70	DCK	5	3000	178.0	9.0	2.4	2.5	1.2	4.0	8.0	Q3
TL071HIDR	SOIC	D	8	3000	330.0	12.4	6.4	5.2	2.1	8.0	12.0	Q1
TL071IDR	SOIC	D	8	2500	330.0	12.4	6.4	5.2	2.1	8.0	12.0	Q1
TL071IDR1G4	SOIC	D	8	2500	330.0	12.4	6.4	5.2	2.1	8.0	12.0	Q1
TL072ACDR	SOIC	D	8	2500	330.0	12.4	6.4	5.2	2.1	8.0	12.0	Q1
TL072BCDR	SOIC	D	8	2500	330.0	12.4	6.4	5.2	2.1	8.0	12.0	Q1
TL072CDR	SOIC	D	8	2500	330.0	12.4	6.4	5.2	2.1	8.0	12.0	Q1
TL072CPSR	SO	PS	8	2000	330.0	16.4	8.35	6.6	2.4	12.0	16.0	Q1
TL072CPWR	TSSOP	PW	8	2000	330.0	12.4	7.0	3.6	1.6	8.0	12.0	Q1

Device	Package Type	Package Drawing	Pins	SPQ	Reel Diameter (mm)	Reel Width W1 (mm)	A0 (mm)	B0 (mm)	K0 (mm)	P1 (mm)	W (mm)	Pin1 Quadrant
TL072HIDDFR	SOT-23-THIN	DDF	8	3000	180.0	8.4	3.2	3.2	1.4	4.0	8.0	Q3
TL072HIDR	SOIC	D	8	3000	330.0	12.4	6.4	5.2	2.1	8.0	12.0	Q1
TL072HIDR	SOIC	D	8	3000	330.0	12.4	6.5	5.4	2.0	8.0	12.0	Q1
TL072HIPWR	TSSOP	PW	8	3000	330.0	12.4	7.0	3.6	1.6	8.0	12.0	Q1
TL072IDR	SOIC	D	8	2500	330.0	12.4	6.4	5.2	2.1	8.0	12.0	Q1
TL074ACDR	SOIC	D	14	2500	330.0	16.4	6.5	9.0	2.1	8.0	16.0	Q1
TL074ACNSR	SOP	NS	14	2000	330.0	16.4	8.1	10.4	2.5	12.0	16.0	Q1
TL074BCDR	SOIC	D	14	2500	330.0	16.4	6.5	9.0	2.1	8.0	16.0	Q1
TL074CDBR	SSOP	DB	14	2000	330.0	16.4	8.35	6.6	2.4	12.0	16.0	Q1
TL074CDR	SOIC	D	14	2500	330.0	16.4	6.5	9.0	2.1	8.0	16.0	Q1
TL074CDR	SOIC	D	14	2500	330.0	16.4	6.5	9.35	2.3	8.0	16.0	Q1
TL074CDRG4	SOIC	D	14	2500	330.0	16.4	6.5	9.0	2.1	8.0	16.0	Q1
TL074CNSR	SOP	NS	14	2000	330.0	16.4	8.45	10.55	2.5	12.0	16.2	Q1
TL074CPWR	TSSOP	PW	14	2000	330.0	12.4	6.9	5.6	1.6	8.0	12.0	Q1
TL074CPWR	TSSOP	PW	14	2000	330.0	12.4	6.9	5.6	1.6	8.0	12.0	Q1
TL074HIDR	SOIC	D	14	2500	330.0	16.4	6.5	9.0	2.1	8.0	16.0	Q1
TL074HIDR	SOIC	D	14	2500	330.0	16.4	6.5	9.35	2.3	8.0	16.0	Q1
TL074HIDRG4	SOIC	D	14	2500	330.0	16.4	6.5	9.0	2.1	8.0	16.0	Q1
TL074HIDYYR	SOT-23-THIN	DYY	14	3000	330.0	12.4	4.8	3.6	1.6	8.0	12.0	Q3
TL074HIPWR	TSSOP	PW	14	2000	330.0	12.4	6.9	5.6	1.6	8.0	12.0	Q1
TL074IDR	SOIC	D	14	2500	330.0	16.4	6.5	9.0	2.1	8.0	16.0	Q1

**TAPE AND REEL BOX DIMENSIONS**

\*All dimensions are nominal

Device	Package Type	Package Drawing	Pins	SPQ	Length (mm)	Width (mm)	Height (mm)
TL071ACDR	SOIC	D	8	2500	340.5	338.1	20.6
TL071BCDR	SOIC	D	8	2500	340.5	338.1	20.6
TL071CDR	SOIC	D	8	2500	353.0	353.0	32.0
TL071CPSR	SO	PS	8	2000	353.0	353.0	32.0
TL071HIDBVR	SOT-23	DBV	5	3000	210.0	185.0	35.0
TL071HIDBVRG4	SOT-23	DBV	5	3000	210.0	185.0	35.0
TL071HIDCKR	SC70	DCK	5	3000	190.0	190.0	30.0
TL071HIDR	SOIC	D	8	3000	353.0	353.0	32.0
TL071IDR	SOIC	D	8	2500	353.0	353.0	32.0
TL071IDR1G4	SOIC	D	8	2500	353.0	353.0	32.0
TL072ACDR	SOIC	D	8	2500	353.0	353.0	32.0
TL072BCDR	SOIC	D	8	2500	353.0	353.0	32.0
TL072CDR	SOIC	D	8	2500	353.0	353.0	32.0
TL072CPSR	SO	PS	8	2000	353.0	353.0	32.0
TL072CPWR	TSSOP	PW	8	2000	353.0	353.0	32.0
TL072HIDDFR	SOT-23-THIN	DDF	8	3000	210.0	185.0	35.0
TL072HIDR	SOIC	D	8	3000	353.0	353.0	32.0
TL072HIDR	SOIC	D	8	3000	367.0	367.0	35.0

Device	Package Type	Package Drawing	Pins	SPQ	Length (mm)	Width (mm)	Height (mm)
TL072HIPWR	TSSOP	PW	8	3000	353.0	353.0	32.0
TL072IDR	SOIC	D	8	2500	353.0	353.0	32.0
TL074ACDR	SOIC	D	14	2500	353.0	353.0	32.0
TL074ACNSR	SOP	NS	14	2000	353.0	353.0	32.0
TL074BCDR	SOIC	D	14	2500	353.0	353.0	32.0
TL074CDBR	SSOP	DB	14	2000	353.0	353.0	32.0
TL074CDR	SOIC	D	14	2500	353.0	353.0	32.0
TL074CDR	SOIC	D	14	2500	367.0	367.0	35.0
TL074CDRG4	SOIC	D	14	2500	340.5	336.1	32.0
TL074CNSR	SOP	NS	14	2000	353.0	353.0	32.0
TL074CPWR	TSSOP	PW	14	2000	353.0	353.0	32.0
TL074CPWR	TSSOP	PW	14	2000	353.0	353.0	32.0
TL074HIDR	SOIC	D	14	2500	353.0	353.0	32.0
TL074HIDR	SOIC	D	14	2500	367.0	367.0	35.0
TL074HIDRG4	SOIC	D	14	2500	353.0	353.0	32.0
TL074HIDYYR	SOT-23-THIN	DYY	14	3000	336.6	336.6	31.8
TL074HIPWR	TSSOP	PW	14	2000	353.0	353.0	32.0
TL074IDR	SOIC	D	14	2500	353.0	353.0	32.0

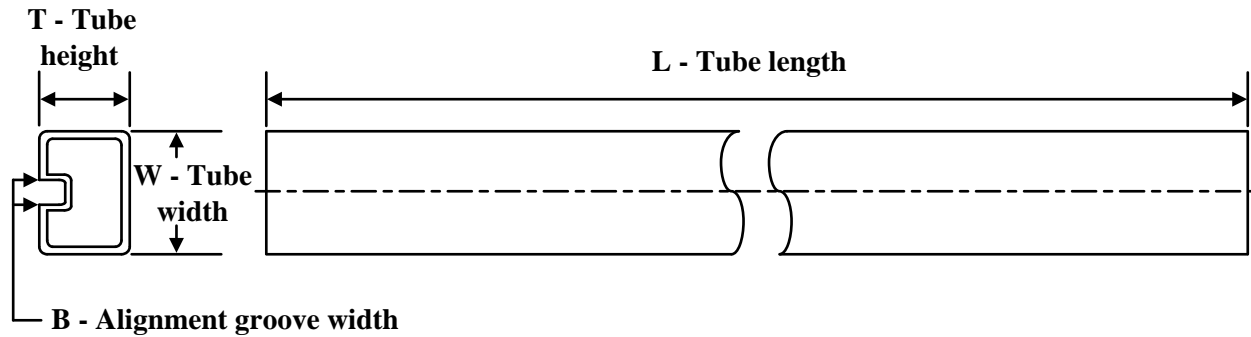
**TUBE**

\*All dimensions are nominal

Device	Package Name	Package Type	Pins	SPQ	L (mm)	W (mm)	T (µm)	B (mm)
81023052A	FK	LCCC	20	55	506.98	12.06	2030	NA
8102305HA	U	CFP	10	25	506.98	26.16	6220	NA
81023062A	FK	LCCC	20	55	506.98	12.06	2030	NA
8102306DA	W	CFP	14	25	506.98	26.16	6220	NA
TL071ACP	P	PDIP	8	50	506	13.97	11230	4.32
TL071ACP.A	P	PDIP	8	50	506	13.97	11230	4.32
TL071BCP	P	PDIP	8	50	506	13.97	11230	4.32
TL071BCP.A	P	PDIP	8	50	506	13.97	11230	4.32
TL071CP	P	PDIP	8	50	506	13.97	11230	4.32
TL071CP.A	P	PDIP	8	50	506	13.97	11230	4.32
TL071IP	P	PDIP	8	50	506	13.97	11230	4.32
TL071IP.A	P	PDIP	8	50	506	13.97	11230	4.32
TL072ACP	P	PDIP	8	50	506	13.97	11230	4.32
TL072ACP.A	P	PDIP	8	50	506	13.97	11230	4.32
TL072ACPS	PS	SOP	8	80	530	10.5	4000	4.1
TL072ACPS.A	PS	SOP	8	80	530	10.5	4000	4.1
TL072BCP	P	PDIP	8	50	506	13.97	11230	4.32
TL072BCP.A	P	PDIP	8	50	506	13.97	11230	4.32
TL072CP	P	PDIP	8	50	506	13.97	11230	4.32
TL072CP.A	P	PDIP	8	50	506	13.97	11230	4.32
TL072CPS	PS	SOP	8	80	530	10.5	4000	4.1
TL072CPS.A	PS	SOP	8	80	530	10.5	4000	4.1
TL072IP	P	PDIP	8	50	506	13.97	11230	4.32
TL072IP.A	P	PDIP	8	50	506	13.97	11230	4.32
TL072MFKB	FK	LCCC	20	55	506.98	12.06	2030	NA
TL072MFKB.A	FK	LCCC	20	55	506.98	12.06	2030	NA
TL072MUB	U	CFP	10	25	506.98	26.16	6220	NA
TL072MUB.A	U	CFP	10	25	506.98	26.16	6220	NA
TL074ACN	N	PDIP	14	25	506	13.97	11230	4.32

Device	Package Name	Package Type	Pins	SPQ	L (mm)	W (mm)	T (µm)	B (mm)
TL074ACN	N	PDIP	14	25	506	13.97	11230	4.32
TL074ACN.A	N	PDIP	14	25	506	13.97	11230	4.32
TL074ACN.A	N	PDIP	14	25	506	13.97	11230	4.32
TL074BCN	N	PDIP	14	25	506	13.97	11230	4.32
TL074BCN	N	PDIP	14	25	506	13.97	11230	4.32
TL074BCN.A	N	PDIP	14	25	506	13.97	11230	4.32
TL074BCN.A	N	PDIP	14	25	506	13.97	11230	4.32
TL074CN	N	PDIP	14	25	506	13.97	11230	4.32
TL074CN.A	N	PDIP	14	25	506	13.97	11230	4.32
TL074IN	N	PDIP	14	25	506	13.97	11230	4.32
TL074IN.A	N	PDIP	14	25	506	13.97	11230	4.32
TL074ING4	N	PDIP	14	25	506	13.97	11230	4.32
TL074ING4.A	N	PDIP	14	25	506	13.97	11230	4.32
TL074MFK	FK	LCCC	20	55	506.98	12.06	2030	NA
TL074MFK.A	FK	LCCC	20	55	506.98	12.06	2030	NA
TL074MFKB	FK	LCCC	20	55	506.98	12.06	2030	NA
TL074MFKB.A	FK	LCCC	20	55	506.98	12.06	2030	NA
TL074MWB	W	CFP	14	25	506.98	26.16	6220	NA
TL074MWB.A	W	CFP	14	25	506.98	26.16	6220	NA

# PACKAGE OUTLINE

## JG0008A

### CDIP - 5.08 mm max height

CERAMIC DUAL IN-LINE PACKAGE



#### NOTES:

1. All linear dimensions are in millimeters. Any dimensions in parenthesis are for reference only. Dimensioning and tolerancing per ASME Y14.5M.
2. This drawing is subject to change without notice.
3. This package can be hermetically sealed with a ceramic lid using glass frit.
4. Index point is provided on cap for terminal identification.
5. Falls within MIL STD 1835 GDIP1-T8

# EXAMPLE BOARD LAYOUT

JG0008A

CDIP - 5.08 mm max height

CERAMIC DUAL IN-LINE PACKAGE

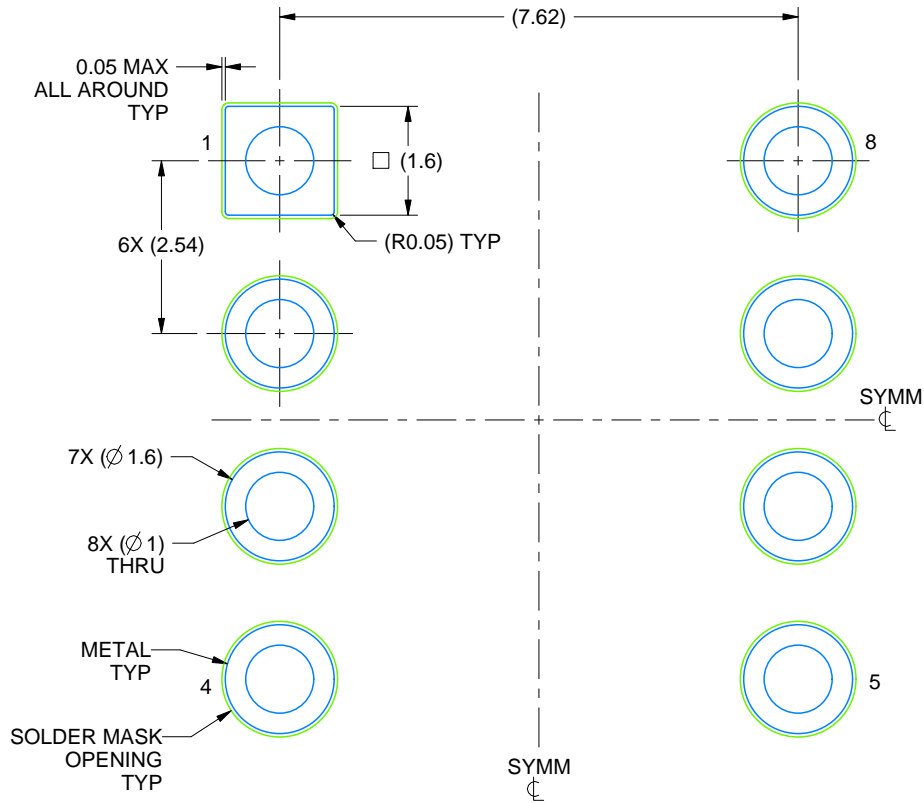

LAND PATTERN EXAMPLE  
NON SOLDER MASK DEFINED  
SCALE: 9X

4230036/A 09/2023



# DBV0005A



# PACKAGE OUTLINE

SOT-23 - 1.45 mm max height

SMALL OUTLINE TRANSISTOR

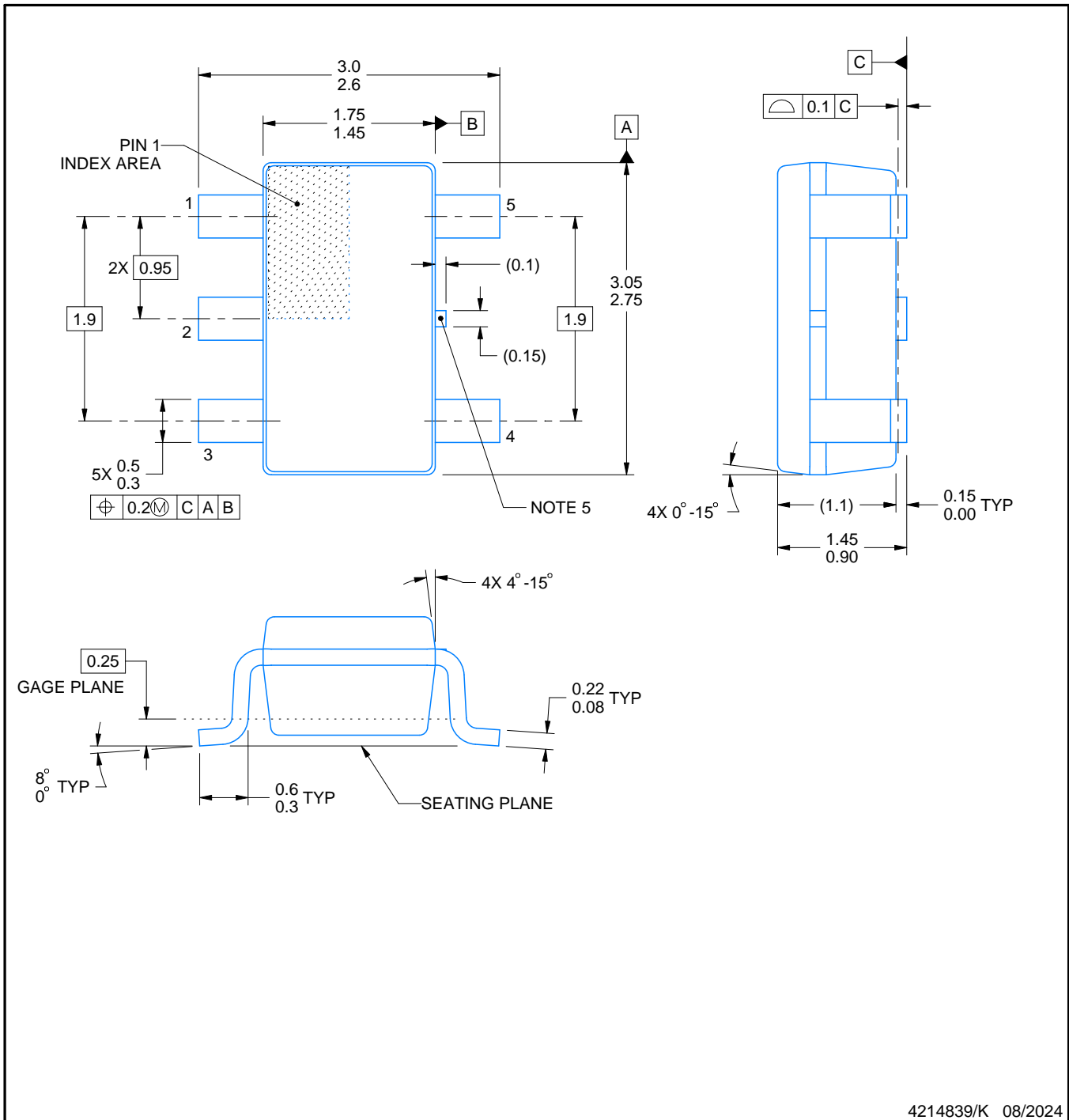

4214839/K 08/2024

## NOTES:

1. All linear dimensions are in millimeters. Any dimensions in parenthesis are for reference only. Dimensioning and tolerancing per ASME Y14.5M.
2. This drawing is subject to change without notice.
3. Reference JEDEC MO-178.
4. Body dimensions do not include mold flash, protrusions, or gate burrs. Mold flash, protrusions, or gate burrs shall not exceed 0.25 mm per side.
5. Support pin may differ or may not be present.

# EXAMPLE BOARD LAYOUT

DBV0005A

SOT-23 - 1.45 mm max height

SMALL OUTLINE TRANSISTOR



LAND PATTERN EXAMPLE  
EXPOSED METAL SHOWN  
SCALE:15X



SOLDER MASK DETAILS

4214839/K 08/2024

NOTES: (continued)

- 6. Publication IPC-7351 may have alternate designs.
- 7. Solder mask tolerances between and around signal pads can vary based on board fabrication site.

# EXAMPLE STENCIL DESIGN

DBV0005A

SOT-23 - 1.45 mm max height

SMALL OUTLINE TRANSISTOR



SOLDER PASTE EXAMPLE  
BASED ON 0.125 mm THICK STENCIL  
SCALE:15X

4214839/K 08/2024

NOTES: (continued)

8. Laser cutting apertures with trapezoidal walls and rounded corners may offer better paste release. IPC-7525 may have alternate design recommendations.
9. Board assembly site may have different recommendations for stencil design.

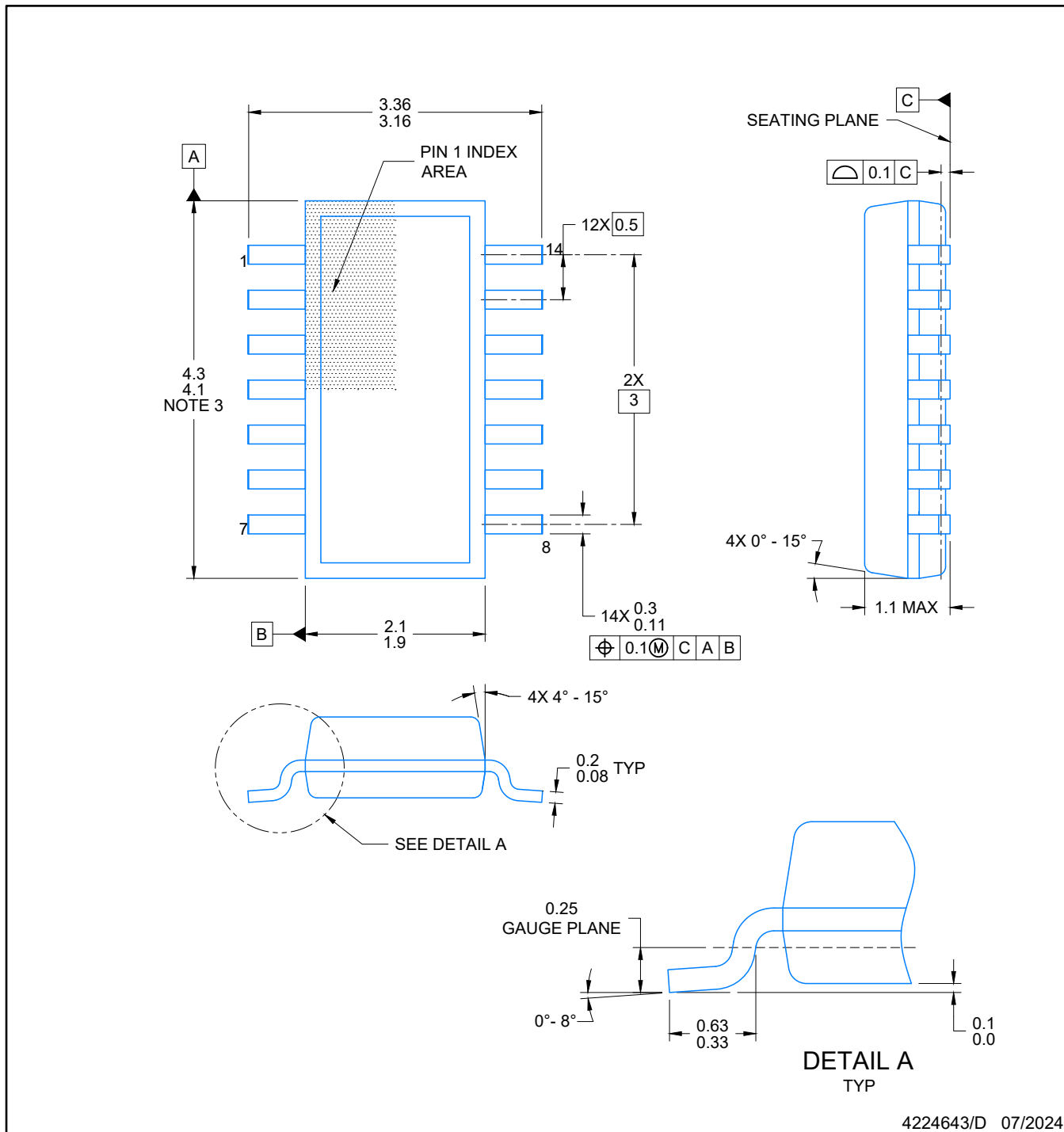

4224643/D 07/2024

NOTES:

1. All linear dimensions are in millimeters. Any dimensions in parenthesis are for reference only. Dimensioning and tolerancing per ASME Y14.5M.
2. This drawing is subject to change without notice.
3. This dimension does not include mold flash, protrusions, or gate burrs. Mold flash, protrusions, or gate burrs shall not exceed 0.15 per side.
4. This dimension does not include interlead flash. Interlead flash shall not exceed 0.50 per side.
5. Reference JEDEC Registration MO-345, Variation AB

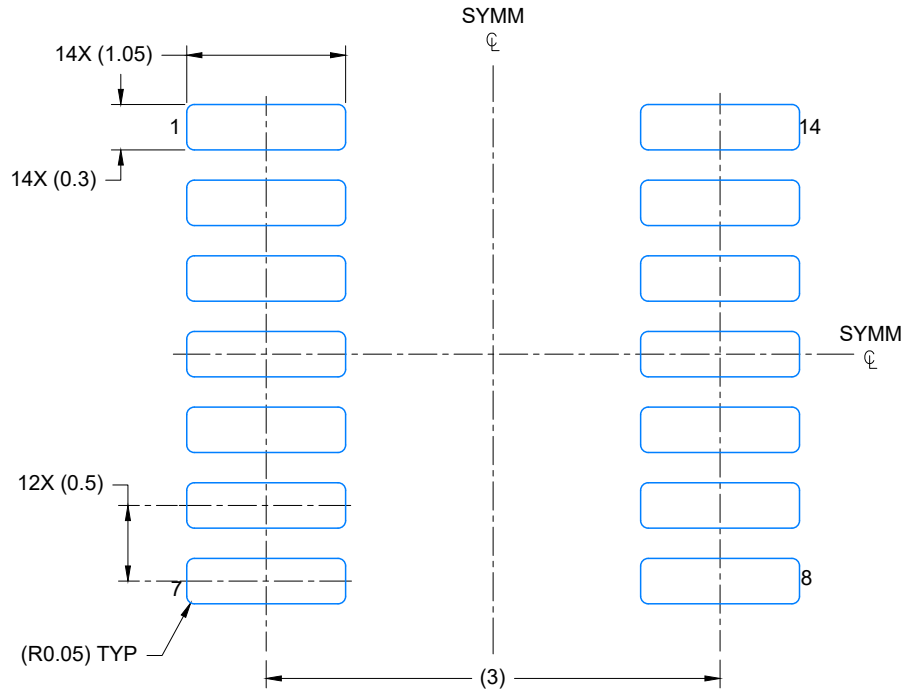

LAND PATTERN EXAMPLE  
EXPOSED METAL SHOWN  
SCALE: 20X

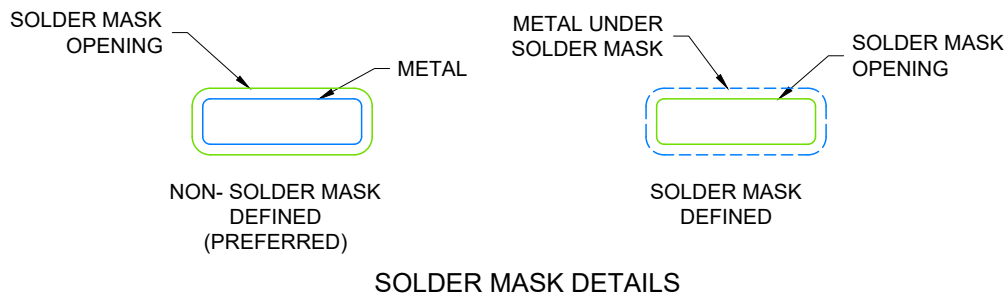

4224643/D 07/2024

NOTES: (continued)

- 6. Publication IPC-7351 may have alternate designs.
- 7. Solder mask tolerances between and around signal pads can vary based on board fabrication site.

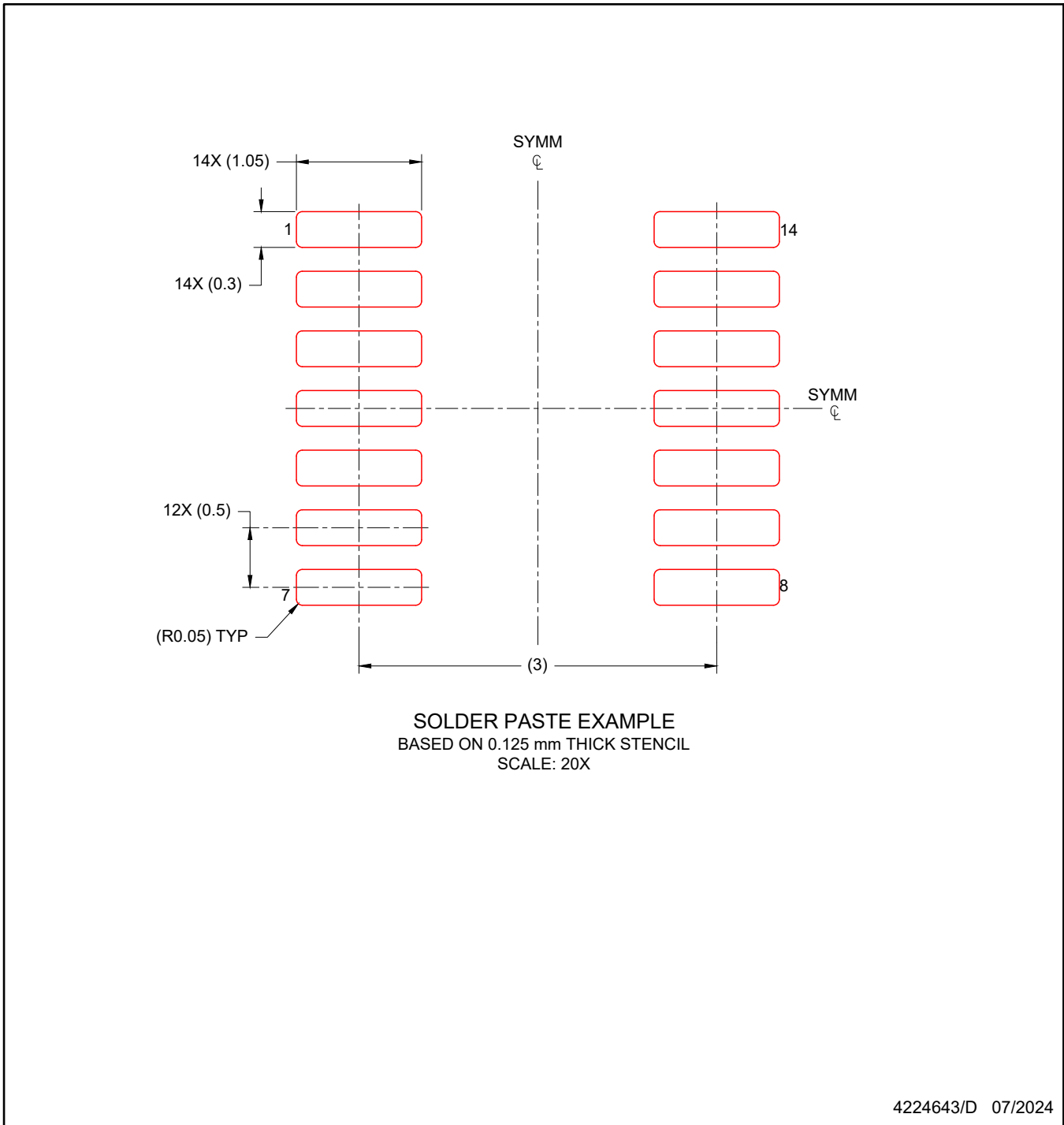

NOTES: (continued)

8. Laser cutting apertures with trapezoidal walls and rounded corners may offer better paste release. IPC-7525 may have alternate design recommendations.
9. Board assembly site may have different recommendations for stencil design.

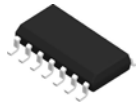

# D0014A

# PACKAGE OUTLINE

## SOIC - 1.75 mm max height

SMALL OUTLINE INTEGRATED CIRCUIT



4220718/A 09/2016

### NOTES:

1. All linear dimensions are in millimeters. Dimensions in parenthesis are for reference only. Dimensioning and tolerancing per ASME Y14.5M.
2. This drawing is subject to change without notice.
3. This dimension does not include mold flash, protrusions, or gate burrs. Mold flash, protrusions, or gate burrs shall not exceed 0.15 mm, per side.
4. This dimension does not include interlead flash. Interlead flash shall not exceed 0.43 mm, per side.
5. Reference JEDEC registration MS-012, variation AB.

# EXAMPLE BOARD LAYOUT

D0014A

SOIC - 1.75 mm max height

SMALL OUTLINE INTEGRATED CIRCUIT



LAND PATTERN EXAMPLE  
SCALE:8X



SOLDER MASK DETAILS

4220718/A 09/2016

NOTES: (continued)

- 6. Publication IPC-7351 may have alternate designs.
- 7. Solder mask tolerances between and around signal pads can vary based on board fabrication site.

# EXAMPLE STENCIL DESIGN

D0014A

SOIC - 1.75 mm max height

SMALL OUTLINE INTEGRATED CIRCUIT



SOLDER PASTE EXAMPLE  
BASED ON 0.125 mm THICK STENCIL  
SCALE:8X

4220718/A 09/2016

NOTES: (continued)

8. Laser cutting apertures with trapezoidal walls and rounded corners may offer better paste release. IPC-7525 may have alternate design recommendations.
9. Board assembly site may have different recommendations for stencil design.

# MECHANICAL DATA

NS (R-PDSO-G\*\*)

PLASTIC SMALL-OUTLINE PACKAGE

14-PINS SHOWN

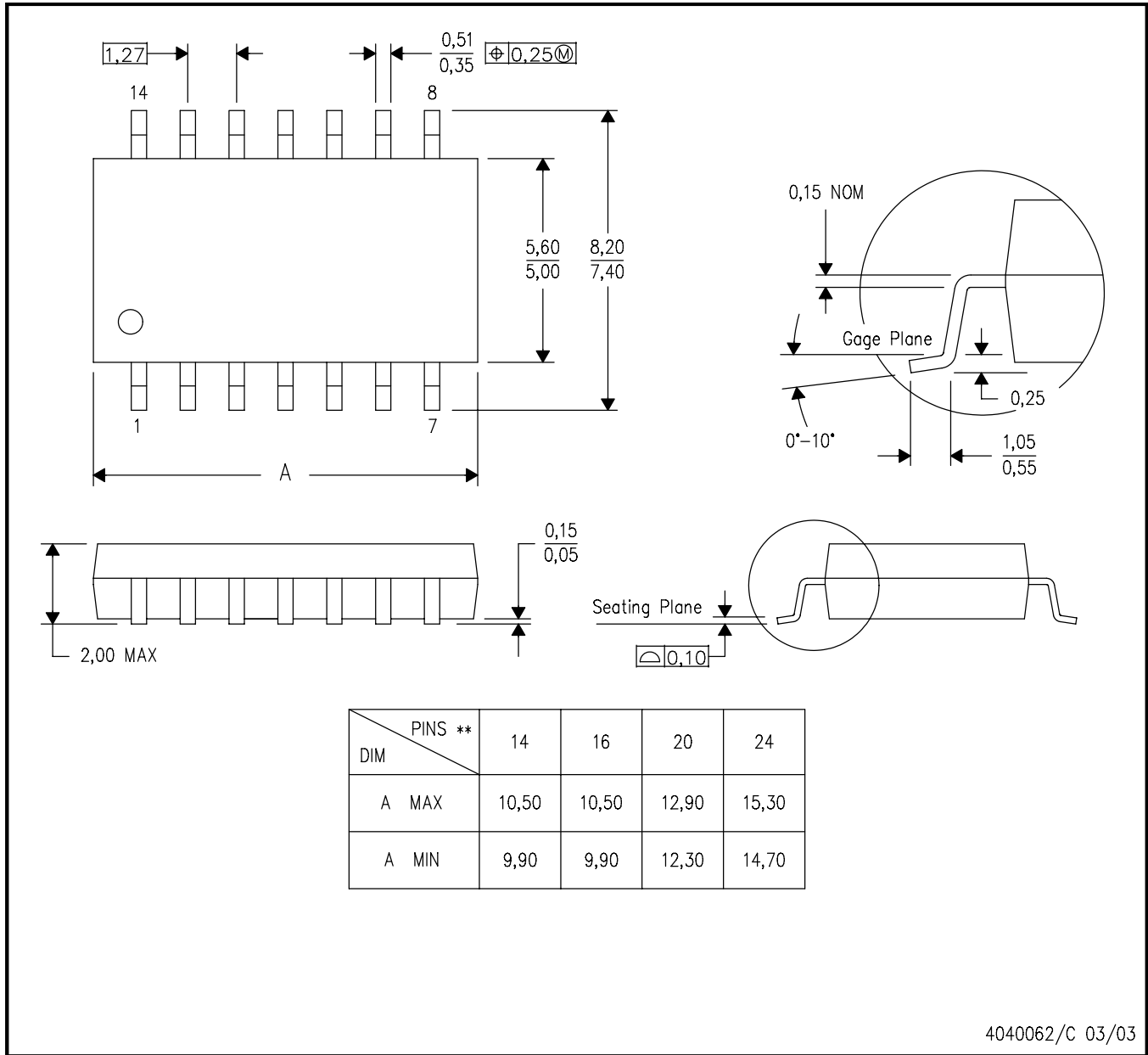

- NOTES:
- A. All linear dimensions are in millimeters.
  - B. This drawing is subject to change without notice.
  - C. Body dimensions do not include mold flash or protrusion, not to exceed 0,15.

W (R-GDFP-F14)

CERAMIC DUAL FLATPACK

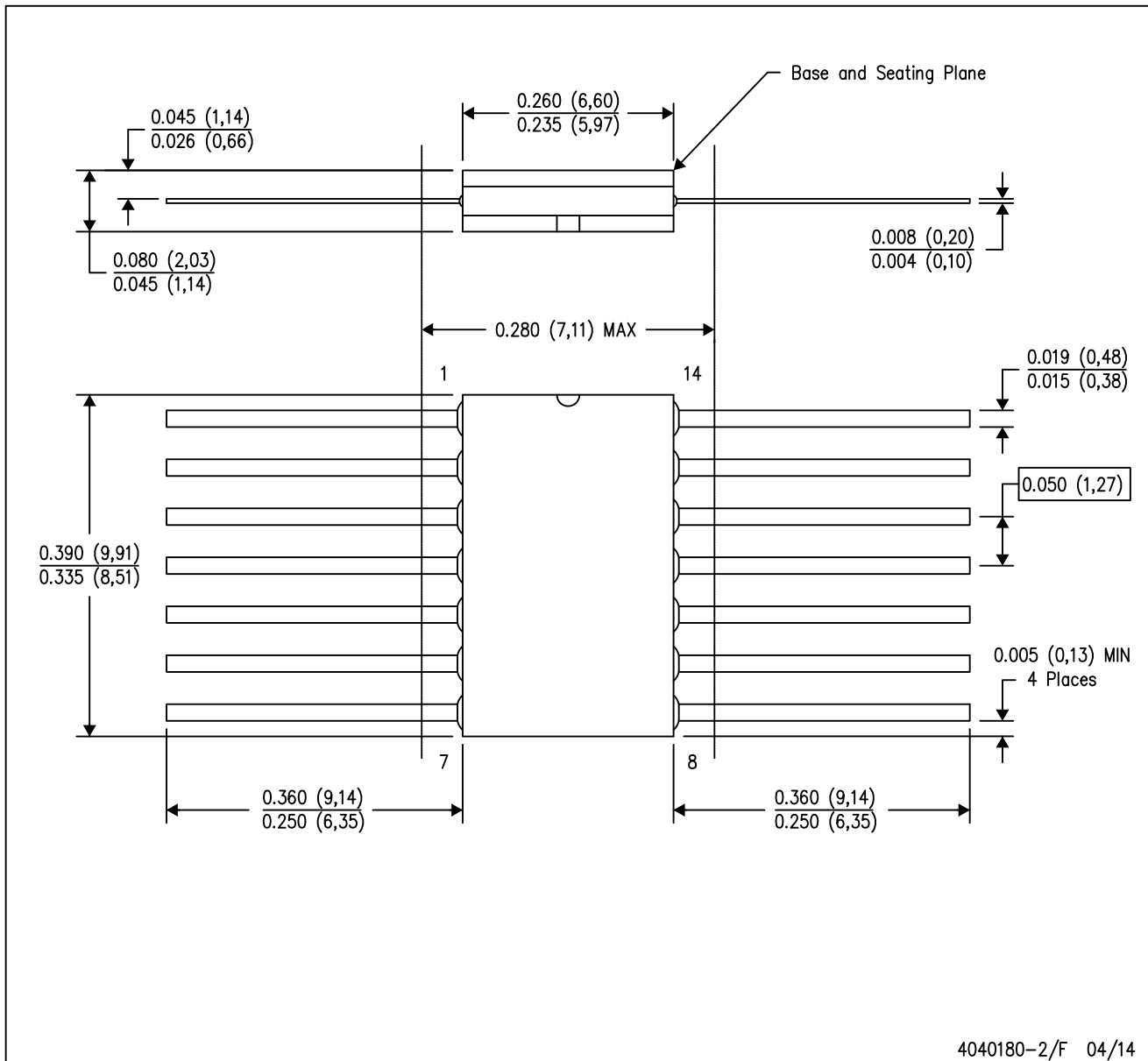

4040180-2/F 04/14

- NOTES:
- A. All linear dimensions are in inches (millimeters).
  - B. This drawing is subject to change without notice.
  - C. This package can be hermetically sealed with a ceramic lid using glass frit.
  - D. Index point is provided on cap for terminal identification only.
  - E. Falls within MIL STD 1835 GDFP1-F14

# DB0014A



# PACKAGE OUTLINE

## SSOP - 2 mm max height

SMALL OUTLINE PACKAGE

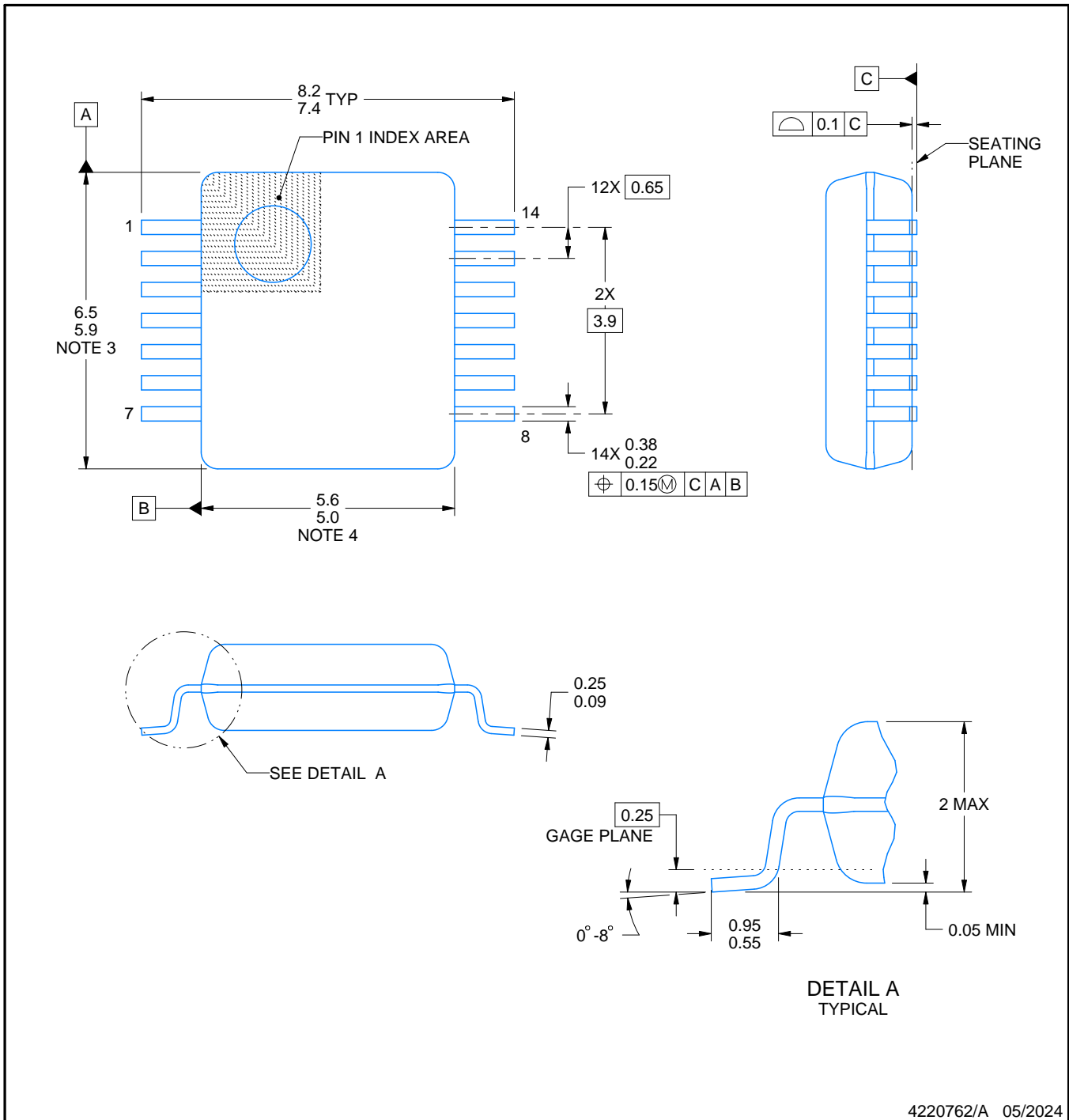

4220762/A 05/2024

### NOTES:

- All linear dimensions are in millimeters. Any dimensions in parenthesis are for reference only. Dimensioning and tolerancing per ASME Y14.5M.
- This drawing is subject to change without notice.
- This dimension does not include mold flash, protrusions, or gate burrs. Mold flash, protrusions, or gate burrs shall not exceed 0.15 mm per side.
- Reference JEDEC registration MO-150.

# EXAMPLE BOARD LAYOUT

DB0014A

SSOP - 2 mm max height

SMALL OUTLINE PACKAGE

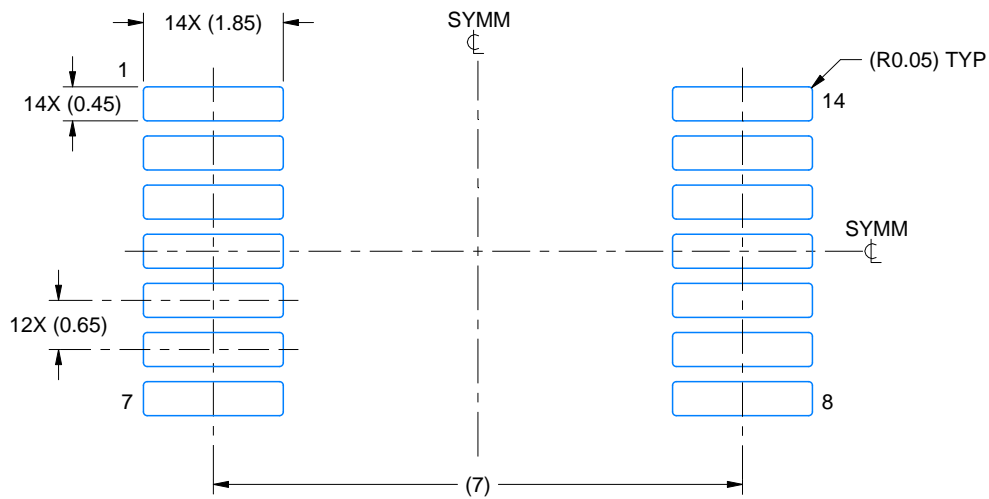

LAND PATTERN EXAMPLE  
EXPOSED METAL SHOWN  
SCALE: 10X

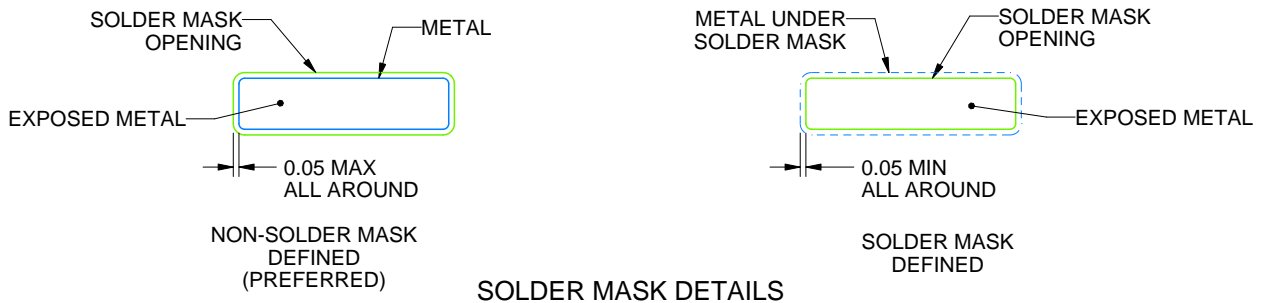

4220762/A 05/2024

NOTES: (continued)

- 5. Publication IPC-7351 may have alternate designs.
- 6. Solder mask tolerances between and around signal pads can vary based on board fabrication site.

# EXAMPLE STENCIL DESIGN

DB0014A

SSOP - 2 mm max height

SMALL OUTLINE PACKAGE

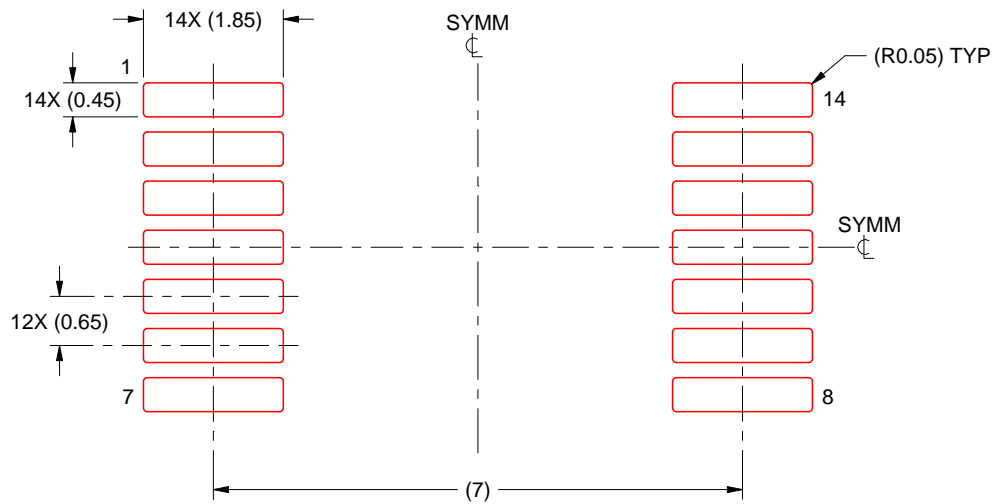

SOLDER PASTE EXAMPLE  
BASED ON 0.125 mm THICK STENCIL  
SCALE: 10X

4220762/A 05/2024

NOTES: (continued)

7. Laser cutting apertures with trapezoidal walls and rounded corners may offer better paste release. IPC-7525 may have alternate design recommendations.
8. Board assembly site may have different recommendations for stencil design.

## GENERIC PACKAGE VIEW

**FK 20**

**LCCC - 2.03 mm max height**

8.89 x 8.89, 1.27 mm pitch

LEADLESS CERAMIC CHIP CARRIER

This image is a representation of the package family, actual package may vary.  
Refer to the product data sheet for package details.

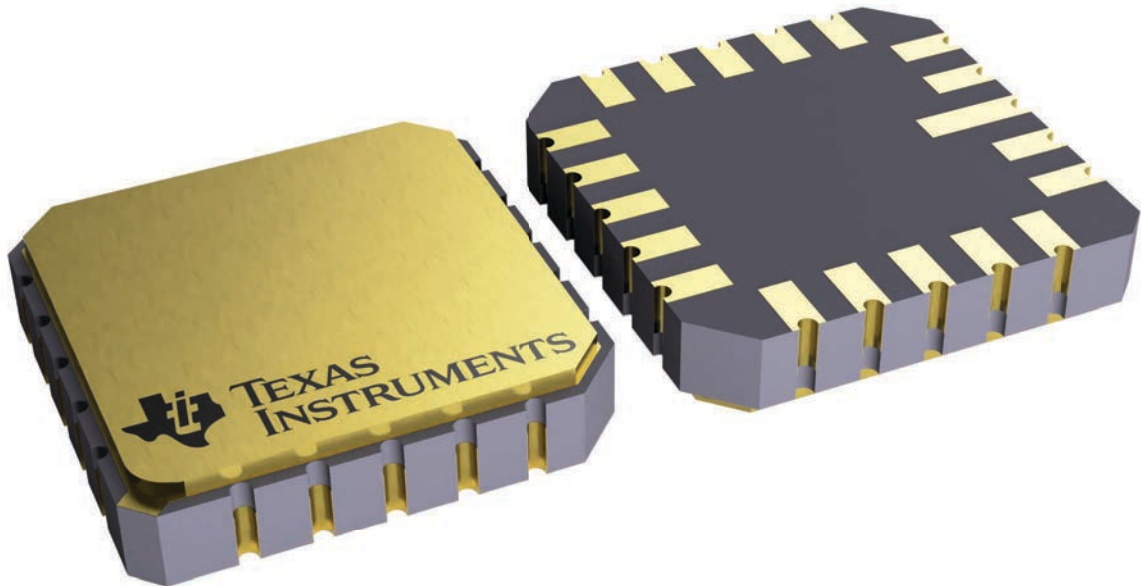

4229370VA\

J 14

**GENERIC PACKAGE VIEW**  
**CDIP - 5.08 mm max height**  
CERAMIC DUAL IN LINE PACKAGE

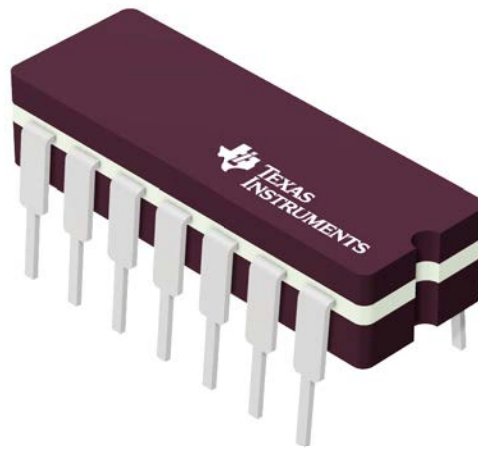

Images above are just a representation of the package family, actual package may vary.  
Refer to the product data sheet for package details.

4040083-5/G

J0014A

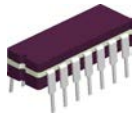

# PACKAGE OUTLINE

CDIP - 5.08 mm max height

CERAMIC DUAL IN LINE PACKAGE

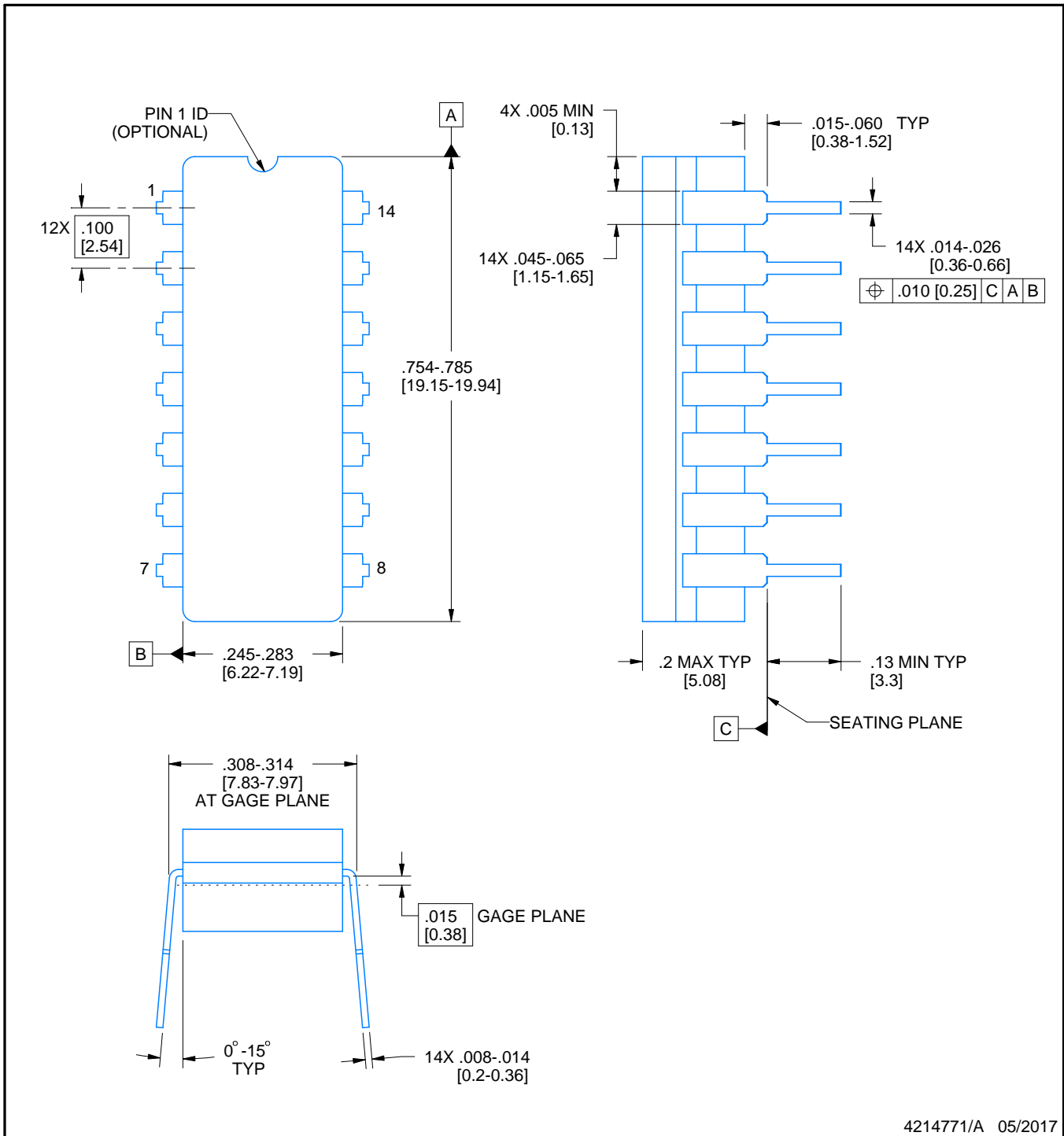

4214771/A 05/2017

NOTES:

1. All controlling linear dimensions are in inches. Dimensions in brackets are in millimeters. Any dimension in brackets or parenthesis are for reference only. Dimensioning and tolerancing per ASME Y14.5M.
2. This drawing is subject to change without notice.
3. This package is hermetically sealed with a ceramic lid using glass frit.
4. Index point is provided on cap for terminal identification only and on press ceramic glass frit seal only.
5. Falls within MIL-STD-1835 and GDIP1-T14.

# EXAMPLE BOARD LAYOUT

J0014A

CDIP - 5.08 mm max height

CERAMIC DUAL IN LINE PACKAGE

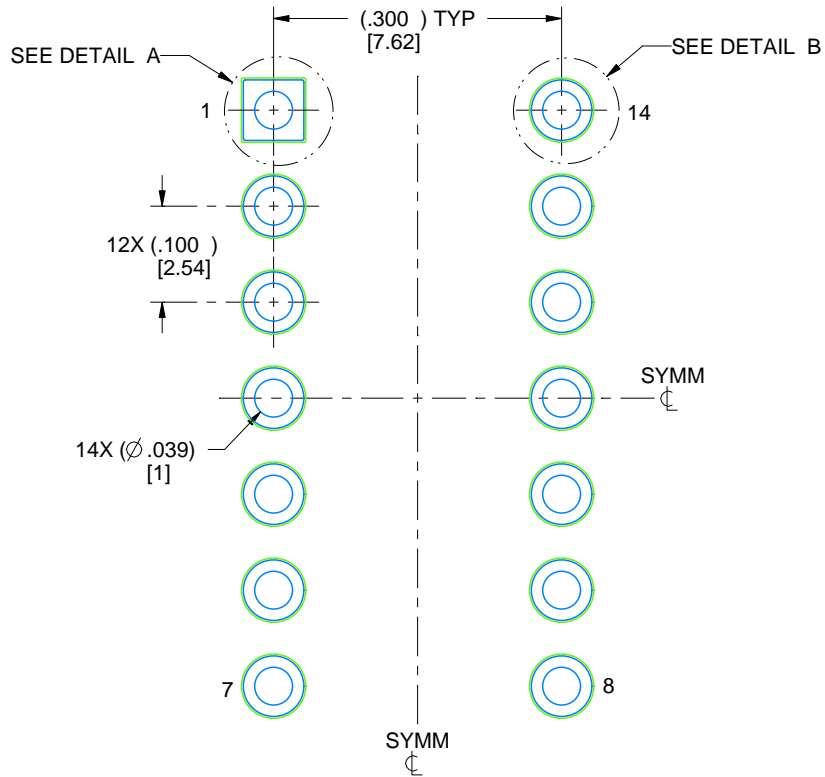

LAND PATTERN EXAMPLE  
NON-SOLDER MASK DEFINED  
SCALE: 5X

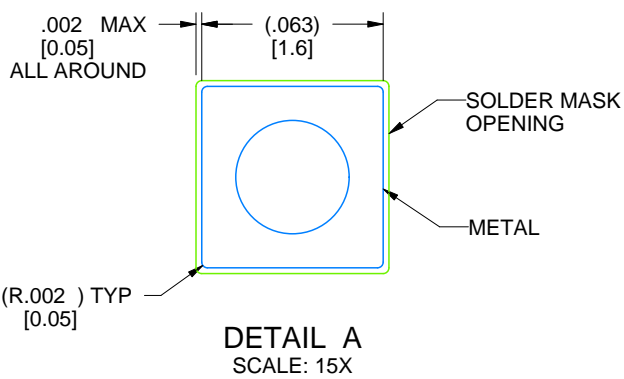

DETAIL A  
SCALE: 15X

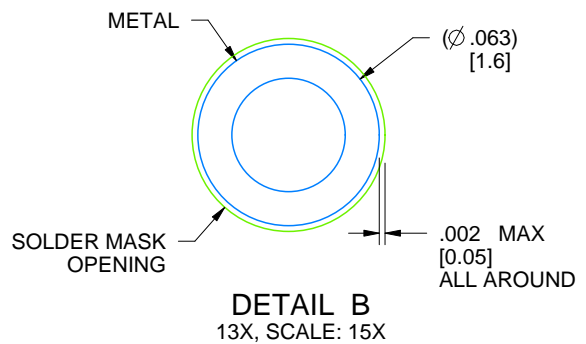

DETAIL B  
13X, SCALE: 15X

4214771/A 05/2017

# DCK0005A



# PACKAGE OUTLINE

SOT - 1.1 max height

SMALL OUTLINE TRANSISTOR

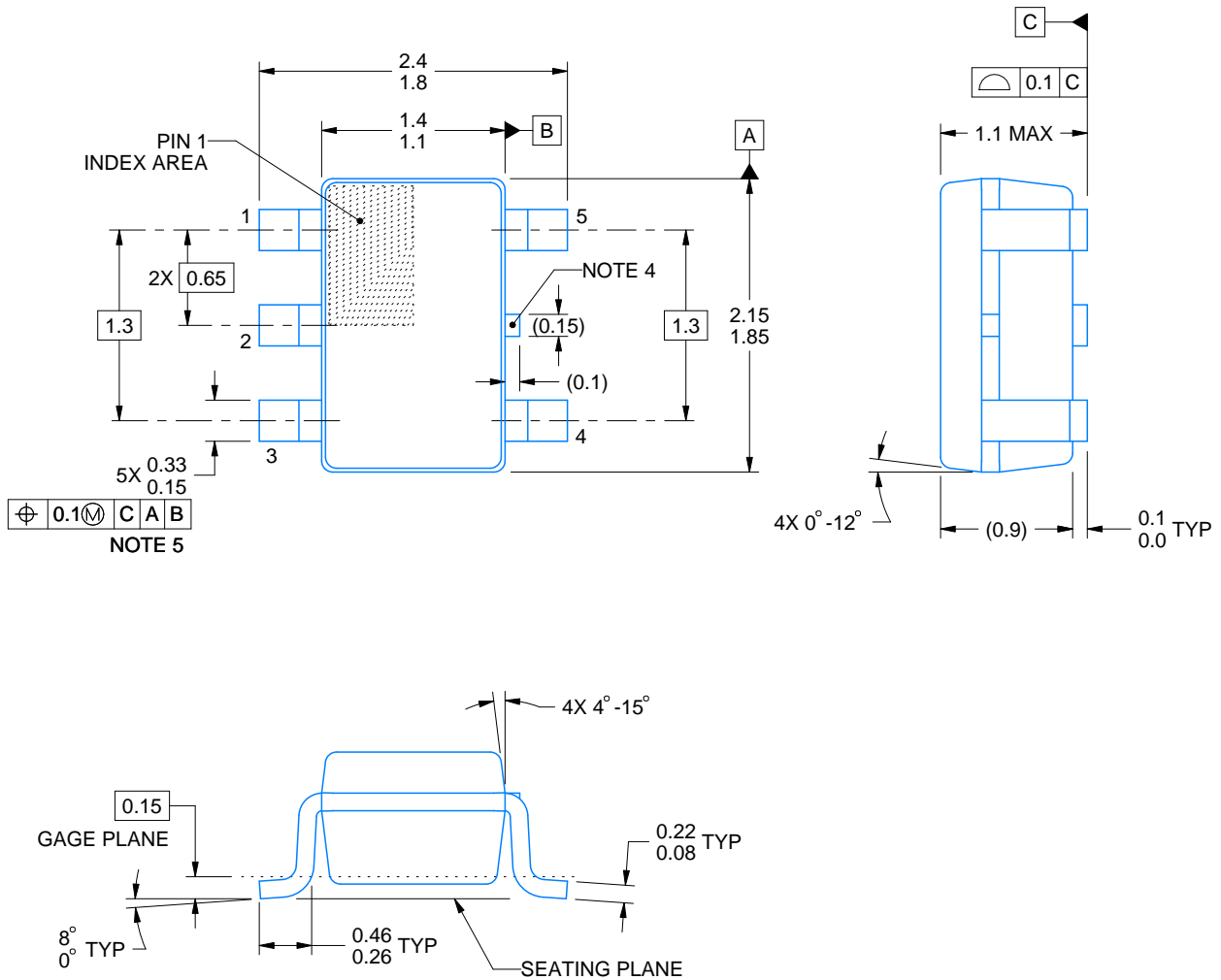

4214834/G 11/2024

## NOTES:

1. All linear dimensions are in millimeters. Any dimensions in parenthesis are for reference only. Dimensioning and tolerancing per ASME Y14.5M.
2. This drawing is subject to change without notice.
3. Reference JEDEC MO-203.
4. Support pin may differ or may not be present.
5. Lead width does not comply with JEDEC.
6. Body dimensions do not include mold flash, protrusions, or gate burrs. Mold flash, protrusions, or gate burrs shall not exceed 0.25mm per side

# EXAMPLE BOARD LAYOUT

DCK0005A

SOT - 1.1 max height

SMALL OUTLINE TRANSISTOR



LAND PATTERN EXAMPLE  
EXPOSED METAL SHOWN  
SCALE:18X

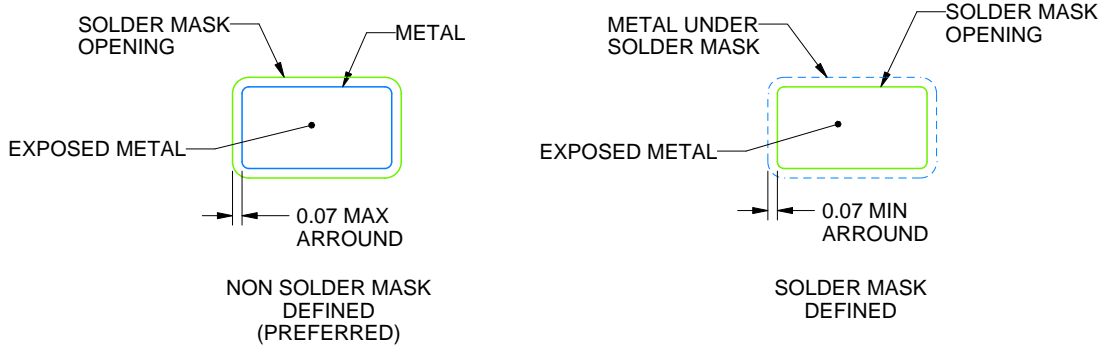

SOLDER MASK DETAILS

4214834/G 11/2024

NOTES: (continued)

- 7. Publication IPC-7351 may have alternate designs.
- 8. Solder mask tolerances between and around signal pads can vary based on board fabrication site.

# EXAMPLE STENCIL DESIGN

DCK0005A

SOT - 1.1 max height

SMALL OUTLINE TRANSISTOR

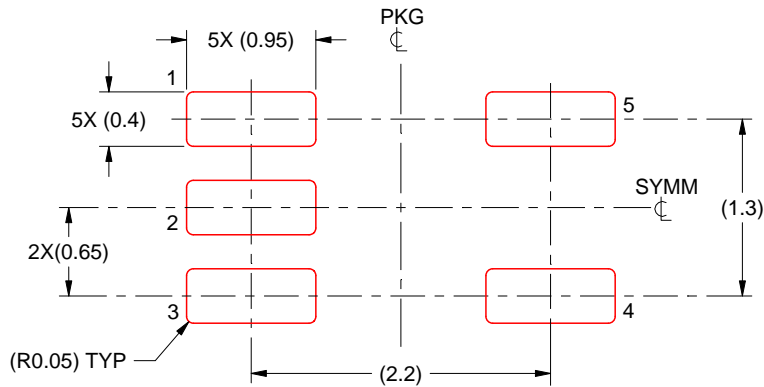

SOLDER PASTE EXAMPLE  
BASED ON 0.125 THICK STENCIL  
SCALE: 18X

4214834/G 11/2024

NOTES: (continued)

9. Laser cutting apertures with trapezoidal walls and rounded corners may offer better paste release. IPC-7525 may have alternate design recommendations.
10. Board assembly site may have different recommendations for stencil design.

# DDF0008A



# PACKAGE OUTLINE

## SOT-23-THIN - 1.1 mm max height

PLASTIC SMALL OUTLINE

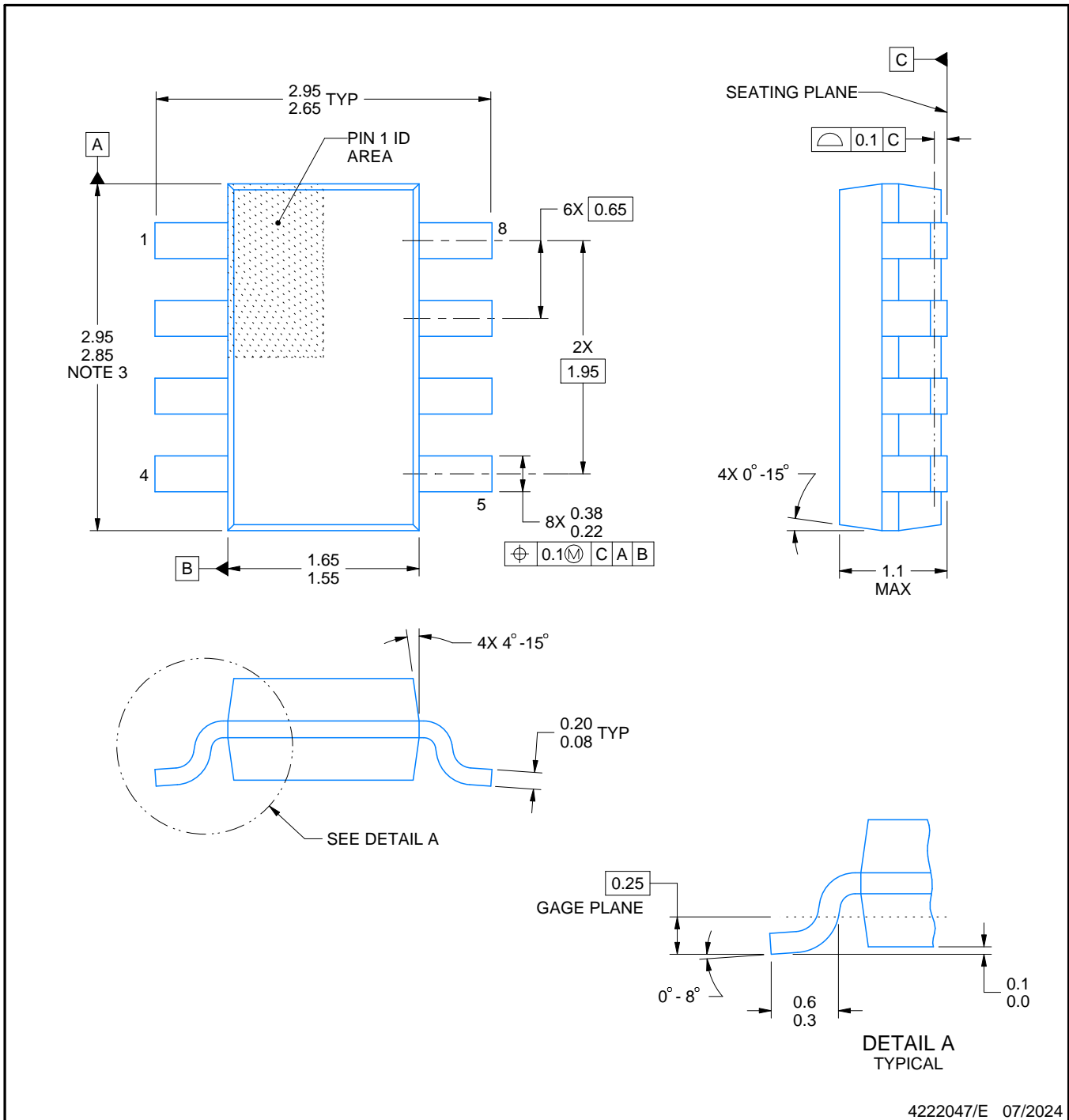

4222047/E 07/2024

### NOTES:

1. All linear dimensions are in millimeters. Any dimensions in parenthesis are for reference only. Dimensioning and tolerancing per ASME Y14.5M.
2. This drawing is subject to change without notice.
3. This dimension does not include mold flash, protrusions, or gate burrs. Mold flash, protrusions, or gate burrs shall not exceed 0.15 mm per side.

# EXAMPLE BOARD LAYOUT

DDF0008A

SOT-23-THIN - 1.1 mm max height

PLASTIC SMALL OUTLINE

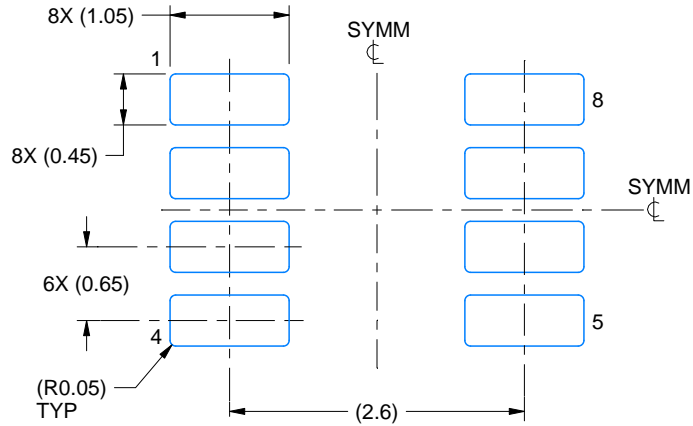

LAND PATTERN EXAMPLE  
EXPOSED METAL SHOWN  
SCALE:15X

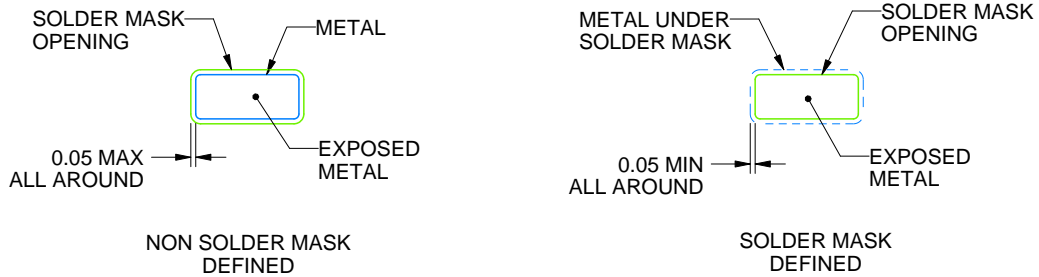

SOLDER MASK DETAILS

4222047/E 07/2024

NOTES: (continued)

- 4. Publication IPC-7351 may have alternate designs.
- 5. Solder mask tolerances between and around signal pads can vary based on board fabrication site.

# EXAMPLE STENCIL DESIGN

DDF0008A

SOT-23-THIN - 1.1 mm max height

PLASTIC SMALL OUTLINE



SOLDER PASTE EXAMPLE  
BASED ON 0.125 mm THICK STENCIL  
SCALE:15X

4222047/E 07/2024

NOTES: (continued)

6. Laser cutting apertures with trapezoidal walls and rounded corners may offer better paste release. IPC-7525 may have alternate design recommendations.
7. Board assembly site may have different recommendations for stencil design.



D0008A

# PACKAGE OUTLINE

SOIC - 1.75 mm max height

SMALL OUTLINE INTEGRATED CIRCUIT



4214825/C 02/2019

### NOTES:

- Linear dimensions are in inches [millimeters]. Dimensions in parenthesis are for reference only. Controlling dimensions are in inches. Dimensioning and tolerancing per ASME Y14.5M.
- This drawing is subject to change without notice.
- This dimension does not include mold flash, protrusions, or gate burrs. Mold flash, protrusions, or gate burrs shall not exceed .006 [0.15] per side.
- This dimension does not include interlead flash.
- Reference JEDEC registration MS-012, variation AA.

# EXAMPLE BOARD LAYOUT

D0008A

SOIC - 1.75 mm max height

SMALL OUTLINE INTEGRATED CIRCUIT



LAND PATTERN EXAMPLE  
 EXPOSED METAL SHOWN  
 SCALE:8X



SOLDER MASK DETAILS

4214825/C 02/2019

NOTES: (continued)

- 6. Publication IPC-7351 may have alternate designs.
- 7. Solder mask tolerances between and around signal pads can vary based on board fabrication site.

# EXAMPLE STENCIL DESIGN

D0008A

SOIC - 1.75 mm max height

SMALL OUTLINE INTEGRATED CIRCUIT

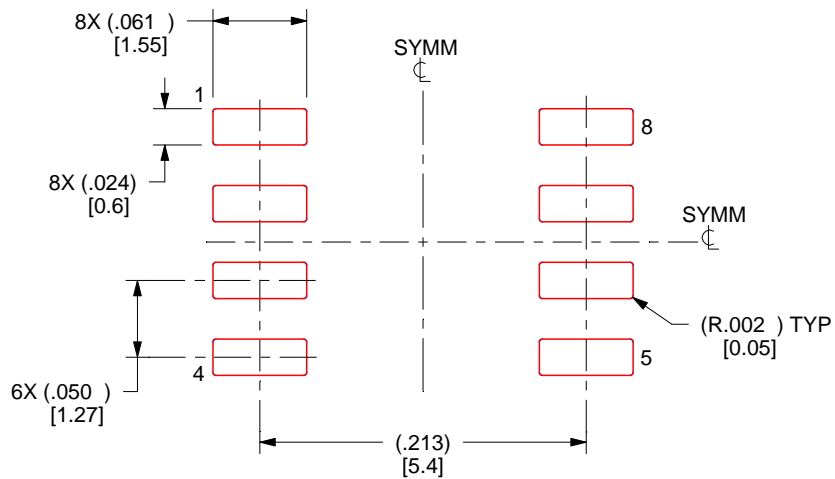

SOLDER PASTE EXAMPLE  
BASED ON .005 INCH [0.125 MM] THICK STENCIL  
SCALE:8X

4214825/C 02/2019

NOTES: (continued)

8. Laser cutting apertures with trapezoidal walls and rounded corners may offer better paste release. IPC-7525 may have alternate design recommendations.
9. Board assembly site may have different recommendations for stencil design.

# MECHANICAL DATA

PS (R-PDSO-G8)

PLASTIC SMALL-OUTLINE PACKAGE

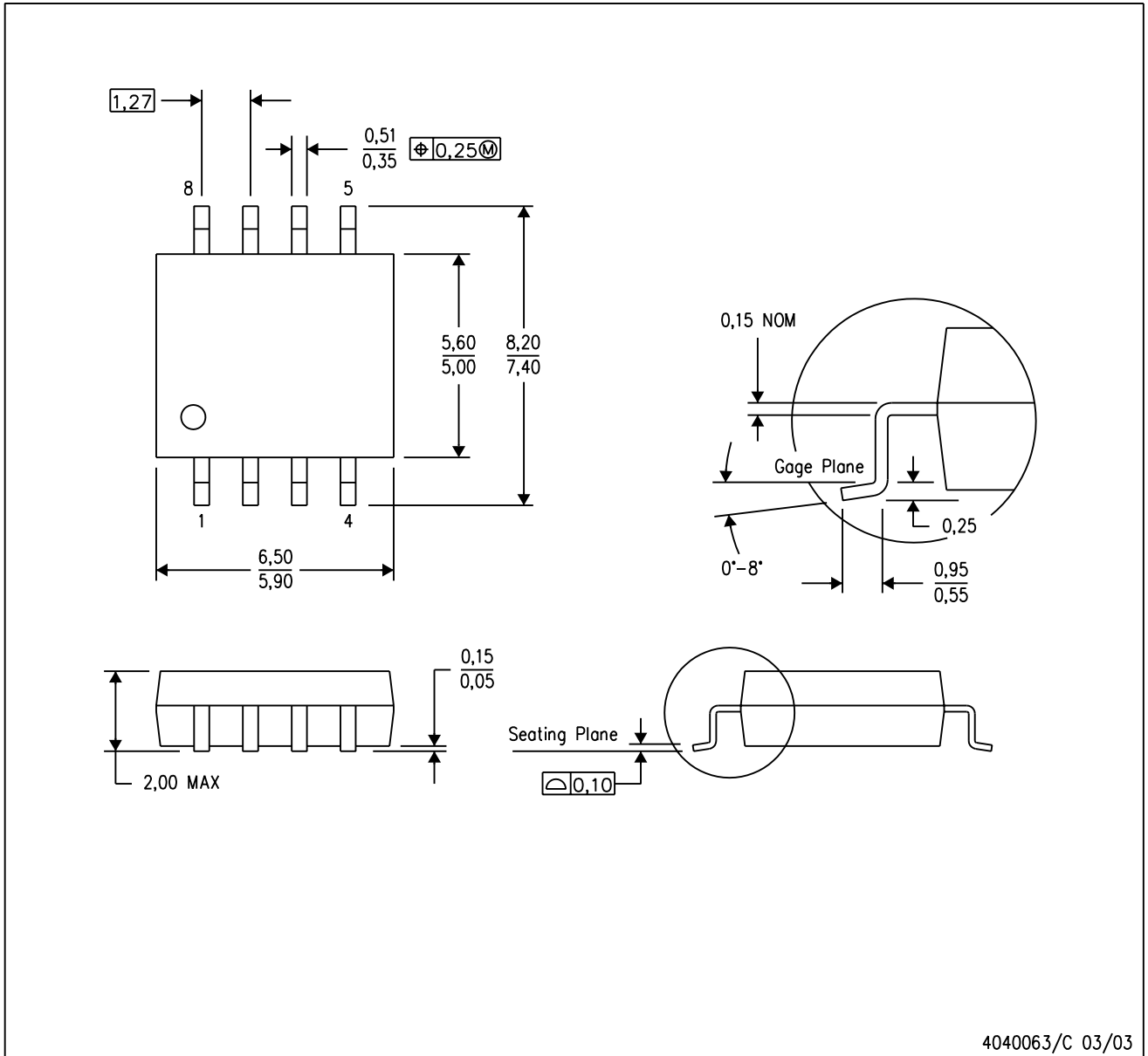

- NOTES:
- A. All linear dimensions are in millimeters.
  - B. This drawing is subject to change without notice.
  - C. Body dimensions do not include mold flash or protrusion, not to exceed 0,15.

PS (R-PDSO-G8)

PLASTIC SMALL OUTLINE

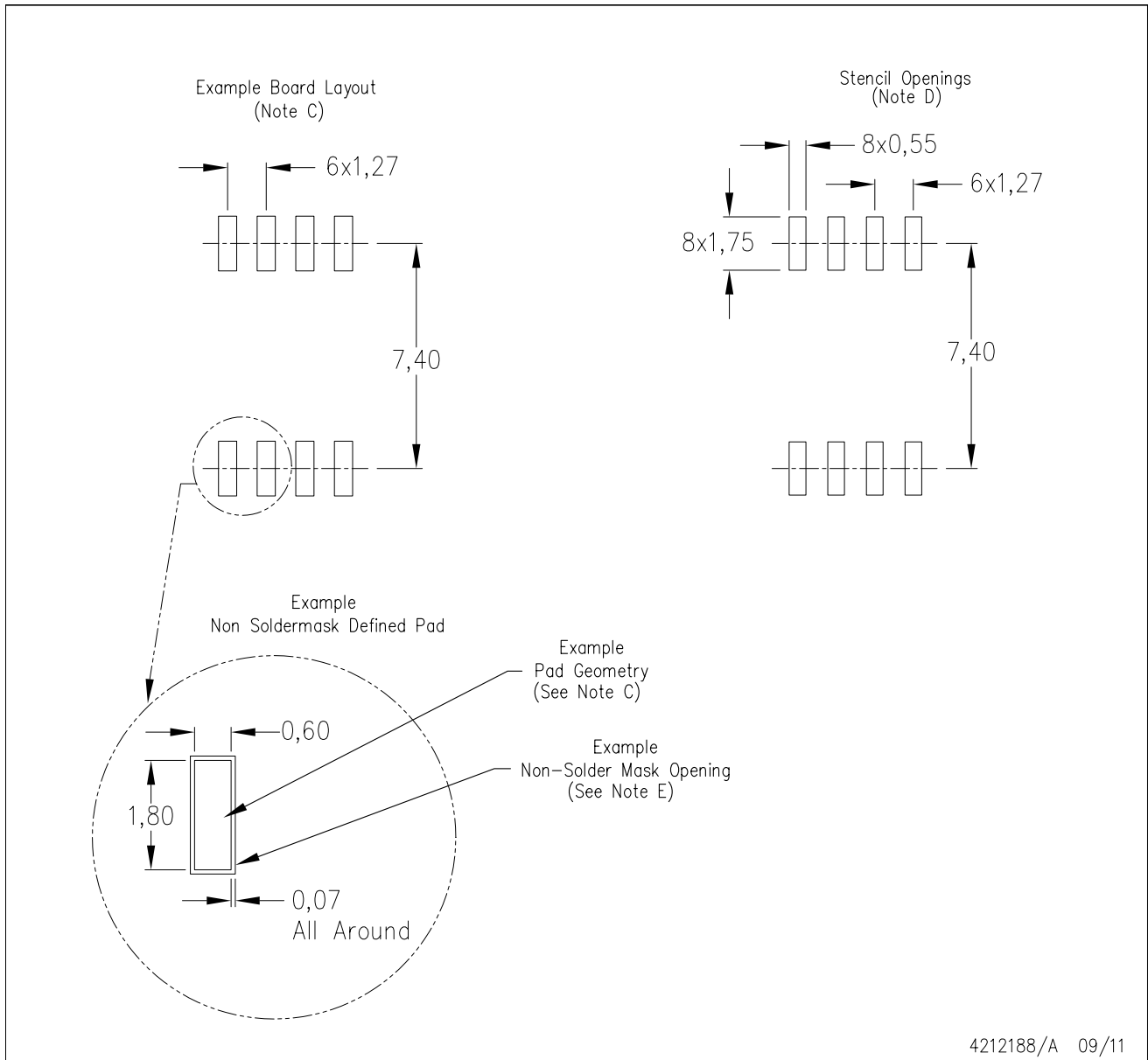

- NOTES:
- A. All linear dimensions are in millimeters.
  - B. This drawing is subject to change without notice.
  - C. Publication IPC-7351 is recommended for alternate designs.
  - D. Laser cutting apertures with trapezoidal walls and also rounding corners will offer better paste release. Customers should contact their board assembly site for stencil design recommendations. Refer to IPC-7525 for other stencil recommendations.
  - E. Customers should contact their board fabrication site for solder mask tolerances between and around signal pads.

P (R-PDIP-T8)

PLASTIC DUAL-IN-LINE PACKAGE

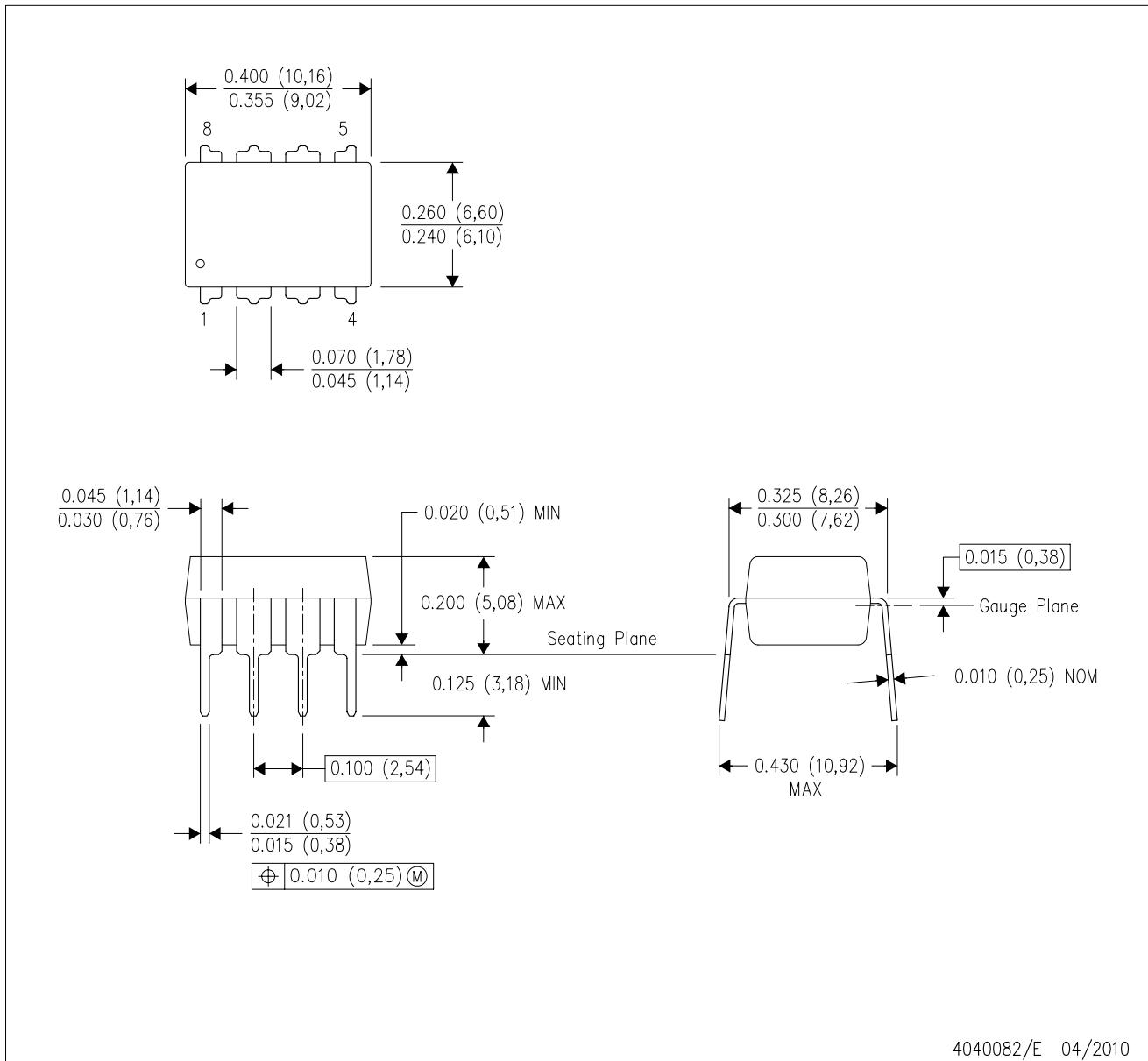

4040082/E 04/2010

- NOTES:
- A. All linear dimensions are in inches (millimeters).
  - B. This drawing is subject to change without notice.
  - C. Falls within JEDEC MS-001 variation BA.

N (R-PDIP-T\*\*)

PLASTIC DUAL-IN-LINE PACKAGE

16 PINS SHOWN



- NOTES:
- A. All linear dimensions are in inches (millimeters).
  - B. This drawing is subject to change without notice.
  - Falls within JEDEC MS-001, except 18 and 20 pin minimum body length (Dim A).
  - The 20 pin end lead shoulder width is a vendor option, either half or full width.

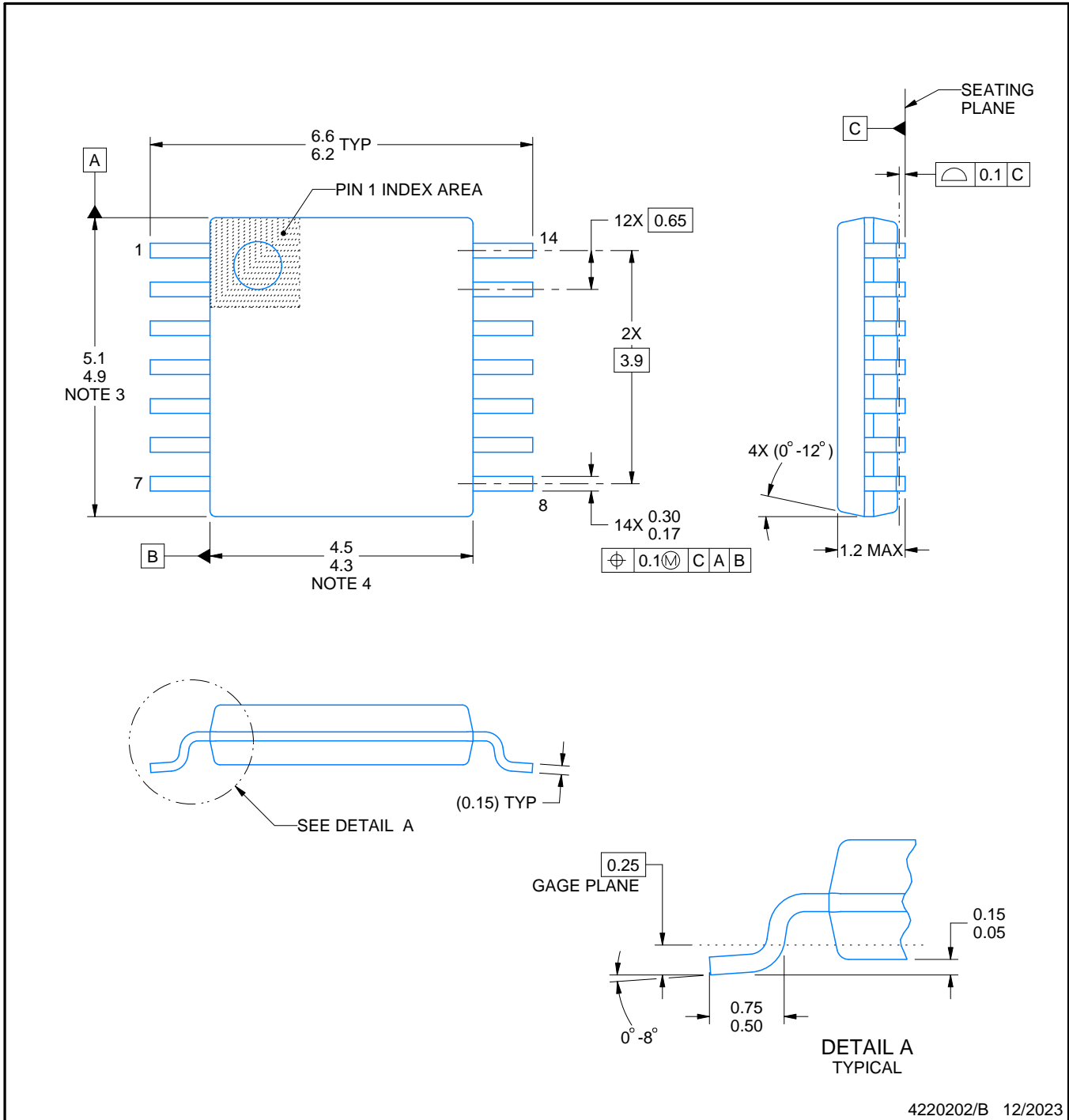
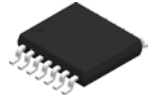

4220202/B 12/2023

NOTES:

1. All linear dimensions are in millimeters. Any dimensions in parenthesis are for reference only. Dimensioning and tolerancing per ASME Y14.5M.
2. This drawing is subject to change without notice.
3. This dimension does not include mold flash, protrusions, or gate burrs. Mold flash, protrusions, or gate burrs shall not exceed 0.15 mm per side.
4. This dimension does not include interlead flash. Interlead flash shall not exceed 0.25 mm per side.
5. Reference JEDEC registration MO-153.

# EXAMPLE BOARD LAYOUT

PW0014A

TSSOP - 1.2 mm max height

SMALL OUTLINE PACKAGE

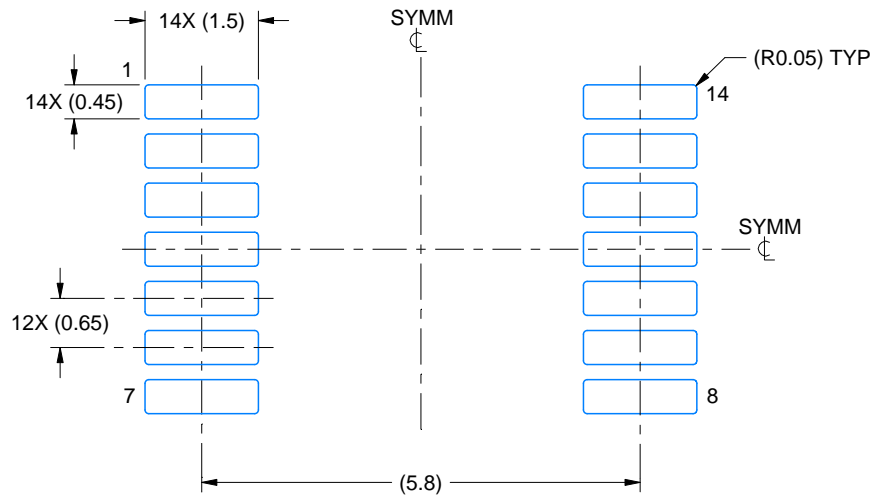

LAND PATTERN EXAMPLE  
EXPOSED METAL SHOWN  
SCALE: 10X

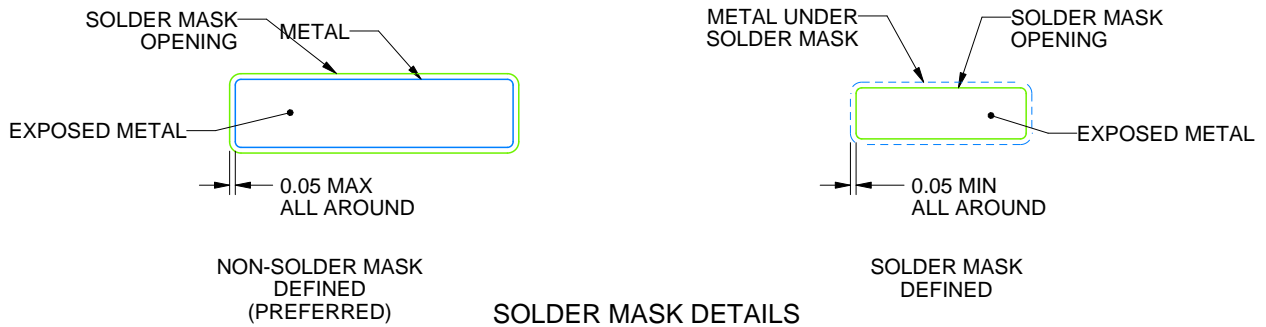

4220202/B 12/2023

NOTES: (continued)

- 6. Publication IPC-7351 may have alternate designs.
- 7. Solder mask tolerances between and around signal pads can vary based on board fabrication site.

# EXAMPLE STENCIL DESIGN

PW0014A

TSSOP - 1.2 mm max height

SMALL OUTLINE PACKAGE

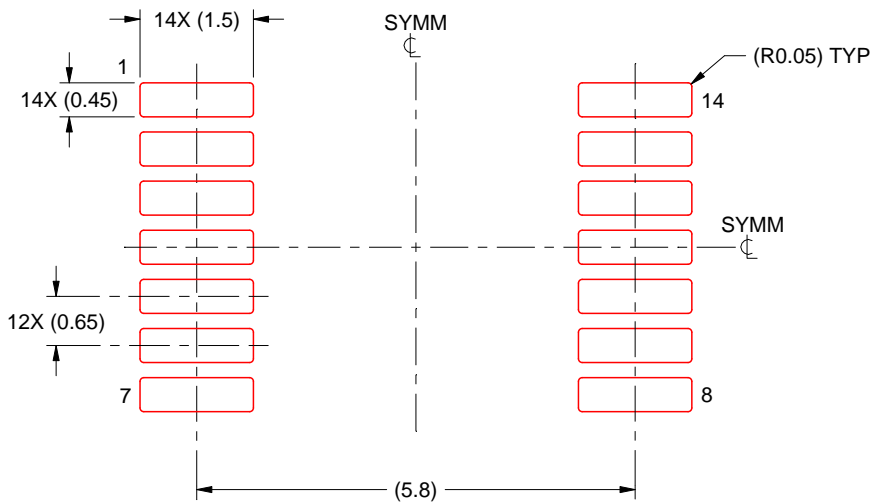

SOLDER PASTE EXAMPLE  
BASED ON 0.125 mm THICK STENCIL  
SCALE: 10X

4220202/B 12/2023

NOTES: (continued)

8. Laser cutting apertures with trapezoidal walls and rounded corners may offer better paste release. IPC-7525 may have alternate design recommendations.
9. Board assembly site may have different recommendations for stencil design.

PW0008A



PACKAGE OUTLINE

TSSOP - 1.2 mm max height

SMALL OUTLINE PACKAGE

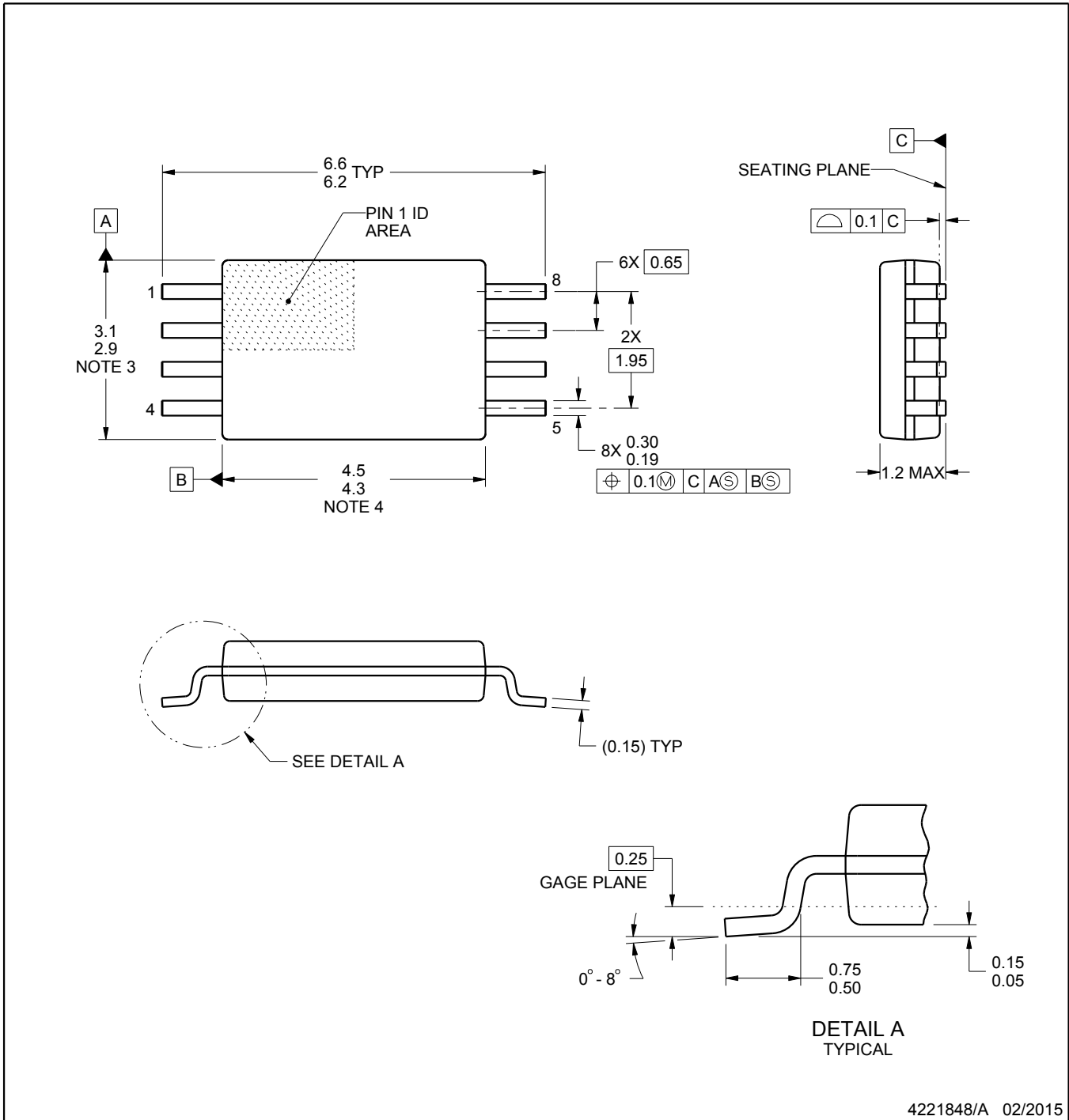

4221848/A 02/2015

NOTES:

1. All linear dimensions are in millimeters. Any dimensions in parenthesis are for reference only. Dimensioning and tolerancing per ASME Y14.5M.
2. This drawing is subject to change without notice.
3. This dimension does not include mold flash, protrusions, or gate burrs. Mold flash, protrusions, or gate burrs shall not exceed 0.15 mm per side.
4. This dimension does not include interlead flash. Interlead flash shall not exceed 0.25 mm per side.
5. Reference JEDEC registration MO-153, variation AA.

# EXAMPLE BOARD LAYOUT

PW0008A

TSSOP - 1.2 mm max height

SMALL OUTLINE PACKAGE

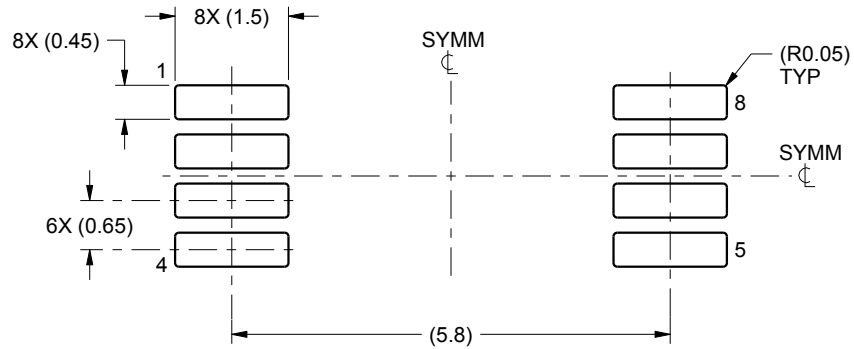

LAND PATTERN EXAMPLE  
SCALE:10X

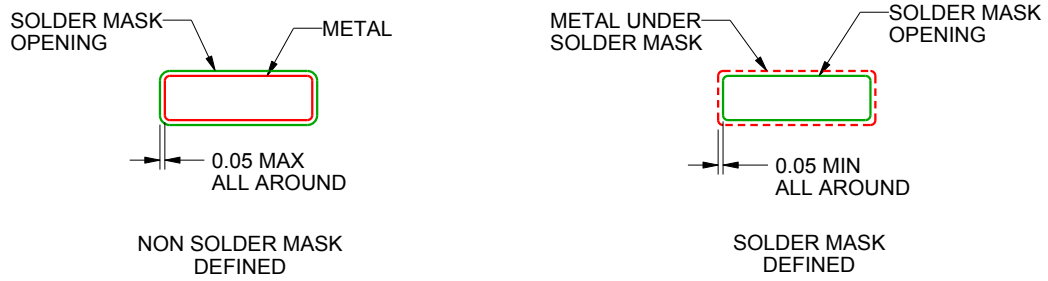

SOLDER MASK DETAILS  
NOT TO SCALE

4221848/A 02/2015

NOTES: (continued)

- 6. Publication IPC-7351 may have alternate designs.
- 7. Solder mask tolerances between and around signal pads can vary based on board fabrication site.

# EXAMPLE STENCIL DESIGN

PW0008A

TSSOP - 1.2 mm max height

SMALL OUTLINE PACKAGE

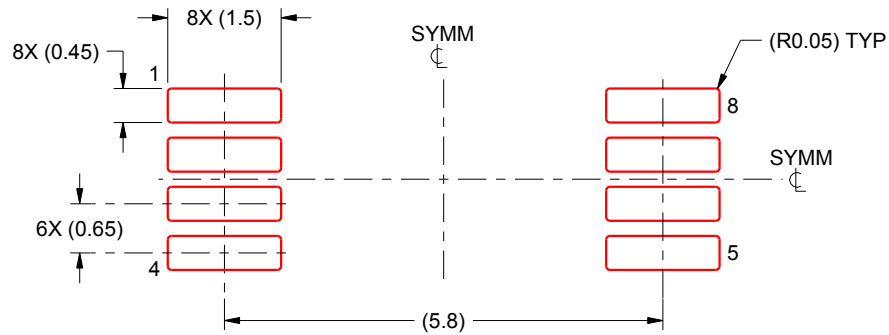

SOLDER PASTE EXAMPLE  
BASED ON 0.125 mm THICK STENCIL  
SCALE:10X

4221848/A 02/2015

NOTES: (continued)

8. Laser cutting apertures with trapezoidal walls and rounded corners may offer better paste release. IPC-7525 may have alternate design recommendations.
9. Board assembly site may have different recommendations for stencil design.

## 重要通知和免责声明

TI“按原样”提供技术和可靠性数据（包括数据表）、设计资源（包括参考设计）、应用或其他设计建议、网络工具、安全信息和其他资源，不保证没有瑕疵且不做任何明示或暗示的担保，包括但不限于对适销性、与某特定用途的适用性或不侵犯任何第三方知识产权的暗示担保。

这些资源可供使用 TI 产品进行设计的熟练开发人员使用。您将自行承担以下全部责任：(1) 针对您的应用选择合适的 TI 产品，(2) 设计、验证并测试您的应用，(3) 确保您的应用满足相应标准以及任何其他安全、安保法规或其他要求。

这些资源如有变更，恕不另行通知。TI 授权您仅可将这些资源用于研发本资源所述的 TI 产品的相关应用。严禁以其他方式对这些资源进行复制或展示。您无权使用任何其他 TI 知识产权或任何第三方知识产权。对于因您对这些资源的使用而对 TI 及其代表造成的任何索赔、损害、成本、损失和债务，您将全额赔偿，TI 对此概不负责。

TI 提供的产品受 [TI 销售条款](#)、[TI 通用质量指南](#) 或 [ti.com](#) 上其他适用条款或 TI 产品随附的其他适用条款的约束。TI 提供这些资源并不会扩展或以其他方式更改 TI 针对 TI 产品发布的适用的担保或担保免责声明。除非德州仪器 (TI) 明确将某产品指定为定制产品或客户特定产品，否则其产品均为按确定价格收入目录的标准通用器件。

TI 反对并拒绝您可能提出的任何其他或不同的条款。

版权所有 © 2026，德州仪器 (TI) 公司

最后更新日期：2025 年 10 月