

TLV1117LV 1A、固定正电压、低压降稳压器

1 特性

- 典型精度：1.5%
- 低 I_Q ：100 μ A (最大值)
 - 比标准 1117 器件低 500 倍
- V_{IN} ：2 V 至 5.5 V
 - V_{IN} 绝对最大值：6V
- 输出电流为 0mA 时运行稳定
- 低压降： $V_{OUT} = 3.3V$ ，1A 时为 455mV
- 高 PSRR：1kHz 时为 65dB
- 最小额定电流限制：1.1A
- 与具有成本效益的陶瓷电容器一起工作时运行稳定：
 - 等效串联电阻 (ESR) 为 0 Ω
- 温度范围：-40°C 至 +125°C
- 热关断保护和过流保护
- 有关具有升级功能的直接替代产品，请参阅 [TLV761](#)
- 采用 SOT-223 封装
 - 请参阅本文档末尾的 [机械、封装和可订购信息](#) 部分，了解可用电压选项的完整列表。

2 应用

- 机顶盒
- 电视和监视器
- PC 外设、笔记本电脑、主板
- 调制解调器和其他通信产品
- 开关电源后稳压

3 说明

TLV1117LV 低压降 (LDO) 线性稳压器是普及型 TLV1117 稳压器的低输入电压版本。

TLV1117LV 是一款静态电流比传统 1117 稳压器低 500 倍的超低功耗器件，非常适合专为需要超低待机电流的应用而设计的器件。TLV1117LV LDO 还可在 0mA 负载电流下保持稳定；没有最低负载要求，这使得此器件非常适合于必须在待机时为极小负载供电，同时又可在正常工作期间提供大约 1A 大电流的应用。TLV1117LV 可提供出色的线路与负载瞬态性能，从而可在负载电流要求由不足 1mA 变为超过 500mA 时产生幅值极低的下冲与过冲输出电压。

高精度带隙与误差放大器支持 1.5% 的精度。凭借超高电源抑制比 (PSRR)，该器件适用于开关稳压器的后稳压操作。其它重要特性还包括低输出噪声与低压降电压等。

该器件可通过内部补偿，在使用 0 Ω ESR 电容器时保持稳定。这些重要优势可实现对低成本小型陶瓷电容器的使用。此外，在必要时还可使用具有较高偏置电压和温度降额的低成本电容器。

TLV1117LV 采用 SOT-223 封装。

封装信息

器件型号	封装 ⁽¹⁾	封装尺寸 (标称值)
TLV1117LV	DCY (SOT-223, 4)	6.50mm × 3.50mm

(1) 如需了解所有可用封装，请参阅数据表末尾的可订购产品附录。

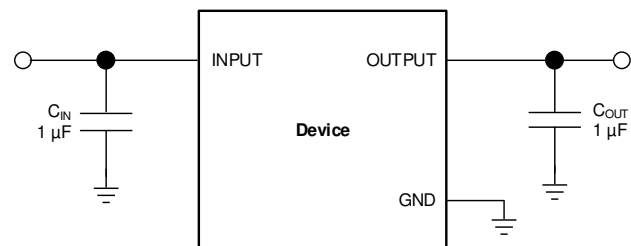

典型应用电路



Table of Contents

1 特性	1	8 Application and Implementation	13
2 应用	1	8.1 Application Information.....	13
3 说明	1	8.2 Typical Application.....	13
4 Revision History	2	8.3 Best Design Practices.....	14
5 Pin Configuration and Functions	3	8.4 Power Supply Recommendations.....	14
6 Specifications	4	8.5 Layout.....	14
6.1 Absolute Maximum Ratings.....	4	9 Device and Documentation Support	16
6.2 ESD Ratings.....	4	9.1 Device Support.....	16
6.3 Recommended Operating Conditions.....	4	9.2 Documentation Support.....	16
6.4 Thermal Information.....	4	9.3 接收文档更新通知.....	16
6.5 Electrical Characteristics.....	5	9.4 支持资源.....	16
6.6 Typical Characteristics.....	6	9.5 Trademarks.....	16
7 Detailed Description	11	9.6 静电放电警告.....	16
7.1 Overview.....	11	9.7 术语表.....	16
7.2 Functional Block Diagram.....	11	10 Mechanical, Packaging, and Orderable	
7.3 Feature Description.....	11	Information	17
7.4 Device Functional Modes.....	12		

4 Revision History

注：以前版本的页码可能与当前版本的页码不同

Changes from Revision B (January 2015) to Revision C (January 2023)	Page
• 向特性部分添加了直接替代产品项目符号.....	1

Changes from Revision A (September 2011) to Revision B (January 2015)	Page
• 添加了 ESD 等级表、特性说明部分、器件功能模式、应用和实施部分、电源相关建议部分、布局部分、器件和文档支持部分以及机械、封装和可订购信息部分.....	1
• 替换了首页图片.....	1
• Deleted <i>Dissipation Ratings</i> table.....	4

5 Pin Configuration and Functions



图 5-1. DCY Package, 4 Pins (SOT-223) (Top View)

表 5-1. Pin Functions

PIN		I/O	DESCRIPTION
NAME	NO.		
IN	3	I	Input pin. See the Input and Output Capacitor Requirements section for more details.
OUT	2, Tab	O	Regulated output voltage pin. See the Input and Output Capacitor Requirements section for more details.
GND	1	—	Ground pin.

6 Specifications

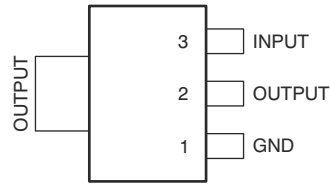
6.1 Absolute Maximum Ratings

at $T_J = 25^\circ\text{C}$ (unless otherwise noted); all voltages are with respect to GND⁽¹⁾

		MIN	MAX	UNIT
Voltage	V_{IN}	- 0.3	6	V
	V_{OUT}	- 0.3	6	V
Current	I_{OUT}	Internally limited		
Output short-circuit duration		Indefinite		
Continuous total power dissipation	P_{DISS}	See Thermal Information		
Temperature	Operating junction, T_J	- 55	150	$^\circ\text{C}$
	Storage, T_{stg}	- 55	150	$^\circ\text{C}$

- (1) Stresses beyond those listed under *Absolute Maximum Ratings* may cause permanent damage to the device. These are stress ratings only, and functional operation of the device at these or any other conditions beyond those indicated under *Recommended Operating Conditions* is not implied. Exposure to absolute-maximum-rated conditions for extended periods may affect device reliability.

6.2 ESD Ratings

			VALUE	UNIT
$V_{(ESD)}$	Electrostatic discharge	Human body model (HBM), per ANSI/ESDA/JEDEC JS-001, all pins ⁽¹⁾	± 2000	V
		Charged device model (CDM), per JEDEC specification JESD22-C101, all pins ⁽²⁾	± 500	

- (1) JEDEC document JEP155 states that 500-V HBM allows safe manufacturing with a standard ESD control process.
 (2) JEDEC document JEP157 states that 250-V CDM allows safe manufacturing with a standard ESD control process.

6.3 Recommended Operating Conditions

over operating free-air temperature range (unless otherwise noted)

		MIN	NOM	MAX	UNIT
V_{IN}	Input voltage	2		5.5	V
V_{OUT}	Output voltage	0		5.5	V
I_{OUT}	Output current	0		1	A

6.4 Thermal Information

THERMAL METRIC ⁽¹⁾		TLV1117LV	UNIT
		DCY (SOT-223)	
		4 PINS	
$R_{\theta JA}$	Junction-to-ambient thermal resistance	62.9	$^\circ\text{C/W}$
θ_{JCtop}	Junction-to-case (top) thermal resistance	47.2	$^\circ\text{C/W}$
$R_{\theta JC(top)}$	Junction-to-board thermal resistance	12	$^\circ\text{C/W}$
ψ_{JT}	Junction-to-top characterization parameter	6.1	$^\circ\text{C/W}$
ψ_{JB}	Junction-to-board characterization parameter	11.9	$^\circ\text{C/W}$

- (1) For more information about traditional and new thermal metrics, see the [Semiconductor and IC Package Thermal Metrics application note](#).

6.5 Electrical Characteristics

at $V_{IN} = V_{OUT(nom)} + 1.5\text{ V}$; $I_{OUT} = 10\text{ mA}$, $C_{OUT} = 1.0\text{ }\mu\text{F}$, and $T_A = 25^\circ\text{C}$ (unless otherwise noted)

PARAMETER		TEST CONDITIONS		MIN	TYP	MAX	UNIT
V_{IN}	Input voltage			2		5.5	V
V_{OUT}	DC output accuracy	$V_{OUT} > 2\text{ V}$		- 1.5%		1.5%	
		$1.5\text{ V} \leq V_{OUT} < 2\text{ V}$		- 2%		2%	
		$1.2\text{ V} \leq V_{OUT} < 1.5\text{ V}$		- 40		40	mV
$\Delta V_{OUT(\Delta V_{IN})}$	Line regulation	$V_{OUT(nom)} + 0.5\text{ V} \leq V_{IN} \leq 5.5\text{ V}$, $I_{OUT} = 10\text{ mA}$			1	5	mV
$\Delta V_{OUT(\Delta I_{OUT})}$	Load regulation	$0\text{ mA} \leq I_{OUT} \leq 1\text{ A}$			1	35	mV
V_{DO}	Dropout voltage ⁽¹⁾	$V_{IN} = 0.98 \times V_{OUT(nom)}$	$V_{OUT} < 3.3\text{ V}$	$I_{OUT} = 200\text{ mA}$	115		mV
				$I_{OUT} = 500\text{ mA}$	285		
				$I_{OUT} = 800\text{ mA}$	455		
				$I_{OUT} = 1\text{ A}$	570	800	
		$V_{OUT} \geq 3.3\text{ V}$	$I_{OUT} = 200\text{ mA}$	90			
			$I_{OUT} = 500\text{ mA}$	230			
			$I_{OUT} = 800\text{ mA}$	365			
			$I_{OUT} = 1\text{ A}$	455	700		
I_{CL}	Output current limit	$V_{OUT} = 0.9 \times V_{OUT(nom)}$		1.1			A
I_Q	Quiescent current	$I_{OUT} = 0\text{ mA}$			50	100	μA
PSRR	Power-supply rejection ratio	$V_{IN} = 3.3\text{ V}$, $V_{OUT} = 1.8\text{ V}$, $I_{OUT} = 500\text{ mA}$, $f = 100\text{ Hz}$			65		dB
V_n	Output noise voltage	BW = 10 Hz to 100 kHz, $V_{IN} = 2.8\text{ V}$, $V_{OUT} = 1.8\text{ V}$, $I_{OUT} = 500\text{ mA}$			60		μV_{RMS}
t_{STR}	Start-up time ⁽²⁾	$C_{OUT} = 1.0\text{ }\mu\text{F}$, $I_{OUT} = 1\text{ A}$			100		μs
UVLO	Undervoltage lockout	V_{IN} rising			1.95		V
T_{SD}	Thermal shutdown temperature	Shutdown, temperature increasing			165		°C
		Reset, temperature decreasing			145		
T_J	Operating junction temperature			- 40		125	°C

(1) V_{DO} is measured for devices with $V_{OUT(nom)} = 2.5\text{ V}$ so that $V_{IN} = 2.45\text{ V}$.

(2) Start-up time = time from when V_{IN} asserts to when output is sustained at a value greater than or equal to $0.98 \times V_{OUT(nom)}$.

6.6 Typical Characteristics

at $V_{IN} = V_{OUT(nom)} + 1.5\text{ V}$, $I_{OUT} = 10\text{ mA}$, $C_{OUT} = 1.0\ \mu\text{F}$, and $T_A = 25^\circ\text{C}$ (unless otherwise noted)

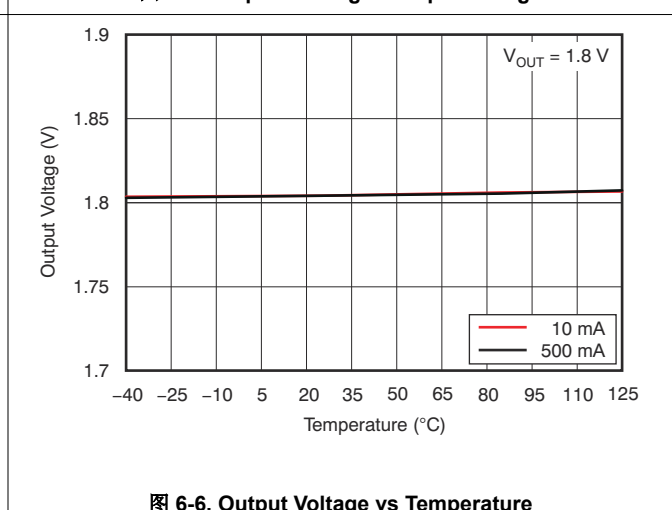
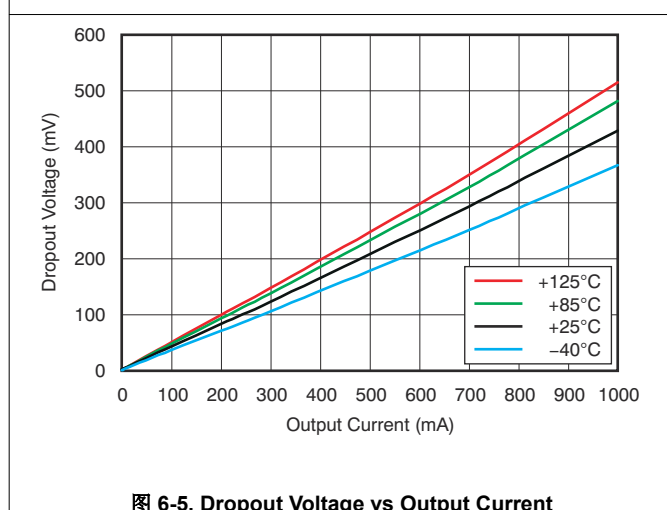
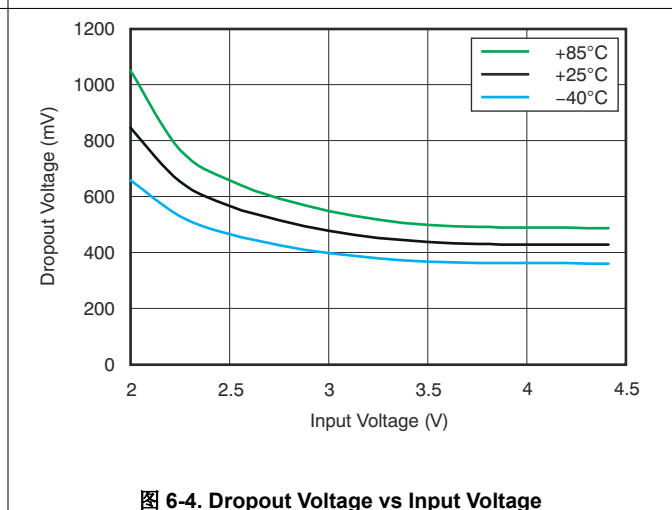
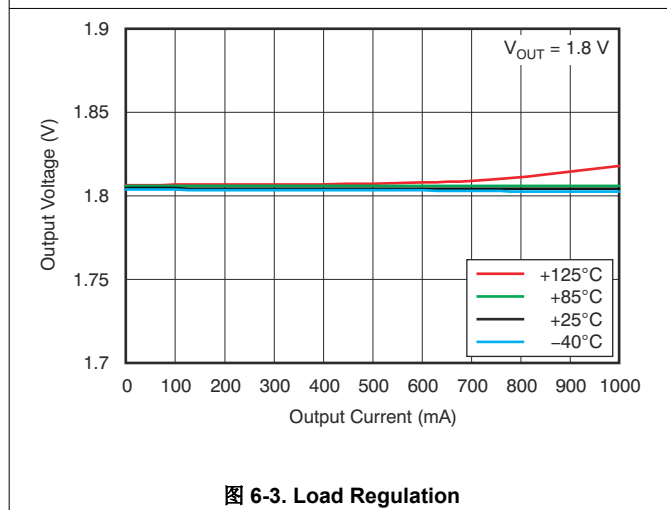
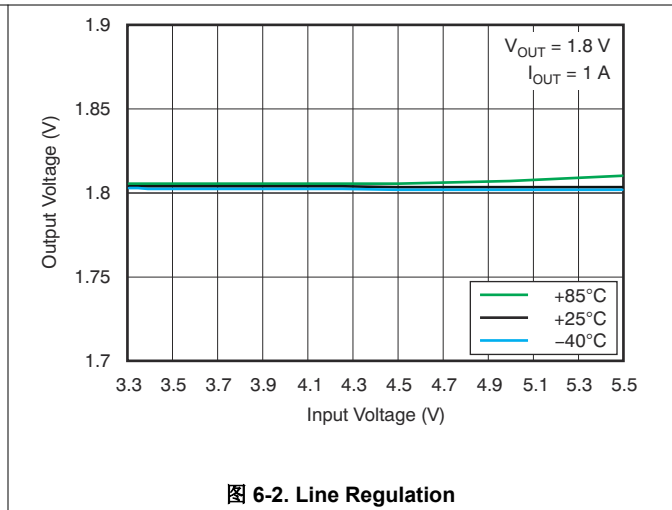
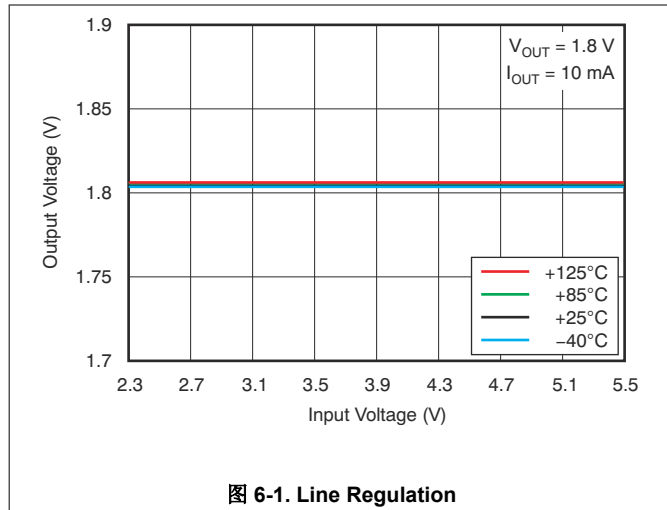

6.6 Typical Characteristics (continued)

at $V_{IN} = V_{OUT(nom)} + 1.5\text{ V}$, $I_{OUT} = 10\text{ mA}$, $C_{OUT} = 1.0\ \mu\text{F}$, and $T_A = 25^\circ\text{C}$ (unless otherwise noted)



图 6-7. Quiescent Current vs Load



图 6-8. Current Limit vs Input Voltage

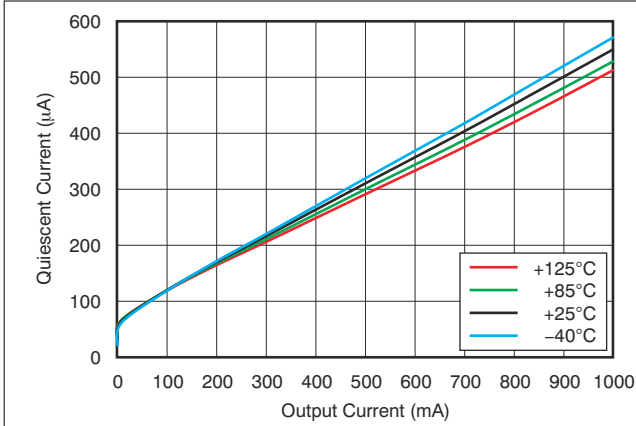

图 6-9. Power-Supply Rejection Ratio vs Frequency

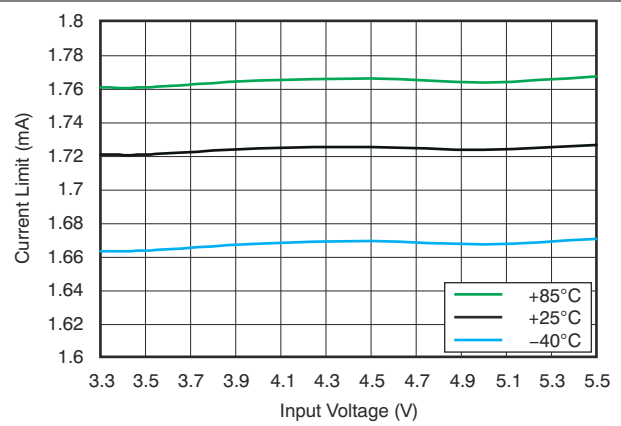

图 6-10. Power-Supply Rejection Ratio vs Frequency

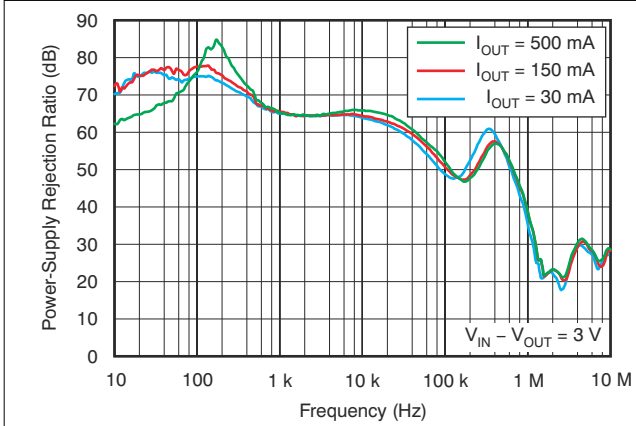

图 6-11. Power-Supply Rejection Ratio vs Output Current

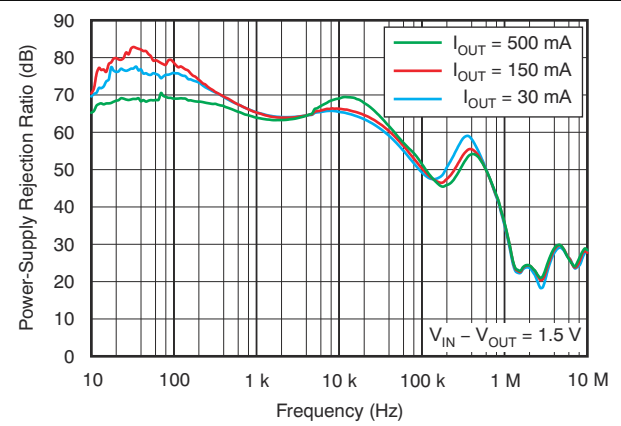

图 6-12. Spectral Noise Density vs Frequency

6.6 Typical Characteristics (continued)

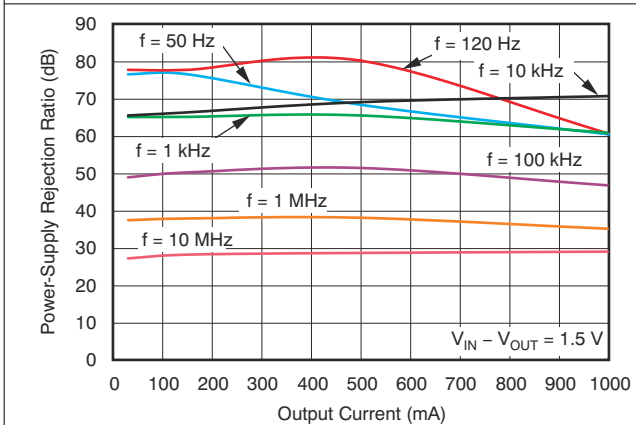
at $V_{IN} = V_{OUT(nom)} + 1.5\text{ V}$, $I_{OUT} = 10\text{ mA}$, $C_{OUT} = 1.0\ \mu\text{F}$, and $T_A = 25^\circ\text{C}$ (unless otherwise noted)

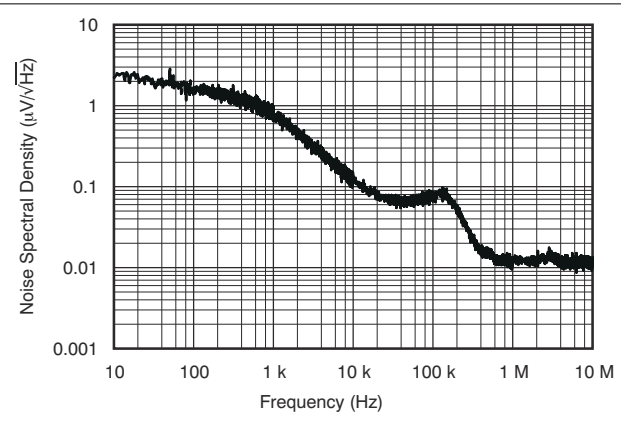
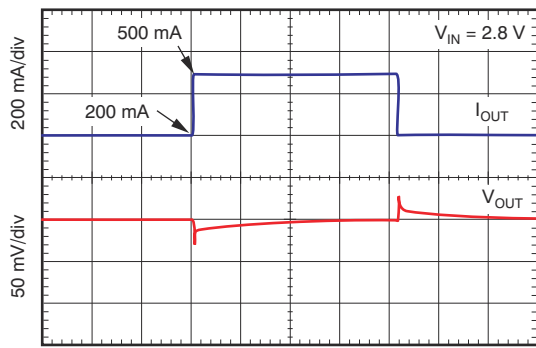

50 $\mu\text{s}/\text{div}$
 $C_{OUT} = 1\ \mu\text{F}$

图 6-13. Load Transient Response 200 mA to 500 mA

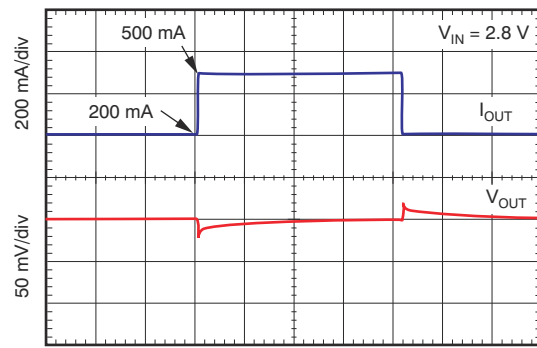

50 $\mu\text{s}/\text{div}$
 $C_{OUT} = 10\ \mu\text{F}$

图 6-14. Load Transient Response 200 mA to 500 mA

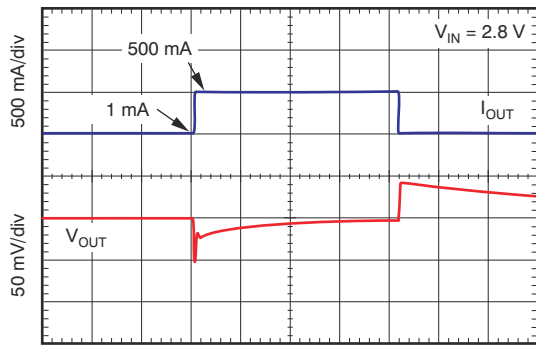

50 $\mu\text{s}/\text{div}$
 $C_{OUT} = 1\ \mu\text{F}$

图 6-15. Load Transient Response 1 mA to 500 mA

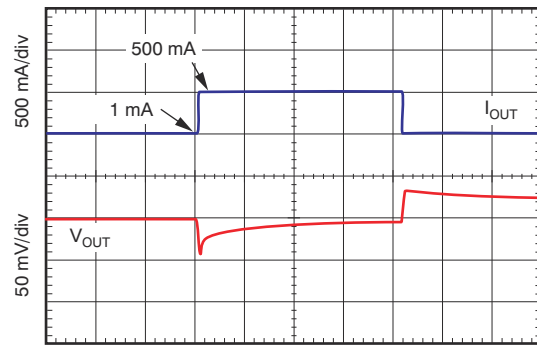

50 $\mu\text{s}/\text{div}$
 $C_{OUT} = 10\ \mu\text{F}$

图 6-16. Load Transient Response 1 mA to 500 mA

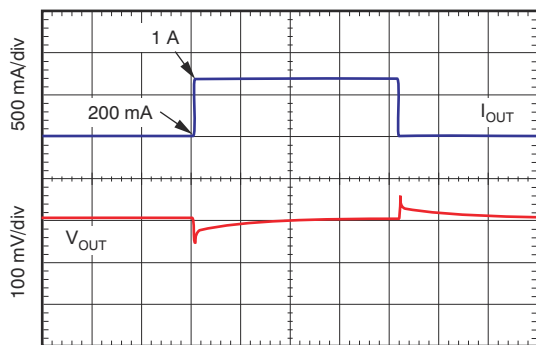

50 $\mu\text{s}/\text{div}$
 $C_{OUT} = 1\ \mu\text{F}$

图 6-17. Load Transient Response 200 mA to 1 A

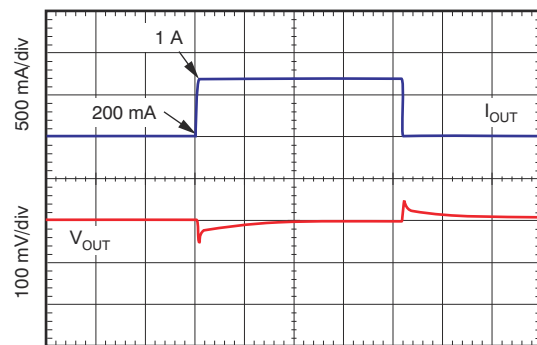

50 $\mu\text{s}/\text{div}$
 $C_{OUT} = 10\ \mu\text{F}$

图 6-18. Load Transient Response 200 mA to 1 A

6.6 Typical Characteristics (continued)

at $V_{IN} = V_{OUT(nom)} + 1.5\text{ V}$, $I_{OUT} = 10\text{ mA}$, $C_{OUT} = 1.0\ \mu\text{F}$, and $T_A = 25^\circ\text{C}$ (unless otherwise noted)

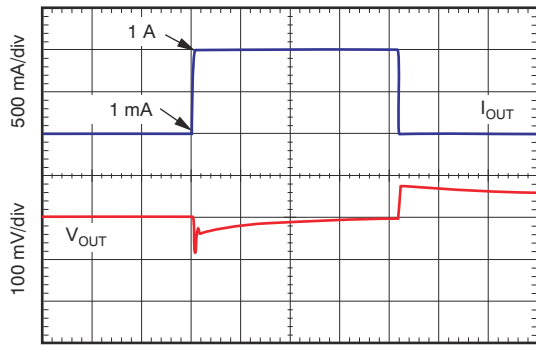

50 $\mu\text{s}/\text{div}$
 $C_{OUT} = 1\ \mu\text{F}$

图 6-19. Load Transient Response 1 mA to 1 A

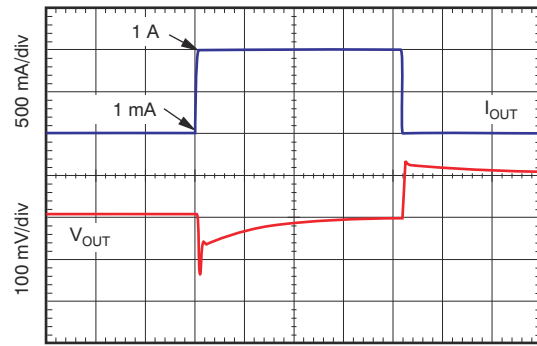

50 $\mu\text{s}/\text{div}$
 $C_{OUT} = 10\ \mu\text{F}$

图 6-20. Load Transient Response 1 mA to 1 A

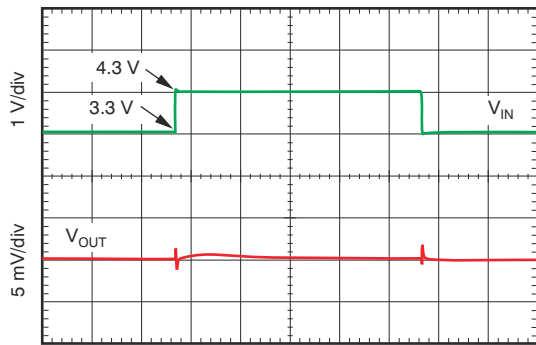

200 $\mu\text{s}/\text{div}$
 $V_{OUT} = 1.8\text{ V}$, $I_{OUT} = 10\text{ mA}$

图 6-21. Line Transient Response

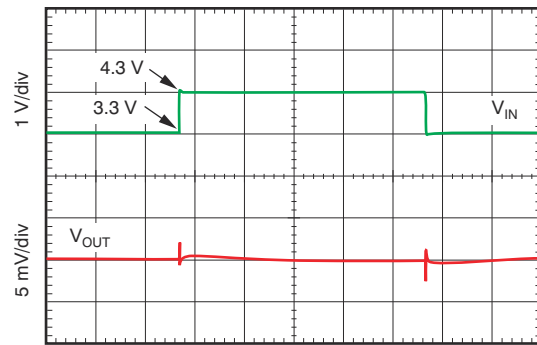

200 $\mu\text{s}/\text{div}$
 $V_{OUT} = 1.8\text{ V}$, $I_{OUT} = 500\text{ mA}$

图 6-22. Line Transient Response

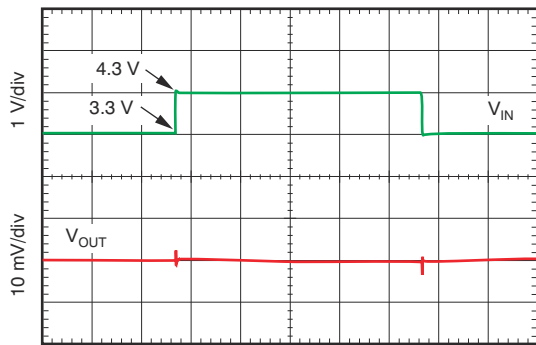

200 $\mu\text{s}/\text{div}$
 $V_{OUT} = 1.8\text{ V}$, $I_{OUT} = 1\text{ A}$

图 6-23. Line Transient Response

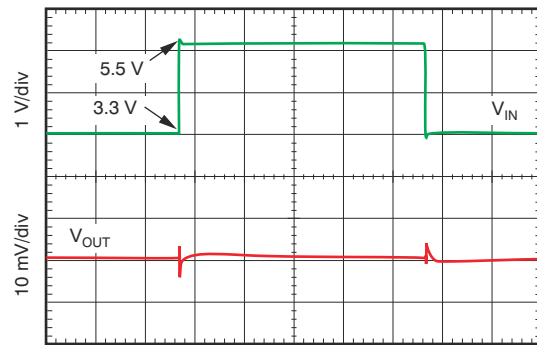

200 $\mu\text{s}/\text{div}$
 $V_{OUT} = 1.8\text{ V}$, $I_{OUT} = 10\text{ mA}$

图 6-24. Line Transient Response

6.6 Typical Characteristics (continued)

at $V_{IN} = V_{OUT(nom)} + 1.5\text{ V}$, $I_{OUT} = 10\text{ mA}$, $C_{OUT} = 1.0\ \mu\text{F}$, and $T_A = 25^\circ\text{C}$ (unless otherwise noted)

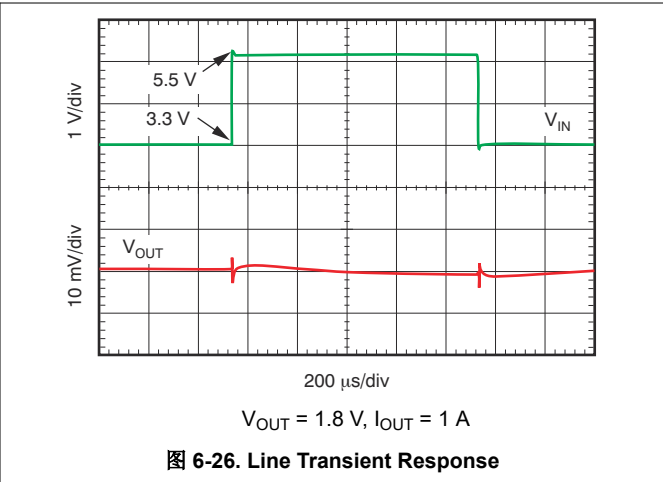
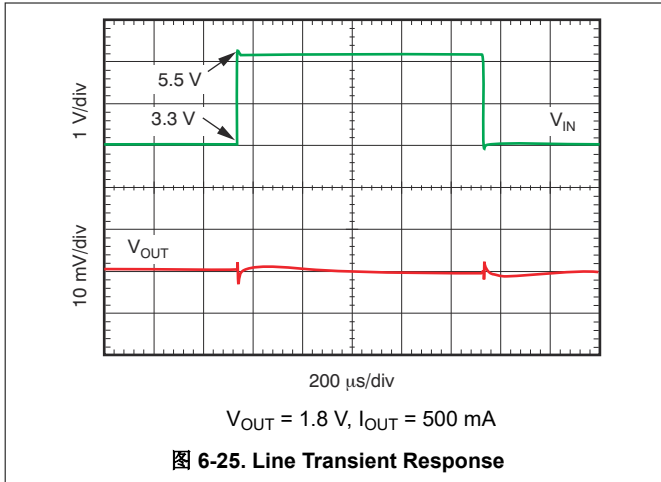

7 Detailed Description

7.1 Overview

The TLV1117LV is a low quiescent current, high PSRR LDO capable of handling up to 1 A of load current. This device features an integrated current limit, thermal shutdown, band-gap reference, and undervoltage lockout (UVLO) circuit blocks.

7.2 Functional Block Diagram

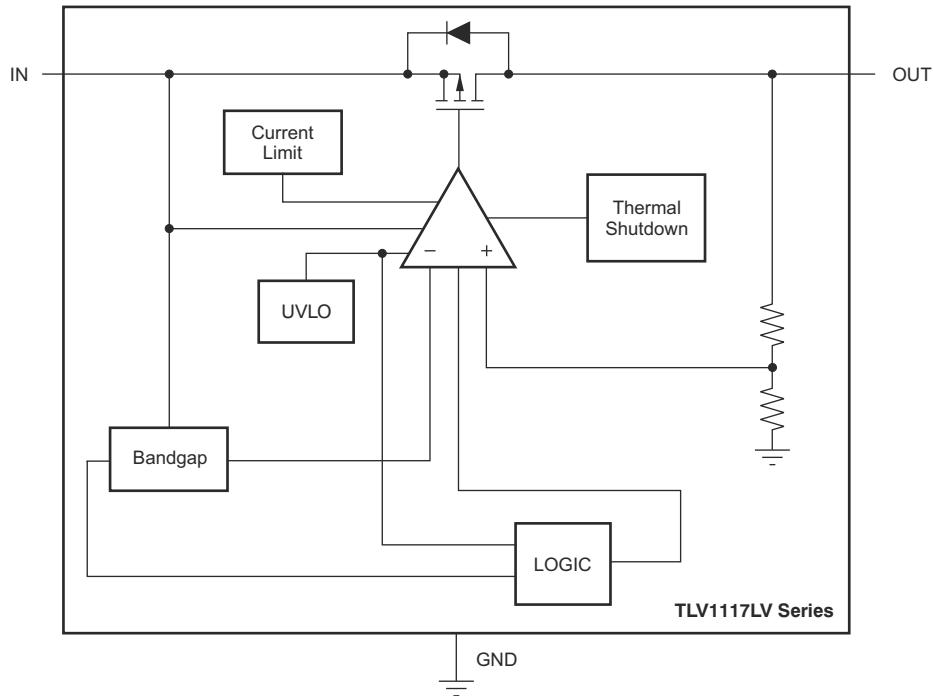

7.3 Feature Description

7.3.1 Internal Current Limit

The TLV1117LV internal current limit helps protect the regulator during fault conditions. During current limit, the output sources a fixed amount of current that is largely independent of the output voltage. In such a case, the output voltage is not regulated, and can be calculated by the formula: $V_{OUT} = I_{LIMIT} \times R_{LOAD}$. The PMOS pass transistor dissipates $(V_{IN} - V_{OUT}) \times I_{LIMIT}$ until thermal shutdown is triggered and the device turns off. When the device cools down, the internal thermal shutdown circuit turns the device back on. If the fault condition continues, the device cycles between current limit and thermal shutdown. See the [Thermal Protection](#) section for more details.

The PMOS pass transistor in the TLV1117LV has a built-in body diode that conducts current when the voltage at OUT exceeds the voltage at IN. This current is not limited; if extended reverse voltage operation is anticipated, external limiting to 5% of the rated output current is recommended.

7.3.2 Dropout Voltage

The TLV1117LV uses a PMOS pass transistor to achieve low dropout. When $(V_{IN} - V_{OUT})$ is less than the dropout voltage (V_{DO}), the PMOS pass transistor is in the linear region of operation and the input-to-output resistance is the $R_{DS(ON)}$ of the PMOS pass transistor. V_{DO} scales approximately with output current because the PMOS transistor behaves like a resistor in dropout.

As with any linear regulator, PSRR and transient response are degraded when $(V_{IN} - V_{OUT})$ approaches dropout.

7.3.3 Undervoltage Lockout

The TLV1117LV uses an undervoltage lockout (UVLO) circuit to keep the output shut off until internal circuitry is operating properly.

7.4 Device Functional Modes

7.4.1 Normal Operation

The device regulates to the nominal output voltage under the following conditions:

- The input voltage is greater than the nominal output voltage added to the dropout voltage
- The output current is less than the current limit
- The device die temperature is lower than the thermal shutdown temperature

7.4.2 Dropout Operation

If the input voltage is lower than the nominal output voltage plus the specified dropout voltage, but all other conditions are met for normal operation, the device operates in dropout mode. In this condition, the output voltage is the same the input voltage minus the dropout voltage. The transient performance of the device is significantly degraded because the pass transistor is in a triode state and no longer controls the current through the LDO. Line or load transients in dropout can result in large output voltage deviations.

表 7-1 shows the conditions that lead to the different modes of operation.

表 7-1. Device Functional Mode Comparison

OPERATING MODE	PARAMETER	
	V_{IN}	I_{OUT}
Normal mode	$V_{IN} > V_{OUT(nom)} + V_{DO}$	$I_{OUT} < I_{CL}$
Dropout mode	$V_{IN} < V_{OUT(nom)} + V_{DO}$	$I_{OUT} < I_{CL}$

8 Application and Implementation

备注

以下应用部分中的信息不属于 TI 器件规格的范围，TI 不担保其准确性和完整性。TI 的客户应负责确定器件是否适用于其应用。客户应验证并测试其设计，以确保系统功能。

8.1 Application Information

The TLV1117LV is a low quiescent current linear regulator designed for high current applications. Unlike typical high current linear regulators, the TLV1117LV consumes significantly less quiescent current. This device delivers excellent line and load transient performance. The device is low noise, and exhibits a very good PSRR. As a result, this device is designed for high current applications that require very sensitive power-supply rails.

This regulators offer both current limit and thermal protection. The operating junction temperature range of the device is -40°C to $+125^{\circ}\text{C}$.

8.2 Typical Application

图 8-1 shows a typical application circuit.



图 8-1. Typical Application Circuit

8.2.1 Design Requirements

For this design example, use the parameters listed in 表 8-1 as the input parameters.

表 8-1. Design Parameters

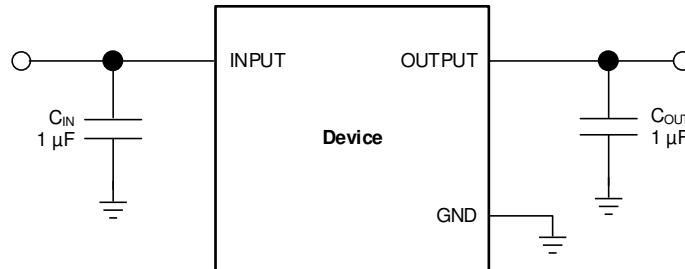
PARAMETER	DESIGN REQUIREMENT
Input voltage	2.5 V to 3.3 V
Output voltage	1.8 V
Output current	500 mA

8.2.2 Detailed Design Procedure

8.2.2.1 Input and Output Capacitor Requirements

For stability, $1.0\text{-}\mu\text{F}$ ceramic capacitors are required at the output. Higher-valued capacitors improve transient performance. Use X5R- and X7R-type ceramic capacitors because these capacitors have minimal variation in value and equivalent series resistance (ESR) over temperature. Unlike traditional linear regulators that need a minimum ESR for stability, the TLV1117LV is specified to be stable with no ESR. Therefore, cost-effective ceramic capacitors can be used with this device. Effective output capacitance that takes bias, temperature, and aging effects into consideration must be greater than $0.5\text{-}\mu\text{F}$ to ensure stability of the device.

Although an input capacitor is not required for stability, good analog design practice is to connect a $0.1\text{-}\mu\text{F}$ to $1.0\text{-}\mu\text{F}$, low-ESR capacitor across the IN pin and GND pin of the regulator. This capacitor counteracts reactive input sources and improves transient response, noise rejection, and ripple rejection. A higher-value capacitor can be necessary if large, fast rise-time load transients are anticipated, or if the device is not located physically

close to the power source. If source impedance is greater than $2\ \Omega$, a $0.1\text{-}\mu\text{F}$ input capacitor can also be necessary to ensure stability.

8.2.2.2 Transient Response

As with any regulator, increasing the size of the output capacitor reduces overshoot and undershoot magnitude.

8.2.3 Application Curves

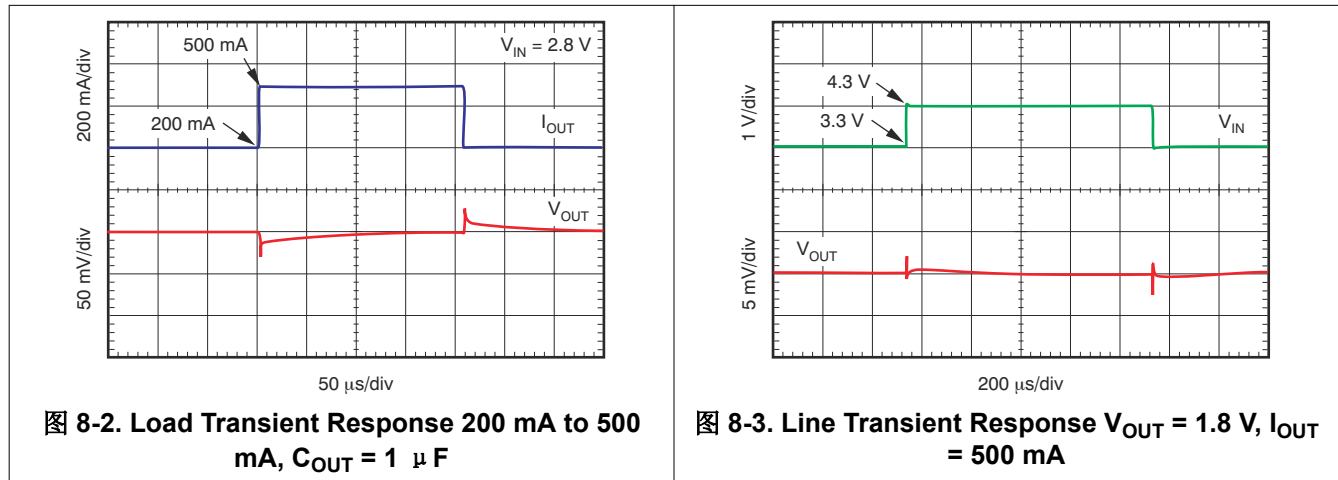

8.3 Best Design Practices

Place input and output capacitors as close to the device as possible.

Use a ceramic output capacitor.

Do not use an electrolytic output capacitor.

Do not exceed the device absolute maximum ratings.

8.4 Power Supply Recommendations

Connect a low output impedance power supply directly to the INPUT pin of the TLV1117LV. Inductive impedances between the input supply and the INPUT pin can create significant voltage excursions at the INPUT pin during start-up or load transient events.

8.5 Layout

8.5.1 Layout Guidelines

Place input and output capacitors as close to the device pins as possible. To improve characteristic AC performance (such as PSRR, output noise, and transient response), design the board with separate ground planes for V_{IN} and V_{OUT} , with the ground plane connected only at the GND pin of the device. In addition, the ground connection for the output capacitor must be connected directly to the GND pin of the device. Higher value ESR capacitors can degrade PSRR performance.

8.5.1.1 Thermal Protection

Thermal protection disables the output when the junction temperature rises to approximately 165°C , allowing the device to cool. When the junction temperature cools to approximately 145°C , the output circuitry is again enabled. Depending on power dissipation, thermal resistance, and ambient temperature, the thermal protection circuit can cycle on and off. This cycling limits the dissipation of the regulator, protecting the regulator from damage as a result of overheating.

Any tendency to activate the thermal protection circuit indicates excessive power dissipation or an inadequate heat sink. For reliable operation, limit junction temperature to 125°C maximum. To estimate the margin of safety

in a complete design (including heat sink), increase the ambient temperature until the thermal protection is triggered; use worst-case loads and signal conditions.

The internal protection circuitry of the TLV1117LV is designed to protect against overload conditions. This circuitry is not intended to replace proper heat sinking. Continuously running the TLV1117LV into thermal shutdown degrades device reliability.

8.5.1.2 Power Dissipation

The ability to remove heat from the die is different for each package type, presenting different considerations in the printed circuit board (PCB) layout. The PCB area around the device that is free of other components moves the heat from the device to the ambient air. Performance data for JEDEC low and high-K boards are given in the [Thermal Information](#) table. Using heavier copper increases the effectiveness in removing heat from the device. The addition of plated through-holes to heat-dissipating layers also improves heat-sink effectiveness.

Power dissipation depends on input voltage and load conditions. Power dissipation (P_D) is equal to the product of the output current and the voltage drop across the output pass element, as shown in [方程式 1](#):

$$P_D = (V_{IN} - V_{OUT}) I_{OUT} \quad (1)$$

8.5.2 Layout Example



图 8-4. Layout Example

9 Device and Documentation Support

9.1 Device Support

9.1.1 Development Support

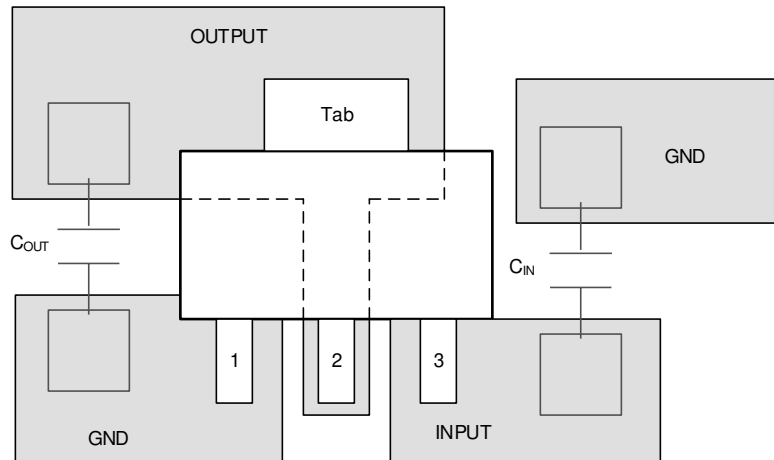
9.1.1.1 Evaluation Module

An evaluation module (EVM) is available to assist in the initial circuit performance evaluation using the TLV1117LV. The [TLV1117LV33EVM-714 evaluation module](#) (and [related user's guide](#)) can be requested at the TI website through the product folders or purchased directly from [the TI eStore](#).

9.1.1.2 Spice Models

Computer simulation of circuit performance using SPICE is often useful when analyzing the performance of analog circuits and systems. A SPICE model for the TLV1117LV is available through the product folders under *Tools & Software*.

9.1.2 Device Nomenclature

表 9-1. Available Options⁽¹⁾

PRODUCT	V _{OUT}
TLV1117LVxxyyyz	xx is the nominal output voltage (for example 33 = 3.3 V). yyy is the package designator. z is the package quantity.

(1) For the most current package and ordering information, see the Package Option Addendum at the end of this document, or visit the device product folder at www.ti.com.

9.2 Documentation Support

9.2.1 Related Documentation

For related documentation see the following:

- Texas Instruments, [TLV1117LVxxEVM-714 Evaluation Module user's guide](#)

9.3 接收文档更新通知

要接收文档更新通知，请导航至 ti.com 上的器件产品文件夹。点击 [订阅更新](#) 进行注册，即可每周接收产品信息更改摘要。有关更改的详细信息，请查看任何已修订文档中包含的修订历史记录。

9.4 支持资源

[TI E2E™ 支持论坛](#) 是工程师的重要参考资料，可直接从专家获得快速、经过验证的解答和设计帮助。搜索现有解答或提出自己的问题可获得所需的快速设计帮助。

链接的内容由各个贡献者“按原样”提供。这些内容并不构成 TI 技术规范，并且不一定反映 TI 的观点；请参阅 TI 的《[使用条款](#)》。

9.5 Trademarks

TI E2E™ is a trademark of Texas Instruments.

所有商标均为其各自所有者的财产。

9.6 静电放电警告



静电放电 (ESD) 会损坏这个集成电路。德州仪器 (TI) 建议通过适当的预防措施处理所有集成电路。如果不遵守正确的处理和安装程序，可能会损坏集成电路。

ESD 的损坏小至导致微小的性能降级，大至整个器件故障。精密的集成电路可能更容易受到损坏，这是因为非常细微的参数更改都可能会导致器件与其发布的规格不相符。

9.7 术语表

TI 术语表

本术语表列出并解释了术语、首字母缩略词和定义。

10 Mechanical, Packaging, and Orderable Information

The following pages include mechanical, packaging, and orderable information. This information is the most current data available for the designated devices. This data is subject to change without notice and revision of this document. For browser-based versions of this data sheet, refer to the left-hand navigation.

PACKAGING INFORMATION

Orderable part number	Status (1)	Material type (2)	Package Pins	Package qty Carrier	RoHS (3)	Lead finish/ Ball material (4)	MSL rating/ Peak reflow (5)	Op temp (°C)	Part marking (6)
TLV1117LV12DCYR	NRND	Production	SOT-223 (DCY) 4	2500 LARGE T&R	Yes	SN	Level-1-260C-UNLIM	-40 to 125	SI
TLV1117LV12DCYR.B	NRND	Production	SOT-223 (DCY) 4	2500 LARGE T&R	Yes	SN	Level-1-260C-UNLIM	-40 to 125	SI
TLV1117LV15DCYR	Active	Production	SOT-223 (DCY) 4	2500 LARGE T&R	Yes	SN	Level-1-260C-UNLIM	-40 to 125	VR
TLV1117LV15DCYR.B	Active	Production	SOT-223 (DCY) 4	2500 LARGE T&R	Yes	SN	Level-1-260C-UNLIM	-40 to 125	VR
TLV1117LV15DCYT	Obsolete	Production	SOT-223 (DCY) 4	-	-	Call TI	Call TI	-40 to 125	VR
TLV1117LV18DCYR	Active	Production	SOT-223 (DCY) 4	2500 LARGE T&R	Yes	SN	Level-1-260C-UNLIM	-40 to 125	SH
TLV1117LV18DCYR.B	Active	Production	SOT-223 (DCY) 4	2500 LARGE T&R	Yes	SN	Level-1-260C-UNLIM	-40 to 125	SH
TLV1117LV18DCYT	Active	Production	SOT-223 (DCY) 4	250 SMALL T&R	Yes	SN	Level-1-260C-UNLIM	-40 to 125	SH
TLV1117LV18DCYT.B	Active	Production	SOT-223 (DCY) 4	250 SMALL T&R	Yes	SN	Level-1-260C-UNLIM	-40 to 125	SH
TLV1117LV25DCYR	Active	Production	SOT-223 (DCY) 4	2500 LARGE T&R	Yes	SN	Level-1-260C-UNLIM	-40 to 125	VS
TLV1117LV25DCYR.B	Active	Production	SOT-223 (DCY) 4	2500 LARGE T&R	Yes	SN	Level-1-260C-UNLIM	-40 to 125	VS
TLV1117LV25DCYT	Active	Production	SOT-223 (DCY) 4	250 SMALL T&R	Yes	SN	Level-1-260C-UNLIM	-40 to 125	VS
TLV1117LV25DCYT.B	Active	Production	SOT-223 (DCY) 4	250 SMALL T&R	Yes	SN	Level-1-260C-UNLIM	-40 to 125	VS
TLV1117LV28DCYR	Active	Production	SOT-223 (DCY) 4	2500 LARGE T&R	Yes	SN	Level-1-260C-UNLIM	-40 to 125	VT
TLV1117LV28DCYR.B	Active	Production	SOT-223 (DCY) 4	2500 LARGE T&R	Yes	SN	Level-1-260C-UNLIM	-40 to 125	VT
TLV1117LV28DCYT	Obsolete	Production	SOT-223 (DCY) 4	-	-	Call TI	Call TI	-40 to 125	VT
TLV1117LV30DCYR	Active	Production	SOT-223 (DCY) 4	2500 LARGE T&R	Yes	SN	Level-1-260C-UNLIM	-40 to 125	VU
TLV1117LV30DCYR.B	Active	Production	SOT-223 (DCY) 4	2500 LARGE T&R	Yes	SN	Level-1-260C-UNLIM	-40 to 125	VU
TLV1117LV30DCYT	Obsolete	Production	SOT-223 (DCY) 4	-	-	Call TI	Call TI	-40 to 125	VU
TLV1117LV33DCYR	Active	Production	SOT-223 (DCY) 4	2500 LARGE T&R	Yes	SN	Level-1-260C-UNLIM	-40 to 125	TJ
TLV1117LV33DCYR.A	Active	Production	SOT-223 (DCY) 4	2500 LARGE T&R	Yes	SN	Level-1-260C-UNLIM	-40 to 125	TJ
TLV1117LV33DCYR.B	Active	Production	SOT-223 (DCY) 4	2500 LARGE T&R	Yes	SN	Level-1-260C-UNLIM	-40 to 125	TJ
TLV1117LV33DCYT	Obsolete	Production	SOT-223 (DCY) 4	-	-	SN	Level-1-260C-UNLIM	-40 to 125	TJ

(1) **Status:** For more details on status, see our [product life cycle](#).

(2) **Material type:** When designated, preproduction parts are prototypes/experimental devices, and are not yet approved or released for full production. Testing and final process, including without limitation quality assurance, reliability performance testing, and/or process qualification, may not yet be complete, and this item is subject to further changes or possible discontinuation. If available for ordering, purchases will be subject to an additional waiver at checkout, and are intended for early internal evaluation purposes only. These items are sold without warranties of any kind.

(3) **RoHS values:** Yes, No, RoHS Exempt. See the [TI RoHS Statement](#) for additional information and value definition.

(4) **Lead finish/Ball material:** Parts may have multiple material finish options. Finish options are separated by a vertical ruled line. Lead finish/Ball material values may wrap to two lines if the finish value exceeds the maximum column width.

(5) **MSL rating/Peak reflow:** The moisture sensitivity level ratings and peak solder (reflow) temperatures. In the event that a part has multiple moisture sensitivity ratings, only the lowest level per JEDEC standards is shown. Refer to the shipping label for the actual reflow temperature that will be used to mount the part to the printed circuit board.

(6) **Part marking:** There may be an additional marking, which relates to the logo, the lot trace code information, or the environmental category of the part.

Multiple part markings will be inside parentheses. Only one part marking contained in parentheses and separated by a "~" will appear on a part. If a line is indented then it is a continuation of the previous line and the two combined represent the entire part marking for that device.

Important Information and Disclaimer: The information provided on this page represents TI's knowledge and belief as of the date that it is provided. TI bases its knowledge and belief on information provided by third parties, and makes no representation or warranty as to the accuracy of such information. Efforts are underway to better integrate information from third parties. TI has taken and continues to take reasonable steps to provide representative and accurate information but may not have conducted destructive testing or chemical analysis on incoming materials and chemicals. TI and TI suppliers consider certain information to be proprietary, and thus CAS numbers and other limited information may not be available for release.

In no event shall TI's liability arising out of such information exceed the total purchase price of the TI part(s) at issue in this document sold by TI to Customer on an annual basis.

TAPE AND REEL INFORMATION

QUADRANT ASSIGNMENTS FOR PIN 1 ORIENTATION IN TAPE

*All dimensions are nominal

Device	Package Type	Package Drawing	Pins	SPQ	Reel Diameter (mm)	Reel Width W1 (mm)	A0 (mm)	B0 (mm)	K0 (mm)	P1 (mm)	W (mm)	Pin1 Quadrant
TLV1117LV12DCYR	SOT-223	DCY	4	2500	330.0	12.4	7.05	7.4	1.9	8.0	12.0	Q3
TLV1117LV15DCYR	SOT-223	DCY	4	2500	330.0	12.4	7.05	7.4	1.9	8.0	12.0	Q3
TLV1117LV18DCYR	SOT-223	DCY	4	2500	330.0	12.4	7.05	7.4	1.9	8.0	12.0	Q3
TLV1117LV18DCYT	SOT-223	DCY	4	250	180.0	12.4	7.05	7.4	1.9	8.0	12.0	Q3
TLV1117LV25DCYR	SOT-223	DCY	4	2500	330.0	12.4	7.05	7.4	1.9	8.0	12.0	Q3
TLV1117LV25DCYT	SOT-223	DCY	4	250	180.0	12.4	7.05	7.4	1.9	8.0	12.0	Q3
TLV1117LV28DCYR	SOT-223	DCY	4	2500	330.0	12.4	7.05	7.4	1.9	8.0	12.0	Q3
TLV1117LV30DCYR	SOT-223	DCY	4	2500	330.0	12.4	7.05	7.4	1.9	8.0	12.0	Q3
TLV1117LV33DCYR	SOT-223	DCY	4	2500	330.0	12.4	7.05	7.4	1.9	8.0	12.0	Q3
TLV1117LV33DCYT	SOT-223	DCY	4	0	330.0	12.4	7.05	7.4	1.9	8.0	12.0	Q3

TAPE AND REEL BOX DIMENSIONS

*All dimensions are nominal

Device	Package Type	Package Drawing	Pins	SPQ	Length (mm)	Width (mm)	Height (mm)
TLV1117LV12DCYR	SOT-223	DCY	4	2500	340.0	340.0	38.0
TLV1117LV15DCYR	SOT-223	DCY	4	2500	340.0	340.0	38.0
TLV1117LV18DCYR	SOT-223	DCY	4	2500	340.0	340.0	38.0
TLV1117LV18DCYT	SOT-223	DCY	4	250	340.0	340.0	38.0
TLV1117LV25DCYR	SOT-223	DCY	4	2500	340.0	340.0	38.0
TLV1117LV25DCYT	SOT-223	DCY	4	250	340.0	340.0	38.0
TLV1117LV28DCYR	SOT-223	DCY	4	2500	340.0	340.0	38.0
TLV1117LV30DCYR	SOT-223	DCY	4	2500	340.0	340.0	38.0
TLV1117LV33DCYR	SOT-223	DCY	4	2500	340.0	340.0	38.0
TLV1117LV33DCYT	SOT-223	DCY	4	0	340.0	340.0	38.0

DCY (R-PDSO-G4)

PLASTIC SMALL-OUTLINE



- NOTES: A. All linear dimensions are in millimeters (inches).
 B. This drawing is subject to change without notice.
 C. Body dimensions do not include mold flash or protrusion.
 D. Falls within JEDEC TO-261 Variation AA.

DCY (R-PDSO-G4)

PLASTIC SMALL OUTLINE

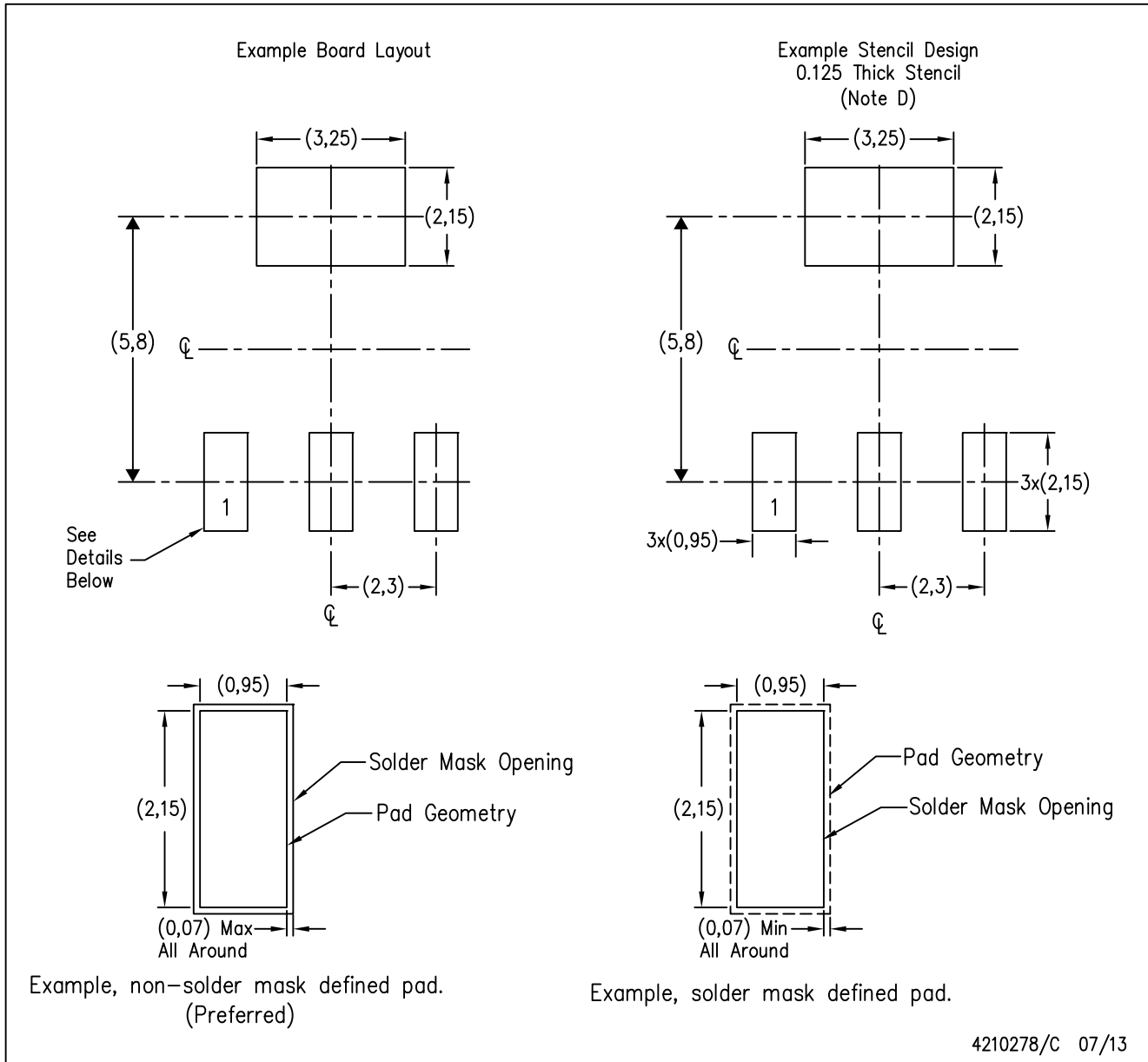

- NOTES:
- A. All linear dimensions are in millimeters.
 - B. This drawing is subject to change without notice.
 - C. Publication IPC-7351 is recommended for alternate designs.
 - D. Laser cutting apertures with trapezoidal walls and also rounding corners will offer better paste release. Customers should contact their board assembly site for stencil recommendations. Refer to IPC 7525 for stencil design considerations.

重要通知和免责声明

TI“按原样”提供技术和可靠性数据（包括数据表）、设计资源（包括参考设计）、应用或其他设计建议、网络工具、安全信息和其他资源，不保证没有瑕疵且不做任何明示或暗示的担保，包括但不限于对适销性、与某特定用途的适用性或不侵犯任何第三方知识产权的暗示担保。

这些资源可供使用 TI 产品进行设计的熟练开发人员使用。您将自行承担以下全部责任：(1) 针对您的应用选择合适的 TI 产品，(2) 设计、验证并测试您的应用，(3) 确保您的应用满足相应标准以及任何其他安全、安保法规或其他要求。

这些资源如有变更，恕不另行通知。TI 授权您仅可将这些资源用于研发本资源所述的 TI 产品的相关应用。严禁以其他方式对这些资源进行复制或展示。您无权使用任何其他 TI 知识产权或任何第三方知识产权。对于因您对这些资源的使用而对 TI 及其代表造成的任何索赔、损害、成本、损失和债务，您将全额赔偿，TI 对此概不负责。

TI 提供的产品受 [TI 销售条款](#)、[TI 通用质量指南](#) 或 [ti.com](#) 上其他适用条款或 TI 产品随附的其他适用条款的约束。TI 提供这些资源并不会扩展或以其他方式更改 TI 针对 TI 产品发布的适用的担保或担保免责声明。除非德州仪器 (TI) 明确将某产品指定为定制产品或客户特定产品，否则其产品均为按确定价格收入目录的标准通用器件。

TI 反对并拒绝您可能提出的任何其他或不同的条款。

版权所有 © 2026，德州仪器 (TI) 公司

最后更新日期：2025 年 10 月