

## Advanced LinCMOS™ RAIL-TO-RAIL OUTPUT WIDE-INPUT-VOLTAGE OPERATIONAL AMPLIFIERS

### FEATURES

- Qualified for Automotive Applications
- ESD Protection Exceeds 2000 V Per MIL-STD-883, Method 3015; Exceeds 200 V Using Machine Model (C = 200 pF, R = 0)
- Output Swing Includes Both Supply Rails
- Extended Common-Mode Input Voltage Range: 0 V to 4.25 V (Min) at 5-V Single Supply
- No Phase Inversion
- Low Noise: 16 nV/ $\sqrt{\text{Hz}}$  Typ at  $f = 1 \text{ kHz}$
- Low Input Offset Voltage: 950  $\mu\text{V}$  Max at  $T_A = 25^\circ\text{C}$  (TLV244xA)
- Low Input Bias Current: 1 pA (Typ)
- 600- $\Omega$  Output Drive
- High-Gain Bandwidth: 1.8 MHz (Typ)
- Low Supply Current: 750  $\mu\text{A}$  Per Channel (Typ)
- Macromodel Included

### DESCRIPTION

The TLV244x and TLV244xA are low-voltage operational amplifiers from Texas Instruments. The common-mode input voltage range of these devices has been extended over typical standard CMOS amplifiers, making them suitable for a wide range of applications. In addition, these devices do not phase invert when the common-mode input is driven to the supply rails. This satisfies most design requirements without paying a premium for rail-to-rail input performance. They also exhibit rail-to-rail output performance for increased dynamic range in single- or split-supply applications. This family is fully characterized at 3-V and 5-V supplies and is optimized for low-voltage operation. Both devices offer comparable ac performance while having lower noise, input offset voltage, and power dissipation than existing CMOS operational amplifiers. The TLV244x has increased output drive over previous rail-to-rail operational amplifiers and can drive 600- $\Omega$  loads for telecommunications applications.

The other members in the TLV244x family are the low-power, TLV243x, and micro-power, TLV2422, versions.

The TLV244x, exhibiting high input impedance and low noise, is excellent for small-signal conditioning for high-impedance sources, such as piezoelectric transducers. Because of the micropower dissipation levels and low-voltage operation, these devices work well in hand-held monitoring and remote-sensing applications. In addition, the rail-to-rail output feature with single- or split-supplies makes this family a great choice when interfacing with analog-to-digital converters (ADCs). For precision applications, the TLV244xA is available with a maximum input offset voltage of 950  $\mu\text{V}$ .

If the design requires single operational amplifiers, see the TI TLV2211/21/31. This is a family of rail-to-rail output operational amplifiers in the SOT-23 package. Their small size and low power consumption make them ideal for high-density battery-powered equipment.

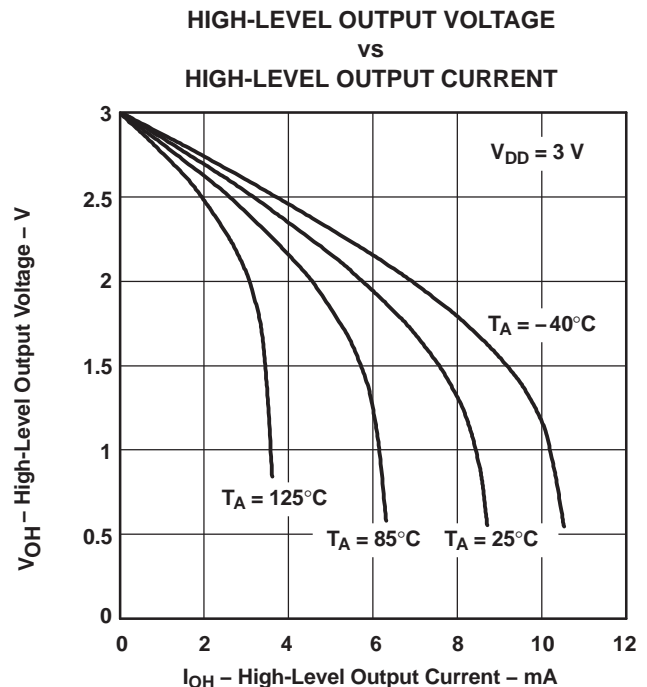

Figure 1.



Please be aware that an important notice concerning availability, standard warranty, and use in critical applications of Texas Instruments semiconductor products and disclaimers thereto appears at the end of this data sheet.

Advanced LinCMOS is a trademark of Texas Instruments.  
PSPICE, Parts are trademarks of MicroSim.

**ORDERING INFORMATION<sup>(1)</sup>**

T <sub>A</sub>	V <sub>IO</sub> max AT 25 = C	PACKAGE <sup>(2)</sup>			ORDERABLE PART NUMBER	TOP-SIDE MARKING
-40°C to 125°C	950 μV	Dual	SOIC – D	Reel of 2500	TLV2442AQDRQ1	2442AQ
			TSSOP – PW	Reel of 2000	TLV2442AQPWRQ1	2442AQ
	2.5 mV	Dual	MSOP – DGK	Reel of 2500	TLV2442QDGKRQ1	OBR
			SOIC – D	Reel of 2500	TLV2442QDRQ1	2442Q1
			TSSOP – PW	Reel of 2000	TLV2442QPWRQ1	2442Q1
	950 μV	Quad	TSSOP – PW	Reel of 2000	TLV2444AQPWRQ1	2444AQ

- (1) For the most current package and ordering information, see the Package Option Addendum at the end of this document, or see the TI web site at [www.ti.com](http://www.ti.com).  
 (2) Package drawings, thermal data, and symbolization are available at [www.ti.com/packaging](http://www.ti.com/packaging).

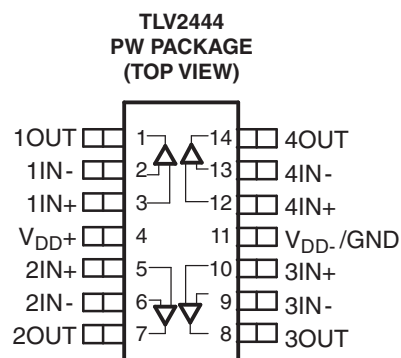
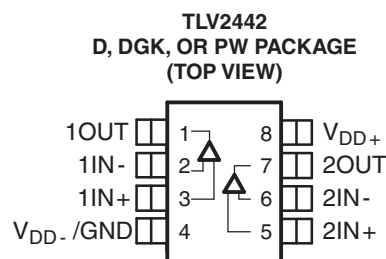

EQUIVALENT SCHEMATIC (EACH AMPLIFIER)

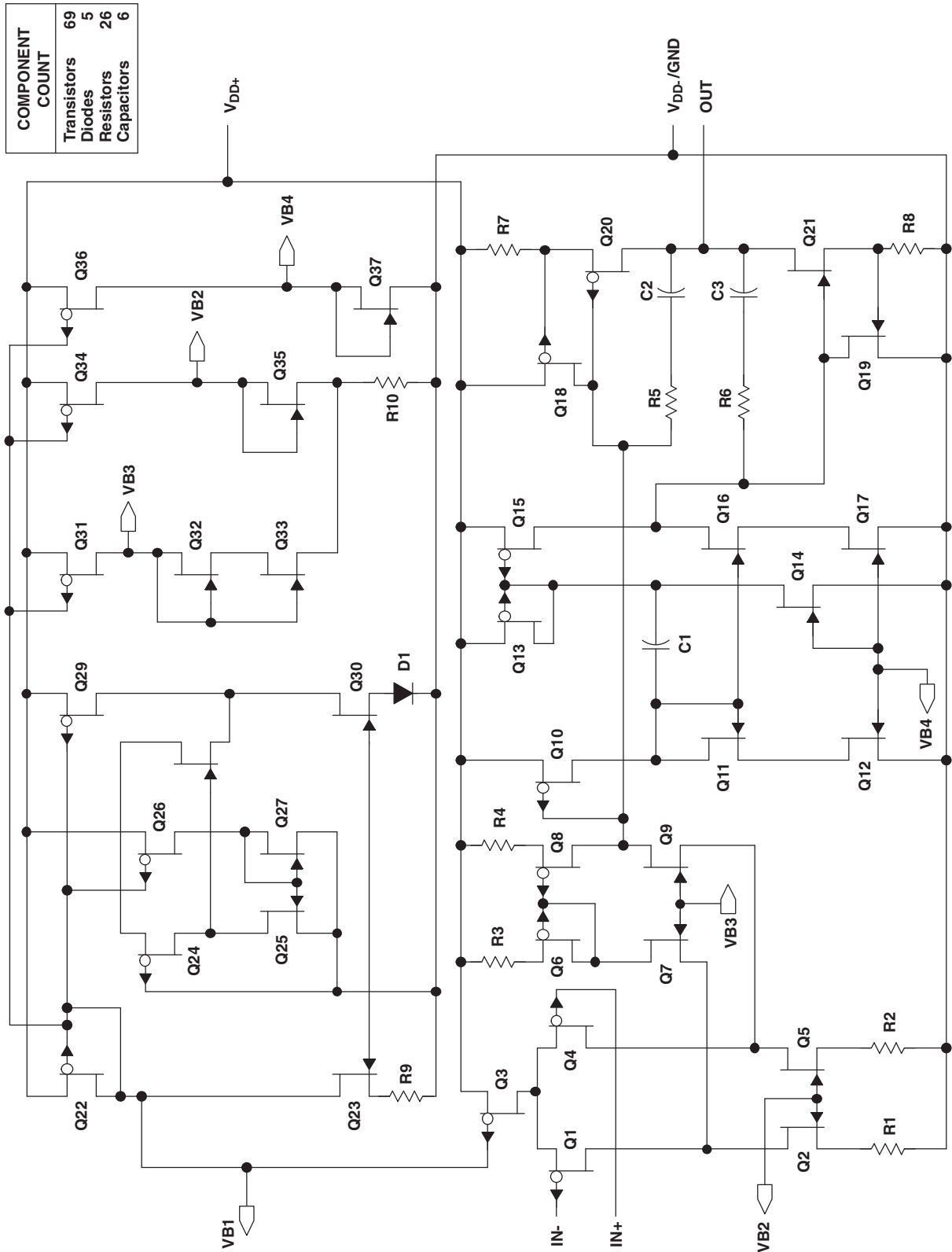

COMPONENT COUNT	
Transistors	69
Diodes	5
Resistors	26
Capacitors	6

## ABSOLUTE MAXIMUM RATINGS<sup>(1)</sup>

over operating free-air temperature range (unless otherwise noted)

V <sub>DD</sub>	Supply voltage <sup>(2)</sup>	12 V
V <sub>ID</sub>	Differential input voltage <sup>(3)</sup>	±V <sub>DD</sub>
V <sub>I</sub>	Input voltage (any input) <sup>(2)</sup>	−0.3 V to V <sub>DD</sub>
I <sub>I</sub>	Input current (any input)	±5 mA
I <sub>O</sub>	Output current	±50 mA
	Total current into V <sub>DD+</sub>	±50 mA
	Total current out of V <sub>DD−</sub>	±50 mA
	Duration of short-circuit current at (or below) 25 = C <sup>(4)</sup>	Unlimited
	Continuous total dissipation	See Dissipation Rating Table
T <sub>A</sub>	Operating free-air temperature range	−40°C to 125°C
T <sub>stg</sub>	Storage temperature range	−65°C to 150°C
	Lead temperature 1,6 mm (1/16 inch) from case for 10 seconds	260°C

- (1) Stresses beyond those listed under *absolute maximum ratings* may cause permanent damage to the device. These are stress ratings only, and functional operation of the device at these or any other conditions beyond those indicated under *recommended operating conditions* is not implied. Exposure to absolute-maximum-rated conditions for extended periods may affect device reliability.
- (2) All voltage values, except differential voltages, are with respect to the midpoint between V<sub>DD+</sub> and V<sub>DD−</sub>.
- (3) Differential voltages are at IN+ with respect to IN−. Excessive current will flow if input is brought below V<sub>DD−</sub> − 0.3 V.
- (4) The output may be shorted to either supply. Temperature and/or supply voltages must be limited to ensure that the maximum dissipation rating is not exceeded.

## DISSIPATION RATINGS

PACKAGE	T <sub>A</sub> ≤ 25°C POWER RATING	DERATING FACTOR ABOVE T <sub>A</sub> = 25°C	T <sub>A</sub> = 70°C POWER RATING	T <sub>A</sub> = 85°C POWER RATING	T <sub>A</sub> = 125°C POWER RATING
D (8 pin)	725 mW	5.8 mW/°C	464 mW	377 mW	145 mW
DGK (8 pin)	606 mW	4.847 mW/°C	388 mW	315 mW	121 mW
PW (8 pin)	525 mW	4.2 mW/°C	336 mW	273 mW	105 mW
PW (14 pin)	720 mW	5.6 mW/°C	634 mW	547 mW	317 mW

## RECOMMENDED OPERATING CONDITIONS

		MIN	MAX	UNIT
V <sub>DD</sub>	Supply voltage	2.7	10	V
V <sub>I</sub>	Input voltage	V <sub>DD−</sub>	V <sub>DD+</sub> − 1	V
V <sub>IC</sub>	Common-mode input voltage	V <sub>DD−</sub>	V <sub>DD+</sub> − 1	V
T <sub>A</sub>	Operating free-air temperature	−40	125	°C

## ELECTRICAL CHARACTERISTICS

 $V_{DD} = 3\text{ V}$ , at specified free-air temperature (unless otherwise noted)

PARAMETER	TEST CONDITIONS	$T_A$ <sup>(1)</sup>	MIN	TYP	MAX	UNIT
$V_{IO}$ Input offset voltage	$V_{IC} = 1.5\text{ V}$ , $V_O = 1.5\text{ V}$ , $R_S = 50\ \Omega$	TLV244x	25°C	300	2000	$\mu\text{V}$
			Full range		2500	
		TLV244xA	25°C	300	950	
			Full range		1600	
$\alpha_{VIO}$ Temperature coefficient of input offset voltage	$V_{IC} = 1.5\text{ V}$ , $V_O = 1.5\text{ V}$ , $R_S = 50\ \Omega$	25°C to 85°C		2		$\mu\text{V}/^\circ\text{C}$
Input offset voltage long-term drift <sup>(2)</sup>	$V_{IC} = 1.5\text{ V}$ , $V_O = 1.5\text{ V}$ , $R_S = 50\ \Omega$	25°C		0.002		$\mu\text{V}/\text{mo}$
$I_{IO}$ Input offset current	$V_{IC} = 1.5\text{ V}$ , $V_O = 1.5\text{ V}$ , $R_S = 50\ \Omega$	25°C		0.5		$\text{pA}$
		Full range			150	
$I_{IB}$ Input bias current	$V_{IC} = 1.5\text{ V}$ , $V_O = 1.5\text{ V}$ , $R_S = 50\ \Omega$	25°C		1		$\text{pA}$
		Full range			260	
$V_{ICR}$ Common-mode input voltage range	$ V_{IO}  \leq 8\text{ mV}$ , $R_S = 50\ \Omega$	25°C	0 to 2.25	-0.25 to 2.5		$\text{V}$
		Full range	0.2 to 2			
$V_{OH}$ High-level output voltage	$I_O = -100\ \mu\text{A}$	25°C		2.98		$\text{V}$
	$I_O = -3\text{ mA}$	25°C		2.5		
	Full range		2.25			
$V_{OL}$ Low-level output voltage	$V_{IC} = 1.5\text{ V}$	$I_O = 100\ \mu\text{A}$	25°C	0.02		$\text{V}$
		$I_O = 3\text{ mA}$	25°C	0.63		
		Full range			1	
$A_{VD}$ Large-signal differential voltage amplification	$V_O = 1\text{ V to }2\text{ V}$	$R_L = 600\ \Omega$	25°C	0.7	1	$\text{V/mV}$
			Full range	0.4		
		$R_L = 1\text{ M}\Omega$	25°C		750	
$r_{id}$ Differential input resistance		25°C		1000		$\text{G}\Omega$
$r_i$ Common-mode input resistance		25°C		1000		$\text{G}\Omega$
$c_i$ Common-mode input capacitance	$f = 10\text{ kHz}$	25°C		8		$\text{pF}$
$z_o$ Closed-loop output impedance	$f = 1\text{ MHz}$ , $A_V = 10$	25°C		130		$\Omega$
CMRR Common-mode rejection ratio	$V_{IC} = V_{ICR\text{ MIN}}$ , $V_O = V_{DD}/2$ , $R_S = 50\ \Omega$	25°C	65	75		$\text{dB}$
		Full range	50			
$k_{SVR}$ Supply-voltage rejection ratio ( $\Delta V_{DD\pm}/\Delta V_{IO}$ )	$V_{DD} = 2.7\text{ V to }8\text{ V}$ , $V_{IC} = V_{DD}/2$ , No load	25°C	80	95		$\text{dB}$
		Full range	80			
$I_{DD}$ Supply current (per channel)	$V_O = 1.5\text{ V}$ , No load	25°C		725	1100	$\mu\text{A}$
		Full range			1100	

(1) Full range is  $-40^\circ\text{C}$  to  $125^\circ\text{C}$ .

(2) Typical values are based on the input offset voltage shift observed through 168 hours of operating life test at  $T_A = 150^\circ\text{C}$  extrapolated to  $T_A = 25^\circ\text{C}$  using the Arrhenius equation and assuming an activation energy of 0.96 eV.

## OPERATING CHARACTERISTICS

$V_{DD} = 3\text{ V}$ , at specified free-air temperature (unless otherwise noted)

PARAMETER		TEST CONDITIONS		$T_A^{(1)}$	MIN	TYP	MAX	UNIT
SR	Slew rate at unity gain	$V_O = 1\text{ V to }2\text{ V}$ , $R_L = 600\ \Omega$ , $C_L = 100\text{ pF}$		25°C	0.65	1.3		V/ $\mu\text{s}$
				Full range	0.4			
$V_n$	Equivalent input noise voltage			25°C	170			nV/ $\sqrt{\text{Hz}}$
					18			
$V_{n(PP)}$	Peak-to-peak equivalent input noise voltage	$f = 0.1\text{ Hz to }1\text{ Hz}$ $f = 0.1\text{ Hz to }10\text{ Hz}$		25°C	2.6			$\mu\text{V}$
					5.1			
$I_n$	Equivalent input noise current			25°C	0.6			fA/ $\sqrt{\text{Hz}}$
THD+N	Total harmonic distortion plus noise	$V_O = 0.5\text{ V to }2.5\text{ V}$ , $R_L = 600\ \Omega$ , $f = 1\text{ kHz}$		25°C	$A_V = 1$			%
					$A_V = 10$			
					$A_V = 100$			
	Gain-bandwidth product	$f = 10\text{ kHz}$ , $R_L = 600\ \Omega$ , $C_L = 100\text{ pF}$		25°C	1.75			MHz
BOM	Maximum output-swing bandwidth	$V_{O(PP)} = 1\text{ V}$ , $R_L = 600\ \Omega$ , $A_V = 1$ , $C_L = 100\text{ pF}$		25°C	0.9			MHz
$t_s$	Settling time	$A_V = -1$ , Step = $-2.3\text{ V to }2.3\text{ V}$ , $R_L = 600\ \Omega$ , $C_L = 100\text{ pF}$		25°C	To 0.1%			$\mu\text{s}$
					To 0.01%			
$\phi_m$	Phase margin at unity gain	$R_L = 600\ \Omega$ , $C_L = 100\text{ pF}$		25°C	65			°
	Gain margin	$R_L = 600\ \Omega$ , $C_L = 100\text{ pF}$		25°C	9			dB

(1) Full range is  $-40^\circ\text{C}$  to  $125^\circ\text{C}$ .

## ELECTRICAL CHARACTERISTICS

 $V_{DD} = 5\text{ V}$ , at specified free-air temperature (unless otherwise noted)

PARAMETER	TEST CONDITIONS	$T_A$ <sup>(1)</sup>	MIN	TYP	MAX	UNIT
$V_{IO}$ Input offset voltage	$V_{DD\pm} = \pm 2.5\text{ V}$ , $V_{IC} = 0$ , $V_O = 0$ , $R_S = 50\ \Omega$	TLV244x	25°C	300	2000	$\mu\text{V}$
			Full range		2500	
		TLV244xA	25°C	300	950	
			Full range		1600	
$\alpha_{VIO}$ Temperature coefficient of input offset voltage	$V_{DD\pm} = \pm 2.5\text{ V}$ , $V_{IC} = 0$ , $V_O = 0$ , $R_S = 50\ \Omega$	25°C to 85°C		2		$\mu\text{V}/^\circ\text{C}$
Input offset voltage long-term drift <sup>(2)</sup>	$V_{DD\pm} = \pm 2.5\text{ V}$ , $V_{IC} = 0$ , $V_O = 0$ , $R_S = 50\ \Omega$	25°C		0.002		$\mu\text{V}/\text{mo}$
$I_{IO}$ Input offset current	$V_{DD\pm} = \pm 2.5\text{ V}$ , $V_{IC} = 0$ , $V_O = 0$ , $R_S = 50\ \Omega$	25°C		0.5		$\text{pA}$
		Full range			150	
$I_{IB}$ Input bias current	$V_{DD\pm} = \pm 2.5\text{ V}$ , $V_{IC} = 0$ , $V_O = 0$ , $R_S = 50\ \Omega$	25°C		1		$\text{pA}$
		Full range			260	
$V_{ICR}$ Common-mode input voltage range	$ V_{IO}  \leq 5\text{ mV}$ , $R_S = 50\ \Omega$	25°C	0 to 4.25	-0.25 to 4.5		$\text{V}$
		Full range	0 to 4			
$V_{OH}$ High-level output voltage	$I_{OH} = -100\ \mu\text{A}$ $I_{OH} = -5\text{ mA}$	25°C		4.97		$\text{V}$
		25°C		4	4.35	
		Full range		4		
$V_{OL}$ Low-level output voltage	$V_{IC} = 2.5\text{ V}$	$I_{OL} = 100\ \mu\text{A}$ $I_{OL} = 5\text{ mA}$	25°C		0.01	$\text{V}$
			25°C		0.8	
		Full range			1.25	
$A_{VD}$ Large-signal differential voltage amplification	$V_{IC} = 2.5\text{ V}$ , $V_O = 1\text{ V to }4\text{ V}$	$R_L = 600\ \Omega$ <sup>(3)</sup>	25°C	0.9	1.3	$\text{V}/\text{mV}$
			Full range		0.5	
		$R_L = 1\ \text{M}\Omega$ <sup>(3)</sup>	25°C		950	
$r_{id}$ Differential input resistance		25°C		1000		$\text{G}\Omega$
$r_i$ Common-mode input resistance		25°C		1000		$\text{G}\Omega$
$c_i$ Common-mode input capacitance	$f = 10\text{ kHz}$	25°C		8		$\text{pF}$
$z_o$ Closed-loop output impedance	$f = 1\text{ MHz}$ , $A_V = 10$	25°C		140		$\Omega$
CMRR Common-mode rejection ratio	$V_{IC} = V_{ICR\text{ MIN}}$ , $V_O = V_{DD}/2$ , $R_S = 50\ \Omega$	25°C	70	75		$\text{dB}$
		Full range	70			
$k_{SVR}$ Supply-voltage rejection ratio ( $\Delta V_{DD}/\Delta V_{IO}$ )	$V_{DD} = 4.4\text{ V to }8\text{ V}$ , $V_{IC} = V_{DD}/2$ , No load	25°C	80	95		$\text{dB}$
		Full range	80			
$I_{DD}$ Supply current (per channel)	$V_O = 2.5\text{ V}$ , No load	25°C		750	1100	$\mu\text{A}$
		Full range			1100	

(1) Full range is  $-40^\circ\text{C}$  to  $125^\circ\text{C}$ .

(2) Typical values are based on the input offset voltage shift observed through 168 hours of operating life test at  $T_A = 150^\circ\text{C}$  extrapolated to  $T_A = 25^\circ\text{C}$  using the Arrhenius equation and assuming an activation energy of 0.96 eV.

(3) Referenced to 2.5 V

## OPERATING CHARACTERISTICS

$V_{DD} = 5\text{ V}$ , at specified free-air temperature (unless otherwise noted)

PARAMETER		TEST CONDITIONS		$T_A^{(1)}$	MIN	TYP	MAX	UNIT
SR	Slew rate at unity gain	$V_O = 0.5\text{ V to } 2.5\text{ V}$ , $R_L = 600\ \Omega^{(2)}$ , $C_L = 100\text{ pF}^{(2)}$		25°C	0.75	1.4		V/ $\mu\text{s}$
				Full range	0.5			
$V_n$	Equivalent input noise voltage			25°C	130			nV/ $\sqrt{\text{Hz}}$
					16			
$V_{n(PP)}$	Peak-to-peak equivalent input noise voltage	$f = 0.1\text{ Hz to } 1\text{ Hz}$ $f = 0.1\text{ Hz to } 10\text{ Hz}$		25°C	1.8			$\mu\text{V}$
					3.6			
$I_n$	Equivalent input noise current			25°C	0.6		fA/ $\sqrt{\text{Hz}}$	
THD+N	Total harmonic distortion plus noise	$V_O = 1.5\text{ V to } 3.5\text{ V}$ , $f = 1\text{ kHz}$ , $R_L = 600\ \Omega^{(2)}$		25°C	$A_V = 1$			%
					$A_V = 10$			
					$A_V = 100$			
Gain-bandwidth product		$f = 10\text{ kHz}$ , $R_L = 600\ \Omega^{(2)}$ , $C_L = 100\text{ pF}^{(2)}$		25°C	1.81		MHz	
BOM	Maximum output-swing bandwidth	$V_{O(PP)} = 2\text{ V}$ , $A_V = 1$ , $R_L = 600\ \Omega^{(2)}$ , $C_L = 100\text{ pF}^{(2)}$		25°C	0.5		MHz	
$t_s$	Settling time	$A_V = -1$ , Step = $-0.5\text{ V to } 2.5\text{ V}$ , $R_L = 600\ \Omega^{(2)}$ , $C_L = 100\text{ pF}^{(2)}$		25°C	To 0.1%			$\mu\text{s}$
					To 0.01%			
$\phi_m$	Phase margin at unity gain	$R_L = 600\ \Omega^{(2)}$ , $C_L = 100\text{ pF}^{(2)}$		25°C	68		°	
	Gain margin	$R_L = 600\ \Omega^{(2)}$ , $C_L = 100\text{ pF}^{(2)}$		25°C	8		dB	

(1) Full range is  $-40^\circ\text{C}$  to  $125^\circ\text{C}$ .

(2) Referenced to 2.5 V

## TYPICAL CHARACTERISTICS

**Table of Graphs<sup>(1)</sup>**

			<b>FIGURE</b>
$V_{IO}$	Input offset voltage	Distribution	2, 3
		vs Common-mode input voltage	4, 5
$\alpha_{VIO}$	Input offset voltage temperature coefficient	Distribution	6, 7
$I_B/I_{IO}$	Input bias and input offset currents	vs Free-air temperature	8
$V_{OH}$	High-level output voltage	vs High-level output current	9, 10
$V_{OL}$	Low-level output voltage	vs Low-level output current	11, 12
$V_{O(PP)}$	Maximum peak-to-peak output voltage	vs Frequency	13
$I_{OS}$	Short-circuit output current	vs Supply voltage	14
		vs Free-air temperature	15
$V_O$	Output voltage	vs Differential input voltage	16, 17
$A_{VD}$	Differential voltage amplification	vs Load resistance	18
	Large-signal differential voltage amplification and phase margin	vs Frequency	19, 20
	Large-signal differential voltage amplification	vs Free-air temperature	21, 22
$Z_o$	Output impedance	vs Frequency	23, 24
CMRR	Common-mode rejection ratio	vs Frequency	25
		vs Free-air temperature	26
$k_{SVR}$	Supply-voltage rejection ratio	vs Frequency	27, 28
		vs Free-air temperature	29
$I_{DD}$	Supply current	vs Supply voltage	30
SR	Slew rate	vs Load capacitance	31
		vs Free-air temperature	32
$V_O$	Inverting large-signal pulse response		33, 34
	Voltage-follower large-signal pulse response		35, 36
	Inverting small-signal pulse response		37, 38
	Voltage-follower small-signal pulse response		39, 40
$V_n$	Equivalent input noise voltage	vs Frequency	41, 42
	Noise voltage	Over a 10-second period	43
THD + N	Total harmonic distortion plus noise	vs Frequency	44, 45
		vs Free-air temperature	46
		vs Supply voltage	47
$\phi_m$	Phase margin	vs Frequency	19, 20
		vs Load capacitance	48
	Gain margin	vs Load capacitance	49
$B_1$	Unity-gain bandwidth	vs Load capacitance	50

(1) For all graphs where  $V_{DD} = 5\text{ V}$ , all loads are referenced to 2.5 V.

**DISTRIBUTION OF TLV2442  
INPUT OFFSET VOLTAGE**

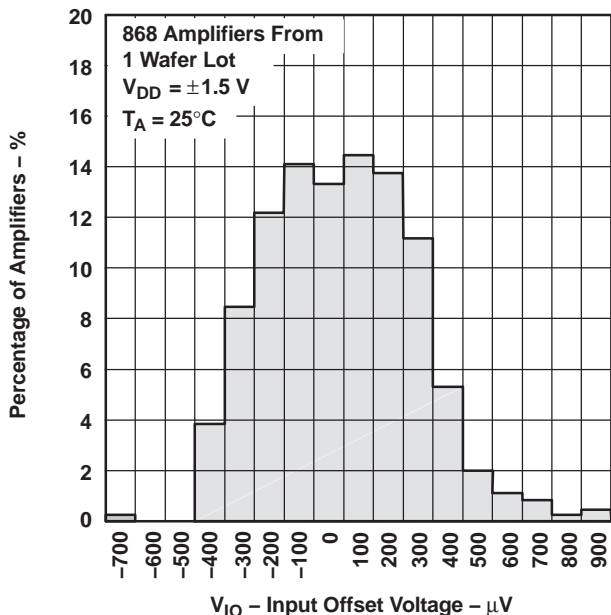

Figure 2.

**DISTRIBUTION OF TLV2442  
INPUT OFFSET VOLTAGE**

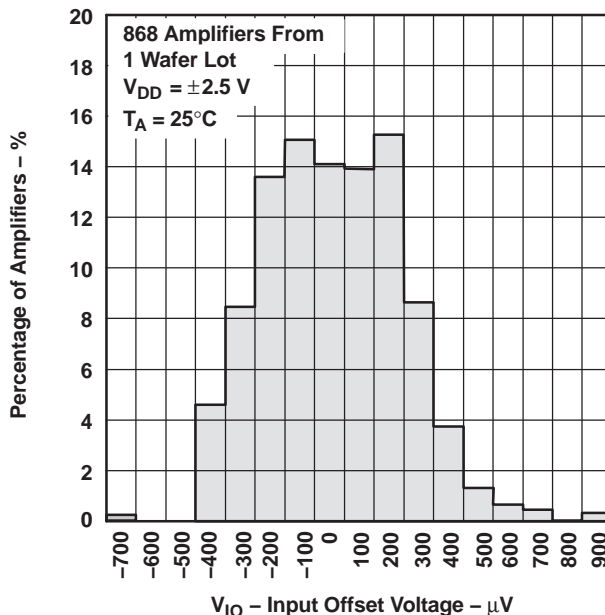

Figure 3.

**INPUT OFFSET VOLTAGE  
vs  
COMMON-MODE INPUT VOLTAGE**

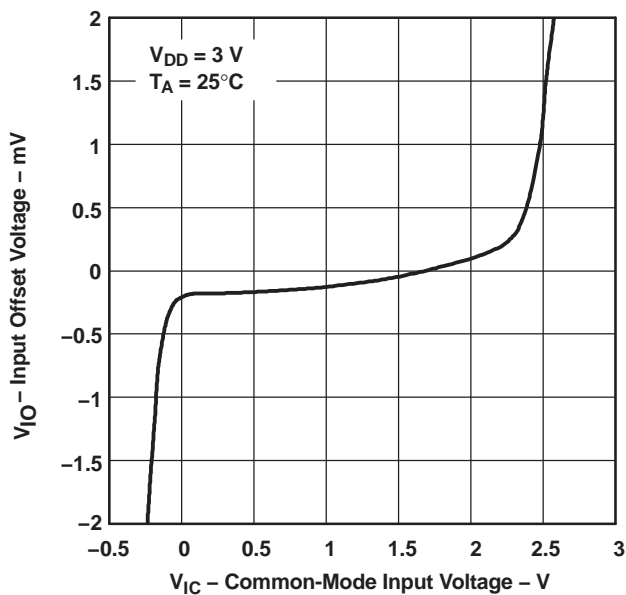

Figure 4.

**INPUT OFFSET VOLTAGE  
vs  
COMMON-MODE INPUT VOLTAGE**

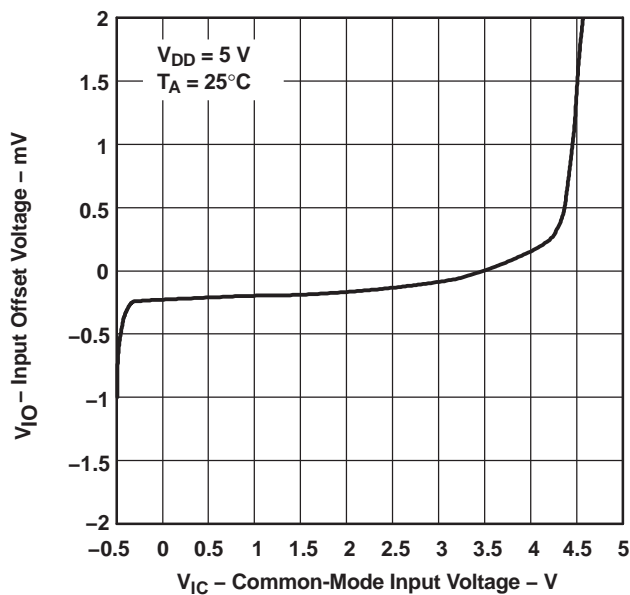

Figure 5.

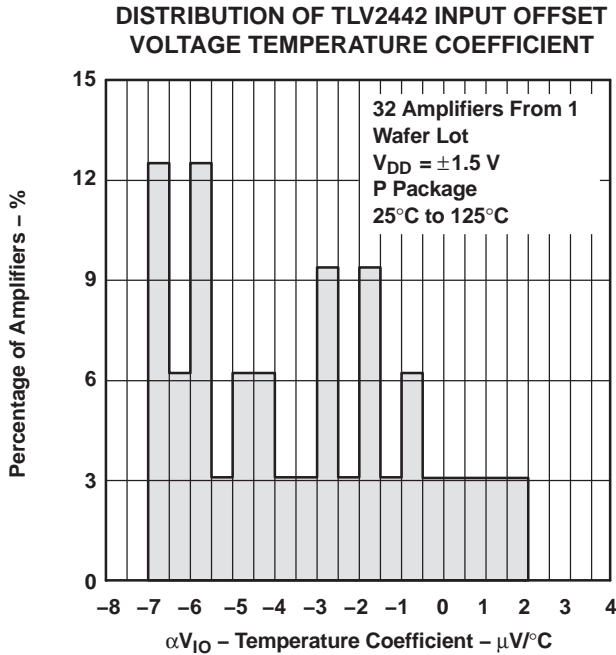

Figure 6.

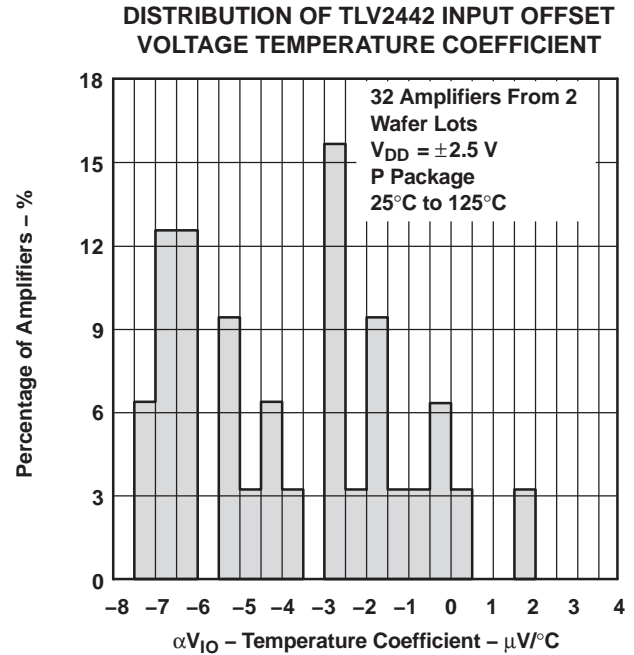

Figure 7.

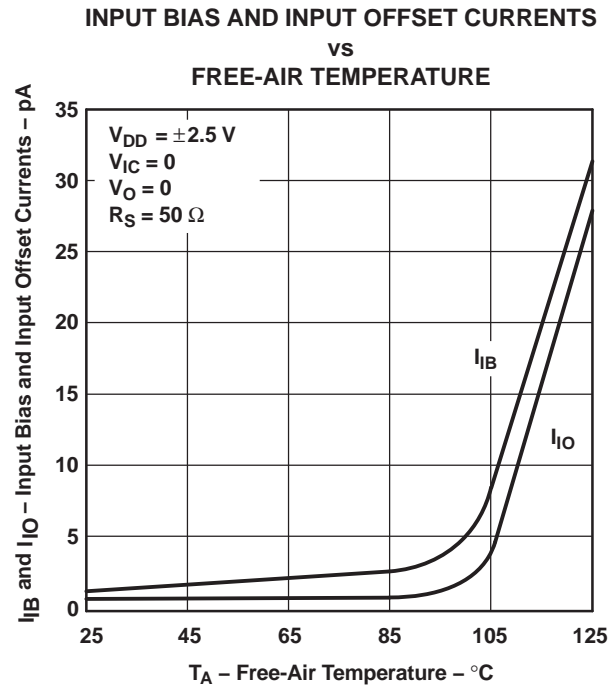

Figure 8.

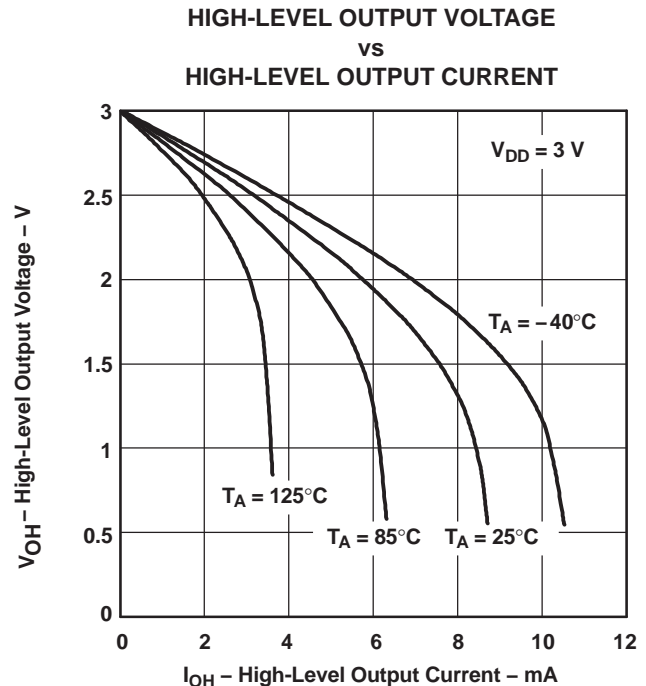
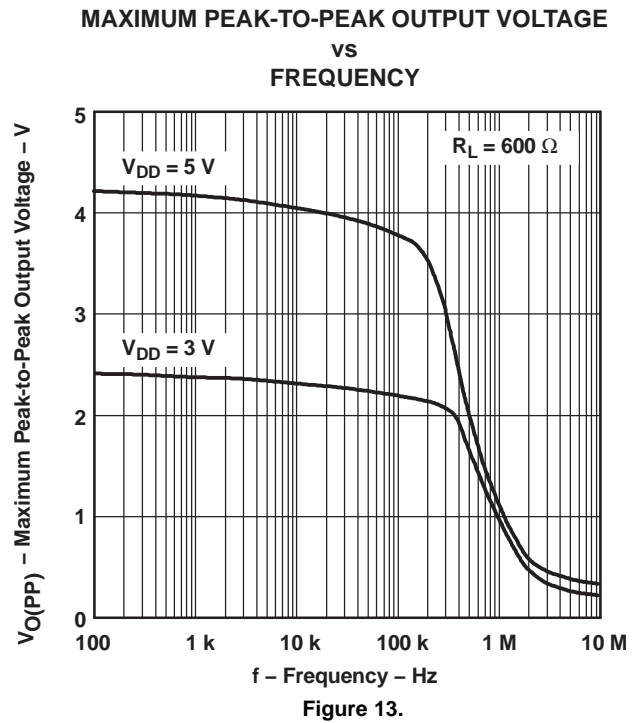
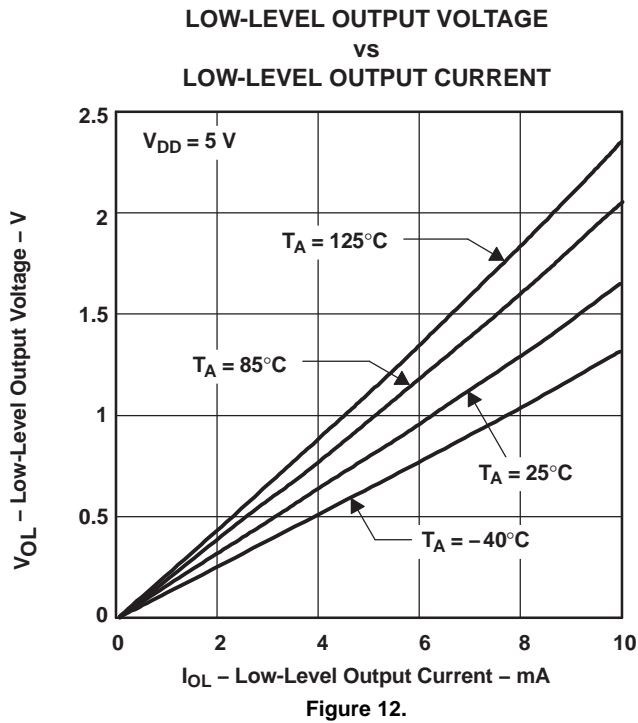
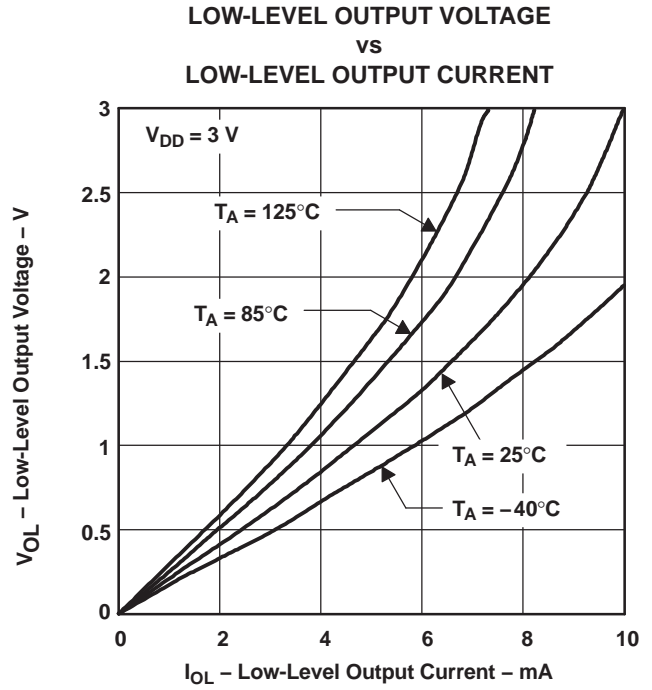
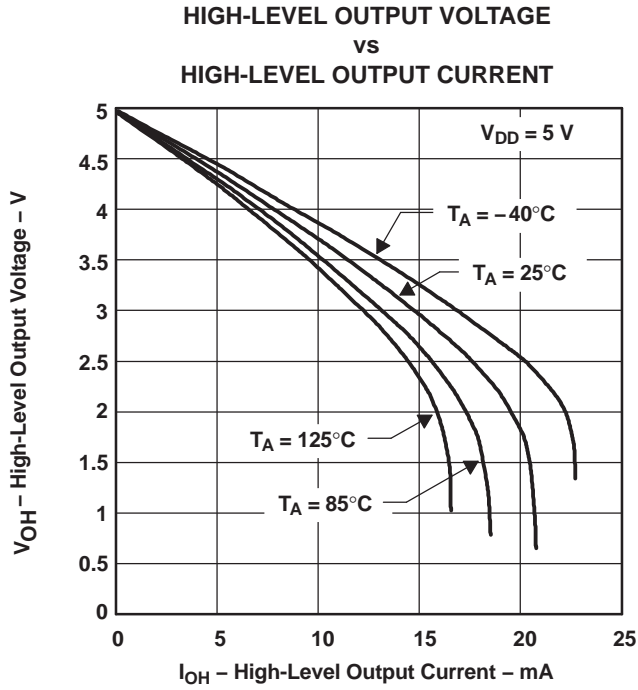

Figure 9.



SHORT-CIRCUIT OUTPUT CURRENT  
VS  
SUPPLY VOLTAGE

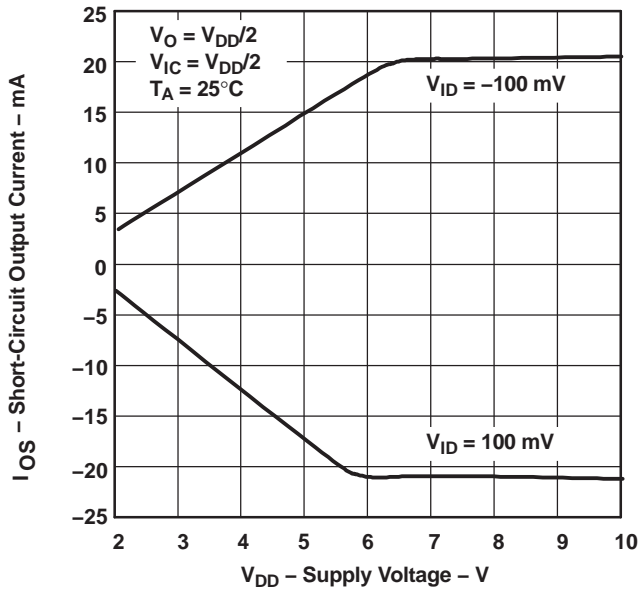

Figure 14.

SHORT-CIRCUIT OUTPUT CURRENT  
VS  
FREE-AIR TEMPERATURE

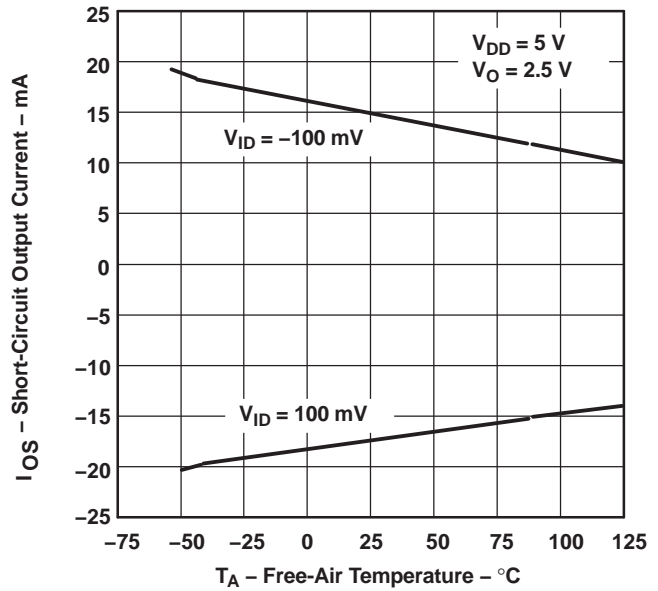

Figure 15.

OUTPUT VOLTAGE  
VS  
DIFFERENTIAL INPUT VOLTAGE

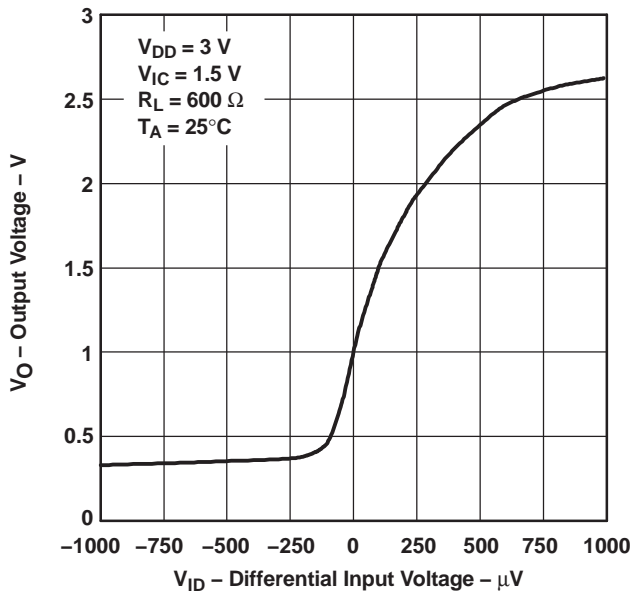

Figure 16.

OUTPUT VOLTAGE  
VS  
DIFFERENTIAL INPUT VOLTAGE

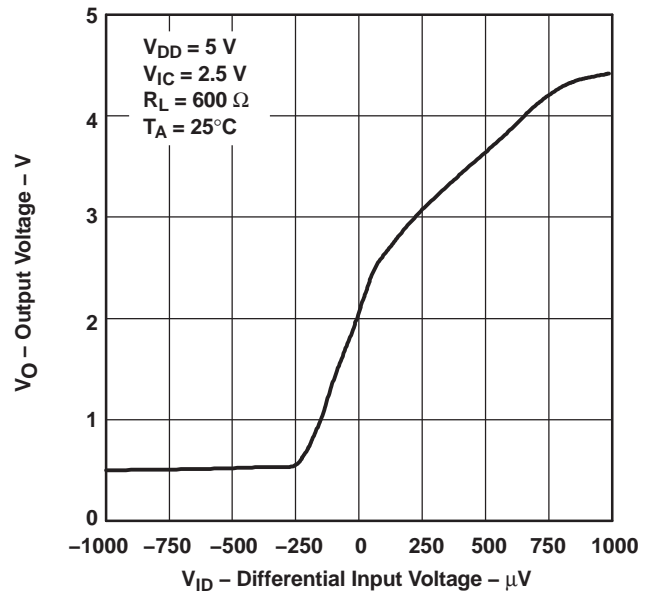
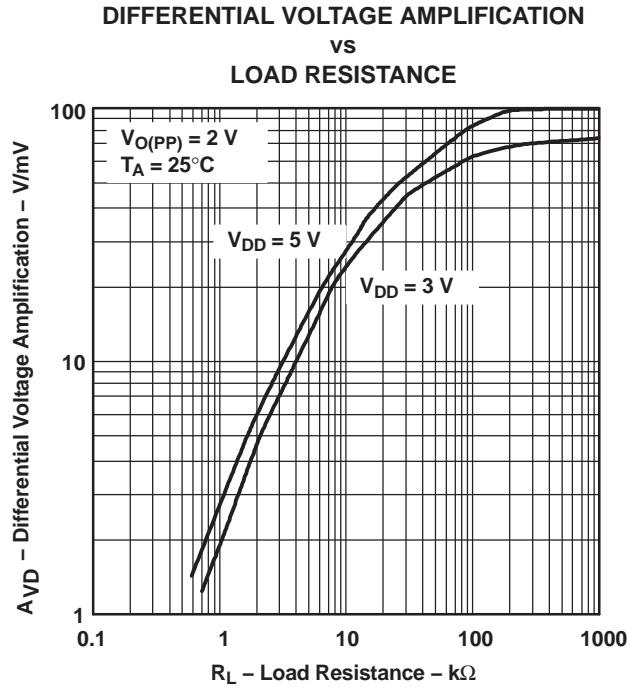
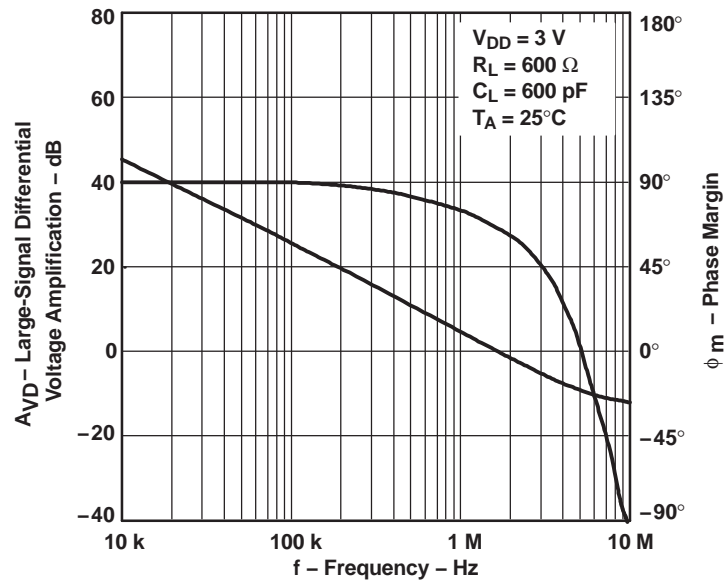

Figure 17.



**LARGE-SIGNAL DIFFERENTIAL VOLTAGE  
 AMPLIFICATION AND PHASE MARGIN  
 vs  
 FREQUENCY**



LARGE-SIGNAL DIFFERENTIAL VOLTAGE AMPLIFICATION AND PHASE MARGIN  
vs  
FREQUENCY

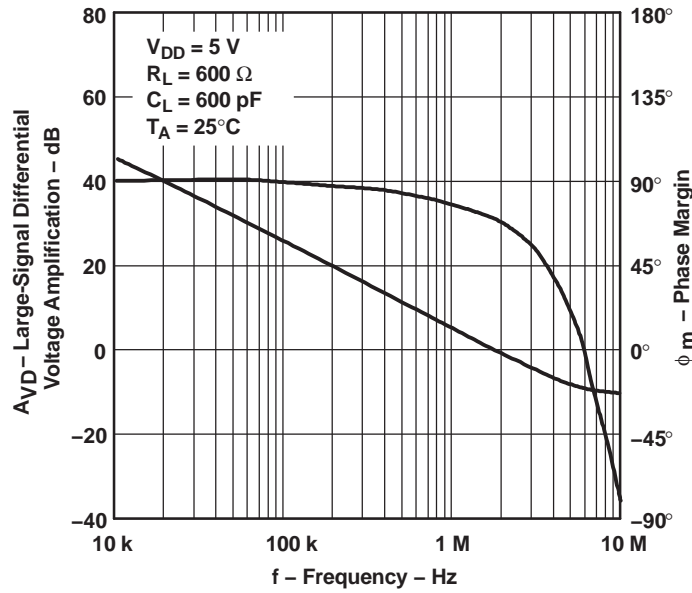

Figure 20.

LARGE-SIGNAL DIFFERENTIAL VOLTAGE AMPLIFICATION  
vs  
FREE-AIR TEMPERATURE

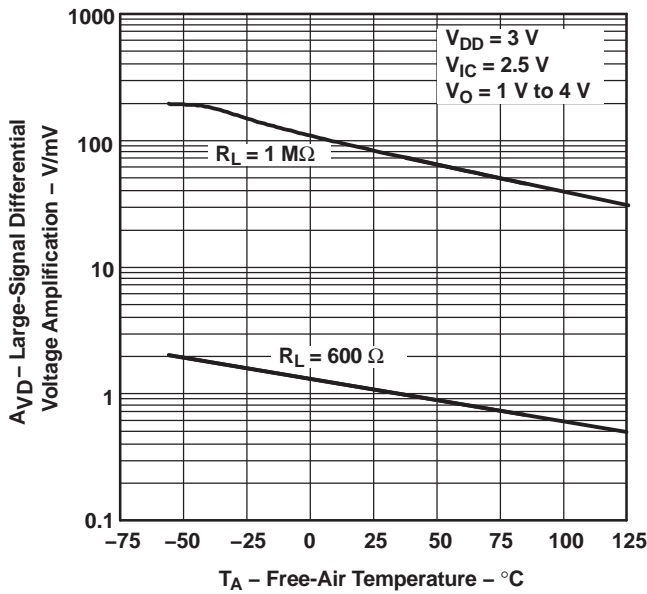

Figure 21.

LARGE-SIGNAL DIFFERENTIAL VOLTAGE AMPLIFICATION  
vs  
FREE-AIR TEMPERATURE

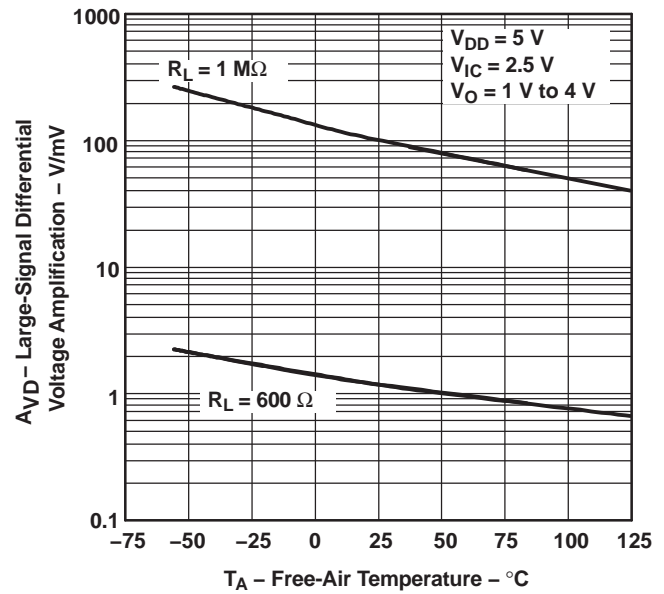

Figure 22.

OUTPUT IMPEDANCE  
VS  
FREQUENCY

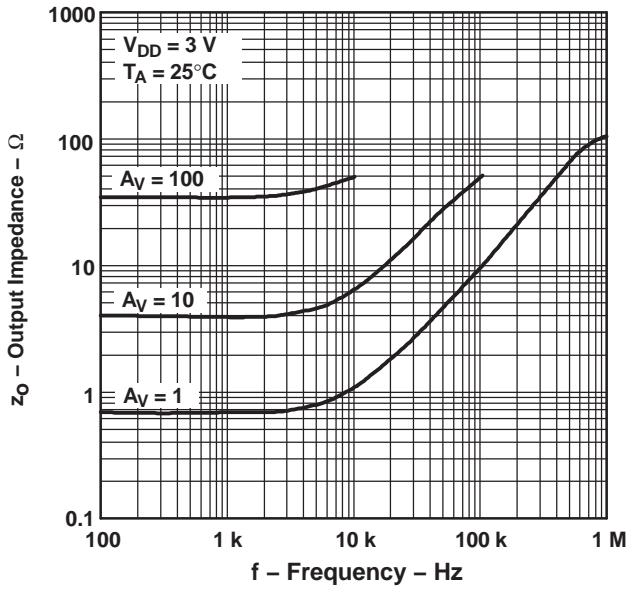

Figure 23.

OUTPUT IMPEDANCE  
VS  
FREQUENCY

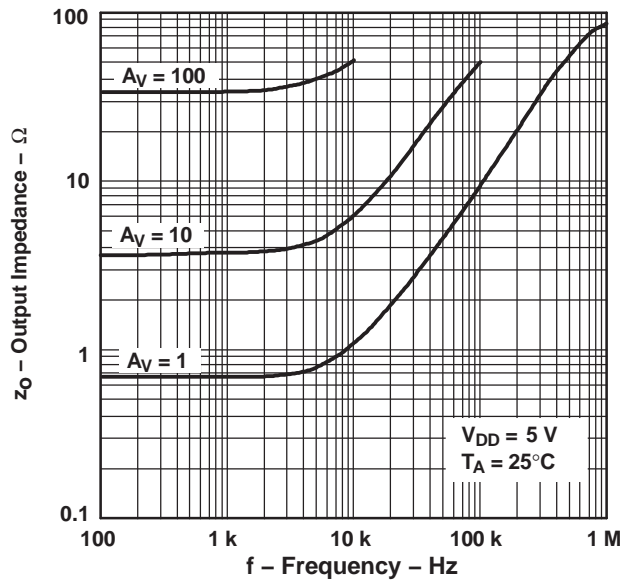

Figure 24.

COMMON-MODE REJECTION RATIO  
VS  
FREQUENCY

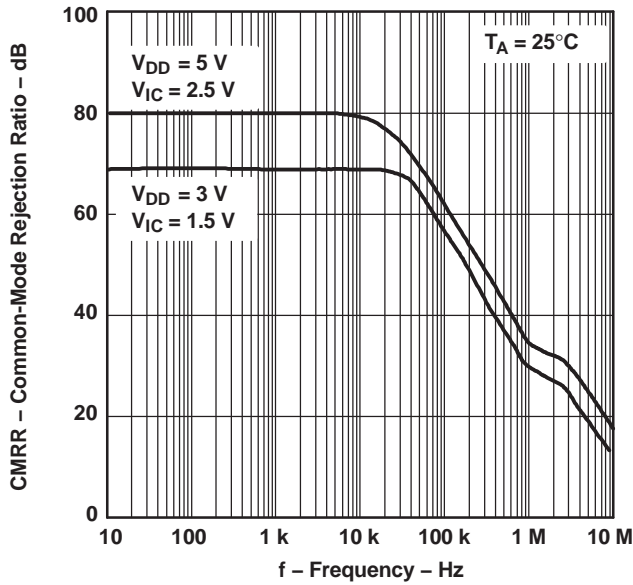

Figure 25.

COMMON-MODE REJECTION RATIO  
VS  
FREE-AIR TEMPERATURE

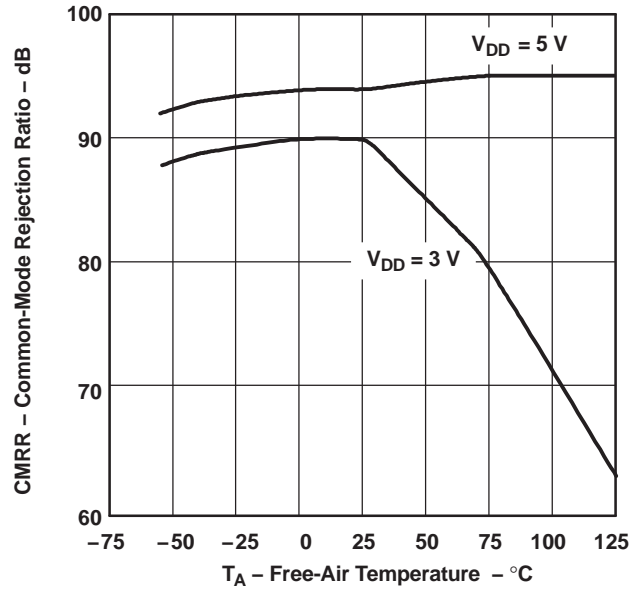

Figure 26.

SUPPLY-VOLTAGE REJECTION RATIO  
VS  
FREQUENCY

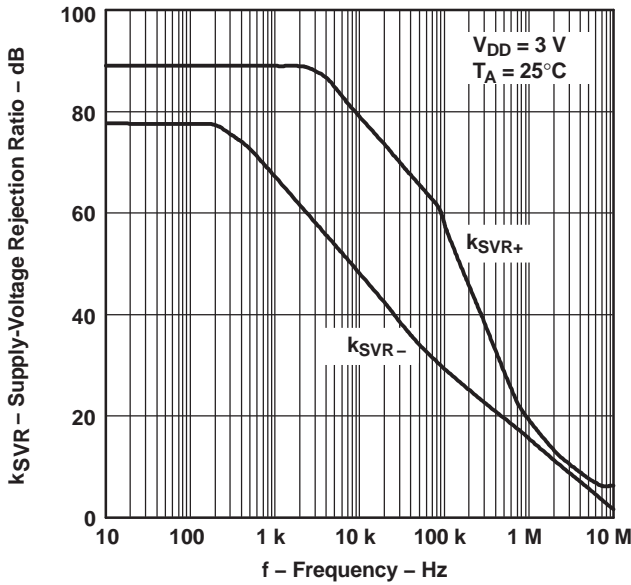

Figure 27.

SUPPLY-VOLTAGE REJECTION RATIO  
VS  
FREQUENCY

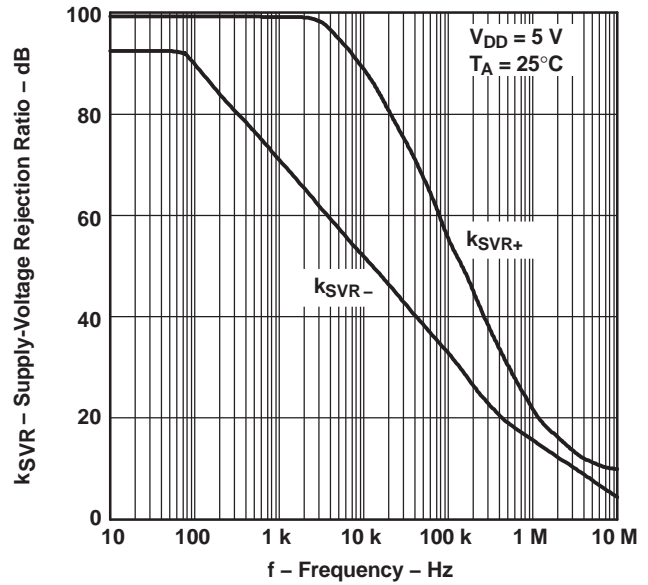

Figure 28.

SUPPLY-VOLTAGE REJECTION RATIO  
VS  
FREE-AIR TEMPERATURE

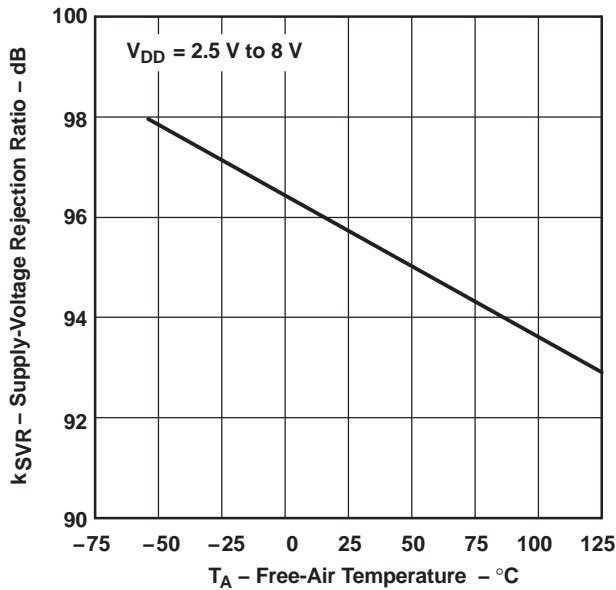

Figure 29.

SUPPLY CURRENT  
VS  
SUPPLY VOLTAGE

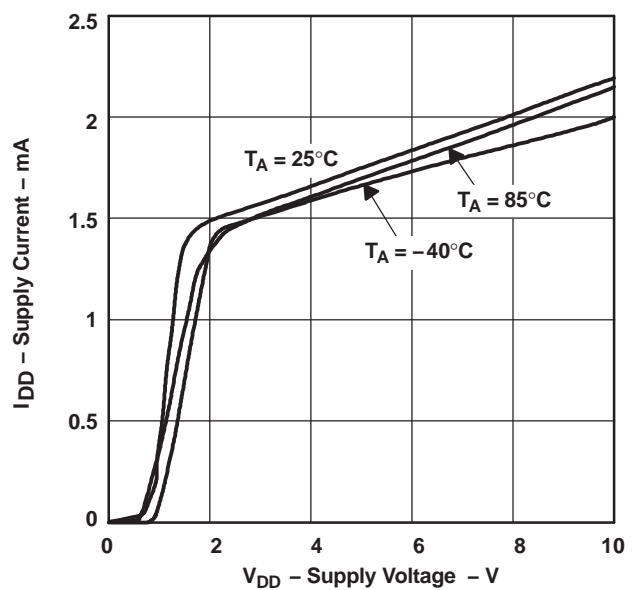
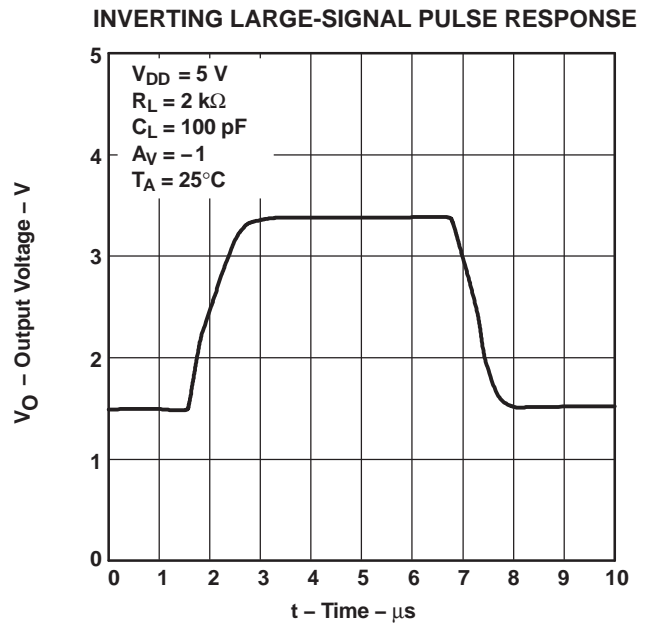
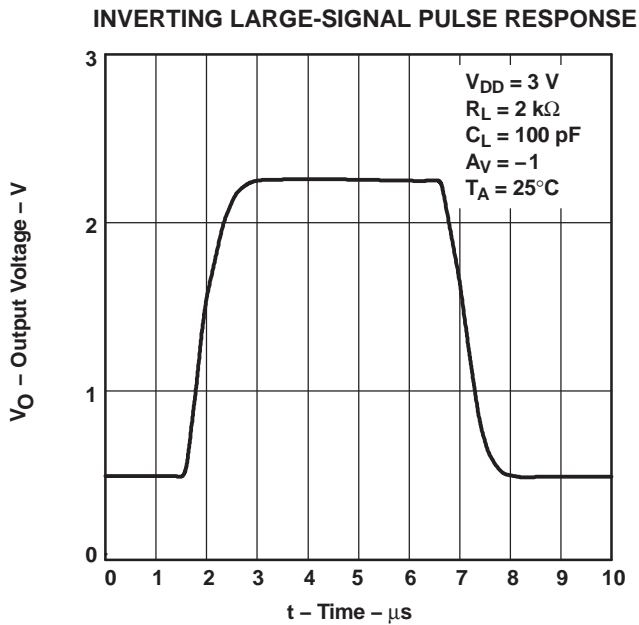
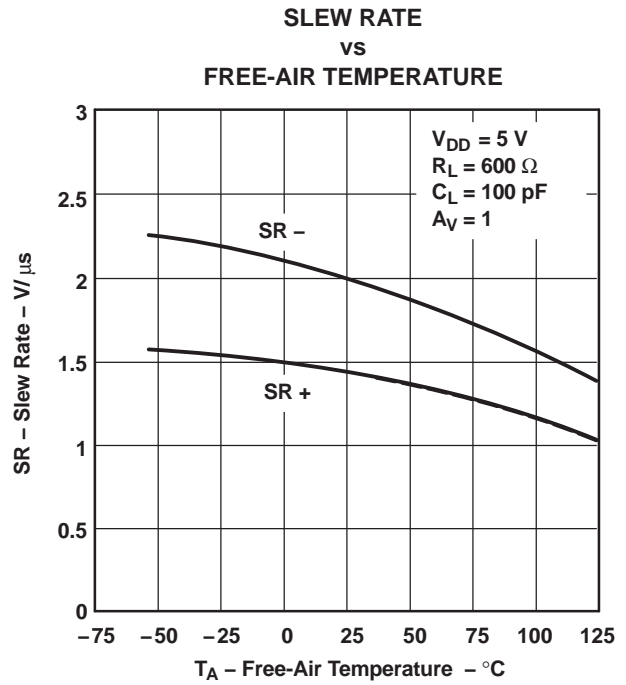
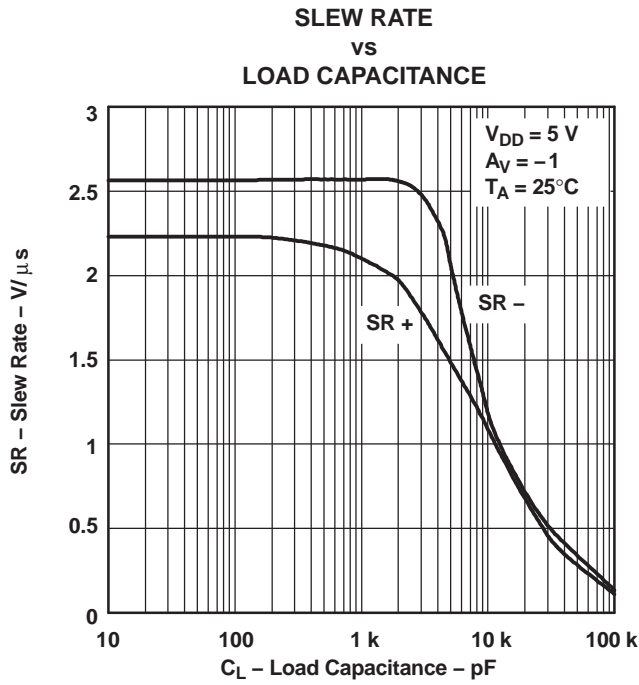

Figure 30.



VOLTAGE-FOLLOWER  
LARGE-SIGNAL PULSE RESPONSE

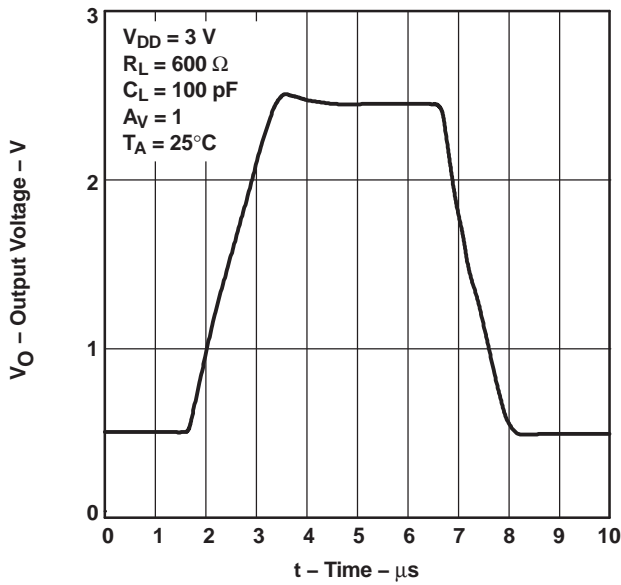

Figure 35.

VOLTAGE-FOLLOWER  
LARGE-SIGNAL PULSE RESPONSE

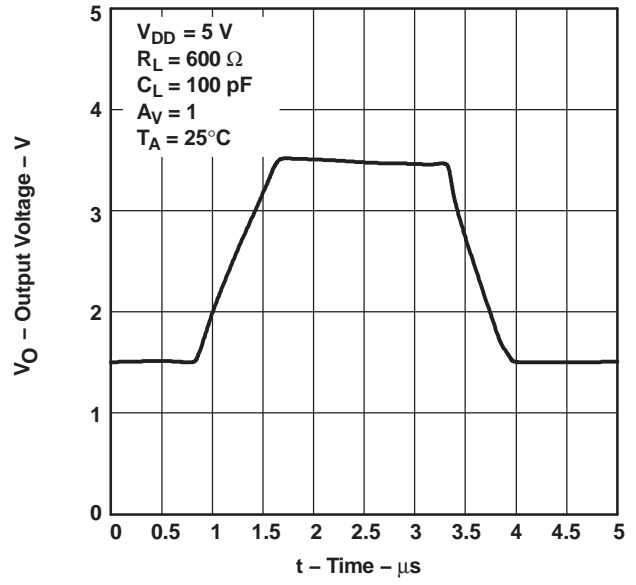

Figure 36.

INVERTING SMALL-SIGNAL PULSE RESPONSE

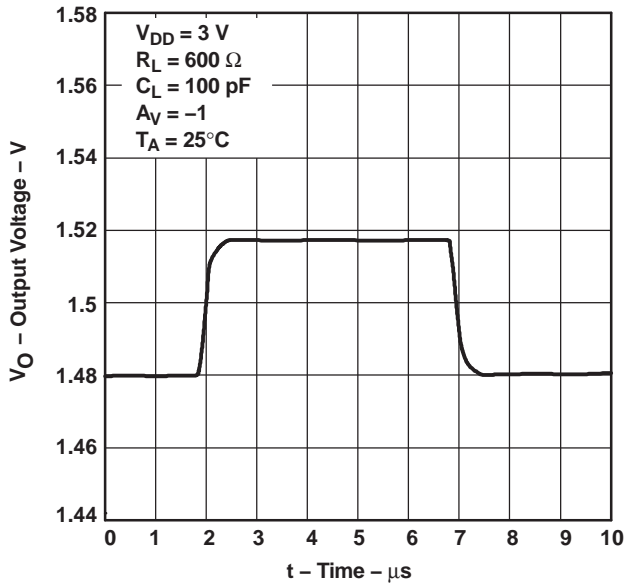

Figure 37.

INVERTING SMALL-SIGNAL PULSE RESPONSE

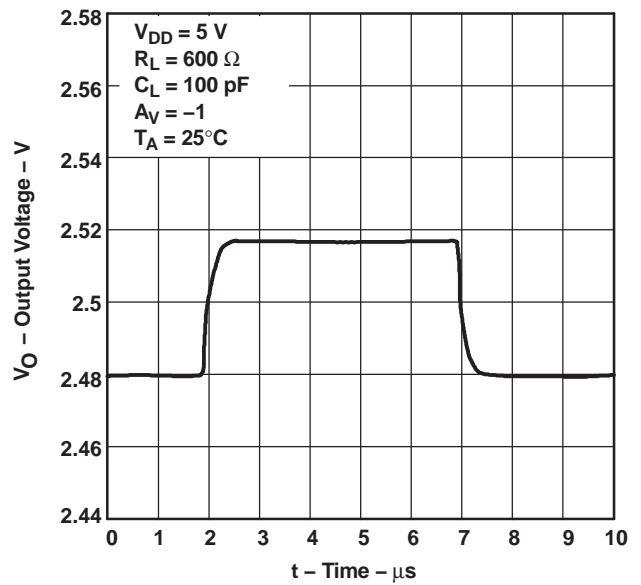

Figure 38.

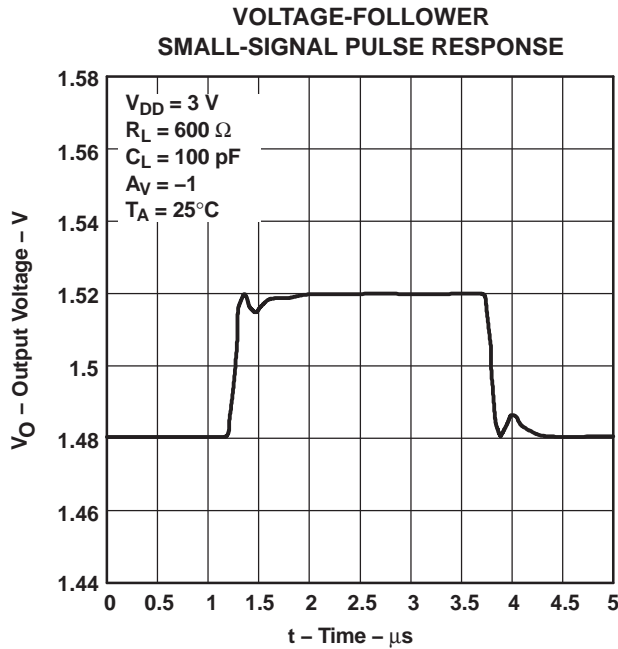

Figure 39.

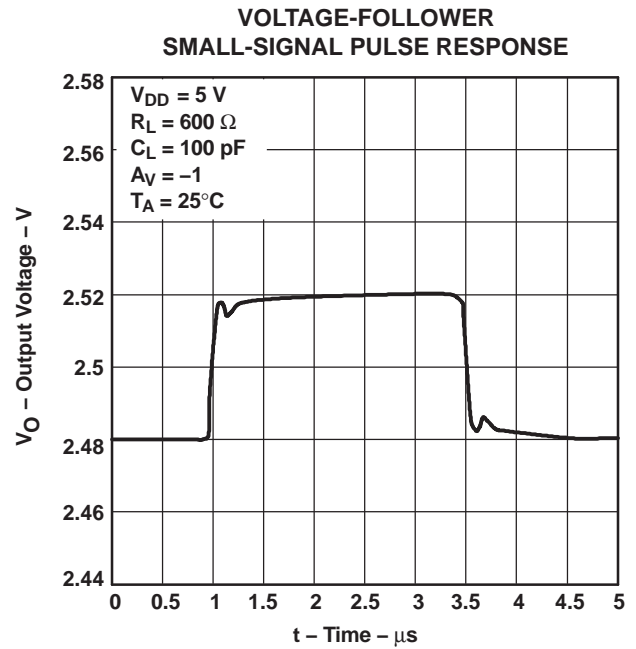

Figure 40.

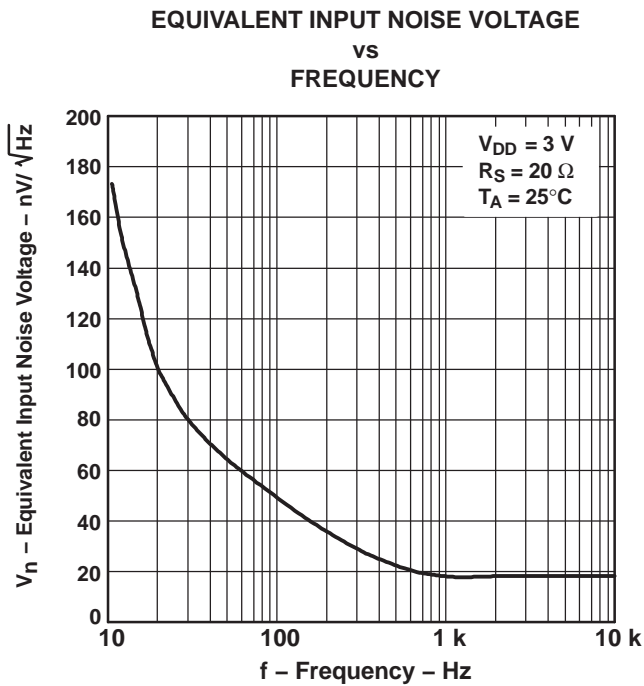

Figure 41.

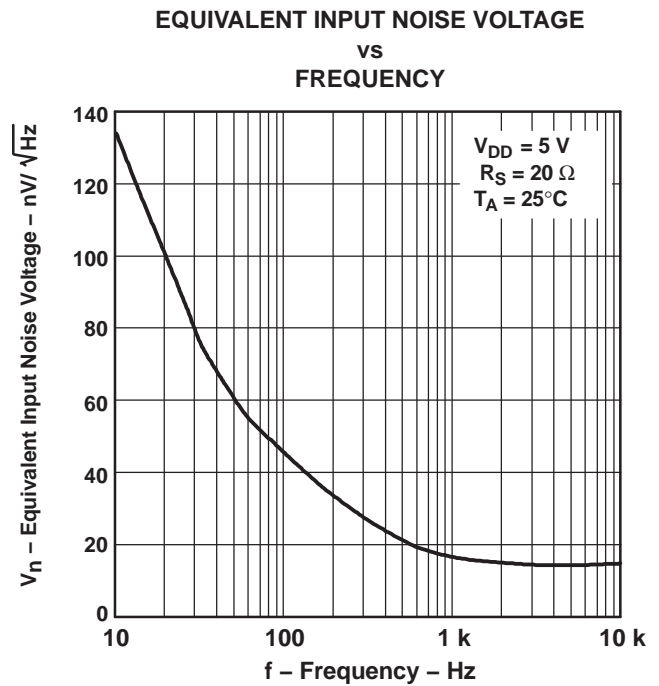

Figure 42.

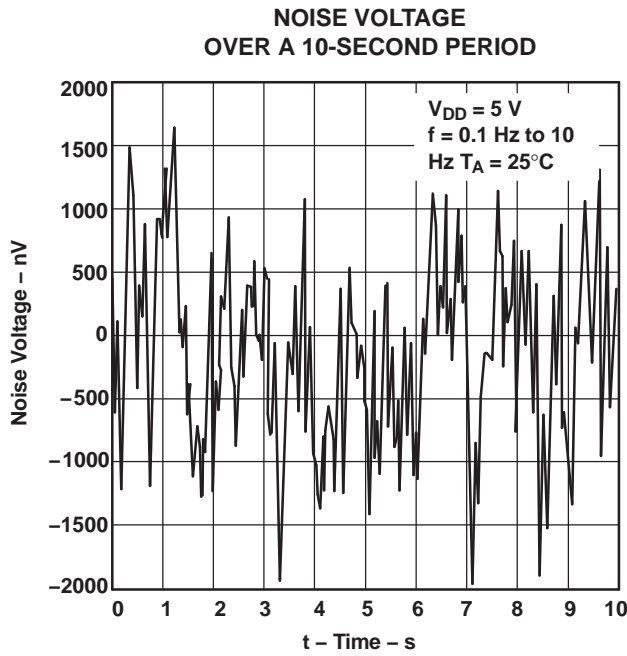

Figure 43.

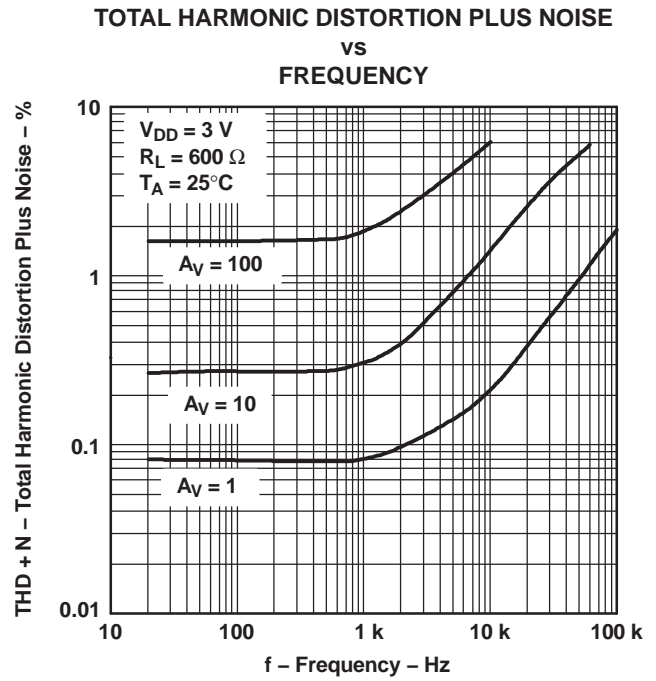

Figure 44.

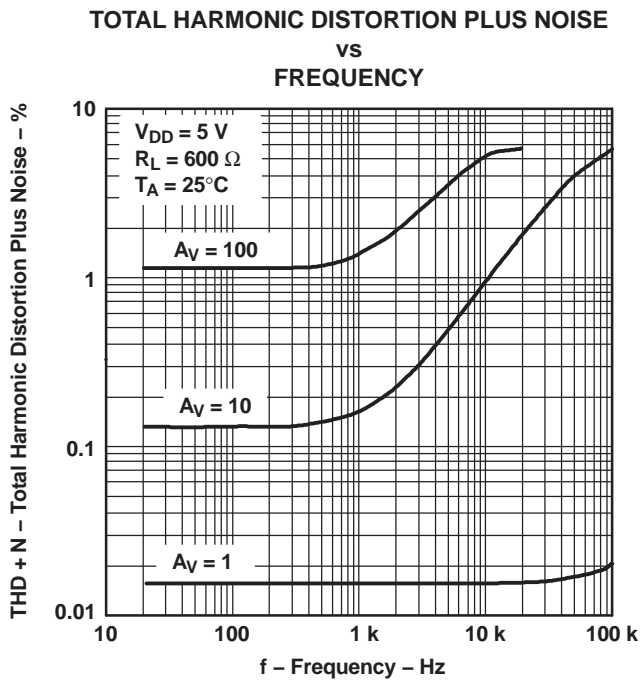

Figure 45.

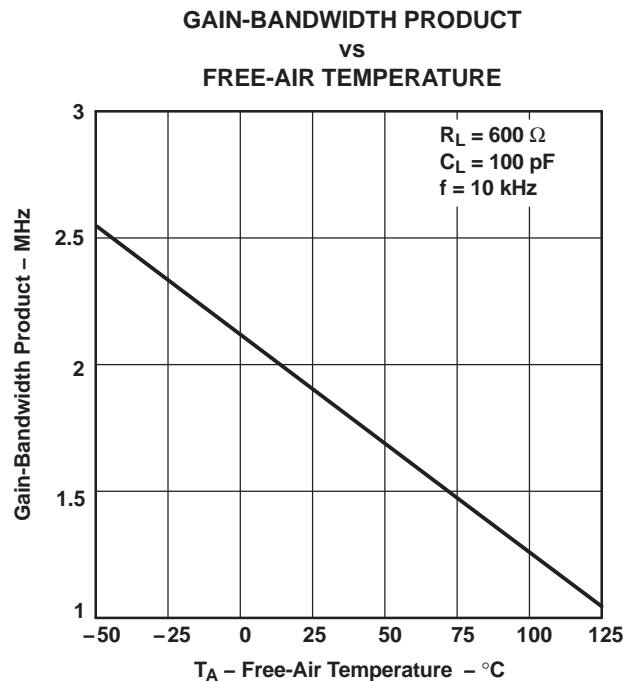

Figure 46.

**GAIN-BANDWIDTH PRODUCT  
VS  
SUPPLY VOLTAGE**

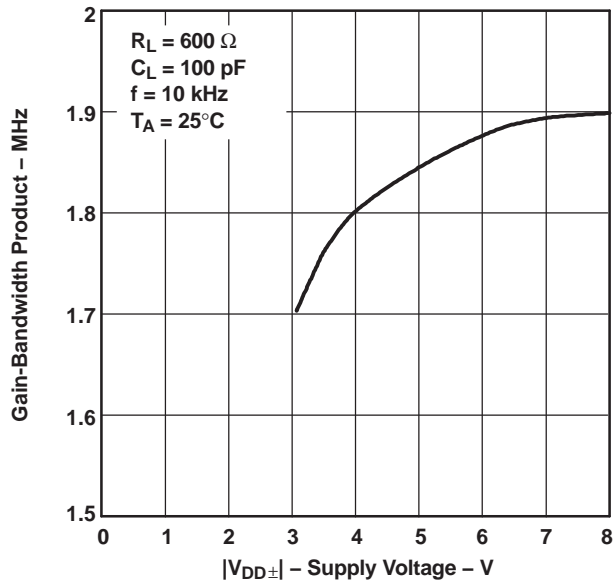

Figure 47.

**PHASE MARGIN  
VS  
LOAD CAPACITANCE**

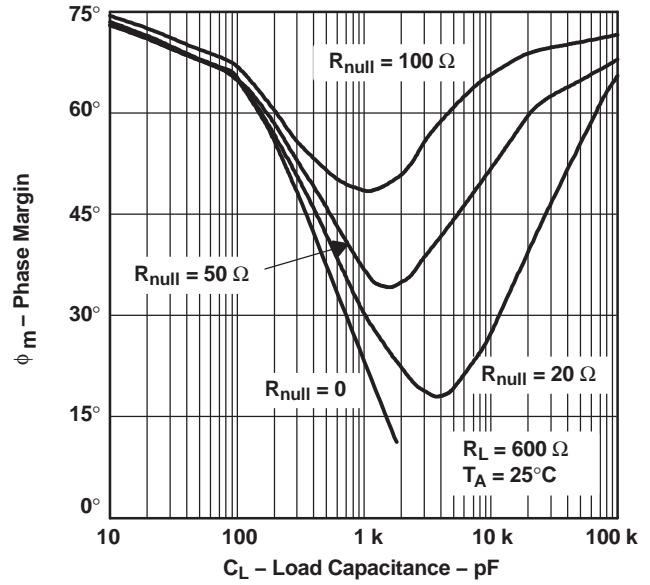

Figure 48.

**GAIN MARGIN  
VS  
LOAD CAPACITANCE**

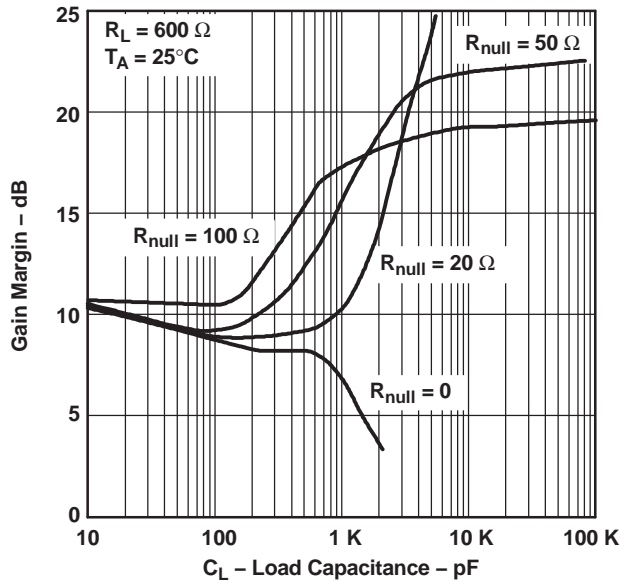

Figure 49.

**UNITY-GAIN BANDWIDTH  
VS  
LOAD CAPACITANCE**

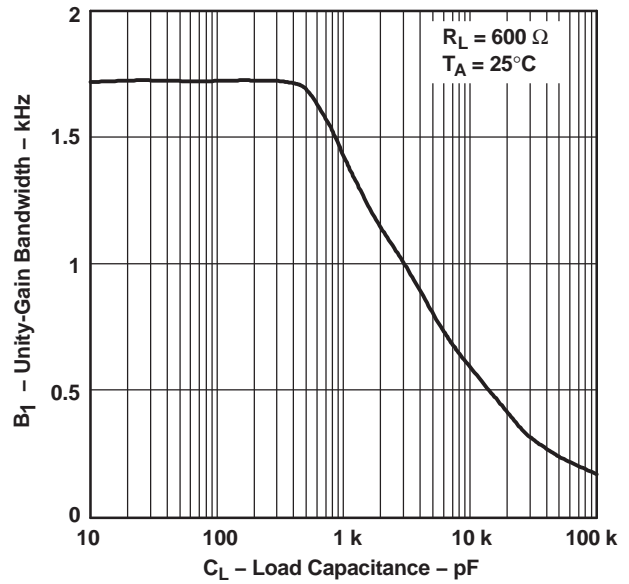

Figure 50.

APPLICATION INFORMATION

macromodel information

Macromodel information provided was derived using PSpice™ Parts™ model generation software. The Boyle macromodel<sup>(2)</sup> and subcircuit in Figure 51 were generated using the TLV244x typical electrical and operating characteristics at T<sub>A</sub> = 25°C. Using this information, output simulations of the following key parameters can be generated to a tolerance of 20% (in most cases):

(2) G. R. Boyle, B. M. Cohn, D. O. Pederson, and J. E. Solomon, "Macromodeling of Integrated Circuit Operational Amplifiers," *IEEE Journal of Solid-State Circuits*, SC-9, 353 (1974).

- Maximum positive output voltage swing
- Maximum negative output voltage swing
- Slew rate
- Quiescent power dissipation
- Input bias current
- Open-loop voltage amplification
- Unity gain frequency
- Common-mode rejection ratio
- Phase margin
- DC output resistance
- AC output resistance
- Short-circuit output current limit

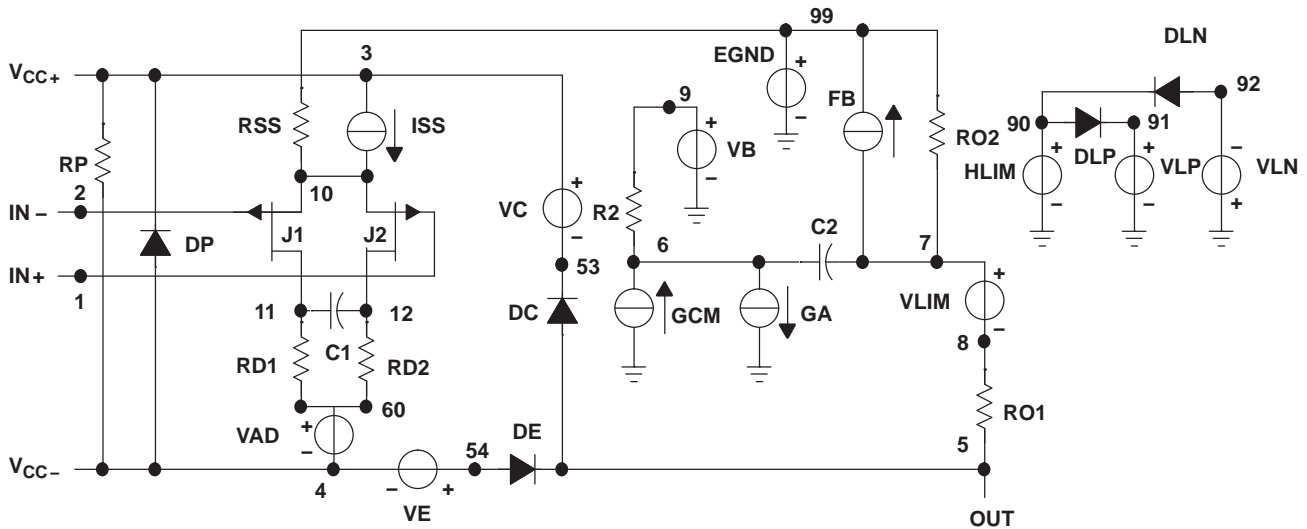

```
.SUBCKT TLV2442 1 2 3 4 5
C1      11      12      14E-12
C2      6       7       60.00E-12
DC      5       53      DX
DE      54      5       DX
DLP     90      91      DX
DLN     92      90      DX
DP      4       3       DX
EGND    99      0       POLY (2) (3,0) (4,) 0 .5 .5
FB      7       99      POLY (5) VB VC VE VLP VLN 0
+ 984.9E3 -1E6 1E6 1E6 -1E6
GA      6       0       11      12 377.0E-6
GCM     0       6       10      99 134E-9
ISS     3       10      DC 216.0E-6
HLIM    90      0       VLIM 1K
J1      11      2       10 JX
J2      12      1       10 JX
R2      6       9       100.OE3
RD1     60      11      2.653E3
RD2     60      12      2.653E3
R01     8       5       50
R02     7       99      50
RP      3       4       4.310E3
RSS     10      99      925.9E3
VAD     60      4       -.5
VB      9       0       DC 0
VC      3       53      DC .78
VE      54      4       DC .78
VLIM    7       8       DC 0
VLP     91      0       DC 1.9
VLN     0       92      DC 9.4
.MODEL DX D (IS=800.0E-18)
.MODEL JX PJF (IS=1.500E-12BETA=1.316E-3
+ VTO=-.270)
.ENDS
```

Figure 51. Boyle Macromodel and Subcircuit

## PACKAGING INFORMATION

Orderable part number	Status (1)	Material type (2)	Package   Pins	Package qty   Carrier	RoHS (3)	Lead finish/ Ball material (4)	MSL rating/ Peak reflow (5)	Op temp (°C)	Part marking (6)
<a href="#">TLV2442AQDRQ1</a>	Active	Production	SOIC (D)   8	2500   LARGE T&R	Yes	NIPDAU	Level-1-260C-UNLIM	-40 to 125	2442AQ
TLV2442AQDRQ1.A	Active	Production	SOIC (D)   8	2500   LARGE T&R	Yes	NIPDAU	Level-1-260C-UNLIM	-40 to 125	2442AQ
<a href="#">TLV2442QDGKRQ1</a>	Active	Production	VSSOP (DGK)   8	2500   LARGE T&R	Yes	Call TI   Nipdauag   Nipdau	Level-2-260C-1 YEAR	-40 to 125	OBR
TLV2442QDGKRQ1.A	Active	Production	VSSOP (DGK)   8	2500   LARGE T&R	Yes	Call TI	Level-2-260C-1 YEAR	-40 to 125	OBR
<a href="#">TLV2442QPWRG4Q1</a>	Active	Production	TSSOP (PW)   8	2000   LARGE T&R	Yes	NIPDAU	Level-1-260C-UNLIM	-40 to 125	2442Q1
TLV2442QPWRG4Q1.A	Active	Production	TSSOP (PW)   8	2000   LARGE T&R	Yes	NIPDAU	Level-1-260C-UNLIM	-40 to 125	2442Q1

(1) **Status:** For more details on status, see our [product life cycle](#).

(2) **Material type:** When designated, preproduction parts are prototypes/experimental devices, and are not yet approved or released for full production. Testing and final process, including without limitation quality assurance, reliability performance testing, and/or process qualification, may not yet be complete, and this item is subject to further changes or possible discontinuation. If available for ordering, purchases will be subject to an additional waiver at checkout, and are intended for early internal evaluation purposes only. These items are sold without warranties of any kind.

(3) **RoHS values:** Yes, No, RoHS Exempt. See the [TI RoHS Statement](#) for additional information and value definition.

(4) **Lead finish/Ball material:** Parts may have multiple material finish options. Finish options are separated by a vertical ruled line. Lead finish/Ball material values may wrap to two lines if the finish value exceeds the maximum column width.

(5) **MSL rating/Peak reflow:** The moisture sensitivity level ratings and peak solder (reflow) temperatures. In the event that a part has multiple moisture sensitivity ratings, only the lowest level per JEDEC standards is shown. Refer to the shipping label for the actual reflow temperature that will be used to mount the part to the printed circuit board.

(6) **Part marking:** There may be an additional marking, which relates to the logo, the lot trace code information, or the environmental category of the part.

Multiple part markings will be inside parentheses. Only one part marking contained in parentheses and separated by a "-" will appear on a part. If a line is indented then it is a continuation of the previous line and the two combined represent the entire part marking for that device.

**Important Information and Disclaimer:** The information provided on this page represents TI's knowledge and belief as of the date that it is provided. TI bases its knowledge and belief on information provided by third parties, and makes no representation or warranty as to the accuracy of such information. Efforts are underway to better integrate information from third parties. TI has taken and continues to take reasonable steps to provide representative and accurate information but may not have conducted destructive testing or chemical analysis on incoming materials and chemicals. TI and TI suppliers consider certain information to be proprietary, and thus CAS numbers and other limited information may not be available for release.

In no event shall TI's liability arising out of such information exceed the total purchase price of the TI part(s) at issue in this document sold by TI to Customer on an annual basis.

**OTHER QUALIFIED VERSIONS OF TLV2442-Q1, TLV2442A-Q1 :**

- Catalog : [TLV2442](#), [TLV2442A](#)

## NOTE: Qualified Version Definitions:

- Catalog - TI's standard catalog product

**TAPE AND REEL INFORMATION**

**QUADRANT ASSIGNMENTS FOR PIN 1 ORIENTATION IN TAPE**

\*All dimensions are nominal

Device	Package Type	Package Drawing	Pins	SPQ	Reel Diameter (mm)	Reel Width W1 (mm)	A0 (mm)	B0 (mm)	K0 (mm)	P1 (mm)	W (mm)	Pin1 Quadrant
TLV2442QPWRG4Q1	TSSOP	PW	8	2000	330.0	12.4	7.0	3.6	1.6	8.0	12.0	Q1

**TAPE AND REEL BOX DIMENSIONS**

\*All dimensions are nominal

Device	Package Type	Package Drawing	Pins	SPQ	Length (mm)	Width (mm)	Height (mm)
TLV2442QPWRG4Q1	TSSOP	PW	8	2000	353.0	353.0	32.0



D0008A

# PACKAGE OUTLINE

SOIC - 1.75 mm max height

SMALL OUTLINE INTEGRATED CIRCUIT



4214825/C 02/2019

### NOTES:

- Linear dimensions are in inches [millimeters]. Dimensions in parenthesis are for reference only. Controlling dimensions are in inches. Dimensioning and tolerancing per ASME Y14.5M.
- This drawing is subject to change without notice.
- This dimension does not include mold flash, protrusions, or gate burrs. Mold flash, protrusions, or gate burrs shall not exceed  $.006$  [0.15] per side.
- This dimension does not include interlead flash.
- Reference JEDEC registration MS-012, variation AA.

# EXAMPLE BOARD LAYOUT

D0008A

SOIC - 1.75 mm max height

SMALL OUTLINE INTEGRATED CIRCUIT



LAND PATTERN EXAMPLE  
 EXPOSED METAL SHOWN  
 SCALE:8X



SOLDER MASK DETAILS

4214825/C 02/2019

NOTES: (continued)

- 6. Publication IPC-7351 may have alternate designs.
- 7. Solder mask tolerances between and around signal pads can vary based on board fabrication site.

# EXAMPLE STENCIL DESIGN

D0008A

SOIC - 1.75 mm max height

SMALL OUTLINE INTEGRATED CIRCUIT



SOLDER PASTE EXAMPLE  
BASED ON .005 INCH [0.125 MM] THICK STENCIL  
SCALE:8X

4214825/C 02/2019

NOTES: (continued)

8. Laser cutting apertures with trapezoidal walls and rounded corners may offer better paste release. IPC-7525 may have alternate design recommendations.
9. Board assembly site may have different recommendations for stencil design.



# EXAMPLE BOARD LAYOUT

PW0008A

TSSOP - 1.2 mm max height

SMALL OUTLINE PACKAGE

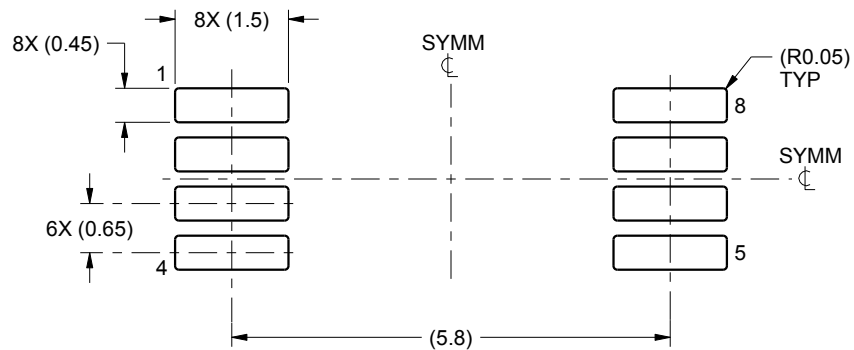

LAND PATTERN EXAMPLE  
SCALE:10X

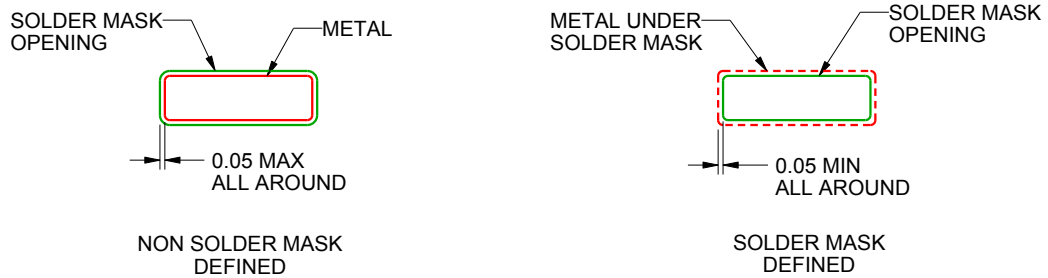

SOLDER MASK DETAILS  
NOT TO SCALE

4221848/A 02/2015

NOTES: (continued)

- 6. Publication IPC-7351 may have alternate designs.
- 7. Solder mask tolerances between and around signal pads can vary based on board fabrication site.

# EXAMPLE STENCIL DESIGN

PW0008A

TSSOP - 1.2 mm max height

SMALL OUTLINE PACKAGE

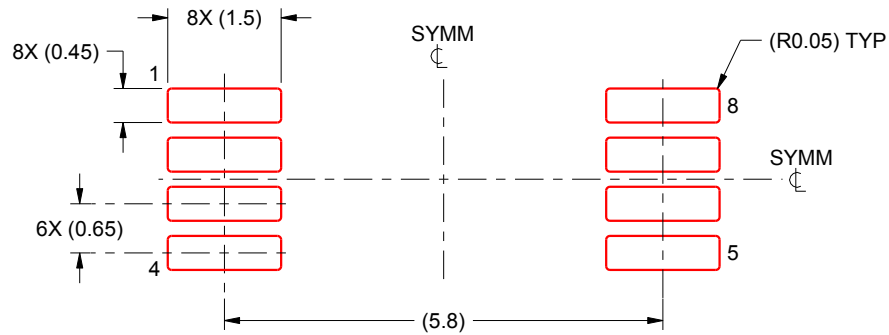

SOLDER PASTE EXAMPLE  
BASED ON 0.125 mm THICK STENCIL  
SCALE:10X

4221848/A 02/2015

NOTES: (continued)

8. Laser cutting apertures with trapezoidal walls and rounded corners may offer better paste release. IPC-7525 may have alternate design recommendations.
9. Board assembly site may have different recommendations for stencil design.

# DGK0008A



# PACKAGE OUTLINE

VSSOP - 1.1 mm max height

SMALL OUTLINE PACKAGE



**NOTES:**

PowerPAD is a trademark of Texas Instruments.

1. All linear dimensions are in millimeters. Any dimensions in parenthesis are for reference only. Dimensioning and tolerancing per ASME Y14.5M.
2. This drawing is subject to change without notice.
3. This dimension does not include mold flash, protrusions, or gate burrs. Mold flash, protrusions, or gate burrs shall not exceed 0.15 mm per side.
4. This dimension does not include interlead flash. Interlead flash shall not exceed 0.25 mm per side.
5. Reference JEDEC registration MO-187.

# EXAMPLE BOARD LAYOUT

DGK0008A

™ VSSOP - 1.1 mm max height

SMALL OUTLINE PACKAGE



LAND PATTERN EXAMPLE  
EXPOSED METAL SHOWN  
SCALE: 15X

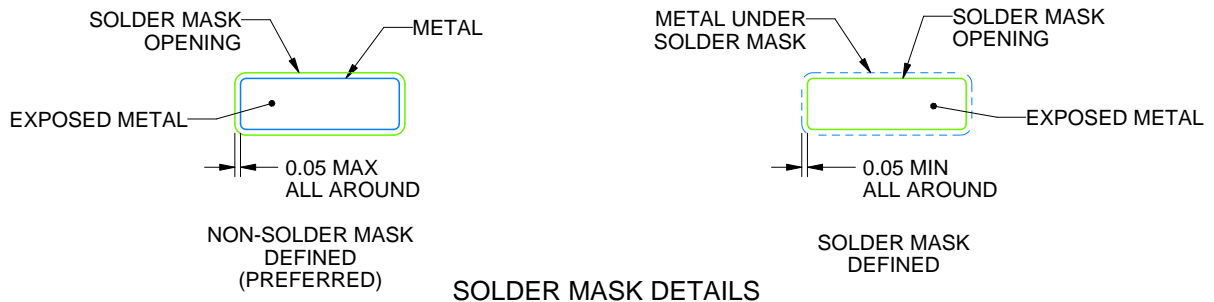

4214862/A 04/2023

NOTES: (continued)

6. Publication IPC-7351 may have alternate designs.
7. Solder mask tolerances between and around signal pads can vary based on board fabrication site.
8. Vias are optional depending on application, refer to device data sheet. If any vias are implemented, refer to their locations shown on this view. It is recommended that vias under paste be filled, plugged or tented.
9. Size of metal pad may vary due to creepage requirement.

# EXAMPLE STENCIL DESIGN

DGK0008A

™ VSSOP - 1.1 mm max height

SMALL OUTLINE PACKAGE



SOLDER PASTE EXAMPLE  
SCALE: 15X

4214862/A 04/2023

NOTES: (continued)

11. Laser cutting apertures with trapezoidal walls and rounded corners may offer better paste release. IPC-7525 may have alternate design recommendations.
12. Board assembly site may have different recommendations for stencil design.

## IMPORTANT NOTICE AND DISCLAIMER

TI PROVIDES TECHNICAL AND RELIABILITY DATA (INCLUDING DATASHEETS), DESIGN RESOURCES (INCLUDING REFERENCE DESIGNS), APPLICATION OR OTHER DESIGN ADVICE, WEB TOOLS, SAFETY INFORMATION, AND OTHER RESOURCES "AS IS" AND WITH ALL FAULTS, AND DISCLAIMS ALL WARRANTIES, EXPRESS AND IMPLIED, INCLUDING WITHOUT LIMITATION ANY IMPLIED WARRANTIES OF MERCHANTABILITY, FITNESS FOR A PARTICULAR PURPOSE OR NON-INFRINGEMENT OF THIRD PARTY INTELLECTUAL PROPERTY RIGHTS.

These resources are intended for skilled developers designing with TI products. You are solely responsible for (1) selecting the appropriate TI products for your application, (2) designing, validating and testing your application, and (3) ensuring your application meets applicable standards, and any other safety, security, regulatory or other requirements.

These resources are subject to change without notice. TI grants you permission to use these resources only for development of an application that uses the TI products described in the resource. Other reproduction and display of these resources is prohibited. No license is granted to any other TI intellectual property right or to any third party intellectual property right. TI disclaims responsibility for, and you fully indemnify TI and its representatives against any claims, damages, costs, losses, and liabilities arising out of your use of these resources.

TI's products are provided subject to [TI's Terms of Sale](#), [TI's General Quality Guidelines](#), or other applicable terms available either on [ti.com](http://ti.com) or provided in conjunction with such TI products. TI's provision of these resources does not expand or otherwise alter TI's applicable warranties or warranty disclaimers for TI products. Unless TI explicitly designates a product as custom or customer-specified, TI products are standard, catalog, general purpose devices.

TI objects to and rejects any additional or different terms you may propose.

Copyright © 2026, Texas Instruments Incorporated

Last updated 10/2025