

TLV3604、TLV3605、TLV3607 具有 LVDS 输出的 800ps 高速 RRI 比较器

1 特性

- 低传播延迟：800ps
- 低过驱动分散：350ps
- 静态电流：12.1mA
- 高切换频率：1.5GHz / 3.0Gbps
- 窄脉宽检测功能：600ps
- 数模转换器 (LVDS) 输出
- 电源电压范围：2.4V 至 5.5V
- 输入共模范围超出两个电源轨 200mV
- 低输入失调电压：±5mV
- 单通道和双通道选项

2 应用

- 激光雷达中的距离感测
- 飞行时间传感器
- 示波器和逻辑分析仪中的高速触发器功能
- 高速差分线路接收器
- 无人机视觉

3 说明

TLV3604、TLV3605 (单通道) 和 TLV3607 (双通道) 是具有 LVDS 输出和轨至轨输入的 800ps 高速比较器。这些比较器具有上述特性以及 2.4V 至 5.5V 的工作电压范围和 3Gbps 的高切换频率，因此非常适合激光雷达、时钟和数据恢复应用以及测试和测量系统。

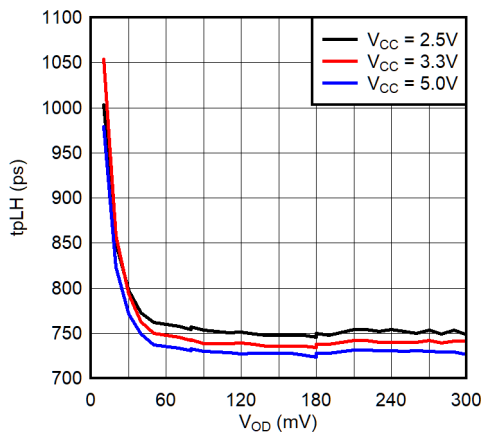

TpLH v. 过驱动分散

同样，TLV3604、TLV3605 和 TLV3607 具有 350ps 的强大输入过驱动性能，并且能够检测仅 600ps 的窄脉冲宽度。由于输入过驱动而导致的传播延迟变化较小，与检测窄脉冲的能力相结合，不仅提高了系统性能，而且扩展了飞行时间 (ToF) 应用中的距离范围。

TLV3604、TLV3605 和 TLV3607 的低压差分信号 (LVDS) 输出还有助于提高数据吞吐量并优化功耗。互补输出通过抑制每个输出上的共模噪声来降低 EMI。LVDS 输出旨在驱动和直接连接可接受标准 LVDS 输入 (例如高速 FPGA 和 CPU) 的下游器件。

TLV3604 采用微型 6 引脚 SC-70 封装，因此更适用于空间敏感型应用，例如光学传感器模块。TLV3605 (单通道) 和 TLV3607 (双通道) 保持与 TLV3604 相同的性能，并在 12 引脚 QFN 和 16 引脚 WQFN 封装中提供可调节的迟滞控制、关断和锁存特性，因而成为测试和测量应用的理想选择。

器件信息

器件型号	封装 (1)	本体尺寸 (标称值) (2)
TLV3604	SC70 (6)	1.25mm × 2.00mm
TLV3605	QFN (12)	3.00mm × 3.00mm
TLV3607	WQFN (16)	4.00mm × 4.00mm

(1) 如需了解所有可用封装，请参阅数据表末尾的可订购产品附录。

(2) 封装尺寸 (长 × 宽) 为标称值，并包括引脚 (如适用)。

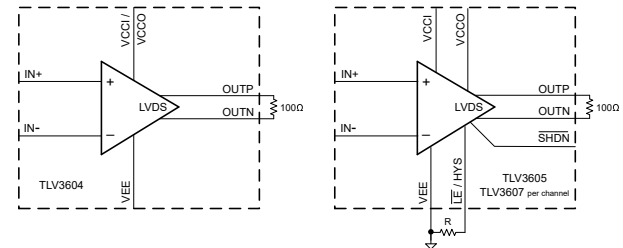

功能方框图

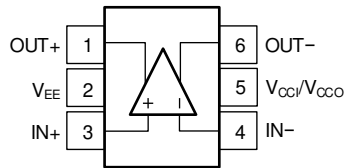

Table of Contents

1 特性	1	6.3 Feature Description.....	13
2 应用	1	6.4 Device Functional Modes.....	13
3 说明	1	7 Application and Implementation	14
4 Pin Configuration and Functions	3	7.1 Application Information.....	14
Pin Configurations: TLV3604 and TLV3605.....	3	7.2 Typical Application.....	16
4.1 Pin Configuration: TLV3607.....	4	7.3 Power Supply Recommendations.....	18
5 Specifications	5	7.4 Layout.....	18
5.1 Absolute Maximum Ratings.....	5	8 Device and Documentation Support	21
5.2 ESD Ratings.....	5	8.1 Device Support.....	21
5.3 Recommended Operating Conditions.....	5	8.2 接收文档更新通知.....	21
5.4 Thermal Information.....	6	8.3 支持资源.....	21
5.5 Electrical Characteristics ($V_{CCI} = V_{CCO} = 2.5V$ to 5V).....	7	8.4 Trademarks.....	21
5.6 Typical Characteristics.....	9	8.5 静电放电警告.....	21
6 Detailed Description	13	8.6 术语表.....	21
6.1 Overview.....	13	9 Revision History	21
6.2 Functional Block Diagram.....	13	10 Mechanical, Packaging, and Orderable Information	22

4 Pin Configuration and Functions

Pin Configurations: TLV3604 and TLV3605



**图 4-1. DCK Package
6-Pin SC70
Top View**

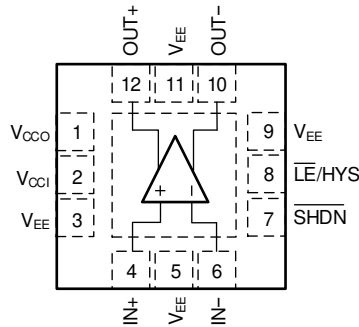

**图 4-2. RVK Package
12-Pin QFN
Top View**

表 4-1. Pin Functions: TLV3604 and TLV3605

NAME	PIN		I/O	DESCRIPTION
	TLV3604	TLV3605		
IN+	3	4	I	Non-inverting input
IN -	4	6	I	Inverting input
OUT+	1	12	O	Non-inverting output
OUT -	6	10	O	Inverting output
V _{EE}	2	3, 5, 9, 11	I	Negative power supply
V _{CCI}	5	2	I	Positive input section power supply
V _{CCO}	5	1	I	Positive output section power supply
SHDN	-	7	I	Shutdown control, active low
LE/HYS	-	8	I	Adjustable hysteresis control and latch

4.1 Pin Configuration: TLV3607

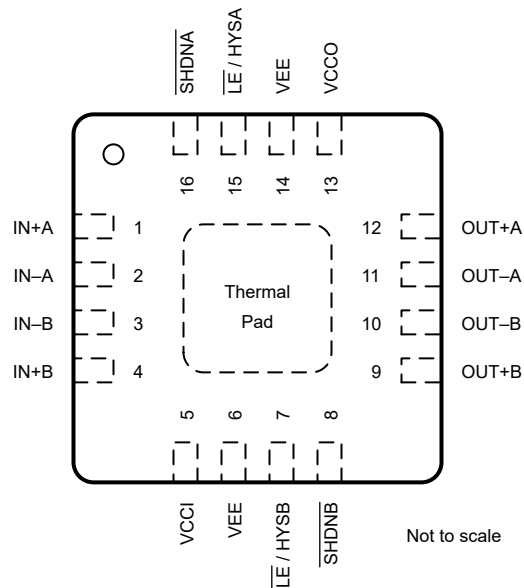

**图 4-3. RTE Package
16-Pin WQFN with Exposed Thermal Pad
Top View**

表 4-2. Pin Functions: TLV3607

PIN		I/O	DESCRIPTION
NAME	TLV3607		
IN+A	1	I	Channel A non-inverting input
IN - A	2	I	Channel A inverting input
IN - B	3	I	Channel B inverting input
IN+B	4	I	Channel B non-inverting input
OUT+A	12	O	Channel A non-inverting output
OUT - A	11	O	Channel A inverting output
OUT - B	10	O	Channel B inverting output
OUT+B	9	O	Channel B non-inverting output
V _{EE}	6, 14	I	Negative power supply
V _{CCI}	5	I	Positive input section power supply
V _{CCO}	13	I	Positive output section power supply
SHDNA	16	I	Channel A shutdown control (active low)
SHDNB	8	I	Channel B shutdown control (active low)
LE/HYSA	15	I	Channel A latch enable (active low) and adjustable hysteresis control
LE/HYSB	7	I	Channel B latch enable (active low) and adjustable hysteresis control

5 Specifications

5.1 Absolute Maximum Ratings

over operating free-air temperature range (unless otherwise noted)⁽¹⁾

	MIN	MAX	UNIT
Input Supply Voltage: $V_{CCI} - V_{EE}$	- 0.3	6	V
Output Supply Voltage: $V_{CCO} - V_{EE}$	- 0.3	6	V
Supply Voltage Difference: $V_{CCI} - V_{CCO}$	- 6	6	V
Input Voltage (IN+, IN -) ⁽²⁾	$V_{EE} - 0.3$	$V_{CCI} + 0.3$	V
Differential Input Voltage ($V_{DI} = IN+, IN -$)	$-(V_{CCI} + 0.3)$	$+(V_{CCI} + 0.3)$	V
Output Voltage (OUT+, OUT -) ⁽³⁾	$V_{EE} - 0.3$	$V_{CCO} + 0.3$	V
Shutdown Enable (SHDN)	$V_{EE} - 0.3$	$V_{CCO} + 0.3$	V
Latch and Hysteresis Control (\overline{LE}/HYS)	$V_{EE} - 0.3$	$V_{CCO} + 0.3$	V
Current into Input pins (IN+, IN -, \overline{SHDN} , \overline{LE}/HYS) ⁽²⁾	- 10	+10	mA
Current into Output pins (OUT+, OUT -) ⁽³⁾	- 10	+10	mA
Junction temperature, T_J		150	°C
Storage temperature, T_{stg}	- 65	150	°C

- (1) Operation outside the Absolute Maximum Ratings may cause permanent device damage. Absolute Maximum Ratings do not imply functional operation of the device at these or any other conditions beyond those listed under Recommended Operating Conditions. If used outside the Recommended Operating Conditions but within the Absolute Maximum Ratings, the device may not be fully functional, and this may affect device reliability, functionality, performance, and shorten the device lifetime.
- (2) Input terminals are diode-clamped to the power-supply rails. Input signals that can swing more than 0.3V beyond the supply rails or 6V, whichever is lower, must be current-limited to 10mA or less.
- (3) Output terminals are diode-clamped to the power-supply rails. Output signals that can swing more than 0.3V beyond the supply rails must be current-limited to 10mA or less.

5.2 ESD Ratings

		VALUE	UNIT
$V_{(ESD)}$	Electrostatic discharge	TLV3604 Human-body model (HBM), per ANSI/ESDA/JEDEC JS-001 ⁽¹⁾	±1500
		TLV3605, TLV3607 Human-body model (HBM), per ANSI/ESDA/JEDEC JS-001 ⁽¹⁾	±2000
		Charged-device model (CDM), per JEDEC specification JESD22-C101 ⁽²⁾	±1000

- (1) JEDEC document JEP155 states that 500V HBM allows safe manufacturing with a standard ESD control process.
- (2) JEDEC document JEP157 states that 250V CDM allows safe manufacturing with a standard ESD control process.

5.3 Recommended Operating Conditions

over operating free-air temperature range (unless otherwise noted)

	MIN	MAX	UNIT
Input Supply Voltage: $V_{CCI} - V_{EE}$	2.4	5.5	V
Output Supply Voltage: $V_{CCO} - V_{EE}$	2.4	5.5	V
Input Voltage Range (IN+, IN -)	$V_{EE} - 0.3$	$V_{CCI} + 0.3$	V
Shutdown Enable (SHDN)	$V_{EE} - 0.3$	$V_{CCO} + 0.3$	V
Latch and Hysteresis Control (\overline{LE}/HYS)	$V_{EE} - 0.3$	$V_{CCO} + 0.3$	V
Ambient temperature, T_A	- 40	125	°C

5.4 Thermal Information

THERMAL METRIC		TLV3604	TLV3605	TLV3607	UNIT
		DCK (SC70)	RVK (WQFN)	RTE (WQFN)	
		6 PINS	12 PINS	16 PINS	
$R_{\theta JA}$	Junction-to-ambient thermal resistance	170.3	85.8	72.1	°C/W
$R_{\theta JC(top)}$	Junction-to-case (top) thermal resistance	134.5	71.6	53.8	°C/W
$R_{\theta JC(bottom)}$	Junction-to-case (bottom) thermal resistance	N/A	15.1	35.7	°C/W
$R_{\theta JB}$	Junction-to-board thermal resistance	63.3	52.7	45.9	°C/W
ψ_{JT}	Junction-to-top characterization parameter	43.7	4.1	2.1	°C/W
ψ_{JB}	Junction-to-board characterization parameter	63.1	52.7	45.9	°C/W

5.5 Electrical Characteristics (V_{CCI} = V_{CCO} = 2.5V to 5V)

V_{CCI} = V_{CCO} = 2.5 to 5V, V_{EE} = 0V, V_{CM} = V_{EE} + 300mV, R_{LOAD} = 100Ω, C_L = 1pF probe capacitance, typical at T_A = 25°C (unless otherwise noted).

PARAMETER		TEST CONDITIONS	MIN	TYP	MAX	UNIT
DC Input Characteristics						
V _{IO} (1)	Input offset voltage	V _{CCI} = V _{CCO} = 2.5V and 5V T _A = -40°C to +125°C	-5	±0.5	5	mV
V _{CM}	Input common mode voltage range	V _{CCI} = V _{CCO} = 2.5V and 5V T _A = -40°C to +125°C	V _{EE} - 0.2		V _{CCI} + 0.2	V
V _{HYST}	Input hysteresis voltage			0		mV
C _{IN}	Input capacitance			1		pF
R _{DM}	Input differential mode resistance			67		kΩ
R _{CM}	Input common mode resistance			5		MΩ
I _B	Input bias current	V _{CCI} = V _{CCO} = 2.5V and 5V T _A = -40°C to +125°C	-5	-1	5	uA
I _{OS}	Input offset current	V _{CCI} = V _{CCO} = 2.5V and 5V T _A = -40°C to +125°C	-1		1	uA
CMRR (1)	Common-mode rejection ratio	V _{CCI} = V _{CCO} = 2.5V and 5V V _{CM} = V _{EE} - 0.2V to V _{CCI} + 0.2V, T _A = -40°C to +125°C	50	80		dB
PSRR (1)	Power-supply rejection ratio	V _{CCI} = V _{CCO} = 2.5V to 5V, T _A = -40°C to +125°C	55	80		dB
DC Output Characteristics						
V _{OCM}	Output common mode voltage	V _{CCI} = V _{CCO} = 2.5V and 5V T _A = -40°C to +125°C	1.125	1.2	1.375	V
ΔV _{OCM}	Output common mode voltage mismatch	V _{CCI} = V _{CCO} = 2.5V and 5V T _A = -40°C to +125°C			50	mV
V _{OCM_PP}	Peak-to-Peak output common mode voltage			20		mVpp
V _{OD}	Differential output voltage	V _{CCI} = V _{CCO} = 2.5V and 5V T _A = -40°C to +125°C	250	350	450	mV
ΔV _{OD}	Differential output voltage mismatch	V _{CCI} = V _{CCO} = 2.5V and 5V T _A = -40°C to +125°C			10	mV
Power Supply						
I _{CC} (TLV3604)	Total quiescent current	V _{CCI} = V _{CCO} = 2.5V and 5V T _A = -40°C to +125°C		12.1	16.5	mA
I _{CCI} (TLV3605)	Input stage quiescent current	V _{CCI} = V _{CCO} = 2.5V and 5V T _A = -40°C to +125°C		7.5	10.5	mA
I _{CCO} (TLV3605)	Output stage quiescent current	V _{CCI} = V _{CCO} = 2.5V and 5V T _A = -40°C to +125°C		5.2	7.0	mA
I _{CCI} (TLV3607)	Input stage quiescent current per channel	V _{CCI} = V _{CCO} = 2.5V and 5V T _A = -40°C to +125°C		7.5	10.5	mA
I _{CCO} (TLV3607)	Output stage quiescent current per channel	V _{CCI} = V _{CCO} = 2.5V and 5V T _A = -40°C to +125°C		5.2	7.0	mA
AC Characteristics						
t _{PD}	Propagation delay	V _{OVERDRIVE} = V _{UNDERDRIVE} = 50mV, 50MHz Squarewave		800		ps
t _{PD_SKEW}	Propagation delay skew	V _{OVERDRIVE} = V _{UNDERDRIVE} = 50mV, 50MHz Squarewave		40		ps
Δt _{PD} (TLV3607 only)	Channel-to-channel propagation delay skew ⁽²⁾	V _{OVERDRIVE} = V _{UNDERDRIVE} = 50mV, 50MHz Squarewave		10		ps
t _{CM_DISPERSION}	Common dispersion	V _{CM} varied from V _{EE} to V _{CCI}		200		ps
t _{OD_DISPERSION}	Overdrive dispersion	Overdrive varied from 10mV to 250mV		350		ps
t _{UD_DISPERSION}	Underdrive dispersion	Underdrive varied from 10mV to 250mV		200		ps
t _R	Rise time	20% to 80%		350		ps
t _F	Fall time	80% to 20%		350		ps

5.5 Electrical Characteristics ($V_{CCI} = V_{CCO} = 2.5V$ to $5V$) (续)

$V_{CCI} = V_{CCO} = 2.5$ to $5V$, $V_{EE} = 0V$, $V_{CM} = V_{EE} + 300mV$, $R_{LOAD} = 100\Omega$, $C_L = 1pF$ probe capacitance, typical at $T_A = 25^\circ C$ (unless otherwise noted).

PARAMETER		TEST CONDITIONS	MIN	TYP	MAX	UNIT
f_{TOGGLE}	Input toggle frequency	$V_{IN} = 200mV_{PP}$ Sine Wave, 50% Output swing		1.5		GHz
TR	Toggle rate	$V_{IN} = 200mV_{PP}$ Sine Wave, 50% Output swing		3.0		Gbps
f_{TOGGLE} (TLV3607 only)	Input toggle frequency	$V_{IN} = 200mV_{PP}$ Sine Wave, 50% Output swing		1.3		GHz
TR (TLV3607 only)	Toggle rate	$V_{IN} = 200mV_{PP}$ Sine Wave, 50% Output swing		2.6		Gbps
PulseWidth	Minimum allowed input pulse width	$V_{OVERDRIVE} = V_{UNDERDRIVE} = 50mV$ $PW_{OUT} = 90\%$ of PW_{IN}		600		ps
Latching/Adjustable Hysteresis (TLV3605 and TLV3607)						
V_{HYST}	Input hysteresis voltage	$R_{HYST} = Floating$		0		mV
V_{HYST}	Input hysteresis voltage	$R_{HYST} = 150k\Omega$		30		mV
V_{HYST}	Input hysteresis voltage	$R_{HYST} = 56k\Omega$		60		mV
V_{IH_LE}	\overline{LE} pin input high level	$V_{CCI} = V_{CCO} = 2.5V$ and $5V$ $T_A = -40^\circ C$ to $+125^\circ C$	1.5			V
V_{IL_LE}	\overline{LE} pin input low level	$V_{CCI} = V_{CCO} = 2.5V$ and $5V$ $T_A = -40^\circ C$ to $+125^\circ C$			0.35	V
I_{IH_LE}	\overline{LE} pin input leakage current	$V_{LE} = V_{CCO}$ $T_A = -40^\circ C$ to $+125^\circ C$			3.5	μA
I_{IL_LE}	\overline{LE} pin input leakage current	$V_{LE} = V_{EE}$, $T_A = -40^\circ C$ to $+125^\circ C$			40	μA
t_{SETUP}	Latch setup time			-3		ns
t_{HOLD}	Latch hold time			6		ns
t_{PL}	Latch to Q and \overline{Q} delay			4		ns
Shutdown Characteristics (TLV3605 and TLV3607)						
V_{IH_SD}	\overline{SHDN} pin input high level	$V_{CCI} = V_{CCO} = 2.5V$ and $5V$ $T_A = -40^\circ C$ to $+125^\circ C$	1.5			V
V_{IL_SD}	\overline{SHDN} pin input low level	$V_{CCI} = V_{CCO} = 2.5V$ and $5V$ $T_A = -40^\circ C$ to $+125^\circ C$			0.4	V
I_{IH_SD}	\overline{SHDN} pin input leakage current	$V_{CCI} = V_{CCO} = 2.5V$ and $5V$ $V_{SD} = V_{CCO}$, $T_A = -40^\circ C$ to $+125^\circ C$			2	μA
I_{IL_SD}	\overline{SHDN} pin input leakage current	$V_{CCI} = V_{CCO} = 2.5V$ and $5V$ $V_{SD} = V_{EE}$, $T_A = -40^\circ C$ to $+125^\circ C$			30	μA
I_{CCI_SD}	Input stage quiescent current per channel in Shutdown mode	$V_{CCI} = V_{CCO} = 2.5V$ and $5V$ $V_{LE} = V_{CCO}$ $T_A = -40^\circ C$ to $+125^\circ C$			1.5	mA
I_{CCO_SD}	Output stage quiescent current per channel in Shutdown mode	$V_{CCI} = V_{CCO} = 2.5V$ and $5V$ $T_A = -40^\circ C$ to $+125^\circ C$			100	μA
t_{SLEEP}	Sleep time from Active to Shutdown mode	10% output swing		8		ns
t_{WAKEUP}	Wake up time from Shutdown mode	$V_{OD} = 50mV$, output valid		100		ns

- For TLV3605 and TLV3607, the V_{IQ} is tested with $R_{HYST} = 150k\Omega$
- Differential propagation delay is defined as the larger of the two:
 $\Delta t_{PDLH} = t_{PDLH}(MAX) - t_{PDLH}(MIN)$
 $\Delta t_{PDHL} = t_{PDHL}(MAX) - t_{PDHL}(MIN)$
 where (MAX) and (MIN) denote the maximum and minimum values of a given measurement across the different comparator channels.

5.6 Typical Characteristics

At $T_A = 25^\circ\text{C}$, $V_{CC1}/V_{CC0} = 2.5\text{V}$ to 5.0V , $V_{CM} = 0.3\text{V}$, and input overdrive/underdrive = 50mV unless otherwise noted.



图 5-1. I_Q vs Temperature



图 5-2. V_{OS} vs V_{CM} @ $V_{CC} = 2.5\text{V}$ - 50 Devices

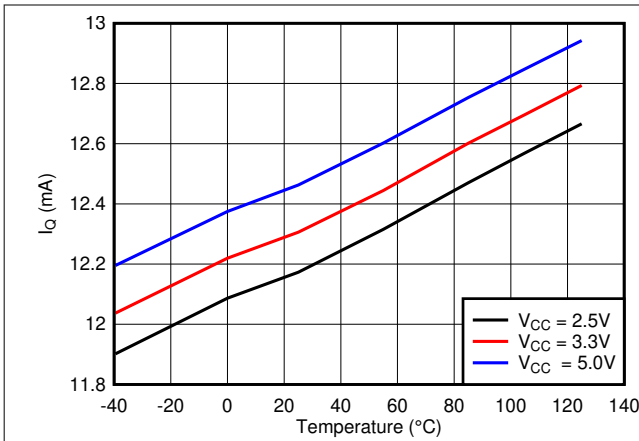

图 5-3. V_{OS} vs V_{CM} @ $V_{CC} = 3.3\text{V}$ - 50 Devices

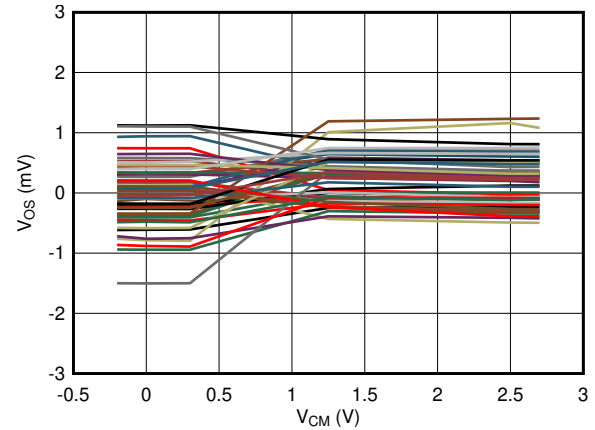

图 5-4. V_{OS} vs V_{CM} @ $V_{CC} = 5.0\text{V}$ - 50 Devices

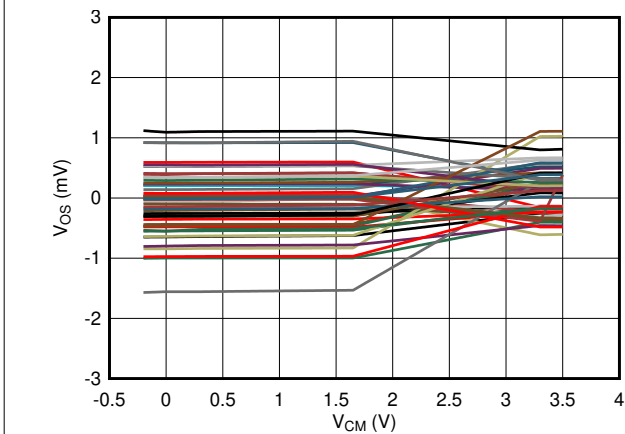

图 5-5. Bias Current vs Temperature

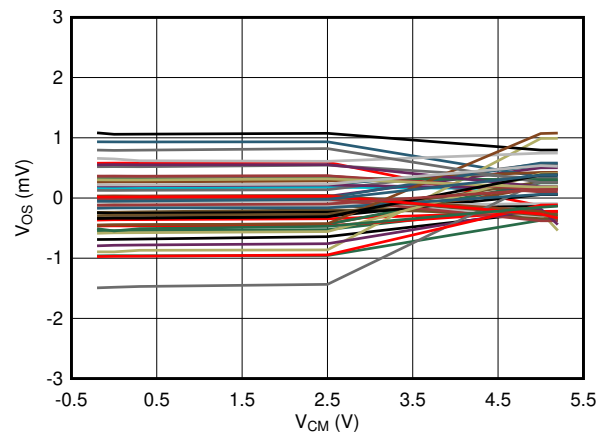

图 5-6. Input Bias Current vs V_{CM} @ $V_{CC} = 2.5\text{V}$

5.6 Typical Characteristics (continued)

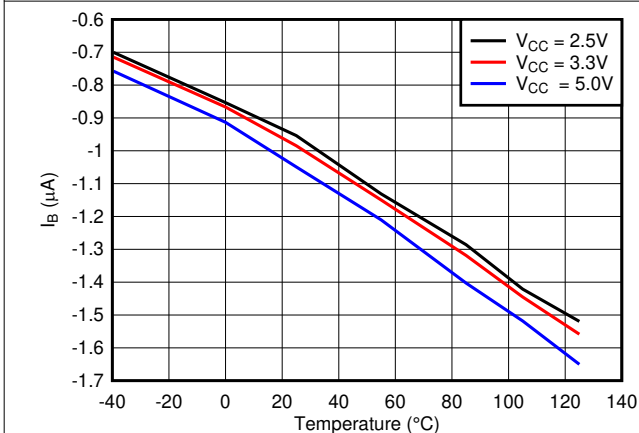
At $T_A = 25^\circ\text{C}$, $V_{CC1}/V_{CC0} = 2.5\text{V to }5.0\text{V}$, $V_{CM} = 0.3\text{V}$, and input overdrive/underdrive = 50mV unless otherwise noted.

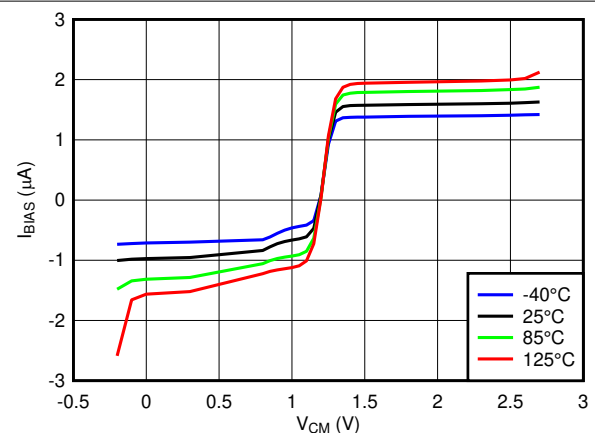

图 5-7. Input Bias Current vs V_{CM} @ $V_{CC} = 3.3\text{V}$



图 5-8. Input Bias Current vs V_{CM} @ $V_{CC} = 5.0\text{V}$

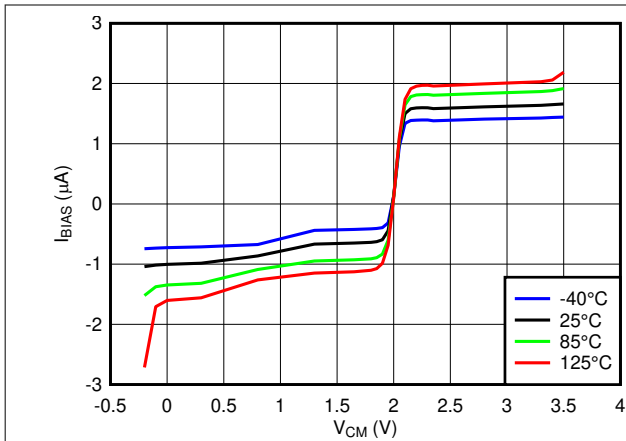

图 5-9. Ftoggle vs Temperature

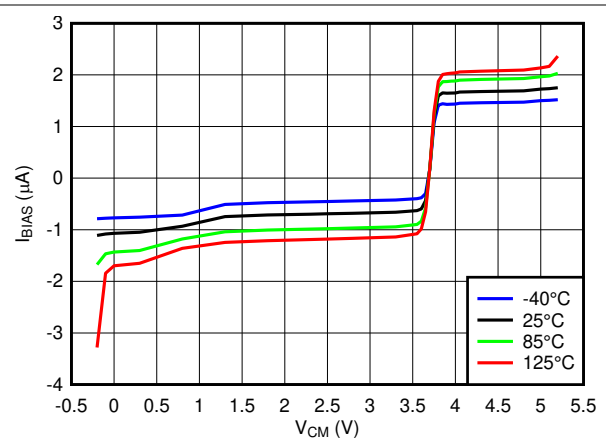

图 5-10. Ftoggle vs V_{CM} @ $V_{CC} = 2.5\text{V}$

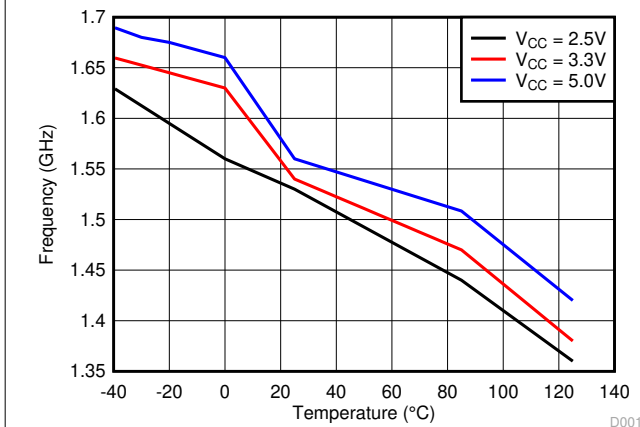

图 5-11. Ftoggle vs V_{CM} @ $V_{CC} = 3.3\text{V}$

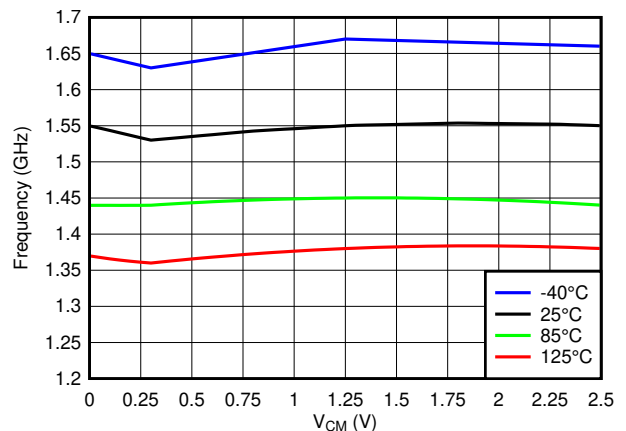

图 5-12. Ftoggle vs V_{CM} @ $V_{CC} = 5.0\text{V}$

5.6 Typical Characteristics (continued)

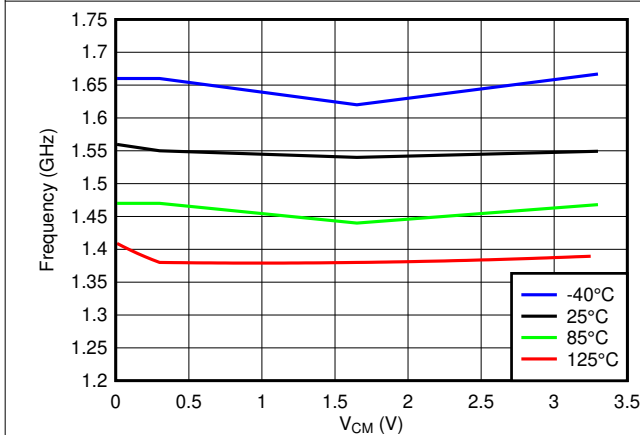
At $T_A = 25^\circ\text{C}$, $V_{CC1}/V_{CC0} = 2.5\text{V to }5.0\text{V}$, $V_{CM} = 0.3\text{V}$, and input overdrive/underdrive = 50mV unless otherwise noted.

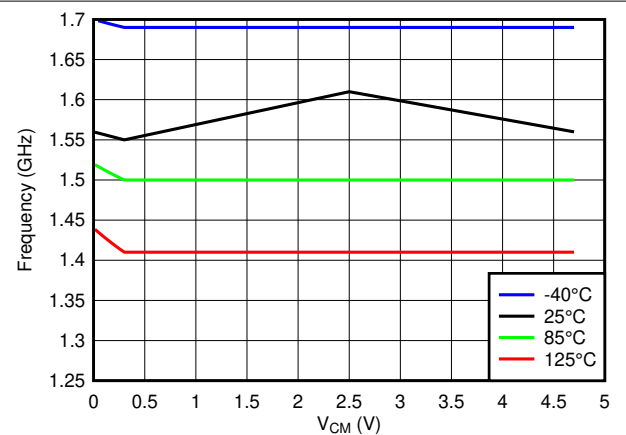

图 5-13. T_{PLH} vs V_{CM} @ $V_{CC} = 2.5\text{V}$



图 5-14. T_{PLH} vs V_{CM} @ $V_{CC} = 3.3\text{V}$

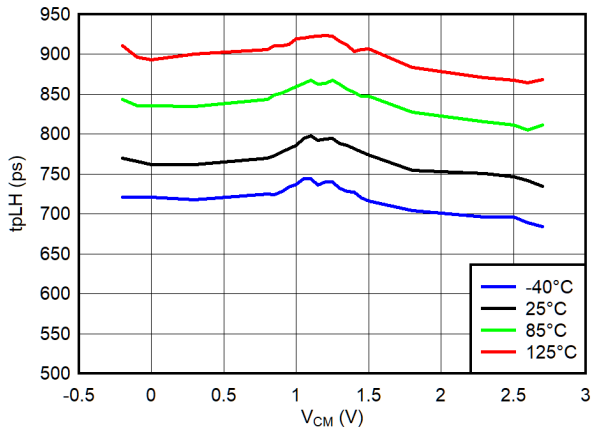

图 5-15. T_{PLH} vs V_{CM} @ $V_{CC} = 5.0\text{V}$

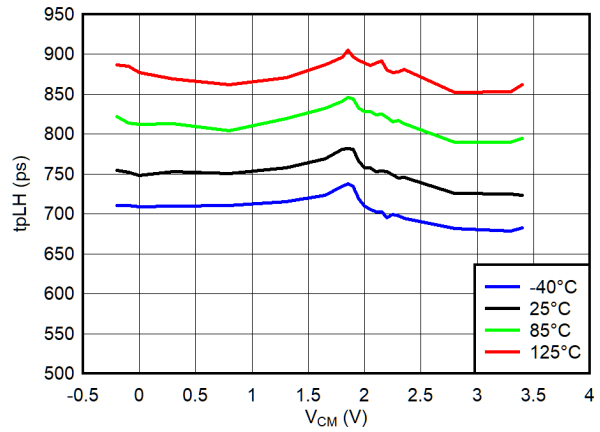

图 5-16. T_{PHL} vs V_{CM} @ $V_{CC} = 2.5\text{V}$

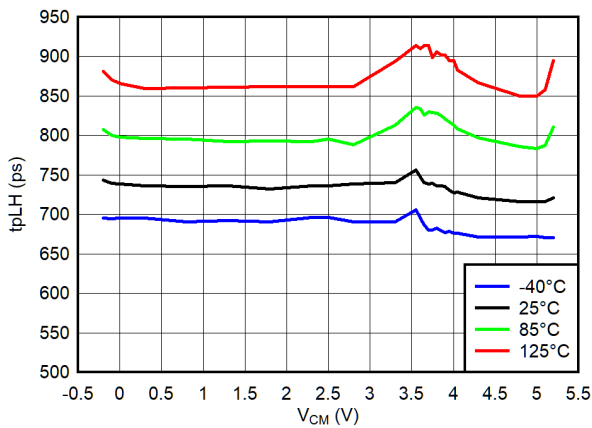

图 5-17. T_{PHL} vs V_{CM} @ $V_{CC} = 3.3\text{V}$

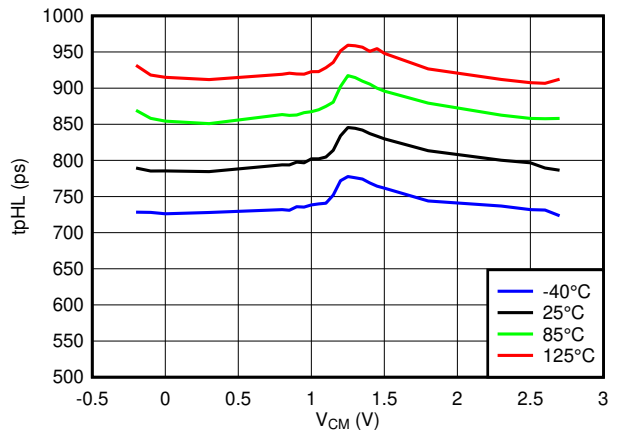

图 5-18. T_{PHL} vs V_{CM} @ $V_{CC} = 5.0\text{V}$

5.6 Typical Characteristics (continued)

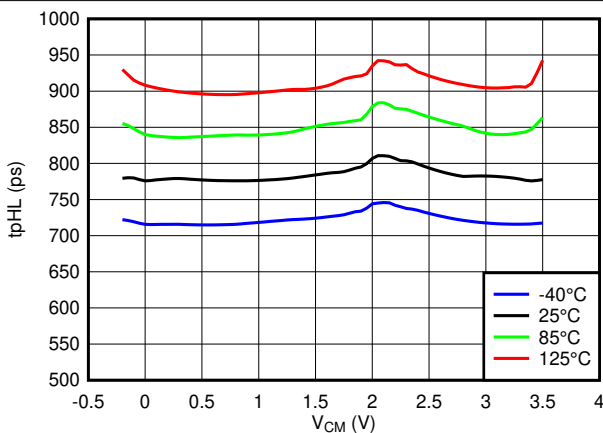
At $T_A = 25^\circ\text{C}$, $V_{CC1}/V_{CC0} = 2.5\text{V to }5.0\text{V}$, $V_{CM} = 0.3\text{V}$, and input overdrive/underdrive = 50mV unless otherwise noted.

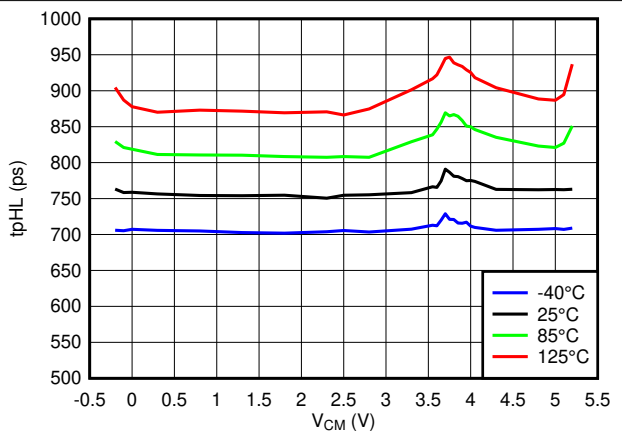

图 5-19. T_{PLH} vs Input Overdrive @ $V_{CC} = 2.5\text{V}$



图 5-20. T_{PLH} vs Input Overdrive @ $V_{CC} = 3.3\text{V}$

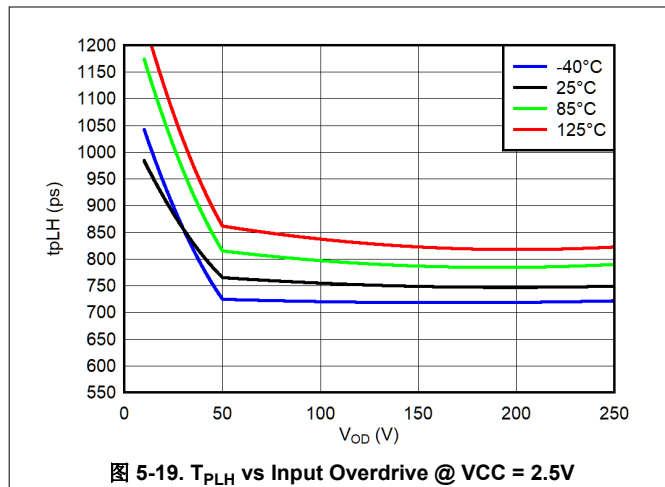

图 5-21. T_{PLH} vs Input Overdrive @ $V_{CC} = 5.0\text{V}$

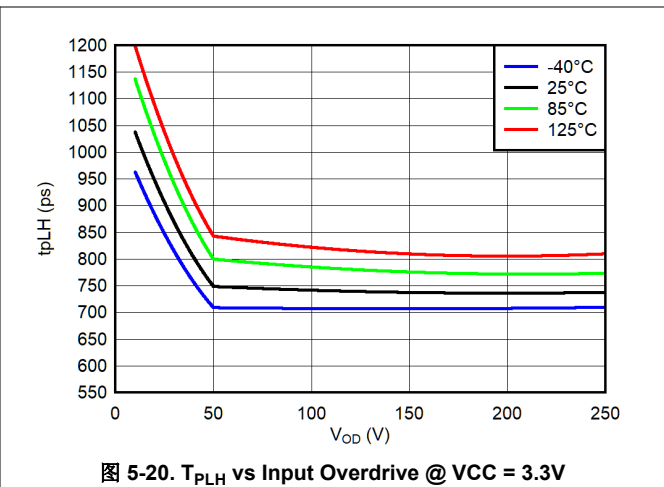

图 5-22. T_{PLH} vs Input Underdrive @ $V_{CC} = 2.5\text{V}$

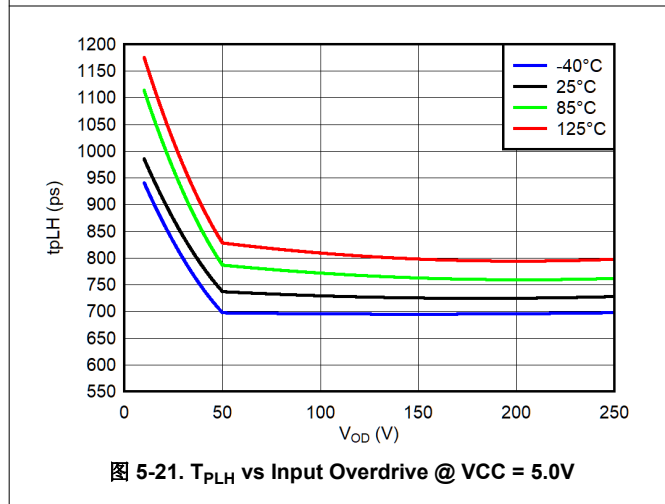

图 5-23. T_{PLH} vs Input Underdrive @ $V_{CC} = 3.3\text{V}$

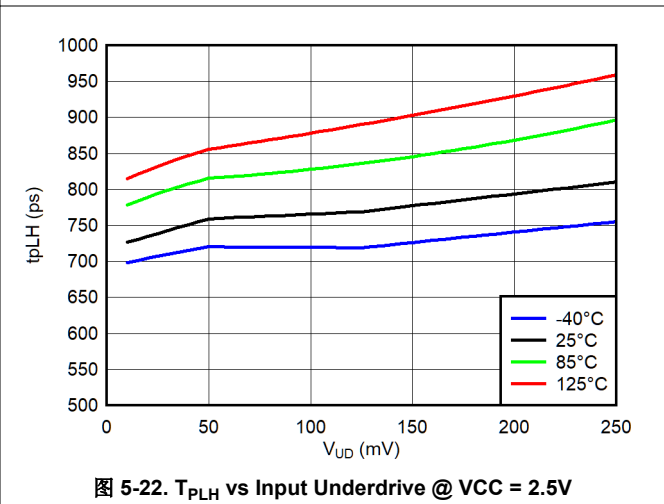

图 5-24. T_{PLH} vs Input Underdrive @ $V_{CC} = 5.0\text{V}$

6 Detailed Description

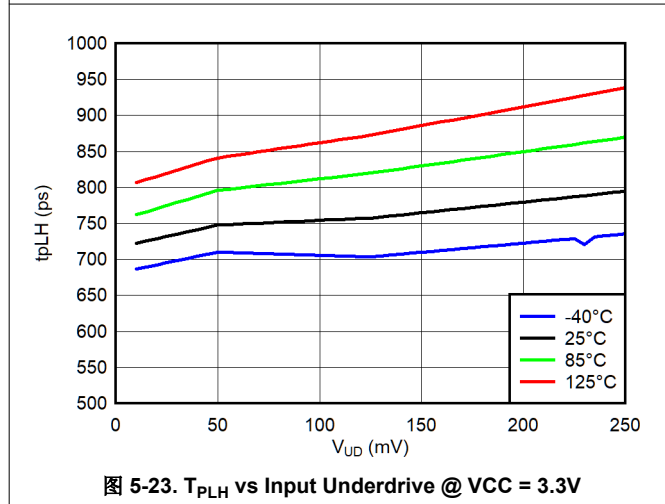
6.1 Overview

The TLV3604, TLV3605, and TLV3607 are 800ps, high-speed comparators with LVDS outputs and rail-to-rail inputs. These features, along with an operating voltage range of 2.4V to 5.5V and a high toggle frequency of 3Gbps, make the TLV3604, TLV3605, and TLV3607 well suited for LIDAR, clock and data recovery applications, and test and measurement systems.

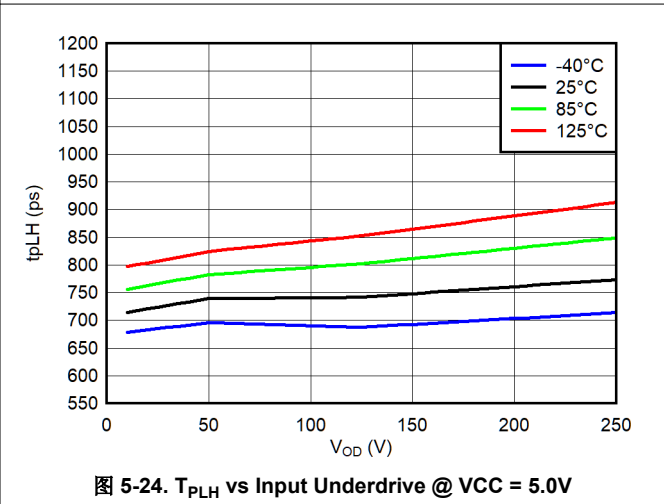
6.2 Functional Block Diagram

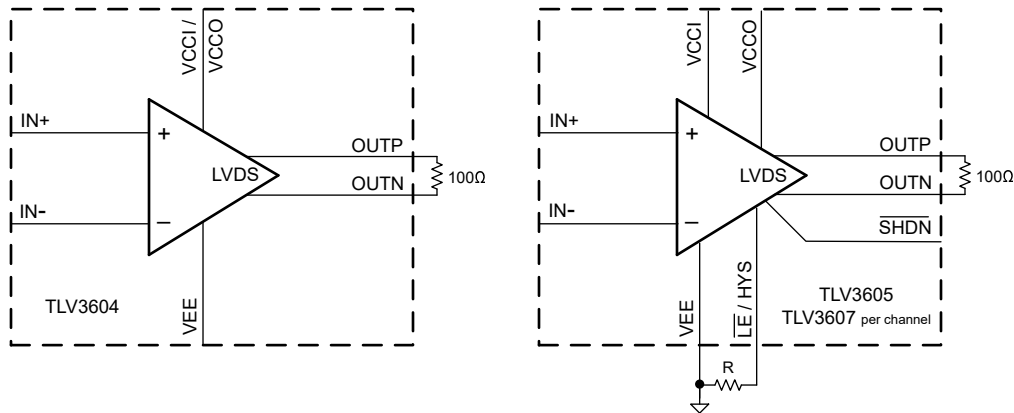

6.3 Feature Description

The TLV3604 and TLV3605 (single channel) and TLV3607 (dual channel) are high-speed comparators with rail-to-rail inputs and LVDS outputs. The rail-to-rail input stage is capable of operating up to 200mV beyond each power supply rail with minimal input offset. The TLV3605 (single) and TLV3607 (dual) have similar performance as the TLV3604 while providing adjustable hysteresis, latching function, and shutdown mode.

6.4 Device Functional Modes

The TLV3604 has a single functional mode and is operational when the power supply voltage is greater than the minimum operating voltage. The TLV3605 and TLV3607 have an active and shutdown mode. The TLV3605 and TLV3607 are in shutdown mode when the SHDN pin is logic low. To allow for easy interface with 1.8V FPGAs and CPUs, the SHDN pin is 1.8V logic compliant and independent of the comparator power supply.

6.4.1 Rail-to-Rail Inputs

The TLV3604, TLV3605, and TLV3607 feature input stages capable of operating 200mV below or above the power supply rails, allowing for zero cross detection and maximizing input dynamic range. With low input offset voltage, the comparators improve system performance in high sensitivity signal detection.

6.4.2 LVDS Output

The TLV3604, TLV3605, and TLV3607 outputs are LVDS compliant. When the input of the downstream device is terminated with a 100 Ω resistor, it provides a ± 350 mV LVDS swing. Fully differential outputs enable fast digital toggling and reduce EMI compared to single-ended output standards.

7 Application and Implementation

备注

以下应用部分中的信息不属于 TI 器件规格的范围，TI 不担保其准确性和完整性。TI 的客户应负责确定器件是否适用于其应用。客户应验证并测试其设计，以确保系统功能。

7.1 Application Information

The TLV3604, TLV3605, and TLV3607 comparators feature rail-to-rail inputs and a LVDS output stage that is well-suited for high speed applications that require low power consumption. The 800ps propagation delay of the comparators improve performance and extend the range for applications involving optical reception, triggers for test and measurement systems, and transceivers that require a high speed signal to be carried over a certain distance.

7.1.1 Comparator Inputs

The TLV3604, TLV3605, and TLV3607 are rail-to-rail input comparators, with an input common-mode range that exceeds the supply rails by 200mV for both positive and negative supplies.

7.1.2 Capacitive Loads

Under reasonable capacitive loads, the device maintains specified propagation delay. However, excessive capacitive loading under high switching frequencies may increase supply current, propagation delay, or induce decreased slew rate.

7.1.3 Latch Functionality

The latch pin for the TLV3605 and TLV3607 holds the output state of the device when the voltage at the LEB/HYST pin is less than 800mV above V_{EE} . This is particularly useful when the output state is intended to remain unchanged. An important consideration of the latch functionality is the latch hold time. Latch hold time is the minimum time (after the latch pin is asserted) required for properly latching the comparator output.



图 7-1. Valid Latch Diagram

Likewise, latch setup time is defined as the time that the input must be stable before the latch pin is asserted low. The figure above illustrates when the input can transition for a valid latch. Note that the typical setup time in the EC table is negative; this is due to the internal trace delays of the LEB/HYST pin relative to the input pin trace delays.

A small delay in the output response is shown below when the TLV3605 and TLV3607 exits a latched output stage.

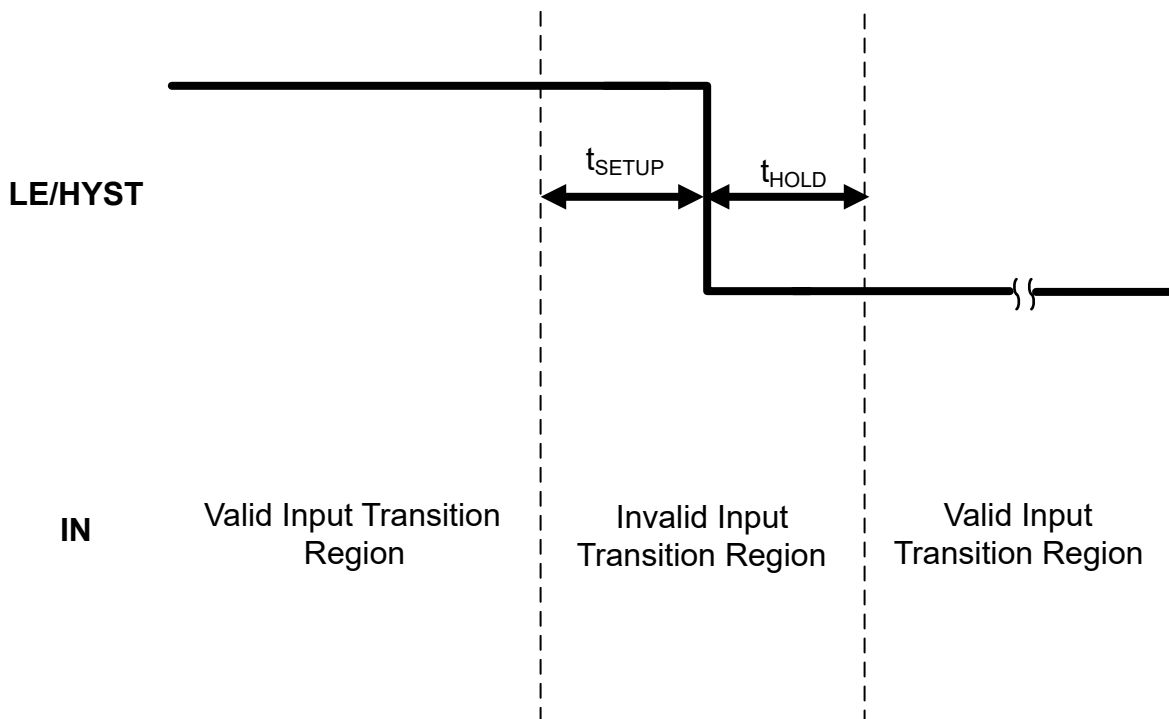

图 7-2. Latch Disable with Input Change

7.1.4 Adjustable Hysteresis

As a result of a comparator's high open loop gain, there is a small band of input differential voltage where the output can toggle back and forth between "logic high" and "logic low" states. This can cause design challenges for inputs with slow rise and fall times or systems with excessive noise.

These challenges can be overcome by adding hysteresis to the comparator. Since the TLV3604 does not have internal hysteresis, external hysteresis can be applied in the form of a positive feedback loop that adjusts the trip point of the comparator depending on its current output state. See the Typical Application section for more details.

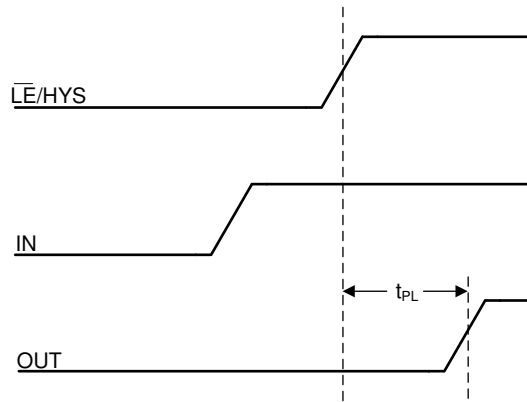
The TLV3605 and TLV3607 have a LEB/HYST pin that can be used to increase the internal hysteresis of the comparator. To change the internal hysteresis of the TLV3605 and TLV3607, connect a single resistor as shown in the [adjusting hysteresis figure](#) between the LEB/HYST pin and VEE. A curve of hysteresis versus resistance is provided below to provide guidance in setting the desired amount of hysteresis.



图 7-3. Adjusting Hysteresis with an External Resistor (R)



图 7-4. V_{HYST} (mV) vs R_{HYST} (kΩ), $V_{CC} = 3.3V$

7.2 Typical Application

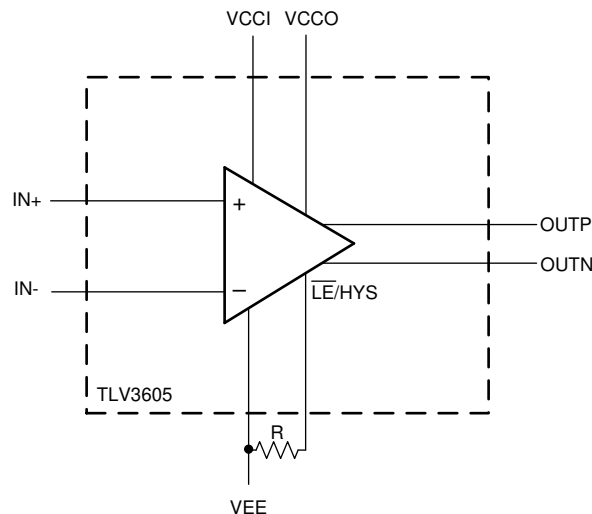
7.2.1 Non-Inverting Comparator With Hysteresis

A way to implement external hysteresis is to add two resistors to the circuit: one in series between the reference voltage and the inverting pin, and another from the inverting pin to one of the differential output pins.

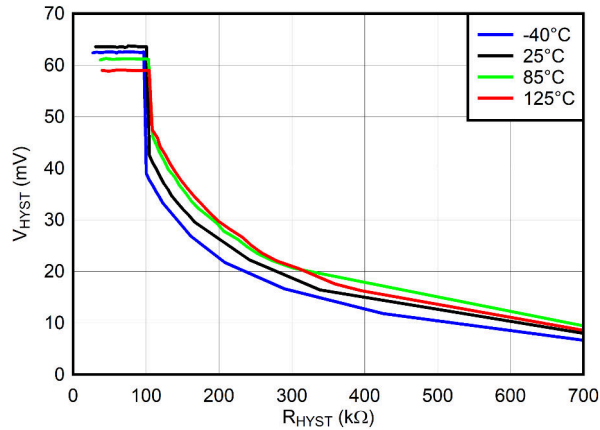

图 7-5. Non-Inverting Comparator with Hysteresis Circuit

7.2.1.1 Design Requirements

表 7-1. Design Parameters

PARAMETER	VALUE
V_{HYS}	50mV
V_{REF}	2.5V
V_{T1}	2.34V
V_{T2}	2.29V
Q	1.375V
\bar{Q}	1.025V

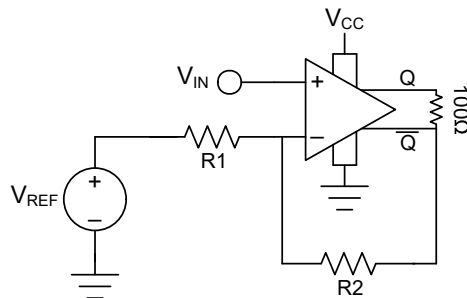
7.2.1.2 Detailed Design Procedure

First, create an equation for V_T that covers both output voltages when the output is high or low.

$$V_{T1} = \frac{V_{REF}R_2 + QR_1}{R_1 + R_2} \tag{1}$$

$$V_{T2} = \frac{V_{REF}R_2 + \overline{Q}R_1}{R_1+R_2} \quad (2)$$

The hysteresis voltage in this network is equal to the difference in the two threshold voltage equations.

$$V_{HYS} = V_{T1} - V_{T2} \quad (3)$$

$$V_{HYS} = \frac{V_{REF}R_2 + QR_1}{R_1+R_2} - \frac{V_{REF}R_2 + \overline{Q}R_1}{R_1+R_2} \quad (4)$$

$$V_{HYS} = \frac{(Q - \overline{Q})R_1}{R_1+R_2} \quad (5)$$

$$V_{HYS} = \frac{V_{OD}R_1}{R_1+R_2} \quad (6)$$

Note that these equations do not take into account the effects of the internal hysteresis and offset voltage of the comparator. Design parameters need to be adjusted accordingly.

Select a value for R2. Plug in given values for V_{REF} , V_{T1} , V_{T2} , Q, and \overline{Q} , and solve for R1. For the given example, $R_2 = 50k\ \Omega$, and R1 is solved as $= 8.3k\ \Omega$.

7.2.1.3 Application Performance Plots



图 7-6. Hysteresis Curve for LVDS Comparator

7.2.2 Optical Receiver

The TLV3604, TLV3605, and TLV3607 can be used in conjunction with a high performance amplifier such as the OPA855 to create an optical receiver as shown in the 图 7-7. The photo diode is connected to a bias voltage and is being driven with a pulsed laser. The OPA855 takes the current conducting through the diode and translates it into a voltage for a high speed comparator to detect. The TLV3604, TLV3605, and TLV3607 will then output the proper LVDS signal according to the threshold set (V_{REF2}).

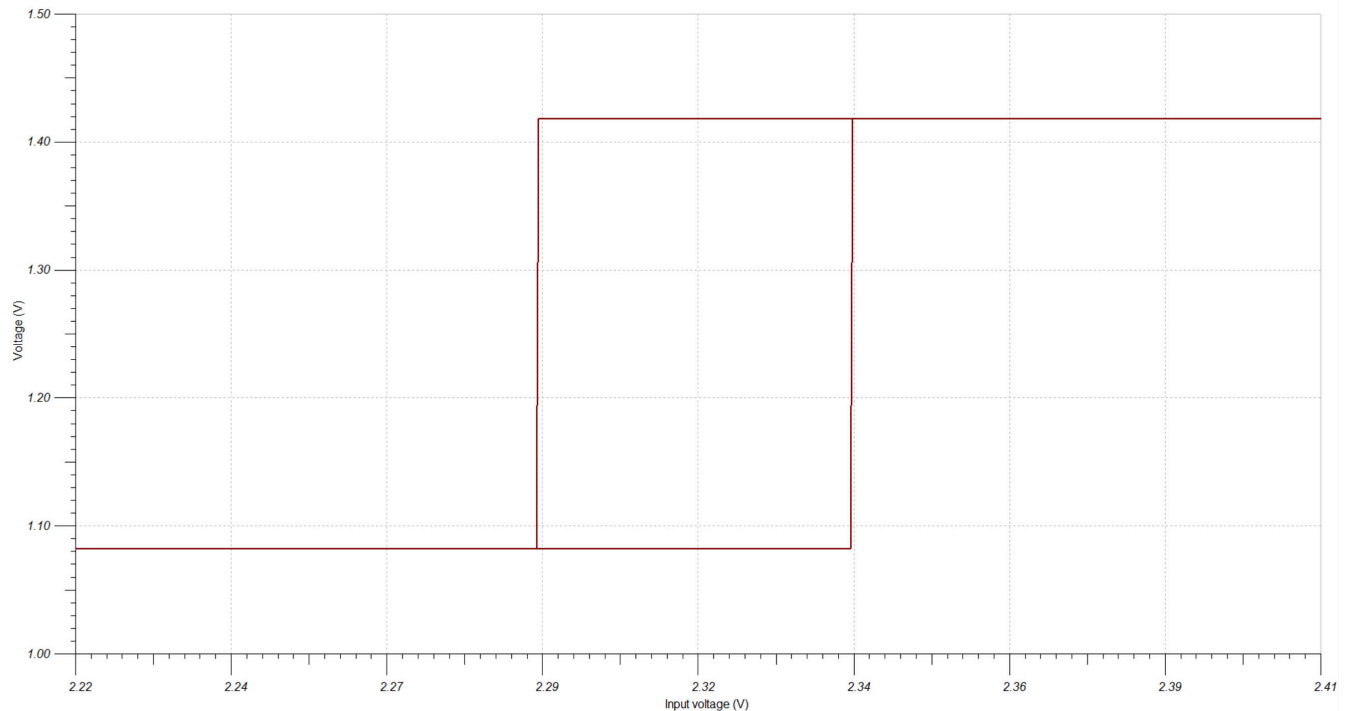

图 7-7. Optical Receiver

7.2.3 Logic Clock Source to LVDS Transceiver

The 图 7-8 shows a logic clock source being terminated and driven with the TLV3604, TLV3605, and TLV3607 across a CAT6 Cable to receive an equivalent LVDS clock signal at the receiver end.

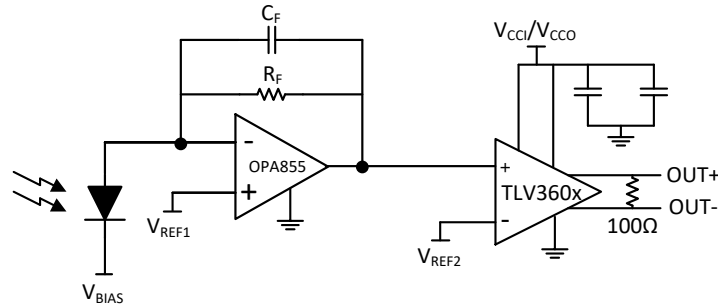

图 7-8. LVDS Clock Transceiver

7.2.4 External Trigger Function for Oscilloscopes

图 7-9 is a typical configuration for creating an external trigger on oscilloscopes. The user adjusts the trigger level, and a DAC converts this trigger level to a voltage the TLV360x can use as a reference. The input voltage from an oscilloscope channel is then compared to the trigger reference voltage, and the TLV3604, TLV3605, and TLV3607 sends an LVDS signal to a downstream FPGA to begin a capture.

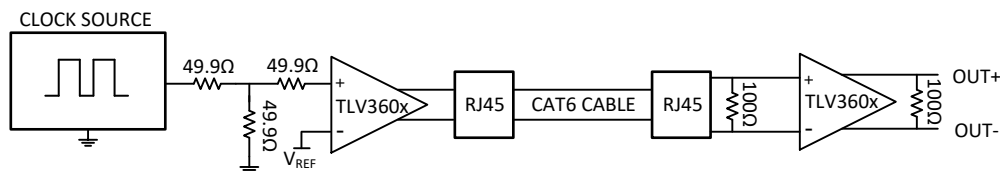

图 7-9. External Trigger Function

7.3 Power Supply Recommendations

The TLV3604, TLV3605, and TLV3607 are recommended for operation from 2.4V to 5.5V. One benefit of the TLV3605 and TLV3607 is that the comparator has separate input and output supply pins (VCCI and VCCO). This provides a system designer the flexibility of powering the input stage with a higher supply voltage such as 5V to maximize the dynamic range of the input while powering the output stage with a 2.5V supply to save power. Regardless of the VCCO supply voltage, the control pins such as LEB and SHDNB are 1.8V logic compliant.

7.4 Layout

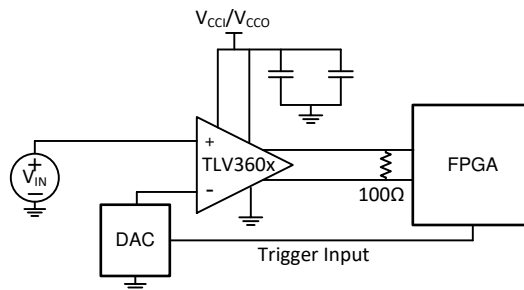
7.4.1 Layout Guidelines

Comparators are very sensitive to input noise. For best results, adhere to the following layout guidelines.

1. Use a printed-circuit-board (PCB) with a good, unbroken, low-inductance ground plane. Proper grounding (use of a ground plane) helps maintain specified device performance and input/output trace impedances.
2. To minimize supply noise, place a decoupling capacitor (0.1- μ F ceramic, surface-mount capacitor) directly between VCCI/VCCO and VEE.
3. On the inputs and outputs, utilize matched trace lengths to minimize timing skew. Also, minimize trace lengths and maximize ground pour spacings around the input and output traces to limit parasitic capacitance.
4. Solder the device directly to the PCB rather than using a socket.
5. For slow-moving input signals, take care to prevent parasitic feedback. A small capacitor (1000pF or less) placed between the inputs can help eliminate oscillations in the transition region. This capacitor causes minimal degradation to propagation delay when source impedance is low.
6. Use a 100 Ω termination resistor across the device's LVDS outputs.
7. Use higher performance substrate materials such as Rogers or High-Speed FR4.
8. PCB signal layers from the TLV3604EVM are shown for reference.

7.4.2 Layout Example

Figure 10-1 shows the 4 layer PCB signal routing for the TLV3604EVM as an example for how layout on this device can be done.

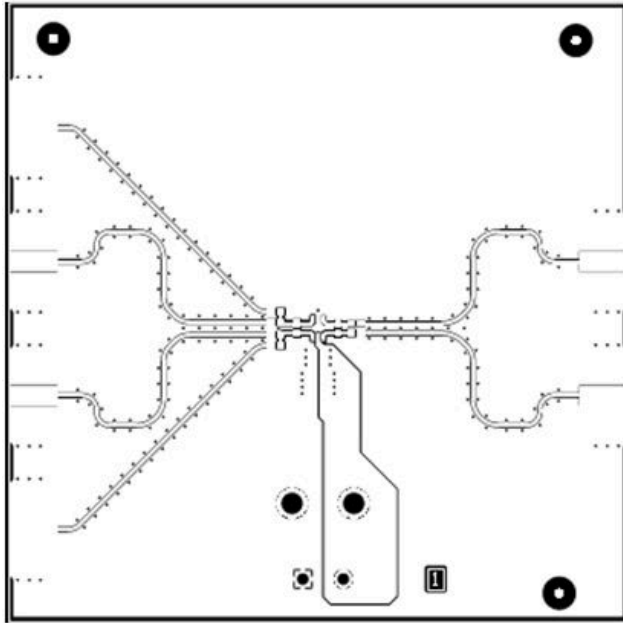

Top Layer

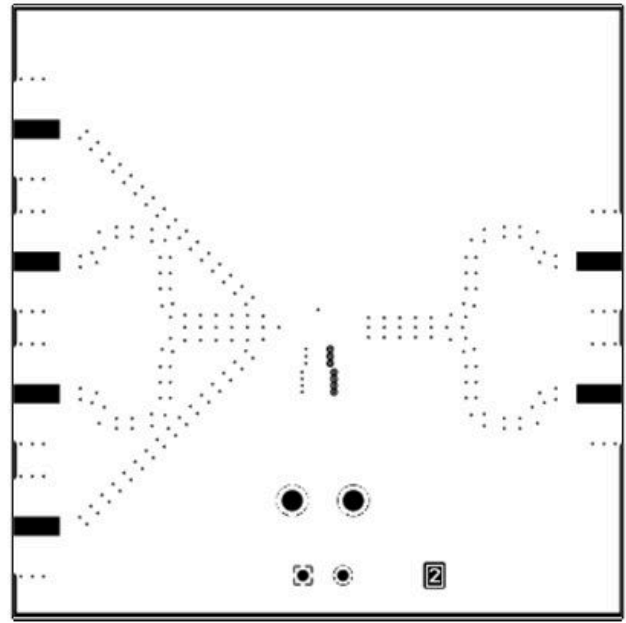

GND-1 Layer

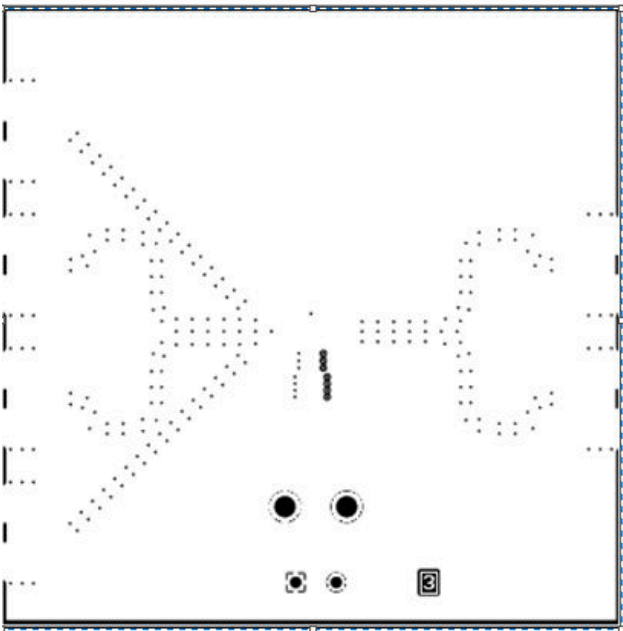

GND-2 Layer

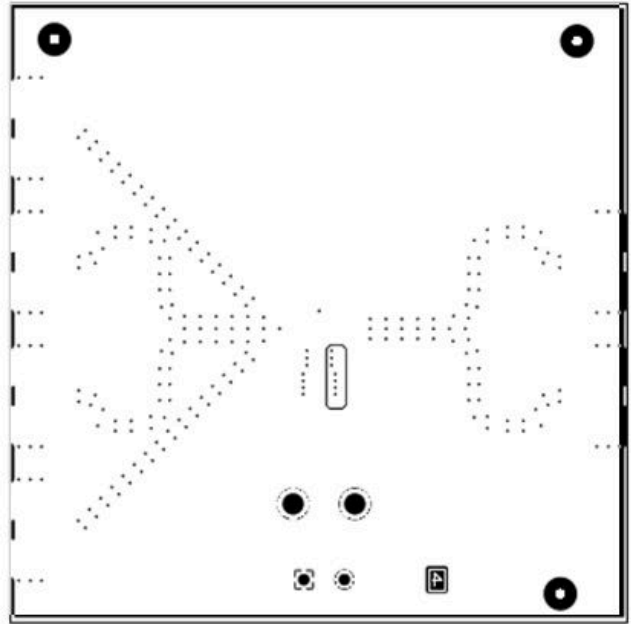

Bottom Layer

图 7-10. TLV3604EVM Layout Example

8 Device and Documentation Support

8.1 Device Support

8.1.1 Development Support

[LIDAR Pulsed Time of Flight Reference Design](#)

8.2 接收文档更新通知

要接收文档更新通知，请导航至 [ti.com](https://www.ti.com) 上的器件产品文件夹。点击 [通知](#) 进行注册，即可每周接收产品信息更改摘要。有关更改的详细信息，请查看任何已修订文档中包含的修订历史记录。

8.3 支持资源

[TI E2E™ 中文支持论坛](#) 是工程师的重要参考资料，可直接从专家处获得快速、经过验证的解答和设计帮助。搜索现有解答或提出自己的问题，获得所需的快速设计帮助。

链接的内容由各个贡献者“按原样”提供。这些内容并不构成 TI 技术规范，并且不一定反映 TI 的观点；请参阅 TI 的 [使用条款](#)。

8.4 Trademarks

TI E2E™ is a trademark of Texas Instruments.

所有商标均为其各自所有者的财产。

8.5 静电放电警告



静电放电 (ESD) 会损坏这个集成电路。德州仪器 (TI) 建议通过适当的预防措施处理所有集成电路。如果不遵守正确的处理和安装程序，可能会损坏集成电路。

ESD 的损坏小至导致微小的性能降级，大至整个器件故障。精密的集成电路可能更容易受到损坏，这是因为非常细微的参数更改都可能会导致器件与其发布的规格不相符。

8.6 术语表

[TI 术语表](#) 本术语表列出并解释了术语、首字母缩略词和定义。

9 Revision History

注：以前版本的页码可能与当前版本的页码不同

Changes from Revision E (July 2023) to Revision F (June 2024) Page

- 将 TLV3607 传播延迟降低至 800ps..... [1](#)
- Updated Typical Application section..... [16](#)

Changes from Revision D (June 2021) to Revision E (July 2023) Page

- 在整个数据表中添加了双通道 TLV3607..... [1](#)

Changes from Revision C (April 2021) to Revision D (June 2021) Page

- Update Hysteresis Curve..... [15](#)

Changes from Revision B (December 2020) to Revision C (April 2021) **Page**

- Updated Typical Performance Curves.....9
 - Updated Latch Functionality..... 14
-

Changes from Revision A (August 2020) to Revision B (December 2020) **Page**

- APL 到 RTM 版本..... 1
-

10 Mechanical, Packaging, and Orderable Information

The following pages include mechanical, packaging, and orderable information. This information is the most current data available for the designated devices. This data is subject to change without notice and revision of this document. For browser-based versions of this data sheet, refer to the left-hand navigation.

PACKAGING INFORMATION

Orderable Device	Status (1)	Package Type	Package Drawing	Pins	Package Qty	Eco Plan (2)	Lead finish/ Ball material (6)	MSL Peak Temp (3)	Op Temp (°C)	Device Marking (4/5)	Samples
TLV3604DCKR	ACTIVE	SC70	DCK	6	3000	RoHS & Green	NIPDAU	Level-1-260C-UNLIM	-40 to 125	1HF	Samples
TLV3604DCKT	ACTIVE	SC70	DCK	6	250	RoHS & Green	NIPDAU	Level-1-260C-UNLIM	-40 to 125	1HF	Samples
TLV3605RVKR	ACTIVE	WQFN	RVK	12	3000	RoHS & Green	NIPDAU	Level-1-260C-UNLIM	-40 to 125	3605	Samples
TLV3605RVKT	ACTIVE	WQFN	RVK	12	250	RoHS & Green	NIPDAU	Level-1-260C-UNLIM	-40 to 125	3605	Samples
TLV3607RTER	ACTIVE	WQFN	RTE	16	5000	RoHS & Green	NIPDAU	Level-1-260C-UNLIM	-40 to 125	TL3607	Samples

(1) The marketing status values are defined as follows:

ACTIVE: Product device recommended for new designs.

LIFEBUY: TI has announced that the device will be discontinued, and a lifetime-buy period is in effect.

NRND: Not recommended for new designs. Device is in production to support existing customers, but TI does not recommend using this part in a new design.

PREVIEW: Device has been announced but is not in production. Samples may or may not be available.

OBSELETE: TI has discontinued the production of the device.

(2) **RoHS:** TI defines "RoHS" to mean semiconductor products that are compliant with the current EU RoHS requirements for all 10 RoHS substances, including the requirement that RoHS substance do not exceed 0.1% by weight in homogeneous materials. Where designed to be soldered at high temperatures, "RoHS" products are suitable for use in specified lead-free processes. TI may reference these types of products as "Pb-Free".

RoHS Exempt: TI defines "RoHS Exempt" to mean products that contain lead but are compliant with EU RoHS pursuant to a specific EU RoHS exemption.

Green: TI defines "Green" to mean the content of Chlorine (Cl) and Bromine (Br) based flame retardants meet JS709B low halogen requirements of <=1000ppm threshold. Antimony trioxide based flame retardants must also meet the <=1000ppm threshold requirement.

(3) MSL, Peak Temp. - The Moisture Sensitivity Level rating according to the JEDEC industry standard classifications, and peak solder temperature.

(4) There may be additional marking, which relates to the logo, the lot trace code information, or the environmental category on the device.

(5) Multiple Device Markings will be inside parentheses. Only one Device Marking contained in parentheses and separated by a "~" will appear on a device. If a line is indented then it is a continuation of the previous line and the two combined represent the entire Device Marking for that device.

(6) Lead finish/Ball material - Orderable Devices may have multiple material finish options. Finish options are separated by a vertical ruled line. Lead finish/Ball material values may wrap to two lines if the finish value exceeds the maximum column width.

Important Information and Disclaimer: The information provided on this page represents TI's knowledge and belief as of the date that it is provided. TI bases its knowledge and belief on information provided by third parties, and makes no representation or warranty as to the accuracy of such information. Efforts are underway to better integrate information from third parties. TI has taken and continues to take reasonable steps to provide representative and accurate information but may not have conducted destructive testing or chemical analysis on incoming materials and chemicals. TI and TI suppliers consider certain information to be proprietary, and thus CAS numbers and other limited information may not be available for release.

In no event shall TI's liability arising out of such information exceed the total purchase price of the TI part(s) at issue in this document sold by TI to Customer on an annual basis.

TAPE AND REEL INFORMATION

QUADRANT ASSIGNMENTS FOR PIN 1 ORIENTATION IN TAPE

*All dimensions are nominal

Device	Package Type	Package Drawing	Pins	SPQ	Reel Diameter (mm)	Reel Width W1 (mm)	A0 (mm)	B0 (mm)	K0 (mm)	P1 (mm)	W (mm)	Pin1 Quadrant
TLV3604DCKR	SC70	DCK	6	3000	180.0	8.4	2.47	2.3	1.25	4.0	8.0	Q3
TLV3604DCKT	SC70	DCK	6	250	180.0	8.4	2.47	2.3	1.25	4.0	8.0	Q3
TLV3605RVKR	WQFN	RVK	12	3000	330.0	12.4	3.3	3.3	1.1	8.0	12.0	Q2
TLV3605RVKT	WQFN	RVK	12	250	180.0	12.4	3.3	3.3	1.1	8.0	12.0	Q2
TLV3607RTER	WQFN	RTE	16	5000	330.0	12.4	3.3	3.3	1.1	8.0	12.0	Q2

TAPE AND REEL BOX DIMENSIONS



*All dimensions are nominal

Device	Package Type	Package Drawing	Pins	SPQ	Length (mm)	Width (mm)	Height (mm)
TLV3604DCKR	SC70	DCK	6	3000	183.0	183.0	20.0
TLV3604DCKT	SC70	DCK	6	250	183.0	183.0	20.0
TLV3605RVKR	WQFN	RVK	12	3000	367.0	367.0	35.0
TLV3605RVKT	WQFN	RVK	12	250	210.0	185.0	35.0
TLV3607RTER	WQFN	RTE	16	5000	367.0	367.0	35.0

MECHANICAL DATA

RVK (S-PWQFN-N12)

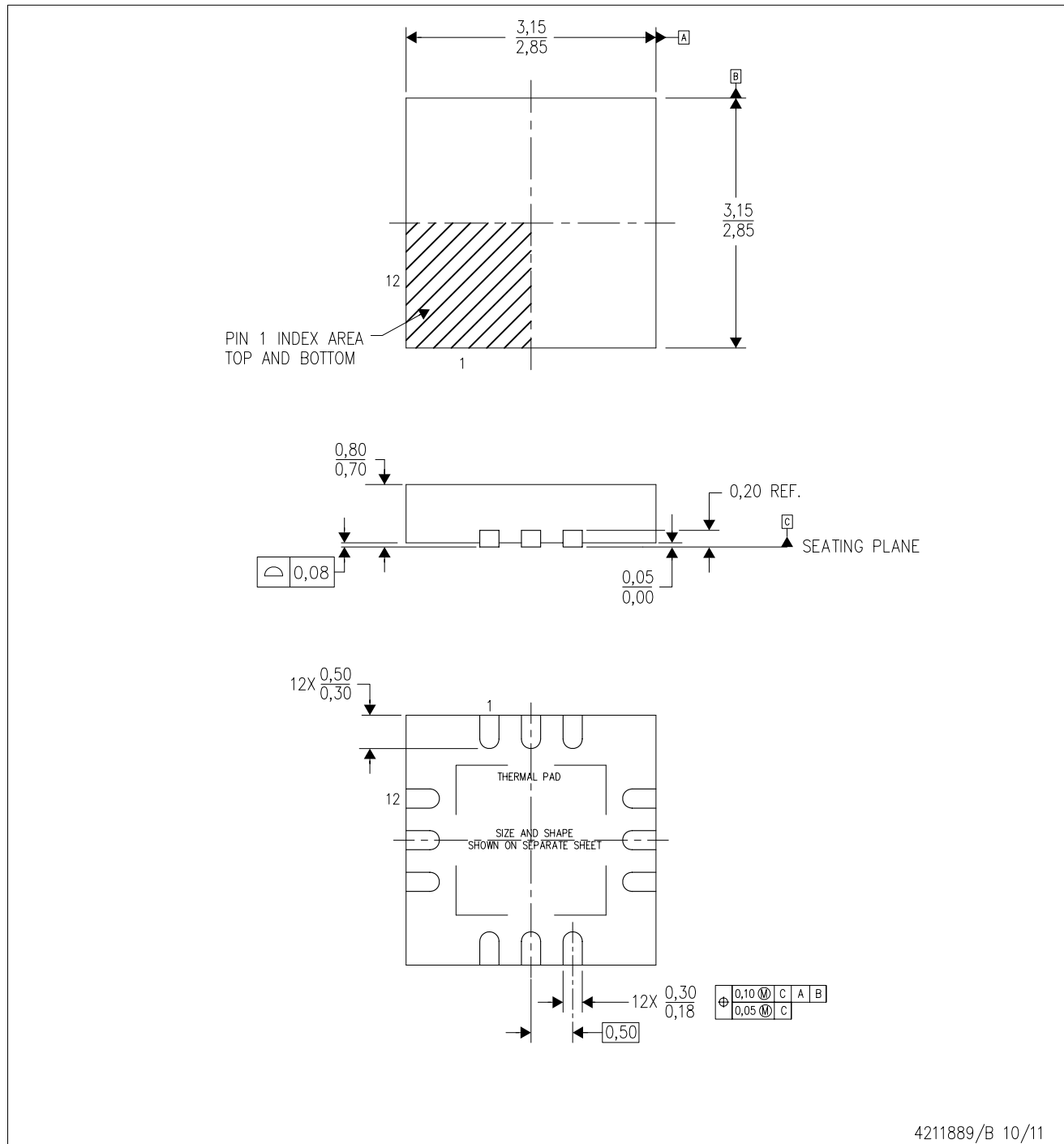
PLASTIC QUAD FLATPACK NO-LEAD



- NOTES:
- All linear dimensions are in millimeters. Dimensioning and tolerancing per ASME Y14.5M-1994.
 - This drawing is subject to change without notice.
 - Quad Flatpack, No-leads (QFN) package configuration.
 - The package thermal pad must be soldered to the board for thermal and mechanical performance.
 - See the additional figure in the Product Data Sheet for details regarding the exposed thermal pad features and dimensions.
 - Falls within JEDEC MO-220.



LAND PATTERN EXAMPLE
EXPOSED METAL SHOWN
SCALE:18X

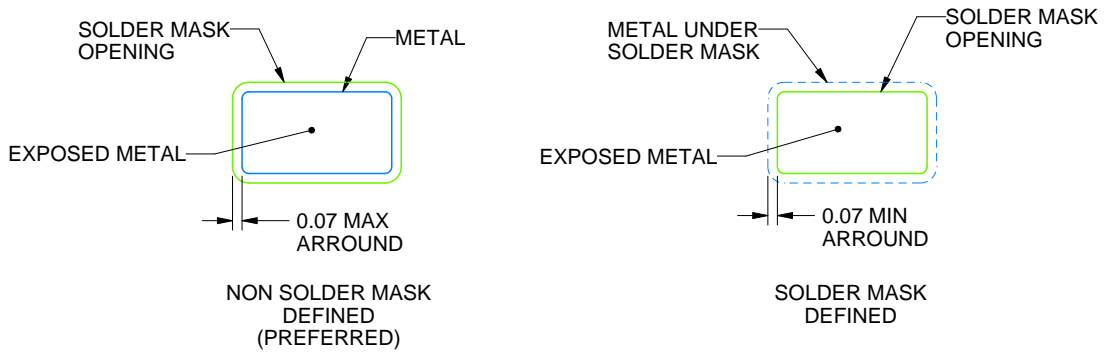

SOLDER MASK DETAILS

4214835/D 11/2024

NOTES: (continued)

- 5. Publication IPC-7351 may have alternate designs.
- 6. Solder mask tolerances between and around signal pads can vary based on board fabrication site.



SOLDER PASTE EXAMPLE
BASED ON 0.125 THICK STENCIL
SCALE:18X

4214835/D 11/2024

NOTES: (continued)

7. Laser cutting apertures with trapezoidal walls and rounded corners may offer better paste release. IPC-7525 may have alternate design recommendations.
8. Board assembly site may have different recommendations for stencil design.

GENERIC PACKAGE VIEW

RTE 16

WQFN - 0.8 mm max height

3 x 3, 0.5 mm pitch

PLASTIC QUAD FLATPACK - NO LEAD

This image is a representation of the package family, actual package may vary.
Refer to the product data sheet for package details.



4225944/A

EXAMPLE BOARD LAYOUT

RTE0016C

WQFN - 0.8 mm max height

PLASTIC QUAD FLATPACK - NO LEAD



LAND PATTERN EXAMPLE
EXPOSED METAL SHOWN
SCALE:20X



SOLDER MASK DETAILS

4219117/B 04/2022

NOTES: (continued)

- This package is designed to be soldered to a thermal pad on the board. For more information, see Texas Instruments literature number SLUA271 (www.ti.com/lit/slua271).
- Vias are optional depending on application, refer to device data sheet. If any vias are implemented, refer to their locations shown on this view. It is recommended that vias under paste be filled, plugged or tented.

EXAMPLE STENCIL DESIGN

RTE0016C

WQFN - 0.8 mm max height

PLASTIC QUAD FLATPACK - NO LEAD



SOLDER PASTE EXAMPLE
BASED ON 0.125 mm THICK STENCIL

EXPOSED PAD 17:
85% PRINTED SOLDER COVERAGE BY AREA UNDER PACKAGE
SCALE:25X

4219117/B 04/2022

NOTES: (continued)

6. Laser cutting apertures with trapezoidal walls and rounded corners may offer better paste release. IPC-7525 may have alternate design recommendations.

重要通知和免责声明

TI“按原样”提供技术和可靠性数据（包括数据表）、设计资源（包括参考设计）、应用或其他设计建议、网络工具、安全信息和其他资源，不保证没有瑕疵且不做任何明示或暗示的担保，包括但不限于对适销性、某特定用途方面的适用性或不侵犯任何第三方知识产权的暗示担保。

这些资源可供使用 TI 产品进行设计的熟练开发人员使用。您将自行承担以下全部责任：(1) 针对您的应用选择合适的 TI 产品，(2) 设计、验证并测试您的应用，(3) 确保您的应用满足相应标准以及任何其他功能安全、信息安全、监管或其他要求。

这些资源如有变更，恕不另行通知。TI 授权您仅可将这些资源用于研发本资源所述的 TI 产品的相关应用。严禁以其他方式对这些资源进行复制或展示。您无权使用任何其他 TI 知识产权或任何第三方知识产权。您应全额赔偿因在这些资源的使用中对 TI 及其代表造成的任何索赔、损害、成本、损失和债务，TI 对此概不负责。

TI 提供的产品受 [TI 的销售条款](#) 或 [ti.com](#) 上其他适用条款/TI 产品随附的其他适用条款的约束。TI 提供这些资源并不会扩展或以其他方式更改 TI 针对 TI 产品发布的适用的担保或担保免责声明。

TI 反对并拒绝您可能提出的任何其他或不同的条款。

邮寄地址：Texas Instruments, Post Office Box 655303, Dallas, Texas 75265
版权所有 © 2025，德州仪器 (TI) 公司