

## TLV7081 纳瓦级功率 4 凸点 WCSP 小尺寸比较器

### 1 特性

- 宽电源电压范围：1.7V 至 5.5V
- 370nA 静态电源电流
- 4 $\mu$ s 低传播延迟
- 漏极开路输出
- 独立输入电压范围最高可达 5.6V
- 内部磁滞：10mV
- 温度范围：-40°C 至 +125°C
- 封装：
  - 0.7mm x 0.7mm WCSP (4)

### 2 应用

- 智能手机
- 笔记本电脑和平板电脑
- 光学模块
- 数码相机
- 中继器和断路器
- 便携式医疗设备
- 门窗传感器
- 视频游戏控制器

### 3 说明

TLV7081 是一款单通道纳瓦级功率比较器，工作电压低至 1.7V。该比较器采用 0.7mm x 0.7mm 超小型 WCSP 封装，使 TLV7081 适用于空间关键型设计，例如智能手机和其他便携式或电池供电应用。

TLV7081 具有不依赖电源电压的广泛输入电压范围。拥有不依赖电源电压的输入范围使 TLV7081 即使在没有通电的情况下也可直接连接电源。

TLV7081 具有可上拉到  $V+$  之上的漏极开路输出级，因此适用于电平转换器和双极至单端转换器。

#### 器件信息 (1)

器件型号	封装	封装尺寸 (标称值)
TLV7081	WCSP (4)	0.7mm x 0.7mm

#### 小尺寸、低功耗比较器系列

系列	每通道的 $I_Q$	$t_{PD}$	输出类型	封装
TLV7081	370nA	4 $\mu$ s	漏极开路	WCSP
TLV7031	335nA	3 $\mu$ s	推挽	X2SON
TLV7041	335nA	3 $\mu$ s	漏极开路	X2SON
TLV7011	5 $\mu$ A	260ns	推挽	X2SON
TLV7021	5 $\mu$ A	260ns	漏极开路	X2SON

(1) 如需了解所有可用封装，请参阅产品说明书末尾的封装选项附录。

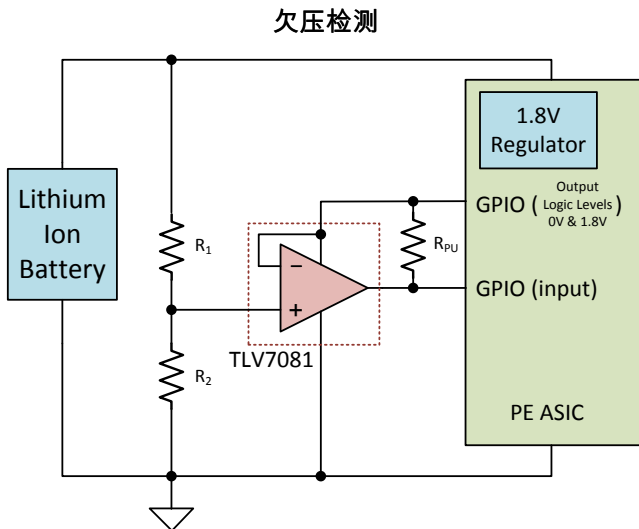

#### $I_S$ 与 电源电压间的关系

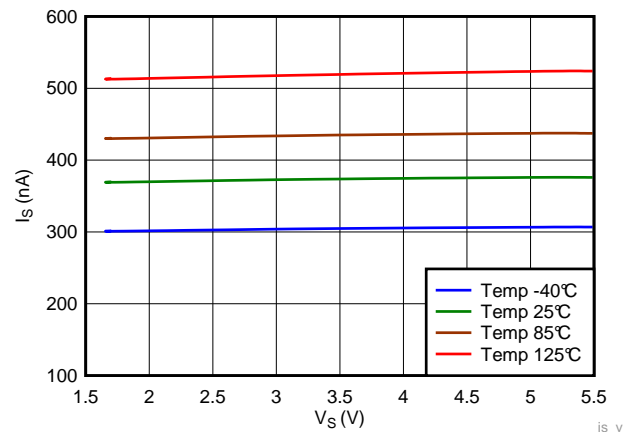

## 目录

<b>1 特性</b> .....	<b>1</b>	7.3 Feature Description .....	10
<b>2 应用</b> .....	<b>1</b>	7.4 Device Functional Modes .....	10
<b>3 说明</b> .....	<b>1</b>	<b>8 Application and Implementation</b> .....	<b>12</b>
<b>4 修订历史记录</b> .....	<b>2</b>	8.1 Application Information .....	12
<b>5 Pin Configuration and Functions</b> .....	<b>3</b>	8.2 Typical Applications .....	12
<b>6 Specifications</b> .....	<b>4</b>	<b>9 Layout</b> .....	<b>14</b>
6.1 Absolute Maximum Ratings .....	4	9.1 Layout Guidelines .....	14
6.2 ESD Ratings .....	4	9.2 Layout Example .....	14
6.3 Recommended Operating Conditions .....	4	<b>10 器件和文档支持</b> .....	<b>15</b>
6.4 Thermal Information .....	4	10.1 文档支持 .....	15
6.5 Electrical Characteristics .....	5	10.2 接收文档更新通知 .....	15
6.6 Switching Characteristics .....	5	10.3 社区资源 .....	15
6.7 Timing Diagrams .....	6	10.4 Trademarks .....	15
6.8 Typical Characteristics .....	7	10.5 Electrostatic Discharge Caution .....	15
<b>7 Detailed Description</b> .....	<b>10</b>	10.6 术语表 .....	15
7.1 Overview .....	10	<b>11 机械、封装和可订购信息</b> .....	<b>15</b>
7.2 Functional Block Diagram .....	10		

## 4 修订历史记录

### Changes from Original (December 2017) to Revision A

**Page**

• 已更改 将“预告信息”更改成了“生产数据” .....	<b>1</b>
• Added note to the <i>Timing Diagrams</i> section .....	<b>6</b>

## 5 Pin Configuration and Functions

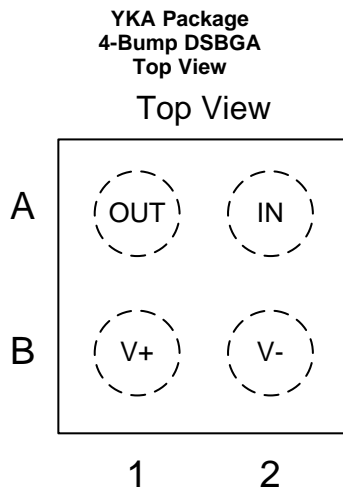

**Pin Functions**

PIN		I/O	DESCRIPTION
NAME	Number		
OUT	A1	O	Comparator output: OUT is open-drain.
V+	B1	P	Positive (highest) power supply; functions as an external reference voltage
V-	B2	P	Negative (lowest) power supply
IN	A2	I	Comparator input: IN is the noninverting input

## 6 Specifications

### 6.1 Absolute Maximum Ratings

over operating free-air temperature range (unless otherwise noted)<sup>(1)</sup>

	MIN	MAX	UNIT
Supply voltage $V_S = (V+) - (V-)$	- 0.3	6	V
Input (IN) to (V-) <sup>(2)</sup>	- 0.3	6	V
Current into input (IN)		±10	mA
Output (OUT) to (V-)	- 0.3	6	V
Output short-circuit duration <sup>(3)</sup>		10	s
Junction temperature, $T_J$		150	°C
Storage temperature, $T_{stg}$	- 65	150	°C

- (1) Stresses beyond those listed under *Absolute Maximum Ratings* may cause permanent damage to the device. These are stress ratings only, which do not imply functional operation of the device at these or any other conditions beyond those indicated under *Recommended Operating Conditions*. Exposure to absolute-maximum-rated conditions for extended periods may affect device reliability.
- (2) Input signals that can swing more than 0.3 V below (V-) must be current-limited to 10 mA or less.
- (3) Short-circuit to ground, one comparator per package.

### 6.2 ESD Ratings

		VALUE	UNIT
$V_{(ESD)}$	Electrostatic discharge	Human-body model (HBM), per ANSI/ESDA/JEDEC JS-001 <sup>(1)</sup>	±1500
		Charged-device model (CDM), per JEDEC specification JESD22-C101 <sup>(2)</sup>	±500

- (1) JEDEC document JEP155 states that 500-V HBM allows safe manufacturing with a standard ESD control process.
- (2) JEDEC document JEP157 states that 250-V CDM allows safe manufacturing with a standard ESD control process.

### 6.3 Recommended Operating Conditions

over operating free-air temperature range (unless otherwise noted)

	MIN	MAX	UNIT
Supply voltage $V_S = (V+) - (V-)$	1.7	5.5	V
Open-Drain PULL-UP voltage $V_{PULL-UP}$		5.5	V
Ambient temperature, $T_A$	-40	125	°C

### 6.4 Thermal Information

THERMAL METRIC <sup>(1)</sup>		TLV7081	UNIT
		YKA (DSBGA)	
		4 PINS	
$R_{\theta JA}$	Junction-to-ambient thermal resistance	207	°C/W
$R_{\theta JC(top)}$	Junction-to-case (top) thermal resistance	1.8	°C/W
$R_{\theta JB}$	Junction-to-board thermal resistance	73.2	°C/W
$\Psi_{JT}$	Junction-to-top characterization parameter	1	°C/W
$\Psi_{JB}$	Junction-to-board characterization parameter	73.3	°C/W

- (1) For more information about traditional and new thermal metrics, see the [Semiconductor and IC Package Thermal Metrics](#) application report.

## 6.5 Electrical Characteristics

Over the operating temperature range of  $T_A = -40^\circ\text{C}$  to  $+125^\circ\text{C}$ ,  $V_S = 3.3\text{ V}$ , and  $V_{\text{PULL-UP}} = V+$  (unless otherwise noted). Typical values are at  $T_A = 25^\circ\text{C}$ . Voltage at input pin (IN) is referenced to (V-).

PARAMETER	TEST CONDITIONS	MIN	TYP	MAX	UNIT
$V_{\text{IO}}$ Input Offset Voltage	$V_S = 1.8\text{ V}$ and $3.3\text{ V}$ , $T_A = -40^\circ\text{C}$ to $+125^\circ\text{C}$	-10	$\pm 1$	10	mV
$dV_{\text{IO}}/dT$ Input Offset Voltage Drift	$T_A = -40^\circ\text{C}$ to $+125^\circ\text{C}$		$\pm 3$		$\mu\text{V}/^\circ\text{C}$
$V_{\text{HYS}}$ Input Hysteresis Voltage			10		mV
$V_{\text{IN}}$ Input Voltage Range <sup>(1)</sup>		0		5.6	V
$I_{\text{BIAS}}$ Input bias current	IN = 5.6 V, positive value means current entering pin (IN)		3		$\mu\text{A}$
$I_{\text{LEAK}}$ Input leakage current	IN = 5.6 V, $V_S = 0\text{ V}$ , positive value means current entering pin (IN)		4		$\mu\text{A}$
$C_{\text{I}}$ Input Capacitance			1.9		pF
$V_{\text{OL}}$ Low-Level Output Voltage	Sinking 200 $\mu\text{A}$ , measured relative to (V-)			0.1	V
	Sinking 2 mA, measured relative to (V-)			0.4	V
$I_{\text{O-SC}}$ Short-circuit sink current	$V_S = 5\text{ V}$		45		mA
$I_{\text{O-LKG}}$ Output Leakage Current	IN = (V+) + 0.1V (output high), $V_{\text{PULL-UP}} = (V+)$		130		$\mu\text{A}$
PSRR Power Supply Rejection Ratio	$V_S = 1.8\text{ V}$ to $5\text{ V}$		75		dB
$I_{\text{S}}$ Supply Current	no load, IN = (V+) – 0.1V (output low), $T_A = 25^\circ\text{C}$		370	470	$\mu\text{A}$
	no load, IN = (V+) – 0.1V (output low), $T_A = -40^\circ\text{C}$ to $+125^\circ\text{C}$			630	

(1) Over Operating Supply Voltage Range ( $V_S$ ): 1.7 V to 5.5 V

## 6.6 Switching Characteristics

Typical values are at  $T_A = 25^\circ\text{C}$ ,  $V_S = 3.3\text{ V}$ ;  $C_L = 15\text{ pF}$ , (unless otherwise noted)

PARAMETER	TEST CONDITIONS	MIN	TYP	MAX	UNIT
$t_{\text{PHL}}$ High-to-low propagation delay <sup>(1)</sup>	Input overdrive = -100 mV		4		$\mu\text{s}$
$t_{\text{PLH}}$ Low-to-high propagation delay <sup>(1)</sup>	Input overdrive = +100 mV, $R_{\text{PULL-UP}} = 4.99\text{ k}\Omega$		4		$\mu\text{s}$
$t_{\text{F}}$ Output fall time	Measured from 20% to 80%		7		ns
$t_{\text{ON}}$ Start-up delay <sup>(2)</sup>			1		ms

(1) High-to-low and low-to-high refers to the transition at the input pin (IN).

(2) During power on,  $V_S$  must exceed 1.7 V for 1 ms before the output is in a correct state.

**6.7 Timing Diagrams**

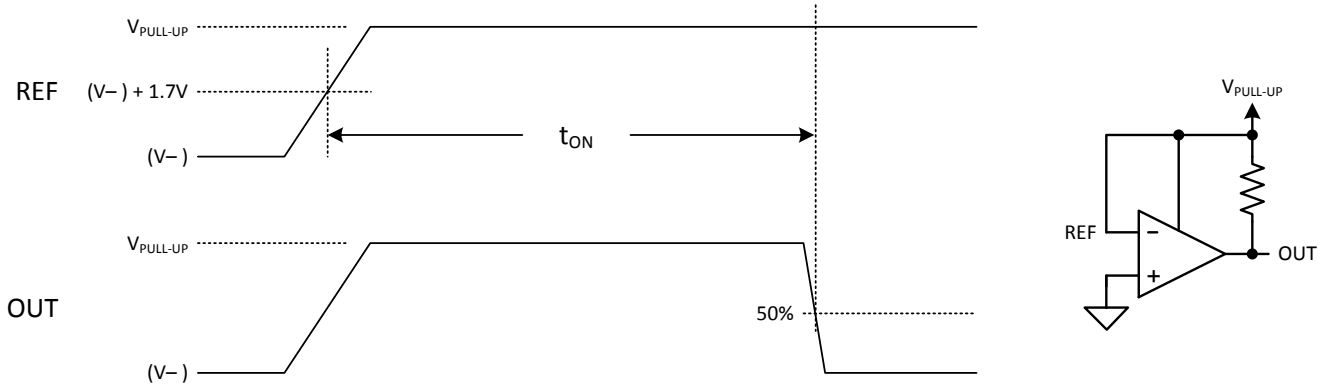

**Figure 1. Start-up Delay**

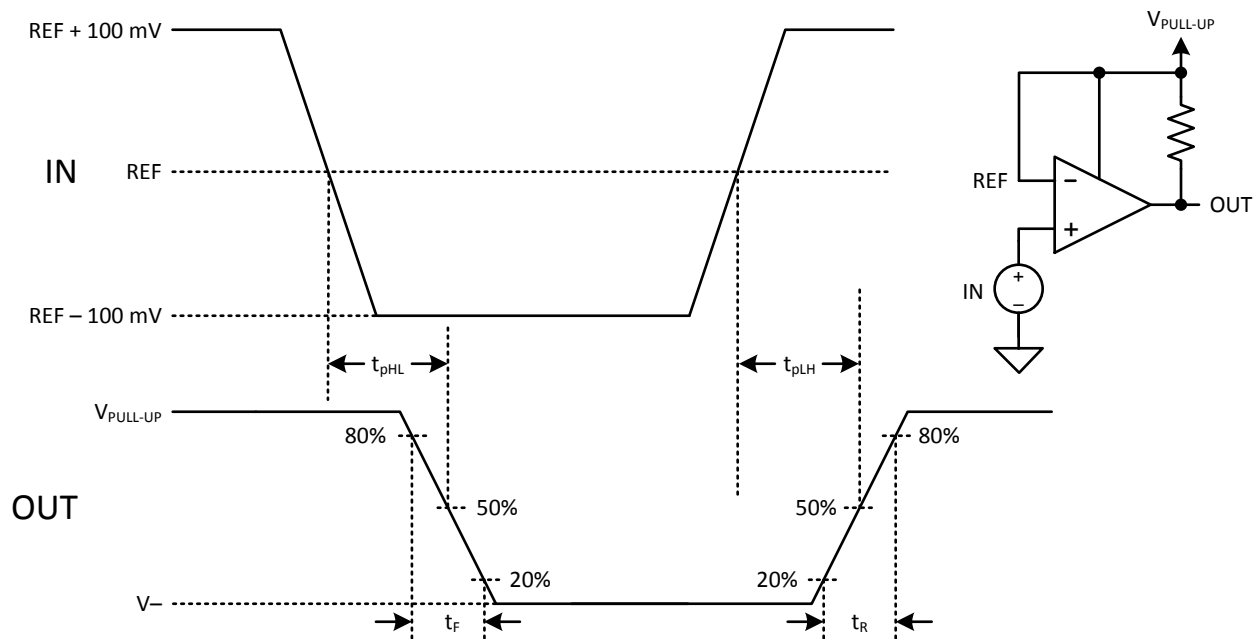

**Figure 2. Timing Diagram**

**NOTE**

The propagation delays t<sub>pLH</sub> and t<sub>pHL</sub> include the contribution of input offset and hysteresis.

### 6.8 Typical Characteristics

$T_A = 25^\circ\text{C}$ ,  $V_S = 3.3\text{ V}$ ,  $R_{\text{PULL-UP}} = 4.99\text{ k}\Omega$ ,  $C_L = 15\text{ pF}$

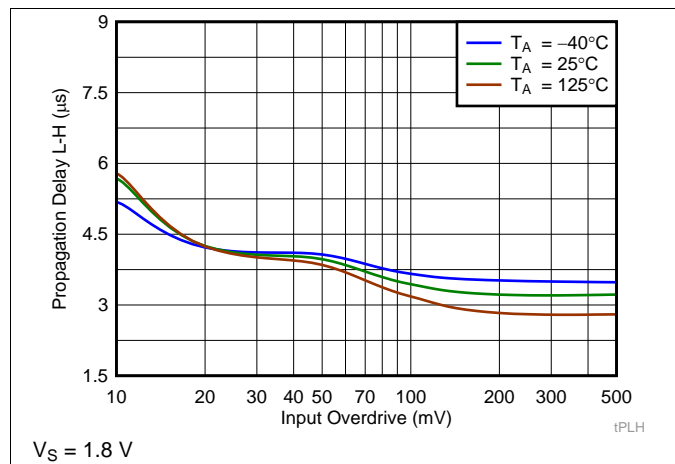

Figure 3. Propagation Delay (L-H) vs. Input Overdrive

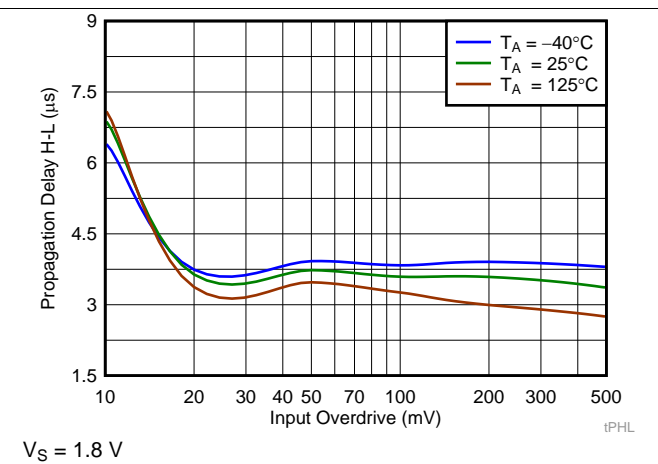

Figure 4. Propagation Delay (H-L) vs. Input Overdrive

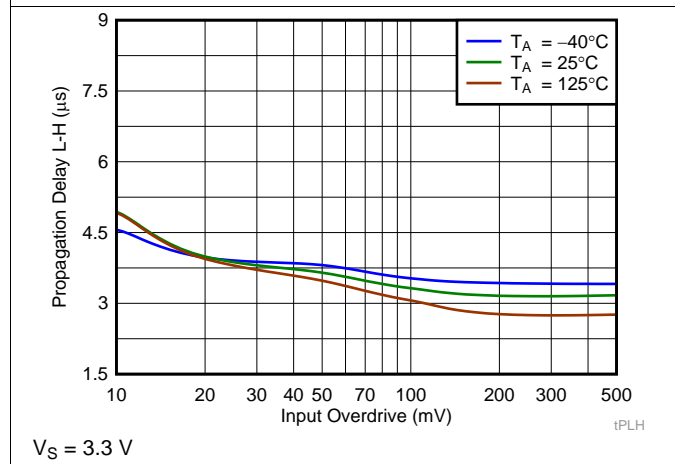

Figure 5. Propagation Delay (L-H) vs. Input Overdrive

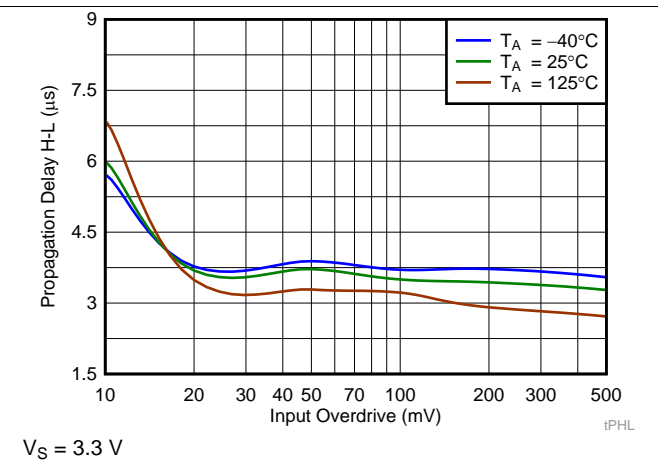

Figure 6. Propagation Delay (H-L) vs. Input Overdrive

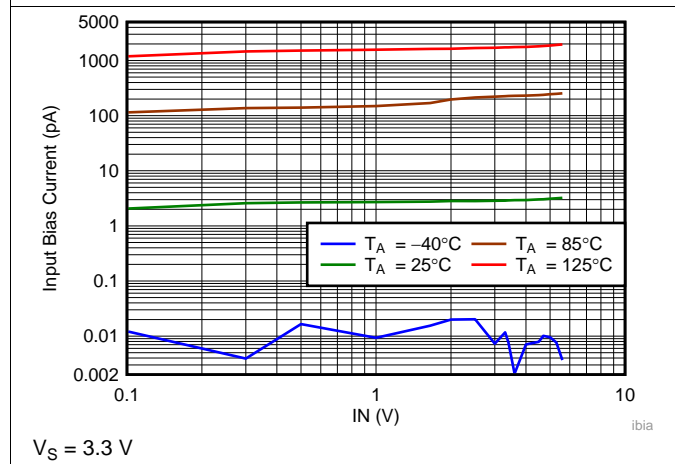

Figure 7. Input Bias Current vs.  $I_N$

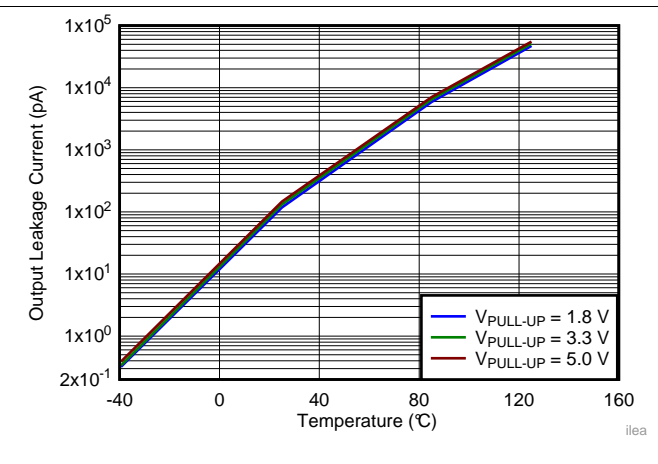

Figure 8. Output Leakage Current vs. Temperature

Typical Characteristics (continued)

$T_A = 25^\circ\text{C}$ ,  $V_S = 3.3\text{ V}$ ,  $R_{\text{PULL-UP}} = 4.99\text{ k}\Omega$ ,  $C_L = 15\text{ pF}$

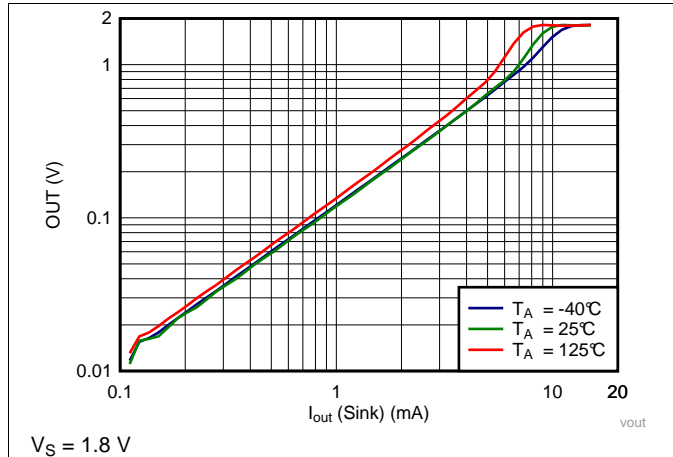

Figure 9. Output Voltage Low vs. Output Sink Current

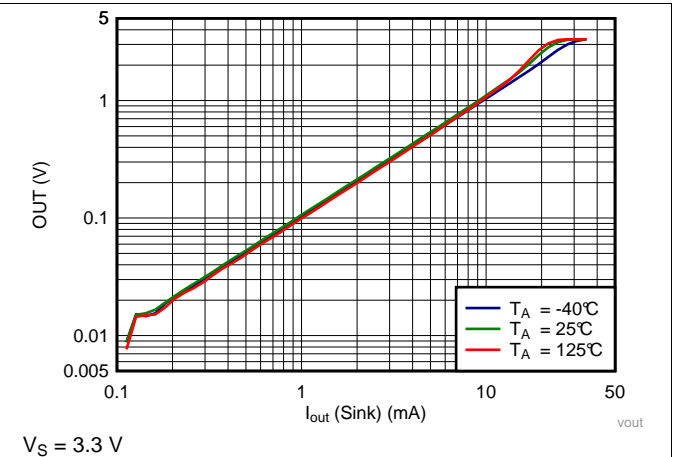

Figure 10. Output Voltage Low vs. Output Sink Current

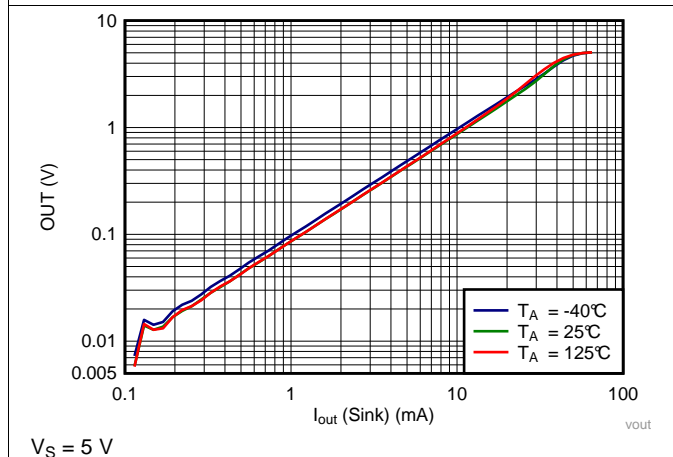

Figure 11. Output Voltage Low vs. Output Sink Current

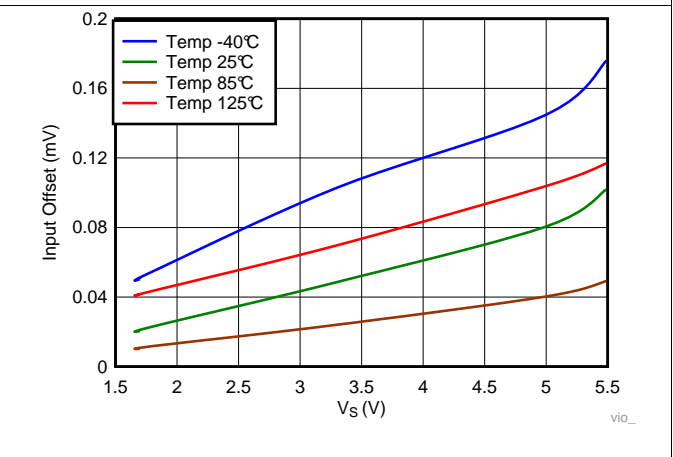

Figure 12. Input Offset vs.  $V_S$

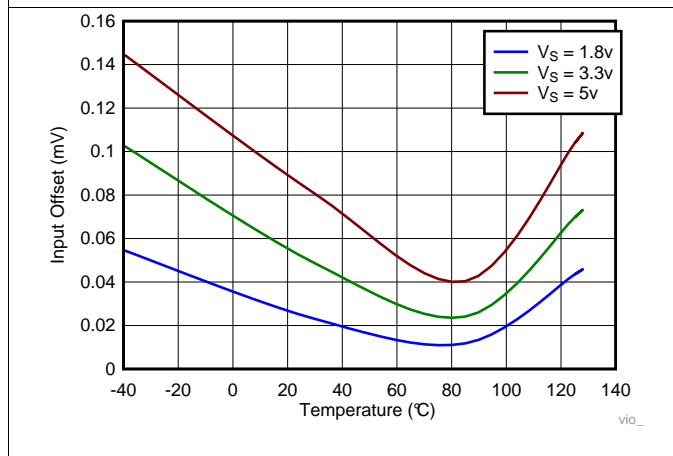

Figure 13. Input Offset vs. Temperature

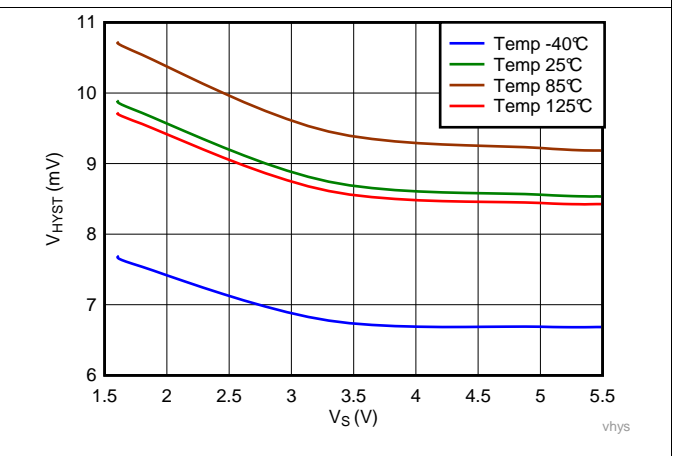
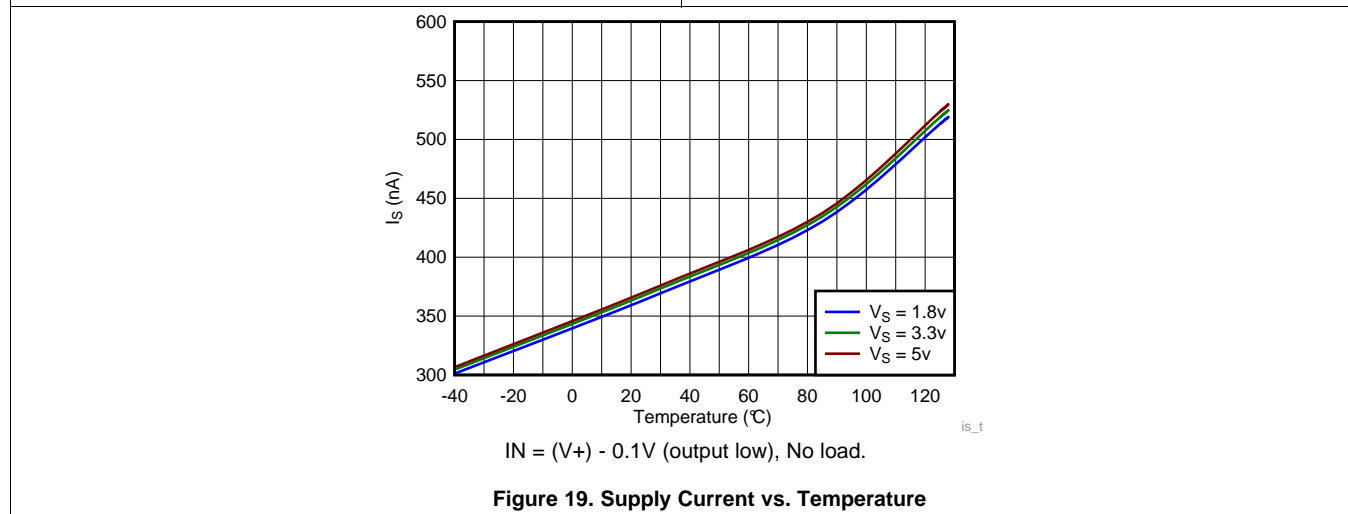
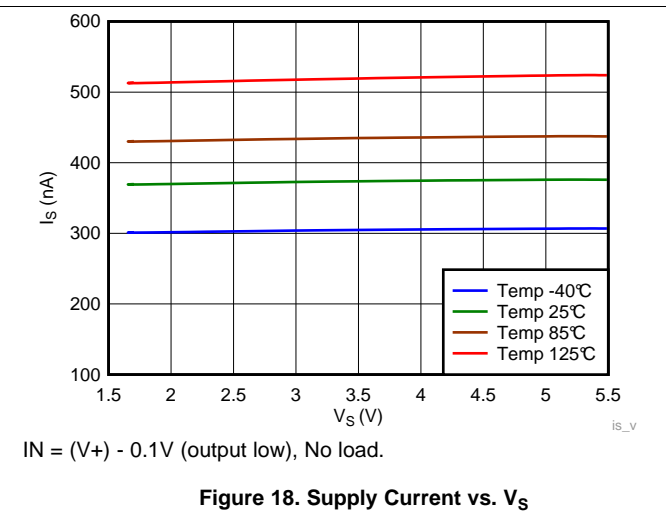
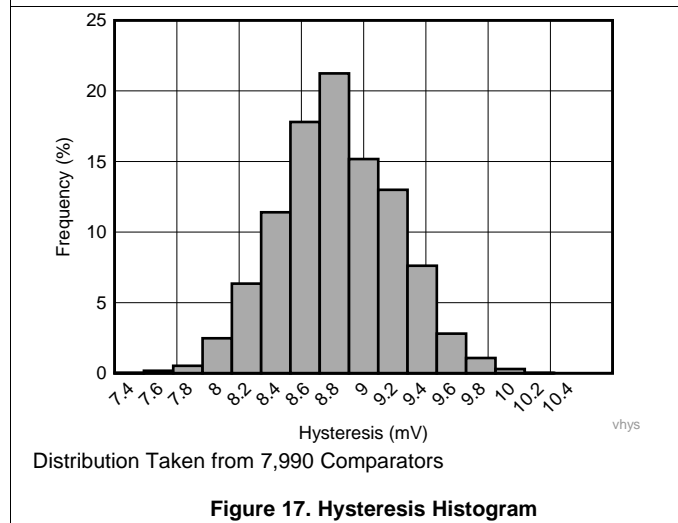
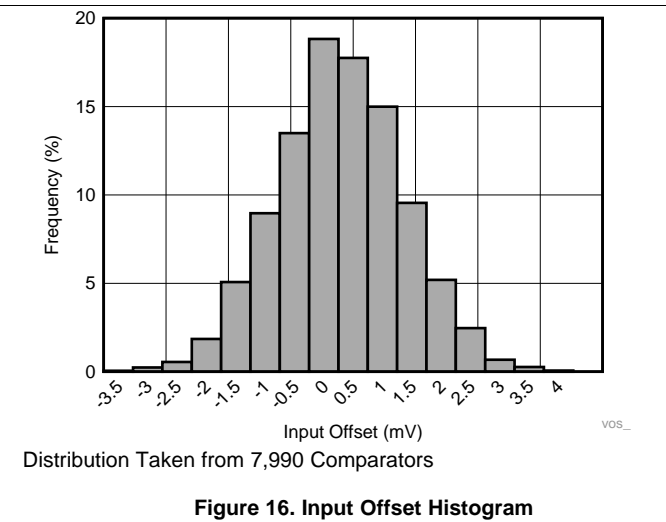
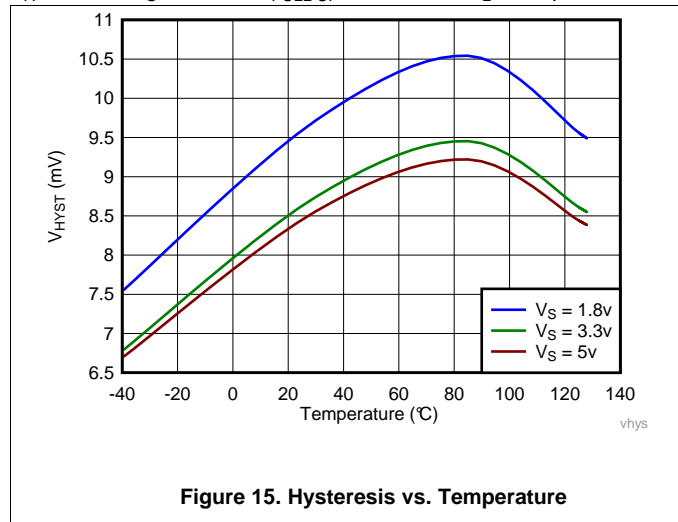

Figure 14. Hysteresis vs  $V_S$



Typical Characteristics (continued)

$T_A = 25^\circ\text{C}$ ,  $V_S = 3.3\text{ V}$ ,  $R_{\text{PULL-UP}} = 4.99\text{ k}\Omega$ ,  $C_L = 15\text{ pF}$



## 7 Detailed Description

### 7.1 Overview

The TLV7081 is a single-channel, nano-power comparator that does not need a dedicated power supply connection, and can operate down to 1.7 V. The comparator is available in an ultra-small, WCSP package measuring 0.7 mm × 0.7 mm, making the TLV7081 applicable for space-critical designs like smartphones and other portable or battery-powered applications.

The TLV7081 features a wide input-voltage range that is independent of supply voltage. Having an input range that is independent of supply voltage allows the TLV7081 to be directly connected to sources that are active even if the TLV7081 is not powered.

The TLV7081 has an open-drain output stage that can be pulled beyond  $V_+$ , making it appropriate for level translators and bipolar to single-ended converters.

### 7.2 Functional Block Diagram

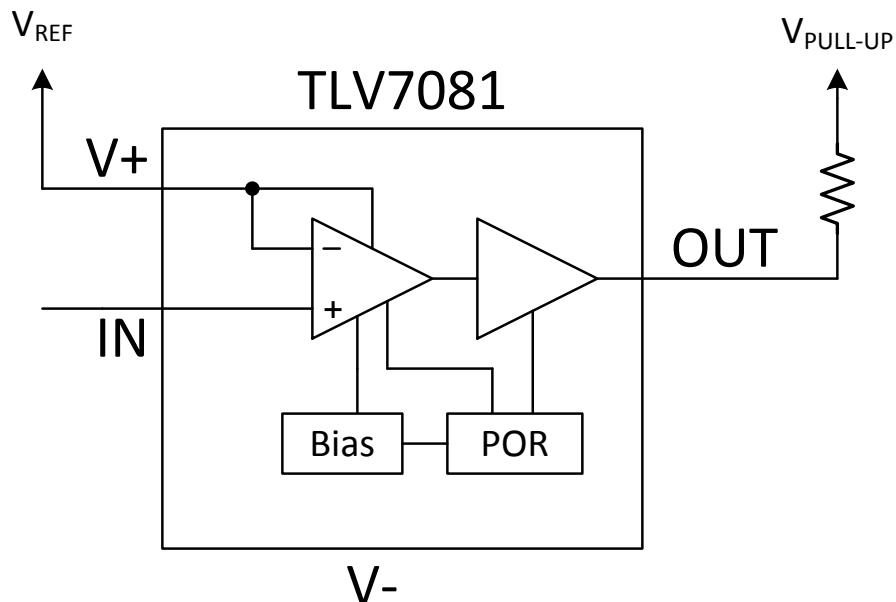

### 7.3 Feature Description

The TLV7081 is a single-channel, nano-power comparator that operates down to 1.7 V. The inverting input is internally tied to  $V_+$  which helps to streamline applications which use supply as the reference. The non-inverting input IN extends to 5.6 V which is independent of the power supply  $V_+$  (1.7 V - 5.5 V) and it's available in an ultra-small, WCSP package measuring 0.7 mm × 0.7 mm.

### 7.4 Device Functional Modes

The TLV7081 has a power-on-reset (POR) circuit. While the power supply ( $V_S$ ) is greater than  $V_{POR}$  (typically 1V) and less than the minimum operating supply voltage, either upon ramp-up or ramp-down, the POR circuitry is activated.

The POR circuit keeps the output high impedance (logical high) while activated.

When the supply voltage is greater than, or equal to, the minimum supply voltage, the comparator output reflects the state of the input IN.

## Device Functional Modes (continued)

### 7.4.1 Inputs

The TLV7081 input extends from  $V_-$  to 5.6 V which is independent of supply. The input IN can be any voltage within these limits and no phase inversion of the comparator output occurs.

The input of TLV7081 is fault tolerant. It maintains the same high input impedance when  $V_+$  is unpowered or ramping up. The input can be safely driven up to the specified maximum voltage (5.6 V) with  $V_+ = 0$  V or any value up to the maximum specified.

The input bias current is typically 3 pA for input IN voltages between 0 and 5.6 V. The comparator inputs are protected from undervoltage by internal diodes connected to  $V_-$ . As the input voltage goes under  $V_-$ , the protection diodes become forward biased and begin to conduct causing the input bias current to increase exponentially. Input bias current typically doubles for every 10°C temperature increase.

### 7.4.2 Internal Hysteresis

The device hysteresis transfer curve is shown in Figure 20. This curve is a function of three components:  $V_{TH}$ ,  $V_{OS}$ , and  $V_{HYST}$ :

- $V_{TH}$  is the actual set voltage or threshold trip voltage.
- $V_{OS}$  is the internal offset voltage between IN and  $V_+$ . This voltage is added to  $V_{TH}$  to form the actual trip point at which the comparator must respond to change output states.
- $V_{HYST}$  is the internal hysteresis (or trip window) that is designed to reduce comparator sensitivity to noise (10 mV typical).

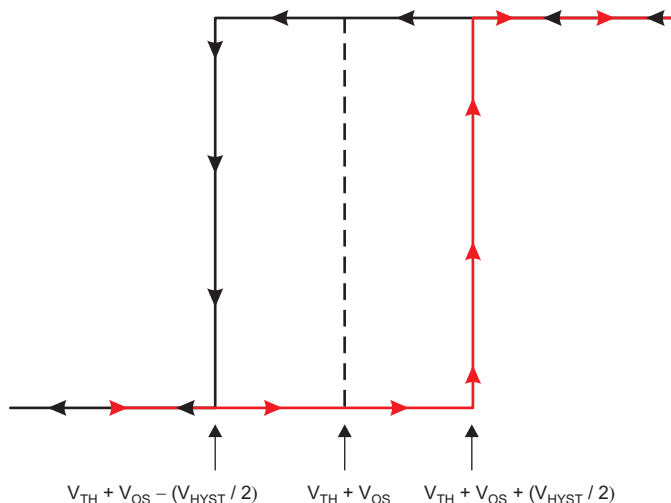

Figure 20. Hysteresis Transfer Curve

### 7.4.3 Output

The TLV7081 features an open-drain output stage enabling the output logic levels to be pulled up to an external source up to 5.5 V independently of the supply voltage.

## 8 Application and Implementation

### NOTE

Information in the following applications sections is not part of the TI component specification, and TI does not warrant its accuracy or completeness. TI's customers are responsible for determining suitability of components for their purposes. Customers should validate and test their design implementation to confirm system functionality.

### 8.1 Application Information

The TLV7081 is a 4-pin, nano-power comparator with open-drain output that is well suited for monitoring battery voltages. The TLV7081's benefits include a small package footprint and a unique input stage that allows the comparator input to be driven by a voltage source even when the operating voltage for the comparator is turned-off (zero volts).

### 8.2 Typical Applications

#### 8.2.1 Nano-Power Battery Monitor

The application of the TLV7081 for an under-voltage detection circuit is shown in Figure 21.

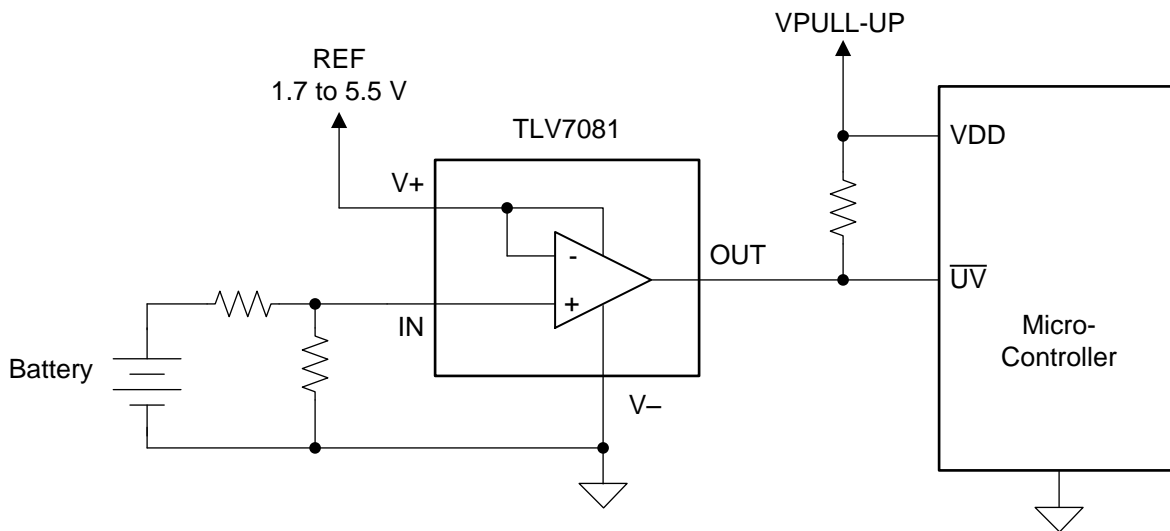

Copyright © 2017, Texas Instruments Incorporated

**Figure 21. Under-Voltage Detection**

#### 8.2.1.1 Design Requirements

For this design, follow these design requirements:

- The supply voltage connected to pin (V+) serves as the reference voltage for the comparator and can be any voltage between 1.7 V and 5.5 V.
- The voltage applied to the input pin (IN) can be any voltage in the range of 0 V to 5.6 V. This voltage range is uniquely independent of the supply voltage applied to pin (V+).
- The comparator output pin (OUT) requires a pull-up resistor that sets the output-high logic level ( $V_{OH}$ ) for the comparator.  $V_{PULL-UP}$  should be connected to the supply voltage of the microcontroller which is monitoring the comparator output and serves as the level-shifting block for the logic levels in the application.

## Typical Applications (continued)

### 8.2.1.2 Detailed Design Procedure

Instead of being powered directly from the battery, the TLV7081 is powered directly from a voltage reference that exists in the system. The input to the comparator (IN) is allowed to operate above and below the reference voltage due to the unique analog front end of the TLV7081. When the battery voltage is above the reference threshold, the output of the comparator is high and when the battery drops below the threshold of the reference, the output of the comparator goes low (see Figure 22 for details). For simplicity, the integrated hysteresis of the comparator is not shown in the timing diagram. Integrated hysteresis is helpful in avoiding glitches at the comparator output when operating in noisy environments or when the input voltage changes thresholds very slowly. An open-drain output configuration allows the output logic level of the comparator to be level-shifted to match the logic level of the receiving device.

### 8.2.1.3 Application Curve

When the voltage applied to the input pin (IN) falls below the reference threshold (REF), the output pin (OUT) is pulled low to ground (V-). Moreover, when the input voltage rises above REF, the output of the comparator goes into a high impedance state and the OUT pin is pulled high by the pull-up resistor and  $V_{PULL-UP}$  supply voltage.

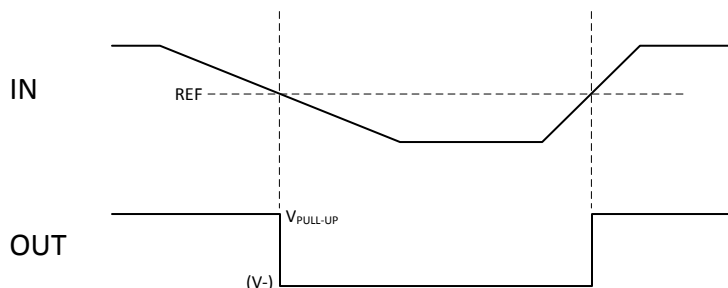

Figure 22. Under-Voltage Timing Results

## 8.2.2 Battery Monitoring in Portable Electronics

A recommended circuit diagram for monitoring a battery voltage in a personal electronic device is shown in Figure 23. In this diagram, the GPIO pin of an application specific integrated circuit (ASIC) serves as the supply voltage and the voltage reference for the TLV7081. Using a GPIO pin to power the TLV7081 is possible because of the low quiescent current of the TLV7081. In systems where power consumption needs to be further reduced, the GPIO pin can be used to power-cycle the TLV7081.

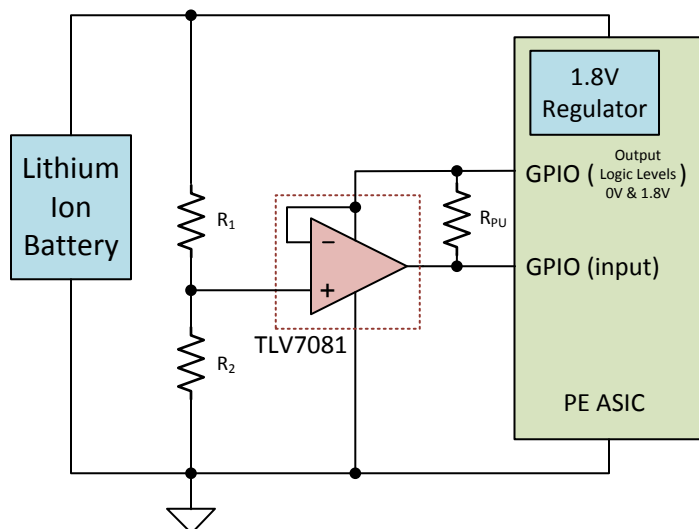

Figure 23. Battery Monitor

## 9 Layout

### 9.1 Layout Guidelines

A power supply bypass capacitor of 100 nF is recommended when supply output impedance is high, supply traces are long, or when excessive noise is expected on the supply lines. Bypass capacitors are also recommended when the comparator output drives a long trace or is required to drive a capacitive load. Due to the fast rising and falling edge rates and high-output sink and source capability of the TLV7081 output stages, higher than normal quiescent current can be drawn from the power supply. Under this circumstance, the system would benefit from a bypass capacitor across the supply pins.

### 9.2 Layout Example

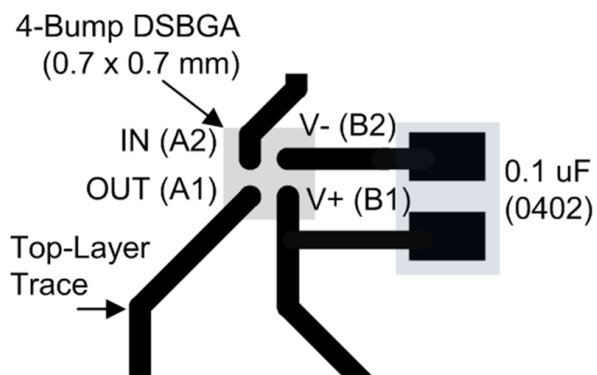

**Figure 24. Layout Example**

## 10 器件和文档支持

### 10.1 文档支持

#### 10.1.1 相关文档

请参阅如下相关文档：

- [TLV7081](#)
- [TLV7031](#)
- [TLV7041](#)
- [TLV7011](#)
- [TLV7021](#)

### 10.2 接收文档更新通知

要接收文档更新通知，请导航至 [TI.com.cn](http://TI.com.cn) 上的器件产品文件夹。单击右上角的 [通知我](#) 进行注册，即可每周接收产品信息更改摘要。有关更改的详细信息，请查看任何已修订文档中包含的修订历史记录。

### 10.3 社区资源

下列链接提供到 TI 社区资源的连接。链接的内容由各个分销商“按照原样”提供。这些内容并不构成 TI 技术规范，并且不一定反映 TI 的观点；请参阅 TI 的 [《使用条款》](#)。

**TI E2E™ 在线社区** [TI 的工程师对工程师 \(E2E\) 社区](#)。此社区的创建目的在于促进工程师之间的协作。在 [e2e.ti.com](http://e2e.ti.com) 中，您可以咨询问题、分享知识、拓展思路并与同行工程师一道帮助解决问题。

**设计支持** [TI 参考设计支持](#) 可帮助您快速查找有帮助的 E2E 论坛、设计支持工具以及技术支持的联系信息。

### 10.4 Trademarks

E2E is a trademark of Texas Instruments.  
All other trademarks are the property of their respective owners.

### 10.5 Electrostatic Discharge Caution



This integrated circuit can be damaged by ESD. Texas Instruments recommends that all integrated circuits be handled with appropriate precautions. Failure to observe proper handling and installation procedures can cause damage.

ESD damage can range from subtle performance degradation to complete device failure. Precision integrated circuits may be more susceptible to damage because very small parametric changes could cause the device not to meet its published specifications.

### 10.6 术语表

[SLYZ022](#) — *TI* 术语表。

这份术语表列出并解释术语、缩写和定义。

## 11 机械、封装和可订购信息

以下页面包含机械、封装和可订购信息。这些信息是指定器件的最新可用数据。数据如有变更，恕不另行通知，且不会对此文档进行修订。如需获取此产品说明书的浏览器版本，请查阅左侧的导航栏。

**PACKAGING INFORMATION**

Orderable Device	Status (1)	Package Type	Package Drawing	Pins	Package Qty	Eco Plan (2)	Lead finish/ Ball material (6)	MSL Peak Temp (3)	Op Temp (°C)	Device Marking (4/5)	Samples
TLV7081YKAR	ACTIVE	DSBGA	YKA	4	3000	RoHS & Green	SAC396   SNAGCU	Level-1-260C-UNLIM	-40 to 125	W	<b>Samples</b>

(1) The marketing status values are defined as follows:

**ACTIVE:** Product device recommended for new designs.

**LIFEBUY:** TI has announced that the device will be discontinued, and a lifetime-buy period is in effect.

**NRND:** Not recommended for new designs. Device is in production to support existing customers, but TI does not recommend using this part in a new design.

**PREVIEW:** Device has been announced but is not in production. Samples may or may not be available.

**OBSOLETE:** TI has discontinued the production of the device.

(2) **RoHS:** TI defines "RoHS" to mean semiconductor products that are compliant with the current EU RoHS requirements for all 10 RoHS substances, including the requirement that RoHS substance do not exceed 0.1% by weight in homogeneous materials. Where designed to be soldered at high temperatures, "RoHS" products are suitable for use in specified lead-free processes. TI may reference these types of products as "Pb-Free".

**RoHS Exempt:** TI defines "RoHS Exempt" to mean products that contain lead but are compliant with EU RoHS pursuant to a specific EU RoHS exemption.

**Green:** TI defines "Green" to mean the content of Chlorine (Cl) and Bromine (Br) based flame retardants meet JS709B low halogen requirements of <=1000ppm threshold. Antimony trioxide based flame retardants must also meet the <=1000ppm threshold requirement.

(3) MSL, Peak Temp. - The Moisture Sensitivity Level rating according to the JEDEC industry standard classifications, and peak solder temperature.

(4) There may be additional marking, which relates to the logo, the lot trace code information, or the environmental category on the device.

(5) Multiple Device Markings will be inside parentheses. Only one Device Marking contained in parentheses and separated by a "-" will appear on a device. If a line is indented then it is a continuation of the previous line and the two combined represent the entire Device Marking for that device.

(6) Lead finish/Ball material - Orderable Devices may have multiple material finish options. Finish options are separated by a vertical ruled line. Lead finish/Ball material values may wrap to two lines if the finish value exceeds the maximum column width.

**Important Information and Disclaimer:**The information provided on this page represents TI's knowledge and belief as of the date that it is provided. TI bases its knowledge and belief on information provided by third parties, and makes no representation or warranty as to the accuracy of such information. Efforts are underway to better integrate information from third parties. TI has taken and continues to take reasonable steps to provide representative and accurate information but may not have conducted destructive testing or chemical analysis on incoming materials and chemicals. TI and TI suppliers consider certain information to be proprietary, and thus CAS numbers and other limited information may not be available for release.

In no event shall TI's liability arising out of such information exceed the total purchase price of the TI part(s) at issue in this document sold by TI to Customer on an annual basis.



**TAPE AND REEL INFORMATION**

**QUADRANT ASSIGNMENTS FOR PIN 1 ORIENTATION IN TAPE**

\*All dimensions are nominal

Device	Package Type	Package Drawing	Pins	SPQ	Reel Diameter (mm)	Reel Width W1 (mm)	A0 (mm)	B0 (mm)	K0 (mm)	P1 (mm)	W (mm)	Pin1 Quadrant
TLV7081YKAR	DSBGA	YKA	4	3000	180.0	8.4	0.8	0.8	0.47	4.0	8.0	Q1
TLV7081YKAR	DSBGA	YKA	4	3000	180.0	8.4	0.8	0.8	0.47	4.0	8.0	Q1

**TAPE AND REEL BOX DIMENSIONS**

\*All dimensions are nominal

Device	Package Type	Package Drawing	Pins	SPQ	Length (mm)	Width (mm)	Height (mm)
TLV7081YKAR	DSBGA	YKA	4	3000	182.0	182.0	20.0
TLV7081YKAR	DSBGA	YKA	4	3000	182.0	182.0	20.0

YKA0004



# PACKAGE OUTLINE

## DSBGA - 0.4 mm max height

DIE SIZE BALL GRID ARRAY

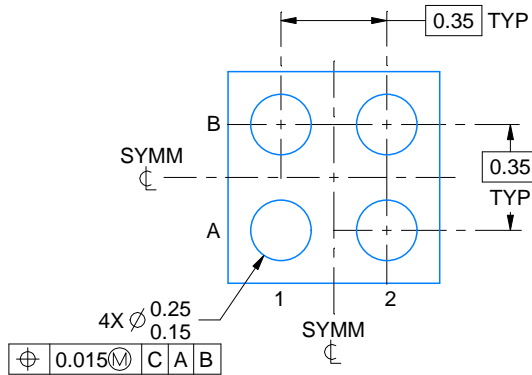
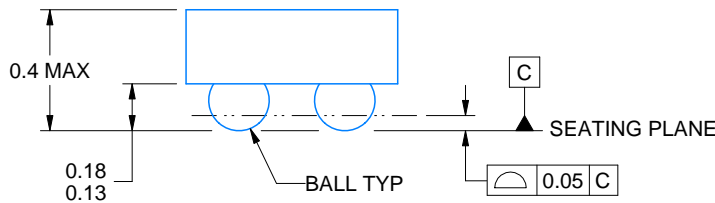
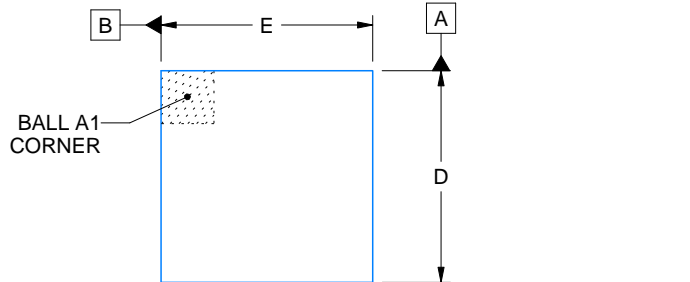

D: Max = 0.73 mm, Min = 0.67 mm
E: Max = 0.73 mm, Min = 0.67 mm

4221909/B 08/2018

NOTES:

1. All linear dimensions are in millimeters. Any dimensions in parenthesis are for reference only. Dimensioning and tolerancing per ASME Y14.5M.
2. This drawing is subject to change without notice.

# EXAMPLE BOARD LAYOUT

YKA0004

DSBGA - 0.4 mm max height

DIE SIZE BALL GRID ARRAY

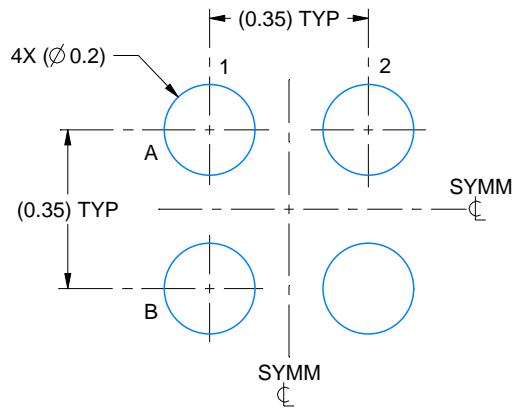

LAND PATTERN EXAMPLE  
EXPOSED METAL SHOWN  
SCALE:60X

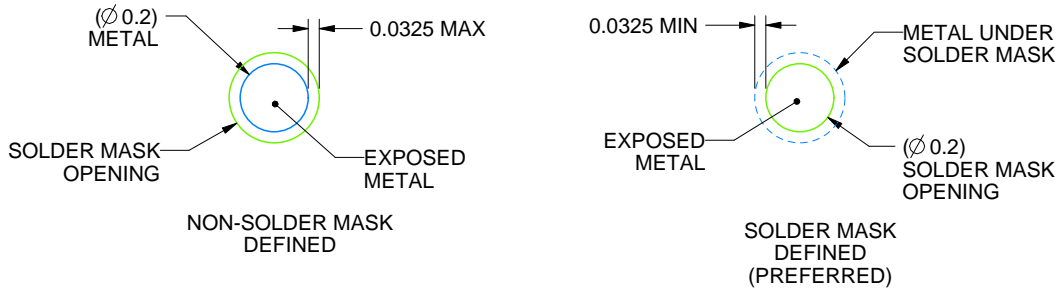

SOLDER MASK DETAILS  
NOT TO SCALE

4221909/B 08/2018

NOTES: (continued)

- Final dimensions may vary due to manufacturing tolerance considerations and also routing constraints. For more information, see Texas Instruments literature number SNVA009 ([www.ti.com/lit/snva009](http://www.ti.com/lit/snva009)).

# EXAMPLE STENCIL DESIGN

YKA0004

DSBGA - 0.4 mm max height

DIE SIZE BALL GRID ARRAY

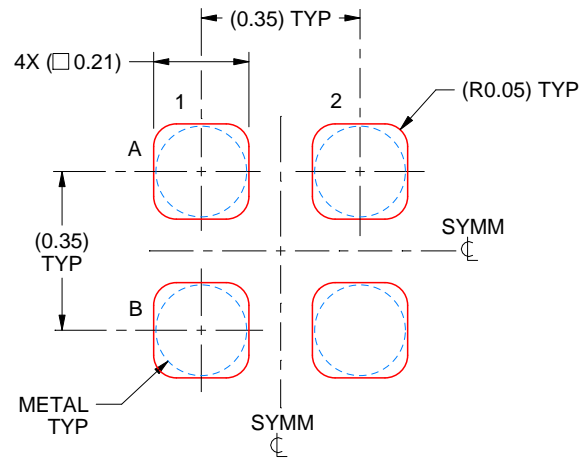

SOLDER PASTE EXAMPLE  
BASED ON 0.075 mm - 0.1 mm THICK STENCIL  
SCALE:60X

4221909/B 08/2018

NOTES: (continued)

4. Laser cutting apertures with trapezoidal walls and rounded corners may offer better paste release.

## 重要通知和免责声明

TI“按原样”提供技术和可靠性数据（包括数据表）、设计资源（包括参考设计）、应用或其他设计建议、网络工具、安全信息和其他资源，不保证没有瑕疵且不做任何明示或暗示的担保，包括但不限于对适销性、某特定用途方面的适用性或不侵犯任何第三方知识产权的暗示担保。

这些资源可供使用 TI 产品进行设计的熟练开发人员使用。您将自行承担以下全部责任：(1) 针对您的应用选择合适的 TI 产品，(2) 设计、验证并测试您的应用，(3) 确保您的应用满足相应标准以及任何其他功能安全、信息安全、监管或其他要求。

这些资源如有变更，恕不另行通知。TI 授权您仅可将这些资源用于研发本资源所述的 TI 产品的相关应用。严禁以其他方式对这些资源进行复制或展示。您无权使用任何其他 TI 知识产权或任何第三方知识产权。您应全额赔偿因在这些资源的使用中对 TI 及其代表造成的任何索赔、损害、成本、损失和债务，TI 对此概不负责。

TI 提供的产品受 [TI 的销售条款](#) 或 [ti.com](#) 上其他适用条款/TI 产品随附的其他适用条款的约束。TI 提供这些资源并不会扩展或以其他方式更改 TI 针对 TI 产品发布的适用的担保或担保免责声明。

TI 反对并拒绝您可能提出的任何其他或不同的条款。

邮寄地址：Texas Instruments, Post Office Box 655303, Dallas, Texas 75265  
版权所有 © 2025，德州仪器 (TI) 公司