

TLV713 面向便携式设备且具有折返电流限制的 无电容 150mA 低压降稳压器

1 特性

- 有无电容器均可实现稳定运行
- 折返过流保护
- 封装：
 - 1mm x 1mm 4 引脚 X2SON
 - 5 引脚 SOT-23
- 超低压降：150mA 时为 230mV
- 准确度：1%
- 低 I_Q ：50 μ A
- 输入电压范围：1.4V 至 5.5V
- 可提供固定输出电压：
1V 至 3.3V
- 高 PSRR：1kHz 时为 65dB
- 有源输出放电（仅限 P 版本）

2 应用

- 掌上电脑 (PDA) 和电池供电便携式设备
- MP3 播放器和其它手持产品
- 无线局域网 (WLAN) 及其他 PC 附加卡

3 说明

TLV713 系列低压降 (LDO) 线性稳压器具有较低的静态电流，并且线路和负载瞬态性能出色，适用于功耗敏感型应用。此类器件可提供典型值为 1% 的精度。

TLV713 系列器件经过设计，无需使用输出电容即可稳定运行。移除输出电容器可实现极小的解决方案尺寸。然而，如果使用了一个输出电容器，TLV713 系列也可与任何输出电容器实现稳定运行。

TLV713 还可在器件上电和使能期间提供浪涌电流控制。TLV713 将输入电流限制到已定义的电流限值来避免来自输入电源的大电流。这个功能对于电池供电类器件十分重要。

TLV713 系列采用标准的 DQN 和 DBV 封装。

TLV713P 提供了有源下拉电路，用于对输出负载进行快速放电。

器件信息⁽¹⁾

器件名称	封装	封装尺寸
TLV713	X2SON (4)	1.00mm x 1.00mm
	SOT-23 (5)	2.90mm x 1.60mm

(1) 如需了解所有可用封装，请参阅产品说明书末尾的可订购产品附录。

典型应用电路

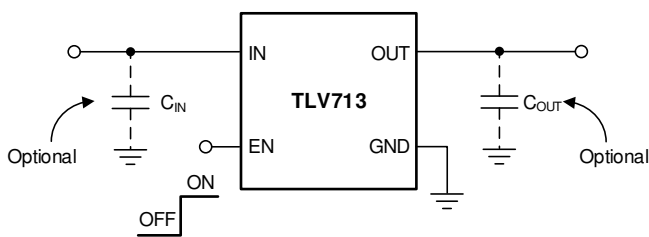

压降电压与输出电流间的关系

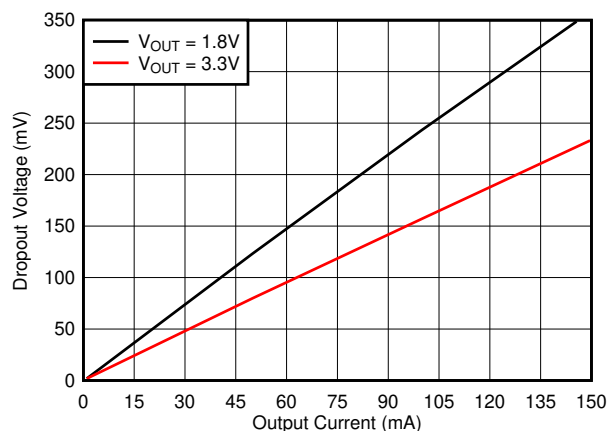

目录

1	特性	1	8	Application and Implementation	16
2	应用	1	8.1	Application Information.....	16
3	说明	1	8.2	Typical Application	17
4	修订历史记录	2	8.3	What to Do and What Not to Do	18
5	Pin Configurations and Functions	5	9	Power Supply Recommendations	18
6	Specifications	6	10	Layout	19
6.1	Absolute Maximum Ratings	6	10.1	Layout Guidelines	19
6.2	ESD Ratings.....	6	10.2	Layout Examples.....	20
6.3	Recommended Operating Conditions.....	6	11	器件和文档支持	21
6.4	Thermal Information	6	11.1	器件支持	21
6.5	Electrical Characteristics.....	7	11.2	文档支持	21
6.6	Typical Characteristics	8	11.3	接收文档更新通知	21
7	Detailed Description	12	11.4	社区资源	21
7.1	Overview	12	11.5	商标	21
7.2	Functional Block Diagrams	12	11.6	静电放电警告	22
7.3	Feature Description.....	13	11.7	Glossary	22
7.4	Device Functional Modes.....	15	12	机械、封装和可订购信息	22

4 修订历史记录

注：之前版本的页码可能与当前版本有所不同。

Changes from Revision E (March 2015) to Revision F	Page
• Added last sentence to <i>Undervoltage Lockout (UVLO)</i> section	13
• Added <i>UVLO Circuit Limitation</i> section	16

Changes from Revision D (July 2013) to Revision E	Page
• 已更改 更改了格式，以符合最新的数据表标准；添加了新的部分，并删除了现有部分.....	1
• 已更改 更改了有关器件封装选项的“特性”项目符号	1
• 已更改 首页图	1
• Changed Pin Configuration and Functions section; updated table format	5
• Changed Absolute Maximum Ratings table conditions	6
• Changed <i>Output voltage range</i> and <i>Junction temperature range</i> parameter maximum specifications in Absolute Maximum Ratings table	6
• Added <i>ESD Ratings</i> table, <i>Feature Description</i> section, <i>Device Functional Modes</i> , <i>Application and Implementation</i> section, <i>Power Supply Recommendations</i> section, <i>Layout</i> section, <i>Device and Documentation Support</i> section, and <i>Mechanical, Packaging, and Orderable Information</i> section	6
• Corrected DBV data in Thermal Information table	6
• Changed conditions of Electrical Characteristics table: changed V_{IN} to $V_{IN(nom)}$; changed T_A to T_J ; corrected operating temperature range	7
• Changed T_A to T_J and 85°C to 125°C throughout Electrical Characteristics table	7
• Added test conditions for line regulation parameter	7
• Changed V_{DO} parameter in Electrical Characteristics table: all rows changed	7
• Changed V_n parameter typical specification in Electrical Characteristics table	7
• Deleted T_J parameter from Electrical Characteristics table	7
• Added T_J condition to I_{LIM} parameter in Electrical Characteristics table for clarification	7
• Changed Typical Characteristics conditions.....	8
• Changed Figure 1 through Figure 11 in Typical Characteristics to show improved performance definition	8
• Added new Figure 3	8

• Changed Figure 4	8
• Changed Figure 5	8
• Changed Figure 9 graph and figure title.....	8
• Added new Figure 10	8
• Changed Figure 12 ; corrected notation on axis titles to show units per graph division (units/div)	8
• Changed Figure 13 ; corrected notation on axis titles to show units per graph division (units/div)	9
• Changed Figure 14 ; corrected notation on axis titles to show units per graph division (units/div)	9
• Changed Figure 15 ; corrected notation on axis titles to show units per graph division (units/div)	9
• Changed Figure 17 ; corrected notation on axis titles to show units per graph division (units/div)	9
• Changed Figure 19 ; corrected notation on axis titles to show units per graph division (units/div)	10
• Changed Figure 21 ; corrected notation on axis titles to show units per graph division (units/div)	10
• Changed Figure 22 ; corrected notation on axis titles to show units per graph division (units/div)	10
• Changed Figure 23 ; corrected notation on axis titles to show units per graph division (units/div)	10
• Changed Shutdown section: clarified description	13
• Changed Foldback Current Limit section: adjusted flow and clarified description	14
• Changed paragraph 1 of Thermal Protection	14
• Changed Table 2	17
• 已将订购信息移动至器件命名规则部分.....	21

Changes from Revision C (July 2013) to Revision D
Page

• 已更改 将文档状态从“混合状态”更改为“生产数据”	1
• 已删除 删除了文档中的 DPW 封装	1
• 已删除 删除了说明 部分最后一句中的 DPW 封装参考	1
• 已删除 首页图中的 DPW 引脚分配图	1
• 已删除 首页图中的脚注	1
• Deleted DPW pinout drawing from Pin Configurations section	5
• Deleted reference to DPW package from Pin Descriptions table.....	5
• Deleted DPW data from Thermal Information table	6
• 已删除 订购信息表的脚注 3	21

Changes from Revision B (December 2012) to Revision C
Page

• 已更改 更改了最后一个“特性”项目符号.....	1
• 已添加 典型应用电路	1
• Changed last two rows of the V_{DO} parameter in the Electrical Characteristics table	7

Changes from Revision A (October 2012) to Revision B
Page

• 已更改 首页图中的脚注.....	1
• Added DBV data to Thermal Information table.....	6
• 已更改 订购信息表的脚注 3	21

Changes from Original (September 2012) to Revision A
Page

• 重新排列了“特性”项目符号.....	1
• 已更改 更改了第四个“特性”项目符号中的压降范围.....	1
• 已更改 更改了封装 和固定输出电压“特性”项目符号.....	1

• 已添加 向说明 部分添加了第二段和第三段	1
• 已更新 DQN 引脚分配图	1
• Changed DQN pinout caption in Pin Configurations section.....	5
• Changed 1.2 V to 0.9 V in description of EN pin in Pin Descriptions table.....	5
• Changed DQN header row in Thermal Information table	6
• Changed V_{OUT} maximum specification in Electrical Characteristics table	7
• Combined all V_{DO} rows together in Electrical Characteristics table	7
• Changed V_{DO} specifications in Electrical Characteristics table	7
• Changed I_{SHDN} test conditions in Electrical Characteristics table	7
• Changed Typical Characteristics conditions.....	8
• Added curves.....	8
• Changed junction temperature range in second paragraph of <i>Overview</i> section	12
• Updated Figure 24	12
• Deleted third paragraph from <i>Thermal Information</i> section.....	14
• Changed second paragraph of <i>Input and Output Capacitor Considerations</i> section	16
• Deleted curve reference from <i>Dropout Voltage</i> section	16

5 Pin Configurations and Functions

**DQN Package
4-Pin X2SON
Top View**



**DBV Package
5-Pin SOT-23
Top View**



Pin Functions

NAME	PIN NO.		I/O	DESCRIPTION
	X2SON	SOT-23		
EN	3	3	I	Enable pin. Driving EN over 0.9 V turns on the regulator. Driving EN below 0.4 V puts the regulator into shutdown mode.
GND	2	2	—	Ground pin
IN	4	1	I	Input pin. A small capacitor is recommended from this pin to ground. See the Input and Output Capacitor Considerations section in the Feature Description for more details.
NC	—	4	—	No internal connection
OUT	1	5	O	Regulated output voltage pin. For best transient response, a small 1- μ F ceramic capacitor is recommended from this pin to ground. See the Input and Output Capacitor Considerations section in the Feature Description for more details.
Thermal pad	—	—	—	The thermal pad is electrically connected to the GND node. Connect to the GND plane for improved thermal performance.

6 Specifications

6.1 Absolute Maximum Ratings

Over operating junction temperature range ($T_J = 25^\circ\text{C}$), unless otherwise noted. All voltages are with respect to GND.⁽¹⁾

		MIN	MAX	UNIT
Voltage	Input, V_{IN}	-0.3	6	V
	Enable, V_{EN}	-0.3	$V_{IN} + 0.3$	
	Output, V_{OUT}	-0.3	3.6	
Current	Maximum output, $I_{OUT(max)}$	Internally limited		
Output short-circuit duration		Indefinite		
Total power dissipation	Continuous, $P_{D(tot)}$	See Thermal Information		
Temperature	Storage, T_{stg}	-55	150	$^\circ\text{C}$
	Junction, T_J	-55	125	$^\circ\text{C}$

- (1) Stresses beyond those listed under *Absolute Maximum Ratings* may cause permanent damage to the device. These are stress ratings only, which do not imply functional operation of the device at these or any other conditions beyond those indicated under *Recommended Operating Conditions*. Exposure to absolute-maximum-rated conditions for extended periods may affect device reliability.

6.2 ESD Ratings

			VALUE	UNIT
$V_{(ESD)}$	Electrostatic discharge	Human body model (HBM), per ANSI/ESDA/JEDEC JS-001, all pins ⁽¹⁾	± 2000	V
		Charged device model (CDM), per JEDEC specification JESD22-C101, all pins ⁽²⁾	± 500	

- (1) JEDEC document JEP155 states that 500-V HBM allows safe manufacturing with a standard ESD control process.
 (2) JEDEC document JEP157 states that 250-V CDM allows safe manufacturing with a standard ESD control process.

6.3 Recommended Operating Conditions

over operating junction temperature range (unless otherwise noted).

		MIN	NOM	MAX	UNIT
V_{IN}	Input voltage	1.4		5.5	V
V_{EN}	Enable range	0		V_{IN}	V
I_{OUT}	Output current	0		150	mA
C_{IN}	Input capacitor	0	1		μF
C_{OUT}	Output capacitor	0	0.1	100	μF
T_J	Operating junction temperature range	-40		125	$^\circ\text{C}$

6.4 Thermal Information

THERMAL METRIC ⁽¹⁾		TLV713, TLV713P		UNIT
		DQN (X2SON)	DBV (SOT23)	
		4 PINS	5 PINS	
$R_{\theta JA}$	Junction-to-ambient thermal resistance	255.8	249	$^\circ\text{C}/\text{W}$
$R_{\theta JC(top)}$	Junction-to-case (top) thermal resistance	159.3	172.7	$^\circ\text{C}/\text{W}$
$R_{\theta JB}$	Junction-to-board thermal resistance	208.2	76.7	$^\circ\text{C}/\text{W}$
ψ_{JT}	Junction-to-top characterization parameter	16.2	49.7	$^\circ\text{C}/\text{W}$
ψ_{JB}	Junction-to-board characterization parameter	208.1	75.8	$^\circ\text{C}/\text{W}$
$R_{\theta JC(bot)}$	Junction-to-case (bottom) thermal resistance	148.6	n/a	$^\circ\text{C}/\text{W}$

- (1) For more information about traditional and new thermal metrics, see the [Semiconductor and IC Package Thermal Metrics application report](#).

6.5 Electrical Characteristics

Over operating temperature range ($T_J = -40^\circ\text{C}$ to 125°C), $V_{IN(nom)} = V_{OUT(nom)} + 0.5\text{ V}$ or $V_{IN(nom)} = 2\text{ V}$ (whichever is greater), $I_{OUT} = 1\text{ mA}$, $V_{EN} = V_{IN}$, and $C_{OUT} = 0.47\text{ }\mu\text{F}$, unless otherwise noted. Typical values are at $T_J = 25^\circ\text{C}$.

PARAMETER		TEST CONDITIONS		MIN	TYP	MAX	UNIT
V_{IN}	Input voltage range			1.4		5.5	V
V_{OUT}	Output voltage range			1		3.3	V
	DC output accuracy	$V_{OUT} \geq 1.8\text{ V}$, $T_J = 25^\circ\text{C}$		-1%		1%	
		$V_{OUT} < 1.8\text{ V}$, $T_J = 25^\circ\text{C}$		-20		20	mV
		$V_{OUT} \geq 1.2\text{ V}$, $-40^\circ\text{C} \leq T_J \leq 125^\circ\text{C}$		-1.5%		1.5%	
		$V_{OUT} < 1.2\text{ V}$, $-40^\circ\text{C} \leq T_J \leq 125^\circ\text{C}$		-50		50	mV
$\Delta V_{OUT(\Delta V_{IN})}$	Line regulation	Max $\{V_{OUT(nom)} + 0.5\text{ V}, V_{IN} = 2.0\text{ V}\} \leq V_{IN} \leq 5.5\text{ V}$			1	5	mV
$\Delta V_{OUT(\Delta I_{OUT})}$	Load regulation	$0\text{ mA} \leq I_{OUT} \leq 150\text{ mA}$			10	30	mV
V_{DO}	Dropout voltage	$V_{OUT} = 0.98 \times V_{OUT(nom)}$, $T_J = -40^\circ\text{C}$ to 85°C	$1\text{ V} \leq V_{OUT} < 1.8\text{ V}$, $I_{OUT} = 150\text{ mA}$		600	900	mV
			$V_{OUT} = 1.1\text{ V}$, $I_{OUT} = 100\text{ mA}$		470	600	
			$1.8\text{ V} \leq V_{OUT} < 2.1\text{ V}$, $I_{OUT} = 30\text{ mA}$		70		
			$1.8\text{ V} \leq V_{OUT} < 2.1\text{ V}$, $I_{OUT} = 150\text{ mA}$		350	575	
			$2.1\text{ V} \leq V_{OUT} < 2.5\text{ V}$, $I_{OUT} = 30\text{ mA}$		90		
			$2.1\text{ V} \leq V_{OUT} < 2.5\text{ V}$, $I_{OUT} = 150\text{ mA}$		290	481	
			$2.5\text{ V} \leq V_{OUT} < 3\text{ V}$, $I_{OUT} = 30\text{ mA}$		50		
			$2.5\text{ V} \leq V_{OUT} < 3\text{ V}$, $I_{OUT} = 150\text{ mA}$		246	445	
		$V_{OUT} = 0.98 \times V_{OUT(nom)}$, $T_J = -40^\circ\text{C}$ to 125°C	$3\text{ V} \leq V_{OUT} < 3.6\text{ V}$, $I_{OUT} = 30\text{ mA}$		46		
			$3\text{ V} \leq V_{OUT} < 3.6\text{ V}$, $I_{OUT} = 150\text{ mA}$		230	420	
			$1\text{ V} \leq V_{OUT} < 1.8\text{ V}$, $I_{OUT} = 150\text{ mA}$		600	1020	
			$V_{OUT} = 1.1\text{ V}$, $I_{OUT} = 100\text{ mA}$		470	720	
			$1.8\text{ V} \leq V_{OUT} < 2.1\text{ V}$, $I_{OUT} = 150\text{ mA}$		350	695	
			$2.1\text{ V} \leq V_{OUT} < 2.5\text{ V}$, $I_{OUT} = 150\text{ mA}$		290	601	
			$2.5\text{ V} \leq V_{OUT} < 3\text{ V}$, $I_{OUT} = 150\text{ mA}$		246	565	
			$3\text{ V} \leq V_{OUT} < 3.6\text{ V}$, $I_{OUT} = 150\text{ mA}$		230	540	
I_{GND}	Ground pin current	$I_{OUT} = 0\text{ mA}$			50	75	μA
$I_{SHUTDOWN}$	Shutdown current	$V_{EN} \leq 0.4\text{ V}$, $2.0\text{ V} \leq V_{IN} \leq 5.5\text{ V}$, $T_J = 25^\circ\text{C}$			0.1	1	μA
PSRR	Power-supply rejection ratio	$V_{IN} = 3.3\text{ V}$, $V_{OUT} = 2.8\text{ V}$, $I_{OUT} = 30\text{ mA}$	$f = 100\text{ Hz}$		70	dB	
			$f = 10\text{ kHz}$		55		
			$f = 1\text{ MHz}$		55		
V_n	Output noise voltage	BW = 100 Hz to 100 kHz, $V_{IN} = 2.3\text{ V}$, $V_{OUT} = 1.8\text{ V}$, $I_{OUT} = 10\text{ mA}$			73		μV_{RMS}
t_{STR}	Start-up time ⁽¹⁾	$C_{OUT} = 1.0\text{ }\mu\text{F}$, $I_{OUT} = 150\text{ mA}$			100		μs
V_{HI}	Enable high (enabled)			0.9		V_{IN}	V
V_{LO}	Enable low (disabled)			0		0.4	V
I_{EN}	EN pin current	EN = 5.5 V			0.01		μA
$R_{PULLDOWN}$	Pulldown resistor (TLV713P only)	$V_{IN} = 4\text{ V}$			120		Ω
I_{LIM}	Output current limit	$V_{IN} = 3.8\text{ V}$, $V_{OUT} = 3.3\text{ V}$, $T_J = -40$ to 85°C		180		mA	
		$V_{IN} = 2.25\text{ V}$, $V_{OUT} = 1.8\text{ V}$, $T_J = -40$ to 85°C		180			
		$V_{IN} = 2.0\text{ V}$, $V_{OUT} = 1.2\text{ V}$, $T_J = -40$ to 85°C		180			
I_{SC}	Short-circuit current	$V_{OUT} = 0\text{ V}$			40		mA
T_{SD}	Thermal shutdown	Shutdown, temperature increasing			158		$^\circ\text{C}$
		Reset, temperature decreasing			140		

(1) Start-up time is the time from EN assertion to $(0.98 \times V_{OUT(nom)})$.

6.6 Typical Characteristics

Over operating temperature range ($T_J = -40^{\circ}\text{C}$ to 125°C), $V_{IN} = V_{OUT(nom)} + 0.5\text{ V}$ or 2.0 V (whichever is greater), $I_{OUT} = 10\text{ mA}$, $V_{EN} = V_{IN}$, $C_{OUT} = 1\ \mu\text{F}$, and $V_{OUT(nom)} = 1.8\text{ V}$, unless otherwise noted. Typical values are at $T_J = 25^{\circ}\text{C}$.

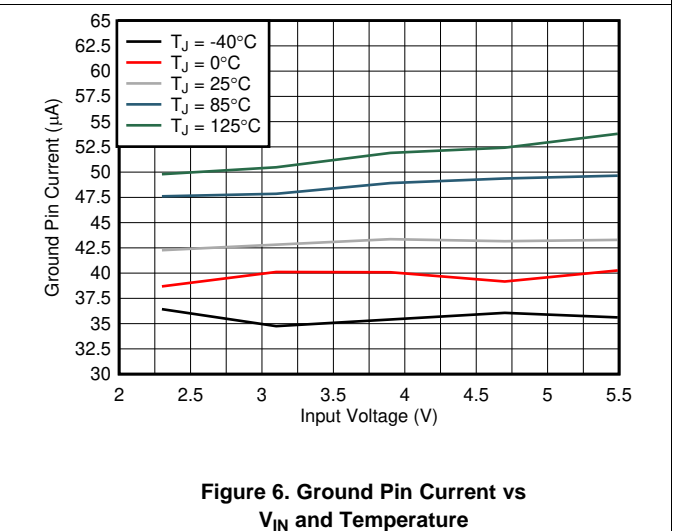
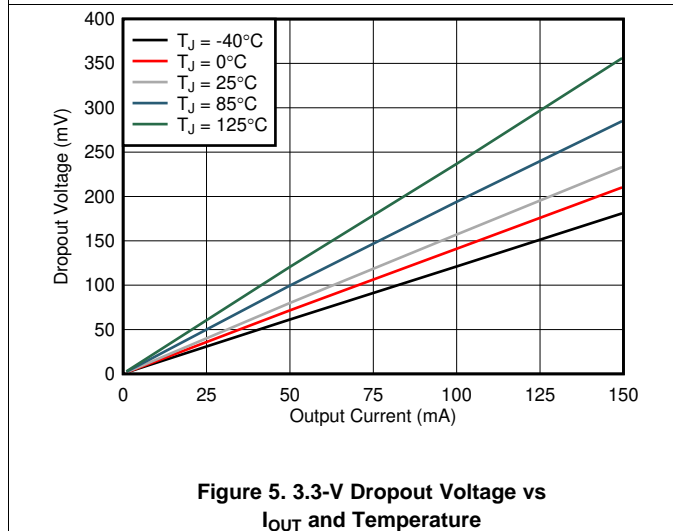
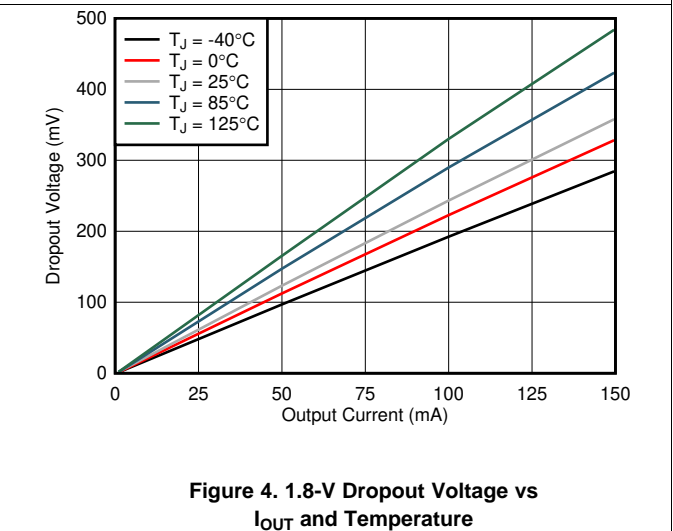
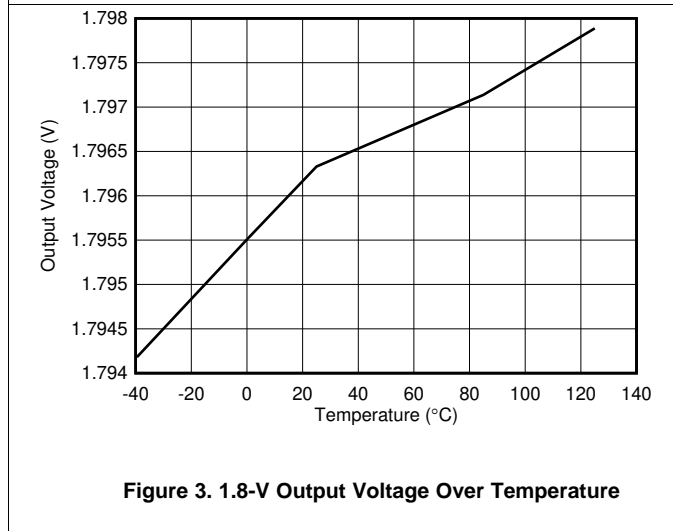
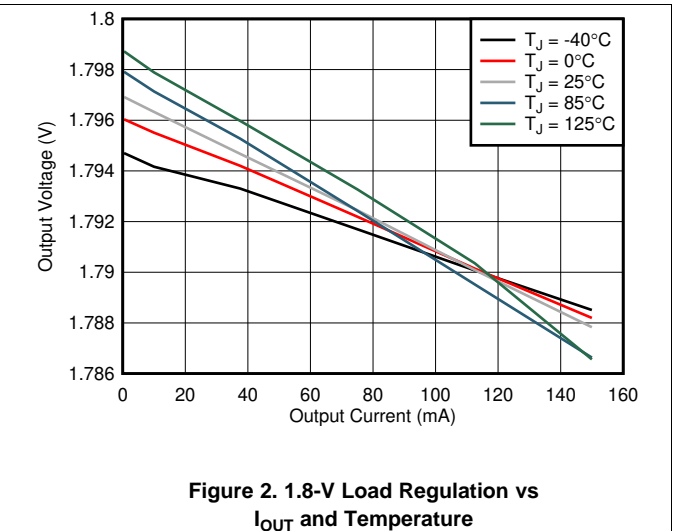
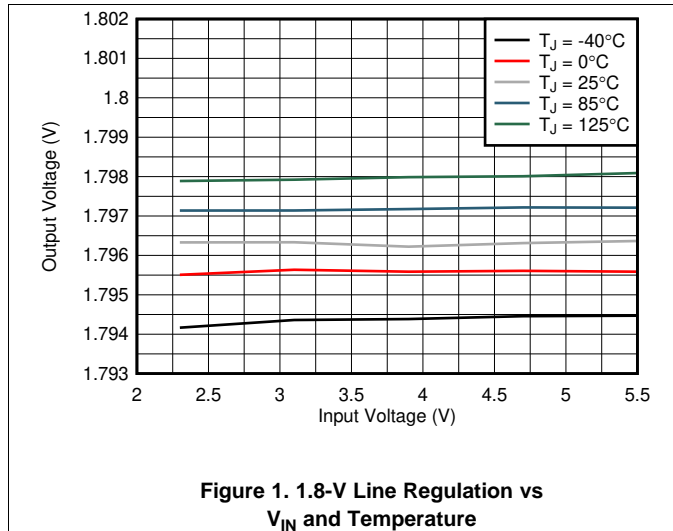

Typical Characteristics (continued)

Over operating temperature range ($T_J = -40^{\circ}\text{C}$ to 125°C), $V_{IN} = V_{OUT(nom)} + 0.5\text{ V}$ or 2.0 V (whichever is greater), $I_{OUT} = 10\text{ mA}$, $V_{EN} = V_{IN}$, $C_{OUT} = 1\text{ }\mu\text{F}$, and $V_{OUT(nom)} = 1.8\text{ V}$, unless otherwise noted. Typical values are at $T_J = 25^{\circ}\text{C}$.

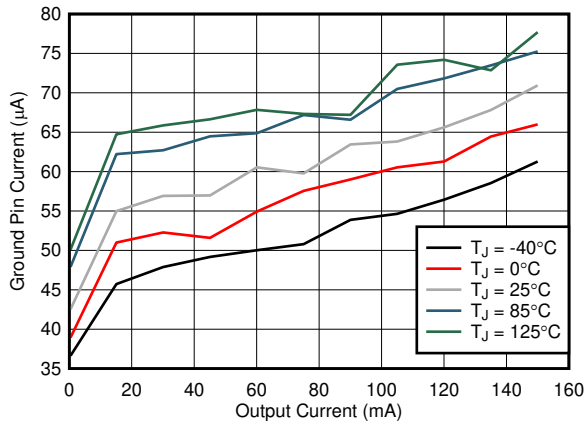

Figure 7. Ground Pin Current vs I_{OUT} and Temperature

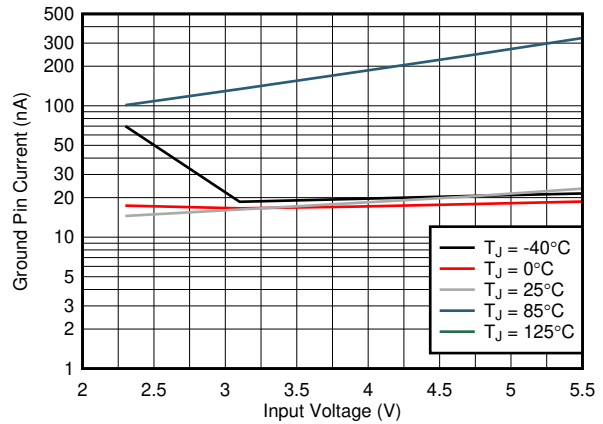

Figure 8. Shutdown Current vs V_{IN} and Temperature

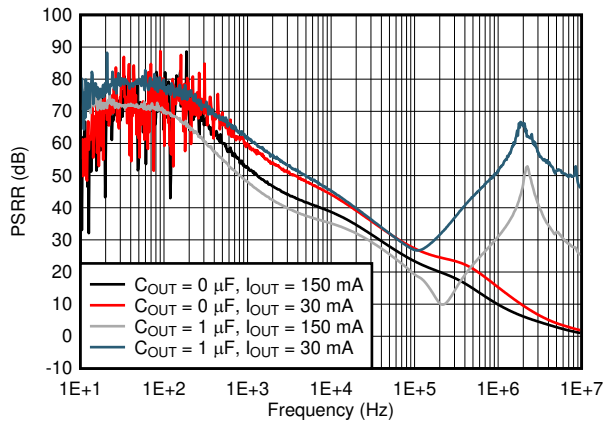

Figure 9. Power-Supply Rejection Ratio Over C_{OUT}

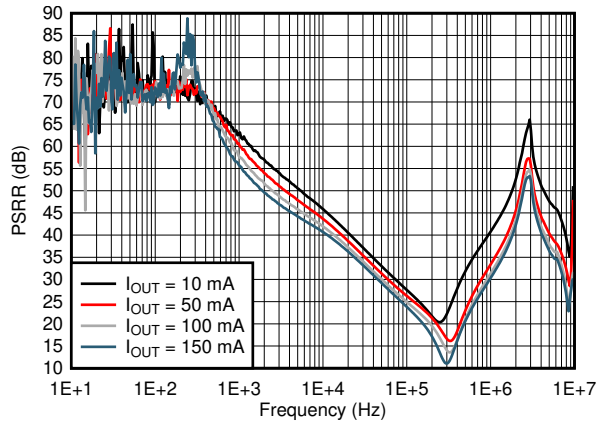

Figure 10. Power-Supply Rejection Ratio Over I_{OUT}

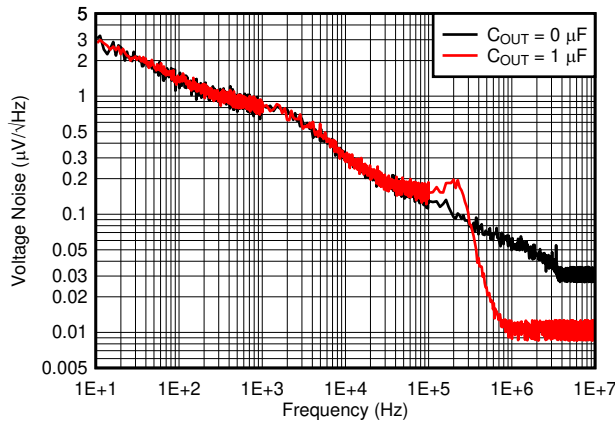

Figure 11. Output Spectral Noise Density

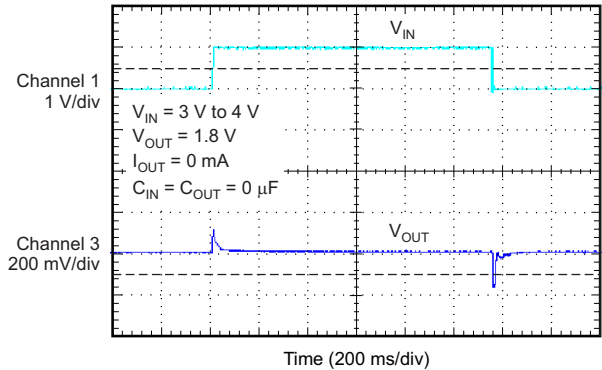
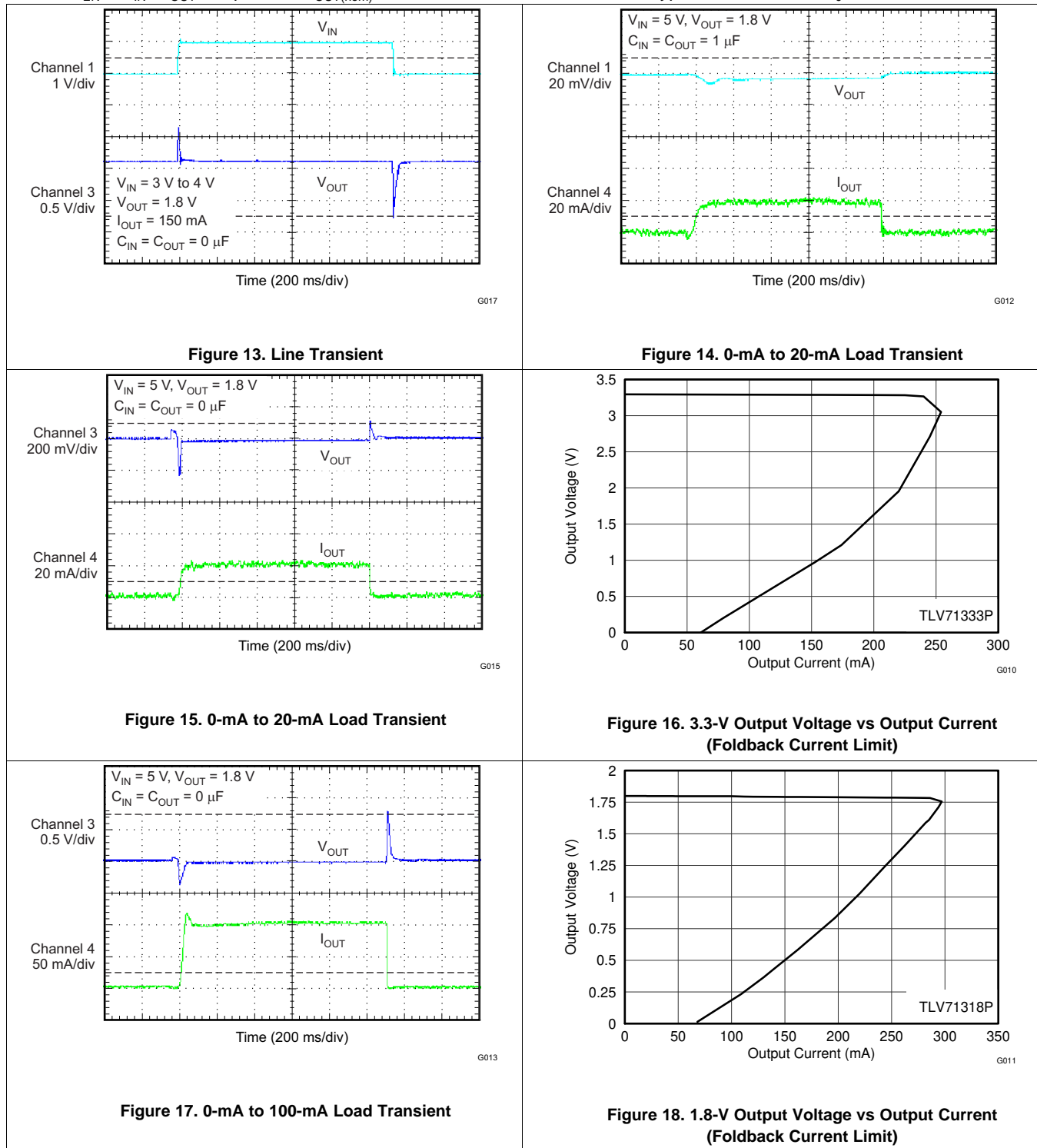

Figure 12. Line Transient

Typical Characteristics (continued)

Over operating temperature range ($T_J = -40^{\circ}\text{C}$ to 125°C), $V_{IN} = V_{OUT(nom)} + 0.5\text{ V}$ or 2.0 V (whichever is greater), $I_{OUT} = 10\text{ mA}$, $V_{EN} = V_{IN}$, $C_{OUT} = 1\text{ }\mu\text{F}$, and $V_{OUT(nom)} = 1.8\text{ V}$, unless otherwise noted. Typical values are at $T_J = 25^{\circ}\text{C}$.



Typical Characteristics (continued)

Over operating temperature range ($T_J = -40^{\circ}\text{C}$ to 125°C), $V_{IN} = V_{OUT(nom)} + 0.5\text{ V}$ or 2.0 V (whichever is greater), $I_{OUT} = 10\text{ mA}$, $V_{EN} = V_{IN}$, $C_{OUT} = 1\text{ }\mu\text{F}$, and $V_{OUT(nom)} = 1.8\text{ V}$, unless otherwise noted. Typical values are at $T_J = 25^{\circ}\text{C}$.

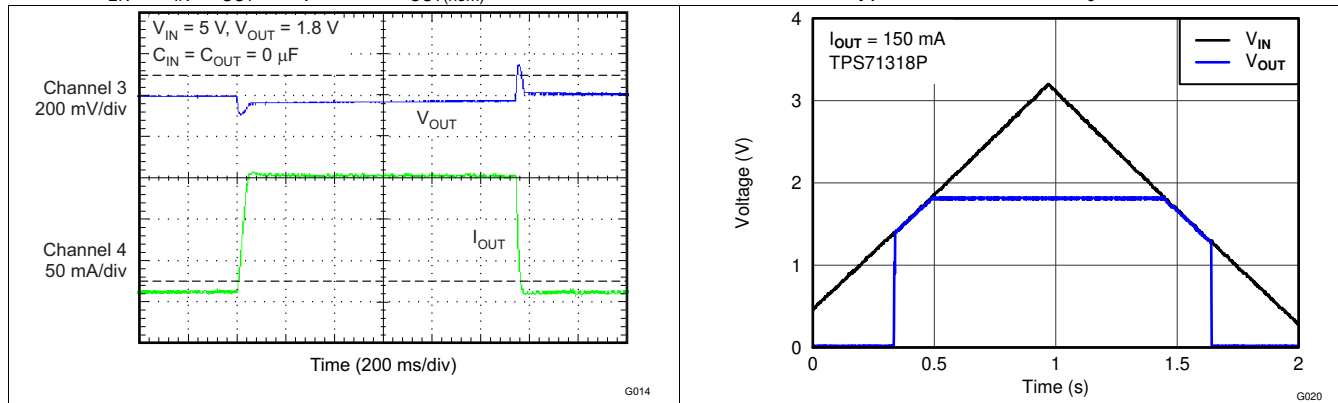

Figure 19. 10-mA to 150-mA Load Transient

Figure 20. V_{IN} Power-Up and Power-Down

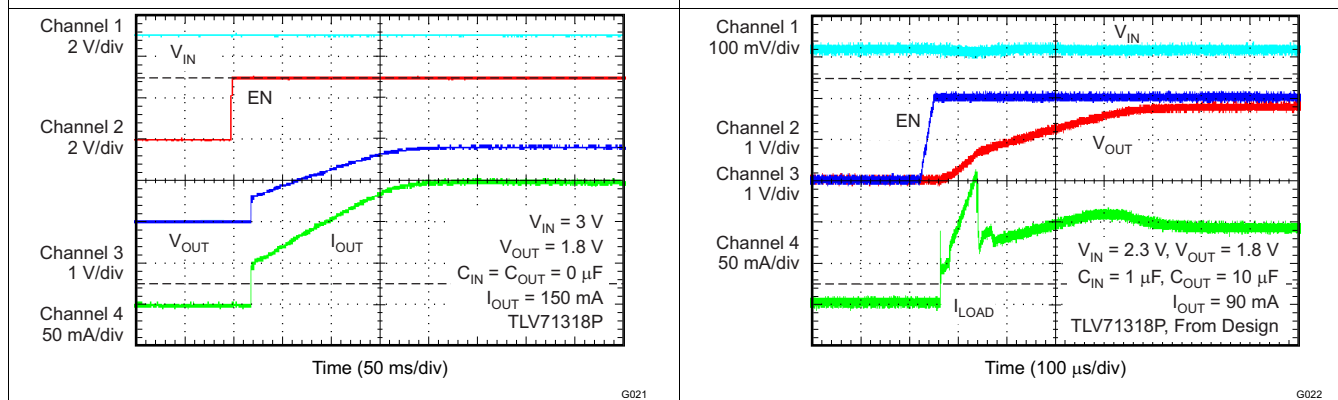

Figure 21. Start-up With EN

Figure 22. Start-up With EN

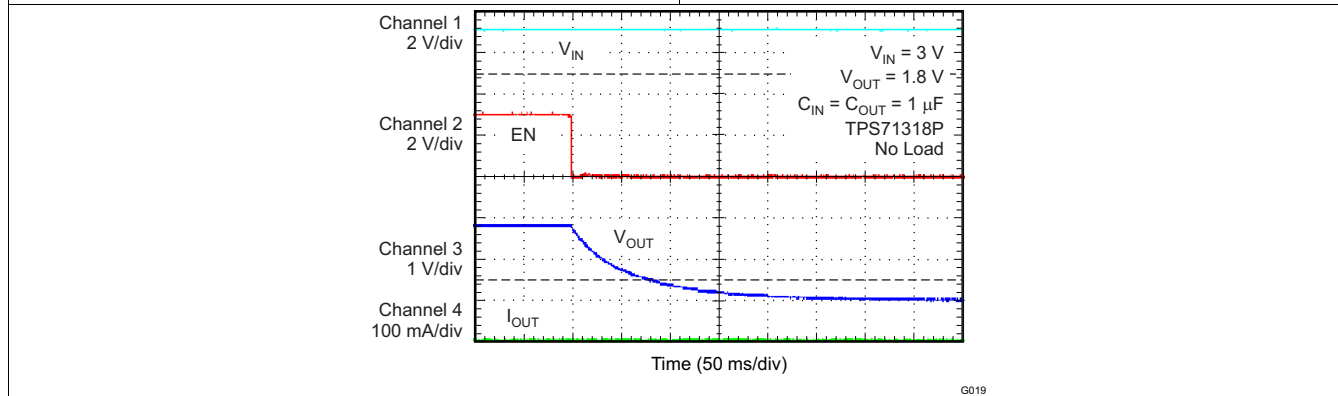

Figure 23. Shutdown Response With Enable

7 Detailed Description

7.1 Overview

These devices belong to a new family of next-generation value low-dropout (LDO) regulators. These devices consume low quiescent current and deliver excellent line and load transient performance. These characteristics, combined with low noise, very good PSRR with little ($V_{IN} - V_{OUT}$) headroom, make this family of devices ideal for RF portable applications.

This family of regulators offers current limit and thermal protection. Device operating junction temperature is -40°C to 125°C .

7.2 Functional Block Diagrams

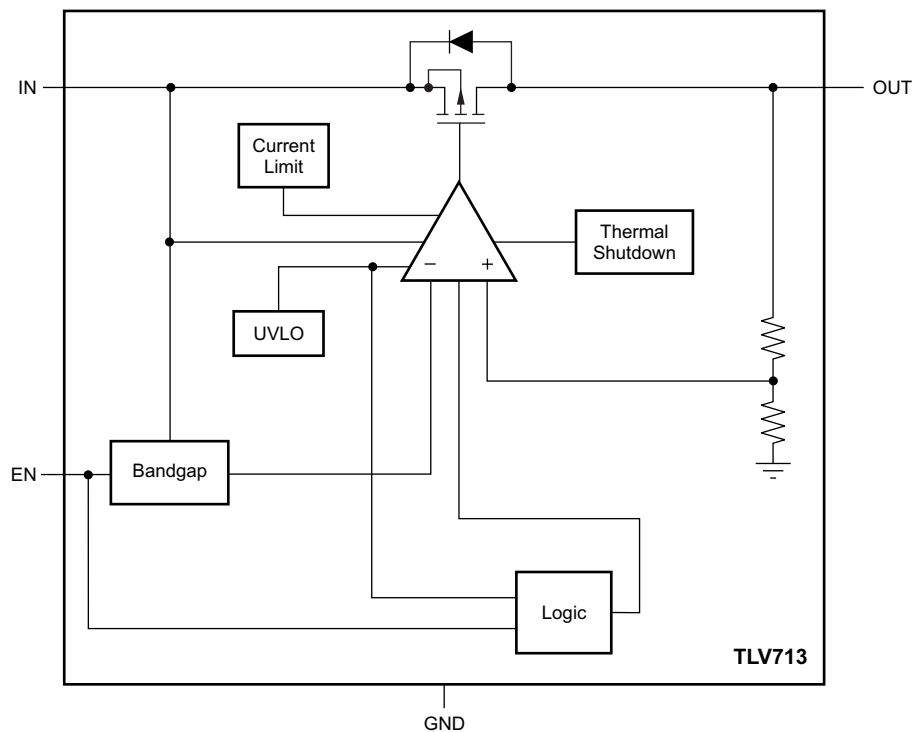

Figure 24. TLV713 Block Diagram

Functional Block Diagrams (continued)

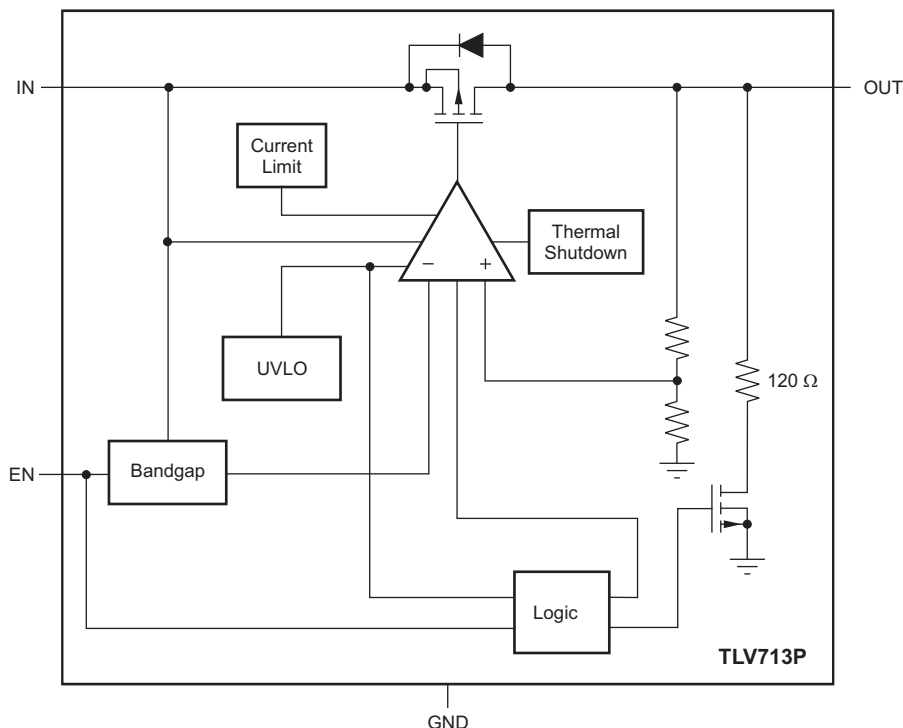

Figure 25. TLV713P Block Diagram

7.3 Feature Description

7.3.1 Undervoltage Lockout (UVLO)

The TLV713 uses a UVLO circuit that disables the output until the input voltage is greater than the rising UVLO voltage. This circuit ensures that the device does not exhibit any unpredictable behavior when the supply voltage is lower than the operational range of the internal circuitry, $V_{IN(min)}$. During UVLO disable, the output of the TLV713P version is connected to ground with a 120- Ω pulldown resistor. Fast rising and falling voltage changes near UVLO levels require at least a 1-ms delay before the rising and falling edges; see the [UVLO Circuit Limitation](#) section.

7.3.2 Shutdown

The enable pin (EN) is active high. Enable the device by forcing the EN pin to exceed $V_{EN(high)}$ (0.9 V, minimum). Turn off the device by forcing the EN pin to drop below 0.4 V. If shutdown capability is not required, connect EN to IN.

The TLV713P has an internal pulldown MOSFET that connects a 120- Ω resistor to ground when the device is disabled. The discharge time after disabling depends on the output capacitance (C_{OUT}) and the load resistance (R_L) in parallel with the 120- Ω pulldown resistor. The time constant is calculated in [Equation 1](#).

$$\tau = \frac{120 \cdot R_L}{120 + R_L} \cdot C_{OUT} \quad (1)$$

Feature Description (continued)

7.3.3 Foldback Current Limit

The TLV713 has an internal foldback current limit that helps protect the regulator during fault conditions. The current supplied by the device is gradually reduced while the output voltage decreases. When the output is shorted, the LDO supplies a typical current of 40 mA. Output voltage is not regulated when the device is in current limit, and is calculated by [Equation 2](#):

$$V_{OUT} = I_{LIMIT} \times R_{LOAD} \quad (2)$$

The PMOS pass transistor dissipates $[(V_{IN} - V_{OUT}) \times I_{LIMIT}]$ until thermal shutdown is triggered and the device turns off. The device is turned on by the internal thermal shutdown circuit during cool down. If the fault condition continues, the device cycles between current limit and thermal shutdown. See the [Thermal Information](#) section for more details.

The TLV713 PMOS pass element has a built-in body diode that conducts current when the voltage at OUT exceeds the voltage at IN. This current is not limited, so if extended reverse voltage operation is anticipated, external limiting to 5% of the rated output current is recommended.

7.3.4 Thermal Protection

Thermal protection disables the output when the junction temperature rises to approximately 158°C, allowing the device to cool. When the junction temperature cools to approximately 140°C, the output circuitry is again enabled. Depending on power dissipation, thermal resistance, and ambient temperature, the thermal protection circuit may cycle on and off. This cycling limits regulator dissipation, protecting the device from damage as a result of overheating.

Any tendency to activate the thermal protection circuit indicates excessive power dissipation or an inadequate heatsink. For reliable operation, junction temperature must be limited to 125°C maximum. To estimate the margin of safety in a complete design (including heatsink), increase the ambient temperature until the thermal protection is triggered; use worst-case loads and signal conditions.

The TLV713 internal protection circuitry is designed to protect against overload conditions. This circuitry is not intended to replace proper heatsinking. Continuously running the TLV713 into thermal shutdown degrades device reliability.

7.4 Device Functional Modes

7.4.1 Normal Operation

The device regulates to the nominal output voltage under the following conditions:

- The input voltage is at least as high as $V_{IN(min)}$.
- The input voltage is greater than the nominal output voltage added to the dropout voltage.
- The enable voltage has previously exceeded the enable rising threshold voltage and has not decreased below the enable falling threshold.
- The output current is less than the current limit.
- The device junction temperature is less than the maximum specified junction temperature.

7.4.2 Dropout Operation

If the input voltage is lower than the nominal output voltage plus the specified dropout voltage, but all other conditions are met for normal operation, the device operates in dropout mode. In this mode of operation, the output voltage is the same as the input voltage minus the dropout voltage. The transient performance of the device is significantly degraded because the pass device is in the linear region and no longer controls the current through the LDO. Line or load transients in dropout can result in large output voltage deviations.

7.4.3 Disabled

The device is disabled under the following conditions:

- The enable voltage is less than the enable falling threshold voltage or has not yet exceeded the enable rising threshold.
- The device junction temperature is greater than the thermal shutdown temperature.

Table 1 shows the conditions that lead to the different modes of operation.

Table 1. Device Functional Mode Comparison

OPERATING MODE	PARAMETER			
	V_{IN}	V_{EN}	I_{OUT}	T_J
Normal mode	$V_{IN} > V_{OUT(nom)} + V_{DO}$ and $V_{IN} > V_{IN(min)}$	$V_{EN} > V_{EN(high)}$	$I_{OUT} < I_{LIM}$	$T_J < 125^{\circ}C$
Dropout mode	$V_{IN(min)} < V_{IN} < V_{OUT(nom)} + V_{DO}$	$V_{EN} > V_{EN(high)}$	—	$T_J < 125^{\circ}C$
Disabled mode (any true condition disables the device)	—	$V_{EN} < V_{EN(low)}$	—	$T_J > 158^{\circ}C$

8 Application and Implementation

NOTE

Information in the following applications sections is not part of the TI component specification, and TI does not warrant its accuracy or completeness. TI's customers are responsible for determining suitability of components for their purposes. Customers should validate and test their design implementation to confirm system functionality.

8.1 Application Information

8.1.1 Input and Output Capacitor Considerations

The TLV713 uses an advanced internal control loop to obtain stable operation both with and without the use of input or output capacitors. The TLV713 dynamic performance is improved with the use of an output capacitor. An output capacitance of 0.1 μF or larger generally provides good dynamic response. X5R- and X7R-type ceramic capacitors are recommended because these capacitors have minimal variation in value and equivalent series resistance (ESR) over temperature.

Although an input capacitor is not required for stability, it is good analog design practice to connect a 0.1- μF to 1- μF capacitor from IN to GND. This capacitor counteracts reactive input sources and improves transient response, input ripple, and PSRR. An input capacitor is recommended if the source impedance is more than 0.5 Ω . A higher-value capacitor may be necessary if large, fast, rise-time load transients are anticipated or if the device is located several inches from the input power source.

8.1.2 Dropout Voltage

The TLV713 uses a PMOS pass transistor to achieve low dropout. When $(V_{\text{IN}} - V_{\text{OUT}})$ is less than the dropout voltage (V_{DO}), the PMOS pass device is in the linear region of operation and the input-to-output resistance is the $R_{\text{DS(on)}}$ of the PMOS pass element. V_{DO} scales approximately with output current because the PMOS device behaves like a resistor in dropout. As with any linear regulator, PSRR and transient response are degraded as $(V_{\text{IN}} - V_{\text{OUT}})$ approaches dropout.

8.1.3 Transient Response

As with any regulator, increasing the size of the output capacitor reduces over- and undershoot magnitude but increases the duration of the transient response.

8.1.4 UVLO Circuit Limitation

The TLV713 UVLO circuit is sensitive to fast rising and falling input voltage changes that result in the device turning on and off. When the input voltage drops below the minimum V_{IN} and the device is turned off, provide a minimum 1-ms delay before turning on the device again. This minimum 1-ms delay allows the internal circuit to reset to the correct state. If the TLV713 is turned on again before the delay elapses, an EN toggle is required for the internal circuit to reset to the correct state.

8.2 Typical Application

Several versions of the TPS713 are ideal for powering the [MSP430 microcontroller](#).

[Figure 26](#) shows a diagram of the TLV713 powering an MSP430 microcontroller. [Table 2](#) shows potential applications of some voltage versions.

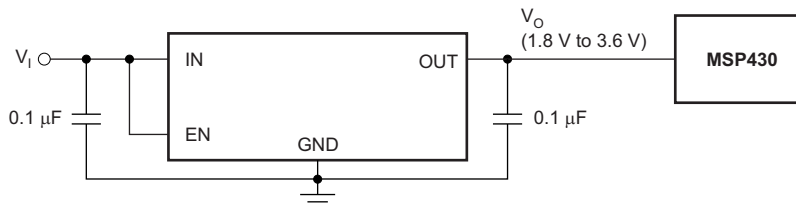

Figure 26. TLV713 Powering a Microcontroller

Table 2. Typical MSP430 Applications

DEVICE	V _{OUT} (Typ)	APPLICATION
TLV71318P	1.8 V	Allows for lowest power consumption with many MSP430s
TLV71325P	2.5 V	2.2-V supply required by many MSP430s for flash programming and erasing

8.2.1 Design Requirements

[Table 3](#) lists the design requirements.

Table 3. Design Parameters

PARAMETER	DESIGN REQUIREMENT
Input voltage	4.2 V to 3 V (Lithium Ion battery)
Output voltage	1.8 V, ±1%
DC output current	10 mA
Peak output current	75 mA
Maximum ambient temperature	65°C

8.2.2 Detailed Design Procedure

An input capacitor is not required for this design because of the low impedance connection directly to the battery.

No output capacitor allows for the minimal possible inrush current during start-up, ensuring the 180-mA maximum input current limit is not exceeded.

Verify that the maximum junction temperature is not exceeded by referring to [Figure 30](#).

8.2.3 Application Curves

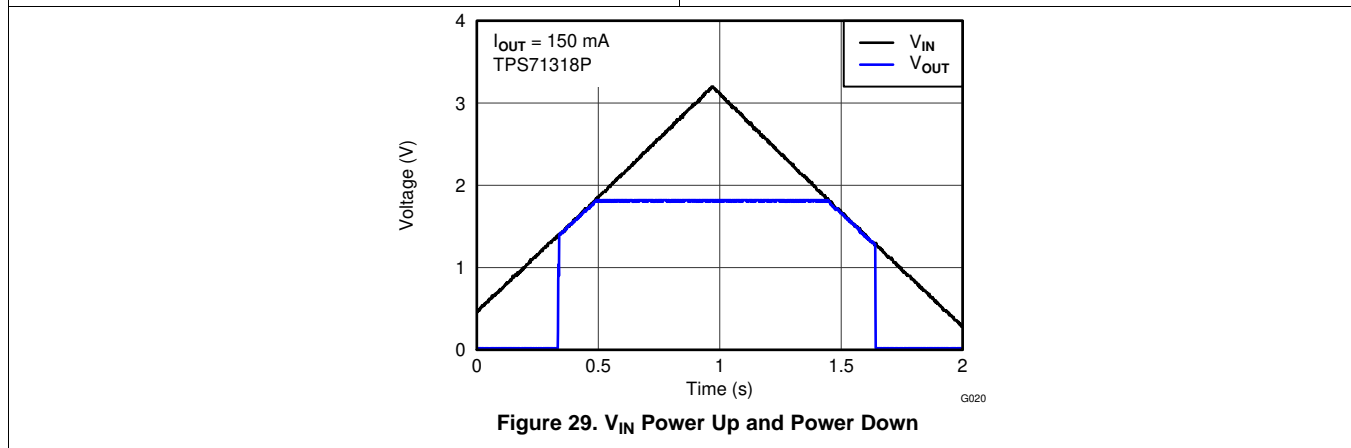
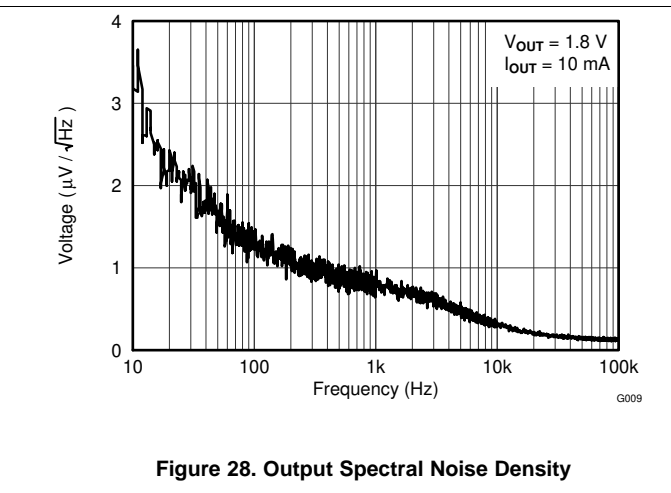
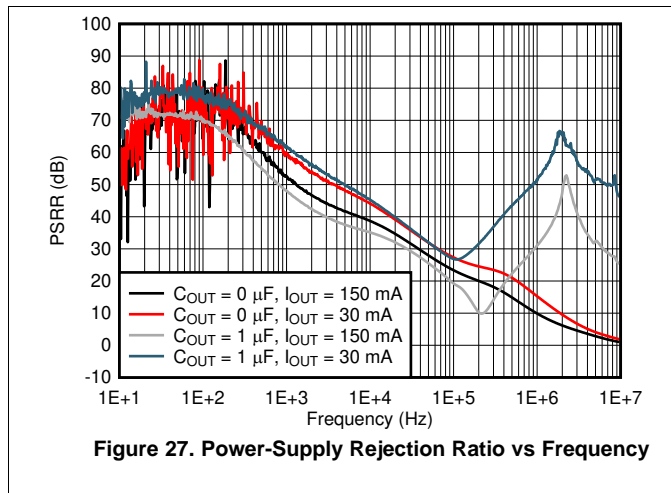

8.3 What to Do and What Not to Do

Place at least one 0.1- μ F ceramic capacitor as close as possible to the OUT pin of the regulator for best transient performance.

Place at least one 1- μ F capacitor as close as possible to the IN pin for best transient performance.

Do not place the output capacitor more than 10 mm away from the regulator.

Do not exceed the absolute maximum ratings.

Do not continuously operate the device in current limit or near thermal shutdown.

9 Power Supply Recommendations

These devices are designed to operate from an input voltage supply range from 1.4 V to 5.5 V. The input voltage range must provide adequate headroom for the device to have a regulated output. This input supply must be well-regulated and stable. If the input supply is noisy, additional input capacitors with low ESR can help improve the output noise performance.

10 Layout

10.1 Layout Guidelines

10.1.1 Board Layout Recommendations to Improve PSRR and Noise Performance

Input and output capacitors must be placed as close to the device pins as possible. To improve AC performance (such as PSRR, output noise, and transient response), TI recommends that the board be designed with separate ground planes for V_{IN} and V_{OUT} , with the ground plane connected only at the device GND pin. In addition, the output capacitor ground connection must be connected directly to the device GND pin. High-ESR capacitors may degrade PSRR performance.

10.1.2 Power Dissipation

The ability to remove heat from the die is different for each package type, presenting different considerations in the printed-circuit-board (PCB) layout. The PCB area around the device that is free of other components moves the heat from the device to the ambient air. Performance data for JEDEC low- and high-K boards are given in [Thermal Information](#). Using heavier copper increases the effectiveness in removing heat from the device. The addition of plated through-holes to heat-dissipating layers also improves the heatsink effectiveness.

Power dissipation depends on input voltage and load conditions. Power dissipation (P_D) can be approximated by the product of the output current times the voltage drop across the output pass element (V_{IN} to V_{OUT}), as shown in [Equation 3](#).

$$P_D = (V_{IN} - V_{OUT}) \times I_{OUT} \quad (3)$$

[Figure 30](#) shows the maximum ambient temperature versus the power dissipation of the TLV713. This figure assumes the device is soldered on a JEDEC standard, high-K layout with no airflow over the board. Actual board thermal impedances vary widely. If the application requires high power dissipation, having a thorough understanding of the board temperature and thermal impedances is helpful to ensure the TLV713 does not operate above a junction temperature of 125°C.

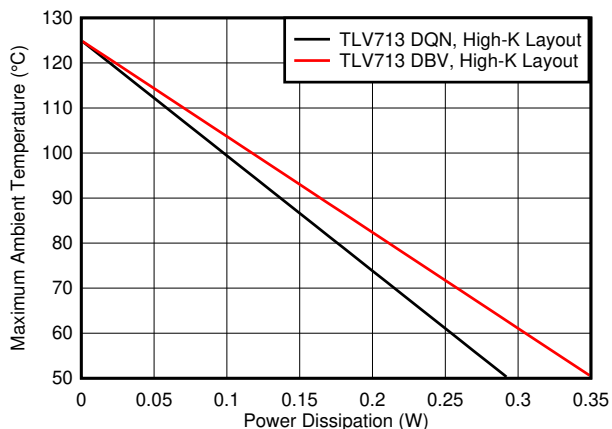

Figure 30. Maximum Ambient Temperature vs Device Power Dissipation

Estimating the junction temperature can be done by using the thermal metrics Ψ_{JT} and Ψ_{JB} , shown in the [Thermal Information](#) table. These metrics are a more accurate representation of the heat transfer characteristics of the die and the package than $R_{\theta JA}$. The junction temperature can be estimated with [Equation 4](#).

Layout Guidelines (continued)

$$\Psi_{JT}: T_J = T_T + \Psi_{JT} \cdot P_D$$

$$\Psi_{JB}: T_J = T_B + \Psi_{JB} \cdot P_D$$

where

- P_D is the power dissipation shown by Equation 3,
 - T_T is the temperature at the center-top of the IC package,
 - T_B is the PCB temperature measured 1 mm away from the IC package on the PCB surface.
- (4)

NOTE

Both T_T and T_B can be measured on actual application boards using a thermo-gun (an infrared thermometer).

For more information about measuring T_T and T_B , see the [Using New Thermal Metrics application note](#), available for download at www.ti.com.

10.2 Layout Examples

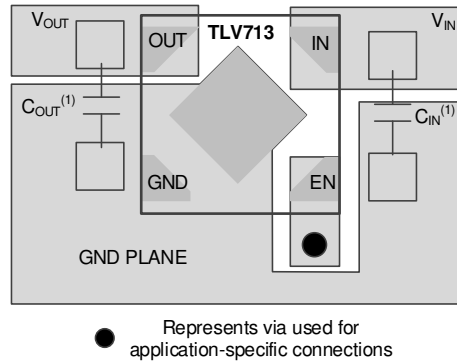

(1) Not required.

Figure 31. X2SON Layout Example

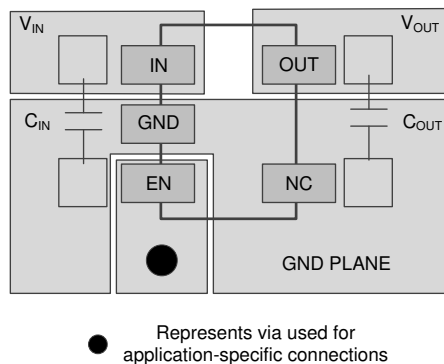

(1) Not required.

Figure 32. SOT-23 Layout Example

11 器件和文档支持

11.1 器件支持

11.1.1 开发支持

11.1.1.1 评估模块

有三个评估模块 (EVM) 可与 TLV713 配套使用, 帮助评估初始电路性能:

- [TLV71312PEVM-171](#)
- [TLV71318PEVM-171](#)
- [TLV71333PEVM-171](#)

这些 EVM 可从德州仪器 (TI) 网站上的器件产品文件夹获取, 也可直接从 [TI 网上商店](#) 购买。

11.1.1.2 Spice 模型

分析模拟电路和系统的性能时, 使用 **SPICE** 模型对电路性能进行计算机仿真非常有用。您可以从产品文件夹中的 [工具和软件](#) 下获取 TLV713 的 **SPICE** 模型。

11.1.2 器件命名规则

表 4. 订购信息 (1)(2)

产品	V_o
TLV713xx(x)Pyyyz	<p>XX(X) 是标称输出电压。对于分辨率为 100mV 的输出电压, 订货编号中使用两位数字; 否则, 使用三位数字 (例如, 28 = 2.8V; 475 = 4.75 V)。</p> <p>P 为可选项; P 表示器件具有一个带有源输出放电功能的 LDO 稳压器。</p> <p>YYY 为封装标识符。</p> <p>Z 为封装数量。R 表示卷 (3000 片), T 表示带 (250 片)。</p>

(1) 要获得最新的封装和订货信息, 请参阅本文档末尾的封装选项附录, 或者访问器件产品文件夹 (www.ti.com.cn)。

(2) 可提供 1.0V 至 3.3V 范围内的输出电压 (以 50mV 为单位增量)。更多详细信息及可用性, 请联系制造商。

11.2 文档支持

11.2.1 相关文档

请参阅如下相关文档:

- 德州仪器 (TI), [《使用新的热度量指标》应用报告](#)
- 德州仪器 (TI), [《TLV713xxEVM-171 用户指南》用户指南](#)

11.3 接收文档更新通知

要接收文档更新通知, 请导航至 TI.com.cn 上的器件产品文件夹。单击右上角的 [通知我](#) 进行注册, 即可每周接收产品信息更改摘要。有关更改的详细信息, 请查看任何已修订文档中包含的修订历史记录。

11.4 社区资源

The following links connect to TI community resources. Linked contents are provided "AS IS" by the respective contributors. They do not constitute TI specifications and do not necessarily reflect TI's views; see TI's [Terms of Use](#).

TI E2E™ Online Community *TI's Engineer-to-Engineer (E2E) Community*. Created to foster collaboration among engineers. At e2e.ti.com, you can ask questions, share knowledge, explore ideas and help solve problems with fellow engineers.

Design Support *TI's Design Support* Quickly find helpful E2E forums along with design support tools and contact information for technical support.

11.5 商标

E2E is a trademark of Texas Instruments.

All other trademarks are the property of their respective owners.

11.6 静电放电警告



ESD 可能会损坏该集成电路。德州仪器 (TI) 建议通过适当的预防措施处理所有集成电路。如果不遵守正确的处理措施和安装程序，可能会损坏集成电路。

ESD 的损坏小至导致微小的性能降级，大至整个器件故障。精密的集成电路可能更容易受到损坏，这是因为非常细微的参数更改都可能会导致器件与其发布的规格不相符。

11.7 Glossary

[SLYZ022](#) — *TI Glossary*.

This glossary lists and explains terms, acronyms, and definitions.

12 机械、封装和可订购信息

以下页面包含机械、封装和可订购信息。这些信息是指定器件的最新可用数据。数据如有变更，恕不另行通知，且不会对此文档进行修订。如需获取此数据表的浏览器版本，请查阅左侧的导航栏。

PACKAGING INFORMATION

Orderable part number	Status (1)	Material type (2)	Package Pins	Package qty Carrier	RoHS (3)	Lead finish/ Ball material (4)	MSL rating/ Peak reflow (5)	Op temp (°C)	Part marking (6)
TLV71310PDBVR	Active	Production	SOT-23 (DBV) 5	3000 LARGE T&R	Yes	NIPDAU SN	Level-1-260C-UNLIM	-40 to 125	VUQI
TLV71310PDBVR.A	Active	Production	SOT-23 (DBV) 5	3000 LARGE T&R	Yes	NIPDAU	Level-1-260C-UNLIM	-40 to 125	VUQI
TLV71310PDBVT	Active	Production	SOT-23 (DBV) 5	250 SMALL T&R	Yes	NIPDAU SN	Level-1-260C-UNLIM	-40 to 125	VUQI
TLV71310PDBVT.A	Active	Production	SOT-23 (DBV) 5	250 SMALL T&R	Yes	SN	Level-1-260C-UNLIM	-40 to 125	VUQI
TLV71310PDQNR	Active	Production	X2SON (DQN) 4	3000 LARGE T&R	Yes	NIPDAU	Level-1-260C-UNLIM	-40 to 125	ET
TLV71310PDQNR.A	Active	Production	X2SON (DQN) 4	3000 LARGE T&R	Yes	NIPDAU	Level-1-260C-UNLIM	-40 to 125	ET
TLV71310PDQNT	Active	Production	X2SON (DQN) 4	250 SMALL T&R	Yes	NIPDAU	Level-1-260C-UNLIM	-40 to 125	ET
TLV71310PDQNT.A	Active	Production	X2SON (DQN) 4	250 SMALL T&R	Yes	NIPDAU	Level-1-260C-UNLIM	-40 to 125	ET
TLV71311PDBVR	Active	Production	SOT-23 (DBV) 5	3000 LARGE T&R	Yes	NIPDAU SN	Level-1-260C-UNLIM	-40 to 125	VUPI
TLV71311PDBVR.A	Active	Production	SOT-23 (DBV) 5	3000 LARGE T&R	Yes	NIPDAU	Level-1-260C-UNLIM	-40 to 125	VUPI
TLV71311PDBVT	Active	Production	SOT-23 (DBV) 5	250 SMALL T&R	Yes	NIPDAU SN	Level-1-260C-UNLIM	-40 to 125	VUPI
TLV71311PDBVT.A	Active	Production	SOT-23 (DBV) 5	250 SMALL T&R	Yes	NIPDAU	Level-1-260C-UNLIM	-40 to 125	VUPI
TLV71312PDBVR	Active	Production	SOT-23 (DBV) 5	3000 LARGE T&R	Yes	NIPDAU SN	Level-1-260C-UNLIM	-40 to 125	VUEI
TLV71312PDBVR.A	Active	Production	SOT-23 (DBV) 5	3000 LARGE T&R	Yes	NIPDAU	Level-1-260C-UNLIM	-40 to 125	VUEI
TLV71312PDBVT	Active	Production	SOT-23 (DBV) 5	250 SMALL T&R	Yes	NIPDAU SN	Level-1-260C-UNLIM	-40 to 125	VUEI
TLV71312PDBVT.A	Active	Production	SOT-23 (DBV) 5	250 SMALL T&R	Yes	NIPDAU	Level-1-260C-UNLIM	-40 to 125	VUEI
TLV71312PDBVTG4	Active	Production	SOT-23 (DBV) 5	250 SMALL T&R	Yes	NIPDAU	Level-1-260C-UNLIM	-40 to 125	VUEI
TLV71312PDBVTG4.A	Active	Production	SOT-23 (DBV) 5	250 SMALL T&R	Yes	NIPDAU	Level-1-260C-UNLIM	-40 to 125	VUEI
TLV71312PDQNR	Active	Production	X2SON (DQN) 4	3000 LARGE T&R	Yes	NIPDAU	Level-1-260C-UNLIM	-40 to 125	AF
TLV71312PDQNR.A	Active	Production	X2SON (DQN) 4	3000 LARGE T&R	Yes	NIPDAU	Level-1-260C-UNLIM	-40 to 125	AF
TLV71312PDQNT	Active	Production	X2SON (DQN) 4	250 SMALL T&R	Yes	NIPDAU	Level-1-260C-UNLIM	-40 to 125	AF
TLV71312PDQNT.A	Active	Production	X2SON (DQN) 4	250 SMALL T&R	Yes	NIPDAU	Level-1-260C-UNLIM	-40 to 125	AF
TLV71315PDBVR	Active	Production	SOT-23 (DBV) 5	3000 LARGE T&R	Yes	NIPDAU SN	Level-1-260C-UNLIM	-40 to 125	VUGI
TLV71315PDBVR.A	Active	Production	SOT-23 (DBV) 5	3000 LARGE T&R	Yes	NIPDAU	Level-1-260C-UNLIM	-40 to 125	VUGI
TLV71315PDBVT	Active	Production	SOT-23 (DBV) 5	250 SMALL T&R	Yes	NIPDAU SN	Level-1-260C-UNLIM	-40 to 125	VUGI
TLV71315PDBVT.A	Active	Production	SOT-23 (DBV) 5	250 SMALL T&R	Yes	NIPDAU	Level-1-260C-UNLIM	-40 to 125	VUGI
TLV71315PDQNR	Active	Production	X2SON (DQN) 4	3000 LARGE T&R	Yes	NIPDAU	Level-1-260C-UNLIM	-40 to 125	AY
TLV71315PDQNR.A	Active	Production	X2SON (DQN) 4	3000 LARGE T&R	Yes	NIPDAU	Level-1-260C-UNLIM	-40 to 125	AY
TLV71315PDQNT	Active	Production	X2SON (DQN) 4	250 SMALL T&R	Yes	NIPDAU	Level-1-260C-UNLIM	-40 to 125	AY

Orderable part number	Status (1)	Material type (2)	Package Pins	Package qty Carrier	RoHS (3)	Lead finish/ Ball material (4)	MSL rating/ Peak reflow (5)	Op temp (°C)	Part marking (6)
TLV71315PDQNT.A	Active	Production	X2SON (DQN) 4	250 SMALL T&R	Yes	NIPDAU	Level-1-260C-UNLIM	-40 to 125	AY
TLV713185PDBVR	Active	Production	SOT-23 (DBV) 5	3000 LARGE T&R	Yes	NIPDAU SN	Level-1-260C-UNLIM	-40 to 125	VUII
TLV713185PDBVR.A	Active	Production	SOT-23 (DBV) 5	3000 LARGE T&R	Yes	NIPDAU	Level-1-260C-UNLIM	-40 to 125	VUII
TLV713185PDBVT	Active	Production	SOT-23 (DBV) 5	250 SMALL T&R	Yes	NIPDAU SN	Level-1-260C-UNLIM	-40 to 125	VUII
TLV713185PDBVT.A	Active	Production	SOT-23 (DBV) 5	250 SMALL T&R	Yes	SN	Level-1-260C-UNLIM	-40 to 125	VUII
TLV713185PDQNR	Active	Production	X2SON (DQN) 4	3000 LARGE T&R	Yes	NIPDAU	Level-1-260C-UNLIM	-40 to 125	A1
TLV713185PDQNR.A	Active	Production	X2SON (DQN) 4	3000 LARGE T&R	Yes	NIPDAU	Level-1-260C-UNLIM	-40 to 125	A1
TLV713185PDQNT	Active	Production	X2SON (DQN) 4	250 SMALL T&R	Yes	NIPDAU	Level-1-260C-UNLIM	-40 to 125	A1
TLV713185PDQNT.A	Active	Production	X2SON (DQN) 4	250 SMALL T&R	Yes	NIPDAU	Level-1-260C-UNLIM	-40 to 125	A1
TLV71318PDBVR	Active	Production	SOT-23 (DBV) 5	3000 LARGE T&R	Yes	NIPDAU SN	Level-1-260C-UNLIM	-40 to 125	VUDI
TLV71318PDBVR.A	Active	Production	SOT-23 (DBV) 5	3000 LARGE T&R	Yes	NIPDAU	Level-1-260C-UNLIM	-40 to 125	VUDI
TLV71318PDBVRG4	Active	Production	SOT-23 (DBV) 5	3000 LARGE T&R	Yes	NIPDAU	Level-1-260C-UNLIM	-40 to 125	VUDI
TLV71318PDBVRG4.A	Active	Production	SOT-23 (DBV) 5	3000 LARGE T&R	Yes	NIPDAU	Level-1-260C-UNLIM	-40 to 125	VUDI
TLV71318PDBVT	Active	Production	SOT-23 (DBV) 5	250 SMALL T&R	Yes	NIPDAU SN	Level-1-260C-UNLIM	-40 to 125	VUDI
TLV71318PDBVT.A	Active	Production	SOT-23 (DBV) 5	250 SMALL T&R	Yes	NIPDAU	Level-1-260C-UNLIM	-40 to 125	VUDI
TLV71318PDQNR	Active	Production	X2SON (DQN) 4	3000 LARGE T&R	Yes	NIPDAU	Level-1-260C-UNLIM	-40 to 125	AW
TLV71318PDQNR.A	Active	Production	X2SON (DQN) 4	3000 LARGE T&R	Yes	NIPDAU	Level-1-260C-UNLIM	-40 to 125	AW
TLV71318PDQNT	Active	Production	X2SON (DQN) 4	250 SMALL T&R	Yes	NIPDAU	Level-1-260C-UNLIM	-40 to 125	AW
TLV71318PDQNT.A	Active	Production	X2SON (DQN) 4	250 SMALL T&R	Yes	NIPDAU	Level-1-260C-UNLIM	-40 to 125	AW
TLV71320DQNR	Active	Production	X2SON (DQN) 4	3000 LARGE T&R	Yes	NIPDAU	Level-1-260C-UNLIM	-40 to 85	B2
TLV71320DQNR.A	Active	Production	X2SON (DQN) 4	3000 LARGE T&R	Yes	NIPDAU	Level-1-260C-UNLIM	-40 to 85	B2
TLV71320DQNT	Active	Production	X2SON (DQN) 4	250 SMALL T&R	Yes	NIPDAU	Level-1-260C-UNLIM	-40 to 85	B2
TLV71320DQNT.A	Active	Production	X2SON (DQN) 4	250 SMALL T&R	Yes	NIPDAU	Level-1-260C-UNLIM	-40 to 85	B2
TLV71325PDBVR	Active	Production	SOT-23 (DBV) 5	3000 LARGE T&R	Yes	NIPDAU SN	Level-1-260C-UNLIM	-40 to 125	VUJI
TLV71325PDBVR.A	Active	Production	SOT-23 (DBV) 5	3000 LARGE T&R	Yes	NIPDAU	Level-1-260C-UNLIM	-40 to 125	VUJI
TLV71325PDBVRG4	Active	Production	SOT-23 (DBV) 5	3000 LARGE T&R	Yes	NIPDAU	Level-1-260C-UNLIM	-40 to 125	VUJI
TLV71325PDBVRG4.A	Active	Production	SOT-23 (DBV) 5	3000 LARGE T&R	Yes	NIPDAU	Level-1-260C-UNLIM	-40 to 125	VUJI
TLV71325PDBVT	Active	Production	SOT-23 (DBV) 5	250 SMALL T&R	Yes	NIPDAU SN	Level-1-260C-UNLIM	-40 to 125	VUJI
TLV71325PDBVT.A	Active	Production	SOT-23 (DBV) 5	250 SMALL T&R	Yes	NIPDAU	Level-1-260C-UNLIM	-40 to 125	VUJI
TLV71325PDQNR	Active	Production	X2SON (DQN) 4	3000 LARGE T&R	Yes	NIPDAU	Level-1-260C-UNLIM	-40 to 125	AZ
TLV71325PDQNR.A	Active	Production	X2SON (DQN) 4	3000 LARGE T&R	Yes	NIPDAU	Level-1-260C-UNLIM	-40 to 125	AZ

Orderable part number	Status (1)	Material type (2)	Package Pins	Package qty Carrier	RoHS (3)	Lead finish/ Ball material (4)	MSL rating/ Peak reflow (5)	Op temp (°C)	Part marking (6)
TLV71325PDQNT	Active	Production	X2SON (DQN) 4	250 SMALL T&R	Yes	NIPDAU	Level-1-260C-UNLIM	-40 to 125	AZ
TLV71325PDQNT.A	Active	Production	X2SON (DQN) 4	250 SMALL T&R	Yes	NIPDAU	Level-1-260C-UNLIM	-40 to 125	AZ
TLV713285PDBVR	Active	Production	SOT-23 (DBV) 5	3000 LARGE T&R	Yes	NIPDAU SN	Level-1-260C-UNLIM	-40 to 125	VULI
TLV713285PDBVR.A	Active	Production	SOT-23 (DBV) 5	3000 LARGE T&R	Yes	NIPDAU	Level-1-260C-UNLIM	-40 to 125	VULI
TLV713285PDBVRG4	Active	Production	SOT-23 (DBV) 5	3000 LARGE T&R	Yes	NIPDAU	Level-1-260C-UNLIM	-40 to 125	VULI
TLV713285PDBVRG4.A	Active	Production	SOT-23 (DBV) 5	3000 LARGE T&R	Yes	NIPDAU	Level-1-260C-UNLIM	-40 to 125	VULI
TLV713285PDBVT	Active	Production	SOT-23 (DBV) 5	250 SMALL T&R	Yes	NIPDAU SN	Level-1-260C-UNLIM	-40 to 125	VULI
TLV713285PDBVT.A	Active	Production	SOT-23 (DBV) 5	250 SMALL T&R	Yes	NIPDAU	Level-1-260C-UNLIM	-40 to 125	VULI
TLV713285PDQNR	Active	Production	X2SON (DQN) 4	3000 LARGE T&R	Yes	NIPDAU	Level-1-260C-UNLIM	-40 to 125	A2
TLV713285PDQNR.A	Active	Production	X2SON (DQN) 4	3000 LARGE T&R	Yes	NIPDAU	Level-1-260C-UNLIM	-40 to 125	A2
TLV713285PDQNRG4	Active	Production	X2SON (DQN) 4	3000 LARGE T&R	Yes	NIPDAU	Level-1-260C-UNLIM	-40 to 125	A2
TLV713285PDQNRG4.A	Active	Production	X2SON (DQN) 4	3000 LARGE T&R	Yes	NIPDAU	Level-1-260C-UNLIM	-40 to 125	A2
TLV713285PDQNT	Active	Production	X2SON (DQN) 4	250 SMALL T&R	Yes	NIPDAU	Level-1-260C-UNLIM	-40 to 125	A2
TLV713285PDQNT.A	Active	Production	X2SON (DQN) 4	250 SMALL T&R	Yes	NIPDAU	Level-1-260C-UNLIM	-40 to 125	A2
TLV71328PDBVR	Active	Production	SOT-23 (DBV) 5	3000 LARGE T&R	Yes	NIPDAU SN	Level-1-260C-UNLIM	-40 to 125	VUKI
TLV71328PDBVR.A	Active	Production	SOT-23 (DBV) 5	3000 LARGE T&R	Yes	NIPDAU	Level-1-260C-UNLIM	-40 to 125	VUKI
TLV71328PDBVT	Active	Production	SOT-23 (DBV) 5	250 SMALL T&R	Yes	NIPDAU SN	Level-1-260C-UNLIM	-40 to 125	VUKI
TLV71328PDBVT.A	Active	Production	SOT-23 (DBV) 5	250 SMALL T&R	Yes	NIPDAU	Level-1-260C-UNLIM	-40 to 125	VUKI
TLV71328PDQNR	Active	Production	X2SON (DQN) 4	3000 LARGE T&R	Yes	NIPDAU	Level-1-260C-UNLIM	-40 to 125	AK
TLV71328PDQNR.A	Active	Production	X2SON (DQN) 4	3000 LARGE T&R	Yes	NIPDAU	Level-1-260C-UNLIM	-40 to 125	AK
TLV71328PDQNRG4	Active	Production	X2SON (DQN) 4	3000 LARGE T&R	Yes	NIPDAU	Level-1-260C-UNLIM	-40 to 125	AK
TLV71328PDQNRG4.A	Active	Production	X2SON (DQN) 4	3000 LARGE T&R	Yes	NIPDAU	Level-1-260C-UNLIM	-40 to 125	AK
TLV71328PDQNT	Active	Production	X2SON (DQN) 4	250 SMALL T&R	Yes	NIPDAU	Level-1-260C-UNLIM	-40 to 125	AK
TLV71328PDQNT.A	Active	Production	X2SON (DQN) 4	250 SMALL T&R	Yes	NIPDAU	Level-1-260C-UNLIM	-40 to 125	AK
TLV71330PDBVR	Active	Production	SOT-23 (DBV) 5	3000 LARGE T&R	Yes	NIPDAU SN	Level-1-260C-UNLIM	-40 to 125	VUMI
TLV71330PDBVR.A	Active	Production	SOT-23 (DBV) 5	3000 LARGE T&R	Yes	SN	Level-1-260C-UNLIM	-40 to 125	VUMI
TLV71330PDBVT	Active	Production	SOT-23 (DBV) 5	250 SMALL T&R	Yes	NIPDAU SN	Level-1-260C-UNLIM	-40 to 125	VUMI
TLV71330PDBVT.A	Active	Production	SOT-23 (DBV) 5	250 SMALL T&R	Yes	NIPDAU	Level-1-260C-UNLIM	-40 to 125	VUMI
TLV71330PDQNR	Active	Production	X2SON (DQN) 4	3000 LARGE T&R	Yes	NIPDAU	Level-1-260C-UNLIM	-40 to 125	AL
TLV71330PDQNR.A	Active	Production	X2SON (DQN) 4	3000 LARGE T&R	Yes	NIPDAU	Level-1-260C-UNLIM	-40 to 125	AL
TLV71330PDQNT	Active	Production	X2SON (DQN) 4	250 SMALL T&R	Yes	NIPDAU	Level-1-260C-UNLIM	-40 to 125	AL

Orderable part number	Status (1)	Material type (2)	Package Pins	Package qty Carrier	RoHS (3)	Lead finish/ Ball material (4)	MSL rating/ Peak reflow (5)	Op temp (°C)	Part marking (6)
TLV71330PDQNT.A	Active	Production	X2SON (DQN) 4	250 SMALL T&R	Yes	NIPDAU	Level-1-260C-UNLIM	-40 to 125	AL
TLV71333PDBVR	Active	Production	SOT-23 (DBV) 5	3000 LARGE T&R	Yes	NIPDAU SN	Level-1-260C-UNLIM	-40 to 125	VUFI
TLV71333PDBVR.A	Active	Production	SOT-23 (DBV) 5	3000 LARGE T&R	Yes	NIPDAU	Level-1-260C-UNLIM	-40 to 125	VUFI
TLV71333PDBVRG4	Active	Production	SOT-23 (DBV) 5	3000 LARGE T&R	Yes	NIPDAU	Level-1-260C-UNLIM	-40 to 125	VUFI
TLV71333PDBVRG4.A	Active	Production	SOT-23 (DBV) 5	3000 LARGE T&R	Yes	NIPDAU	Level-1-260C-UNLIM	-40 to 125	VUFI
TLV71333PDBVT	Active	Production	SOT-23 (DBV) 5	250 SMALL T&R	Yes	NIPDAU SN	Level-1-260C-UNLIM	-40 to 125	VUFI
TLV71333PDBVT.A	Active	Production	SOT-23 (DBV) 5	250 SMALL T&R	Yes	NIPDAU	Level-1-260C-UNLIM	-40 to 125	VUFI
TLV71333PDQNR	Active	Production	X2SON (DQN) 4	3000 LARGE T&R	Yes	NIPDAU	Level-1-260C-UNLIM	-40 to 125	AH
TLV71333PDQNR.A	Active	Production	X2SON (DQN) 4	3000 LARGE T&R	Yes	NIPDAU	Level-1-260C-UNLIM	-40 to 125	AH
TLV71333PDQNT	Active	Production	X2SON (DQN) 4	250 SMALL T&R	Yes	NIPDAU	Level-1-260C-UNLIM	-40 to 125	AH
TLV71333PDQNT.A	Active	Production	X2SON (DQN) 4	250 SMALL T&R	Yes	NIPDAU	Level-1-260C-UNLIM	-40 to 125	AH

(1) **Status:** For more details on status, see our [product life cycle](#).

(2) **Material type:** When designated, preproduction parts are prototypes/experimental devices, and are not yet approved or released for full production. Testing and final process, including without limitation quality assurance, reliability performance testing, and/or process qualification, may not yet be complete, and this item is subject to further changes or possible discontinuation. If available for ordering, purchases will be subject to an additional waiver at checkout, and are intended for early internal evaluation purposes only. These items are sold without warranties of any kind.

(3) **RoHS values:** Yes, No, RoHS Exempt. See the [TI RoHS Statement](#) for additional information and value definition.

(4) **Lead finish/Ball material:** Parts may have multiple material finish options. Finish options are separated by a vertical ruled line. Lead finish/Ball material values may wrap to two lines if the finish value exceeds the maximum column width.

(5) **MSL rating/Peak reflow:** The moisture sensitivity level ratings and peak solder (reflow) temperatures. In the event that a part has multiple moisture sensitivity ratings, only the lowest level per JEDEC standards is shown. Refer to the shipping label for the actual reflow temperature that will be used to mount the part to the printed circuit board.

(6) **Part marking:** There may be an additional marking, which relates to the logo, the lot trace code information, or the environmental category of the part.

Multiple part markings will be inside parentheses. Only one part marking contained in parentheses and separated by a "-" will appear on a part. If a line is indented then it is a continuation of the previous line and the two combined represent the entire part marking for that device.

Important Information and Disclaimer: The information provided on this page represents TI's knowledge and belief as of the date that it is provided. TI bases its knowledge and belief on information provided by third parties, and makes no representation or warranty as to the accuracy of such information. Efforts are underway to better integrate information from third parties. TI has taken and continues to take reasonable steps to provide representative

and accurate information but may not have conducted destructive testing or chemical analysis on incoming materials and chemicals. TI and TI suppliers consider certain information to be proprietary, and thus CAS numbers and other limited information may not be available for release.

In no event shall TI's liability arising out of such information exceed the total purchase price of the TI part(s) at issue in this document sold by TI to Customer on an annual basis.

OTHER QUALIFIED VERSIONS OF TLV713P :

- Automotive : [TLV713P-Q1](#)

NOTE: Qualified Version Definitions:

- Automotive - Q100 devices qualified for high-reliability automotive applications targeting zero defects

TAPE AND REEL INFORMATION



QUADRANT ASSIGNMENTS FOR PIN 1 ORIENTATION IN TAPE

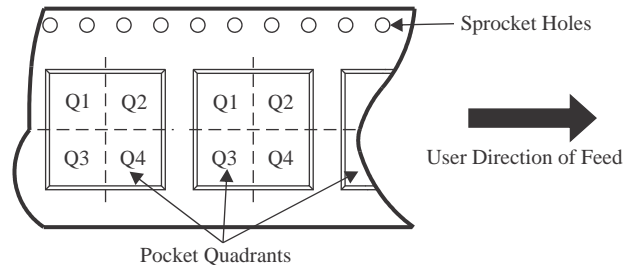

*All dimensions are nominal

Device	Package Type	Package Drawing	Pins	SPQ	Reel Diameter (mm)	Reel Width W1 (mm)	A0 (mm)	B0 (mm)	K0 (mm)	P1 (mm)	W (mm)	Pin1 Quadrant
TLV71310PDBVR	SOT-23	DBV	5	3000	180.0	8.4	3.2	3.2	1.4	4.0	8.0	Q3
TLV71310PDBVT	SOT-23	DBV	5	250	180.0	8.4	3.2	3.2	1.4	4.0	8.0	Q3
TLV71310PDQNR	X2SON	DQN	4	3000	180.0	8.4	1.16	1.16	0.5	4.0	8.0	Q2
TLV71310PDQNT	X2SON	DQN	4	250	180.0	8.4	1.16	1.16	0.5	4.0	8.0	Q2
TLV71311PDBVR	SOT-23	DBV	5	3000	178.0	8.4	3.2	3.2	1.4	4.0	8.0	Q3
TLV71311PDBVT	SOT-23	DBV	5	250	180.0	8.4	3.2	3.2	1.4	4.0	8.0	Q3
TLV71312PDBVR	SOT-23	DBV	5	3000	180.0	8.4	3.2	3.2	1.4	4.0	8.0	Q3
TLV71312PDBVT	SOT-23	DBV	5	250	180.0	8.4	3.2	3.2	1.4	4.0	8.0	Q3
TLV71312PDBVTG4	SOT-23	DBV	5	250	180.0	8.4	3.2	3.2	1.4	4.0	8.0	Q3
TLV71312PDQNR	X2SON	DQN	4	3000	180.0	8.4	1.16	1.16	0.5	4.0	8.0	Q2
TLV71312PDQNT	X2SON	DQN	4	250	180.0	8.4	1.16	1.16	0.5	4.0	8.0	Q2
TLV71315PDBVR	SOT-23	DBV	5	3000	180.0	8.4	3.2	3.2	1.4	4.0	8.0	Q3
TLV71315PDBVT	SOT-23	DBV	5	250	180.0	8.4	3.2	3.2	1.4	4.0	8.0	Q3
TLV71315PDQNR	X2SON	DQN	4	3000	180.0	8.4	1.16	1.16	0.5	4.0	8.0	Q2
TLV71315PDQNT	X2SON	DQN	4	250	180.0	8.4	1.16	1.16	0.5	4.0	8.0	Q2
TLV713185PDBVR	SOT-23	DBV	5	3000	180.0	8.4	3.2	3.2	1.4	4.0	8.0	Q3

Device	Package Type	Package Drawing	Pins	SPQ	Reel Diameter (mm)	Reel Width W1 (mm)	A0 (mm)	B0 (mm)	K0 (mm)	P1 (mm)	W (mm)	Pin1 Quadrant
TLV713185PDBVT	SOT-23	DBV	5	250	180.0	8.4	3.2	3.2	1.4	4.0	8.0	Q3
TLV713185PDQNR	X2SON	DQN	4	3000	180.0	8.4	1.16	1.16	0.5	4.0	8.0	Q2
TLV713185PDQNT	X2SON	DQN	4	250	180.0	8.4	1.16	1.16	0.5	4.0	8.0	Q2
TLV71318PDBVR	SOT-23	DBV	5	3000	178.0	8.4	3.2	3.2	1.4	4.0	8.0	Q3
TLV71318PDBVRG4	SOT-23	DBV	5	3000	180.0	8.4	3.2	3.2	1.4	4.0	8.0	Q3
TLV71318PDBVT	SOT-23	DBV	5	250	180.0	8.4	3.2	3.2	1.4	4.0	8.0	Q3
TLV71318PDQNR	X2SON	DQN	4	3000	180.0	8.4	1.16	1.16	0.5	4.0	8.0	Q2
TLV71318PDQNT	X2SON	DQN	4	250	180.0	8.4	1.16	1.16	0.5	4.0	8.0	Q2
TLV71320DQNR	X2SON	DQN	4	3000	180.0	8.4	1.16	1.16	0.5	4.0	8.0	Q2
TLV71320DQNT	X2SON	DQN	4	250	180.0	8.4	1.16	1.16	0.5	4.0	8.0	Q2
TLV71325PDBVR	SOT-23	DBV	5	3000	180.0	8.4	3.2	3.2	1.4	4.0	8.0	Q3
TLV71325PDBVRG4	SOT-23	DBV	5	3000	180.0	8.4	3.2	3.2	1.4	4.0	8.0	Q3
TLV71325PDBVT	SOT-23	DBV	5	250	180.0	8.4	3.2	3.2	1.4	4.0	8.0	Q3
TLV71325PDQNR	X2SON	DQN	4	3000	180.0	8.4	1.16	1.16	0.5	4.0	8.0	Q2
TLV71325PDQNT	X2SON	DQN	4	250	180.0	8.4	1.16	1.16	0.5	4.0	8.0	Q2
TLV713285PDBVR	SOT-23	DBV	5	3000	180.0	8.4	3.2	3.2	1.4	4.0	8.0	Q3
TLV713285PDBVRG4	SOT-23	DBV	5	3000	180.0	8.4	3.2	3.2	1.4	4.0	8.0	Q3
TLV713285PDBVT	SOT-23	DBV	5	250	180.0	8.4	3.2	3.2	1.4	4.0	8.0	Q3
TLV713285PDQNR	X2SON	DQN	4	3000	180.0	8.4	1.16	1.16	0.5	4.0	8.0	Q2
TLV713285PDQNRG4	X2SON	DQN	4	3000	180.0	8.4	1.16	1.16	0.5	4.0	8.0	Q2
TLV713285PDQNT	X2SON	DQN	4	250	180.0	8.4	1.16	1.16	0.5	4.0	8.0	Q2
TLV71328PDBVR	SOT-23	DBV	5	3000	180.0	8.4	3.2	3.2	1.4	4.0	8.0	Q3
TLV71328PDBVT	SOT-23	DBV	5	250	180.0	8.4	3.2	3.2	1.4	4.0	8.0	Q3
TLV71328PDQNR	X2SON	DQN	4	3000	180.0	8.4	1.16	1.16	0.5	4.0	8.0	Q2
TLV71328PDQNRG4	X2SON	DQN	4	3000	180.0	8.4	1.16	1.16	0.5	4.0	8.0	Q2
TLV71328PDQNT	X2SON	DQN	4	250	180.0	8.4	1.16	1.16	0.5	4.0	8.0	Q2
TLV71330PDBVR	SOT-23	DBV	5	3000	180.0	8.4	3.2	3.2	1.4	4.0	8.0	Q3
TLV71330PDBVR	SOT-23	DBV	5	3000	180.0	8.4	3.2	3.2	1.4	4.0	8.0	Q3
TLV71330PDBVT	SOT-23	DBV	5	250	180.0	8.4	3.2	3.2	1.4	4.0	8.0	Q3
TLV71330PDQNR	X2SON	DQN	4	3000	180.0	8.4	1.16	1.16	0.5	4.0	8.0	Q2
TLV71330PDQNT	X2SON	DQN	4	250	180.0	8.4	1.16	1.16	0.5	4.0	8.0	Q2
TLV71333PDBVR	SOT-23	DBV	5	3000	180.0	8.4	3.2	3.2	1.4	4.0	8.0	Q3
TLV71333PDBVRG4	SOT-23	DBV	5	3000	180.0	8.4	3.2	3.2	1.4	4.0	8.0	Q3
TLV71333PDBVT	SOT-23	DBV	5	250	180.0	8.4	3.2	3.2	1.4	4.0	8.0	Q3
TLV71333PDQNR	X2SON	DQN	4	3000	180.0	8.4	1.16	1.16	0.5	4.0	8.0	Q2
TLV71333PDQNT	X2SON	DQN	4	250	180.0	8.4	1.16	1.16	0.5	4.0	8.0	Q2

TAPE AND REEL BOX DIMENSIONS

*All dimensions are nominal

Device	Package Type	Package Drawing	Pins	SPQ	Length (mm)	Width (mm)	Height (mm)
TLV71310PDBVR	SOT-23	DBV	5	3000	210.0	185.0	35.0
TLV71310PDBVT	SOT-23	DBV	5	250	210.0	185.0	35.0
TLV71310PDQNR	X2SON	DQN	4	3000	210.0	185.0	35.0
TLV71310PDQNT	X2SON	DQN	4	250	210.0	185.0	35.0
TLV71311PDBVR	SOT-23	DBV	5	3000	208.0	191.0	35.0
TLV71311PDBVT	SOT-23	DBV	5	250	210.0	185.0	35.0
TLV71312PDBVR	SOT-23	DBV	5	3000	210.0	185.0	35.0
TLV71312PDBVT	SOT-23	DBV	5	250	210.0	185.0	35.0
TLV71312PDBVTG4	SOT-23	DBV	5	250	210.0	185.0	35.0
TLV71312PDQNR	X2SON	DQN	4	3000	210.0	185.0	35.0
TLV71312PDQNT	X2SON	DQN	4	250	210.0	185.0	35.0
TLV71315PDBVR	SOT-23	DBV	5	3000	210.0	185.0	35.0
TLV71315PDBVT	SOT-23	DBV	5	250	210.0	185.0	35.0
TLV71315PDQNR	X2SON	DQN	4	3000	210.0	185.0	35.0
TLV71315PDQNT	X2SON	DQN	4	250	210.0	185.0	35.0
TLV713185PDBVR	SOT-23	DBV	5	3000	210.0	185.0	35.0
TLV713185PDBVT	SOT-23	DBV	5	250	210.0	185.0	35.0
TLV713185PDQNR	X2SON	DQN	4	3000	210.0	185.0	35.0

Device	Package Type	Package Drawing	Pins	SPQ	Length (mm)	Width (mm)	Height (mm)
TLV713185PDQNT	X2SON	DQN	4	250	210.0	185.0	35.0
TLV71318PDBVR	SOT-23	DBV	5	3000	208.0	191.0	35.0
TLV71318PDBVRG4	SOT-23	DBV	5	3000	210.0	185.0	35.0
TLV71318PDBVT	SOT-23	DBV	5	250	210.0	185.0	35.0
TLV71318PDQNR	X2SON	DQN	4	3000	210.0	185.0	35.0
TLV71318PDQNT	X2SON	DQN	4	250	210.0	185.0	35.0
TLV71320DQNR	X2SON	DQN	4	3000	210.0	185.0	35.0
TLV71320DQNT	X2SON	DQN	4	250	210.0	185.0	35.0
TLV71325PDBVR	SOT-23	DBV	5	3000	210.0	185.0	35.0
TLV71325PDBVRG4	SOT-23	DBV	5	3000	210.0	185.0	35.0
TLV71325PDBVT	SOT-23	DBV	5	250	210.0	185.0	35.0
TLV71325PDQNR	X2SON	DQN	4	3000	210.0	185.0	35.0
TLV71325PDQNT	X2SON	DQN	4	250	210.0	185.0	35.0
TLV713285PDBVR	SOT-23	DBV	5	3000	210.0	185.0	35.0
TLV713285PDBVRG4	SOT-23	DBV	5	3000	210.0	185.0	35.0
TLV713285PDBVT	SOT-23	DBV	5	250	210.0	185.0	35.0
TLV713285PDQNR	X2SON	DQN	4	3000	210.0	185.0	35.0
TLV713285PDQNRG4	X2SON	DQN	4	3000	210.0	185.0	35.0
TLV713285PDQNT	X2SON	DQN	4	250	210.0	185.0	35.0
TLV71328PDBVR	SOT-23	DBV	5	3000	210.0	185.0	35.0
TLV71328PDBVT	SOT-23	DBV	5	250	210.0	185.0	35.0
TLV71328PDQNR	X2SON	DQN	4	3000	210.0	185.0	35.0
TLV71328PDQNRG4	X2SON	DQN	4	3000	210.0	185.0	35.0
TLV71328PDQNT	X2SON	DQN	4	250	210.0	185.0	35.0
TLV71330PDBVR	SOT-23	DBV	5	3000	210.0	185.0	35.0
TLV71330PDBVR	SOT-23	DBV	5	3000	210.0	185.0	35.0
TLV71330PDBVT	SOT-23	DBV	5	250	210.0	185.0	35.0
TLV71330PDQNR	X2SON	DQN	4	3000	210.0	185.0	35.0
TLV71330PDQNT	X2SON	DQN	4	250	210.0	185.0	35.0
TLV71333PDBVR	SOT-23	DBV	5	3000	210.0	185.0	35.0
TLV71333PDBVRG4	SOT-23	DBV	5	3000	210.0	185.0	35.0
TLV71333PDBVT	SOT-23	DBV	5	250	210.0	185.0	35.0
TLV71333PDQNR	X2SON	DQN	4	3000	210.0	185.0	35.0
TLV71333PDQNT	X2SON	DQN	4	250	210.0	185.0	35.0

EXAMPLE BOARD LAYOUT

DBV0005A

SOT-23 - 1.45 mm max height

SMALL OUTLINE TRANSISTOR



LAND PATTERN EXAMPLE
EXPOSED METAL SHOWN
SCALE:15X



SOLDER MASK DETAILS

4214839/K 08/2024

NOTES: (continued)

- 6. Publication IPC-7351 may have alternate designs.
- 7. Solder mask tolerances between and around signal pads can vary based on board fabrication site.

EXAMPLE STENCIL DESIGN

DBV0005A

SOT-23 - 1.45 mm max height

SMALL OUTLINE TRANSISTOR



SOLDER PASTE EXAMPLE
BASED ON 0.125 mm THICK STENCIL
SCALE:15X

4214839/K 08/2024

NOTES: (continued)

8. Laser cutting apertures with trapezoidal walls and rounded corners may offer better paste release. IPC-7525 may have alternate design recommendations.
9. Board assembly site may have different recommendations for stencil design.

GENERIC PACKAGE VIEW

DQN 4

X2SON - 0.4 mm max height

PLASTIC SMALL OUTLINE - NO LEAD



Images above are just a representation of the package family, actual package may vary.
Refer to the product data sheet for package details.

4210367/F



LAND PATTERN EXAMPLE
SCALE: 40X



SOLDER MASK DETAIL

4215302/E 12/2016

NOTES: (continued)

7. This package is designed to be soldered to a thermal pad on the board. For more information, see Texas Instruments literature number SLUA271 (www.ti.com/lit/sluea271).
8. If any vias are implemented, it is recommended that vias under paste be filled, plugged or tented.



SOLDER PASTE EXAMPLE
 BASED ON 0.075 - 0.1mm THICK STENCIL
 EXPOSED PAD
 88% PRINTED SOLDER COVERAGE BY AREA
 SCALE: 60X

4215302/E 12/2016

NOTES: (continued)

- 9. Laser cutting apertures with trapezoidal walls and rounded corners may offer better paste release. IPC-7525 may have alternate design recommendations.

重要通知和免责声明

TI“按原样”提供技术和可靠性数据（包括数据表）、设计资源（包括参考设计）、应用或其他设计建议、网络工具、安全信息和其他资源，不保证没有瑕疵且不做任何明示或暗示的担保，包括但不限于对适销性、与某特定用途的适用性或不侵犯任何第三方知识产权的暗示担保。

这些资源可供使用 TI 产品进行设计的熟练开发人员使用。您将自行承担以下全部责任：(1) 针对您的应用选择合适的 TI 产品，(2) 设计、验证并测试您的应用，(3) 确保您的应用满足相应标准以及任何其他安全、安保法规或其他要求。

这些资源如有变更，恕不另行通知。TI 授权您仅可将这些资源用于研发本资源所述的 TI 产品的相关应用。严禁以其他方式对这些资源进行复制或展示。您无权使用任何其他 TI 知识产权或任何第三方知识产权。对于因您对这些资源的使用而对 TI 及其代表造成的任何索赔、损害、成本、损失和债务，您将全额赔偿，TI 对此概不负责。

TI 提供的产品受 [TI 销售条款](#)、[TI 通用质量指南](#) 或 [ti.com](#) 上其他适用条款或 TI 产品随附的其他适用条款的约束。TI 提供这些资源并不会扩展或以其他方式更改 TI 针对 TI 产品发布的适用的担保或担保免责声明。除非德州仪器 (TI) 明确将某产品指定为定制产品或客户特定产品，否则其产品均为按确定价格收入目录的标准通用器件。

TI 反对并拒绝您可能提出的任何其他或不同的条款。

版权所有 © 2026，德州仪器 (TI) 公司

最后更新日期：2025 年 10 月