

FEATURES

- Low Supply Current...20 μ A Typ
- Single Power Supply
- Rail-to-Rail Common-Mode Input Voltage Range
- Push-Pull Output Circuit
- Low Input-Bias Current

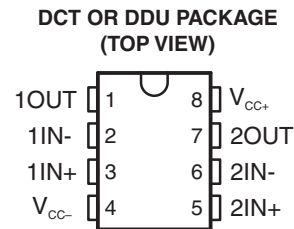

APPLICATIONS

- Battery Packs for Sensing Battery Voltage
- MP3 Players, Digital Cameras, PMPs
- Cellular Phones, PDAs, Notebook Computers
- Test Equipment
- General-Purpose Low-Voltage Applications

DESCRIPTION/ORDERING INFORMATION

The TLV7256 is a CMOS-type general-purpose dual comparator capable of single power-supply operation and using lower supply currents than the conventional bipolar comparators. Its push-pull output can connect directly to local ICs such as TTL and CMOS circuits.

ORDERING INFORMATION⁽¹⁾

T_A	PACKAGE ⁽²⁾		ORDERABLE PART NUMBER	TOP-SIDE MARKING
-40°C to 85°C	SSOP – DCT	Reel of 3000	TLV7256IDCTR	PREVIEW
		Reel of 250	TLV7256IDCTT	
	VSSOP – DDU	Reel of 3000	TLV7256IDDUR	YAUA

- (1) For the most current package and ordering information, see the Package Option Addendum at the end of this document, or see the TI web site at www.ti.com.
 (2) Package drawings, standard packing quantities, thermal data, symbolization, and PCB design guidelines are available at www.ti.com/sc/package.

Typical Application Circuit

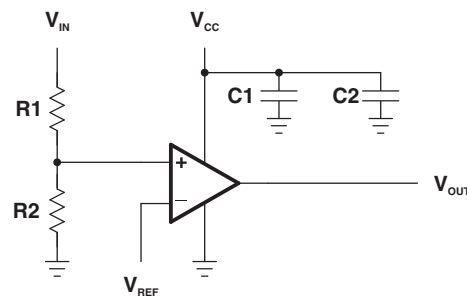

Figure 1. Threshold Detector



Please be aware that an important notice concerning availability, standard warranty, and use in critical applications of Texas Instruments semiconductor products and disclaimers thereto appears at the end of this data sheet.

TLV7256 DUAL COMPARATOR

SLCS147A–OCTOBER 2006–REVISED JANUARY 2007

Absolute Maximum Ratings⁽¹⁾

over operating free-air temperature range (unless otherwise noted)

		MIN	MAX	UNIT
V _{CC}	Supply voltage	1.5	7	V
V _{ID}	Differential input voltage			V
V _I	Input voltage	V _{CC-}	V _{CC+}	V
I _O	Output current		±35	mA
θ _{JA}	Thermal resistance, junction to ambient ⁽²⁾	DCT package	220	°C/W
		DDU package	227	
P _D	Power dissipation	DCT package	250	mW
		DDU package	200	
T _A	Operating free-air temperature range	–40	85	°C
T _{stg}	Storage temperature range	–55	125	°C

(1) Stresses beyond those listed under *absolute maximum ratings* may cause permanent damage to the device. These are stress ratings only, and functional operation of the device at these or any other conditions beyond those indicated under *recommended operating conditions* is not implied. Exposure to absolute-maximum-rated conditions for extended periods may affect device reliability.

(2) Package thermal impedance is calculated according to JESD 51-7.

Recommended Operating Conditions

		MIN	MAX	UNIT
V _{CC}	Supply voltage	1.8	5	V
T _A	Operating free-air temperature	–40	85	°C

Electrical Characteristics
 $V_{CC+} = 5\text{ V}$, $V_{CC-} = \text{GND}$, $T_A = 25^\circ\text{C}$ (unless otherwise noted)

PARAMETER		TEST CONDITIONS	T_A	MIN	TYP	MAX	UNIT	
V_{IO}	Input offset voltage		25°C		±2	±7	mV	
			–40°C to 85°C			±8		
I_{IO}	Input offset current		25°C		2		pA	
I_I	Input bias current		25°C		4		pA	
V_{CM}	Common-mode input voltage		25°C	0		V_{CC}	V	
CMRR	Common-mode rejection ratio	$\Delta V_{CM} = 5\text{ V}$	25°C	48	65		dB	
		$0 \leq V_{CM} \leq 5\text{ V}$	–40°C to 85°C	48				
I_{CC}	Supply current	Output = High, $V_{IN} = 5\text{ V}$	25°C		37	51	μA	
		Output = Low, $V_{IN} = 5\text{ V}$			40	60		
		Output = High, $V_{IN} = 5\text{ V}$	–40°C to 85°C			61		
		Output = Low, $V_{IN} = 5\text{ V}$				70		
		Output = High, $V_{IN} = 2.5\text{ V}$	25°C		20	32		
		Output = Low, $V_{IN} = 2.5\text{ V}$			26	42		
		Output = High, $V_{IN} = 2.5\text{ V}$	–40°C to 85°C			40		
		Output = Low, $V_{IN} = 2.5\text{ V}$				53		
A_{VD}	Voltage gain	$V_D = 3\text{ V}$, $1\text{ V} \leq V_{OUT} \leq 4\text{ V}$	25°C		88		dB	
I_{sink}	Sink current	$V_{OL} = 0.5\text{ V}$	25°C	25	33		mA	
			–40°C to 85°C	20				
I_{source}	Source current	$V_{OH} = 4.5\text{ V}$	25°C	30	35		mA	
			–40°C to 85°C	25				
V_{OL}	Low-level output voltage	$I_{sink} = 5\text{ mA}$	25°C		0.07	0.12	V	
			–40°C to 85°C			0.20		
V_{OH}	High-level output voltage	$I_{source} = 5\text{ mA}$	25°C	4.9	4.93		V	
			–40°C to 85°C	4.85				

TLV7256 DUAL COMPARATOR

SLCS147A–OCTOBER 2006–REVISED JANUARY 2007

Electrical Characteristics

$V_{CC+} = 2.7\text{ V}$, $V_{CC-} = \text{GND}$, $T_A = 25^\circ\text{C}$ (unless otherwise noted)

PARAMETER		TEST CONDITIONS	T_A	MIN	TYP	MAX	UNIT	
V_{IO}	Input offset voltage		25°C		±2	±8	mV	
			–40°C to 85°C			±9		
I_{IO}	Input offset current		25°C		2		pA	
I_I	Input bias current		25°C		4		pA	
V_{CM}	Common-mode input voltage		25°C	0		V_{CC}	V	
CMRR	Common-mode rejection ratio	$\Delta V_{CM} = 2.7\text{ V}$	25°C	42	57		dB	
		$0 \leq V_{CM} \leq 2.7\text{ V}$	–40°C to 85°C	42				
I_{CC}	Supply current	Output = High, $V_{IN} = 2.7\text{ V}$	25°C		30	55	μA	
		Output = Low, $V_{IN} = 2.7\text{ V}$			36	55		
		Output = High, $V_{IN} = 2.7\text{ V}$	–40°C to 85°C			65		
		Output = Low, $V_{IN} = 2.7\text{ V}$				65		
		Output = High, $V_{IN} = 1.35\text{ V}$	25°C		30	48		
		Output = Low, $V_{IN} = 1.35\text{ V}$			35	55		
		Output = High, $V_{IN} = 1.35\text{ V}$	–40°C to 85°C			55		
		Output = Low, $V_{IN} = 1.35\text{ V}$				65		
A_{VD}	Voltage gain	$V_D = 1.7\text{ V}$, $0.5\text{ V} \leq V_{OUT} \leq 2.2\text{ V}$	25°C		88		dB	
I_{sink}	Sink current	$V_{OL} = 0.5\text{ V}$	25°C	13	18		mA	
			–40°C to 85°C	11				
I_{source}	Source current	$V_{OH} = 2.2\text{ V}$	25°C	15	20		mA	
			–40°C to 85°C	13				
V_{OL}	Low-level output voltage	$I_{sink} = 5\text{ mA}$	25°C		0.11	0.16	V	
			–40°C to 85°C			0.19		
V_{OH}	High-level output voltage	$I_{source} = 5\text{ mA}$	25°C	2.54	2.60		V	
			–40°C to 85°C	2.45				

Electrical Characteristics

$V_{CC+} = 1.8\text{ V}$, $V_{CC-} = \text{GND}$, $T_A = 25^\circ\text{C}$ (unless otherwise noted)

PARAMETER		TEST CONDITIONS	T_A	MIN	TYP	MAX	UNIT	
V_{IO}	Input offset voltage		25°C		±2	±8	mV	
			-40°C to 85°C			±9		
I_{IO}	Input offset current		25°C		2		pA	
I_I	Input bias current		25°C		4		pA	
V_{CM}	Common-mode input voltage		25°C	0		$V_{CC} - 0.3$	V	
CMRR	Common-mode rejection ratio	$\Delta V_{CM} = 5\text{ V}$	25°C	40	55		dB	
		$0 \leq V_{CM} \leq 5\text{ V}$	-40°C to 85°C	40				
I_{CC}	Supply current	Output = High, $V_{IN} = 1.8\text{ V}$	25°C		30	55	μA	
		Output = Low, $V_{IN} = 1.8\text{ V}$			33	47		
		Output = High, $V_{IN} = 1.8\text{ V}$	-40°C to 85°C			60		
		Output = Low, $V_{IN} = 1.8\text{ V}$				51		
		Output = High, $V_{IN} = 0.9\text{ V}$	25°C		20	32		
		Output = Low, $V_{IN} = 0.9\text{ V}$			25	37		
		Output = High, $V_{IN} = 0.9\text{ V}$	-40°C to 85°C			34		
		Output = Low, $V_{IN} = 0.9\text{ V}$				40		
A_{VD}	Voltage gain	$V_D = 1.1\text{ V}$, $0.4\text{ V} \leq V_{OUT} \leq 1.5\text{ V}$	25°C		88		dB	
I_{sink}	Sink current	$V_{OL} = 0.5\text{ V}$	25°C	6	9		mA	
			-40°C to 85°C	5				
I_{source}	Source current	$V_{OH} = 2.2\text{ V}$	25°C	5	9		mA	
			-40°C to 85°C	4				
V_{OL}	Low-level output voltage	$I_{sink} = 5\text{ mA}$	25°C		0.2	0.34	V	
			-40°C to 85°C			0.39		
V_{OH}	High-level output voltage	$I_{source} = 5\text{ mA}$	25°C	1.3	1.6		V	
			-40°C to 85°C	1.2				

Switching Characteristics

$V_{CC+} = 5\text{ V}$, $V_{CC-} = \text{GND}$, $T_A = 25^\circ\text{C}$ (unless otherwise noted)

PARAMETER		TEST CONDITIONS	TYP	UNIT
t_{PLH}	Propagation delay time (turn on)	Overdrive = 100 mV	680	ns
		TTL step input	500	
t_{PHL}	Propagation delay time (turn off)	Overdrive = 100 mV	250	ns
		TTL step input	380	
t_{TLH}	Response time	Overdrive = 100 mV	60	ns
t_{THL}			8	

Switching Characteristics

$V_{CC+} = 3\text{ V}$, $V_{CC-} = \text{GND}$, $T_A = 25^\circ\text{C}$ (unless otherwise noted)

PARAMETER		TEST CONDITIONS	TYP	UNIT
t_{PLH}	Propagation delay time (turn on)	Overdrive = 100 mV	550	ns
t_{PHL}	Propagation delay time (turn off)	Overdrive = 100 mV	250	ns
t_{TLH}	Response time	Overdrive = 100 mV	30	ns
t_{THL}			8	

TYPICAL CHARACTERISTICS

SUPPLY CURRENT
VS
FREQUENCY
 $V_{CC} = 5\text{ V}$

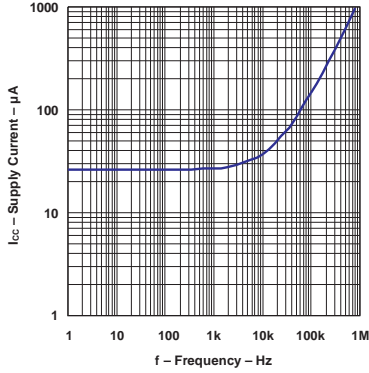

SUPPLY CURRENT
VS
FREQUENCY
 $V_{CC} = 2.7\text{ V}$

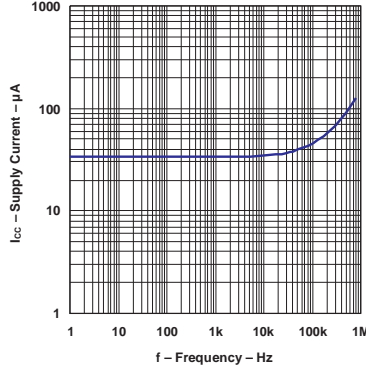

SUPPLY CURRENT
VS
FREQUENCY
 $V_{CC} = 1.8\text{ V}$

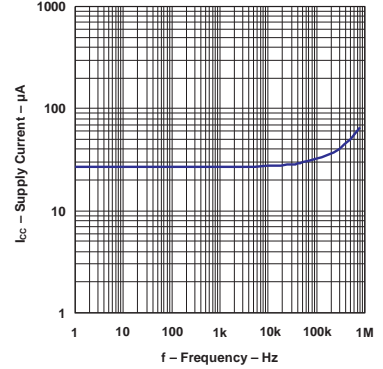

SUPPLY CURRENT
VS
COMMON-MODE VOLTAGE
 $V_{CC} = \pm 2.5\text{ V}$

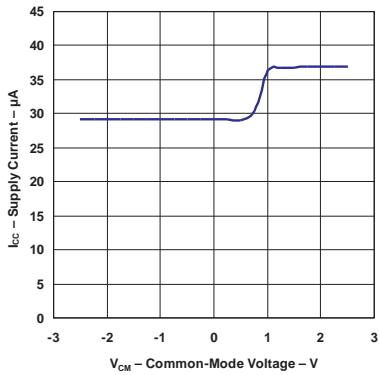

SUPPLY CURRENT
VS
COMMON-MODE VOLTAGE
 $V_{CC} = \pm 1.35\text{ V}$

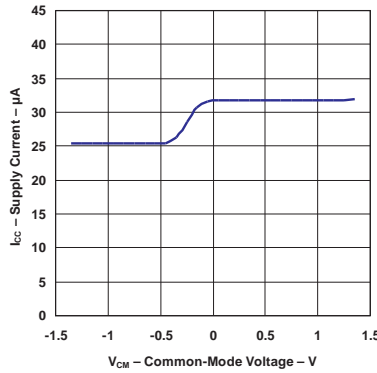

SUPPLY CURRENT
VS
COMMON-MODE VOLTAGE
 $V_{CC} = \pm 0.9\text{ V}$

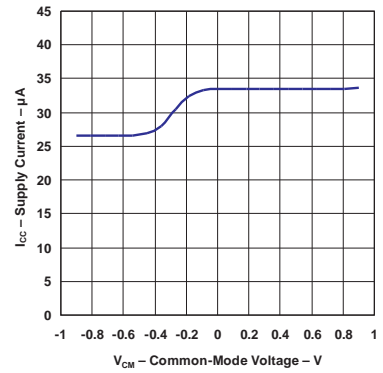

PROPAGATION DELAY TIME,
HIGH TO LOW
 $V_{CC} = 5\text{ V}$

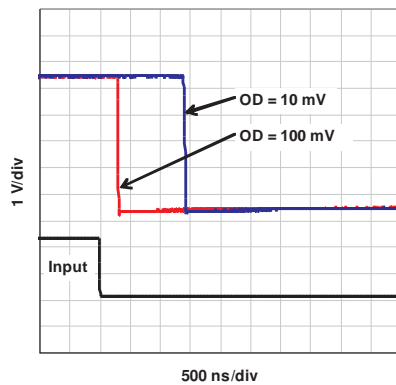

PROPAGATION DELAY TIME,
HIGH TO LOW
 $V_{CC} = 2.7\text{ V}$

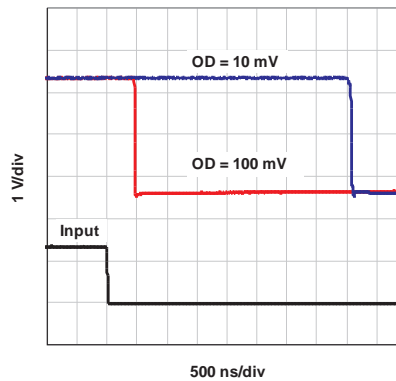

PROPAGATION DELAY TIME,
HIGH TO LOW
 $V_{CC} = 1.8\text{ V}$

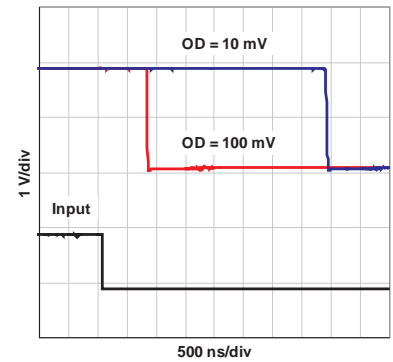

TYPICAL CHARACTERISTICS (continued)

PROPAGATION DELAY TIME,
LOW TO HIGH
 $V_{CC} = 5\text{ V}$

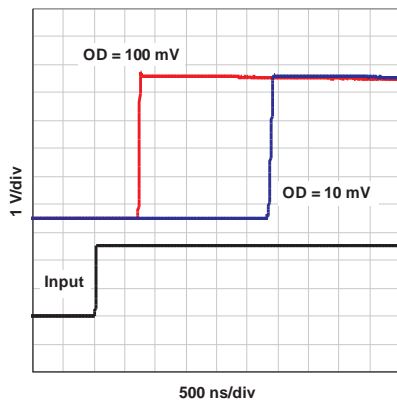

PROPAGATION DELAY TIME,
LOW TO HIGH
 $V_{CC} = 2.7\text{ V}$

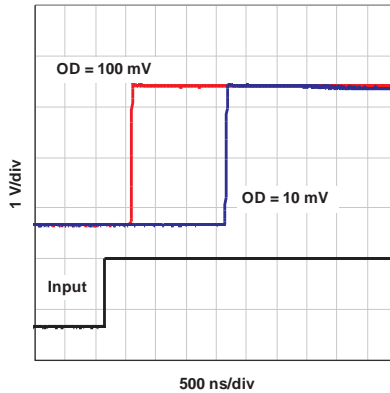

PROPAGATION DELAY TIME,
LOW TO HIGH
 $V_{CC} = 1.8\text{ V}$

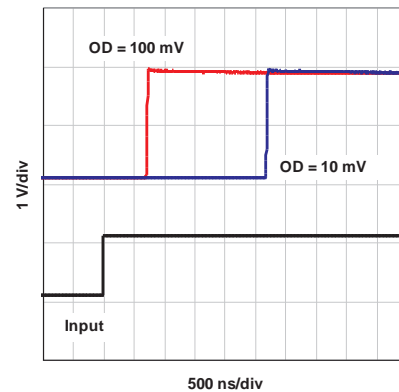

PACKAGING INFORMATION

Orderable Device	Status (1)	Package Type	Package Drawing	Pins	Package Qty	Eco Plan (2)	Lead finish/ Ball material (6)	MSL Peak Temp (3)	Op Temp (°C)	Device Marking (4/5)	Samples
TLV7256IDDUR	ACTIVE	VSSOP	DDU	8	3000	RoHS & Green	NIPDAU	Level-1-260C-UNLIM	-40 to 85	YAUA	Samples

(1) The marketing status values are defined as follows:

ACTIVE: Product device recommended for new designs.

LIFEBUY: TI has announced that the device will be discontinued, and a lifetime-buy period is in effect.

NRND: Not recommended for new designs. Device is in production to support existing customers, but TI does not recommend using this part in a new design.

PREVIEW: Device has been announced but is not in production. Samples may or may not be available.

OBSELETE: TI has discontinued the production of the device.

(2) **RoHS:** TI defines "RoHS" to mean semiconductor products that are compliant with the current EU RoHS requirements for all 10 RoHS substances, including the requirement that RoHS substance do not exceed 0.1% by weight in homogeneous materials. Where designed to be soldered at high temperatures, "RoHS" products are suitable for use in specified lead-free processes. TI may reference these types of products as "Pb-Free".

RoHS Exempt: TI defines "RoHS Exempt" to mean products that contain lead but are compliant with EU RoHS pursuant to a specific EU RoHS exemption.

Green: TI defines "Green" to mean the content of Chlorine (Cl) and Bromine (Br) based flame retardants meet JS709B low halogen requirements of <=1000ppm threshold. Antimony trioxide based flame retardants must also meet the <=1000ppm threshold requirement.

(3) MSL, Peak Temp. - The Moisture Sensitivity Level rating according to the JEDEC industry standard classifications, and peak solder temperature.

(4) There may be additional marking, which relates to the logo, the lot trace code information, or the environmental category on the device.

(5) Multiple Device Markings will be inside parentheses. Only one Device Marking contained in parentheses and separated by a "-" will appear on a device. If a line is indented then it is a continuation of the previous line and the two combined represent the entire Device Marking for that device.

(6) Lead finish/Ball material - Orderable Devices may have multiple material finish options. Finish options are separated by a vertical ruled line. Lead finish/Ball material values may wrap to two lines if the finish value exceeds the maximum column width.

Important Information and Disclaimer:The information provided on this page represents TI's knowledge and belief as of the date that it is provided. TI bases its knowledge and belief on information provided by third parties, and makes no representation or warranty as to the accuracy of such information. Efforts are underway to better integrate information from third parties. TI has taken and continues to take reasonable steps to provide representative and accurate information but may not have conducted destructive testing or chemical analysis on incoming materials and chemicals. TI and TI suppliers consider certain information to be proprietary, and thus CAS numbers and other limited information may not be available for release.

In no event shall TI's liability arising out of such information exceed the total purchase price of the TI part(s) at issue in this document sold by TI to Customer on an annual basis.

TAPE AND REEL INFORMATION



QUADRANT ASSIGNMENTS FOR PIN 1 ORIENTATION IN TAPE



*All dimensions are nominal

Device	Package Type	Package Drawing	Pins	SPQ	Reel Diameter (mm)	Reel Width W1 (mm)	A0 (mm)	B0 (mm)	K0 (mm)	P1 (mm)	W (mm)	Pin1 Quadrant
TLV7256IDDUR	VSSOP	DDU	8	3000	180.0	8.4	2.25	3.35	1.05	4.0	8.0	Q3

TAPE AND REEL BOX DIMENSIONS



*All dimensions are nominal

Device	Package Type	Package Drawing	Pins	SPQ	Length (mm)	Width (mm)	Height (mm)
TLV7256IDDUR	VSSOP	DDU	8	3000	202.0	201.0	28.0

DDU (R-PDSO-G8)

PLASTIC SMALL-OUTLINE PACKAGE

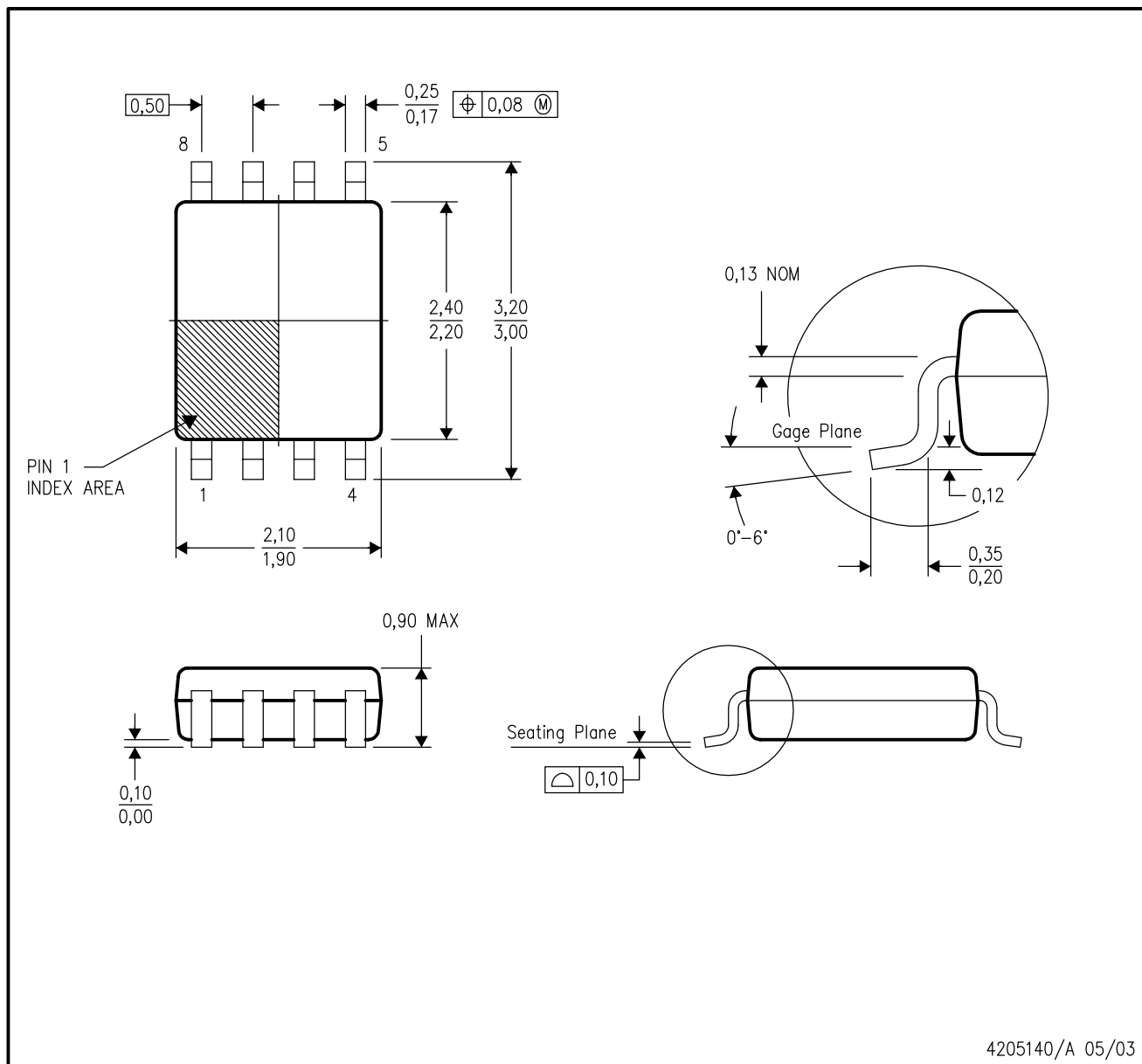

- NOTES:
- A. All linear dimensions are in millimeters.
 - B. This drawing is subject to change without notice.
 - C. Body dimensions do not include mold flash or protrusion.
 - D. Falls within JEDEC MO-187 variation CA.

DDU (S-PDSO-G8)

PLASTIC SMALL OUTLINE PACKAGE (DIE UP)

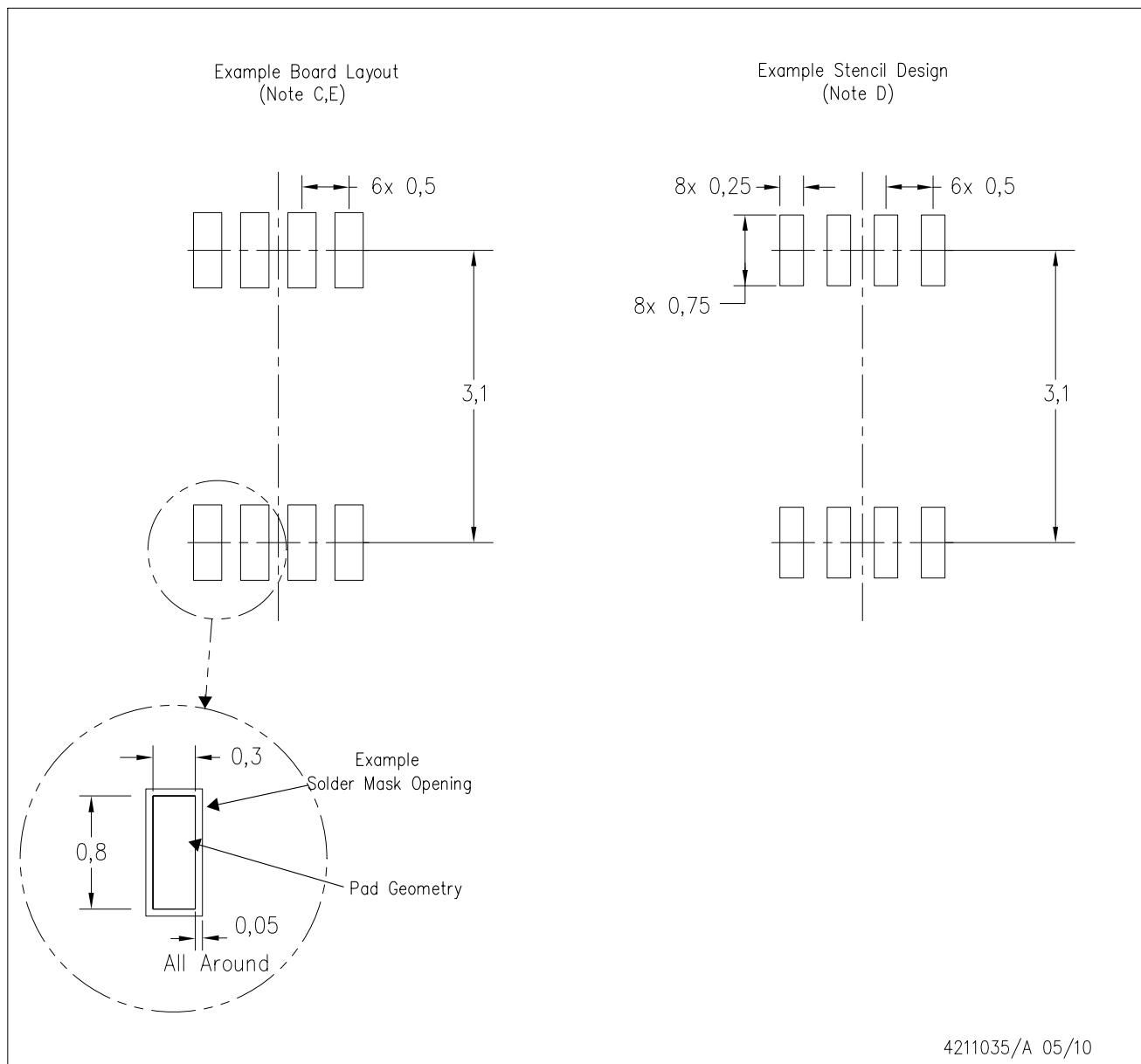

- NOTES:
- All linear dimensions are in millimeters.
 - This drawing is subject to change without notice.
 - Publication IPC-7351 is recommended for alternate designs.
 - Laser cutting apertures with trapezoidal walls and also rounding corners will offer better paste release. Customers should contact their board assembly site for stencil design recommendations. Refer to IPC-7525.
 - Customers should contact their board fabrication site for solder mask tolerances between and around signal pads.

IMPORTANT NOTICE AND DISCLAIMER

TI PROVIDES TECHNICAL AND RELIABILITY DATA (INCLUDING DATASHEETS), DESIGN RESOURCES (INCLUDING REFERENCE DESIGNS), APPLICATION OR OTHER DESIGN ADVICE, WEB TOOLS, SAFETY INFORMATION, AND OTHER RESOURCES "AS IS" AND WITH ALL FAULTS, AND DISCLAIMS ALL WARRANTIES, EXPRESS AND IMPLIED, INCLUDING WITHOUT LIMITATION ANY IMPLIED WARRANTIES OF MERCHANTABILITY, FITNESS FOR A PARTICULAR PURPOSE OR NON-INFRINGEMENT OF THIRD PARTY INTELLECTUAL PROPERTY RIGHTS.

These resources are intended for skilled developers designing with TI products. You are solely responsible for (1) selecting the appropriate TI products for your application, (2) designing, validating and testing your application, and (3) ensuring your application meets applicable standards, and any other safety, security, or other requirements. These resources are subject to change without notice. TI grants you permission to use these resources only for development of an application that uses the TI products described in the resource. Other reproduction and display of these resources is prohibited. No license is granted to any other TI intellectual property right or to any third party intellectual property right. TI disclaims responsibility for, and you will fully indemnify TI and its representatives against, any claims, damages, costs, losses, and liabilities arising out of your use of these resources.

TI's products are provided subject to TI's Terms of Sale (www.ti.com/legal/termsofsale.html) or other applicable terms available either on ti.com or provided in conjunction with such TI products. TI's provision of these resources does not expand or otherwise alter TI's applicable warranties or warranty disclaimers for TI products.

Mailing Address: Texas Instruments, Post Office Box 655303, Dallas, Texas 75265
Copyright © 2020, Texas Instruments Incorporated