

## TPD1E10B09 采用 0402 封装的单通道 ESD 保护二极管

### 1 特性

- 可为高达  $\pm 9\text{V}$  的 I/O 接口提供系统级 ESD 保护
- IEC 61000-4-2 4 级：
  - $\pm 20\text{ kV}$  (空气间隙放电)
  - $\pm 20\text{ kV}$  (接触放电)
- IEC 61000-4-5 浪涌保护：
  - $4.5\text{ A}$  ( $8/20\mu\text{s}$ )
- I/O 电容  $10\text{ pF}$  (典型值)
- $R_{\text{DYN}} 0.5\ \Omega$  (典型值)
- 直流击穿电压  $\pm 9.5\text{ V}$  (最小值)
- 超低泄漏电流  $100\text{ nA}$  (最大值)
- $13\text{ V}$  钳位电压 ( $I_{\text{PP}} = 1\text{ A}$  时的最大值)
- 工业温度范围： $-40^\circ\text{C}$  至  $125^\circ\text{C}$
- 节省空间的 0402 外形尺寸 ( $1\text{ mm} \times 0.6\text{ mm} \times 0.5\text{ mm}$ )

### 2 应用

- 终端设备：
  - 平板电脑
  - 远程控制器
  - 可穿戴设备
  - 机顶盒
  - 电子销售终端 (EPOS)
  - 电子书阅读器
- 接口：
  - 音频线路
  - 按钮
  - 通用输入/输出 (GPIO)

### 3 说明

TPD1E10B09 器件是一款采用小型 0402 封装的单通道 ESD 瞬态电压抑制 (TVS) 二极管。这款 ESD 保护二极管提供  $\pm 20\text{ kV}$  IEC 61000-4-2 (4 级) 接触和气隙 ESD 保护。该器件提供背靠背 TVS 二极管配置以支持双极或双向信号。 $10\text{ pF}$  线路电容适用于能够支持高达  $500\text{ Mbps}$  数据速率的宽范围应用。0402 封装是一种业界通用的封装，便于将元件安装到空间受限型应用中。

该 ESD 保护 TVS 二极管的典型应用是针对音频线路 (麦克风、耳机和扬声器)、SD 接口、键盘或其他按钮、USB 端口的  $V_{\text{BUS}}$  引脚和 ID 引脚以及通用 I/O 端口提供电路保护。该 ESD 钳位有利于为电子书阅读器、平板电脑、远程控制器、可穿戴设备、机顶盒以及电子销售点等终端设备提供保护。

#### 封装信息

器件型号	封装 <sup>(1)</sup>	封装尺寸 <sup>(2)</sup>
TPD1E10B09	DPY (X1SON, 2)	$1\text{ mm} \times 0.6\text{ mm}$

(1) 如需了解所有可用封装，请参阅数据表末尾的可订购产品附录。

(2) 封装尺寸 (长 x 宽) 为标称值，并包括引脚 (如适用)。

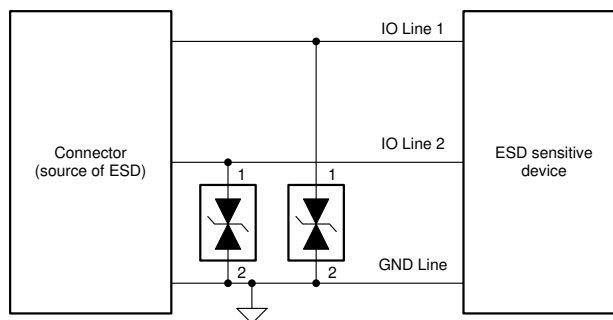

应用原理图

## Table of Contents

1 特性.....	1	7.3 Feature Description.....	8
2 应用.....	1	7.4 Device Functional Modes.....	8
3 说明.....	1	<b>8 Application and Implementation.....</b>	<b>9</b>
<b>4 Revision History.....</b>	<b>2</b>	8.1 Application Information.....	9
<b>5 Pin Configuration and Functions.....</b>	<b>3</b>	8.2 Typical Application.....	9
<b>6 Specifications.....</b>	<b>4</b>	8.3 Power Supply Recommendations.....	10
6.1 Absolute Maximum Ratings.....	4	8.4 Layout.....	11
6.2 ESD Ratings.....	4	<b>9 Device and Documentation Support.....</b>	<b>12</b>
6.3 Recommended Operating Conditions.....	4	9.1 接收文档更新通知.....	12
6.4 Thermal Information.....	4	9.2 支持资源.....	12
6.5 Electrical Characteristics.....	5	9.3 Trademarks.....	12
6.6 Typical Characteristics.....	6	9.4 静电放电警告.....	12
<b>7 Detailed Description.....</b>	<b>8</b>	9.5 术语表.....	12
7.1 Overview.....	8	<b>10 Mechanical, Packaging, and Orderable</b>	
7.2 Functional Block Diagram.....	8	<b>Information.....</b>	<b>12</b>

## 4 Revision History

注：以前版本的页码可能与当前版本的页码不同

<b>Changes from Revision D (August 2015) to Revision E (September 2023)</b>	<b>Page</b>
• 更改了封装信息表的格式以包含封装引线尺寸.....	1
• 更改了整个文档中的表格、图和交叉参考的编号格式.....	1
<b>Changes from Revision C (June 2015) to Revision D (August 2015)</b>	<b>Page</b>
• Added capacitive measurement frequency.....	5
<b>Changes from Revision B (October 2012) to Revision C (June 2015)</b>	<b>Page</b>
• 添加了 ESD 等级表、特性说明部分、器件功能模式、应用和实施部分、电源相关建议部分、布局部分、器件和文档支持部分以及机械、封装和可订购信息部分.....	1
<b>Changes from Revision A (March 2012) to Revision B (October 2012)</b>	<b>Page</b>
• Added Thermal Information table.....	4
<b>Changes from Revision * (February 2012) to Revision A (March 2012)</b>	<b>Page</b>
• 更新了特性部分.....	1
• Added graphs to Typical Characteristics section.....	6
• Added APPLICATION INFORMATION section.....	9

## 5 Pin Configuration and Functions



图 5-1. DPY Package, 2-Pin X1SON (Top View)

表 5-1. Pin Functions

PIN	TYPE <sup>(1)</sup>	DESCRIPTION
1	I/O	ESD protected I/O
2		

(1) I = input, O = output

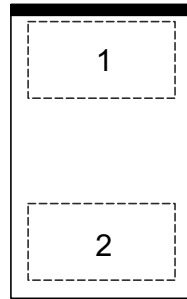
## 6 Specifications

### 6.1 Absolute Maximum Ratings

		MIN	MAX	UNIT
Operating temperature		- 40	125	°C
$I_{PP}$	Peak pulse current (tp = 8/20 $\mu$ s)		4.5	A
$P_{PP}$	Peak pulse power (tp = 8/20 $\mu$ s)		90	W
$T_{stg}$	Storage temperature	- 65	155	°C

### 6.2 ESD Ratings

		VALUE	UNIT
$V_{(ESD)}$	Electrostatic discharge	Human body model (HBM), per ANSI/ESDA/JEDEC JS-001 <sup>(1)</sup>	V
		Charged-device model (CDM), per JEDEC specification JESD22-C101 <sup>(2)</sup>	
		IEC 61000-4-2 Contact Discharge	
		IEC 61000-4-2 Air-Gap Discharge	

(1) JEDEC document JEP155 states that 500-V HBM allows safe manufacturing with a standard ESD control process.

(2) JEDEC document JEP157 states that 250-V CDM allows safe manufacturing with a standard ESD control process.

### 6.3 Recommended Operating Conditions

over operating free-air temperature range (unless otherwise noted)

		MIN	NOM	MAX	UNIT
Operating free-air temperature, $T_A$		- 40		125	°C
Operating voltage	Pin 1 to 2 or pin 2 to 1	- 9		9	V

### 6.4 Thermal Information

THERMAL METRIC <sup>(1)</sup>		TPD1E10B09	UNIT
		DPY (X1SON)	
		2 PINS	
$R_{\theta JA}$	Junction-to-ambient thermal resistance	615.5	°C/W
$R_{\theta JC(top)}$	Junction-to-case (top) thermal resistance	404.8	°C/W
$R_{\theta JB}$	Junction-to-board thermal resistance	493.3	°C/W
$\psi_{JT}$	Junction-to-top characterization parameter	127.7	°C/W
$\psi_{JB}$	Junction-to-board characterization parameter	493.3	°C/W
P	Power Dissipation <sup>(2)</sup>	162	mW

(1) For more information about traditional and new thermal metrics, see the *IC Package Thermal Metrics* application report, [SPRA953](#).

(2) Max junction temperature: 125°C; power dissipation calculated at 25°C ambient temperature using JEDEC High K board Standard. Not to be used for steady state power dissipation in the breakdown region.

## 6.5 Electrical Characteristics

over operating free-air temperature range (unless otherwise noted)

PARAMETER		TEST CONDITION	MIN	TYP	MAX	UNIT
$V_{RWM}$	Reverse stand-off voltage	Pin 1 to 2 or pin 2 to 1			9	V
$I_{LEAK}$	Leakage current	Pin 1 = 5 V, pin 2 = 0 V			100	nA
$V_{Clamp1,2}$	Clamp voltage with ESD strike on pin 1, pin 2 grounded.	$I_{PP} = 1\text{ A}$ , $t_p = 8/20\ \mu\text{Sec}^{(2)}$			13	V
		$I_{PP} = 5\text{ A}$ , $t_p = 8/20\ \mu\text{Sec}^{(2)}$			17	
$V_{Clamp2,1}$	Clamp voltage with ESD strike on pin 2, pin 1 grounded.	$I_{PP} = 1\text{ A}$ , $t_p = 8/20\ \mu\text{Sec}^{(2)}$			13	V
		$I_{PP} = 4.5\text{ A}$ , $t_p = 8/20\ \mu\text{Sec}^{(2)}$			20	
$R_{DYN}$	Dynamic resistance	Pin 1 to pin 2 <sup>(1)</sup>		0.5		$\Omega$
		Pin 2 to pin 1 <sup>(1)</sup>		0.5		
$C_{IO}$	I/O capacitance	$V_{IO} = 2.5\text{ V}$ ; $f = 1\text{ MHz}$		10		pF
$V_{BR1,2}$	Break-down voltage, pin 1 to pin 2	$I_{IO} = 1\text{ mA}$	9.5			V
$V_{BR2,1}$	Break-down voltage, pin 2 to pin 1	$I_{IO} = 1\text{ mA}$	9.5			V

(1) Extraction of  $R_{DYN}$  using least squares fit of TLP characteristics from  $I_{PP} = 10\text{ A}$  to  $I_{PP} = 20\text{ A}$ .

(2) Non-repetitive current pulse 8/20  $\mu\text{s}$  exponentially decaying waveform according to IEC 61000-4-5.

## 6.6 Typical Characteristics



图 6-1. ESD Clamp Voltage +8 kV Contact ESD



图 6-2. ESD Clamp Voltage - 8 kV Contact ESD

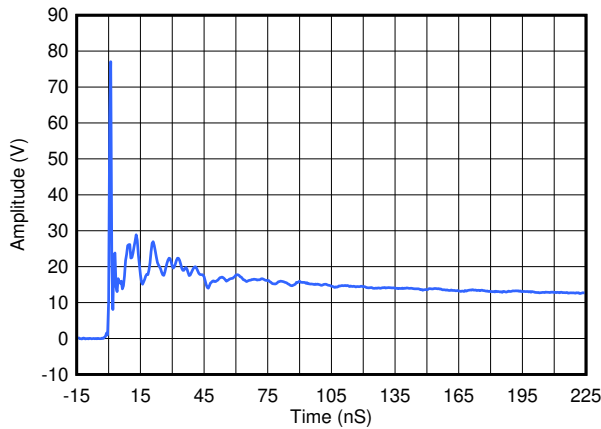

图 6-3. Transmission Line Pulse (TLP) Waveform Pin 1 to Pin 2

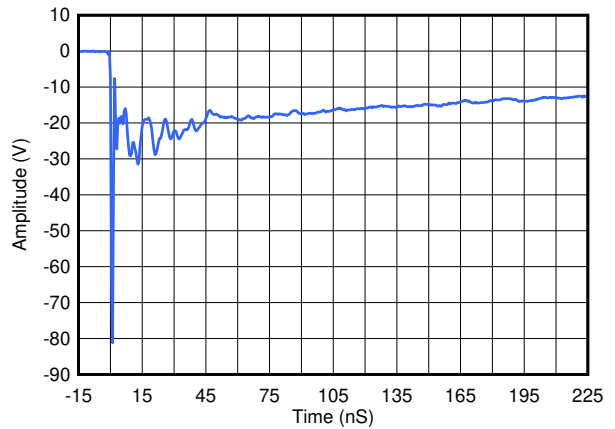

图 6-4. Transmission Line Pulse (TLP) Waveform Pin 2 to Pin 1

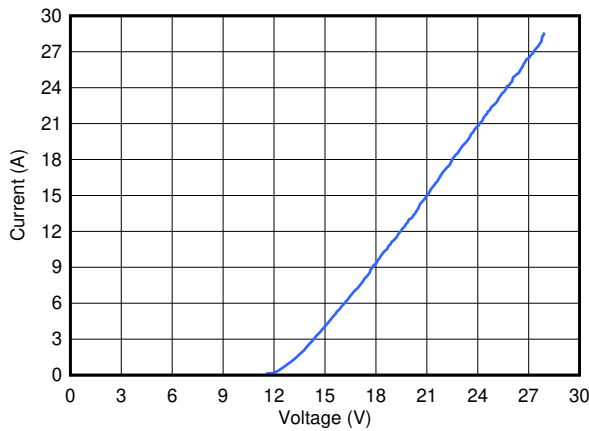

图 6-5. IV Curve

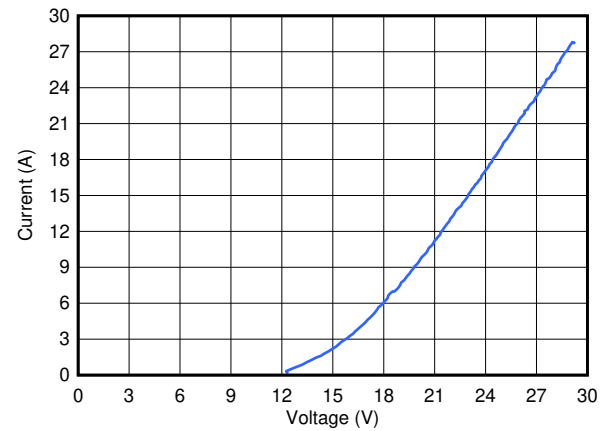

图 6-6. Positive Surge Waveform 8/20 μs

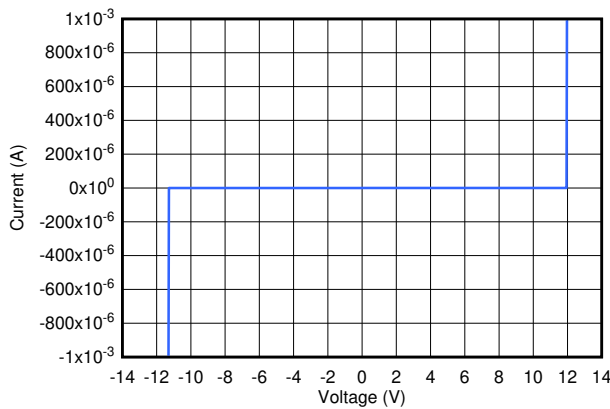

图 6-7. Negative Surge Waveform 8/20  $\mu$ s

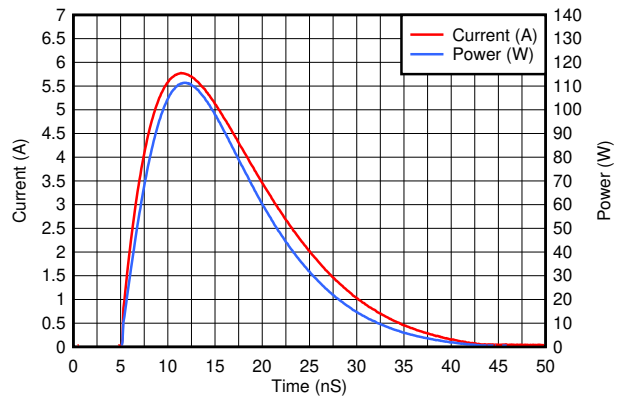

图 6-8. Pin Capacitance Across V<sub>BIAS</sub>

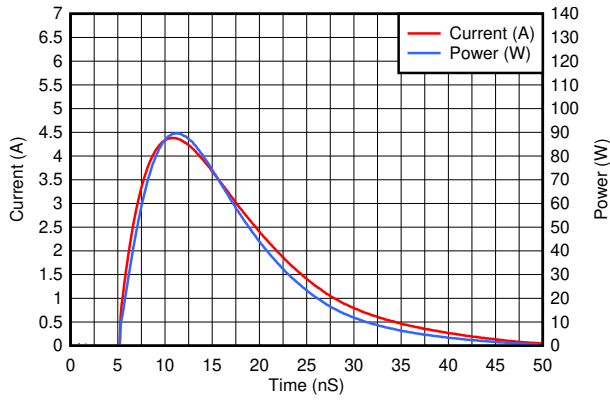

图 6-9. Insertion Loss

## 7 Detailed Description

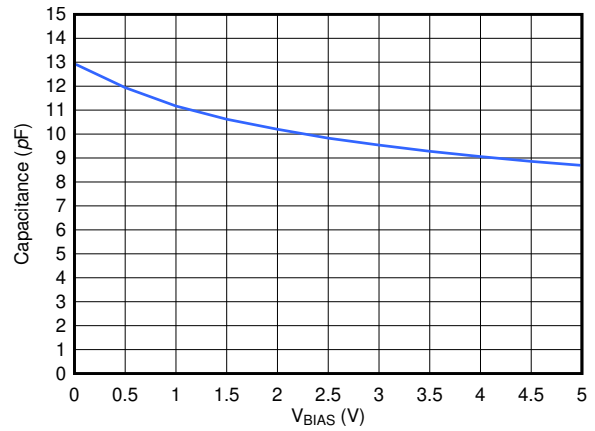
### 7.1 Overview

TPD1E10B09 is a single-channel ESD TVS that provides  $\pm 20$ -kV IEC 61000-4-2 (Level 4) contact and air-gap ESD protection. The 10-pF back-to-back diode architecture is suitable for signals that range from  $-9$  V to 9 V and supports data rates up to 500 Mbps. The industry-standard 0402 package is convenient for placement in applications with limited space.

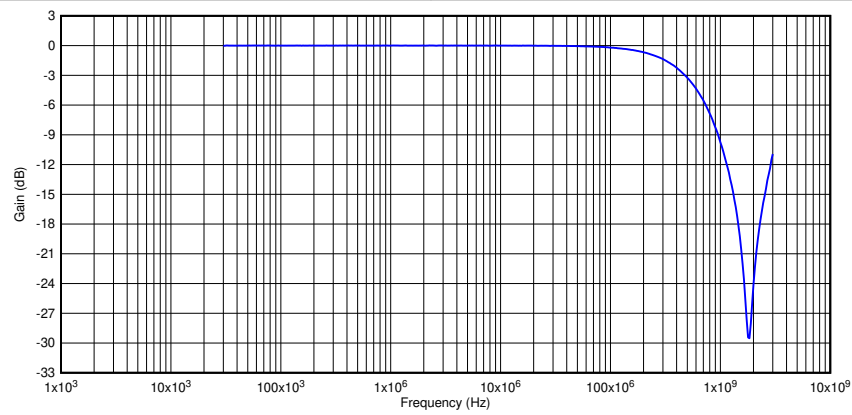
### 7.2 Functional Block Diagram

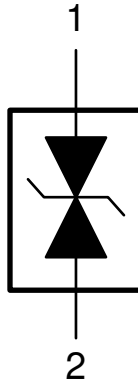

### 7.3 Feature Description

TPD1E10B09 is a bidirectional TVS with high ESD protection level. This device protects circuit from ESD strikes up to  $\pm 20$ -kV contact and  $\pm 20$ -kV air-gap specified in the IEC 61000-4-2 level 4 international standard. The device can also handle up to 4.5-A surge current (IEC 61000-4-5 8/20  $\mu$ s). The I/O capacitance of 10 pF supports a data rate up to 500 Mbps. This clamping device has a small dynamic resistance of 0.5  $\Omega$  typically. This makes the clamping voltage low when the device is actively protecting other circuits. For example, the clamping voltage is only 13 V when the device is taking 1-A transient current. The breakdown is bidirectional so that this protection device is a good fit for GPIO, especially audio lines which carry bidirectional signals. Low leakage allows the diode to conserve power when working below the  $V_{RWM}$ . The industrial temperature range of  $-40^{\circ}\text{C}$  to  $125^{\circ}\text{C}$  makes this ESD device work at extensive temperatures in most environments. The space-saving 0402 package can fit into small electronic devices like mobile equipment and wearables.

### 7.4 Device Functional Modes

TPD1E10B09 is a passive clamp that has low leakage during normal operation when the voltage between pin 1 and pin 2 is below  $V_{RWM}$  and activates when the voltage between pin 1 and pin 2 goes above  $V_{BR}$ . During IEC ESD events, transient voltages as high as  $\pm 20$  kV can be clamped between the two pins. When the voltages on the protected lines fall below the trigger voltage, the device reverts back to the low leakage passive state.



## 8 Application and Implementation

### 备注

以下应用部分中的信息不属于 TI 器件规格的范围，TI 不担保其准确性和完整性。TI 的客户应负责确定器件是否适用于其应用。客户应验证并测试其设计，以确保系统功能。

### 8.1 Application Information

The TPD1E10B09 is a single-channel back-to-back diode that protects one bidirectional signal line from electrostatic discharge and surge pulses. Because the diode is bidirectional, TPD1E10B09 protects signals that have positive or negative polarity. During normal operation, the diode behaves as a 10-pF capacitance to ground. Board layout is critical for optimal performance of any diode.

Placement: The diode should be placed very close to the external connector for optimal performance. It is best to place the diode on the line that it is protecting.

Layout: Pin 1 of the diode should be right over the protected signal line. There should a thick and short trace from pin 2 to ground. For an example, see the [Layout](#) section.

### 8.2 Typical Application

A system with a human interface is vulnerable to large system-level ESD strikes that standard ICs cannot survive. TVS ESD protection diodes are typically used to suppress ESD at these connectors. TPD1E10B09 is a single-channel ESD protection device containing back-to-back TVS diodes, which is typically used to provide a path to ground for dissipating ESD events on bidirectional signal lines between a human interface connector and a system. As the current from ESD passes through the device, only a small voltage drop is present across the diode structure. This is the voltage presented to the protected IC. The low  $R_{DYN}$  of the triggered TVS holds this voltage,  $V_{CLAMP}$ , to a tolerable level to the protected IC.



图 8-1. Typical Application Schematic

#### 8.2.1 Design Requirements

For this design example, two TPD1E10B09s will be used to protect left and right audio channels. 表 8-1 lists the known system parameters for this audio application.

表 8-1. Design Parameters

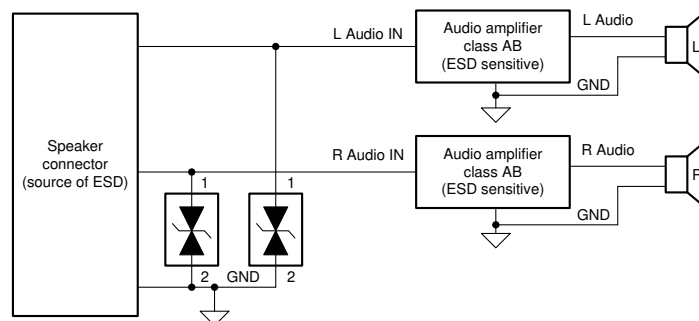
DESIGN PARAMETER	VALUE
Audio Amplifier Class	AB
Audio signal voltage range	- 8 V to 8 V
Audio frequency content	20 Hz to 20 kHz
Required IEC 61000-4-2 ESD Protection	±15-kV Contact/ ±15-kV Air-Gap

#### 8.2.2 Detailed Design Procedure

To begin the design process, consider the following parameters:

- Ensure the voltage range on the protected line does not exceed the reverse standoff voltage of the TVS diodes ( $V_{RWM}$ ).
- Ensure the operating frequency is supported by the I/O capacitance ( $C_{IO}$ ) of the TVS diode.
- Ensure the IEC 61000-4-2 protection requirement is covered by the IEC performance of the TVS diode.

For this application, the audio signal voltage range is  $-8\text{ V}$  to  $8\text{ V}$ . The  $V_{RWM}$  for the TVS is  $-9.5\text{ V}$  to  $9.5\text{ V}$ ; therefore, the bidirectional TVS will not break down during normal operation, and normal operation of the audio signal will not be affected due to the signal voltage range. In this application, a bidirectional TVS like TPD1E10B09 is required.

Next, consider the frequency content of this audio signal. In this application with the class AB amplifier, the frequency content is from  $20\text{ Hz}$  to  $20\text{ kHz}$ ; filter the TVS I/O capacitance so that it does not distort this signal. With TPD1E10B09 typical capacitance of  $10\text{ pF}$ , which leads to a typical cutoff frequency of just under  $500\text{ MHz}$ , this diode has sufficient bandwidth to pass the audio signal without distorting it.

Finally, the human interface in this application requires protection for  $\pm 15\text{-kV}$  Contact and  $\pm 15\text{-kV}$  Air-Gap ESD, which is above the standard Level 4 IEC 61000-4-2 system-level ESD protection. A standard TVS cannot survive this level of IEC ESD stress. However, TPD1E10B09 can survive at least  $\pm 20\text{-kV}$  Contact and  $\pm 20\text{-kV}$  Air-Gap ESD. Therefore, the device can provide sufficient ESD protection for the interface, even though the requirements are stringent. For any TVS diode to provide its full range of ESD protection capabilities, as well as to minimize the noise and EMI disturbances the board will see during ESD events, it is crucial that a system designer uses proper board layout of their TVS ESD protection diodes. For instructions on properly laying out TPD1E10B09, see [Layout](#).

### 8.2.3 Application Curves

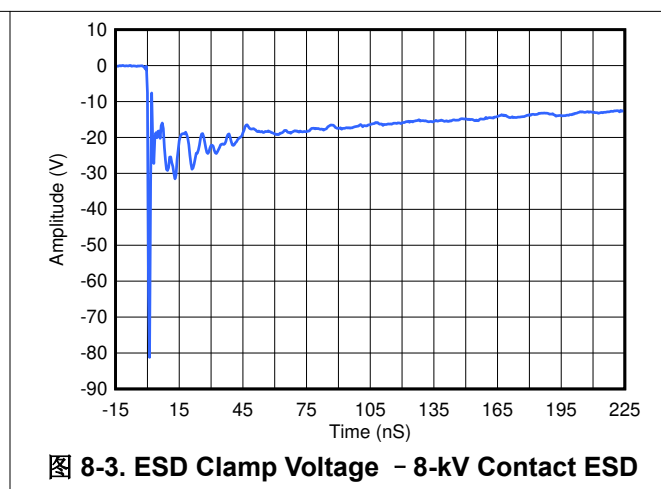
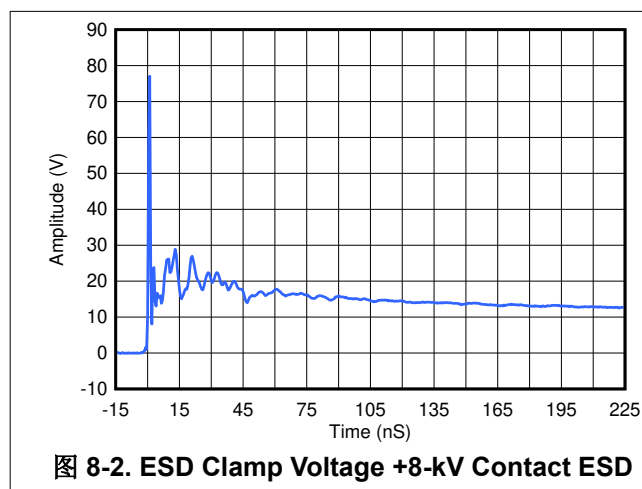

### 8.3 Power Supply Recommendations

This device is a passive TVS diode-based ESD protection device, so there is no need to power it. Do not violate the maximum specifications for each pin.

## 8.4 Layout

### 8.4.1 Layout Guidelines

- The optimum placement is as close to the connector as possible.
  - EMI during an ESD event can couple from the trace being struck to other nearby unprotected traces, resulting in early system failures.
  - The PCB designer must minimize the possibility of EMI coupling by keeping any unprotected traces away from the protected traces which are between the TVS and the connector.
- Route the protected traces as straight as possible.
- Use rounded corners with the largest radii possible on the protected traces between the TVS and the connector, thus eliminating any sharp corners.
  - Electric fields tend to build up on corners, increasing EMI coupling.
- If pin 1 or pin 2 is connected to ground, use a thick and short trace for this return path.

### 8.4.2 Layout Example



图 8-4. Layout Example

## 9 Device and Documentation Support

### 9.1 接收文档更新通知

要接收文档更新通知，请导航至 [ti.com](http://ti.com) 上的器件产品文件夹。点击 [订阅更新](#) 进行注册，即可每周接收产品信息更改摘要。有关更改的详细信息，请查看任何已修订文档中包含的修订历史记录。

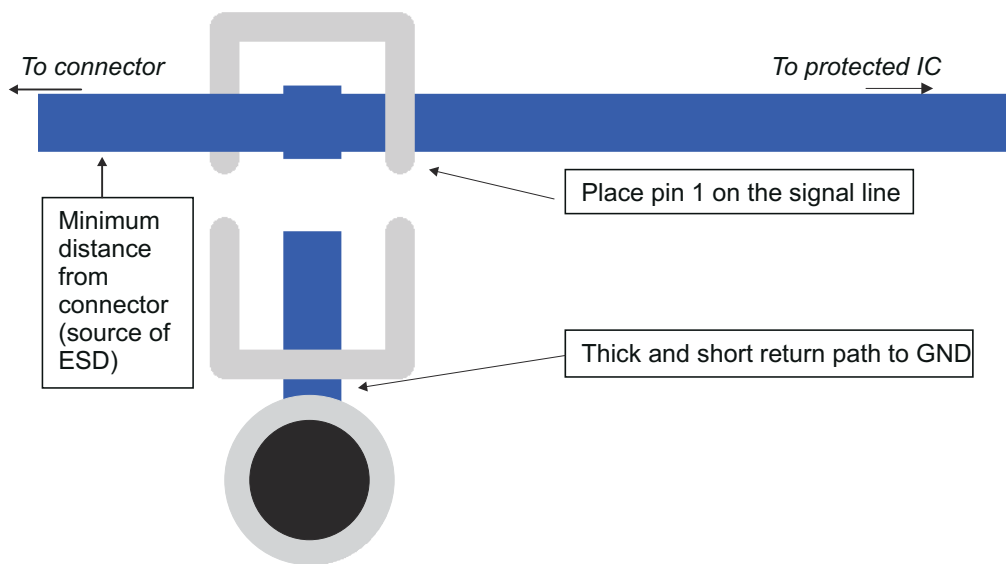
### 9.2 支持资源

**TI E2E™ 支持论坛** 是工程师的重要参考资料，可直接从专家获得快速、经过验证的解答和设计帮助。搜索现有解答或提出自己的问题可获得所需的快速设计帮助。

链接的内容由各个贡献者“按原样”提供。这些内容并不构成 TI 技术规范，并且不一定反映 TI 的观点；请参阅 TI 的《[使用条款](#)》。

### 9.3 Trademarks

TI E2E™ is a trademark of Texas Instruments.

所有商标均为其各自所有者的财产。

### 9.4 静电放电警告



静电放电 (ESD) 会损坏这个集成电路。德州仪器 (TI) 建议通过适当的预防措施处理所有集成电路。如果不遵守正确的处理和安装程序，可能会损坏集成电路。

ESD 的损坏小至导致微小的性能降级，大至整个器件故障。精密的集成电路可能更容易受到损坏，这是因为非常细微的参数更改都可能会导致器件与其发布的规格不相符。

### 9.5 术语表

**TI 术语表** 本术语表列出并解释了术语、首字母缩略词和定义。

## 10 Mechanical, Packaging, and Orderable Information

The following pages include mechanical, packaging, and orderable information. This information is the most current data available for the designated devices. This data is subject to change without notice and revision of this document. For browser-based versions of this data sheet, refer to the left-hand navigation.

**PACKAGING INFORMATION**

Orderable Device	Status (1)	Package Type	Package Drawing	Pins	Package Qty	Eco Plan (2)	Lead finish/ Ball material (6)	MSL Peak Temp (3)	Op Temp (°C)	Device Marking (4/5)	Samples
TPD1E10B09DPYR	ACTIVE	X1SON	DPY	2	10000	RoHS & Green	NIPDAU	Level-1-260C-UNLIM	-40 to 125	(A1, A2, A6, BJ)	<a href="#">Samples</a>
TPD1E10B09DPYT	ACTIVE	X1SON	DPY	2	250	RoHS & Green	NIPDAU	Level-1-260C-UNLIM	-40 to 125	(A1, A2, A6, BJ)	<a href="#">Samples</a>

(1) The marketing status values are defined as follows:

**ACTIVE:** Product device recommended for new designs.

**LIFEBUY:** TI has announced that the device will be discontinued, and a lifetime-buy period is in effect.

**NRND:** Not recommended for new designs. Device is in production to support existing customers, but TI does not recommend using this part in a new design.

**PREVIEW:** Device has been announced but is not in production. Samples may or may not be available.

**OBSELETE:** TI has discontinued the production of the device.

(2) **RoHS:** TI defines "RoHS" to mean semiconductor products that are compliant with the current EU RoHS requirements for all 10 RoHS substances, including the requirement that RoHS substance do not exceed 0.1% by weight in homogeneous materials. Where designed to be soldered at high temperatures, "RoHS" products are suitable for use in specified lead-free processes. TI may reference these types of products as "Pb-Free".

**RoHS Exempt:** TI defines "RoHS Exempt" to mean products that contain lead but are compliant with EU RoHS pursuant to a specific EU RoHS exemption.

**Green:** TI defines "Green" to mean the content of Chlorine (Cl) and Bromine (Br) based flame retardants meet JS709B low halogen requirements of <=1000ppm threshold. Antimony trioxide based flame retardants must also meet the <=1000ppm threshold requirement.

(3) MSL, Peak Temp. - The Moisture Sensitivity Level rating according to the JEDEC industry standard classifications, and peak solder temperature.

(4) There may be additional marking, which relates to the logo, the lot trace code information, or the environmental category on the device.

(5) Multiple Device Markings will be inside parentheses. Only one Device Marking contained in parentheses and separated by a "~" will appear on a device. If a line is indented then it is a continuation of the previous line and the two combined represent the entire Device Marking for that device.

(6) Lead finish/Ball material - Orderable Devices may have multiple material finish options. Finish options are separated by a vertical ruled line. Lead finish/Ball material values may wrap to two lines if the finish value exceeds the maximum column width.

**Important Information and Disclaimer:**The information provided on this page represents TI's knowledge and belief as of the date that it is provided. TI bases its knowledge and belief on information provided by third parties, and makes no representation or warranty as to the accuracy of such information. Efforts are underway to better integrate information from third parties. TI has taken and continues to take reasonable steps to provide representative and accurate information but may not have conducted destructive testing or chemical analysis on incoming materials and chemicals. TI and TI suppliers consider certain information to be proprietary, and thus CAS numbers and other limited information may not be available for release.

In no event shall TI's liability arising out of such information exceed the total purchase price of the TI part(s) at issue in this document sold by TI to Customer on an annual basis.

**OTHER QUALIFIED VERSIONS OF TPD1E10B09 :**

- Automotive : [TPD1E10B09-Q1](#)

## NOTE: Qualified Version Definitions:

- Automotive - Q100 devices qualified for high-reliability automotive applications targeting zero defects

**TAPE AND REEL INFORMATION**

**QUADRANT ASSIGNMENTS FOR PIN 1 ORIENTATION IN TAPE**

\*All dimensions are nominal

Device	Package Type	Package Drawing	Pins	SPQ	Reel Diameter (mm)	Reel Width W1 (mm)	A0 (mm)	B0 (mm)	K0 (mm)	P1 (mm)	W (mm)	Pin1 Quadrant
TPD1E10B09DPYR	X1SON	DPY	2	10000	180.0	8.4	0.67	1.15	0.46	2.0	8.0	Q2
TPD1E10B09DPYT	X1SON	DPY	2	250	178.0	8.4	0.7	1.15	0.47	2.0	8.0	Q1
TPD1E10B09DPYT	X1SON	DPY	2	250	180.0	9.5	0.73	1.13	0.5	2.0	8.0	Q1

## TAPE AND REEL BOX DIMENSIONS



\*All dimensions are nominal

Device	Package Type	Package Drawing	Pins	SPQ	Length (mm)	Width (mm)	Height (mm)
TPD1E10B09DPYR	X1SON	DPY	2	10000	210.0	185.0	35.0
TPD1E10B09DPYT	X1SON	DPY	2	250	205.0	200.0	33.0
TPD1E10B09DPYT	X1SON	DPY	2	250	189.0	185.0	36.0



## GENERIC PACKAGE VIEW

**DPY 2**

**X1SON - 0.45 mm max height**

1 x 0.6 mm

PLASTIC SMALL OUTLINE - NO LEAD

This image is a representation of the package family, actual package may vary.  
Refer to the product data sheet for package details.



4231484/A

DPY0002A

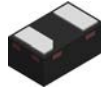

**PACKAGE OUTLINE**  
**X1SON - 0.45 mm max height**

PLASTIC SMALL OUTLINE - NO LEAD

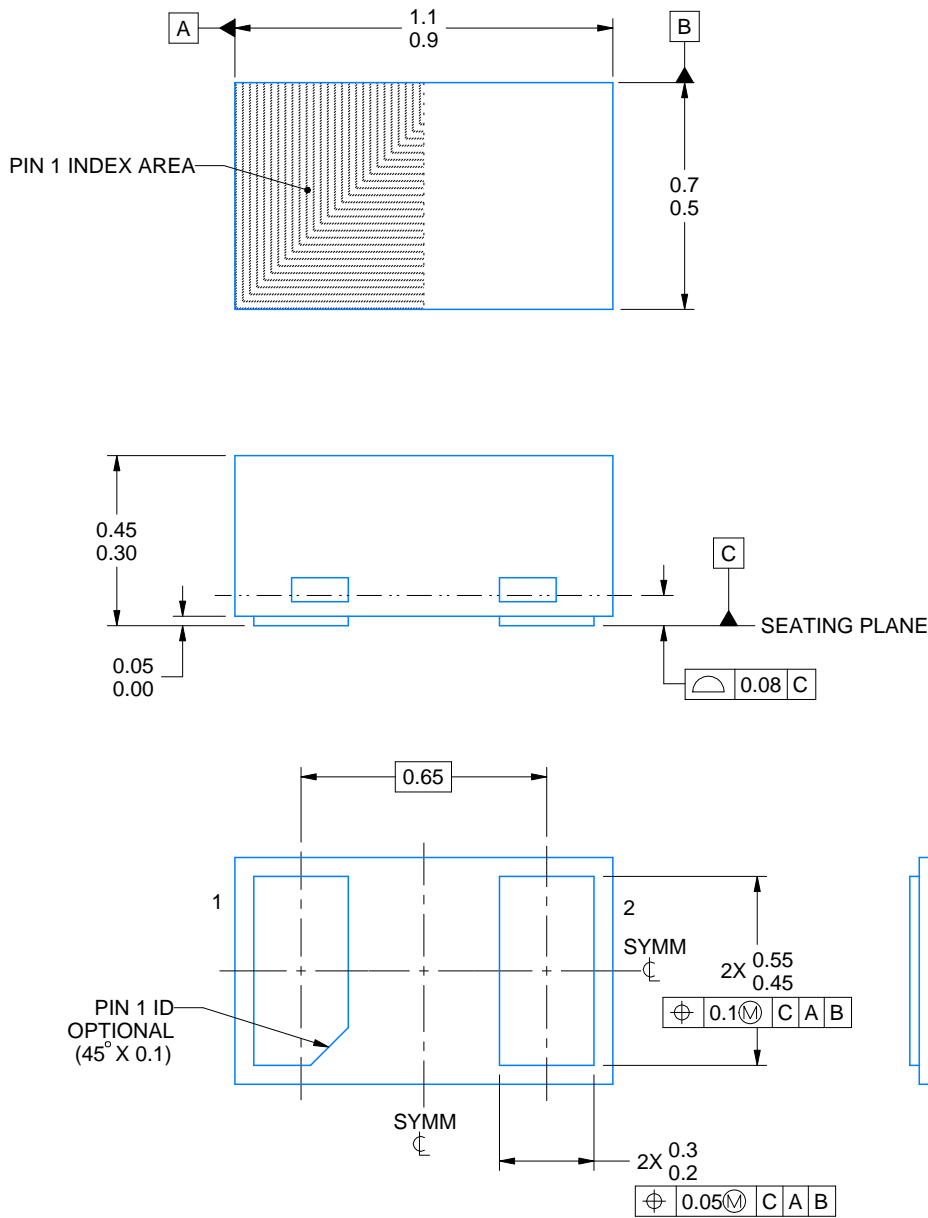

4224561/C 07/2024

NOTES:

1. All linear dimensions are in millimeters. Any dimensions in parenthesis are for reference only. Dimensioning and tolerancing per ASME Y14.5M
2. This drawing is subject to change without notice.

# EXAMPLE BOARD LAYOUT

DPY0002A

X1SON - 0.45 mm max height

PLASTIC SMALL OUTLINE - NO LEAD

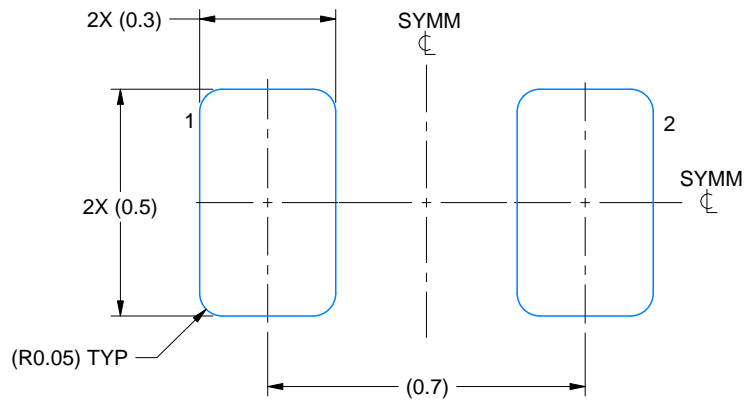

LAND PATTERN EXAMPLE  
EXPOSED METAL SHOWN  
SCALE:60X

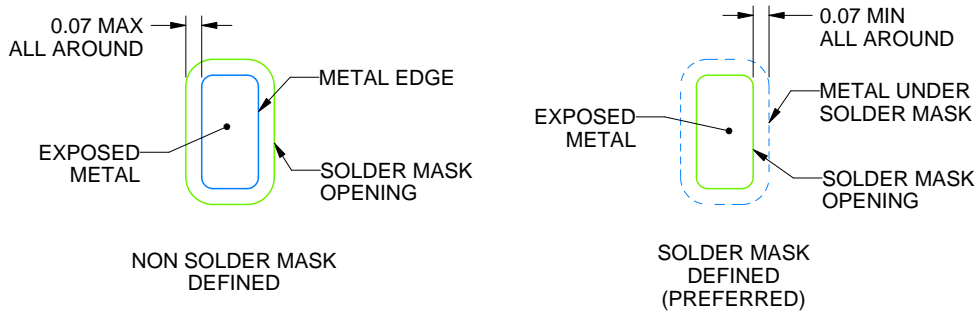

SOLDER MASK DETAILS

4224561/C 07/2024

NOTES: (continued)

3. For more information, see Texas Instruments literature number SLUA271 ([www.ti.com/lit/slue271](http://www.ti.com/lit/slue271)).
4. Vias are optional depending on application, refer to device data sheet. If any vias are implemented, refer to their locations shown on this view. It is recommended that vias under paste be filled, plugged or tented.

# EXAMPLE STENCIL DESIGN

DPY0002A

X1SON - 0.45 mm max height

PLASTIC SMALL OUTLINE - NO LEAD

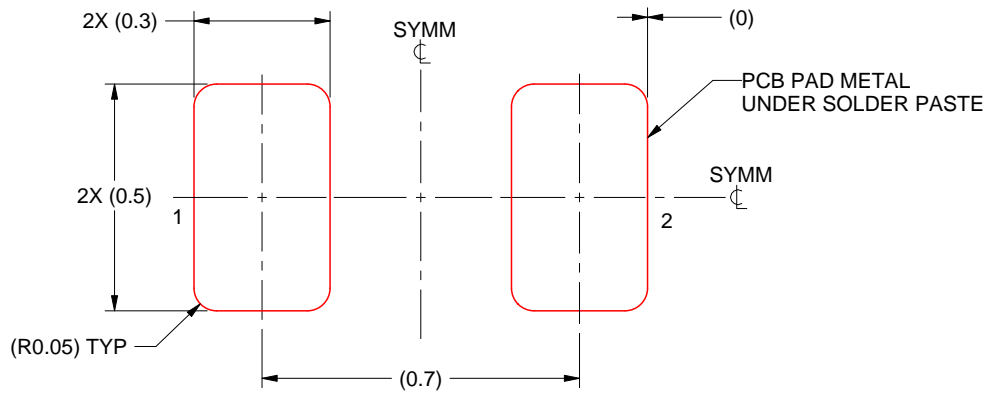

SOLDER PASTE EXAMPLE  
BASED ON 0.1 mm THICK STENCIL  
SCALE:60X

4224561/C 07/2024

NOTES: (continued)

5. Laser cutting apertures with trapezoidal walls and rounded corners may offer better paste release. IPC-7525 may have alternate design recommendations.

## 重要通知和免责声明

TI“按原样”提供技术和可靠性数据（包括数据表）、设计资源（包括参考设计）、应用或其他设计建议、网络工具、安全信息和其他资源，不保证没有瑕疵且不做任何明示或暗示的担保，包括但不限于对适销性、某特定用途方面的适用性或不侵犯任何第三方知识产权的暗示担保。

这些资源可供使用 TI 产品进行设计的熟练开发人员使用。您将自行承担以下全部责任：(1) 针对您的应用选择合适的 TI 产品，(2) 设计、验证并测试您的应用，(3) 确保您的应用满足相应标准以及任何其他功能安全、信息安全、监管或其他要求。

这些资源如有变更，恕不另行通知。TI 授权您仅可将这些资源用于研发本资源所述的 TI 产品的相关应用。严禁以其他方式对这些资源进行复制或展示。您无权使用任何其他 TI 知识产权或任何第三方知识产权。您应全额赔偿因在这些资源的使用中对 TI 及其代表造成的任何索赔、损害、成本、损失和债务，TI 对此概不负责。

TI 提供的产品受 [TI 的销售条款](#) 或 [ti.com](#) 上其他适用条款/TI 产品随附的其他适用条款的约束。TI 提供这些资源并不会扩展或以其他方式更改 TI 针对 TI 产品发布的适用的担保或担保免责声明。

TI 反对并拒绝您可能提出的任何其他或不同的条款。

邮寄地址：Texas Instruments, Post Office Box 655303, Dallas, Texas 75265  
版权所有 © 2025，德州仪器 (TI) 公司