

TPS2295x 5.7V、5A、14mΩ 导通电阻负载开关

1 特性

- 集成单通道负载开关
- 输入电压范围：0.7V 至 5.7V
- R_{ON} 电阻
 - $V_{IN} = 5V$ ($V_{BIAS} = 5V$) 时, $R_{ON} = 14m\Omega$
- 5A 最大持续开关电流
- 可调欠压闭锁 (UVLO) 阈值
- 带有电源正常 (PG) 指示器的可调电压监控器
- 可调输出转换率控制
- 增强型快速输出放电功能, 在电源移除后仍能保持激活状态 (仅 TPS22954)
 - 15Ω (典型值), 可使 $100\mu F$ 电容在 10ms 内完全放电
- 禁用时提供反向电流保护 (仅 TPS22953)
- 可在监控器检测到故障后自动重启 (使能时)
- 热关断
- 低静态电流 $\leq 50\mu A$
- 带有散热焊盘的小外形尺寸无引线 (SON) 10 引脚封装
- 经测试, 静电放电 (ESD) 性能符合 JESD 22 规范
 - 2kV 人体模型 (HBM) 和 750V 充电器件模型 (CDM)

2 应用

- 固态硬盘
- 嵌入式/工业 PC
- Ultrabook™/笔记本电脑
- 台式机
- 服务器
- 电信系统

4 简化电路原理图

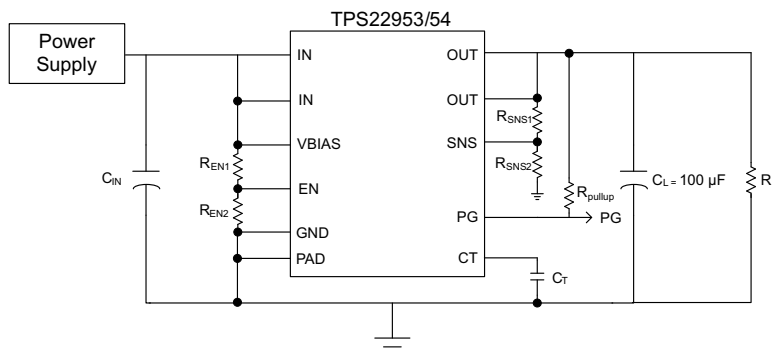

3 说明

TPS22953/54 是具有受控导通功能的小型单通道负载开关。该器件包含一个可在 0.7V 至 5.7V 输入电压范围内运行的 N 通道 MOSFET, 并且可支持最大 5A 的持续电流。

该器件具有可调欠压闭锁 (UVLO) 和可调电源正常 (PG) 阈值, 可提供电压监控和可靠的电源排序功能。器件的可调上升时间控制功能可大幅降低各类大容量负载电容的浪涌电流, 从而降低或消除电源压降。此开关可由一个导通/关断输入 (EN) 独立控制, 该输入可与低压控制信号直接对接。器件集成了一个 15Ω 片上负载电阻, 可在开关被禁用时使输出快速放电。增强型快速输出放电 (QOD) 功能可在器件断电后的一小段时间内继续保持激活状态, 以便使输出完成放电。

TPS22953/54 采用小型、节省空间的 10 引脚小外形尺寸无引线 (SON) 封装, 此类封装具有集成散热焊盘, 支持较高功耗。器件在自然通风环境下的额定运行温度范围为 $-40^{\circ}C$ 至 $105^{\circ}C$ 。

器件信息(1)

器件编号	封装 (引脚)	封装尺寸 (标称值)
TPS2295x	DSQ (10)	2.00mm x 2.00mm
	DQC (10)	2.00mm x 3.00mm

(1) 要了解所有可用封装, 请见数据表末尾的可订购产品附录。

目录

1	特性	1	8.12	Typical Switching Characteristics	15
2	应用	1	9	Detailed Description	21
3	说明	1	9.1	Overview	21
4	简化电路原理图	1	9.2	Functional Block Diagram	21
5	修订历史记录	2	9.3	Feature Description	22
6	Device Comparison Table	3	9.4	Device Functional Modes	27
7	Pin Configuration and Functions	3	10	Application and Implementation	28
8	Specifications	4	10.1	Application Information	28
8.1	Absolute Maximum Ratings	4	10.2	Typical Application	31
8.2	ESD Ratings	4	11	Power Supply Recommendations	33
8.3	Recommended Operating Conditions	4	12	Layout	33
8.4	Thermal Information	5	12.1	Layout Guidelines	33
8.5	Electrical Characteristics	5	12.2	Layout Example	34
8.6	Electrical Characteristics, $V_{BIAS} = 5\text{ V}$	6	13	器件和文档支持	35
8.7	Electrical Characteristics, $V_{BIAS} = 3.3\text{ V}$	7	13.1	相关链接	35
8.8	Electrical Characteristics, $V_{BIAS} = 2.5\text{ V}$	8	13.2	商标	35
8.9	Switching Characteristics, $CT = 1000\text{ pF}$	9	13.3	静电放电警告	35
8.10	Switching Characteristics, $CT = 0\text{ pF}$	10	13.4	术语表	35
8.11	Typical DC Characteristics	12	14	机械封装和可订购信息	35

5 修订历史记录

Changes from Original (March 2015) to Revision A

Page

• 完整版的最初发布版本。	1
---------------------	----------

6 Device Comparison Table

Device	Quick Output Discharge	Reverse Current Blocking	Package (Pin)	Body Size	Pin Pitch
TPS22954	Yes	No	DSQ (10)	2.00 mm x 2.00 mm	0.4 mm
			DQC (10)	2.00 mm x 3.00 mm	0.5 mm
TPS22953	No	Yes	DSQ (10)	2.00 mm x 2.00 mm	0.4 mm
			DQC (10)	2.00 mm x 3.00 mm	0.5 mm

7 Pin Configuration and Functions

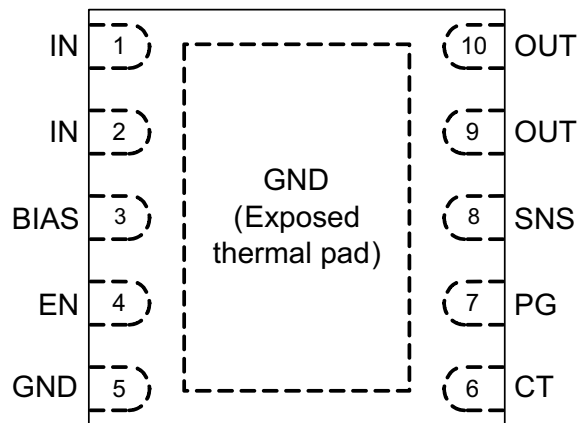

Top View

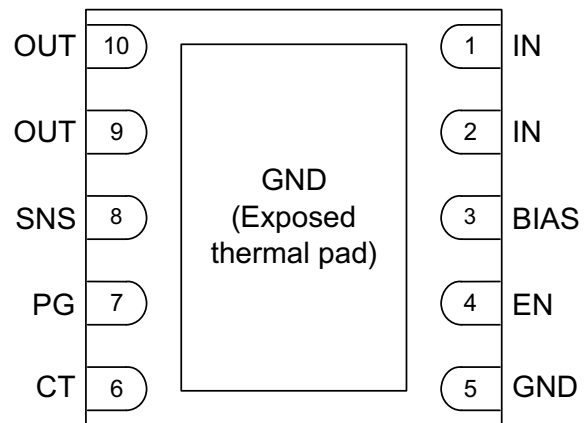

Bottom View

Pin Functions

PIN ⁽¹⁾		I/O	DESCRIPTION
NAME	NO.		
IN	1, 2	I	Switch input. Bypass this input with a ceramic capacitor to GND.
BIAS	3	I	Bias pin and power supply to the device.
EN	4	I	Active high switch enable/disable input. Also acts as the input UVLO pin. Use external resistor divider to adjust the UVLO level. Do not leave floating.
GND	5	–	Device ground.
CT	6	O	V_{OUT} slew rate control. Place ceramic cap from CT to GND to change the V_{OUT} slew rate of the device and limit the inrush current. CT Capacitor should be rated to 25V or higher.
PG	7	O	Power good. This pin is open drain which will pull low when the voltage on EN and/or SNS is below their respective VIL level.
SNS	8	I	Sense pin. Use external resistor divider to adjust the power good level. Do not leave floating.
OUT	9, 10	O	Switch output.
Thermal Pad	–	–	Exposed thermal pad. Tie to GND.

(1) Pinout applies to all package versions.

8 Specifications

8.1 Absolute Maximum Ratings

Over operating free-air temperature range (unless otherwise noted) ⁽¹⁾

		MIN	MAX	UNIT
V _{IN}	Input voltage range	-0.3	6	V
V _{BIAS}	Bias voltage range	-0.3	6	V
V _{OUT}	Output voltage range	-0.3	6	V
V _{EN} , V _{SNS} , V _{PG}	EN, SNS, and PG voltage range	-0.3	6	V
I _{MAX}	Maximum Continuous Switch Current, T _A = 70°C		5	A
I _{PLS}	Maximum Pulsed Switch Current, pulse <300µs, 2% duty cycle		7	A
T _{J,MAX}	Maximum junction temperature	Internally limited ⁽²⁾		
T _{stg}	Storage temperature range	-65	150	°C

- (1) Stresses beyond those listed under *Absolute Maximum Ratings* may cause permanent damage to the device. These are stress ratings only, which do not imply functional operation of the device at these or any other conditions beyond those indicated under *Recommended Operating Conditions*. Exposure to absolute-maximum-rated conditions for extended periods may affect device reliability.
- (2) See TSD specification in *Electrical Characteristics* section and *Thermal Considerations* section.

8.2 ESD Ratings

		VALUE	UNIT
V _(ESD)	Electrostatic discharge	Human-body model (HBM), per ANSI/ESDA/JEDEC JS-001 ⁽¹⁾	±2000
		Charged-device model (CDM), per JEDEC specification JESD22-C101 ⁽²⁾	±750

- (1) JEDEC document JEP155 states that 500-V HBM allows safe manufacturing with a standard ESD control process. Manufacturing with less than 500-V HBM is possible with the necessary precautions.
- (2) JEDEC document JEP157 states that 250-V CDM allows safe manufacturing with a standard ESD control process. Manufacturing with less than 250-V CDM is possible with the necessary precautions.

8.3 Recommended Operating Conditions

Over operating free-air temperature range (unless otherwise noted)

		MIN	MAX	UNIT
V _{IN}	Input voltage range	0.7	V _{BIAS}	V
V _{BIAS}	Bias voltage range	2.5	5.7	V
V _{OUT}	Output voltage range	0	5.7	V
V _{EN} , V _{SNS} , V _{PG}	EN, SNS, and PG voltage range	0	5.7	V
T _A ⁽¹⁾	Operating free-air temperature range	-40	105	°C
T _J	Operating Junction Temperature	-40	125	°C

- (1) In applications where high power dissipation and/or poor package thermal resistance is present, the maximum ambient temperature may have to be derated. Maximum ambient temperature [T_{A(max)}] is dependent on the maximum operating junction temperature [T_{J(max)}], the maximum power dissipation of the device in the application [P_{D(max)}], and the junction-to-ambient thermal resistance of the part/package in the application (θ_{JA}), as given by the following equation: T_{A(max)} = T_{J(max)} - (θ_{JA} × P_{D(max)})

8.4 Thermal Information

THERMAL METRIC ⁽¹⁾		TPS22953/54		UNIT
		DQC-10	DSQ-10	
R _{θJA}	Junction-to-ambient thermal resistance	65.2	63.5	°C/W
R _{θJC(top)}	Junction-to-case (top) thermal resistance	73.9	81.6	
R _{θJB}	Junction-to-board thermal resistance	25.5	34.1	
ψ _{JT}	Junction-to-top characterization parameter	2	1.9	
ψ _{JB}	Junction-to-board characterization parameter	25.4	34.5	
R _{θJC(bot)}	Junction-to-case (bottom) thermal resistance	8.5	7.9	

(1) For more information about traditional and new thermal metrics, see the *IC Package Thermal Metrics* application report, [SPRA953](#).

8.5 Electrical Characteristics

Unless otherwise noted, the specification in the following table applies over the operating ambient temperature $-40\text{ °C} \leq T_A \leq 105\text{ °C}$ and the recommended V_{BIAS} voltage range of 2.5V to 5.7V. Typical values are for $T_A = 25\text{ °C}$.

PARAMETER		TEST CONDITIONS	T _A	MIN	TYP	MAX	UNIT
VOLTAGE THRESHOLDS							
V _{EN}	V _{IH} , Rising threshold	V _{IN} = 0.7V to V _{BIAS}	-40°C to 105°C	650	700	750	mV
	V _{IL} , Falling threshold	V _{IN} = 0.7V to V _{BIAS}	-40°C to 105°C	560	600	640	mV
V _{SNS}	V _{IH} , Rising threshold	V _{IN} = 0.7V to V _{BIAS}	-40°C to 105°C	465	515	565	mV
	V _{IL} , Falling threshold	V _{IN} = 0.7V to V _{BIAS}	-40°C to 105°C	410	455	500	mV
TIMINGS							
t _{BLANK}	Blanking time for EN and SNS	EN or SNS Rising	-40°C to 105°C	100			μs
t _{DEGLITCH}	Deglitch time for EN and SNS	EN or SNS Falling	-40°C to 105°C	5			μs
t _{DIS}	Output discharge time (TPS22954 Only)	C _L = 100 μF	-40°C to 105°C			10	ms
t _{RESTART}	Output Restart Time	SNS Falling	-40°C to 105°C	2			ms
THERMAL CHARACTERISTICS							
T _{SD}	Thermal shutdown	Junction Temperature Rising	-	130	150	170	°C
TSD _{HYS}	Thermal shutdown hysteresis	Junction Temperature Falling	-	20			°C

8.6 Electrical Characteristics, $V_{BIAS} = 5\text{ V}$

Unless otherwise noted, the specification in the following table applies over the operating ambient temperature $-40\text{ °C} \leq T_A \leq 105\text{ °C}$ and $V_{BIAS} = 5\text{ V}$. Typical values are for $T_A = 25\text{ °C}$.

PARAMETER		TEST CONDITIONS	T_A	MIN	TYP	MAX	UNIT	
POWER SUPPLIES AND CURRENTS								
$I_{Q, BIAS}$	BIAS quiescent current	$I_{OUT} = 0$, $V_{IN} = 0.7\text{ V}$ to V_{BIAS} , $V_{EN} = 5\text{ V}$	-40°C to 85°C	34	45		μA	
			-40°C to 105°C			50		
$I_{SD, BIAS}$	BIAS shutdown current	$V_{OUT} = 0\text{ V}$, $V_{IN} = 0.7\text{ V}$ to V_{BIAS} , $V_{EN} = 0\text{ V}$	-40°C to 85°C	5	7		μA	
			-40°C to 105°C			8	μA	
$I_{SD, IN}$	Input shutdown current	$V_{EN} = 0\text{ V}$, $V_{OUT} = 0\text{ V}$	$V_{IN} = 5.0\text{ V}$	-40°C to 85°C	0.02	4	μA	
				-40°C to 105°C				13
			$V_{IN} = 3.3\text{ V}$	-40°C to 85°C	0.01	3		
				-40°C to 105°C				10
			$V_{IN} = 1.8\text{ V}$	-40°C to 85°C	0.01	3		
				-40°C to 105°C				10
			$V_{IN} = 1.2\text{ V}$	-40°C to 85°C	0.01	2		
				-40°C to 105°C				8
$V_{IN} = 0.7\text{ V}$	-40°C to 85°C	0.01	2					
	-40°C to 105°C			8				
I_{EN}	EN pin input leakage current	$V_{EN} = 0\text{ V}$ to 5.7 V	-40°C to 105°C			0.1	μA	
I_{SNS}	SNS pin input leakage current	$V_{SNS} \leq V_{BIAS}$	-40°C to 105°C			0.1	μA	
RESISTANCE CHARACTERISTICS								
R_{ON}	ON-state resistance	$I_{OUT} = -200\text{ mA}$	$V_{IN} = 5.0\text{ V}$	25°C	14	20	$\text{m}\Omega$	
				-40°C to 85°C				23
				-40°C to 105°C				24
			$V_{IN} = 3.3\text{ V}$	25°C	14	20	$\text{m}\Omega$	
				-40°C to 85°C				23
				-40°C to 105°C				24
			$V_{IN} = 1.8\text{ V}$	25°C	14	20	$\text{m}\Omega$	
				-40°C to 85°C				23
				-40°C to 105°C				24
			$V_{IN} = 1.5\text{ V}$	25°C	14	20	$\text{m}\Omega$	
				-40°C to 85°C				23
				-40°C to 105°C				24
			$V_{IN} = 1.2\text{ V}$	25°C	14	20	$\text{m}\Omega$	
				-40°C to 85°C				23
				-40°C to 105°C				24
			$V_{IN} = 0.7\text{ V}$	25°C	14	20	$\text{m}\Omega$	
				-40°C to 85°C				23
				-40°C to 105°C				24
R_{PD}	Output pulldown resistance (TPS22954 Only)	$V_{IN} = V_{OUT} = V_{BIAS}$, $V_{EN} = 0\text{ V}$	25°C	15	28	Ω		
			-40°C to 105°C			30	Ω	

8.7 Electrical Characteristics, $V_{BIAS} = 3.3\text{ V}$

Unless otherwise noted, the specification in the following table applies over the operating ambient temperature $-40\text{ }^{\circ}\text{C} \leq T_A \leq 105\text{ }^{\circ}\text{C}$ and $V_{BIAS} = 3.3\text{ V}$. Typical values are for $T_A = 25\text{ }^{\circ}\text{C}$.

PARAMETER		TEST CONDITIONS	T_A	MIN	TYP	MAX	UNIT	
POWER SUPPLIES AND CURRENTS								
$I_{Q, BIAS}$	BIAS quiescent current	$I_{OUT} = 0$, $V_{IN} = 0.7\text{ V}$ to V_{BIAS} , $V_{EN} = 5\text{ V}$	-40°C to 85°C	19	35		μA	
			-40°C to 105°C			37		
$I_{SD, BIAS}$	BIAS shutdown current	$V_{OUT} = 0\text{ V}$, $V_{IN} = 0.7\text{ V}$ to V_{BIAS} , $V_{EN} = 0\text{ V}$	-40°C to 85°C	4	6		μA	
			-40°C to 105°C			7	μA	
$I_{SD, IN}$	Input shutdown current	$V_{EN} = 0\text{ V}$, $V_{OUT} = 0\text{ V}$	$V_{IN} = 3.3\text{ V}$	-40°C to 85°C	0.01	3	μA	
				-40°C to 105°C				10
			$V_{IN} = 1.8\text{ V}$	-40°C to 85°C	0.01	3		
				-40°C to 105°C				10
			$V_{IN} = 1.2\text{ V}$	-40°C to 85°C	0.01	2		
				-40°C to 105°C				8
			$V_{IN} = 0.7\text{ V}$	-40°C to 85°C	0.01	2		
				-40°C to 105°C				8
I_{EN}	EN pin input leakage current	$V_{EN} = 0\text{ V}$ to 5.7 V	-40°C to 105°C			0.1	μA	
I_{SNS}	SNS pin input leakage current	$V_{SNS} = 0\text{ V}$ to V_{BIAS}	-40°C to 105°C			0.1	μA	
RESISTANCE CHARACTERISTICS								
R_{ON}	ON-state resistance	$I_{OUT} = -200\text{ mA}$	$V_{IN} = 3.3\text{ V}$	25°C	15	21	$\text{m}\Omega$	
				-40°C to 85°C				24
				-40°C to 105°C				25
			$V_{IN} = 1.8\text{ V}$	25°C	14	20	$\text{m}\Omega$	
				-40°C to 85°C				23
				-40°C to 105°C				24
			$V_{IN} = 1.5\text{ V}$	25°C	14	20	$\text{m}\Omega$	
				-40°C to 85°C				23
				-40°C to 105°C				24
			$V_{IN} = 1.2\text{ V}$	25°C	14	20	$\text{m}\Omega$	
				-40°C to 85°C				23
				-40°C to 105°C				24
$V_{IN} = 0.7\text{ V}$	25°C	14	20	$\text{m}\Omega$				
	-40°C to 85°C				23			
	-40°C to 105°C				24			
R_{PD}	Output pulldown resistance (TPS22954 Only)	$V_{IN} = V_{OUT} = V_{BIAS}$, $V_{EN} = 0\text{ V}$	25°C	13	28	Ω		
			-40°C to 105°C			30	Ω	

8.8 Electrical Characteristics, $V_{BIAS} = 2.5\text{ V}$

Unless otherwise noted, the specification in the following table applies over the operating ambient temperature $-40\text{ }^{\circ}\text{C} \leq T_A \leq 105\text{ }^{\circ}\text{C}$ and $V_{BIAS} = 2.5\text{ V}$. Typical values are for $T_A = 25\text{ }^{\circ}\text{C}$.

PARAMETER		TEST CONDITIONS	T_A	MIN	TYP	MAX	UNIT
POWER SUPPLIES AND CURRENTS							
$I_{Q, BIAS}$	BIAS quiescent current	$I_{OUT} = 0$, $V_{IN} = 0.7\text{ V}$ to V_{BIAS} , $V_{EN} = 5\text{ V}$	-40°C to 85°C	16	25		μA
			-40°C to 105°C			27	
$I_{SD, BIAS}$	BIAS shutdown current	$V_{OUT} = 0\text{ V}$, $V_{IN} = 0.7\text{ V}$ to V_{BIAS} , $V_{EN} = 0\text{ V}$	-40°C to 85°C	4	5		μA
			-40°C to 105°C			6	μA
$I_{SD, IN}$	Input shutdown current	$V_{EN} = 0\text{ V}$, $V_{OUT} = 0\text{ V}$	$V_{IN} = 2.5\text{ V}$	-40°C to 85°C	0.01	3	μA
				-40°C to 105°C		10	
			$V_{IN} = 1.8\text{ V}$	-40°C to 85°C	0.01	3	
				-40°C to 105°C		10	
			$V_{IN} = 1.2\text{ V}$	-40°C to 85°C	0.01	2	
				-40°C to 105°C		8	
			$V_{IN} = 0.7\text{ V}$	-40°C to 85°C	0.01	2	
				-40°C to 105°C		8	
I_{EN}	EN pin input leakage current	$V_{EN} = 0\text{ V}$ to 5.7 V	-40°C to 105°C			0.1	μA
I_{SNS}	SNS pin input leakage current	$V_{SNS} = 0\text{ V}$ to V_{BIAS}	-40°C to 105°C			0.1	μA
RESISTANCE CHARACTERISTICS							
R_{ON}	ON-state resistance	$I_{OUT} = -200\text{ mA}$	$V_{IN} = 2.5\text{ V}$	25°C	16	23	$\text{m}\Omega$
				-40°C to 85°C		26	
				-40°C to 105°C		27	
			$V_{IN} = 1.8\text{ V}$	25°C	15	22	$\text{m}\Omega$
				-40°C to 85°C		25	
				-40°C to 105°C		26	
			$V_{IN} = 1.5\text{ V}$	25°C	15	22	$\text{m}\Omega$
				-40°C to 85°C		25	
			$V_{IN} = 1.2\text{ V}$	-40°C to 105°C		26	
				25°C	15	22	$\text{m}\Omega$
				-40°C to 85°C		24	
			-40°C to 105°C		25		
$V_{IN} = 0.7\text{ V}$	25°C	14	21	$\text{m}\Omega$			
	-40°C to 85°C		24				
	-40°C to 105°C		25				
R_{PD}	Output pulldown resistance (TPS22954 Only)	$V_{IN} = V_{OUT} = V_{BIAS}$, $V_{EN} = 0\text{ V}$	25°C	12	28	Ω	
			-40°C to 105°C		30	Ω	

8.9 Switching Characteristics, CT = 1000 pF

Refer to the timing test circuit in Figure 1 (unless otherwise noted) for references to external components used for the test condition in the switching characteristics table. Switching characteristics shown below are only valid for the power-up sequence where V_{IN} and V_{BIAS} are already in steady state condition before the EN terminal is asserted high.

PARAMETER		TEST CONDITION	MIN	TYP	MAX	UNIT
$V_{IN} = 5V, V_{EN} = V_{BIAS} = 5V, T_A = 25^\circ C$						
t_{ON}	Turn-on time	$R_L = 10 \Omega, C_L = 0.1 \mu F, CT = 1000 pF$		1265		μs
t_{OFF}	Turn-off time			6.0		
t_R	V_{OUT} rise time			1492		
t_F	V_{OUT} fall time			2.2		
t_D	ON delay time			519		
$V_{IN} = 2.5V, V_{EN} = V_{BIAS} = 5V, T_A = 25^\circ C$						
t_{ON}	Turn-on time	$R_L = 10 \Omega, C_L = 0.1 \mu F, CT = 1000 pF$		813		μs
t_{OFF}	Turn-off time			6.1		
t_R	V_{OUT} rise time			765		
t_F	V_{OUT} fall time			2.2		
t_D	ON delay time			430		
$V_{IN} = 0.7V, V_{EN} = V_{BIAS} = 5V, T_A = 25^\circ C$						
t_{ON}	Turn-on time	$R_L = 10 \Omega, C_L = 0.1 \mu F, CT = 1000 pF$		476		μs
t_{OFF}	Turn-off time			6.2		
t_R	V_{OUT} rise time			245		
t_F	V_{OUT} fall time			2.1		
t_D	ON delay time			353		
$V_{IN} = 2.5V, V_{EN} = 5V, V_{BIAS} = 2.5V, T_A = 25^\circ C$						
t_{ON}	Turn-on time	$R_L = 10 \Omega, C_L = 0.1 \mu F, CT = 1000 pF$		813		μs
t_{OFF}	Turn-off time			4.9		
t_R	V_{OUT} rise time			765		
t_F	V_{OUT} fall time			2.2		
t_D	ON delay time			430		
$V_{IN} = 0.7V, V_{EN} = 5V, V_{BIAS} = 2.5V, T_A = 25^\circ C$						
t_{ON}	Turn-on time	$R_L = 10 \Omega, C_L = 0.1 \mu F, CT = 1000 pF$		476		μs
t_{OFF}	Turn-off time			6.1		
t_R	V_{OUT} rise time			245		
t_F	V_{OUT} fall time			2.1		
t_D	ON delay time			353		

8.10 Switching Characteristics, CT = 0 pF

Refer to the timing test circuit in Figure 1 (unless otherwise noted) for references to external components used for the test condition in the switching characteristics table. Switching characteristics shown below are only valid for the power-up sequence where V_{IN} and V_{BIAS} are already in steady state condition before the EN terminal is asserted high.

PARAMETER		TEST CONDITION	MIN	TYP	MAX	UNIT
$V_{IN} = 5V, V_{EN} = V_{BIAS} = 5V, T_A = 25^\circ C$						
t_{ON}	Turn-on time	$R_L = 10 \Omega, C_L = 0.1 \mu F, CT = 0 pF$		235		μs
t_{OFF}	Turn-off time			6.0		
t_R	V_{OUT} rise time			140		
t_F	V_{OUT} fall time			2.2		
t_D	ON delay time			165		
$V_{IN} = 2.5V, V_{EN} = V_{BIAS} = 5V, T_A = 25^\circ C$						
t_{ON}	Turn-on time	$R_L = 10 \Omega, C_L = 0.1 \mu F, CT = 0 pF$		200		μs
t_{OFF}	Turn-off time			6		
t_R	V_{OUT} rise time			79		
t_F	V_{OUT} fall time			2.1		
t_D	ON delay time			160		
$V_{IN} = 0.7V, V_{EN} = V_{BIAS} = 5V, T_A = 25^\circ C$						
t_{ON}	Turn-on time	$R_L = 10 \Omega, C_L = 0.1 \mu F, CT = 0 pF$		170		μs
t_{OFF}	Turn-off time			6		
t_R	V_{OUT} rise time			32		
t_F	V_{OUT} fall time			2		
t_D	ON delay time			154		
$V_{IN} = 2.5V, V_{EN} = 5V, V_{BIAS} = 2.5V, T_A = 25^\circ C$						
t_{ON}	Turn-on time	$R_L = 10 \Omega, C_L = 0.1 \mu F, CT = 0 pF$		200		μs
t_{OFF}	Turn-off time			6		
t_R	V_{OUT} rise time			79		
t_F	V_{OUT} fall time			2.1		
t_D	ON delay time			160		
$V_{IN} = 0.7V, V_{EN} = 5V, V_{BIAS} = 2.5V, T_A = 25^\circ C$						
t_{ON}	Turn-on time	$R_L = 10 \Omega, C_L = 0.1 \mu F, CT = 0 pF$		170		μs
t_{OFF}	Turn-off time			6		
t_R	V_{OUT} rise time			32		
t_F	V_{OUT} fall time			2		
t_D	ON delay time			154		

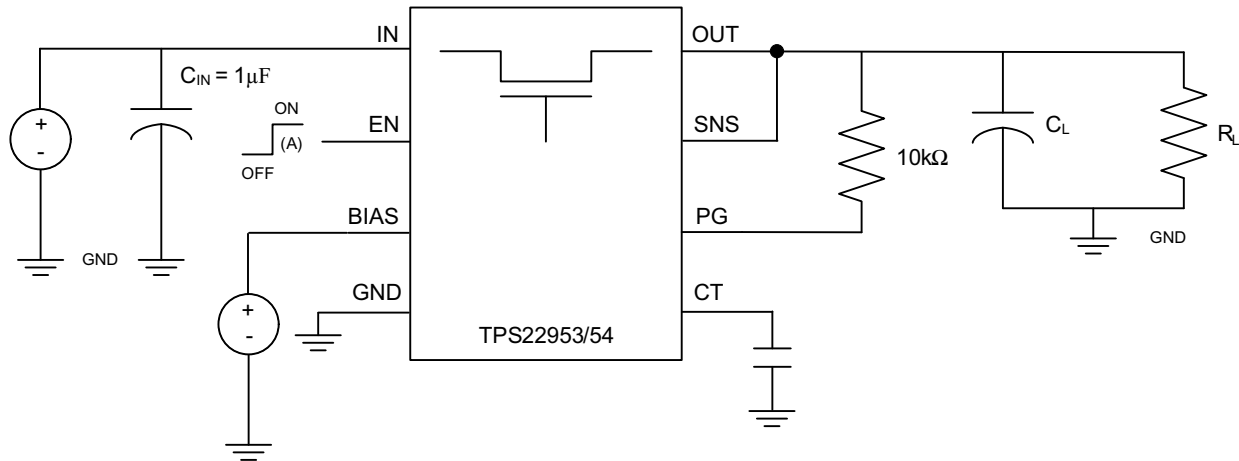

A. Rise and fall times of the control signal is 100 ns.

Figure 1. Timing Test Circuit

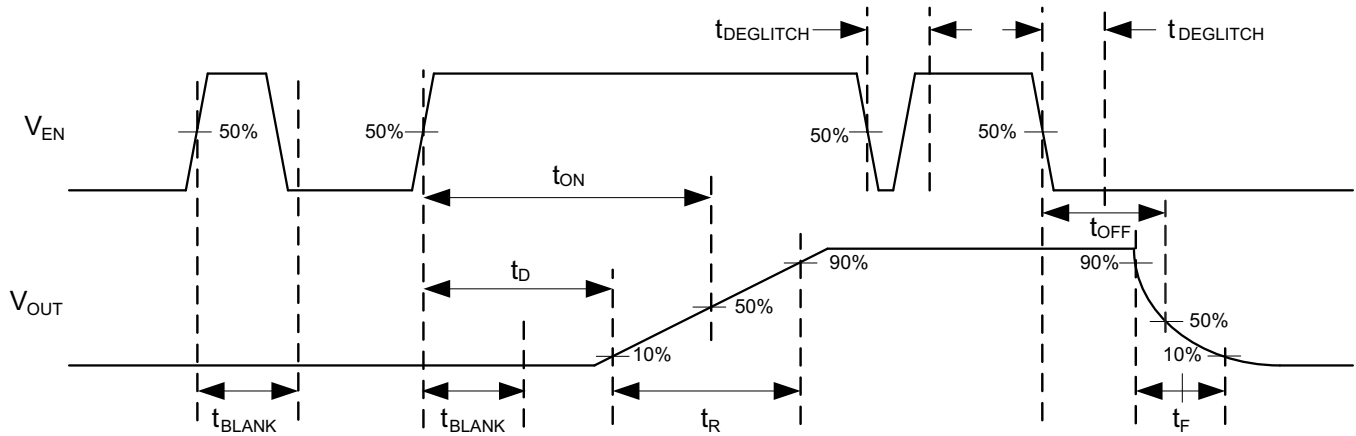

Figure 2. Timing Waveforms

8.11 Typical DC Characteristics

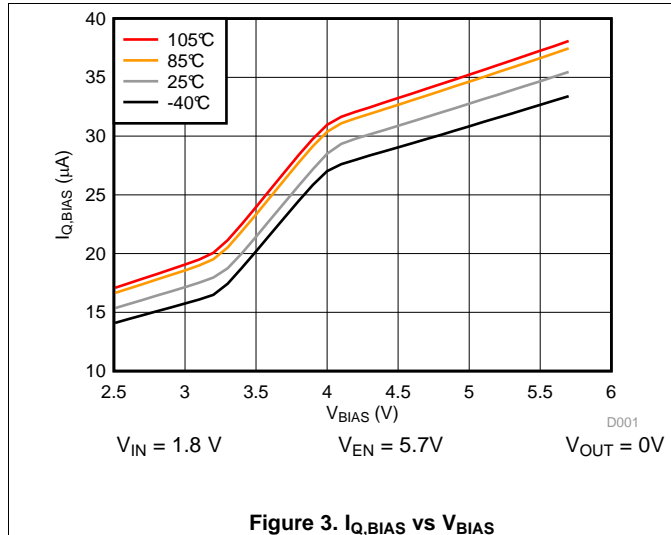

Figure 3. $I_{Q,BIAS}$ vs V_{BIAS}

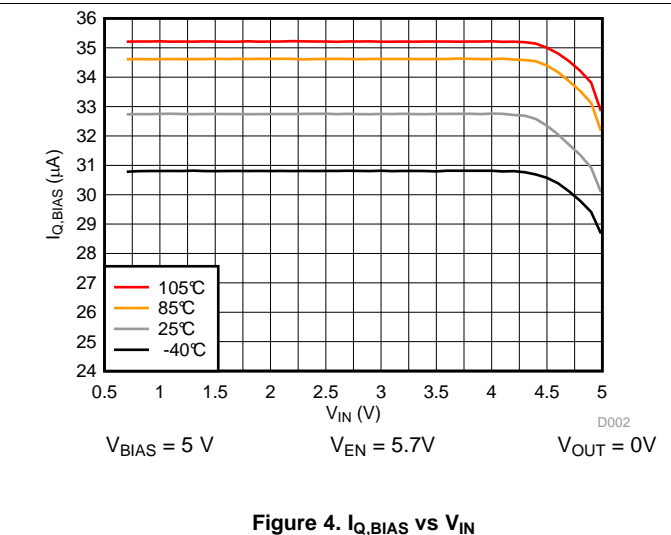

Figure 4. $I_{Q,BIAS}$ vs V_{IN}

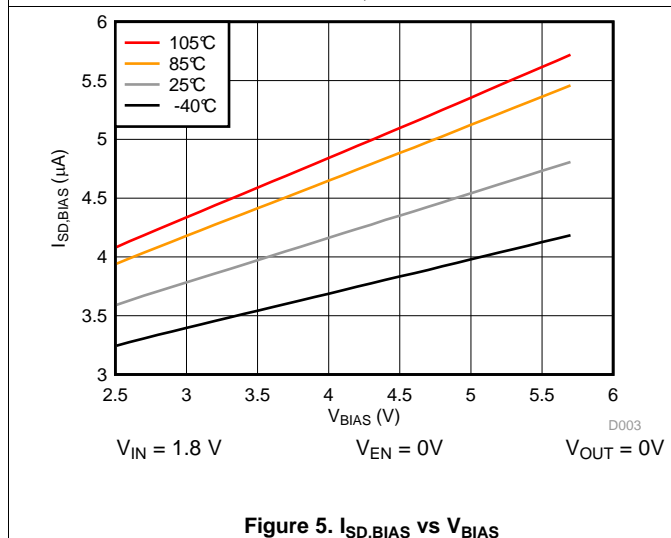

Figure 5. $I_{SD,BIAS}$ vs V_{BIAS}

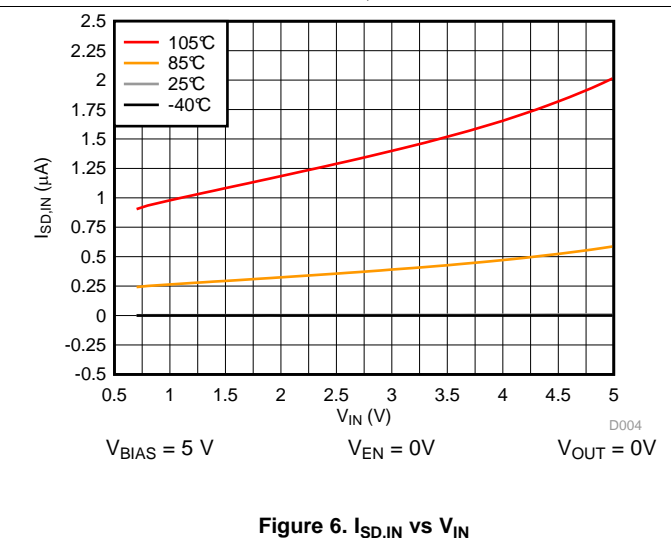

Figure 6. $I_{SD,IN}$ vs V_{IN}

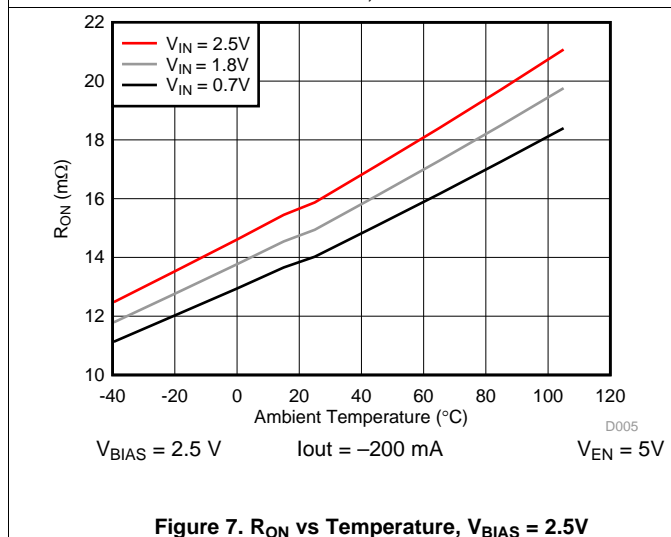

Figure 7. R_{ON} vs Temperature, $V_{BIAS} = 2.5V$

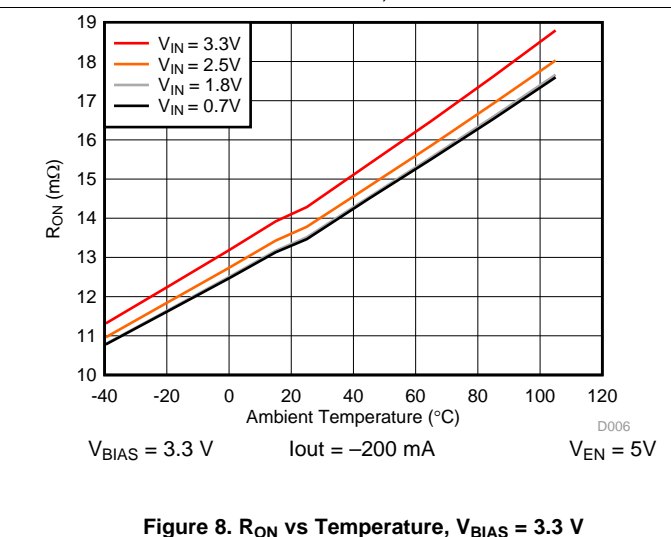

Figure 8. R_{ON} vs Temperature, $V_{BIAS} = 3.3V$

Typical DC Characteristics (continued)

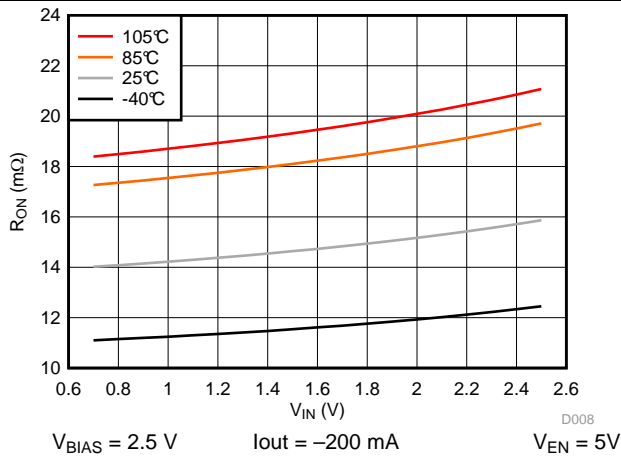

Figure 9. R_{ON} vs V_{IN} , $V_{BIAS} = 2.5\text{ V}$

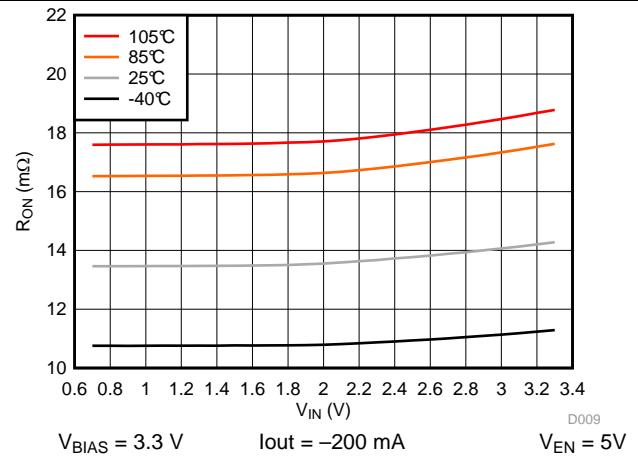

Figure 10. R_{ON} vs V_{IN} , $V_{BIAS} = 3.3\text{ V}$

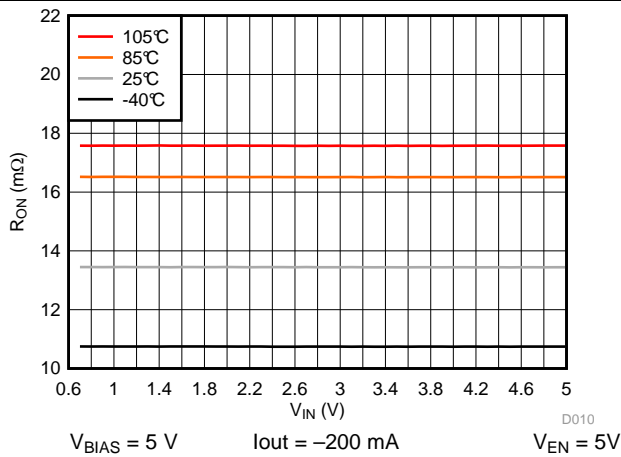

Figure 11. R_{ON} vs V_{IN} , $V_{BIAS} = 5\text{ V}$

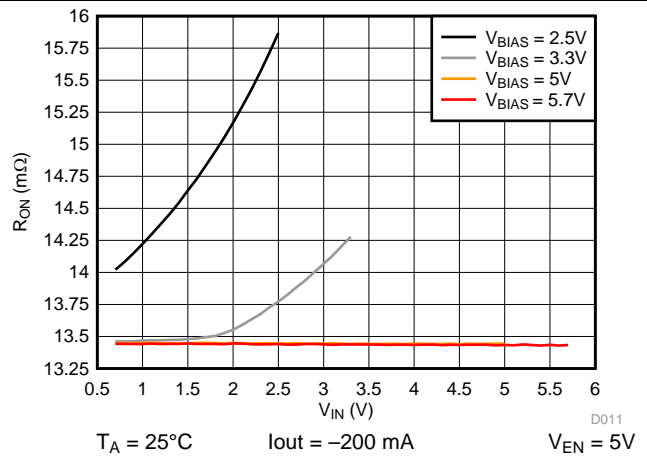

Figure 12. R_{ON} vs V_{IN}

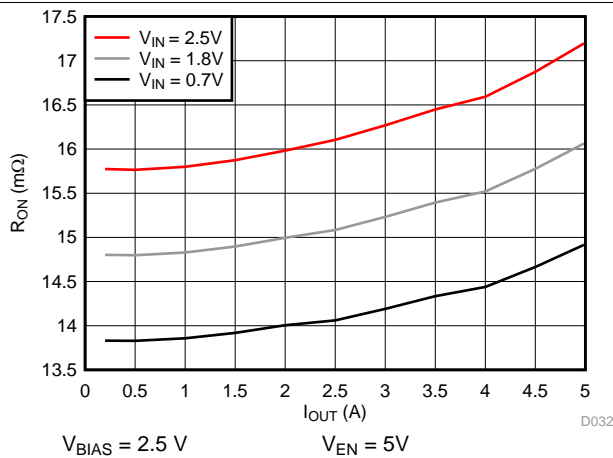

Figure 13. R_{ON} vs I_{OUT} , $V_{BIAS} = 2.5\text{ V}$

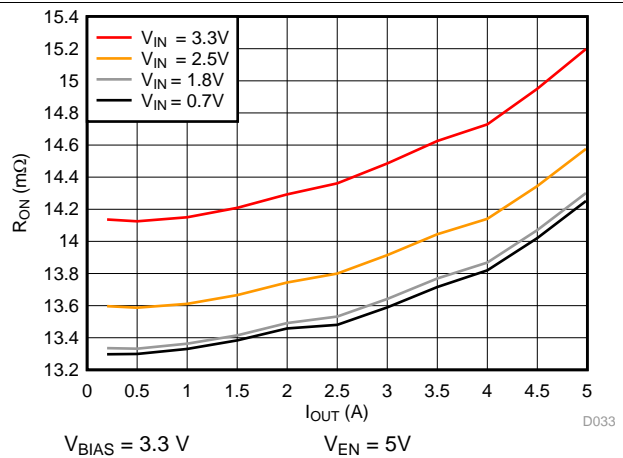

Figure 14. R_{ON} vs I_{OUT} , $V_{BIAS} = 3.3\text{ V}$

Typical DC Characteristics (continued)

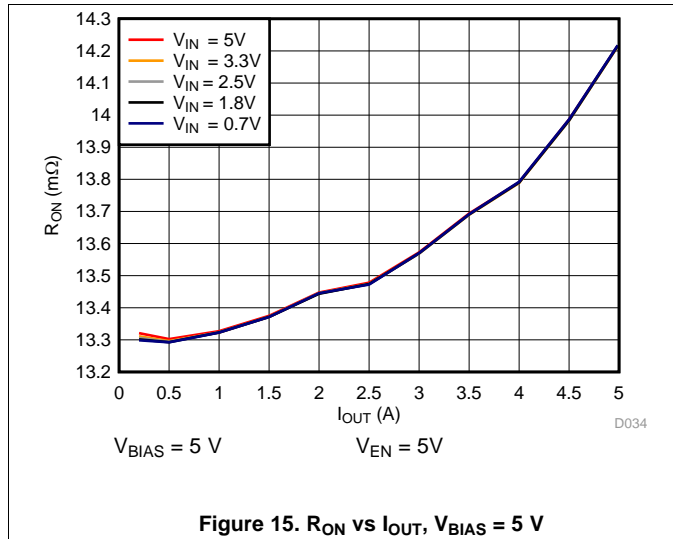

Figure 15. R_{ON} vs I_{OUT} , $V_{BIAS} = 5\text{ V}$

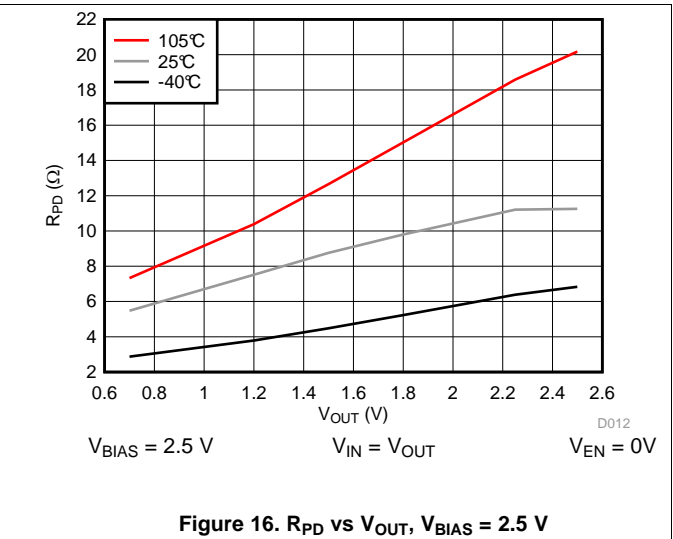

Figure 16. R_{PD} vs V_{OUT} , $V_{BIAS} = 2.5\text{ V}$

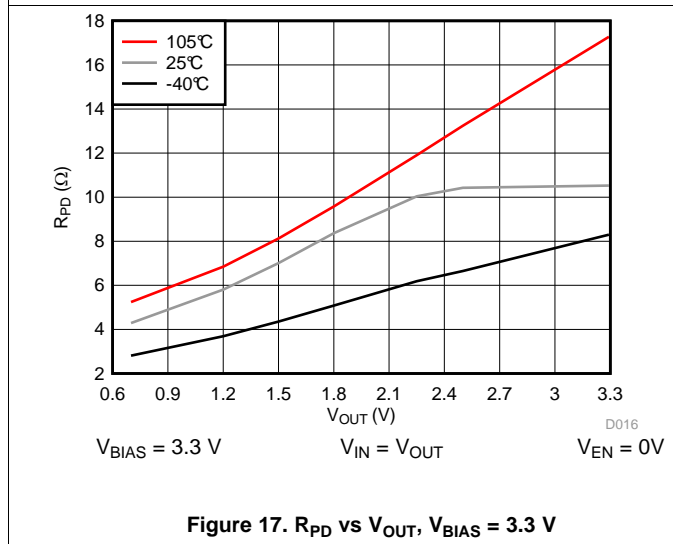

Figure 17. R_{PD} vs V_{OUT} , $V_{BIAS} = 3.3\text{ V}$

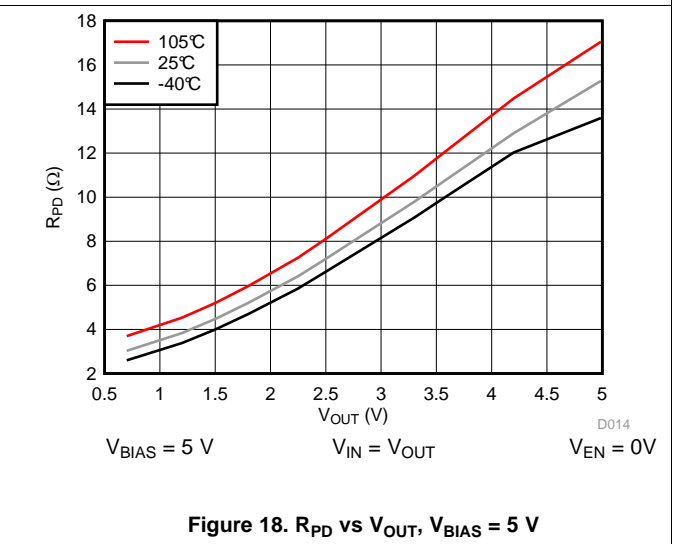

Figure 18. R_{PD} vs V_{OUT} , $V_{BIAS} = 5\text{ V}$

8.12 Typical Switching Characteristics

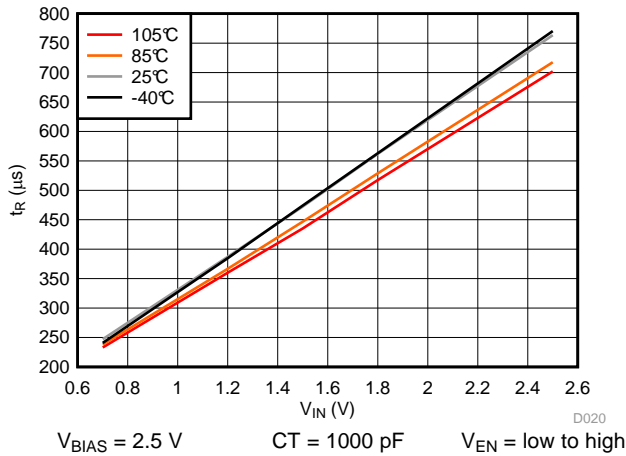

Figure 19. t_R vs V_{IN} , $V_{BIAS} = 2.5$ V

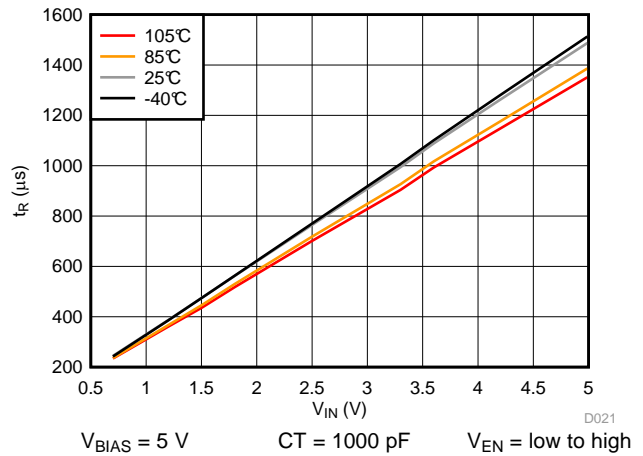

Figure 20. t_R vs V_{IN} , $V_{BIAS} = 5$ V

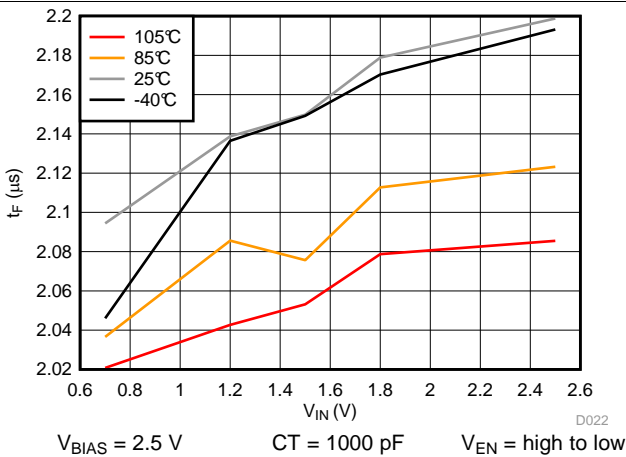

Figure 21. t_F vs V_{IN} , $V_{BIAS} = 2.5$ V

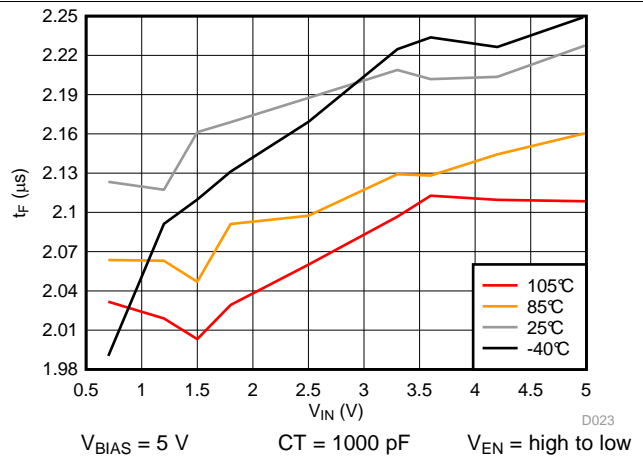

Figure 22. t_F vs V_{IN} , $V_{BIAS} = 5$ V

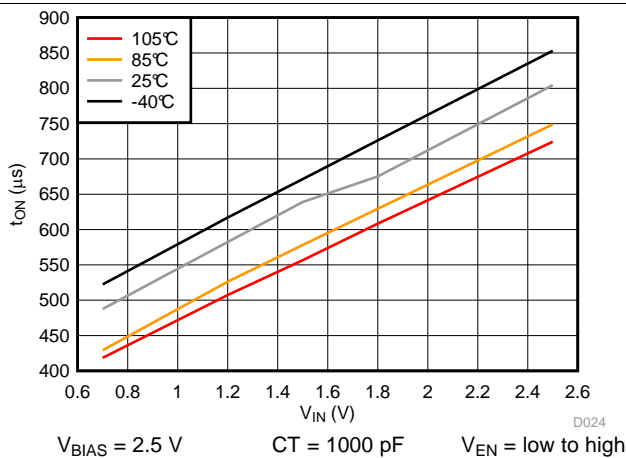

Figure 23. t_{ON} vs V_{IN} , $V_{BIAS} = 2.5$ V

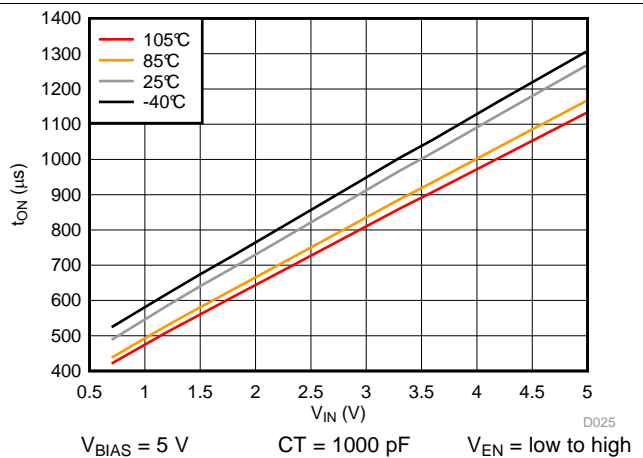
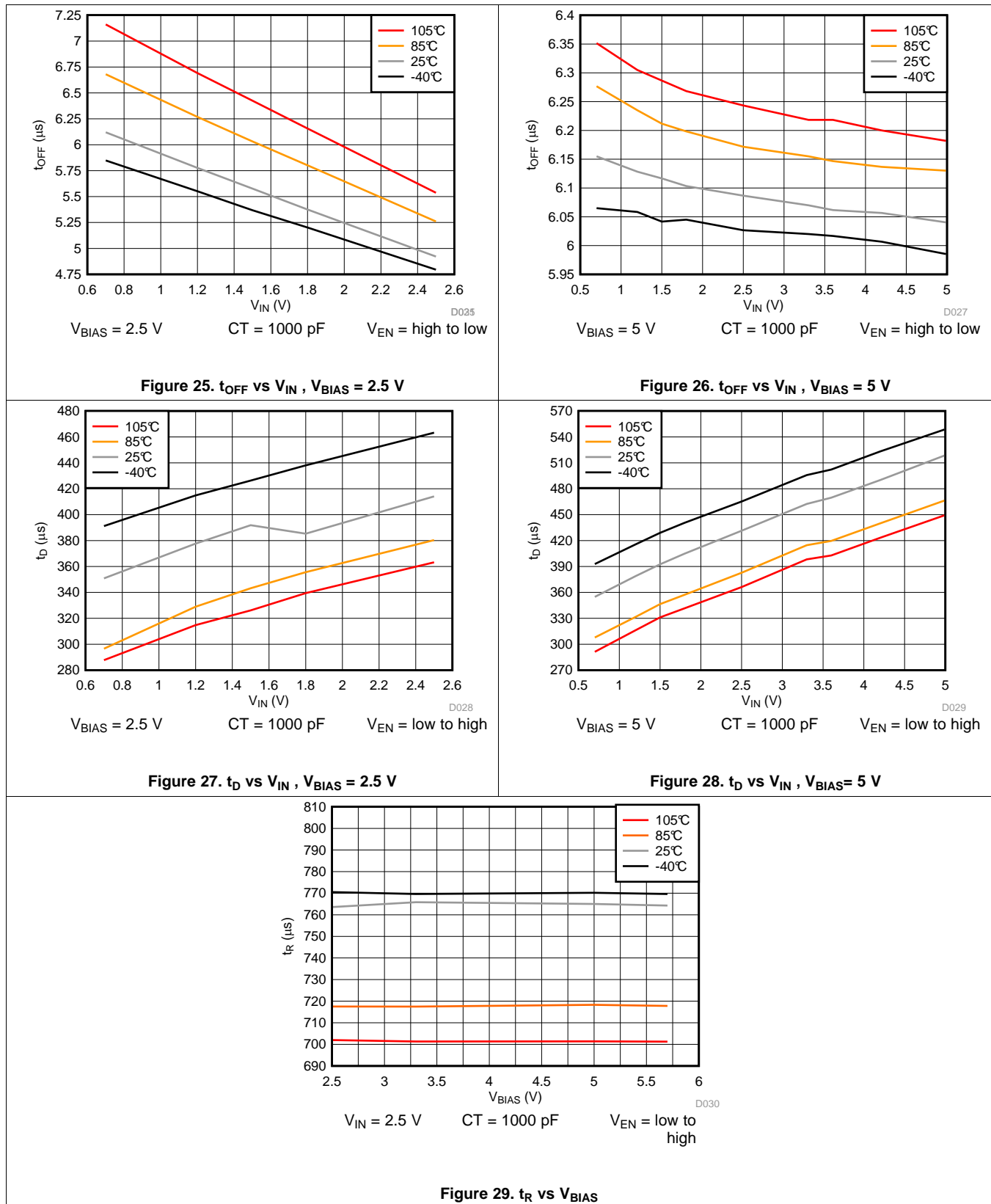

Figure 24. t_{ON} vs V_{IN} , $V_{BIAS} = 5$ V

Typical Switching Characteristics (continued)



Typical Switching Characteristics (continued)

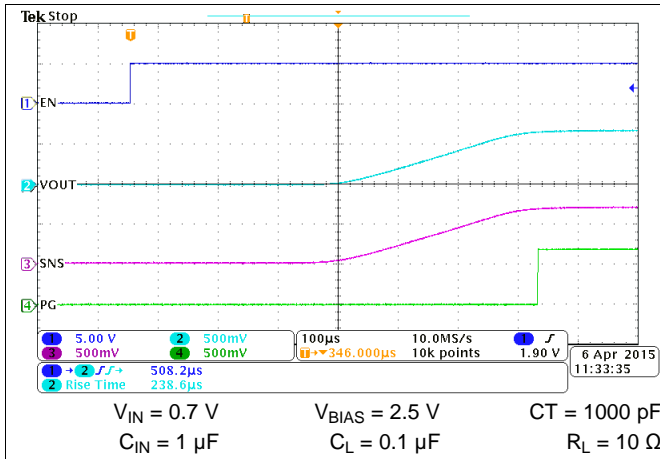

Figure 30. Turn On Waveform, $V_{BIAS} = 2.5\text{ V}$

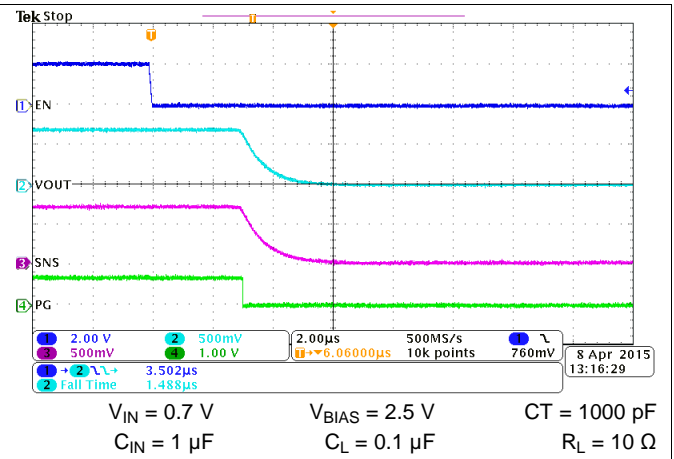

Figure 31. Turn Off Waveform, $V_{BIAS} = 2.5\text{ V}$

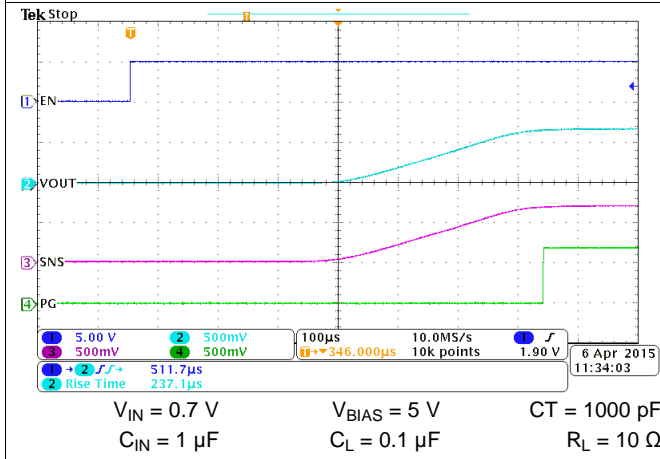

Figure 32. Turn On Waveform, $V_{BIAS} = 5\text{ V}$

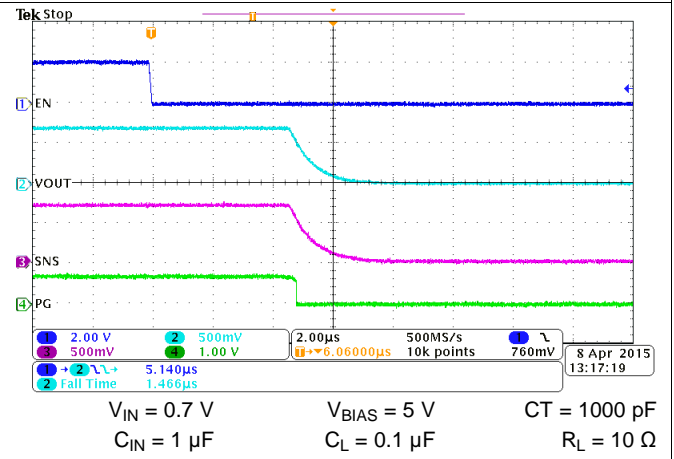

Figure 33. Turn Off Waveform, $V_{BIAS} = 5\text{ V}$

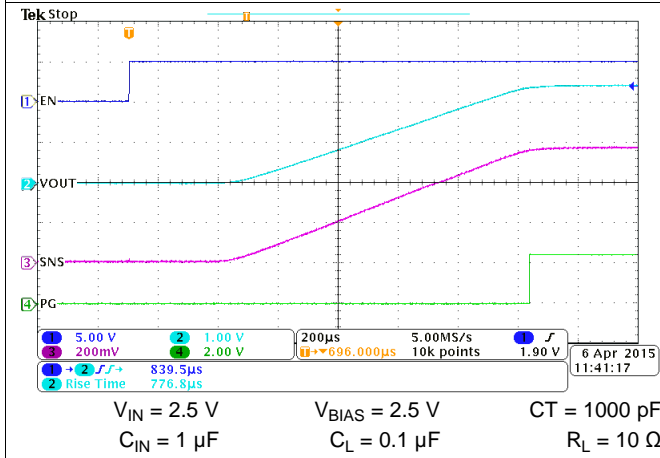

Figure 34. Turn On Waveform, $V_{BIAS} = 2.5\text{ V}$

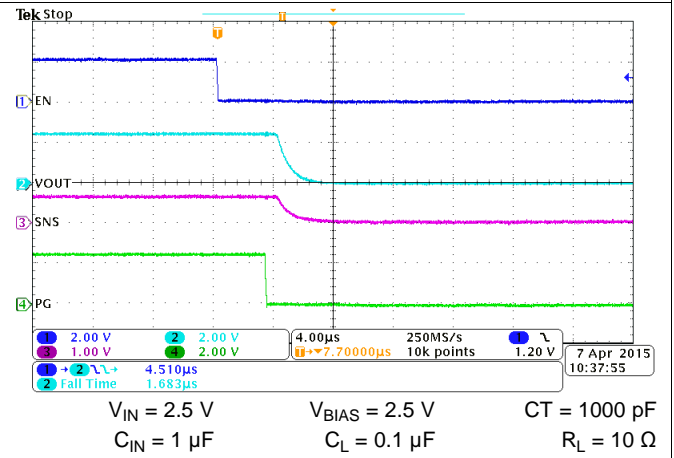

Figure 35. Turn Off Waveform, $V_{BIAS} = 2.5\text{ V}$

Typical Switching Characteristics (continued)

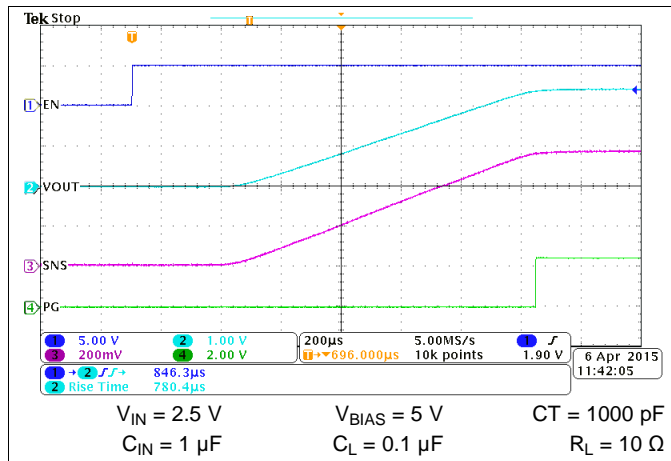

Figure 36. Turn On Waveform, $V_{BIAS} = 5\text{ V}$

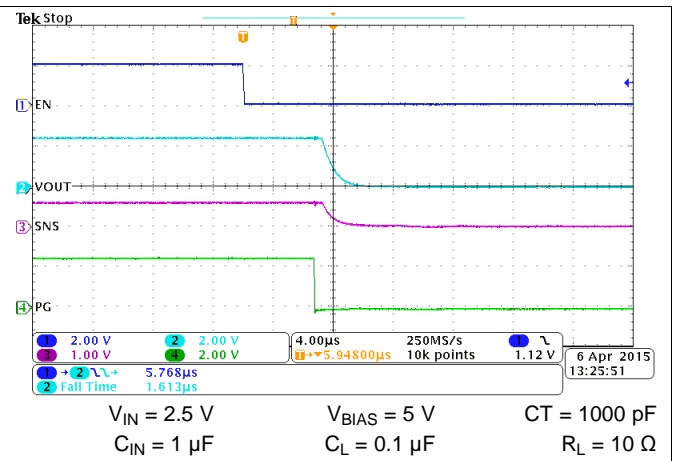

Figure 37. Turn Off Waveform, $V_{BIAS} = 5\text{ V}$

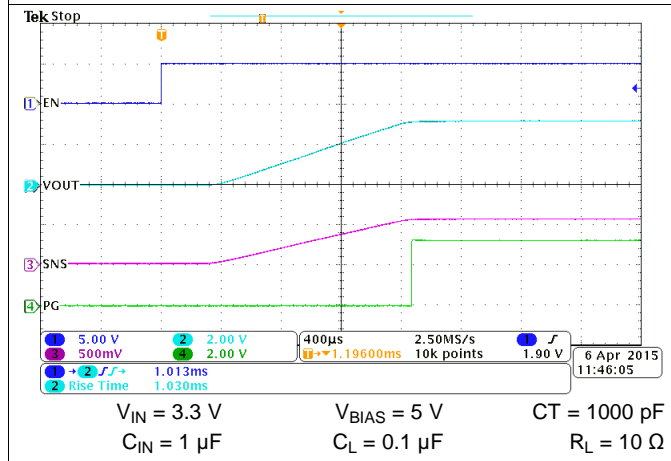

Figure 38. Turn On Waveform, $V_{BIAS} = 5\text{ V}$

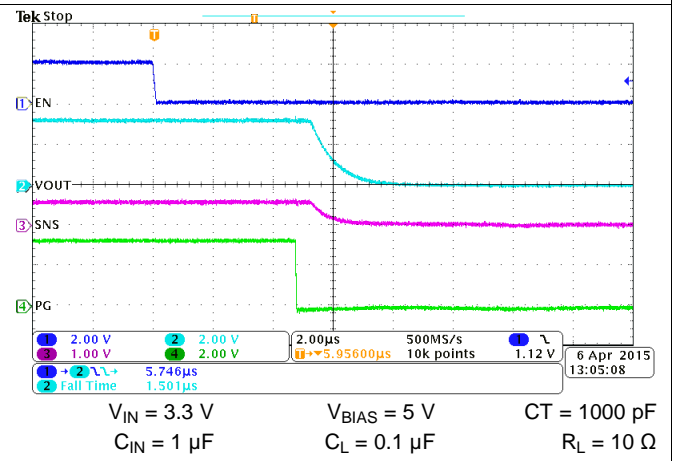

Figure 39. Turn Off Waveform, $V_{BIAS} = 5\text{ V}$

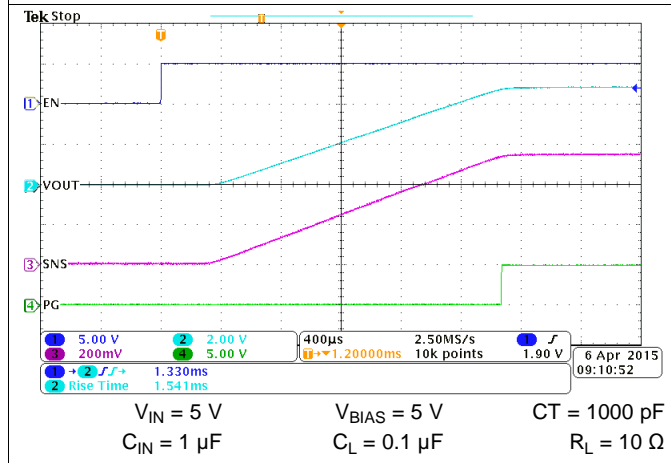

Figure 40. Turn On Waveform, $V_{BIAS} = 5\text{ V}$

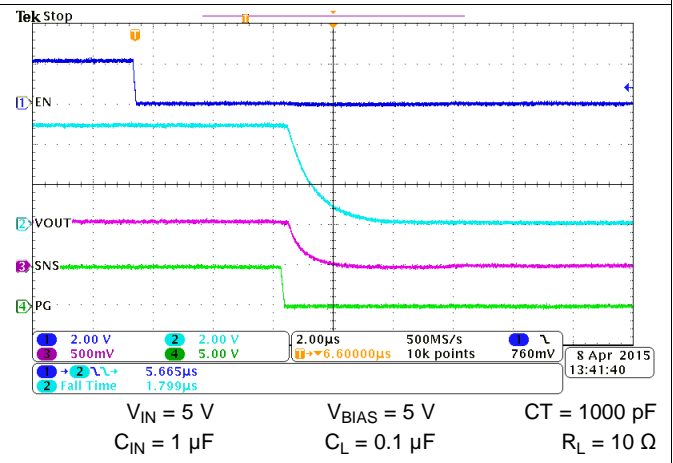

Figure 41. Turn Off Waveform, $V_{BIAS} = 5\text{ V}$

Typical Switching Characteristics (continued)

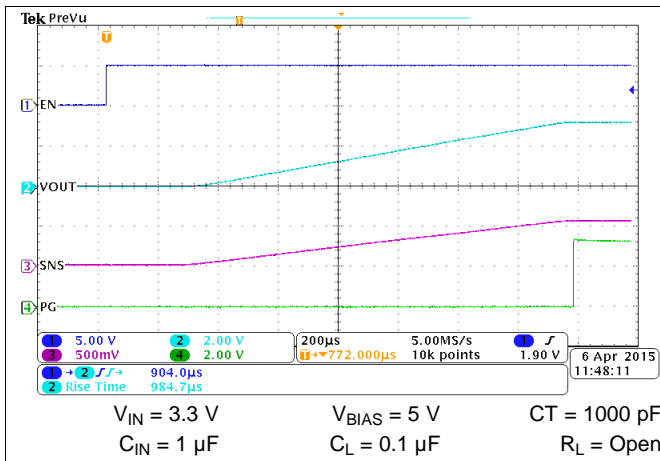

Figure 42. Turn On Waveform, No Load

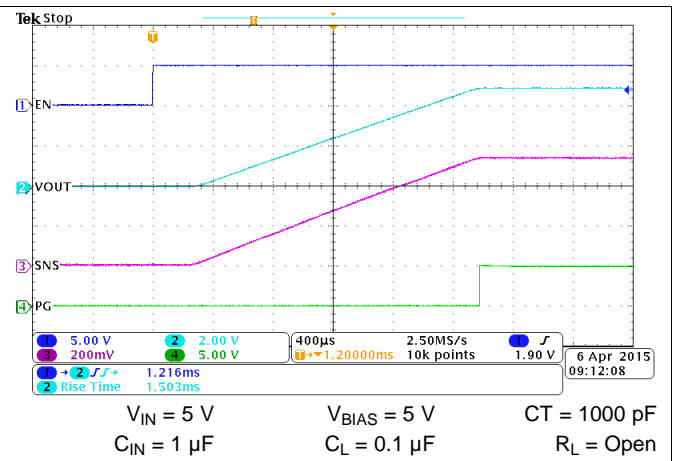

Figure 43. Turn On Waveform, No Load

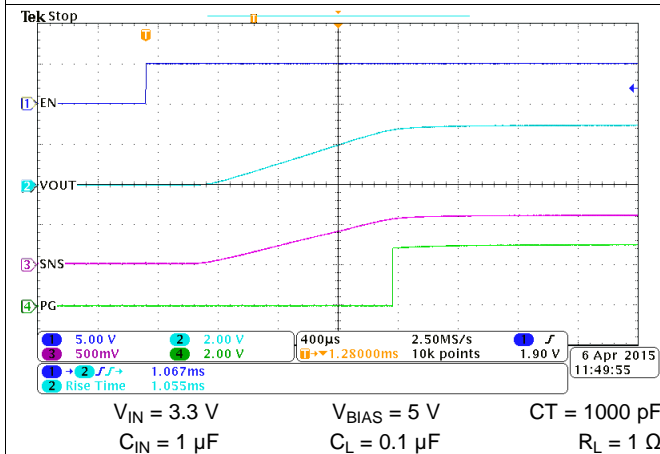

Figure 44. Turn On Waveform, Heavy Load

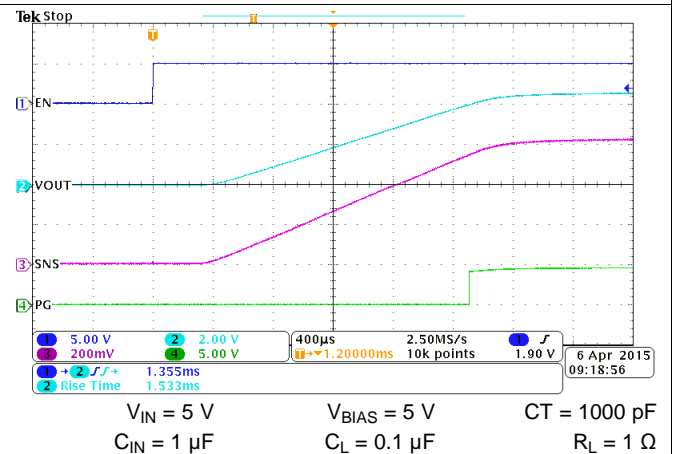

Figure 45. Turn On Waveform, Heavy Load

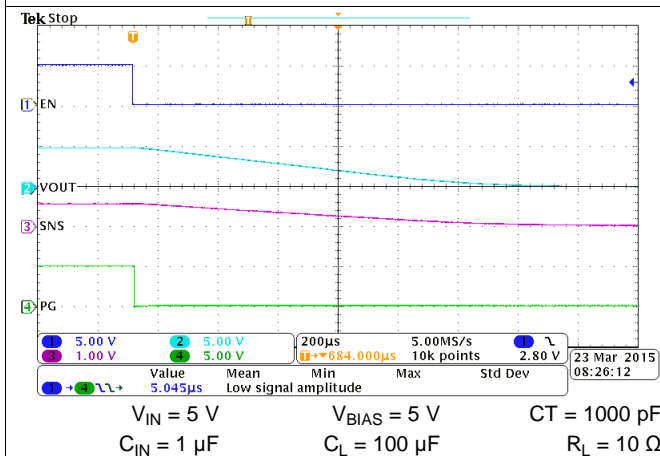

Figure 46. PG Response to EN Falling ($t_{DEGLITCH}$)

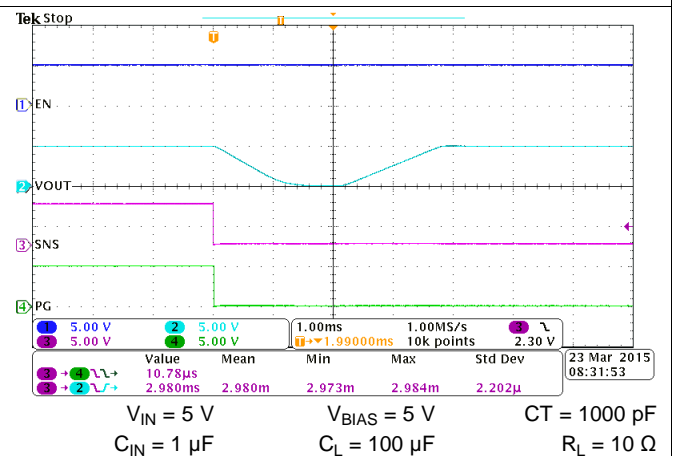
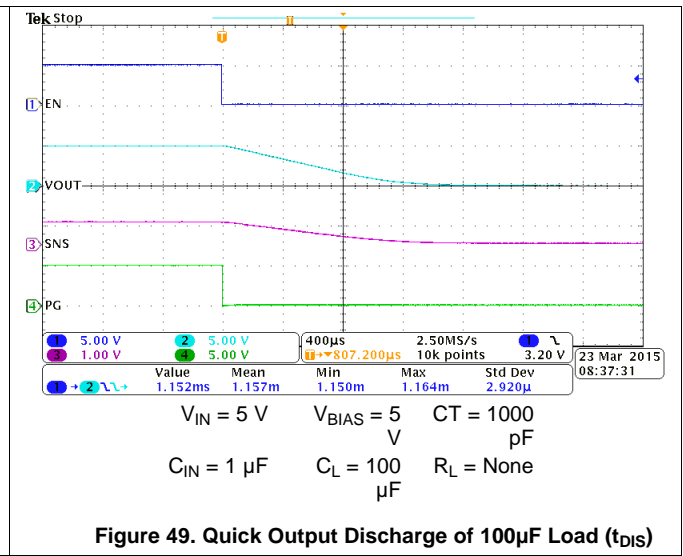
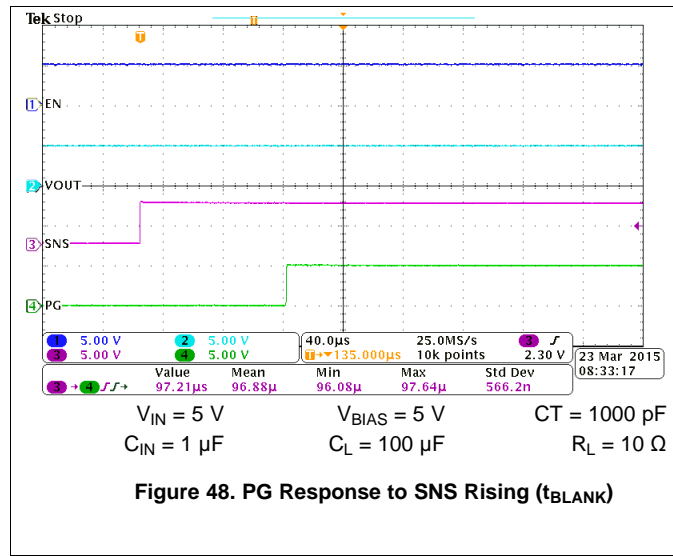

Figure 47. PG Response to SNS Falling with Auto-Restart ($t_{DEGLITCH}$ and $t_{RESTART}$)

Typical Switching Characteristics (continued)



9 Detailed Description

9.1 Overview

The TPS22953/4 are 5.7-V, 5-A load switches in 10-pin SON packages. To reduce voltage drop for low voltage, high current rails the device implements a low resistance N-channel MOSFET, which reduces the drop out voltage through the device at high currents. The integrated adjustable undervoltage lockout (UVLO) and adjustable power good (PG) threshold provides voltage monitoring as well as robust power sequencing.

The adjustable rise time control of the device greatly reduces inrush current for a wide variety of bulk load capacitances, thereby reducing or eliminating power supply droop. The switch is independently controlled by an on/off input (EN), which is capable of interfacing directly with low-voltage control signals. A 15 Ω on-chip load resistor is integrated into the device for output quick discharge when switch is turned off.

During shutdown, the device has very low leakage currents, thereby reducing unnecessary leakages for downstream modules during standby. Integrated power monitoring functionality, control logic, driver, power supply, and output discharge FET eliminates the need for any external components, which reduces solution size and BOM count.

9.2 Functional Block Diagram

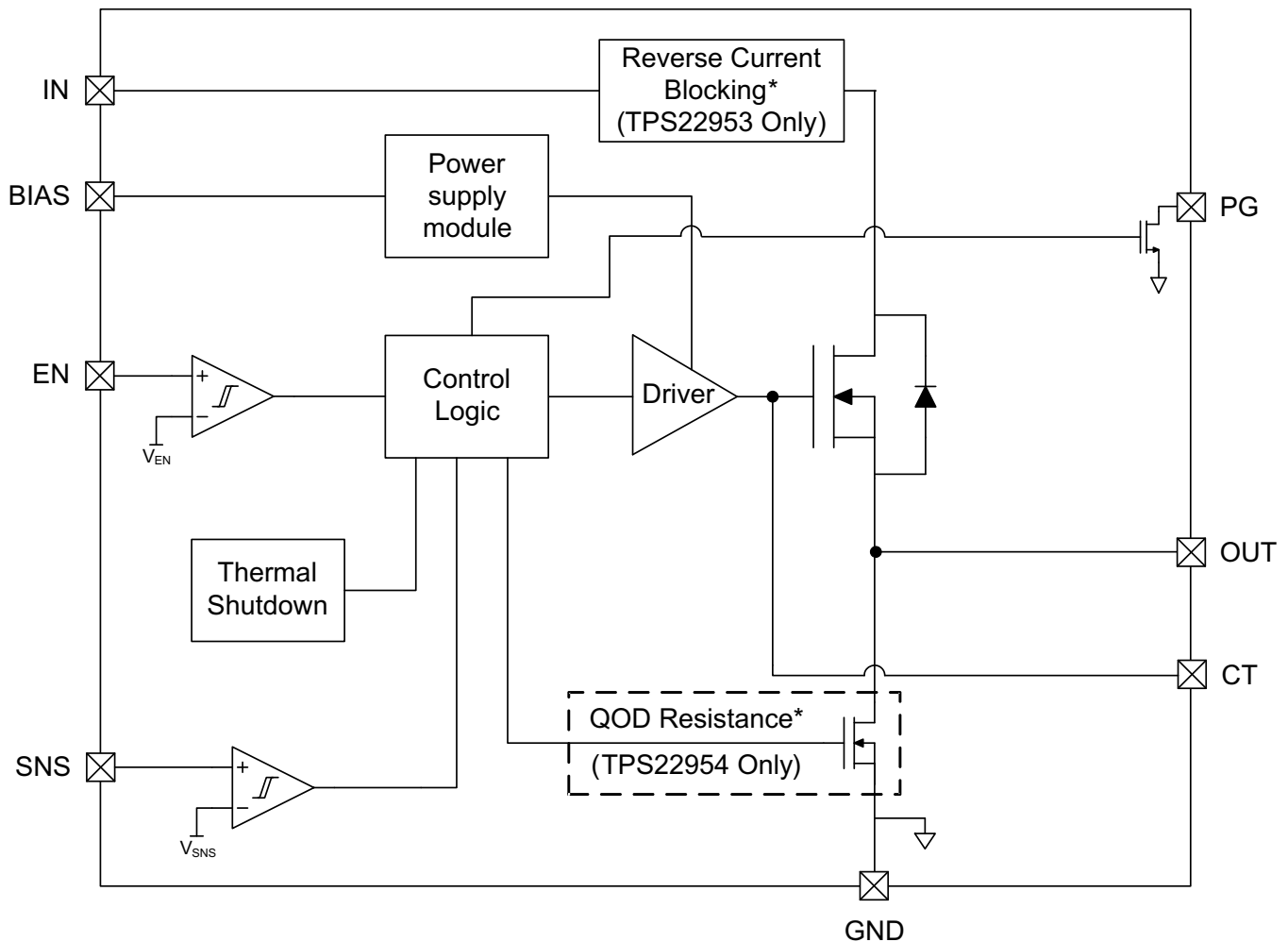

(*) Only active when the switch is disabled.

9.3 Feature Description

9.3.1 On/Off Control (EN pin)

The EN pin controls the state of the switch. When the voltage on EN has exceeded $V_{IH,EN}$ the switch will be enabled. When EN goes below $V_{IL,EN}$ the switch is disabled.

The EN pin has a blanking time of t_{BLANK} on the rising edge once the $V_{IH,EN}$ threshold has been exceeded. It also has a deglitch time of $t_{DEGLITCH}$ when the voltage has gone below $V_{IL,EN}$.

The EN pin can also be configured via an external resistor divider to monitor a voltage signal for input UVLO. Refer to the equation and diagram below on how to configure the EN pin for input UVLO.

$$V_{IH,EN} = V_{IN} \times \frac{R_{EN2}}{R_{EN1} + R_{EN2}} \quad (1)$$

Where:

$V_{IH,EN}$ = the rising threshold of the EN pin (see [Electrical Characteristics](#) table)

V_{IN} = the input voltage being monitored (this could be V_{IN} , V_{BIAS} , or an external power supply)

R_{EN1} , R_{EN2} = resistor divider values

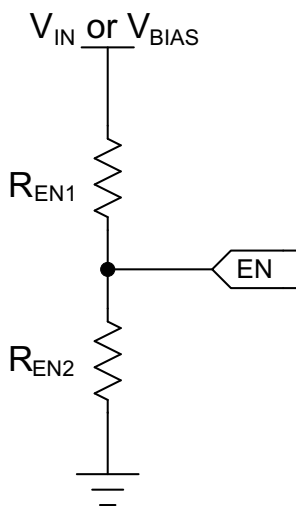

Feature Description (continued)

9.3.2 Voltage Monitoring (SNS pin)

The SNS pin of the device can be used to monitor the output voltage of the device or another voltage rail. The pin can be configured with an external resistor divider to set the desired trip point for the voltage being monitored or be tied to OUT directly. If the voltage on the SNS pin exceeds $V_{IH,SNS}$, the voltage being monitored on the SNS pin is considered to be valid high. The voltage on the SNS pin must be greater than $V_{IH,SNS}$ for at least t_{BLANK} before PG is asserted high. If the voltage on the SNS pin goes below $V_{IL,SNS}$, then the switch will power cycle (i.e., the switch will be disabled and re-enabled). For proper functionality of the device, this pin must not be left floating. If a resistor divider is not being used for voltage sensing, this pin can be tied directly to V_{OUT} .

The SNS pin has a blanking time of t_{BLANK} on the rising edge once the $V_{IH,SNS}$ threshold has been exceeded. It has a deglitch time of $t_{DEGLITCH}$ when the voltage has gone below $V_{IL,SNS}$.

Refer to the equation and diagram below on how to configure the SNS pin for voltage monitoring.

$$V_{IH,SNS} = V_{OUT} \times \frac{R_{SNS2}}{R_{SNS1} + R_{SNS2}} \quad (2)$$

Where:

$V_{IH,SNS}$ = the rising threshold of the SNS pin (see [Electrical Characteristics](#) table)

V_{OUT} = voltage on the OUTpin

R_{SNS1} , R_{SNS2} = resistor divider values

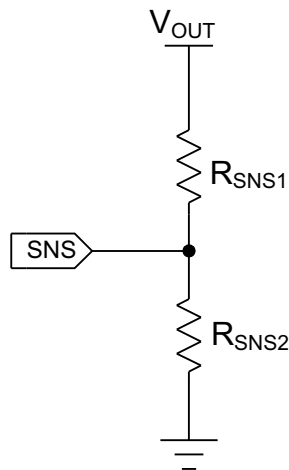

Feature Description (continued)

9.3.3 Power Good (PG Pin)

The PG pin is only asserted high when the voltage on EN has exceeded $V_{IH,EN}$ and the voltage on SNS has exceeded $V_{IH,SNS}$. There is a t_{BLANK} time, typically $100\mu s$, between the SNS voltage exceeding $V_{IH,SNS}$ and PG being asserted high. If the voltage on EN goes below $V_{IL,EN}$ or the voltage on SNS goes below $V_{IL,SNS}$, PG will be de-asserted. There is a $t_{DEGLITCH}$ time, typically $5\mu s$, between the EN voltage or SNS voltage going below their respective V_{IL} levels and PG being pulled low.

PG is an open drain pin and must be pulled up with a pull-up resistor. Be sure to never exceed the maximum operating voltage on this pin. If PG is not being used in the application, tie it to GND for proper device functionality.

For proper PG operation, the BIAS voltage should be within the recommended operating range. In systems that are very sensitive to noise or have long PG traces, it is recommended to add a small capacitance from PG to GND to for decoupling.

9.3.4 Supervisor Fault Detection and Automatic Restart

The falling edge of the SNS pin below $V_{IL,SNS}$ is considered a fault case and will cause the load switch to be disabled for $t_{RESTART}$ (typically 2ms). After the $t_{RESTART}$ time, the switch will be automatically re-enabled as long as EN is still above $V_{IH,EN}$. In the case the SNS pin is being used to monitor V_{OUT} or a downstream voltage, the restart will help to protect against excessive over-current if there is a quick short to GND.

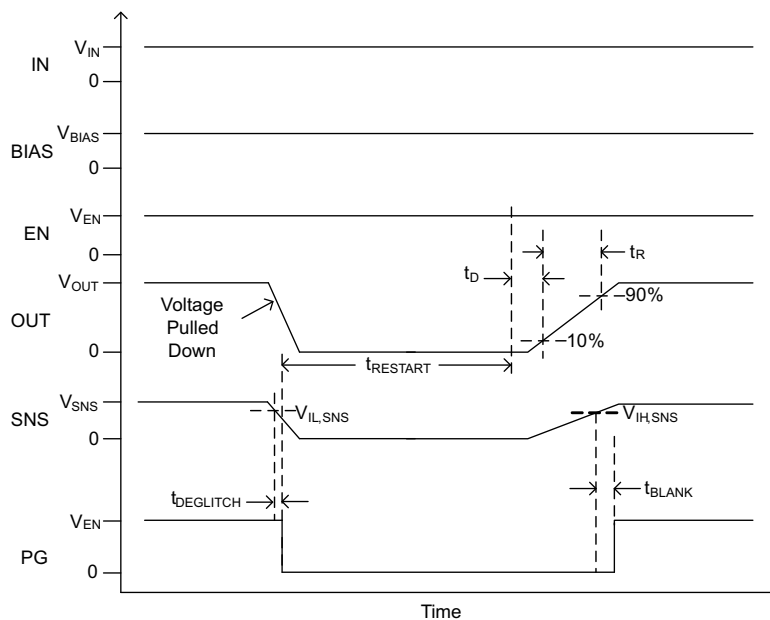

Figure 50. Automatic Restart after Quick Short to GND

Feature Description (continued)

9.3.5 Manual Restart

The falling edge of the SNS pin below $V_{IL,SNS}$ is considered a fault case and will cause the load switch to be disabled for $t_{RESTART}$ (typically 2ms). The SNS pin can be driven by an MCU to manually reset the load switch. After the $t_{RESTART}$ time, the switch will be automatically re-enabled as long as EN is still above $V_{IH,EN}$, even if SNS is held low. The PG pin will stay low until the switch is re-enabled and the SNS pin rises above $V_{IH,SNS}$.

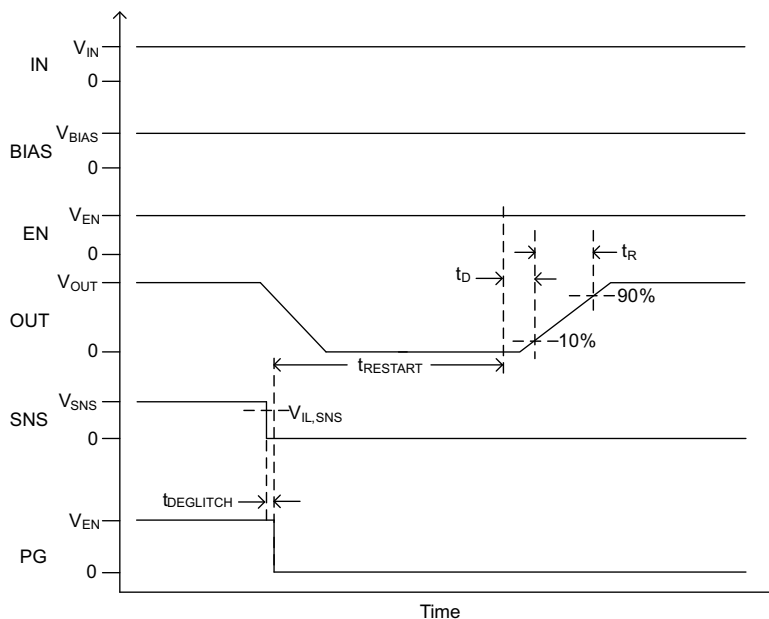

Figure 51. Manual Restart (SNS Held Low)

If the SNS pin is brought above $V_{IH,SNS}$ within the $t_{RESTART}$ time, the switch will still wait to re-enable. The PG pin will also stay low until t_{BLANK} after switch is re-enabled. In this case, PG will indicate when the switch is enabled and capable of being reset again.

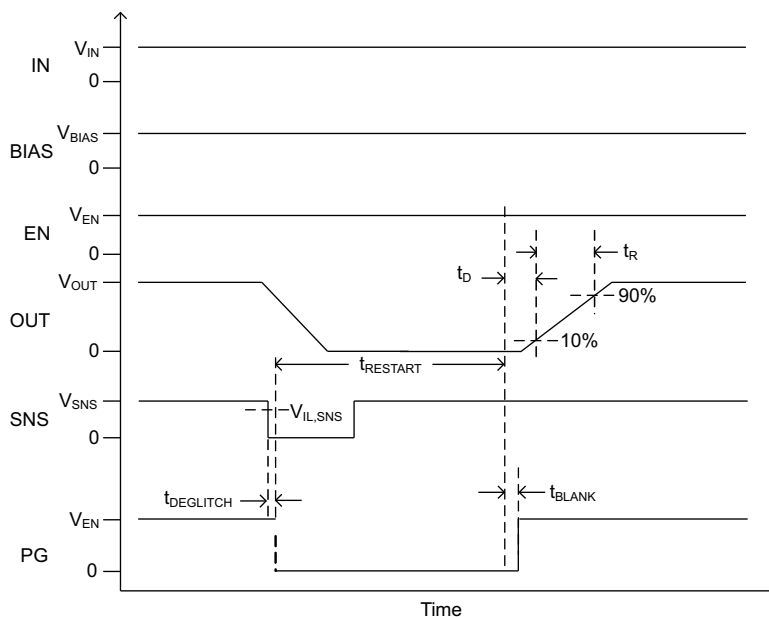

Figure 52. Manual Restart (SNS Toggled Low to High)

Feature Description (continued)

9.3.6 Thermal Shutdown

If the junction temperature of the device exceeds T_{SD} , the switch will be disabled. The device will be enabled once the junction temperature drops by TSD_{HYS} as long as EN is still greater than $V_{IH,EN}$.

9.3.7 Quick Output Discharge (QOD) (TPS22954 Only)

The quick output discharge (QOD) transistor is engaged indefinitely whenever the switch is disabled and the recommended V_{BIAS} voltage is met. During this state, the QOD resistance (R_{PD}) will discharge V_{OUT} to GND. It is not recommended to apply a continuous DC voltage to OUT when the device is disabled.

The QOD transistor can remain active for a short period of time even after V_{BIAS} loses power. This brief period of time is defined as t_{DIS} . For best results, it is recommended the device get disabled before V_{BIAS} goes below the minimum recommended voltage. The waveform below shows the behaviour when power is applied and then removed in a typical application.

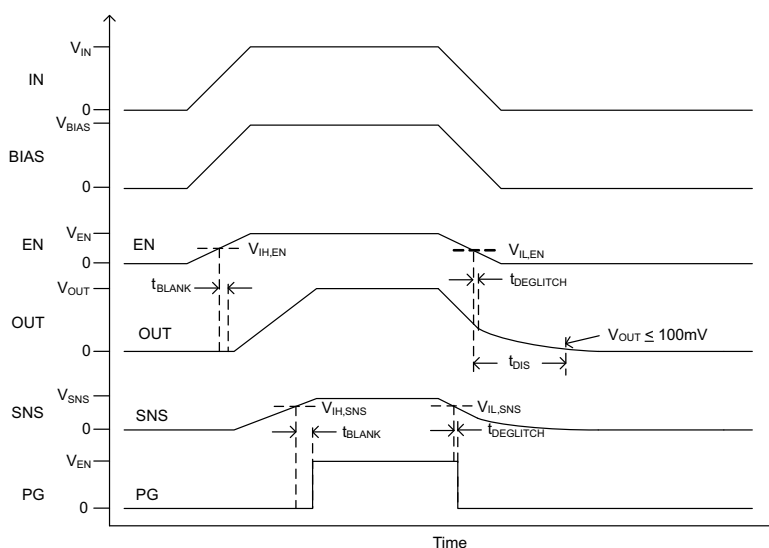

Figure 53. Power Applied and then Removed in a Typical Application

At the end of the t_{DIS} time, it is not guaranteed that V_{OUT} will be 0V since the final voltage will be dependent upon the initial voltage and the C_L capacitor. The final V_{OUT} can be calculated with the following formula for a given initial voltage and C_L capacitor.

$$V_f = V_o \times e^{\frac{-t}{RC}} \quad (3)$$

Where:

V_f = final V_{OUT} voltage

V_o = initial V_{OUT} voltage

R = the value of the output discharge resistor, R_{PD} (see [Electrical Characteristics](#) table)

C = the output bulk capacitance on OUT

9.3.8 V_{IN} and V_{BIAS} Voltage Range

For optimal R_{ON} performance, make sure $V_{IN} \leq V_{BIAS}$. The device will still be functional if $V_{IN} > V_{BIAS}$ but it will exhibit R_{ON} greater than what is listed in the [Electrical Characteristics](#) table. See [Figure 50](#) for an example of a typical device. Notice the increasing R_{ON} as V_{IN} increases. Be sure to never exceed the maximum voltage rating for V_{IN} and V_{BIAS} .

Feature Description (continued)

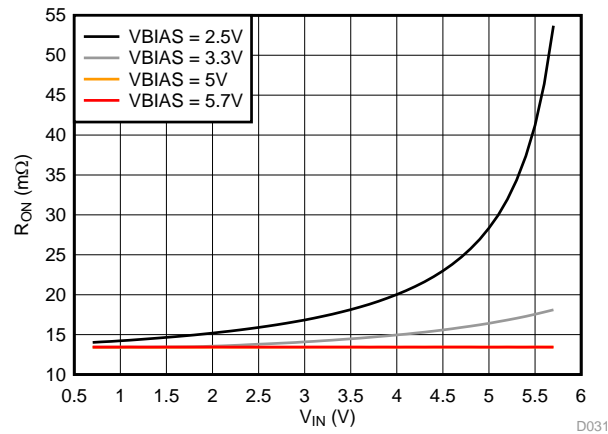

Figure 54. R_{ON} When $V_{IN} > V_{BIAS}$

9.3.9 Adjustable Rise Time (CT pin)

A capacitor to GND on the CT pin sets the slew rate for V_{OUT} . An appropriate capacitance value should be placed on CT such that the I_{MAX} and I_{PLS} specifications of the device are not violated. The capacitor to GND on the CT pin should be rated for 25 V or higher. An approximate formula for the relationship between CT (except for CT = open) and the slew rate for any V_{BIAS} is:

$$SR = 0.35 \times CT + 20$$

where

- SR = slew rate (in $\mu s/V$)
 - CT = the capacitance value on the CT terminal (in pF)
 - The units for the constant 20 are $\mu s/V$.
 - The units for the constant 0.35 are $\mu s/(V \cdot pF)$.
- (4)

Rise time can be calculated by multiplying the input voltage (typically 10% to 90%) by the slew rate. The table below contains rise time values measured on a typical device.

CTx (pF)	RISE TIME (μs) 10%–90%, $C_L = 0.1 \mu F$, $V_{BIAS} = 2.5V$ to $5.7V$, $R_L = 10\Omega$ LOAD. TYPICAL VALUES AT 25°C, 25V X7R 10% CERAMIC CAP					
	5V	3.3V	1.8V	1.5V	1.2V	0.7V
Open	140	98	62	54	46	32
220	444	301	175	150	124	81
470	767	518	299	255	210	133
1000	1492	994	562	474	387	245
2200	3105	2050	1151	961	787	490
4700	6420	4246	2365	1980	1612	998
10000	14059	9339	5183	4331	3533	2197

9.4 Device Functional Modes

The following Table describes what the OUT pin will be connected to for a particular device as determined by the EN pin.

EN	TPS22953	TPS22954
L	OPEN	R_{PD} to GND
H	IN	IN

10 Application and Implementation

NOTE

Information in the following applications sections is not part of the TI component specification, and TI does not warrant its accuracy or completeness. TI's customers are responsible for determining suitability of components for their purposes. Customers should validate and test their design implementation to confirm system functionality.

10.1 Application Information

This section will highlight some of the design considerations when implementing this device in various applications. A PSPICE model for this device is also available on www.ti.com for further aid.

10.1.1 Input to Output Voltage Drop

The input to output voltage drop in the device is determined by the R_{ON} of the device and the load current. The R_{ON} of the device depends upon the V_{IN} and V_{BIAS} conditions of the device. Refer to the R_{ON} specification of the device in the [Electrical Characteristics](#) table of this datasheet. Once the R_{ON} of the device is determined based upon the V_{IN} and V_{BIAS} voltage conditions, use [Equation 5](#) to calculate the input to output voltage drop:

$$\Delta V = I_{LOAD} \times R_{ON} \quad (5)$$

Where:

ΔV = voltage drop from IN to OUT

I_{LOAD} = load current

R_{ON} = On-Resistance of the device for a specific V_{IN} and V_{BIAS}

An appropriate I_{LOAD} must be chosen such that the I_{MAX} specification of the device is not violated.

10.1.2 Thermal Considerations

The maximum IC junction temperature should be restricted to just under the thermal shutdown (T_{SD}) limit of the device. To calculate the maximum allowable dissipation, $P_{D(max)}$ for a given output current and ambient temperature, use [Equation 6](#).

$$P_{D(max)} = \frac{T_{J(max)} - T_A}{\theta_{JA}} \quad (6)$$

Where:

$P_{D(max)}$ = maximum allowable power dissipation

$T_{J(max)}$ = maximum allowable junction temperature before hitting thermal shutdown (see [Electrical Characteristics](#) table)

T_A = ambient temperature of the device

θ_{JA} = junction to air thermal impedance. See [Thermal Information](#) section. This parameter is highly dependent upon board layout.

Application Information (continued)

10.1.3 Automatic Power Sequencing

The PG pin of the TPS22953/54 allows for automatic sequencing of multiple system rails or loads. The accurate SNS voltage monitoring will ensure the first rail is up before the next starts to turn on. This approach provides robust system sequencing and reduces the total inrush current by preventing overlap. The example shows how two rails can be sequenced. There is no limit to the number of rails that can be sequenced in this way

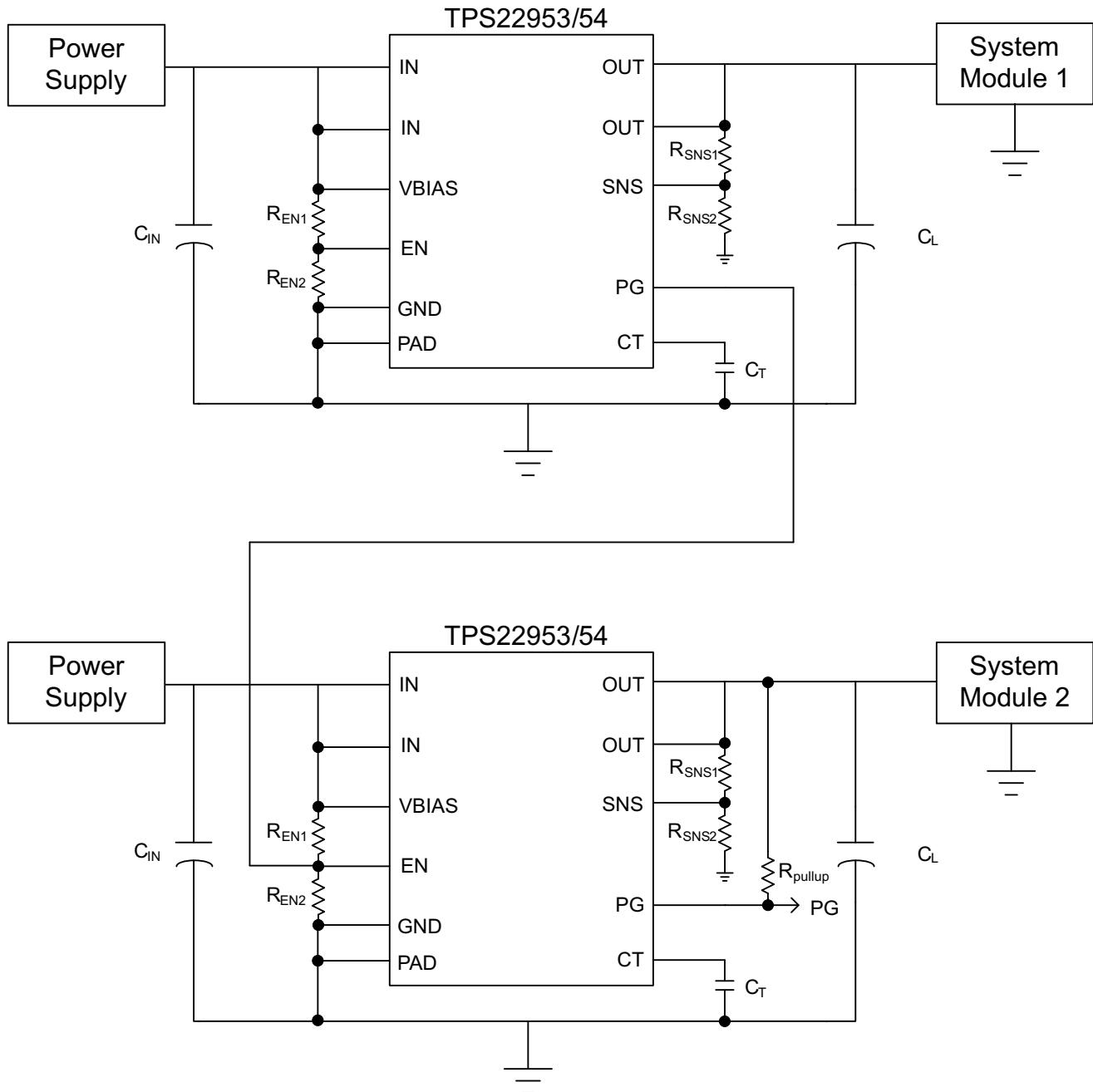

Figure 55. Power Sequencing with PG Control

Application Information (continued)

10.1.4 Monitoring a Downstream Voltage

The SNS pin can be used to monitor other system voltages in addition to V_{OUT} . The status of the monitored voltage will be indicated by the PG pin which can be pulled up to V_{OUT} or another voltage. The figure below shows an example of the TPS22953/54 monitoring the output of a downstream DC/DC regulator. In this case, the switch will turn on when the power supply is above the UVLO, but the PG will not be asserted until the DC/DC regulator has started up.

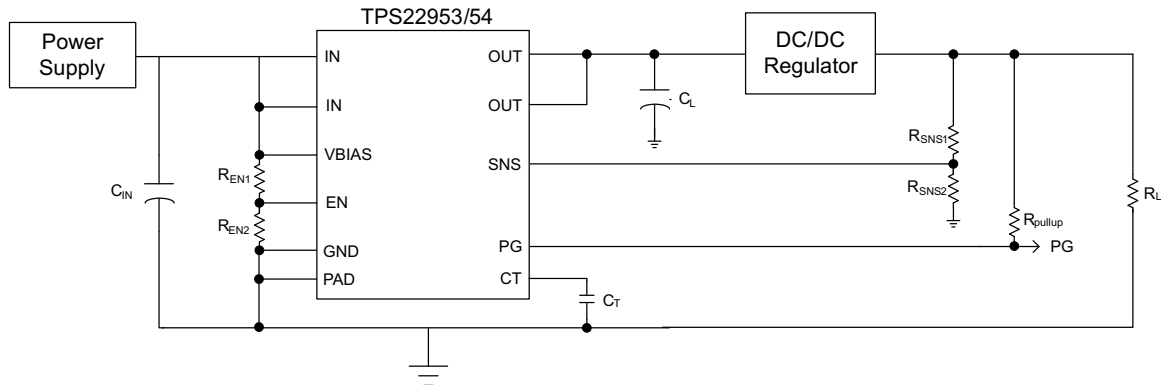

Figure 56. Monitoring a Downstream Voltage

In this application, if the DC/DC Regulator is shut down, the supervisor will register this as a fault case and reset the load switch.

10.1.4.1 Monitoring the Input Voltage

The SNS pin can also be used to monitor V_{IN} in the case a MCU GPIO is being used to control the EN. This will allow PG to report on the status of the input voltage when the switch is enabled.

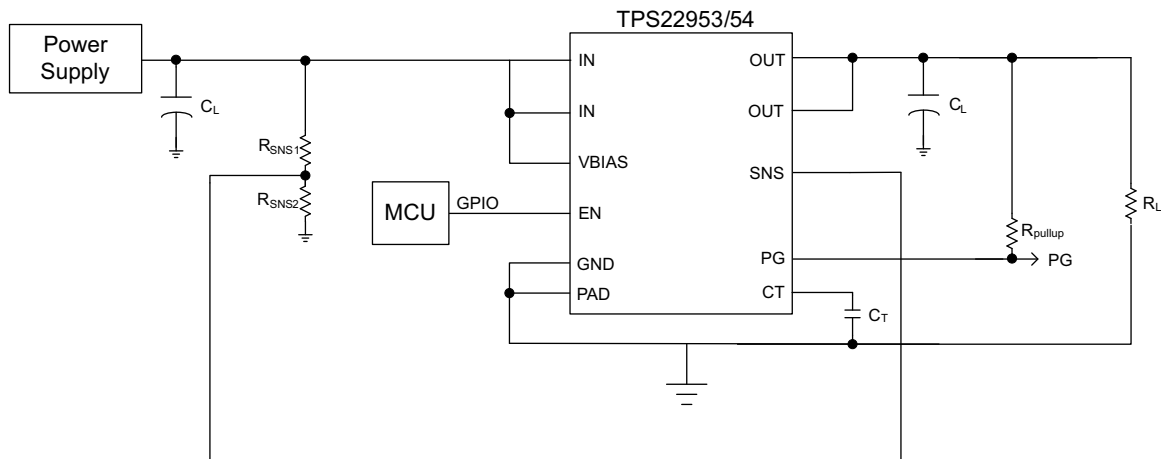

Figure 57. Monitoring Input Voltage

10.2 Typical Application

This application demonstrates how the TPS22953/54 can be used to limit inrush current to output capacitance.

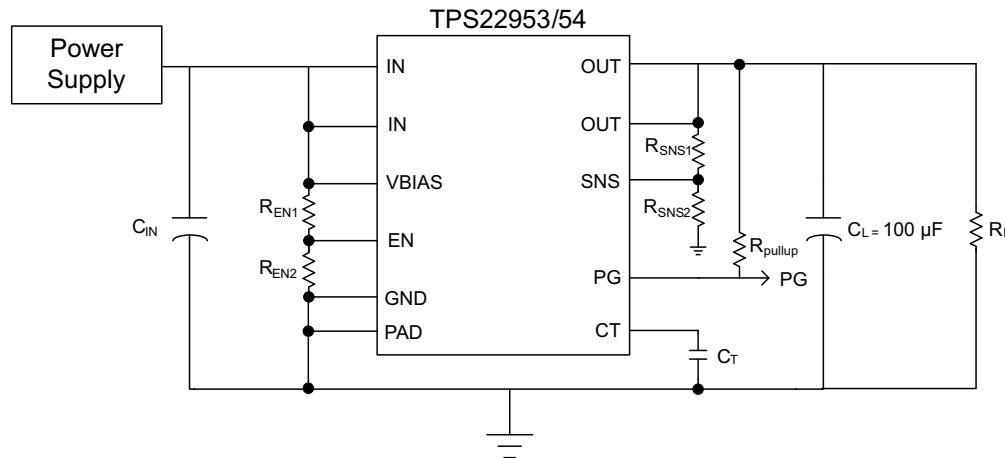

Figure 58. Typical Application Schematic for Powering a Downstream Module

10.2.1 Design Requirements

For this design example, use the following as the input parameters.

Table 1. Design Parameters

DESIGN PARAMETER	EXAMPLE VALUE
V_{IN}	3.3 V
V_{BIAS}	5.0 V
C_L	47 μ F
Maximum Acceptable Inrush Current	150mA
R_L	None

10.2.2 Detailed Design Procedure

To begin the design process, the designer needs to know the following:

- Input voltage
- BIAS voltage
- Load current
- Load capacitance
- Maximum acceptable inrush current

10.2.2.1 Inrush Current

To determine how much inrush current will be caused by the C_L capacitor, use Equation 7:

$$I_{INRUSH} = C_L \times \frac{dV_{OUT}}{dt} \quad (7)$$

Where:

I_{INRUSH} = amount of inrush caused by C_L

C_L = capacitance on V_{OUT}

dt = V_{OUT} Rise Time (typically 10% to 90%)

dV_{OUT} = Change in V_{OUT} Voltage (typically 10% to 90%)

In this case, a Slew Rate slower than 314 μ s/V will be required to meet the maximum acceptable inrush requirement. Equation 4 can be used to estimate the C_T capacitance required for this slew rate.

$$314 \mu\text{s/V} = 0.35 \times C_T + 20 \quad (8)$$

$$C_T = 840 \text{ pF} \quad (9)$$

10.2.3 Application Curves

The following Application Curves show the inrush with multiple different CT values. These curves show only a CT capacitance greater than 840pF results in the acceptable inrush current of 150mA.

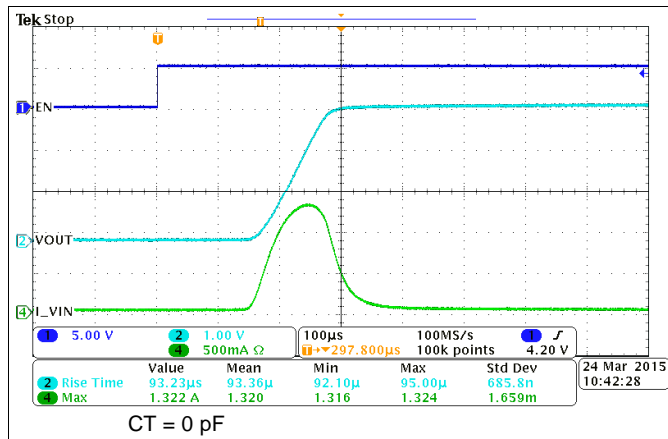

Figure 59. Inrush with CT = 0 pF

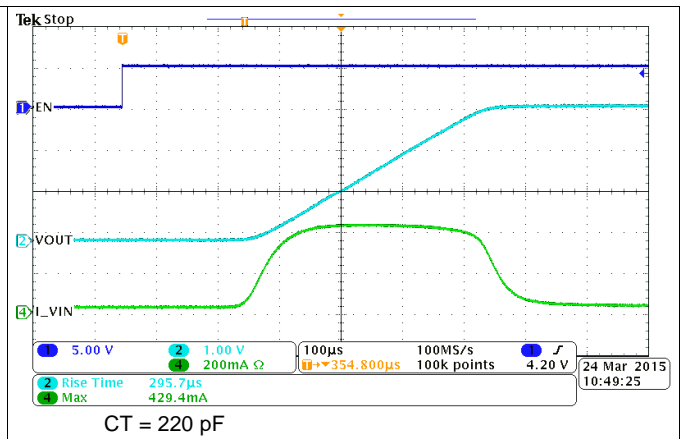

Figure 60. Inrush with CT = 220 pF

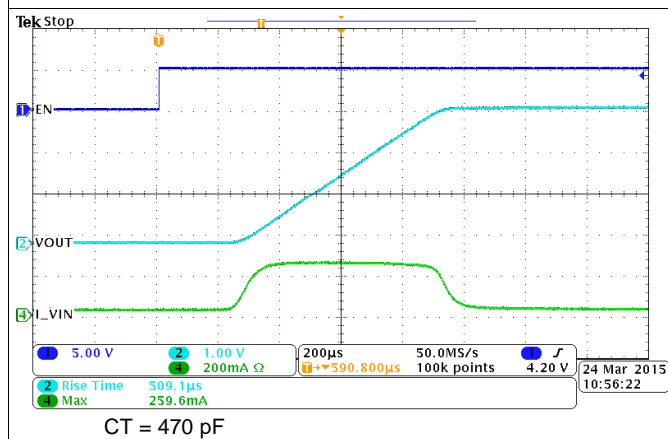

Figure 61. Inrush with CT = 470 pF

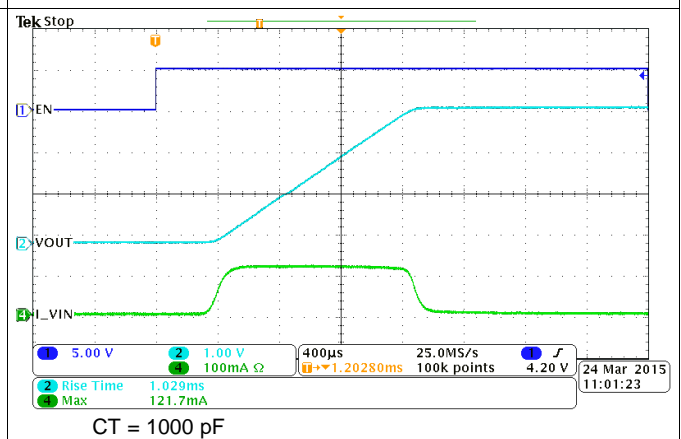

Figure 62. Inrush with CT = 1000 pF

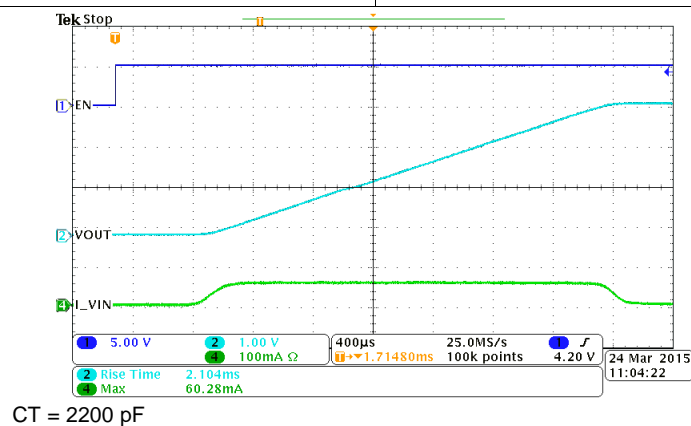

Figure 63. Inrush with CT = 2200 pF

11 Power Supply Recommendations

The device is designed to operate from a V_{BIAS} range of 2.5V to 5.7V and a V_{IN} range of 0.7 V to 5.7 V. The power supply should be well regulated and placed as close to the device terminals as possible. It must be able to withstand all transient and load current steps. In most situations, using an input capacitance of 1 μ F is sufficient to prevent the supply voltage from dipping when the switch is turned on. In cases where the power supply is slow to respond to a large transient current or large load current step, additional bulk capacitance may be required on the input.

The requirements for larger input capacitance can be mitigated by adding additional capacitance to the CT pin. This will cause the load switch to turn on more slowly. Not only will this reduce transient inrush current, but it will also give the power supply more time to respond to the load current step.

12 Layout

12.1 Layout Guidelines

- Input and Output traces should be as short and wide as possible to accommodate for high current.
- Use vias under the exposed thermal pad for thermal relief for high current operation.
- The CT Capacitor should be placed as close as possible to the device to minimize parasitic trace capacitance. It is also recommended to cutout copper on other layers directly below CT to minimize parasitic capacitance.
- The IN terminal should be bypassed to ground with low ESR ceramic bypass capacitors. The typical recommended bypass capacitance is ceramic with X5R or X7R dielectric. This capacitor should be placed as close to the device pins as possible.
- The OUT terminal should be bypassed to ground with low ESR ceramic bypass capacitors. The typical recommended bypass capacitance is ceramic with X5R or X7R dielectric. This capacitor should be placed as close to the device pins as possible.
- The BIAS terminal should be bypassed to ground with low ESR ceramic bypass capacitors. The typical recommended bypass capacitance is ceramic with X5R or X7R dielectric.

12.2 Layout Example

○ VIA to Power Ground Plane

○ VIA to PG pin

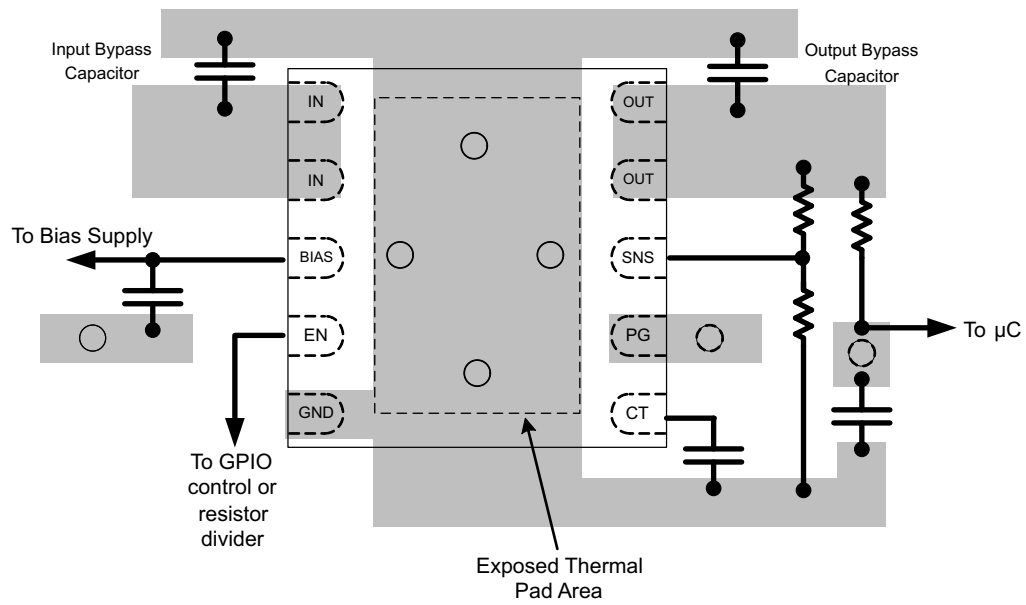

Figure 64. Recommended Board Layout

13 器件和文档支持

13.1 相关链接

以下表格列出了快速访问链接。范围包括技术文档、支持与社区资源、工具和软件，并且可以快速访问样片或购买链接。

表 2. 相关链接

器件	产品文件夹	样片与购买	技术文档	工具与软件	支持与社区
TPS22953	请单击此处	请单击此处	请单击此处	请单击此处	请单击此处
TPS22954	请单击此处	请单击此处	请单击此处	请单击此处	请单击此处

13.2 商标

All trademarks are the property of their respective owners.

13.3 静电放电警告



这些装置包含有限的内置 ESD 保护。存储或装卸时，应将导线一起截短或将装置放置于导电泡棉中，以防止 MOS 门极遭受静电损伤。

13.4 术语表

[SLYZ022](#) — TI 术语表。

这份术语表列出并解释术语、首字母缩略词和定义。

14 机械封装和可订购信息

以下页中包括机械封装和可订购信息。 这些信息是针对指定器件可提供的最新数据。 这些数据会在无通知且不对本文档进行修订的情况下发生改变。 欲获得该数据表的浏览器版本，请查阅左侧的导航栏。

PACKAGING INFORMATION

Orderable part number	Status (1)	Material type (2)	Package Pins	Package qty Carrier	RoHS (3)	Lead finish/ Ball material (4)	MSL rating/ Peak reflow (5)	Op temp (°C)	Part marking (6)
TPS22953DQCR	Active	Production	WSON (DQC) 10	3000 LARGE T&R	Yes	NIPDAU SN	Level-2-260C-1 YEAR	-40 to 105	RB953
TPS22953DQCR.A	Active	Production	WSON (DQC) 10	3000 LARGE T&R	Yes	NIPDAU	Level-2-260C-1 YEAR	-40 to 105	RB953
TPS22953DQCRG4	Active	Production	WSON (DQC) 10	3000 LARGE T&R	Yes	NIPDAU	Level-2-260C-1 YEAR	-40 to 105	RB953
TPS22953DQCRG4.A	Active	Production	WSON (DQC) 10	3000 LARGE T&R	Yes	NIPDAU	Level-2-260C-1 YEAR	-40 to 105	RB953
TPS22953DSQR	Active	Production	WSON (DSQ) 10	3000 LARGE T&R	Yes	NIPDAU NIPDAUAG SN	Level-2-260C-1 YEAR	-40 to 105	ZFDI
TPS22953DSQR.A	Active	Production	WSON (DSQ) 10	3000 LARGE T&R	Yes	NIPDAU	Level-2-260C-1 YEAR	-40 to 105	ZFDI
TPS22953DSQRG4	Active	Production	WSON (DSQ) 10	3000 LARGE T&R	Yes	NIPDAU	Level-2-260C-1 YEAR	-40 to 105	ZFDI
TPS22953DSQRG4.A	Active	Production	WSON (DSQ) 10	3000 LARGE T&R	Yes	NIPDAU	Level-2-260C-1 YEAR	-40 to 105	ZFDI
TPS22954DQCR	Active	Production	WSON (DQC) 10	3000 LARGE T&R	Yes	NIPDAU SN	Level-2-260C-1 YEAR	-40 to 105	RB954
TPS22954DQCR.A	Active	Production	WSON (DQC) 10	3000 LARGE T&R	Yes	NIPDAU	Level-2-260C-1 YEAR	-40 to 105	RB954
TPS22954DQCRG4	Active	Production	WSON (DQC) 10	3000 LARGE T&R	Yes	NIPDAU	Level-2-260C-1 YEAR	-40 to 105	RB954
TPS22954DQCRG4.A	Active	Production	WSON (DQC) 10	3000 LARGE T&R	Yes	NIPDAU	Level-2-260C-1 YEAR	-40 to 105	RB954
TPS22954DSQR	Active	Production	WSON (DSQ) 10	3000 LARGE T&R	Yes	NIPDAU NIPDAUAG SN	Level-2-260C-1 YEAR	-40 to 105	ZDKI
TPS22954DSQR.A	Active	Production	WSON (DSQ) 10	3000 LARGE T&R	Yes	NIPDAUAG	Level-2-260C-1 YEAR	-40 to 105	ZDKI
TPS22954DSQRG4	Active	Production	WSON (DSQ) 10	3000 LARGE T&R	Yes	NIPDAU	Level-1-260C-UNLIM	-40 to 105	ZDKI
TPS22954DSQRG4.A	Active	Production	WSON (DSQ) 10	3000 LARGE T&R	Yes	NIPDAU	Level-1-260C-UNLIM	-40 to 105	ZDKI

(1) **Status:** For more details on status, see our [product life cycle](#).

(2) **Material type:** When designated, preproduction parts are prototypes/experimental devices, and are not yet approved or released for full production. Testing and final process, including without limitation quality assurance, reliability performance testing, and/or process qualification, may not yet be complete, and this item is subject to further changes or possible discontinuation. If available for ordering, purchases will be subject to an additional waiver at checkout, and are intended for early internal evaluation purposes only. These items are sold without warranties of any kind.

(3) **RoHS values:** Yes, No, RoHS Exempt. See the [TI RoHS Statement](#) for additional information and value definition.

(4) **Lead finish/Ball material:** Parts may have multiple material finish options. Finish options are separated by a vertical ruled line. Lead finish/Ball material values may wrap to two lines if the finish value exceeds the maximum column width.

(5) **MSL rating/Peak reflow:** The moisture sensitivity level ratings and peak solder (reflow) temperatures. In the event that a part has multiple moisture sensitivity ratings, only the lowest level per JEDEC standards is shown. Refer to the shipping label for the actual reflow temperature that will be used to mount the part to the printed circuit board.

(6) **Part marking:** There may be an additional marking, which relates to the logo, the lot trace code information, or the environmental category of the part.

Multiple part markings will be inside parentheses. Only one part marking contained in parentheses and separated by a "~" will appear on a part. If a line is indented then it is a continuation of the previous line and the two combined represent the entire part marking for that device.

Important Information and Disclaimer:The information provided on this page represents TI's knowledge and belief as of the date that it is provided. TI bases its knowledge and belief on information provided by third parties, and makes no representation or warranty as to the accuracy of such information. Efforts are underway to better integrate information from third parties. TI has taken and continues to take reasonable steps to provide representative and accurate information but may not have conducted destructive testing or chemical analysis on incoming materials and chemicals. TI and TI suppliers consider certain information to be proprietary, and thus CAS numbers and other limited information may not be available for release.

In no event shall TI's liability arising out of such information exceed the total purchase price of the TI part(s) at issue in this document sold by TI to Customer on an annual basis.

OTHER QUALIFIED VERSIONS OF TPS22953, TPS22954 :

- Automotive : [TPS22953-Q1](#), [TPS22954-Q1](#)

NOTE: Qualified Version Definitions:

- Automotive - Q100 devices qualified for high-reliability automotive applications targeting zero defects

TAPE AND REEL INFORMATION

QUADRANT ASSIGNMENTS FOR PIN 1 ORIENTATION IN TAPE

*All dimensions are nominal

Device	Package Type	Package Drawing	Pins	SPQ	Reel Diameter (mm)	Reel Width W1 (mm)	A0 (mm)	B0 (mm)	K0 (mm)	P1 (mm)	W (mm)	Pin1 Quadrant
TPS22953DQCR	WSO	DQC	10	3000	180.0	8.4	2.25	3.25	1.05	4.0	8.0	Q1
TPS22953DQCRG4	WSO	DQC	10	3000	180.0	8.4	2.25	3.25	1.05	4.0	8.0	Q1
TPS22953DSQR	WSO	DSQ	10	3000	180.0	8.4	2.3	2.3	1.15	4.0	8.0	Q2
TPS22953DSQRG4	WSO	DSQ	10	3000	180.0	8.4	2.3	2.3	1.15	4.0	8.0	Q2
TPS22954DQCR	WSO	DQC	10	3000	180.0	8.4	2.25	3.25	1.05	4.0	8.0	Q1
TPS22954DQCRG4	WSO	DQC	10	3000	180.0	8.4	2.25	3.25	1.05	4.0	8.0	Q1
TPS22954DSQR	WSO	DSQ	10	3000	180.0	8.4	2.3	2.3	1.15	4.0	8.0	Q2
TPS22954DSQRG4	WSO	DSQ	10	3000	180.0	8.4	2.3	2.3	1.15	4.0	8.0	Q2

TAPE AND REEL BOX DIMENSIONS

*All dimensions are nominal

Device	Package Type	Package Drawing	Pins	SPQ	Length (mm)	Width (mm)	Height (mm)
TPS22953DQCR	WSON	DQC	10	3000	210.0	185.0	35.0
TPS22953DQCRG4	WSON	DQC	10	3000	210.0	185.0	35.0
TPS22953DSQR	WSON	DSQ	10	3000	210.0	185.0	35.0
TPS22953DSQRG4	WSON	DSQ	10	3000	210.0	185.0	35.0
TPS22954DQCR	WSON	DQC	10	3000	210.0	185.0	35.0
TPS22954DQCRG4	WSON	DQC	10	3000	210.0	185.0	35.0
TPS22954DSQR	WSON	DSQ	10	3000	182.0	182.0	20.0
TPS22954DSQRG4	WSON	DSQ	10	3000	182.0	182.0	20.0

GENERIC PACKAGE VIEW

DQC 10

WSON - 0.8 mm max height

PLASTIC SMALL OUTLINE - NO LEAD

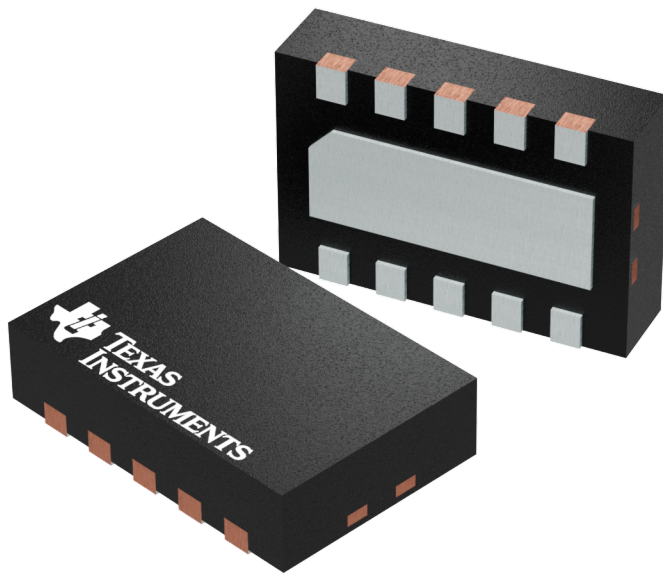

Images above are just a representation of the package family, actual package may vary.
Refer to the product data sheet for package details.

4209674/B

DQC0010A



PACKAGE OUTLINE

WSO - 0.8mm max height

PLASTIC SMALL OUTLINE - NO LEAD

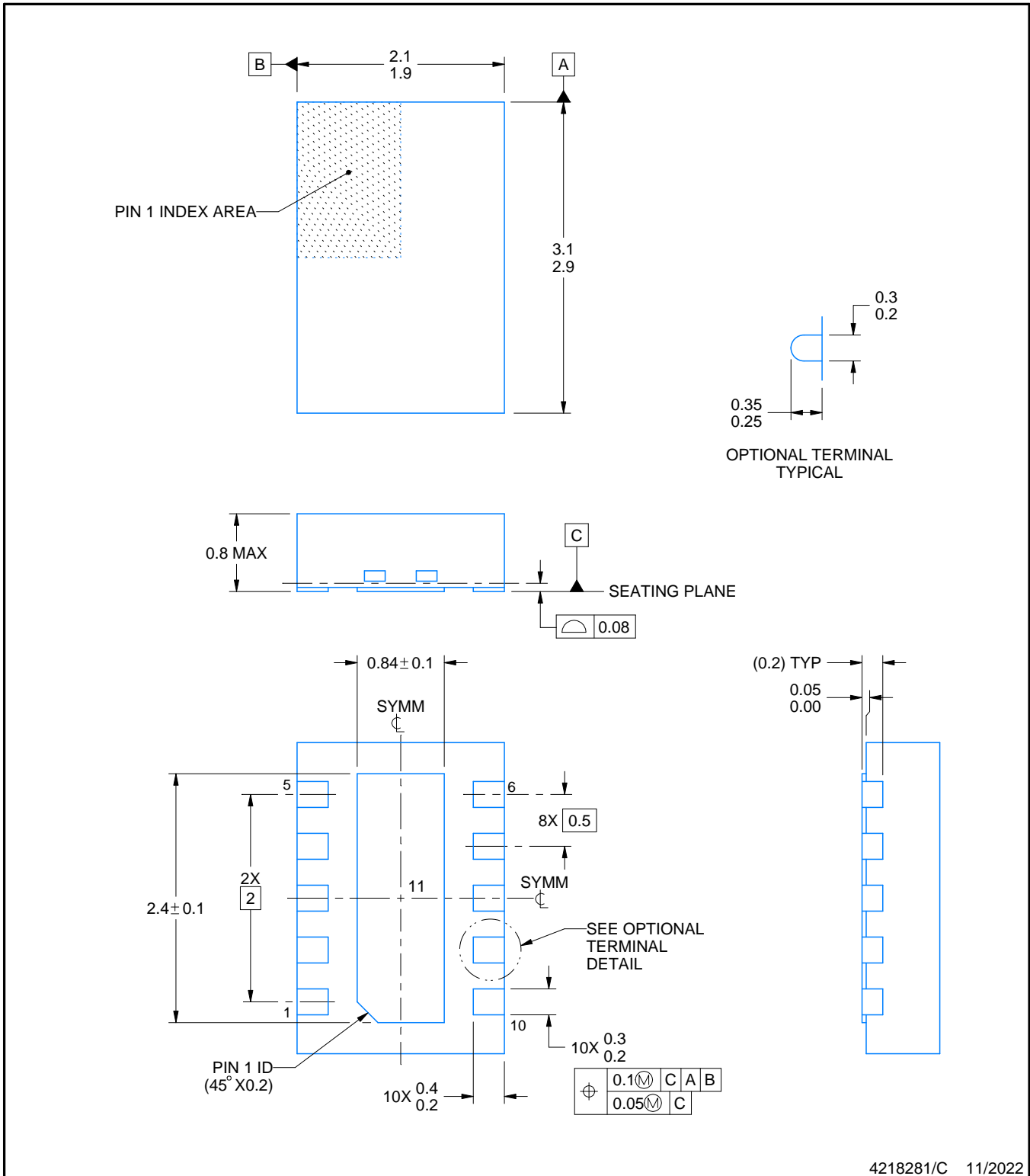

4218281/C 11/2022

NOTES:

1. All linear dimensions are in millimeters. Any dimensions in parenthesis are for reference only. Dimensioning and tolerancing per ASME Y14.5M.
2. This drawing is subject to change without notice.
3. The package thermal pad must be soldered to the printed circuit board for thermal and mechanical performance.

EXAMPLE BOARD LAYOUT

DQC0010A

WSON - 0.8mm max height

PLASTIC SMALL OUTLINE - NO LEAD

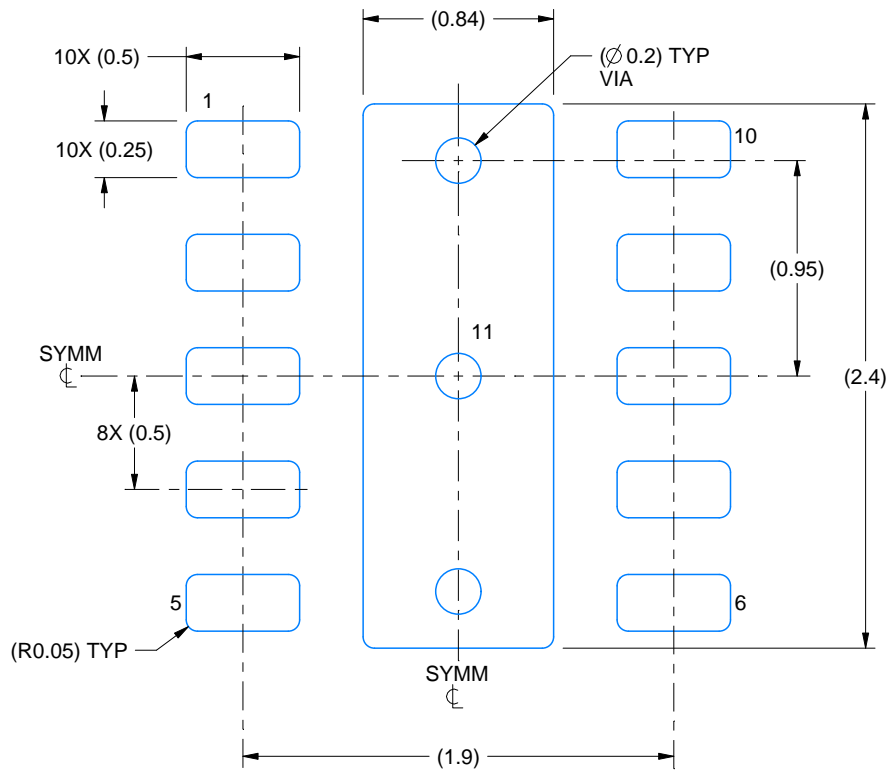

LAND PATTERN EXAMPLE
SCALE: 30X

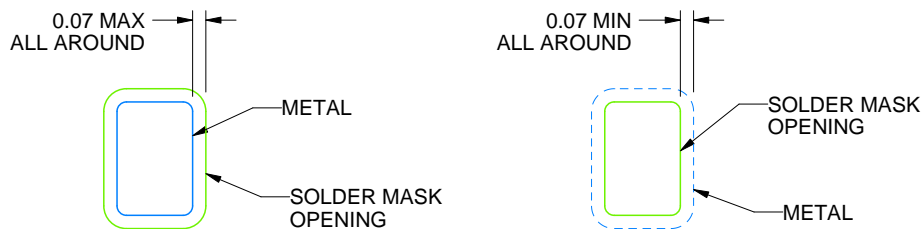

NON SOLDER MASK
DEFINED
(PREFERRED)

SOLDER MASK
DEFINED

SOLDER MASK DETAILS

4218281/C 11/2022

NOTES: (continued)

4. This package is designed to be soldered to a thermal pad on the board. For more information, see Texas Instruments literature number SLUA271 (www.ti.com/lit/sluea271).
5. Vias are optional depending on application, refer to device data sheet. If any vias are implemented, refer to their locations shown on this view. It is recommended that vias under paste be filled, plugged or tented.

EXAMPLE STENCIL DESIGN

DQC0010A

WSN - 0.8mm max height

PLASTIC SMALL OUTLINE - NO LEAD

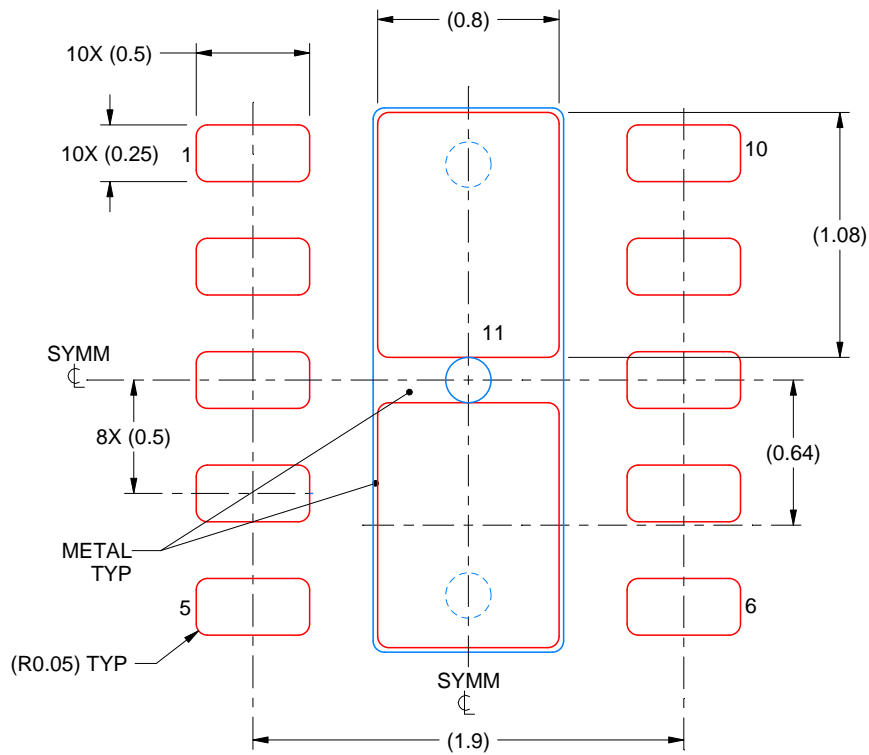

SOLDER PASTE EXAMPLE
BASED ON 0.125 mm THICK STENCIL

EXPOSED PAD 11:
86% PRINTED SOLDER COVERAGE BY AREA UNDER PACKAGE
SCALE: 30X

4218281/C 11/2022

NOTES: (continued)

6. Laser cutting apertures with trapezoidal walls and rounded corners may offer better paste release. IPC-7525 may have alternate design recommendations.

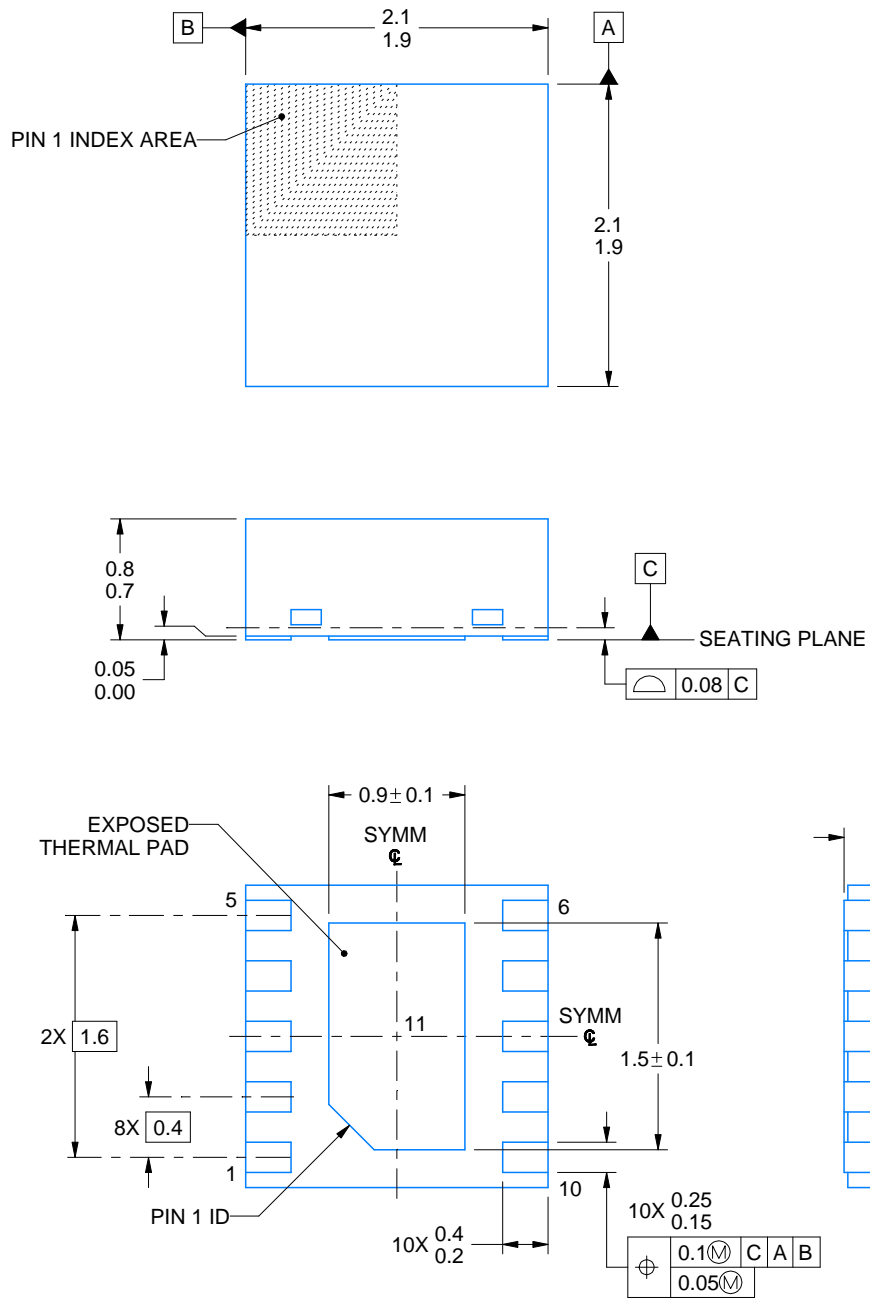
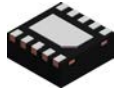

4218906/A 04/2019

NOTES:

1. All linear dimensions are in millimeters. Any dimensions in parenthesis are for reference only. Dimensioning and tolerancing per ASME Y14.5M.
2. This drawing is subject to change without notice.
3. The package thermal pad must be soldered to the printed circuit board for thermal and mechanical performance.

EXAMPLE BOARD LAYOUT

DSQ0010A

WSON - 0.8 mm max height

PLASTIC SMALL OUTLINE - NO LEAD

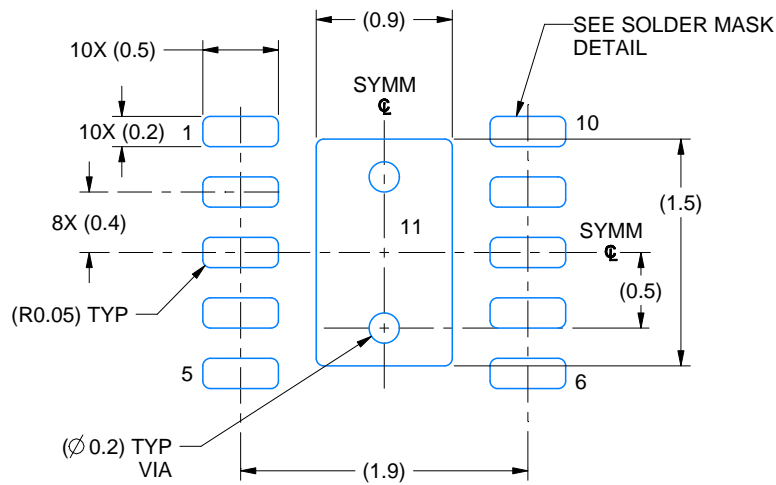

LAND PATTERN EXAMPLE
EXPOSED METAL SHOWN
SCALE: 20X

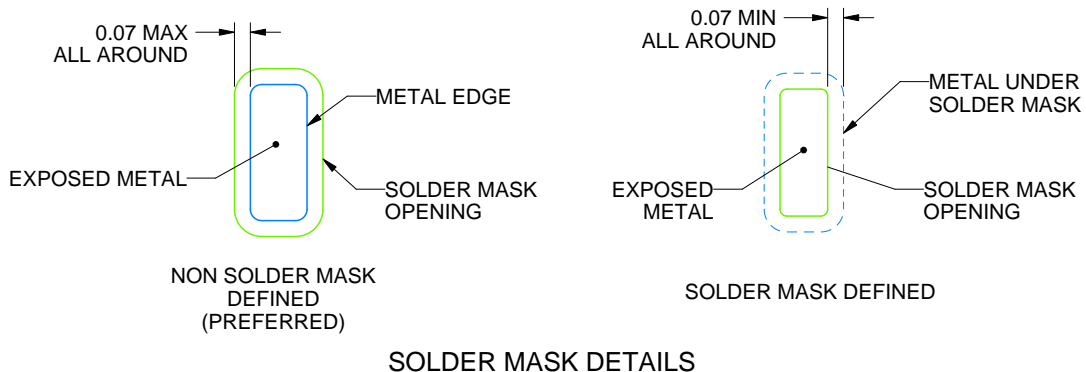

4218906/A 04/2019

NOTES: (continued)

- This package is designed to be soldered to a thermal pad on the board. For more information, see Texas Instruments literature number SLUA271 (www.ti.com/lit/slua271).
- Vias are optional depending on application, refer to device data sheet. If any vias are implemented, refer to their locations shown on this view. It is recommended that vias under paste be filled, plugged or tented.

EXAMPLE STENCIL DESIGN

DSQ0010A

WSON - 0.8 mm max height

PLASTIC SMALL OUTLINE - NO LEAD

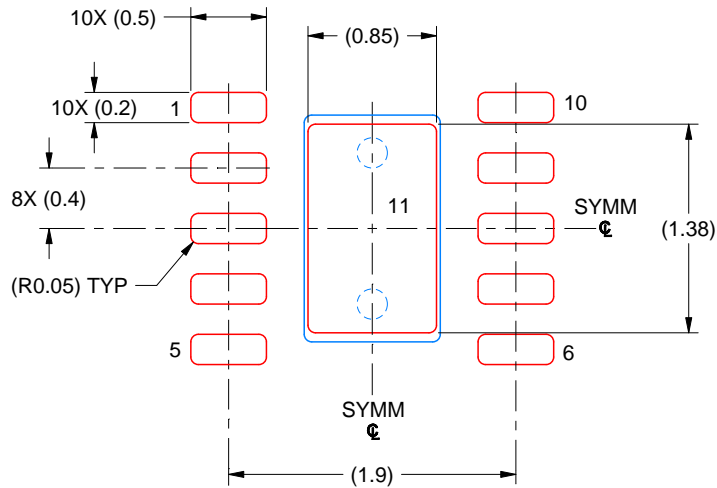

SOLDER PASTE EXAMPLE
BASED ON 0.125 MM THICK STENCIL
SCALE: 20X

EXPOSED PAD 11
87% PRINTED SOLDER COVERAGE BY AREA UNDER PACKAGE

4218906/A 04/2019

NOTES: (continued)

6. Laser cutting apertures with trapezoidal walls and rounded corners may offer better paste release. IPC-7525 may have alternate design recommendations.

重要通知和免责声明

TI“按原样”提供技术和可靠性数据（包括数据表）、设计资源（包括参考设计）、应用或其他设计建议、网络工具、安全信息和其他资源，不保证没有瑕疵且不做任何明示或暗示的担保，包括但不限于对适销性、与某特定用途的适用性或不侵犯任何第三方知识产权的暗示担保。

这些资源可供使用 TI 产品进行设计的熟练开发人员使用。您将自行承担以下全部责任：(1) 针对您的应用选择合适的 TI 产品，(2) 设计、验证并测试您的应用，(3) 确保您的应用满足相应标准以及任何其他安全、安保法规或其他要求。

这些资源如有变更，恕不另行通知。TI 授权您仅可将这些资源用于研发本资源所述的 TI 产品的相关应用。严禁以其他方式对这些资源进行复制或展示。您无权使用任何其他 TI 知识产权或任何第三方知识产权。对于因您对这些资源的使用而对 TI 及其代表造成的任何索赔、损害、成本、损失和债务，您将全额赔偿，TI 对此概不负责。

TI 提供的产品受 [TI 销售条款](#)、[TI 通用质量指南](#) 或 [ti.com](#) 上其他适用条款或 TI 产品随附的其他适用条款的约束。TI 提供这些资源并不会扩展或以其他方式更改 TI 针对 TI 产品发布的适用的担保或担保免责声明。除非德州仪器 (TI) 明确将某产品指定为定制产品或客户特定产品，否则其产品均为按确定价格收入目录的标准通用器件。

TI 反对并拒绝您可能提出的任何其他或不同的条款。

版权所有 © 2026，德州仪器 (TI) 公司

最后更新日期：2025 年 10 月