

双通道、超低电阻负载开关

 查询样片: [TPS22966](#)

特性

- 集成双通道负载开关
- 输入电压范围: **0.8V 至 5.5V**
- 超低 R_{ON} 电阻
 - $V_{IN} = 5V$ ($V_{BIAS} = 5V$) 时, $R_{ON} = 18m\Omega$
 - $V_{IN} = 3.6V$ ($V_{BIAS} = 5V$) 时, $R_{ON} = 18m\Omega$
 - $V_{IN} = 1.8V$ ($V_{BIAS} = 5V$) 时, $R_{ON} = 18m\Omega$
- 每通道最大 **6A** 持续开关电流
- 低静态电流
 - **80 μ A** (两个通道)
 - **60 μ A** (单通道)
- 低控制输入阈值支持使用 **1.2V/1.8V/2.5V/3.3V** 逻辑电路
- 可配置的上升时间
- 快速输出放电 (**QOD**)
- 带有散热垫的小外形尺寸无引线 (**SON**) **14** 引脚封装
- 根据 **JESD 22** 测试得出的静电放电 (**ESD**) 性能
 - **2kV** 人体模型 (**HBM**) 和 **1kV** 器件充电模型 (**CDM**)

应用范围

- **Ultrabook™**
- 笔记本电脑/上网本
- 平板电脑
- 消费类电子产品
- 机顶盒/家庭网关
- 电信系统
- 固态硬盘 (**SSD**)

说明

TPS22966 是一款小型, 超低 R_{ON} , 双通道负载开关, 此开关具有受控接通功能。此器件包含两个可在 0.8V 至 5.5V 输入电压范围内运行的 N 通道 MOSFET, 并且每通道支持最大 6A 的持续电流。每个开关可由一个打开/关闭输入 (ON1 和 ON2) 独立控制, 此输入可与低压控制信号直接对接。在 TPS22966 中, 为了实现开关关闭时的快速输出放电, 增加了一个 220 Ω 的片上负载电阻器。

TPS22966 采用小型, 节省空间的 2mm x 3mm 14 小外形尺寸无引线 (SON) 封装 (DPU), 此类封装具有可实现高功率耗散的内置散热垫。器件在自然通风环境下的额定运行温度范围为 -40°C 至 85°C。

表 1. 特性列表

3.6V ($V_{BIAS} = 5V$) 时, R_{ON} 的典型值	18m Ω
上升时间 ⁽¹⁾	可调节
快速输出放电	支持
最大输出电流 (每通道)	6A
通用输入输出接口 (GPIO) 启用	高电平有效
工作温度	-40°C 至 85°C
(1) CT 值与上升时间之间的关系请见应用信息部分。	
(2) 这个特性通过一个 220 Ω 电阻器将开关的输出放电至接地 (GND) 水平, 从而防止输出悬空。	



图 1. 典型应用



Please be aware that an important notice concerning availability, standard warranty, and use in critical applications of Texas Instruments semiconductor products and disclaimers thereto appears at the end of this data sheet.

Ultrabook is a trademark of Intel.

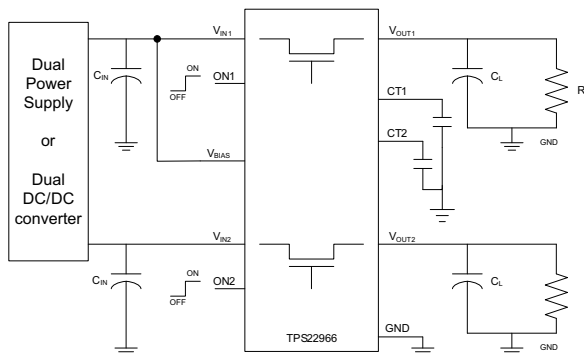

These devices have limited built-in ESD protection. The leads should be shorted together or the device placed in conductive foam during storage or handling to prevent electrostatic damage to the MOS gates.

ORDERING INFORMATION

See package option addendum for orderable part numbers.

ABSOLUTE MAXIMUM RATINGS

over operating free-air temperature range (unless otherwise noted)⁽¹⁾⁽²⁾

		VALUE	UNIT ⁽²⁾
V _{IN1,2}	Input voltage range	-0.3 to 6	V
V _{OUT1,2}	Output voltage range	-0.3 to 6	V
V _{ON1,2}	ON-pin voltage range	-0.3 to 6	V
V _{BIAS}	VBIAS voltage range	-0.3 to 6	V
I _{MAX}	Maximum continuous switch current per channel	6	A
I _{PLS}	Maximum pulsed switch current per channel, pulse <300 μs, 2% duty cycle	8	A
T _A	Operating free-air temperature range ⁽³⁾	-40 to 85	°C
T _J	Maximum junction temperature	125	°C
T _{STG}	Storage temperature range	-65 to 150	°C
T _{LEAD}	Maximum lead temperature (10-s soldering time)	300	°C
ESD	Electrostatic discharge protection	Human-Body Model (HBM)	2000
		Charged-Device Model (CDM)	1000

- (1) Stresses beyond those listed under absolute maximum ratings may cause permanent damage to the device. These are stress ratings only, and functional operation of the device at these or any other conditions beyond those indicated under recommended operating conditions is not implied. Exposure to absolute–maximum–rated conditions for extended periods may affect device reliability.
- (2) All voltage values are with respect to network ground terminal.
- (3) In applications where high power dissipation and/or poor package thermal resistance is present, the maximum ambient temperature may have to be derated. Maximum ambient temperature [T_{A(max)}] is dependent on the maximum operating junction temperature [T_{J(max)}], the maximum power dissipation of the device in the application [P_{D(max)}], and the junction-to-ambient thermal resistance of the part/package in the application (θ_{JA}), as given by the following equation: T_{A(max)} = T_{J(max)} – (θ_{JA} × P_{D(max)})

THERMAL INFORMATION

THERMAL METRIC ⁽¹⁾		TPS22966	UNITS
		DPU (14 PINS)	
θ _{JA}	Junction-to-ambient thermal resistance	52.3	°C/W
θ _{JCtop}	Junction-to-case (top) thermal resistance	45.9	
θ _{JB}	Junction-to-board thermal resistance	11.5	
ψ _{JT}	Junction-to-top characterization parameter	0.8	
ψ _{JB}	Junction-to-board characterization parameter	11.4	
θ _{JCbot}	Junction-to-case (bottom) thermal resistance	6.9	

- (1) For more information about traditional and new thermal metrics, see the *IC Package Thermal Metrics* application report, [SPRA953](#).

RECOMMENDED OPERATING CONDITIONS

			MIN	MAX	UNIT
$V_{IN1,2}$	Input voltage range		0.8	V_{BIAS}	V
V_{BIAS}	Bias voltage range		2.5	5.5	V
$V_{ON1,2}$	ON voltage range		0	5.5	V
$V_{OUT1,2}$	Output voltage range			V_{IN}	V
V_{IH}	High-level input voltage, ON	$V_{BIAS} = 2.5\text{ V to }5.5\text{ V}$	1.2	5.5	V
V_{IL}	Low-level input voltage, ON	$V_{BIAS} = 2.5\text{ V to }5.5\text{ V}$	0	0.5	V
$C_{IN1,2}$	Input capacitor		1 ⁽¹⁾		μF

(1) Refer to Application Information section.

ELECTRICAL CHARACTERISTICS

 Unless otherwise note the specification in the following table applies over the operating ambient temperature $-40^{\circ}\text{C} \leq T_A \leq 85^{\circ}\text{C}$ (full) and $V_{BIAS} = 5.0\text{ V}$. Typical values are for $T_A = 25^{\circ}\text{C}$. (unless otherwise noted)

PARAMETER		TEST CONDITIONS	T_A	MIN	TYP	MAX	UNIT	
POWER SUPPLIES AND CURRENTS								
$I_{IN(VBIAS-ON)}$	V_{BIAS} quiescent current (both channels)	$I_{OUT1} = I_{OUT2} = 0\text{ mA}$, $V_{IN1,2} = V_{ON1,2} = V_{BIAS} = 5.0\text{ V}$	Full	80	120		μA	
$I_{IN(VBIAS-ON)}$	V_{BIAS} quiescent current (single channel)	$I_{OUT1} = I_{OUT2} = 0\text{ mA}$, $V_{ON2} = 0\text{ V}$ $V_{IN1,2} = V_{ON1} = V_{BIAS} = 5.0\text{ V}$	Full	60			μA	
$I_{IN(VBIAS-OFF)}$	V_{BIAS} shutdown current	$V_{ON1,2} = 0\text{ V}$, $V_{OUT1,2} = 0\text{ V}$	Full			2	μA	
$I_{IN(VIN-OFF)}$	$V_{IN1,2}$ off-state supply current (per channel)	$V_{ON1,2} = 0\text{ V}$, $V_{OUT1,2} = 0\text{ V}$	Full	$V_{IN1,2} = 5.0\text{ V}$		0.5	8	μA
				$V_{IN1,2} = 3.3\text{ V}$		0.1	3	
				$V_{IN1,2} = 1.8\text{ V}$		0.07	2	
				$V_{IN1,2} = 0.8\text{ V}$		0.04	1	
I_{ON}	ON pin input leakage current	$V_{ON} = 5.5\text{ V}$	Full			1	μA	
RESISTANCE CHARACTERISTICS								
R_{ON}	ON-state resistance (per channel)	$I_{OUT} = -200\text{ mA}$, $V_{BIAS} = 5.0\text{ V}$	$V_{IN} = 5.0\text{ V}$	25°C	18	25	m Ω	
				Full		27		
			$V_{IN} = 3.3\text{ V}$	25°C	18	25	m Ω	
				Full		27		
			$V_{IN} = 1.8\text{ V}$	25°C	18	25	m Ω	
				Full		27		
			$V_{IN} = 1.5\text{ V}$	25°C	18	25	m Ω	
				Full		27		
			$V_{IN} = 1.2\text{ V}$	25°C	18	25	m Ω	
				Full		27		
			$V_{IN} = 0.8\text{ V}$	25°C	18	25	m Ω	
				Full		27		
R_{PD}	Output pulldown resistance	$V_{IN} = 5.0\text{ V}$, $V_{ON} = 0\text{ V}$, $I_{OUT} = 15\text{ mA}$	Full	220	300		Ω	

ELECTRICAL CHARACTERISTICS

Unless otherwise noted, the specification in the following table applies over the operating ambient temp $-40^{\circ}\text{C} \leq T_A \leq 85^{\circ}\text{C}$ (full) and $V_{\text{BIAS}} = 2.5\text{ V}$. Typical values are for $T_A = 25^{\circ}\text{C}$ unless otherwise noted.

PARAMETER		TEST CONDITIONS	T_A	MIN	TYP	MAX	UNIT			
POWER SUPPLIES AND CURRENTS										
$I_{\text{IN}}(\text{VBIAS-ON})$	V_{BIAS} quiescent current (both channels)	$I_{\text{OUT}1} = I_{\text{OUT}2} = 0\text{ mA}$, $V_{\text{IN}1,2} = V_{\text{ON}1,2} = V_{\text{BIAS}} = 2.5\text{ V}$	Full		32	37	μA			
$I_{\text{IN}}(\text{VBIAS-ON})$	V_{BIAS} quiescent current (single channel)	$I_{\text{OUT}1} = I_{\text{OUT}2} = 0\text{ mA}$, $V_{\text{ON}2} = 0\text{ V}$ $V_{\text{IN}1,2} = V_{\text{ON}1} = V_{\text{BIAS}} = 2.5\text{ V}$	Full		23		μA			
$I_{\text{IN}}(\text{VBIAS-OFF})$	V_{BIAS} shutdown current	$V_{\text{ON}1,2} = 0\text{ V}$, $V_{\text{OUT}1,2} = 0\text{ V}$	Full			2	μA			
$I_{\text{IN}}(\text{VIN-OFF})$	$V_{\text{IN}1,2}$ off-state supply current (per channel)	$V_{\text{ON}1,2} = 0\text{ V}$, $V_{\text{OUT}1,2} = 0\text{ V}$	Full		$V_{\text{IN}1,2} = 2.5\text{ V}$	0.13	3	μA		
					$V_{\text{IN}1,2} = 1.8\text{ V}$	0.07	2			
					$V_{\text{IN}1,2} = 1.2\text{ V}$	0.05	2			
					$V_{\text{IN}1,2} = 0.8\text{ V}$	0.04	1			
I_{ON}	ON pin input leakage current	$V_{\text{ON}} = 5.5\text{ V}$	Full			1	μA			
RESISTANCE CHARACTERISTICS										
R_{ON}	ON-state resistance	$I_{\text{OUT}} = -200\text{ mA}$, $V_{\text{BIAS}} = 2.5\text{ V}$	$V_{\text{IN}} = 2.5\text{ V}$	25°C	22	28	$\text{m}\Omega$			
				Full		30				
			$V_{\text{IN}} = 1.8\text{ V}$	25°C	21	28	$\text{m}\Omega$			
				Full		30				
			$V_{\text{IN}} = 1.5\text{ V}$	25°C	20	27	$\text{m}\Omega$			
				Full		29				
			$V_{\text{IN}} = 1.2\text{ V}$	25°C	20	27	$\text{m}\Omega$			
				Full		29				
			$V_{\text{IN}} = 0.8\text{ V}$	25°C	19	27	$\text{m}\Omega$			
				Full		29				
			R_{PD}	Output pulldown resistance	$V_{\text{IN}} = 2.5\text{ V}$, $V_{\text{ON}} = 0\text{ V}$, $I_{\text{OUT}} = 1\text{ mA}$	Full		260	300	Ω

SWITCHING CHARACTERISTIC MEASUREMENT INFORMATION

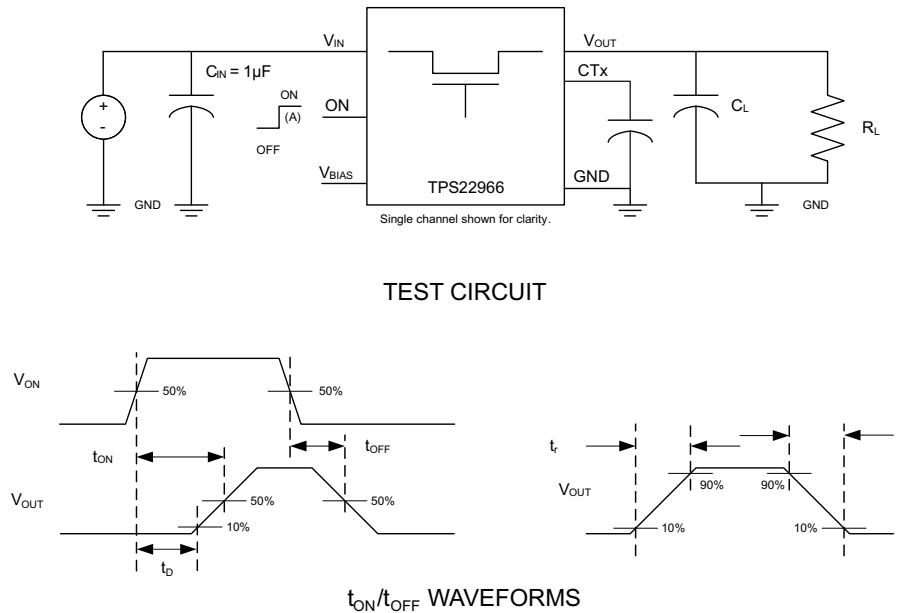

(A) Rise and fall times of the control signal is 100ns.

Figure 2. Test Circuit and tON/tOFF Waveforms

SWITCHING CHARACTERISTICS

PARAMETER	TEST CONDITION	MIN	TYP	MAX	UNIT
V_{IN} = V_{ON} = V_{BIAS} = 5 V, T_A = 25°C (unless otherwise noted)					
t _{ON}	Turn-on time		1310		µs
t _{OFF}	Turn-off time		6		
t _R	V _{OUT} rise time		1720		
t _F	V _{OUT} fall time		2		
t _D	ON delay time		460		
V_{IN} = 0.8 V, V_{ON} = V_{BIAS} = 5 V, T_A = 25°C (unless otherwise noted)					
t _{ON}	Turn-on time		550		µs
t _{OFF}	Turn-off time		170		
t _R	V _{OUT} rise time		325		
t _F	V _{OUT} fall time		16		
t _D	ON delay time		400		
V_{IN} = 2.5 V, V_{ON} = 5 V, V_{BIAS} = 2.5 V, T_A = 25°C (unless otherwise noted)					
t _{ON}	Turn-on time		2050		µs
t _{OFF}	Turn-off time		5		
t _R	V _{OUT} rise time		2275		
t _F	V _{OUT} fall time		2.5		
t _D	ON delay time		990		
V_{IN} = 0.8 V, V_{ON} = 5 V, V_{BIAS} = 2.5 V, T_A = 25°C (unless otherwise noted)					
t _{ON}	Turn-on time		1300		µs
t _{OFF}	Turn-off time		130		
t _R	V _{OUT} rise time		875		
t _F	V _{OUT} fall time		16		
t _D	ON delay time		870		

FUNCTIONAL BLOCK DIAGRAM

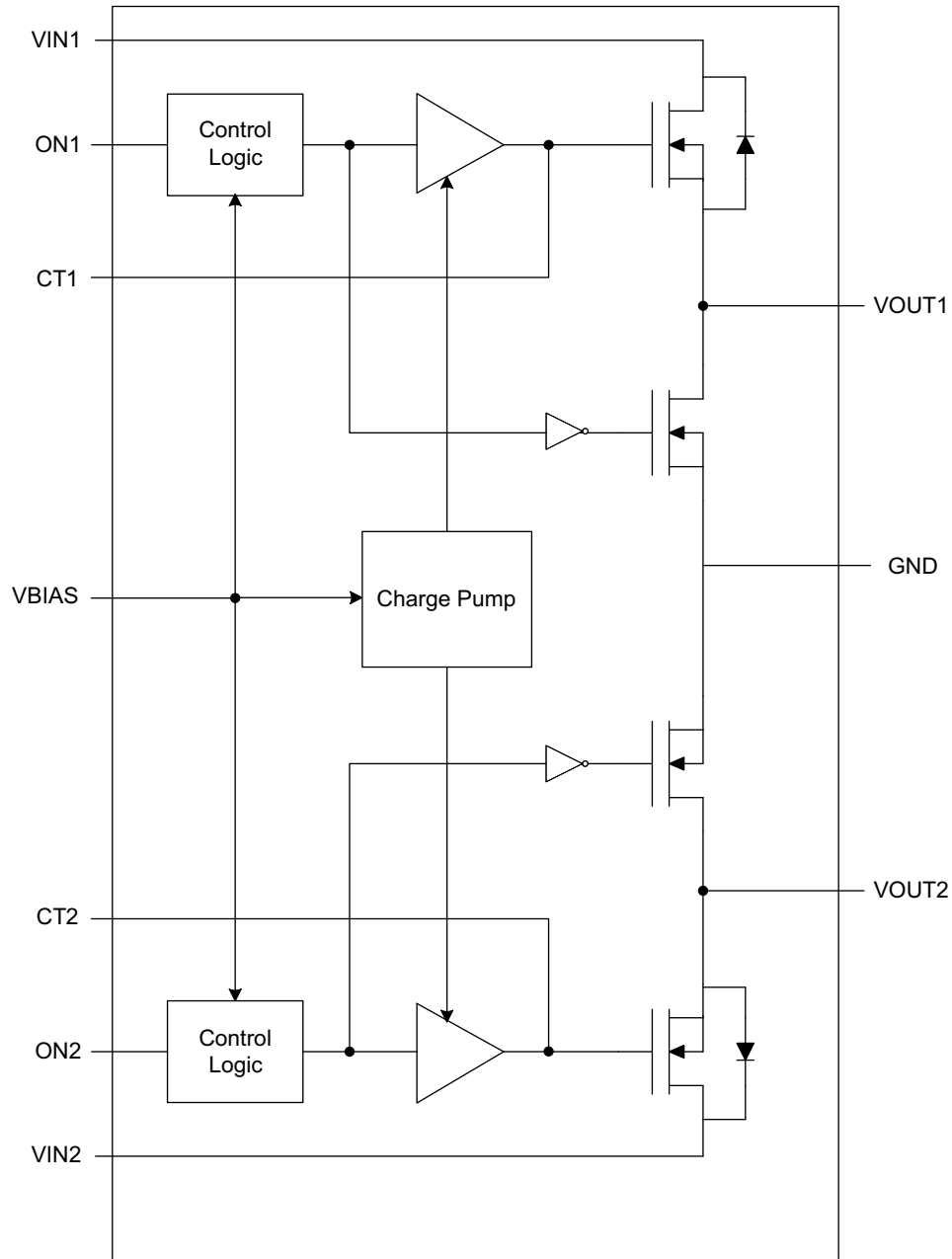
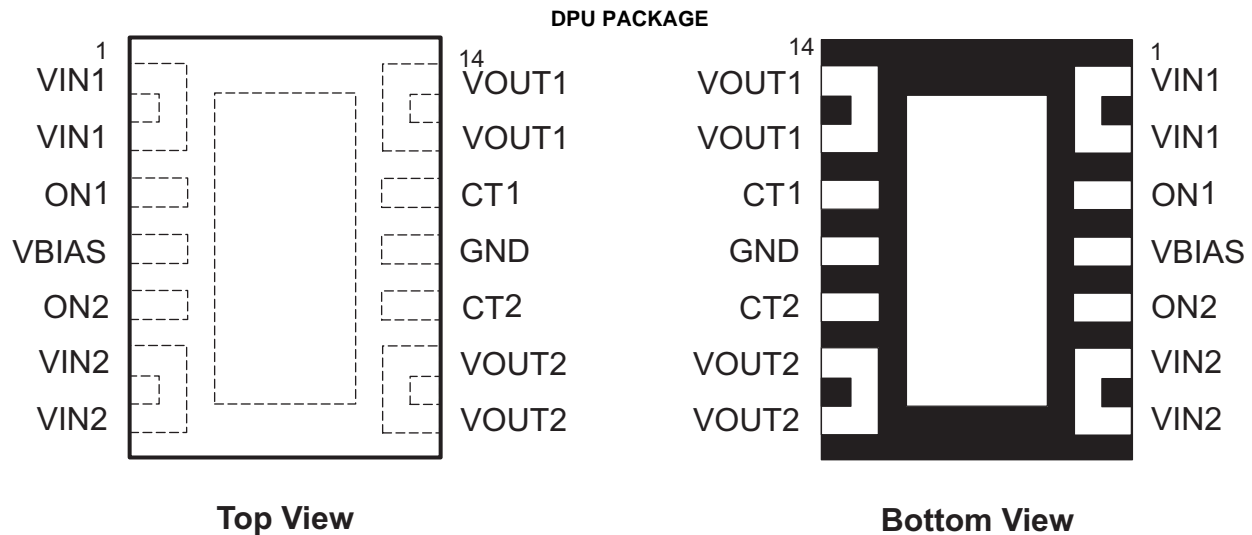

Figure 3. Functional Block Diagram

Table 2. FUNCTIONAL TABLE

ONx	VINx to VOUTx	VOUTx to GND
L	Off	On
H	On	Off



PIN TABLE

TPS22966 DPU	PIN NAME	I/O	DESCRIPTION
1	VIN1	I	Switch #1 input. Recommended voltage range for this pin for optimal R_{ON} performance is 0.8V to V_{BIAS} . Place an optional decoupling capacitor between this pin and GND for reduce VIN dip during turn-on of the channel. See Application Information section for more information.
2	VIN1	I	Switch #1 input. Recommended voltage range for this pin for optimal R_{ON} performance is 0.8V to V_{BIAS} . Place an optional decoupling capacitor between this pin and GND for reduce VIN dip during turn-on of the channel. See Application Information section for more information.
3	ON1	I	Active high switch #1 control input. Do not leave floating.
4	VBIAS	I	Bias voltage. Power supply to the device. Recommended voltage range for this pin is 2.5V to 5.5V. See Application Information section.
5	ON2	I	Active high switch #2 control input. Do not leave floating.
6	VIN2	I	Switch #2 input. Recommended voltage range for this pin for optimal R_{ON} performance is 0.8V to V_{BIAS} . Place an optional decoupling capacitor between this pin and GND for reduce VIN dip during turn-on of the channel. See Application Information section for more information.
7	VIN2	I	Switch #2 input. Recommended voltage range for this pin for optimal R_{ON} performance is 0.8V to V_{BIAS} . Place an optional decoupling capacitor between this pin and GND for reduce VIN dip during turn-on of the channel. See Application Information section for more information.
8	VOUT2	O	Switch #2 output.
9	VOUT2	O	Switch #2 output.
10	CT2	O	Switch #2 slew rate control. Can be left floating. Capacitor used on this pin should be rated for a minimum of 25V for desired rise time performance.
11	GND	–	Ground
12	CT1	O	Switch #1 slew rate control. Can be left floating. Capacitor used on this pin should be rated for a minimum of 25V for desired rise time performance.
13	VOUT1	O	Switch #1 output.
14	VOUT1	O	Switch #1 output.
15	Thermal Pad	O	Thermal pad (exposed center pad) to alleviate thermal stress. Tie to GND. See Application Information for layout guidelines.

TYPICAL CHARACTERISTICS

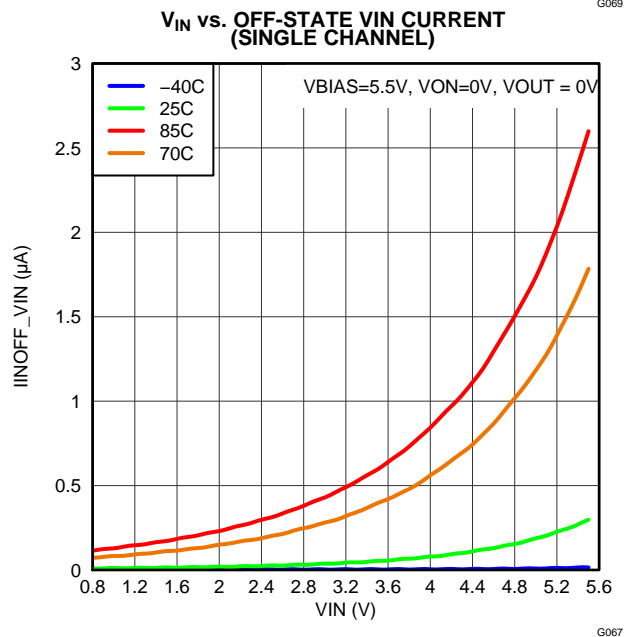
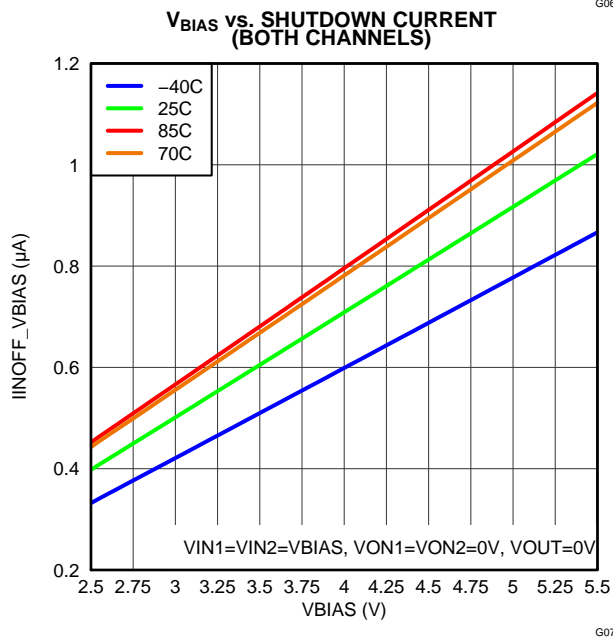
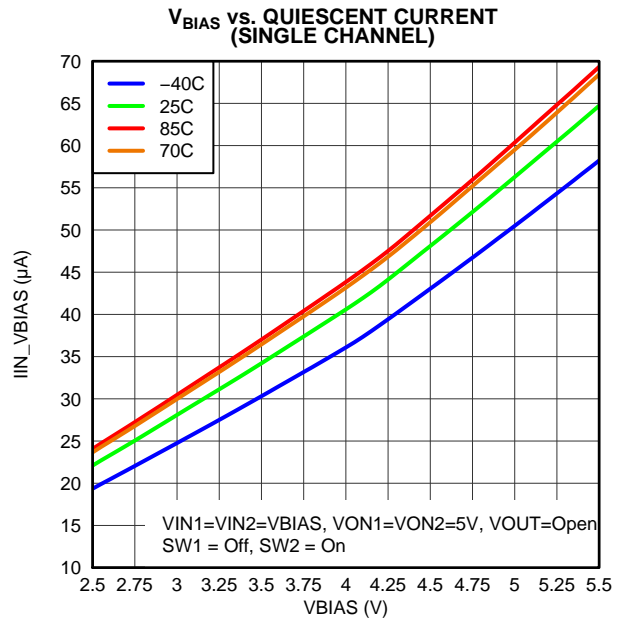
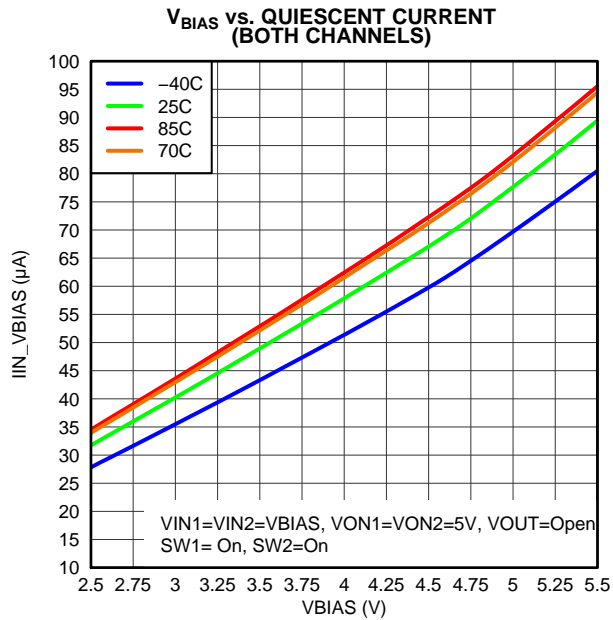

TYPICAL CHARACTERISTICS (continued)

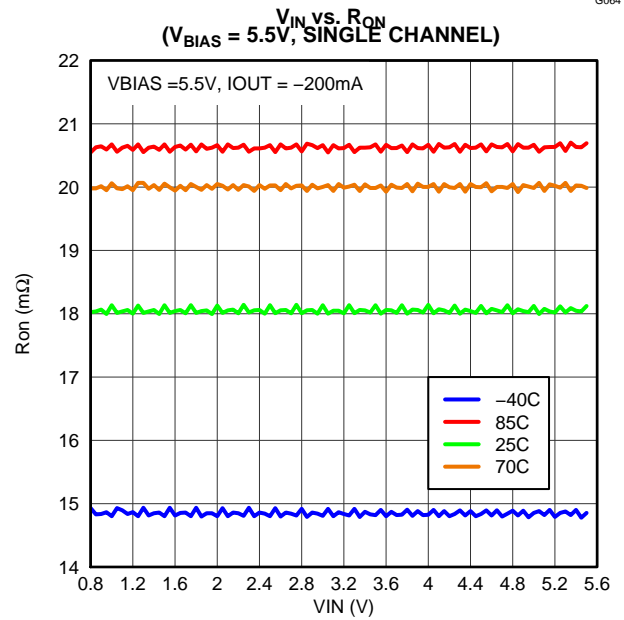
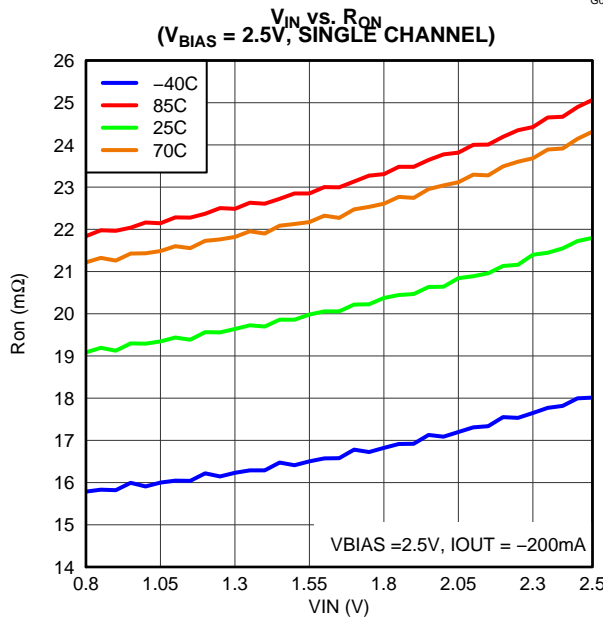
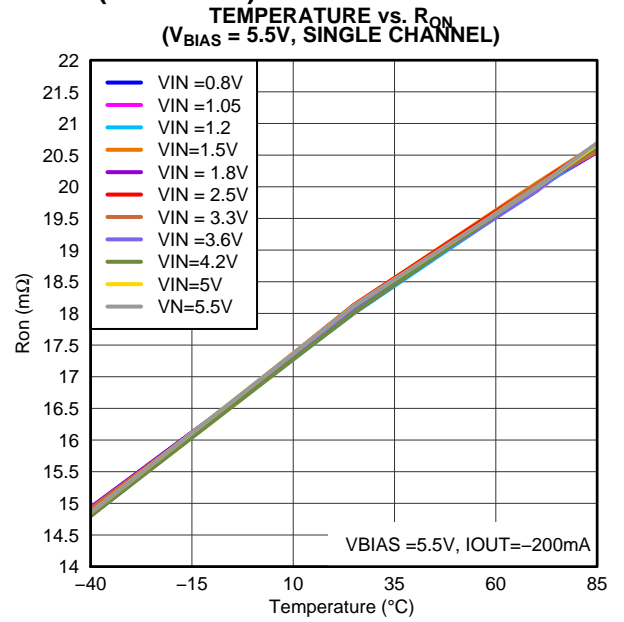
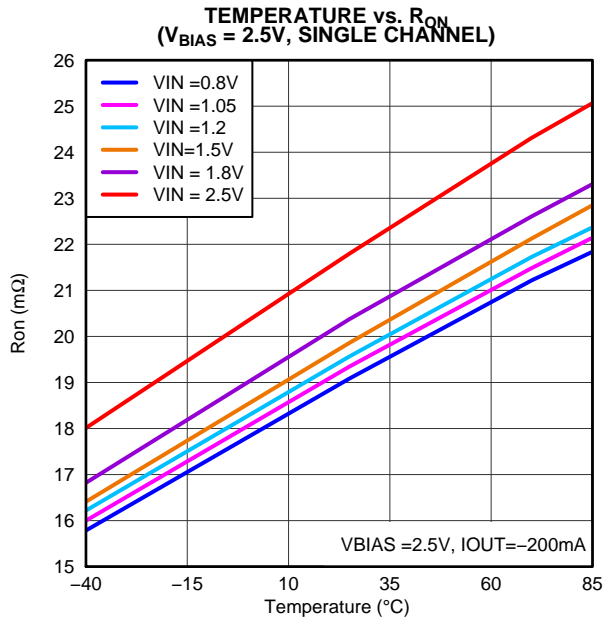

TYPICAL CHARACTERISTICS (continued)

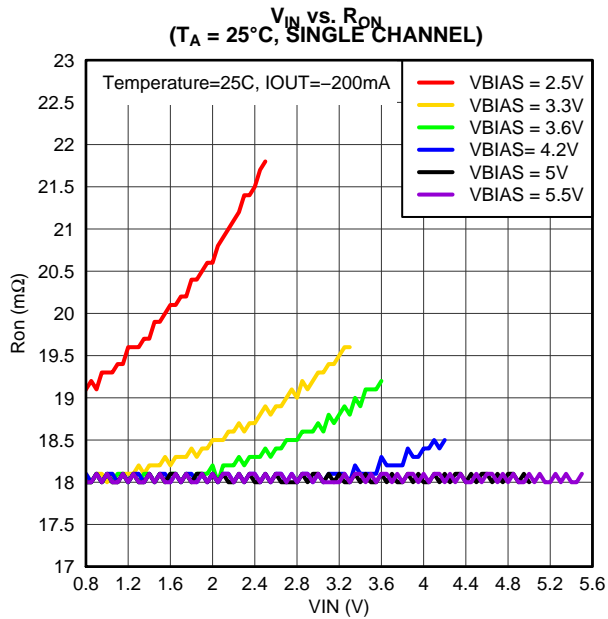

G062

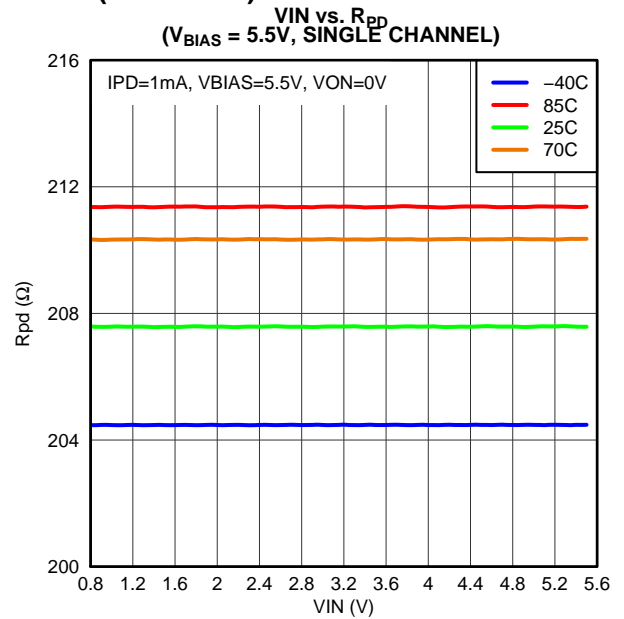

G065

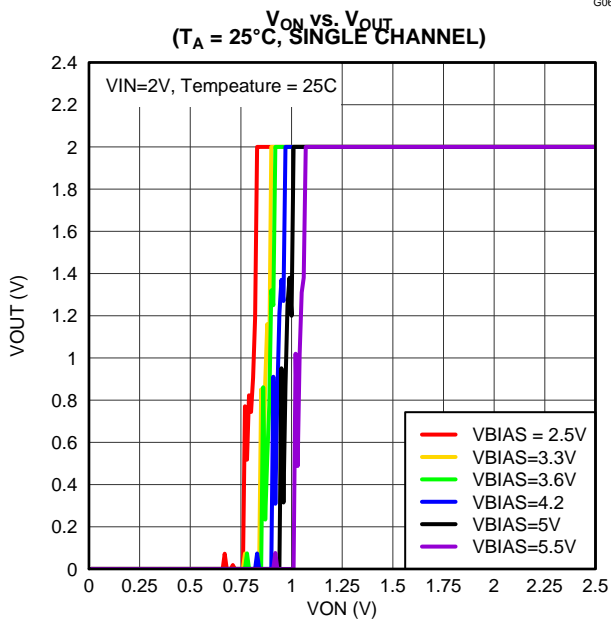

G066

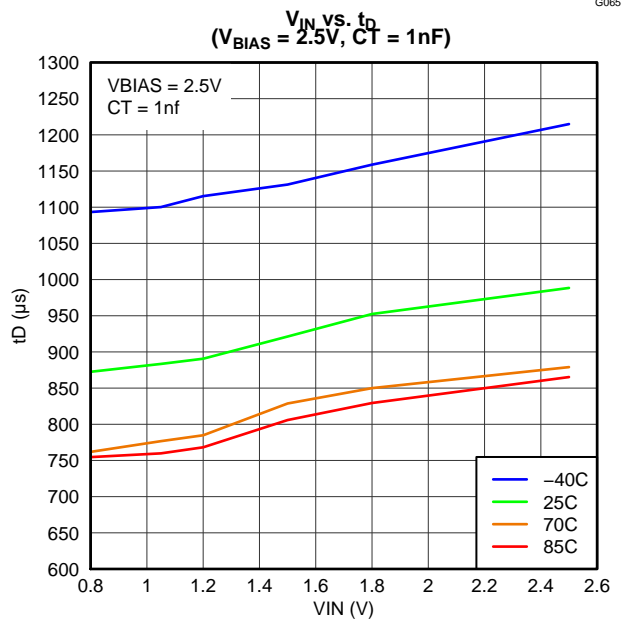

G030

TYPICAL CHARACTERISTICS (continued)

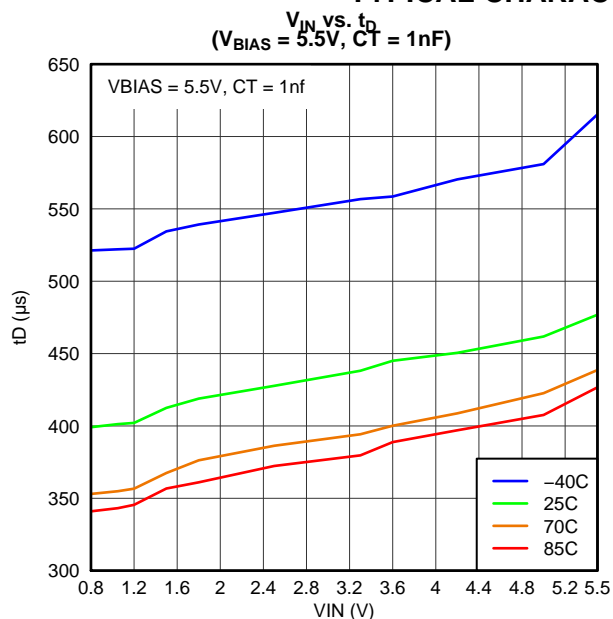

G035

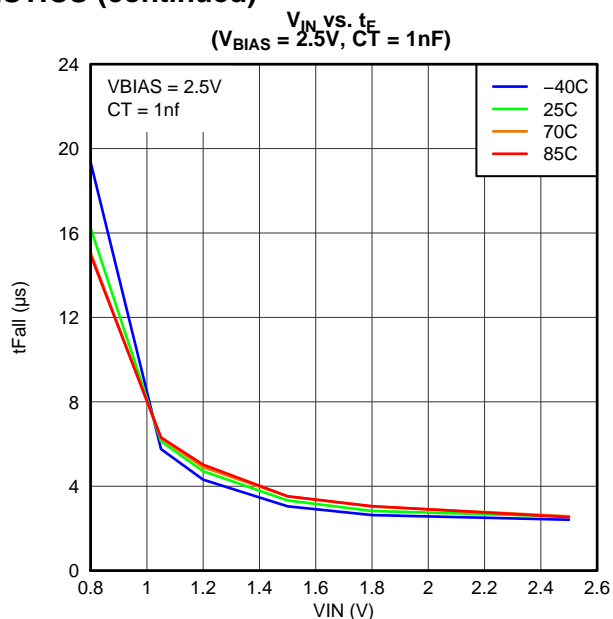

G036

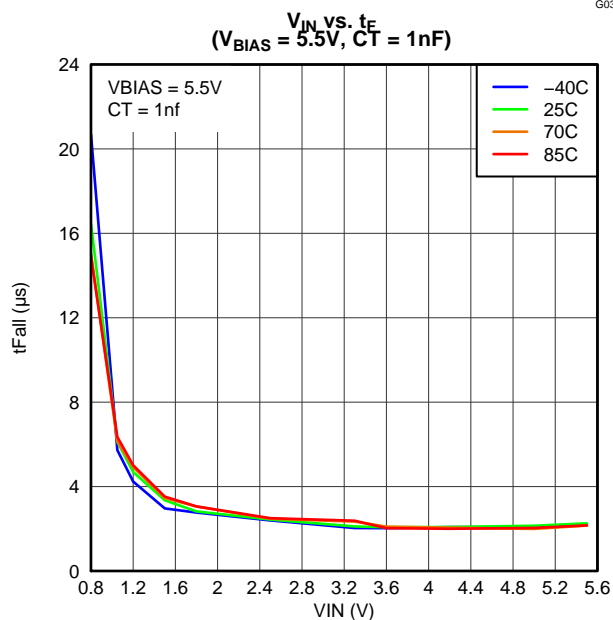

G041

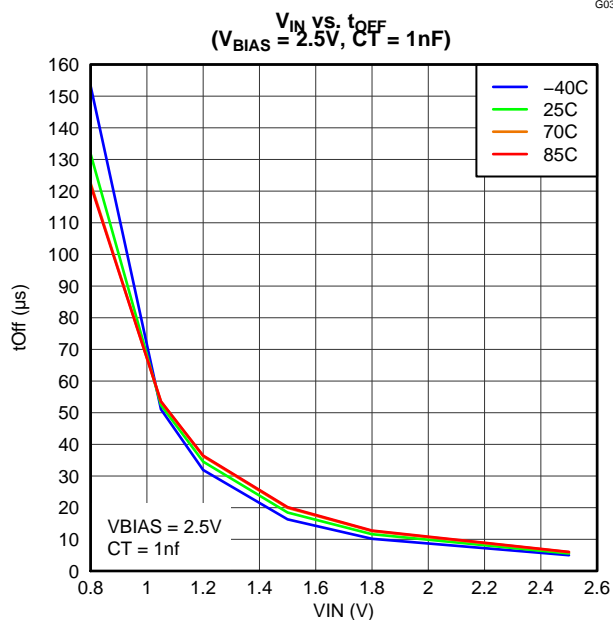

G042

TYPICAL CHARACTERISTICS (continued)

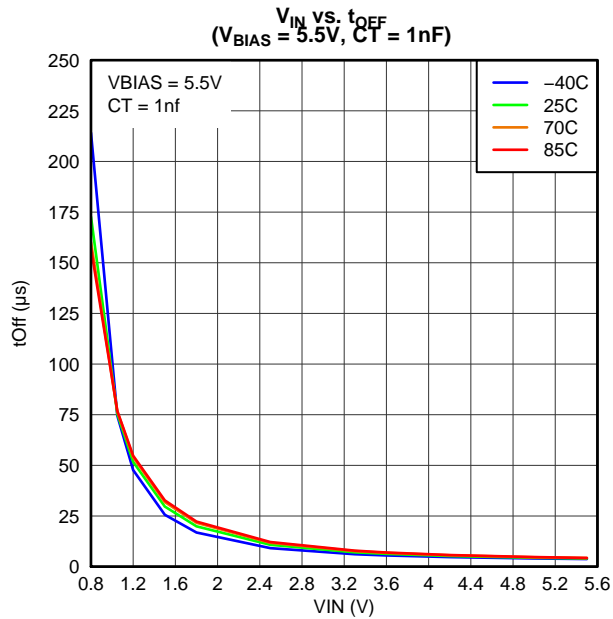

G047

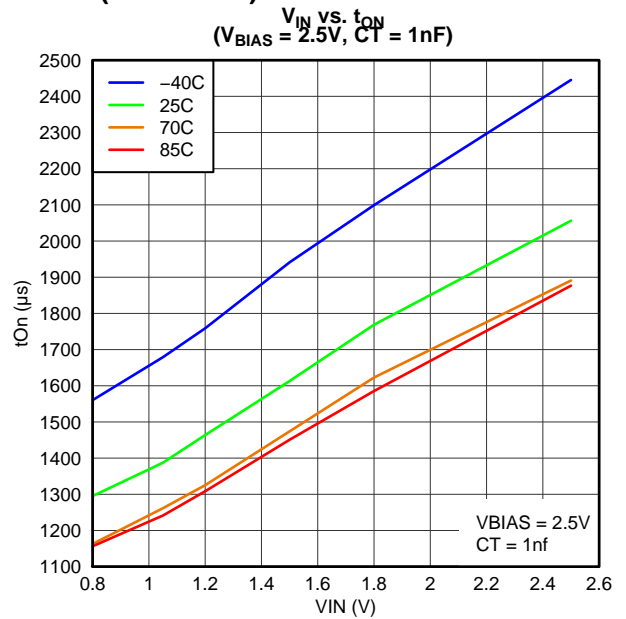

G048

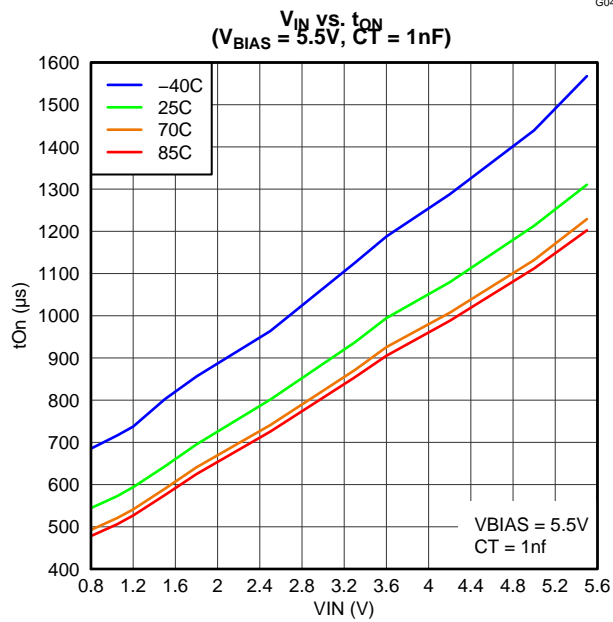

G053

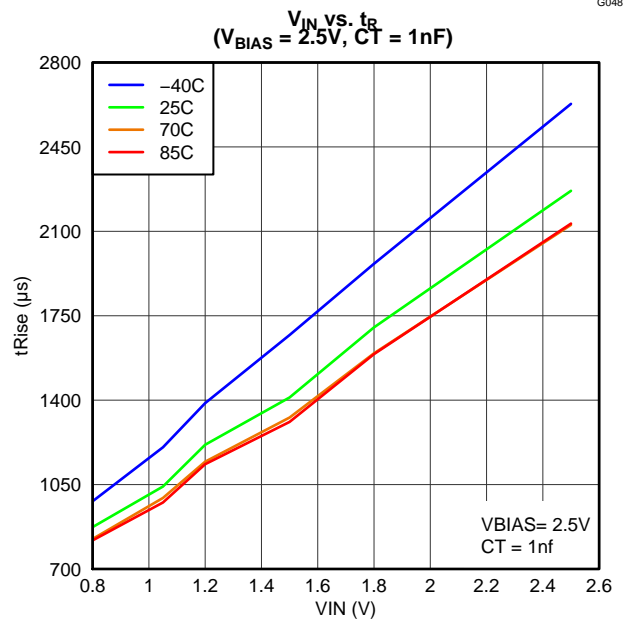

G061

TYPICAL CHARACTERISTICS (continued)

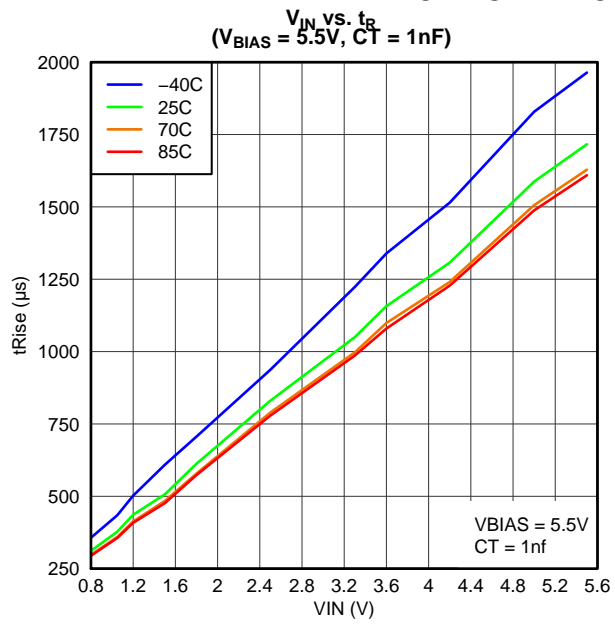

G059

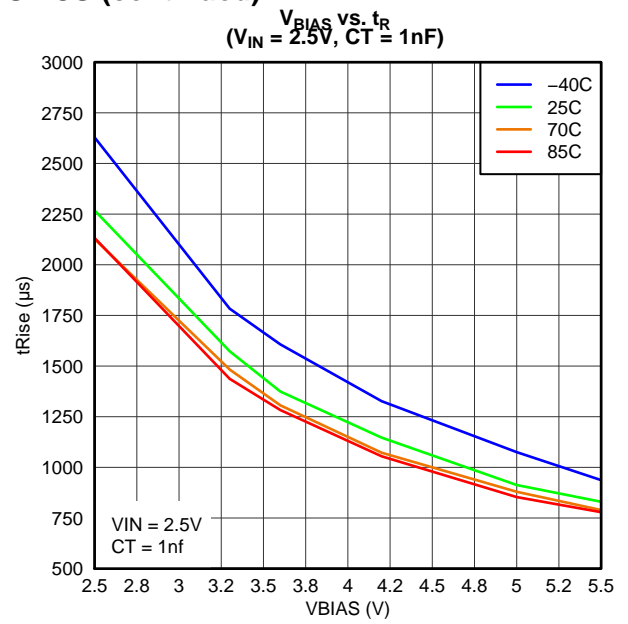

G061

TYPICAL AC SCOPE CAPTURES @ $T_A = 25^\circ\text{C}$, $C_T = 1\text{nF}$

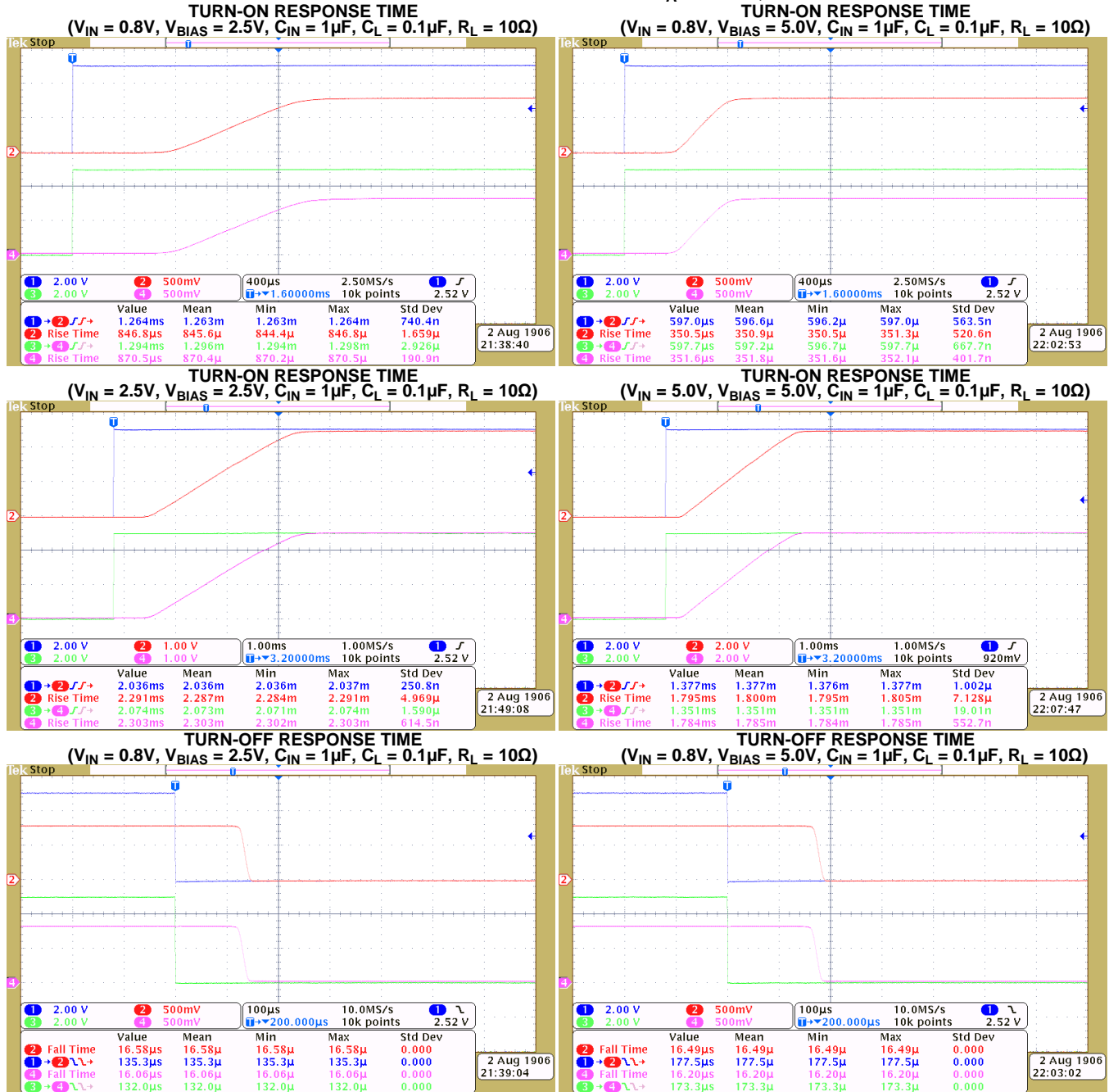

TYPICAL AC SCOPE CAPTURES @ $T_A = 25^\circ\text{C}$, $C_T = 1\text{nF}$ (continued)

TURN-OFF RESPONSE TIME
 $(V_{IN} = 2.5\text{V}, V_{BIAS} = 2.5\text{V}, C_{IN} = 1\mu\text{F}, C_L = 0.1\mu\text{F}, R_L = 10\Omega)$

TURN-OFF RESPONSE TIME
 $(V_{IN} = 5.0\text{V}, V_{BIAS} = 5.0\text{V}, C_{IN} = 1\mu\text{F}, C_L = 0.1\mu\text{F}, R_L = 10\Omega)$

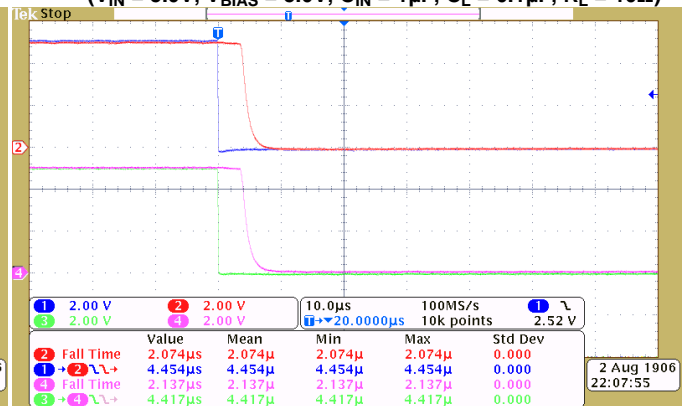
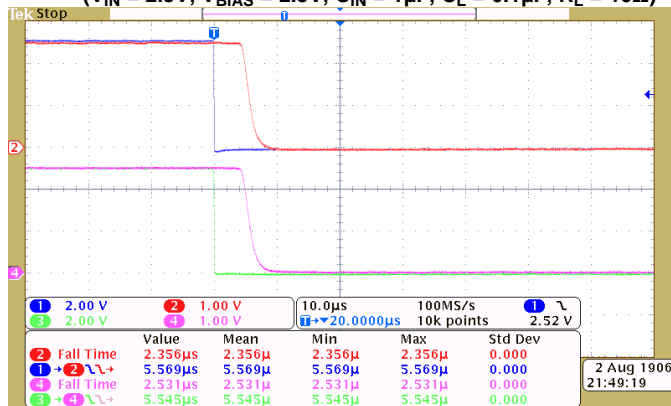

APPLICATION INFORMATION

ON/OFF CONTROL

The ON pins control the state of the switch. Asserting ON high enables the switch. ON is active high and has a low threshold, making it capable of interfacing with low-voltage signals. The ON pin is compatible with standard GPIO logic threshold. It can be used with any microcontroller with 1.2-V or higher GPIO voltage. This pin cannot be left floating and must be tied either high or low for proper functionality.

INPUT CAPACITOR (OPTIONAL)

To limit the voltage drop on the input supply caused by transient in-rush currents when the switch turns on into a discharged load capacitor or short-circuit, a capacitor needs to be placed between VIN and GND. A 1- μ F ceramic capacitor, C_{IN}, placed close to the pins, is usually sufficient. Higher values of C_{IN} can be used to further reduce the voltage drop during high-current application. When switching heavy loads, it is recommended to have an input capacitor about 10 times higher than the output capacitor to avoid excessive voltage drop.

OUTPUT CAPACITOR (OPTIONAL)

Due to the integrated body diode in the NMOS switch, a C_{IN} greater than C_L is highly recommended. A C_L greater than C_{IN} can cause V_{OUT} to exceed V_{IN} when the system supply is removed. This could result in current flow through the body diode from V_{OUT} to V_{IN}. A C_{IN} to C_L ratio of 10 to 1 is recommended for minimizing V_{IN} dip caused by inrush currents during startup, however a 10 to 1 ratio for capacitance is not required for proper functionality of the device. A ratio smaller than 10 to 1 (such as 1 to 1) could cause slightly more V_{IN} dip upon turn-on due to inrush currents. This can be mitigated by increasing the capacitance on the CT pin for a longer rise time (see Figure 4).

V_{IN} and V_{BIAS} VOLTAGE RANGE

For optimal R_{ON} performance, make sure V_{IN} ≤ V_{BIAS}. The device will still be functional if V_{IN} > V_{BIAS} but it will exhibit R_{ON} greater than what is listed in the ELECTRICAL CHARACTERISTICS table. See Figure 4 for an example of a typical device. Notice the increasing R_{ON} as V_{IN} exceeds V_{BIAS} voltage. Be sure to never exceed the maximum voltage rating for V_{IN} and V_{BIAS}.

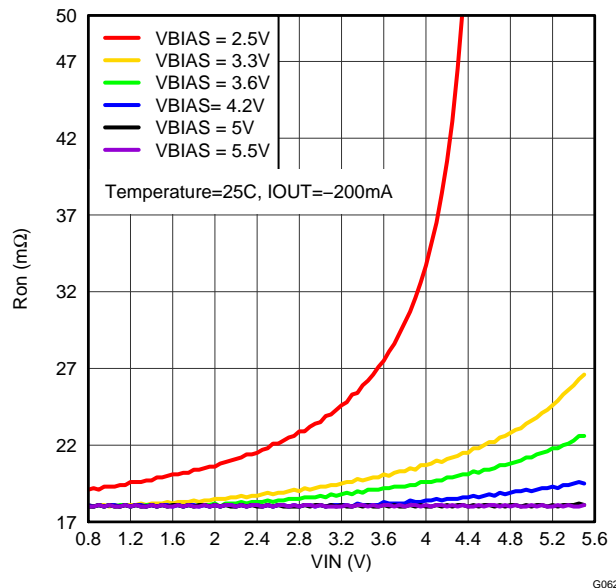

Figure 4. R_{ON} vs. V_{IN} (V_{IN} > V_{BIAS}, Single Channel)

ADJUSTABLE RISE TIME

A capacitor to GND on the CTx pins sets the slew rate for each channel. To ensure desired performance, a capacitor with a minimum voltage rating of 25V should be used on the CTx pin. An approximate formula for the relationship between CTx and slew rate is (the equation below accounts for 10% to 90% measurement on V_{OUT} and does **NOT** apply for CTx = 0pF. Use table below to determine rise times for when CTx = 0pF):

$$SR = 0.32 \times CT + 13.7 \quad (1)$$

Where,

SR = slew rate (in $\mu\text{s/V}$)

CT = the capacitance value on the CTx pin (in pF)

The units for the constant 13.7 is in $\mu\text{s/V}$.

Rise time can be calculated by multiplying the input voltage by the slew rate. The table below contains rise time values measured on a typical device. Rise times shown below are only valid for the power-up sequence where V_{IN} and V_{BIAS} are already in steady state condition, and the ON pin is asserted high.

CTx (pF)	RISE TIME (μs) 10% - 90%, C _L = 0.1 μF , C _{IN} = 1 μF , R _L = 10 Ω TYPICAL VALUES at 25°C, V _{BIAS} = 5V, 25V X7R 10% CERAMIC CAP						
	5V	3.3V	1.8V	1.5V	1.2V	1.05V	0.8V
0	124	88	63	60	53	49	42
220	481	323	193	166	143	133	109
470	855	603	348	299	251	228	175
1000	1724	1185	670	570	469	411	342
2200	3328	2240	1308	1088	893	808	650
4700	7459	4950	2820	2429	1920	1748	1411
10000	16059	10835	6040	5055	4230	3770	3033

BOARD LAYOUT AND THERMAL CONSIDERATIONS

For best performance, all traces should be as short as possible. To be most effective, the input and output capacitors should be placed close to the device to minimize the effects that parasitic trace inductances may have on normal operation. Using wide traces for VIN, VOUT, and GND helps minimize the parasitic electrical effects along with minimizing the case to ambient thermal impedance.

The maximum IC junction temperature should be restricted to 125°C under normal operating conditions. To calculate the maximum allowable power dissipation, $P_{D(max)}$ for a given output current and ambient temperature, use the following equation:

$$P_{D(max)} = \frac{T_{J(max)} - T_A}{\Theta_{JA}} \tag{2}$$

Where:

$P_{D(max)}$ = maximum allowable power dissipation

$T_{J(max)}$ = maximum allowable junction temperature (125°C for the TPS22966)

T_A = ambient temperature of the device

Θ_{JA} = junction to air thermal impedance. See Thermal Information section. This parameter is highly dependent upon board layout.

The figure below shows an example of a layout. Notice the thermal vias located under the exposed thermal pad of the device. This allows for thermal diffusion away from the device.

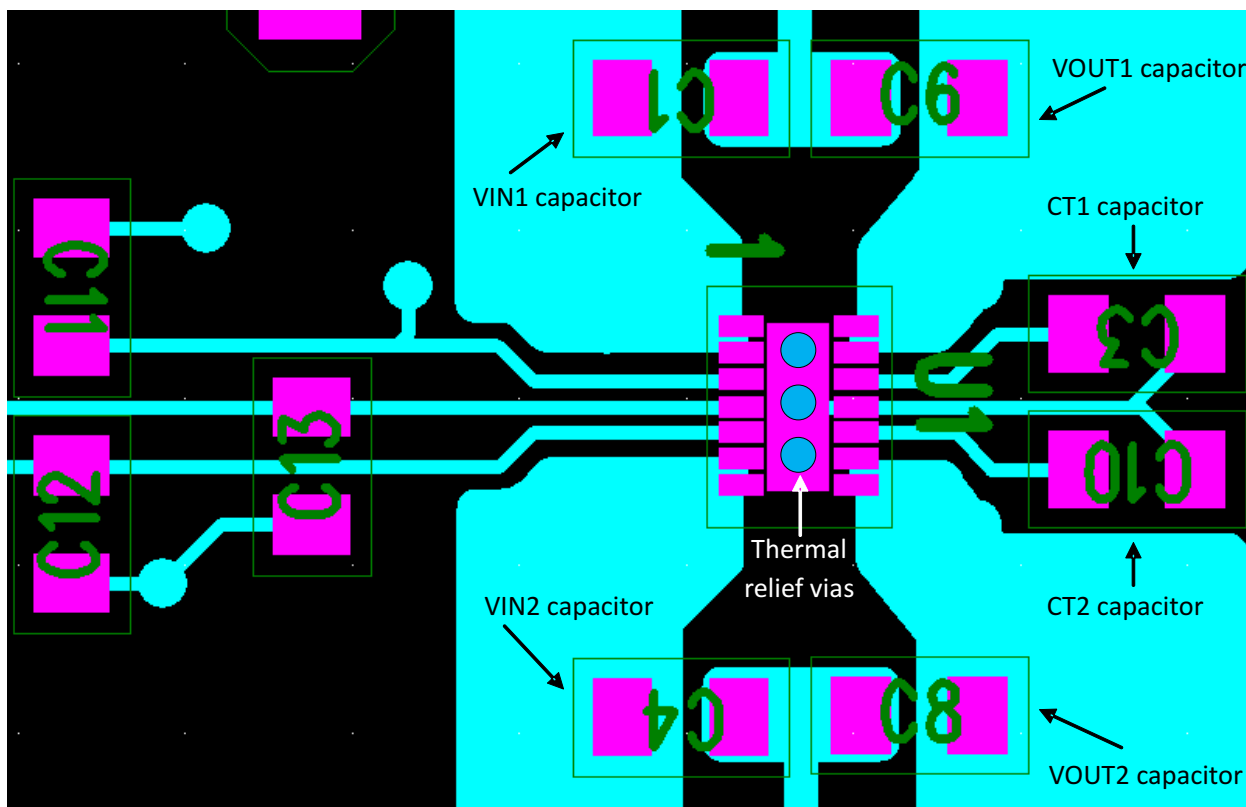

REVISION HISTORY

Changes from Original (June 2012) to Revision A Page

- Updated V_{BIAS} vs. QUIESCENT CURRENT (BOTH CHANNELS) Y-axis Units. 8
 - Updated V_{BIAS} vs. QUIESCENT CURRENT (SINGLE CHANNEL) Y-axis Units. 8
-

Changes from Revision A (July 2012) to Revision B Page

- 已更新典型应用电路原理图 1
 - Updated Functional Block Diagram 6
-

Changes from Revision B (December 2012) to Revision C Page

- Added VBIAS to ABSOLUTE MAXIMUM RATINGS table. 2
 - Updated SWITCHING CHARACTERISTIC MEASUREMENT INFORMATION. 5
 - Updated Test Circuit Diagram. 5
 - Updated Functional Block Diagram 6
-

PACKAGING INFORMATION

Orderable Device	Status (1)	Package Type	Package Drawing	Pins	Package Qty	Eco Plan (2)	Lead finish/ Ball material (6)	MSL Peak Temp (3)	Op Temp (°C)	Device Marking (4/5)	Samples
TPS22966DPUR	ACTIVE	WSON	DPU	14	3000	RoHS & Green	NIPDAU	Level-2-260C-1 YEAR	-40 to 105	RB966	Samples
TPS22966DPUT	ACTIVE	WSON	DPU	14	250	RoHS & Green	NIPDAU	Level-2-260C-1 YEAR	-40 to 105	RB966	Samples

(1) The marketing status values are defined as follows:

ACTIVE: Product device recommended for new designs.

LIFEBUY: TI has announced that the device will be discontinued, and a lifetime-buy period is in effect.

NRND: Not recommended for new designs. Device is in production to support existing customers, but TI does not recommend using this part in a new design.

PREVIEW: Device has been announced but is not in production. Samples may or may not be available.

OBSOLETE: TI has discontinued the production of the device.

(2) **RoHS:** TI defines "RoHS" to mean semiconductor products that are compliant with the current EU RoHS requirements for all 10 RoHS substances, including the requirement that RoHS substance do not exceed 0.1% by weight in homogeneous materials. Where designed to be soldered at high temperatures, "RoHS" products are suitable for use in specified lead-free processes. TI may reference these types of products as "Pb-Free".

RoHS Exempt: TI defines "RoHS Exempt" to mean products that contain lead but are compliant with EU RoHS pursuant to a specific EU RoHS exemption.

Green: TI defines "Green" to mean the content of Chlorine (Cl) and Bromine (Br) based flame retardants meet JS709B low halogen requirements of <=1000ppm threshold. Antimony trioxide based flame retardants must also meet the <=1000ppm threshold requirement.

(3) MSL, Peak Temp. - The Moisture Sensitivity Level rating according to the JEDEC industry standard classifications, and peak solder temperature.

(4) There may be additional marking, which relates to the logo, the lot trace code information, or the environmental category on the device.

(5) Multiple Device Markings will be inside parentheses. Only one Device Marking contained in parentheses and separated by a "~" will appear on a device. If a line is indented then it is a continuation of the previous line and the two combined represent the entire Device Marking for that device.

(6) Lead finish/Ball material - Orderable Devices may have multiple material finish options. Finish options are separated by a vertical ruled line. Lead finish/Ball material values may wrap to two lines if the finish value exceeds the maximum column width.

Important Information and Disclaimer:The information provided on this page represents TI's knowledge and belief as of the date that it is provided. TI bases its knowledge and belief on information provided by third parties, and makes no representation or warranty as to the accuracy of such information. Efforts are underway to better integrate information from third parties. TI has taken and continues to take reasonable steps to provide representative and accurate information but may not have conducted destructive testing or chemical analysis on incoming materials and chemicals. TI and TI suppliers consider certain information to be proprietary, and thus CAS numbers and other limited information may not be available for release.

In no event shall TI's liability arising out of such information exceed the total purchase price of the TI part(s) at issue in this document sold by TI to Customer on an annual basis.

TAPE AND REEL INFORMATION

QUADRANT ASSIGNMENTS FOR PIN 1 ORIENTATION IN TAPE

*All dimensions are nominal

Device	Package Type	Package Drawing	Pins	SPQ	Reel Diameter (mm)	Reel Width W1 (mm)	A0 (mm)	B0 (mm)	K0 (mm)	P1 (mm)	W (mm)	Pin1 Quadrant
TPS22966DPUR	WSON	DPU	14	3000	180.0	8.4	2.25	3.25	1.05	4.0	8.0	Q1
TPS22966DPUT	WSON	DPU	14	250	180.0	8.4	2.25	3.25	1.05	4.0	8.0	Q1

TAPE AND REEL BOX DIMENSIONS

*All dimensions are nominal

Device	Package Type	Package Drawing	Pins	SPQ	Length (mm)	Width (mm)	Height (mm)
TPS22966DPUR	WSON	DPU	14	3000	210.0	185.0	35.0
TPS22966DPUT	WSON	DPU	14	250	210.0	185.0	35.0

DPU (R-PWSON-N14)

PLASTIC SMALL OUTLINE NO-LEAD

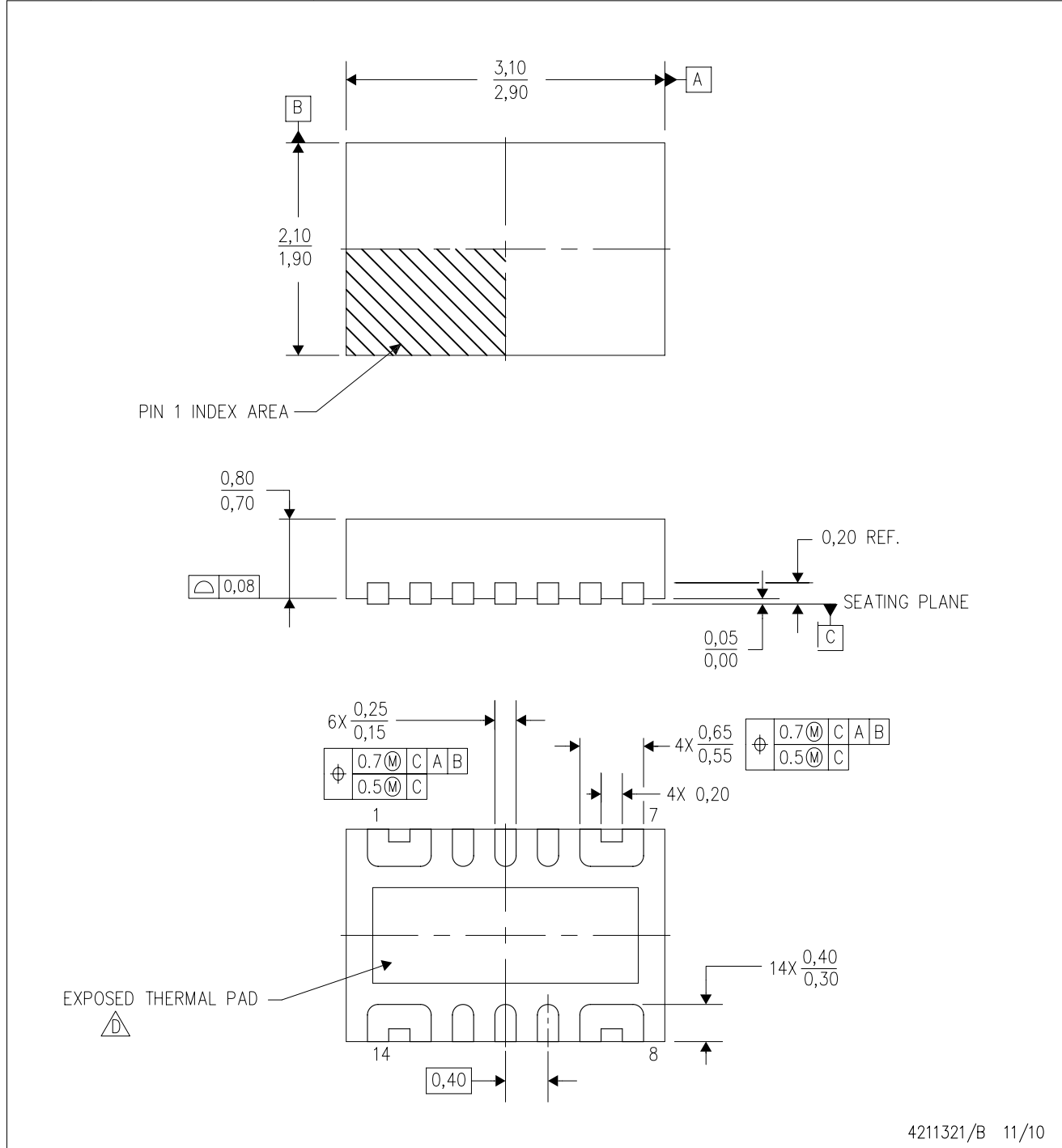

- NOTES:
- All linear dimensions are in millimeters. Dimensioning and tolerancing per ASME Y14.5M-1994.
 - This drawing is subject to change without notice.
 - Small Outline No-Lead (SON) package configuration.
 - The package thermal pad must be soldered to the board for thermal and mechanical performance. See the Product Data Sheet for details regarding the exposed thermal pad dimensions.
 - This package is Pb-free.

THERMAL PAD MECHANICAL DATA

DPU (R-PWSON-N14)

PLASTIC SMALL OUTLINE NO-LEAD

THERMAL INFORMATION

This package incorporates an exposed thermal pad that is designed to be attached directly to an external heatsink. The thermal pad must be soldered directly to the printed circuit board (PCB). After soldering, the PCB can be used as a heatsink. In addition, through the use of thermal vias, the thermal pad can be attached directly to the appropriate copper plane shown in the electrical schematic for the device, or alternatively, can be attached to a special heatsink structure designed into the PCB. This design optimizes the heat transfer from the integrated circuit (IC).

For information on the Quad Flatpack No-Lead (QFN) package and its advantages, refer to Application Report, QFN/SON PCB Attachment, Texas Instruments Literature No. SLUA271. This document is available at www.ti.com.

The exposed thermal pad dimensions for this package are shown in the following illustration.

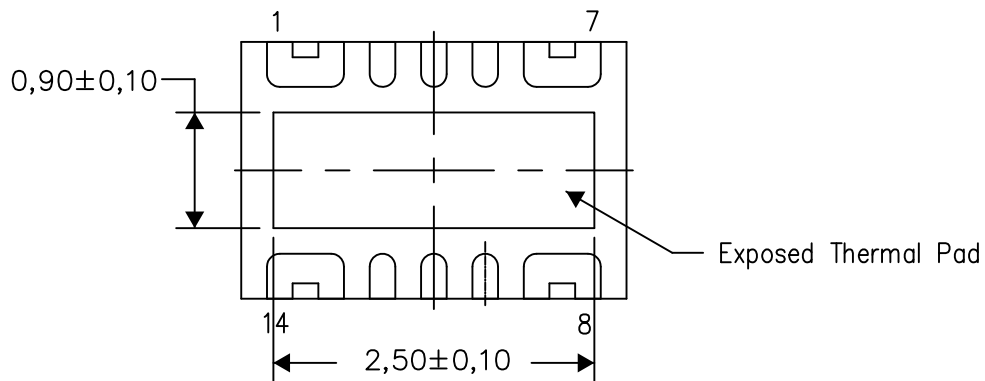

Bottom View

Exposed Thermal Pad Dimensions

4211395/C 04/15

NOTE: All linear dimensions are in millimeters

DPU (R-PWSON-N14)

PLASTIC SMALL OUTLINE NO-LEAD

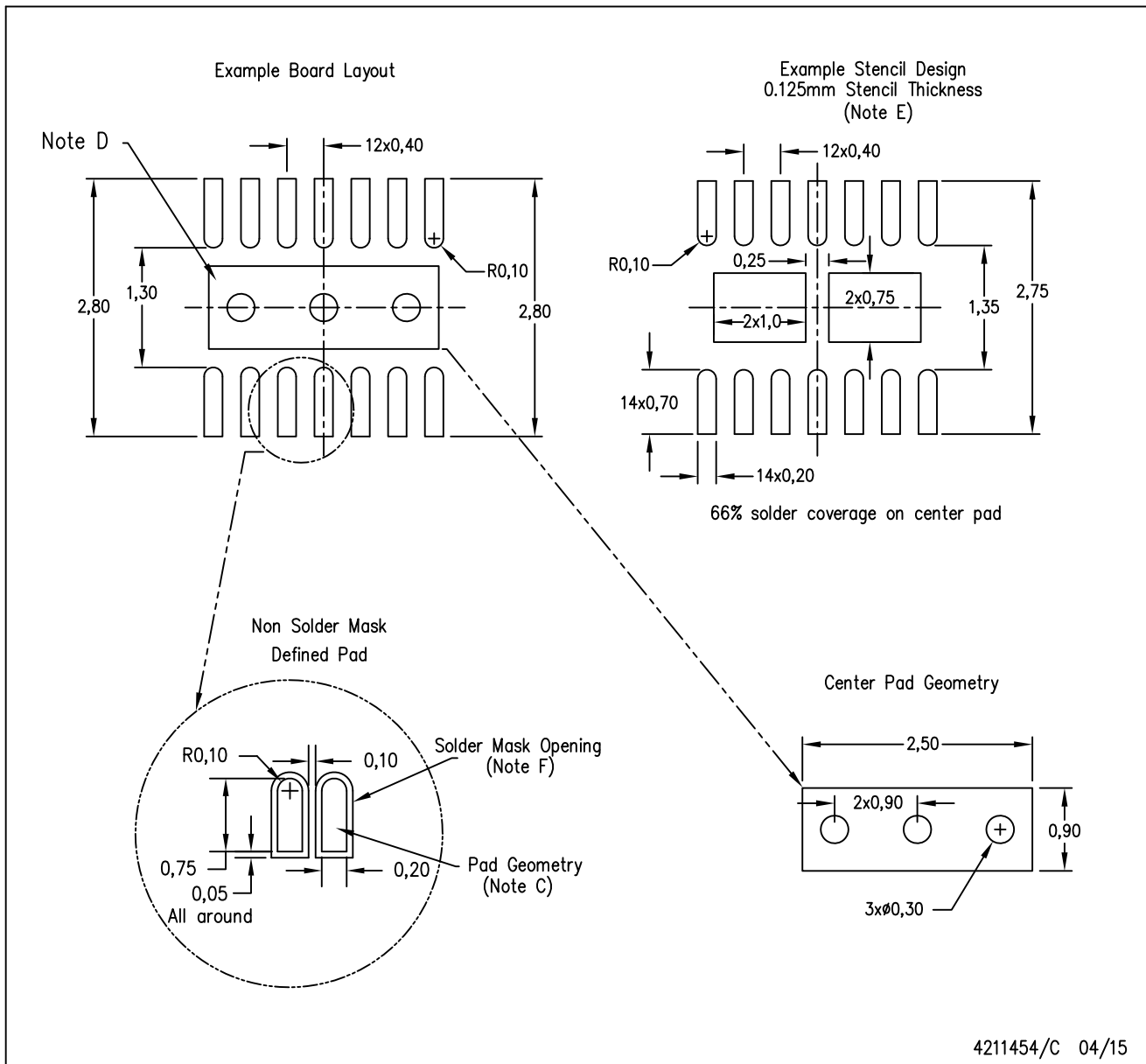

- NOTES:
- All linear dimensions are in millimeters.
 - This drawing is subject to change without notice.
 - Publication IPC-7351 is recommended for alternate designs.
 - This package is designed to be soldered to a thermal pad on the board. Refer to Application Note, QFN/SON PCB Attachment, Texas Instruments Literature No. SLUA271, and also the Product Data Sheets for specific thermal information, via requirements, and recommended board layout. These documents are available at www.ti.com <<http://www.ti.com>>.
 - Laser cutting apertures with trapezoidal walls and also rounding corners will offer better paste release. Customers should contact their board assembly site for stencil design recommendations. Refer to IPC 7525 for stencil design considerations.
 - Customers should contact their board fabrication site for minimum solder mask web tolerances between signal pads.

重要声明和免责声明

TI“按原样”提供技术和可靠性数据（包括数据表）、设计资源（包括参考设计）、应用或其他设计建议、网络工具、安全信息和其他资源，不保证没有瑕疵且不做任何明示或暗示的担保，包括但不限于对适销性、某特定用途方面的适用性或不侵犯任何第三方知识产权的暗示担保。

这些资源可供使用 TI 产品进行设计的熟练开发人员使用。您将自行承担以下全部责任：(1) 针对您的应用选择合适的 TI 产品，(2) 设计、验证并测试您的应用，(3) 确保您的应用满足相应标准以及任何其他功能安全、信息安全、监管或其他要求。

这些资源如有变更，恕不另行通知。TI 授权您仅可将这些资源用于研发本资源所述的 TI 产品的应用。严禁对这些资源进行其他复制或展示。您无权使用任何其他 TI 知识产权或任何第三方知识产权。您应全额赔偿因在这些资源的使用中对 TI 及其代表造成的任何索赔、损害、成本、损失和债务，TI 对此概不负责。

TI 提供的产品受 [TI 的销售条款](#) 或 [ti.com](#) 上其他适用条款/TI 产品随附的其他适用条款的约束。TI 提供这些资源并不会扩展或以其他方式更改 TI 针对 TI 产品发布的适用的担保或担保免责声明。

TI 反对并拒绝您可能提出的任何其他或不同的条款。

邮寄地址：Texas Instruments, Post Office Box 655303, Dallas, Texas 75265

Copyright © 2024，德州仪器 (TI) 公司