

## TPS22976 5.7V、6A、14mΩ 导通电阻双通道负载开关

### 1 特性

- 集成双通道负载开关
- 输入电压范围：0.6V 至  $V_{BIAS}$
- $V_{BIAS}$  电压范围：2.5 V 至 5.7 V
- 导通电阻
  - $R_{ON} = 14m\Omega$   
( $V_{IN} = 0.6V$  至  $5V$ ,  $V_{BIAS} = 5V$  时的典型值)
  - $R_{ON} = 18m\Omega$   
( $V_{IN} = 0.6V$  至  $2.5V$ ,  $V_{BIAS} = 2.5V$  时的典型值)
- 每通道最大 6A 连续开关电流
- TPS22976、TPS22976N 的静态电流
  - 37 $\mu$ A  
( $V_{IN} = V_{BIAS} = 5V$  时双通道的典型值)
  - 35 $\mu$ A  
( $V_{IN} = V_{BIAS} = 5V$  时单通道的典型值)
- TPS22976A 的静态电流
  - 85 $\mu$ A  
( $V_{IN} = V_{BIAS} = 5V$  时双通道的典型值)
  - 83 $\mu$ A  
( $V_{IN} = V_{BIAS} = 5V$  时单通道的典型值)
- 控制输入阈值，支持使用 1.2V、1.8V、2.5V 和 3.3V 逻辑器件
- 可配置上升时间
- 快速开通时间 (TPS22976A)
  - $V_{IN} = 1.05V$  时,  $t_{ON} = 17\mu s$
- 热关断
- 快速输出放电 (QOD) (可选)
- 带有散热垫的 SON 14 引脚封装
- ESD 性能测试符合 JESD 22 标准
  - 2kV 人体放电模式 (HBM) 和 1kV 器件充电模型 (CDM)

### 2 应用

- [PC 和笔记本电脑](#)
- [机顶盒和住宅网关](#)
- [电信系统](#)
- [固态硬盘 \(SSD\)](#)

### 3 说明

TPS22976 产品系列包含三款器件：TPS22976、TPS22976A 和 TPS22976N。每款器件都是一个接通受控的双通道负载开关。此器件包含两个可在 0.6V 至 5.7V 输入电压范围内运行的 N 沟道 MOSFET，并且每通道可支持最大 6A 的持续电流。每个开关可由一个导通/关断输入 (ON1 和 ON2) 独立控制，此输入可与低压控制信号直接连接。TPS22976 能够在结温超出阈值时热关断，以此关断开关。开关会在结温稳定在安全范围内时再次导通。此外，TPS22976 还包含一个可选 230 $\Omega$  片上负载电阻，用于在此开关被关断时进行快速输出放电。

TPS22976 采用小型、节省空间的 3mm × 2mm 14-SON (DPU) 封装，此类封装集成有散热焊盘，支持较高功耗。器件在自然通风环境下的额定运行温度范围为 -40°C 至 105°C。

#### 器件信息<sup>(1)</sup>

器件型号	封装	封装尺寸 (标称值)
TPS22976 TPS22976A TPS22976N	WSON (14)	3.00mm × 2.00mm

(1) 如需了解所有可用封装，请参阅数据表末尾的可订购产品附录。

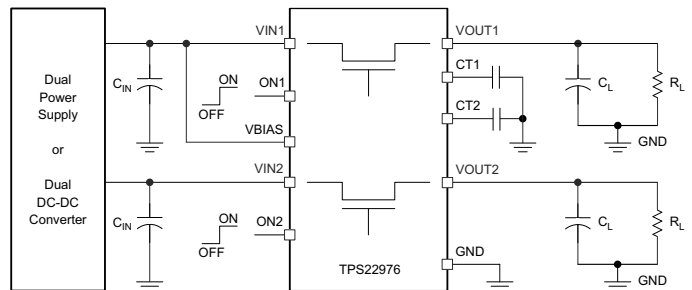

Copyright © 2016, Texas Instruments Incorporated

#### 应用电路



## Table of Contents

<b>1 特性</b> .....	<b>1</b>	8.1 Overview.....	<b>22</b>
<b>2 应用</b> .....	<b>1</b>	8.2 Functional Block Diagram.....	<b>23</b>
<b>3 说明</b> .....	<b>1</b>	8.3 Feature Description.....	<b>23</b>
<b>4 Device Comparison Table</b> .....	<b>3</b>	8.4 Device Functional Modes.....	<b>24</b>
<b>5 Pin Configuration and Functions</b> .....	<b>3</b>	<b>9 Application and Implementation</b> .....	<b>25</b>
Pin Functions.....	<b>3</b>	9.1 Application Information.....	<b>25</b>
<b>6 Specifications</b> .....	<b>5</b>	9.2 Typical Application.....	<b>27</b>
6.1 Absolute Maximum Ratings.....	<b>5</b>	9.3 Power Supply Recommendations.....	<b>30</b>
6.2 ESD Ratings.....	<b>5</b>	9.4 Layout.....	<b>30</b>
6.3 Recommended Operating Conditions.....	<b>5</b>	<b>10 Device and Documentation Support</b> .....	<b>31</b>
6.4 Thermal Information.....	<b>5</b>	10.1 Device Support.....	<b>31</b>
6.5 Electrical Characteristics (VBIAS = 5V).....	<b>6</b>	10.2 Documentation Support.....	<b>31</b>
6.6 Electrical Characteristics (VBIAS = 2.5V).....	<b>8</b>	10.3 接收文档更新通知.....	<b>31</b>
6.7 Switching Characteristics (TPS22976).....	<b>10</b>	10.4 支持资源.....	<b>31</b>
6.8 Switching Characteristics (TPS22976A).....	<b>11</b>	10.5 Trademarks.....	<b>31</b>
6.9 Switching Characteristics (TPS22976N).....	<b>11</b>	10.6 静电放电警告.....	<b>31</b>
6.10 Typical DC Characteristics.....	<b>13</b>	10.7 术语表.....	<b>31</b>
6.11 Typical AC Characteristics.....	<b>16</b>	<b>11 Revision History</b> .....	<b>31</b>
<b>7 Parameter Measurement Information</b> .....	<b>21</b>	<b>12 Mechanical, Packaging, and Orderable Information</b> .....	<b>32</b>
<b>8 Detailed Description</b> .....	<b>22</b>		

## 4 Device Comparison Table

DEVICE	$R_{ON}$ AT $V_{IN} = V_{BIAS} = 5\text{ V}$ (TYPICAL)	QUICK OUTPUT DISCHARGE	MAXIMUM OUTPUT CURRENT	TURN ON TIME $<65\mu\text{s}$ AT $V_{IN} = 1.05\text{ V}$
TPS22976	16 m $\Omega$	Yes	6 A	No
TPS22976A	14 m $\Omega$	Yes	6 A	Yes
TPS22976N	14 m $\Omega$	No	6 A	No

## 5 Pin Configuration and Functions



图 5-1. DPU Package 14-Pin WSON with Exposed Thermal Pad Top View



图 5-2. DPU Package 14-Pin WSON with Exposed Thermal Pad Bottom View

## Pin Functions

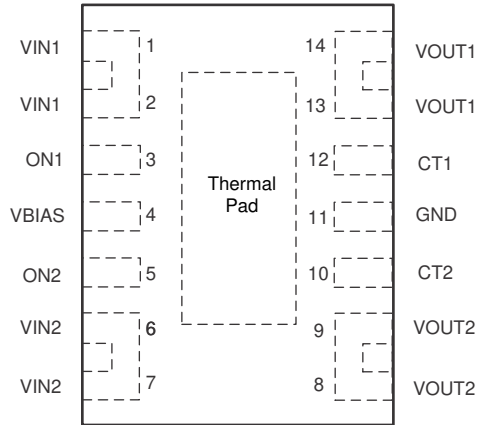
PIN		I/O	DESCRIPTION
NO.	NAME		
1	VIN1	I	Switch 1 input. Recommended voltage range for these pins for optimal $R_{ON}$ performance is 0.6 V to $V_{BIAS}$ . Place an optional decoupling capacitor between these pins and GND to reduce $V_{IN1}$ dip during turnon of the channel. See the <a href="#">Application Information</a> section for more information.
2			
3	ON1	I	Active-high switch 1 control input. Do not leave floating.
4	VBIAS	I	Bias voltage. Power supply to the device. Recommended voltage range for this pin is 2.5 V to 5.7 V. See the <a href="#">Application Information</a> section.
5	ON2	I	Active-high switch 2 control input. Do not leave floating.
6	VIN2	I	Switch 2 input. Recommended voltage range for these pins for optimal $R_{ON}$ performance is 0.6 V to $V_{BIAS}$ . Place an optional decoupling capacitor between these pins and GND to reduce $V_{IN2}$ dip during turn-on of the channel. See the <a href="#">Application Information</a> section for more information.
7			
8	VOUT2	O	Switch 2 output.
9			
10	CT2	O	Switch 2 slew rate control. Can be left floating. Capacitor used on this pin must be rated for a minimum of 25 V for desired rise time performance.
11	GND	—	Ground.
12	CT1	O	Switch 1 slew rate control. Can be left floating. Capacitor used on this pin must be rated for a minimum of 25 V for desired rise time performance.
13	VOUT1	O	Switch 1 output.
14			

PIN		I/O	DESCRIPTION
NO.	NAME		
—	Thermal pad	—	Thermal pad (exposed center pad) to alleviate thermal stress. Tie to GND. See the <a href="#">Layout</a> section for layout guidelines.

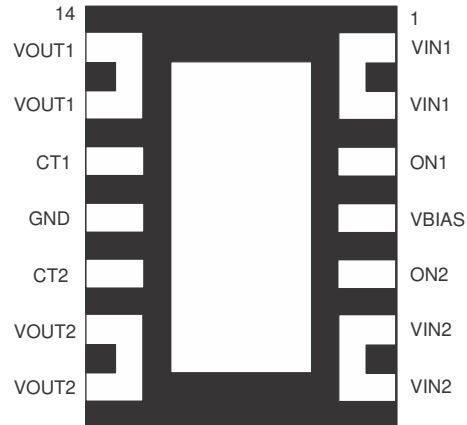
## 6 Specifications

### 6.1 Absolute Maximum Ratings

over operating free-air temperature range (unless otherwise noted)<sup>(1)</sup>

		MIN	MAX	UNIT
V <sub>IN1,2</sub>	Input Voltage	- 0.3	6	V
V <sub>OUT1,2</sub>	Output Voltage	- 0.3	6	V
V <sub>ON1,2</sub>	ON Pin Voltage	- 0.3	6	V
V <sub>BIAS</sub>	Bias Voltage	- 0.3	6	V
I <sub>MAX</sub>	Maximum continuous current per channel		6	A
I <sub>MAX,PLS</sub>	Maximum pulsed current switch per channel, pulse <300µs, 3% duty cycle		8	A
T <sub>J</sub>	Junction temperature		125	°C
T <sub>stg</sub>	Storage temperature	- 65	150	°C

- (1) Stresses beyond those listed under *Absolute Maximum Rating* may cause permanent damage to the device. These are stress ratings only, which do not imply functional operation of the device at these or any other conditions beyond those indicated under *Recommended Operating Condition*. Exposure to absolute-maximum-rated conditions for extended periods may affect device reliability.

### 6.2 ESD Ratings

			VALUE	UNIT
V <sub>(ESD)</sub>	Electrostatic discharge	Human body model (HBM), per ANSI/ESDA/ JEDEC JS-001, all pins <sup>(1)</sup>	±2000	V
		Charged device model (CDM), per JEDEC specification JESD22-C101, all pins <sup>(2)</sup>	±1000	

- (1) JEDEC document JEP155 states that 500-V HBM allows safe manufacturing with a standard ESD control process.  
 (2) JEDEC document JEP157 states that 250-V CDM allows safe manufacturing with a standard ESD control process.

### 6.3 Recommended Operating Conditions

over operating free-air temperature range (unless otherwise noted)

		MIN	NOM	MAX	UNIT
V <sub>IN1,2</sub>	Input Voltage	0.6		V <sub>BIAS</sub>	V
V <sub>BIAS</sub>	Bias Voltage	2.5		5.7	V
V <sub>ON1,2</sub>	ON Pin Voltage	0		5.7	V
V <sub>OUT1,2</sub>	Output Voltage	0		V <sub>IN</sub>	V
V <sub>IH</sub>	High-Level Input Voltage, ON	1.2		5.7	V
V <sub>IL</sub>	Low-Level Input Voltage, ON	0		0.5	V
T <sub>A</sub>	Ambient Temperature	- 40		105	°C

### 6.4 Thermal Information

THERMAL METRIC <sup>(1)</sup>		TPS22976	UNIT
		DPU (WSON)	
		14 PINS	
R <sub>θJA</sub>	Junction-to-ambient thermal resistance	50.8	°C/W
R <sub>θJC(top)</sub>	Junction-to-case (top) thermal resistance	52.3	°C/W
R <sub>θJB</sub>	Junction-to-board thermal resistance	18.4	°C/W
Ψ <sub>JT</sub>	Junction-to-top characterization parameter	1.6	°C/W

## 6.4 Thermal Information (续)

THERMAL METRIC <sup>(1)</sup>		TPS22976	
		DPU (WSON)	
		14 PINS	
			UNIT
$\Psi_{JB}$	Junction-to-board characterization parameter	18.6	°C/W
$R_{\theta JC(bot)}$	Junction-to-case (bottom) thermal resistance	6.5	°C/W

(1) For more information about traditional and new thermal metrics, see the [Semiconductor and IC Package Thermal Metrics](#) application report.

## 6.5 Electrical Characteristics (VBIAS = 5V)

over operating free-air temperature range (unless otherwise noted)

PARAMETER		TEST CONDITIONS	$T_A$	MIN	TYP	MAX	UNIT
<b>Power Supplies and Currents</b>							
$I_{Q,VBIAS}$	$V_{BIAS}$ Quiescent Current (TPS22976, both channels)	$I_{OUT1} = I_{OUT2} = 0mA, V_{IN1,2} = V_{ON1,2} = 5V$	-40°C to 85°C	37	49		$\mu A$
			-40°C to 105°C		49		$\mu A$
	$V_{BIAS}$ Quiescent Current (TPS22976, single-channel)	$I_{OUT1} = I_{OUT2} = 0mA, V_{ON2} = 0V, V_{IN1,2} = V_{IN1} = 5V$	-40°C to 85°C	35	43		$\mu A$
			-40°C to 105°C		44		$\mu A$
$I_{Q,VBIAS}$	$V_{BIAS}$ Quiescent Current (TPS22976A, both channels)	$I_{OUT1} = I_{OUT2} = 0mA, V_{IN1,2} = V_{ON1,2} = 5V$	-40°C to 85°C	85	106		$\mu A$
			-40°C to 105°C		106		$\mu A$
	$V_{BIAS}$ Quiescent Current (TPS22976A, single-channel)	$I_{OUT1} = I_{OUT2} = 0mA, V_{ON2} = 0V, V_{IN1,2} = V_{IN1} = 5V$	-40°C to 85°C	83	102		$\mu A$
			-40°C to 105°C		102		$\mu A$
$I_{Q,VBIAS}$	$V_{BIAS}$ Quiescent Current (TPS22976N, both channels)	$I_{OUT1} = I_{OUT2} = 0mA, V_{IN1,2} = V_{ON1,2} = 5V$	-40°C to 85°C	37	48		$\mu A$
			-40°C to 105°C		49		$\mu A$
	$V_{BIAS}$ Quiescent Current (TPS22976N, single-channel)	$I_{OUT1} = I_{OUT2} = 0mA, V_{ON2} = 0V, V_{IN1,2} = V_{IN1} = 5V$	-40°C to 85°C	35	43		$\mu A$
			-40°C to 105°C		44		$\mu A$
$I_{SD,VBIAS}$	$V_{BIAS}$ Shutdown Current	$V_{ON1,2} = 0V, V_{OUT1,2} = 0V$	-40°C to 105°C	1.37	2.3		$\mu A$
$I_{SD,VIN}$	$V_{IN}$ Shutdown Current (per channel)	$V_{ON} = 0V, V_{OUT} = 0V$	$V_{IN} = 5V$	-40°C to 85°C	0.005	5.5	$\mu A$
				-40°C to 105°C		11.3	$\mu A$
			$V_{IN} = 3.3V$	-40°C to 85°C	0.002	1.4	$\mu A$
				-40°C to 105°C		3.4	$\mu A$
			$V_{IN} = 1.8V$	-40°C to 85°C	0.002	0.5	$\mu A$
				-40°C to 105°C		1.4	$\mu A$
			$V_{IN} = 0.6V$	-40°C to 85°C	0.001	0.3	$\mu A$
				-40°C to 105°C		0.8	$\mu A$
$I_{ON}$	ON Pin Leakage Current	$V_{ON} = 5.5V$	-40°C to 105°C		0.1	$\mu A$	

## 6.5 Electrical Characteristics (VBIAS = 5V) (续)

over operating free-air temperature range (unless otherwise noted)

PARAMETER		TEST CONDITIONS		T <sub>A</sub>	MIN	TYP	MAX	UNIT				
R <sub>ON</sub>	On-Resistance (TPS22976)	I <sub>OUT</sub> = -200mA	V <sub>IN</sub> = 5V	25°C	16	18		mΩ				
				-40°C to 85°C			22	mΩ				
				-40°C to 105°C			23	mΩ				
				V <sub>IN</sub> = 3.3V	25°C	16	18		mΩ			
					-40°C to 85°C			22	mΩ			
					-40°C to 105°C			23	mΩ			
				V <sub>IN</sub> = 1.8V	25°C	16	18		mΩ			
					-40°C to 85°C			22	mΩ			
					-40°C to 105°C			23	mΩ			
			V <sub>IN</sub> = 1.2V	25°C	16	18		mΩ				
				-40°C to 85°C			22	mΩ				
				-40°C to 105°C			23	mΩ				
			V <sub>IN</sub> = 1.05V	25°C	16	18		mΩ				
				-40°C to 85°C			22	mΩ				
				-40°C to 105°C			23	mΩ				
			V <sub>IN</sub> = 0.6V	25°C	14	18		mΩ				
				-40°C to 85°C			22	mΩ				
				-40°C to 105°C			23	mΩ				
			<b>Resistance Characteristics</b>									
			R <sub>ON</sub>	On-Resistance (TPS22976A, TPS22976N)	I <sub>OUT</sub> = -200mA	V <sub>IN</sub> = 5V	25°C	14	18		mΩ	
							-40°C to 85°C			22	mΩ	
							-40°C to 105°C			23	mΩ	
							V <sub>IN</sub> = 3.3V	25°C	14	18		mΩ
								-40°C to 85°C			22	mΩ
-40°C to 105°C								23	mΩ			
V <sub>IN</sub> = 1.8V	25°C	14					18		mΩ			
	-40°C to 85°C							22	mΩ			
	-40°C to 105°C							23	mΩ			
V <sub>IN</sub> = 1.2V	25°C	14				18		mΩ				
	-40°C to 85°C						22	mΩ				
	-40°C to 105°C						23	mΩ				
V <sub>IN</sub> = 1.05V	25°C	14				18		mΩ				
	-40°C to 85°C						22	mΩ				
	-40°C to 105°C						23	mΩ				
V <sub>IN</sub> = 0.6V	25°C	14				18		mΩ				
	-40°C to 85°C						22	mΩ				
	-40°C to 105°C						23	mΩ				
V <sub>ON,HYS</sub>	ON Pin Hysteresis	V <sub>IN</sub> = 5V				25°C		90		mV		
R <sub>PD</sub>	Output Pulldown Resistance	V <sub>IN</sub> = V <sub>OUT</sub> = 5V, V <sub>ON</sub> = 0V				-40°C to 105°C		230	280	Ω		
T <sub>SD</sub>	Thermal Shutdown	Junction Temperature Rising				-		160		°C		

## 6.5 Electrical Characteristics (VBIAS = 5V) (续)

over operating free-air temperature range (unless otherwise noted)

PARAMETER		TEST CONDITIONS	T <sub>A</sub>	MIN	TYP	MAX	UNIT
T <sub>SD,HYS</sub>	Thermal Shutdown Hysteresis	Junction Temperature Falling	-		20		°C

## 6.6 Electrical Characteristics (VBIAS = 2.5V)

over operating free-air temperature range (unless otherwise noted)

PARAMETER		TEST CONDITIONS	T <sub>A</sub>	MIN	TYP	MAX	UNIT	
<b>Power Supplies and Currents</b>								
I <sub>Q,VBIAS</sub>	V <sub>BIAS</sub> Quiescent Current (TPS22976, TPS22976N, both channels)	I <sub>OUT1</sub> = I <sub>OUT2</sub> = 0mA, V <sub>IN1,2</sub> = V <sub>ON1,2</sub> = 2.5V	-40°C to 85°C		15	20	μA	
			-40°C to 105°C			20	μA	
	V <sub>BIAS</sub> Quiescent Current (TPS22976, TPS22976N, single-channel)	I <sub>OUT1</sub> = I <sub>OUT2</sub> = 0mA, V <sub>ON2</sub> = 0V, V <sub>IN1,2</sub> = V <sub>IN1</sub> = 2.5V	-40°C to 85°C		14	19	μA	
			-40°C to 105°C			19	μA	
I <sub>Q,VBIAS</sub>	V <sub>BIAS</sub> Quiescent Current (TPS22976A, both channels)	I <sub>OUT1</sub> = I <sub>OUT2</sub> = 0mA, V <sub>IN1,2</sub> = V <sub>ON1,2</sub> = 2.5V	-40°C to 85°C		26	37	μA	
			-40°C to 105°C			37	μA	
	V <sub>BIAS</sub> Quiescent Current (TPS22976A, single-channel)	I <sub>OUT1</sub> = I <sub>OUT2</sub> = 0mA, V <sub>ON2</sub> = 0V, V <sub>IN1,2</sub> = V <sub>IN1</sub> = 2.5V	-40°C to 85°C		25	36	μA	
			-40°C to 105°C			36	μA	
I <sub>SD,VBIAS</sub>	V <sub>BIAS</sub> Shutdown Current	V <sub>ON1,2</sub> = 0V, V <sub>OUT1,2</sub> = 0V	-40°C to 105°C		0.58	1.1	μA	
I <sub>SD,VIN</sub>	V <sub>IN</sub> Shutdown Current (per channel)	V <sub>ON</sub> = 0V, V <sub>OUT</sub> = 0V	V <sub>IN</sub> = 2.5V	-40°C to 85°C		0.005	0.8	μA
				-40°C to 105°C			2.1	μA
			V <sub>IN</sub> = 1.8V	-40°C to 85°C		0.002	0.5	μA
				-40°C to 105°C			1.4	μA
			V <sub>IN</sub> = 1.05V	-40°C to 85°C		0.002	0.3	μA
				-40°C to 105°C			1	μA
			V <sub>IN</sub> = 0.6V	-40°C to 85°C		0.001	0.3	μA
				-40°C to 105°C			0.8	μA
I <sub>ON</sub>	ON Pin Leakage Current	V <sub>ON</sub> = 5.5V	-40°C to 105°C			0.1	μA	



## 6.6 Electrical Characteristics (VBIAS = 2.5V) (续)

over operating free-air temperature range (unless otherwise noted)

PARAMETER		TEST CONDITIONS		T <sub>A</sub>	MIN	TYP	MAX	UNIT				
R <sub>ON</sub>	On-Resistance (TPS22976)	I <sub>OUT</sub> = -200mA	V <sub>IN</sub> = 2.5V	25°C	18	23		mΩ				
				-40°C to 85°C			28		mΩ			
				-40°C to 105°C			30		mΩ			
				V <sub>IN</sub> = 1.8V	25°C	16	23		mΩ			
					-40°C to 85°C			28		mΩ		
					-40°C to 105°C			29		mΩ		
				V <sub>IN</sub> = 1.5V	25°C	16	22		mΩ			
					-40°C to 85°C			27		mΩ		
					-40°C to 105°C			28		mΩ		
			V <sub>IN</sub> = 1.2V	25°C	16	21		mΩ				
				-40°C to 85°C			26		mΩ			
				-40°C to 105°C			28		mΩ			
			V <sub>IN</sub> = 1.05V	25°C	16	21		mΩ				
				-40°C to 85°C			25		mΩ			
				-40°C to 105°C			27		mΩ			
			V <sub>IN</sub> = 0.6V	25°C	16	20		mΩ				
				-40°C to 85°C			25		mΩ			
				-40°C to 105°C			26		mΩ			
			<b>Resistance Characteristics</b>									
			R <sub>ON</sub>	On-Resistance (TPS22976A, TPS22976N)	I <sub>OUT</sub> = -200mA	V <sub>IN</sub> = 2.5V	25°C	18	23		mΩ	
							-40°C to 85°C			28		mΩ
							-40°C to 105°C			30		mΩ
							V <sub>IN</sub> = 1.8V	25°C	16	23		mΩ
								-40°C to 85°C			28	
-40°C to 105°C								29		mΩ		
V <sub>IN</sub> = 1.5V	25°C	16					22		mΩ			
	-40°C to 85°C							27		mΩ		
	-40°C to 105°C							28		mΩ		
V <sub>IN</sub> = 1.2V	25°C	16				21		mΩ				
	-40°C to 85°C						26		mΩ			
	-40°C to 105°C						28		mΩ			
V <sub>IN</sub> = 1.05V	25°C	16				21		mΩ				
	-40°C to 85°C						25		mΩ			
	-40°C to 105°C						27		mΩ			
V <sub>IN</sub> = 0.6V	25°C	15				20		mΩ				
	-40°C to 85°C						25		mΩ			
	-40°C to 105°C						26		mΩ			
V <sub>ON,HYS</sub>	ON Pin Hysteresis	V <sub>IN</sub> = 2.5V				25°C	70			mV		
R <sub>PD</sub>	Output Pulldown Resistance	V <sub>IN</sub> = V <sub>OUT</sub> = 2.5V, V <sub>ON</sub> = 0V				-40°C to 105°C	250	330		Ω		
T <sub>SD</sub>	Thermal Shutdown	Junction Temperature Rising				-	160			°C		

## 6.6 Electrical Characteristics (VBIAS = 2.5V) (续)

over operating free-air temperature range (unless otherwise noted)

PARAMETER		TEST CONDITIONS	T <sub>A</sub>	MIN	TYP	MAX	UNIT
T <sub>SD,HYS</sub>	Thermal Shutdown Hysteresis	Junction Temperature Falling	-		20		°C

## 6.7 Switching Characteristics (TPS22976)

over operating free-air temperature range (unless otherwise noted)

PARAMETER		TEST CONDITIONS	MIN	TYP	MAX	UNIT
<b>VIN = VON = VBIAS = 5V, TA = 25°C</b>						
t <sub>ON</sub>	Turn ON Time	R <sub>L</sub> = 10 Ω, C <sub>L</sub> = 0.1uF, CT = 1000pF		2390		μs
t <sub>OFF</sub>	Turn OFF Time	R <sub>L</sub> = 10 Ω, C <sub>L</sub> = 0.1uF, CT = 1000pF		3		μs
t <sub>R</sub>	Rise Time	R <sub>L</sub> = 10 Ω, C <sub>L</sub> = 0.1uF, CT = 1000pF		1770		μs
t <sub>F</sub>	Fall Time	R <sub>L</sub> = 10 Ω, C <sub>L</sub> = 0.1uF, CT = 1000pF		2		μs
t <sub>D</sub>	Delay Time	R <sub>L</sub> = 10 Ω, C <sub>L</sub> = 0.1uF, CT = 1000pF		620		μs
<b>VIN = 0.6V, VON = VBIAS = 5V, TA = 25°C</b>						
t <sub>ON</sub>	Turn ON Time	R <sub>L</sub> = 10 Ω, C <sub>L</sub> = 0.1uF, CT = 1000pF		745		μs
t <sub>OFF</sub>	Turn OFF Time	R <sub>L</sub> = 10 Ω, C <sub>L</sub> = 0.1uF, CT = 1000pF		3		μs
t <sub>R</sub>	Rise Time	R <sub>L</sub> = 10 Ω, C <sub>L</sub> = 0.1uF, CT = 1000pF		285		μs
t <sub>F</sub>	Fall Time	R <sub>L</sub> = 10 Ω, C <sub>L</sub> = 0.1uF, CT = 1000pF		2		μs
t <sub>D</sub>	Delay Time	R <sub>L</sub> = 10 Ω, C <sub>L</sub> = 0.1uF, CT = 1000pF		460		μs
<b>VIN = 2.5V, VON = 5V, VBIAS = 2.5V, TA = 25°C</b>						
t <sub>ON</sub>	Turn ON Time	R <sub>L</sub> = 10 Ω, C <sub>L</sub> = 0.1uF, CT = 1000pF		3485		μs
t <sub>OFF</sub>	Turn OFF Time	R <sub>L</sub> = 10 Ω, C <sub>L</sub> = 0.1uF, CT = 1000pF		2		μs
t <sub>R</sub>	Rise Time	R <sub>L</sub> = 10 Ω, C <sub>L</sub> = 0.1uF, CT = 1000pF		2275		μs
t <sub>F</sub>	Fall Time	R <sub>L</sub> = 10 Ω, C <sub>L</sub> = 0.1uF, CT = 1000pF		2		μs
t <sub>D</sub>	Delay Time	R <sub>L</sub> = 10 Ω, C <sub>L</sub> = 0.1uF, CT = 1000pF		1210		μs
<b>VIN = 0.6V, VON = 5V, VBIAS = 2.5V, TA = 25°C</b>						
t <sub>ON</sub>	Turn ON Time	R <sub>L</sub> = 10 Ω, C <sub>L</sub> = 0.1uF, CT = 1000pF		1730		μs
t <sub>OFF</sub>	Turn OFF Time	R <sub>L</sub> = 10 Ω, C <sub>L</sub> = 0.1uF, CT = 1000pF		2		μs
t <sub>R</sub>	Rise Time	R <sub>L</sub> = 10 Ω, C <sub>L</sub> = 0.1uF, CT = 1000pF		700		μs
t <sub>F</sub>	Fall Time	R <sub>L</sub> = 10 Ω, C <sub>L</sub> = 0.1uF, CT = 1000pF		2		μs
t <sub>D</sub>	Delay Time	R <sub>L</sub> = 10 Ω, C <sub>L</sub> = 0.1uF, CT = 1000pF		1030		μs
<b>VIN = 1.05V, VON = VBIAS = 5V, TA = -40°C to 85°C</b>						

## 6.8 Switching Characteristics (TPS22976A)

over operating free-air temperature range (unless otherwise noted)

PARAMETER		TEST CONDITIONS	MIN	TYP	MAX	UNIT
<b>VIN = VON = VBIAS = 5V, TA = 25°C</b>						
t <sub>ON</sub>	Turn ON Time	R <sub>L</sub> = 10 Ω, C <sub>L</sub> = 0.1uF, CT = 1000pF		350		μs
t <sub>OFF</sub>	Turn OFF Time	R <sub>L</sub> = 10 Ω, C <sub>L</sub> = 0.1uF, CT = 1000pF		2		μs
t <sub>R</sub>	Rise Time	R <sub>L</sub> = 10 Ω, C <sub>L</sub> = 0.1uF, CT = 1000pF		263		μs
t <sub>F</sub>	Fall Time	R <sub>L</sub> = 10 Ω, C <sub>L</sub> = 0.1uF, CT = 1000pF		2		μs
t <sub>D</sub>	Delay Time	R <sub>L</sub> = 10 Ω, C <sub>L</sub> = 0.1uF, CT = 1000pF		86		μs
<b>VIN = 0.6V, VON = VBIAS = 5V, TA = 25°C</b>						
t <sub>ON</sub>	Turn ON Time	R <sub>L</sub> = 10 Ω, C <sub>L</sub> = 0.1uF, CT = 1000pF		100		μs
t <sub>OFF</sub>	Turn OFF Time	R <sub>L</sub> = 10 Ω, C <sub>L</sub> = 0.1uF, CT = 1000pF		2		μs
t <sub>R</sub>	Rise Time	R <sub>L</sub> = 10 Ω, C <sub>L</sub> = 0.1uF, CT = 1000pF		41		μs
t <sub>F</sub>	Fall Time	R <sub>L</sub> = 10 Ω, C <sub>L</sub> = 0.1uF, CT = 1000pF		2		μs
t <sub>D</sub>	Delay Time	R <sub>L</sub> = 10 Ω, C <sub>L</sub> = 0.1uF, CT = 1000pF		58		μs
<b>VIN = 2.5V, VON = 5V, VBIAS = 2.5V, TA = 25°C</b>						
t <sub>ON</sub>	Turn ON Time	R <sub>L</sub> = 10 Ω, C <sub>L</sub> = 0.1uF, CT = 1000pF		612		μs
t <sub>OFF</sub>	Turn OFF Time	R <sub>L</sub> = 10 Ω, C <sub>L</sub> = 0.1uF, CT = 1000pF		3		μs
t <sub>R</sub>	Rise Time	R <sub>L</sub> = 10 Ω, C <sub>L</sub> = 0.1uF, CT = 1000pF		392		μs
t <sub>F</sub>	Fall Time	R <sub>L</sub> = 10 Ω, C <sub>L</sub> = 0.1uF, CT = 1000pF		2		μs
t <sub>D</sub>	Delay Time	R <sub>L</sub> = 10 Ω, C <sub>L</sub> = 0.1uF, CT = 1000pF		221		μs
<b>VIN = 0.6V, VON = 5V, VBIAS = 2.5V, TA = 25°C</b>						
t <sub>ON</sub>	Turn ON Time	R <sub>L</sub> = 10 Ω, C <sub>L</sub> = 0.1uF, CT = 1000pF		301		μs
t <sub>OFF</sub>	Turn OFF Time	R <sub>L</sub> = 10 Ω, C <sub>L</sub> = 0.1uF, CT = 1000pF		3		μs
t <sub>R</sub>	Rise Time	R <sub>L</sub> = 10 Ω, C <sub>L</sub> = 0.1uF, CT = 1000pF		119		μs
t <sub>F</sub>	Fall Time	R <sub>L</sub> = 10 Ω, C <sub>L</sub> = 0.1uF, CT = 1000pF		2		μs
t <sub>D</sub>	Delay Time	R <sub>L</sub> = 10 Ω, C <sub>L</sub> = 0.1uF, CT = 1000pF		182		μs
<b>VIN = 1.05V, VON = VBIAS = 5V, TA = -40°C to 85°C</b>						
t <sub>ON</sub>	Turn ON Time	R <sub>L</sub> = 10 Ω, C <sub>L</sub> = 0.1uF, CT = 0pF		17	42	μs
t <sub>OFF</sub>	Turn OFF Time	R <sub>L</sub> = 10 Ω, C <sub>L</sub> = 0.1uF, CT = 0pF		2		μs
t <sub>R</sub>	Rise Time	R <sub>L</sub> = 10 Ω, C <sub>L</sub> = 0.1uF, CT = 0pF		6	25	μs
t <sub>F</sub>	Fall Time	R <sub>L</sub> = 10 Ω, C <sub>L</sub> = 0.1uF, CT = 0pF		2		μs
t <sub>D</sub>	Delay Time	R <sub>L</sub> = 10 Ω, C <sub>L</sub> = 0.1uF, CT = 0pF		11	25	μs

## 6.9 Switching Characteristics (TPS22976N)

over operating free-air temperature range (unless otherwise noted)

PARAMETER		TEST CONDITIONS	MIN	TYP	MAX	UNIT
<b>VIN = VON = VBIAS = 5V, TA = 25°C</b>						
t <sub>ON</sub>	Turn ON Time	R <sub>L</sub> = 10 Ω, C <sub>L</sub> = 0.1uF, CT = 1000pF		2390		μs
t <sub>OFF</sub>	Turn OFF Time	R <sub>L</sub> = 10 Ω, C <sub>L</sub> = 0.1uF, CT = 1000pF		3		μs
t <sub>R</sub>	Rise Time	R <sub>L</sub> = 10 Ω, C <sub>L</sub> = 0.1uF, CT = 1000pF		1770		μs
t <sub>F</sub>	Fall Time	R <sub>L</sub> = 10 Ω, C <sub>L</sub> = 0.1uF, CT = 1000pF		2		μs
t <sub>D</sub>	Delay Time	R <sub>L</sub> = 10 Ω, C <sub>L</sub> = 0.1uF, CT = 1000pF		620		μs
<b>VIN = 0.6V, VON = VBIAS = 5V, TA = 25°C</b>						
t <sub>ON</sub>	Turn ON Time	R <sub>L</sub> = 10 Ω, C <sub>L</sub> = 0.1uF, CT = 1000pF		745		μs

## 6.9 Switching Characteristics (TPS22976N) (续)

over operating free-air temperature range (unless otherwise noted)

PARAMETER		TEST CONDITIONS	MIN	TYP	MAX	UNIT
$t_{OFF}$	Turn OFF Time	$R_L = 10\ \Omega$ , $C_L = 0.1\ \mu\text{F}$ , $CT = 1000\text{pF}$		3		$\mu\text{s}$
$t_R$	Rise Time	$R_L = 10\ \Omega$ , $C_L = 0.1\ \mu\text{F}$ , $CT = 1000\text{pF}$		285		$\mu\text{s}$
$t_F$	Fall Time	$R_L = 10\ \Omega$ , $C_L = 0.1\ \mu\text{F}$ , $CT = 1000\text{pF}$		2		$\mu\text{s}$
$t_D$	Delay Time	$R_L = 10\ \Omega$ , $C_L = 0.1\ \mu\text{F}$ , $CT = 1000\text{pF}$		460		$\mu\text{s}$
<b>VIN = 2.5V, VON = 5V, VBIAS = 2.5V, TA = 25°C</b>						
$t_{ON}$	Turn ON Time	$R_L = 10\ \Omega$ , $C_L = 0.1\ \mu\text{F}$ , $CT = 1000\text{pF}$		3485		$\mu\text{s}$
$t_{OFF}$	Turn OFF Time	$R_L = 10\ \Omega$ , $C_L = 0.1\ \mu\text{F}$ , $CT = 1000\text{pF}$		4		$\mu\text{s}$
$t_R$	Rise Time	$R_L = 10\ \Omega$ , $C_L = 0.1\ \mu\text{F}$ , $CT = 1000\text{pF}$		2275		$\mu\text{s}$
$t_F$	Fall Time	$R_L = 10\ \Omega$ , $C_L = 0.1\ \mu\text{F}$ , $CT = 1000\text{pF}$		2		$\mu\text{s}$
$t_D$	Delay Time	$R_L = 10\ \Omega$ , $C_L = 0.1\ \mu\text{F}$ , $CT = 1000\text{pF}$		1210		$\mu\text{s}$
<b>VIN = 0.6V, VON = 5V, VBIAS = 2.5V, TA = 25°C</b>						
$t_{ON}$	Turn ON Time	$R_L = 10\ \Omega$ , $C_L = 0.1\ \mu\text{F}$ , $CT = 1000\text{pF}$		1730		$\mu\text{s}$
$t_{OFF}$	Turn OFF Time	$R_L = 10\ \Omega$ , $C_L = 0.1\ \mu\text{F}$ , $CT = 1000\text{pF}$		5		$\mu\text{s}$
$t_R$	Rise Time	$R_L = 10\ \Omega$ , $C_L = 0.1\ \mu\text{F}$ , $CT = 1000\text{pF}$		700		$\mu\text{s}$
$t_F$	Fall Time	$R_L = 10\ \Omega$ , $C_L = 0.1\ \mu\text{F}$ , $CT = 1000\text{pF}$		2		$\mu\text{s}$
$t_D$	Delay Time	$R_L = 10\ \Omega$ , $C_L = 0.1\ \mu\text{F}$ , $CT = 1000\text{pF}$		1030		$\mu\text{s}$
<b>VIN = 1.05V, VON = VBIAS = 5V, TA = -40°C to 85°C</b>						

## 6.10 Typical DC Characteristics

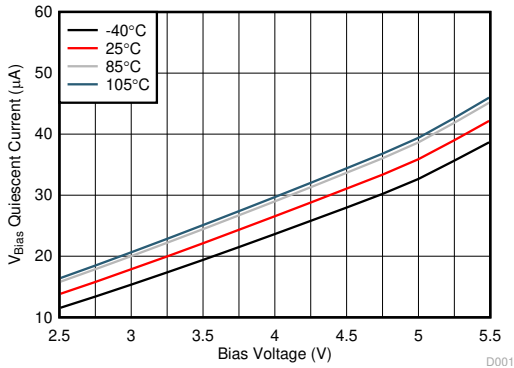

$$V_{IN1} = V_{IN2} = V_{BIAS} \quad V_{ON1} = V_{ON2} = 5 \text{ V} \quad V_{OUT} = \text{Open}$$

图 6-1.  $V_{BIAS}$  Quiescent Current vs Bias Voltage Both Channels (TPS22976, TPS22976N)

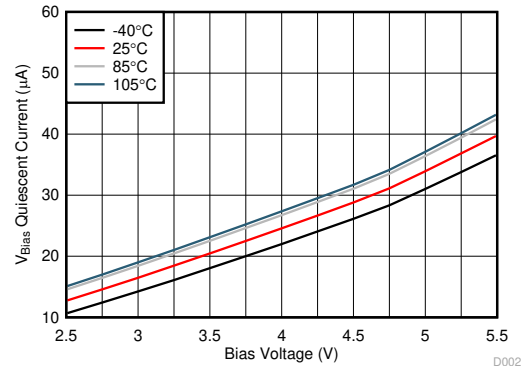

$$V_{IN1} = V_{BIAS} \quad V_{ON1} = 5 \text{ V} \quad V_{OUT} = \text{Open}$$

图 6-2.  $V_{BIAS}$  Quiescent Current vs Bias Voltage Single Channel (TPS22976, TPS22976N)

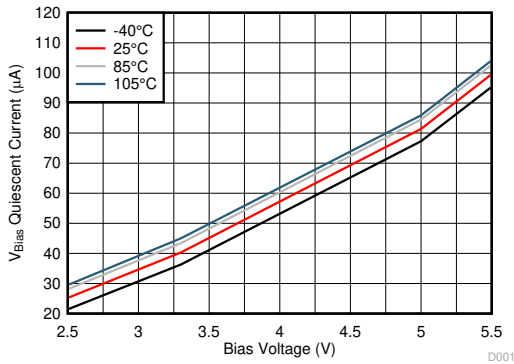

$$V_{IN1} = V_{IN2} = V_{BIAS} \quad V_{ON1} = V_{ON2} = 5 \text{ V} \quad V_{OUT} = \text{Open}$$

图 6-3.  $V_{BIAS}$  Quiescent Current vs Bias Voltage Both Channels (TPS22976A)

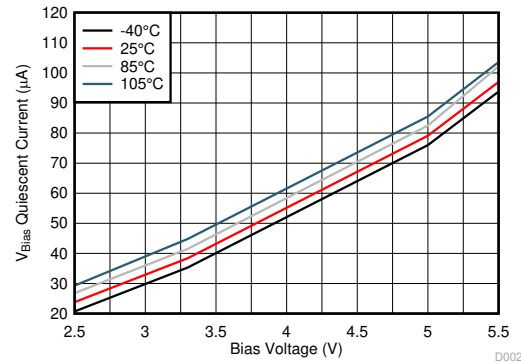

$$V_{IN1} = V_{BIAS} \quad V_{ON1} = 5 \text{ V} \quad V_{OUT} = \text{Open}$$

图 6-4.  $V_{BIAS}$  Quiescent Current vs Bias Voltage Single Channel (TPS22976A)

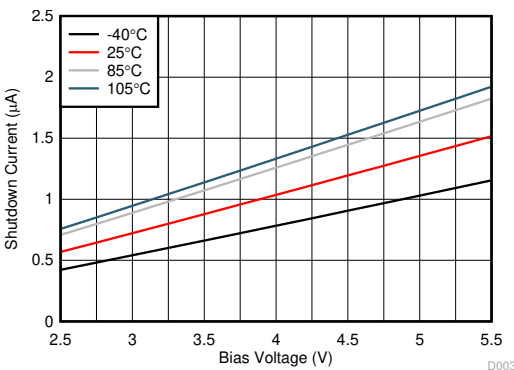

$$V_{IN1} = V_{IN2} = V_{BIAS} \quad V_{ON1} = V_{ON2} = 0 \text{ V} \quad V_{OUT} = 0 \text{ V}$$

图 6-5.  $V_{BIAS}$  Shutdown Current vs Bias Voltage Both Channels

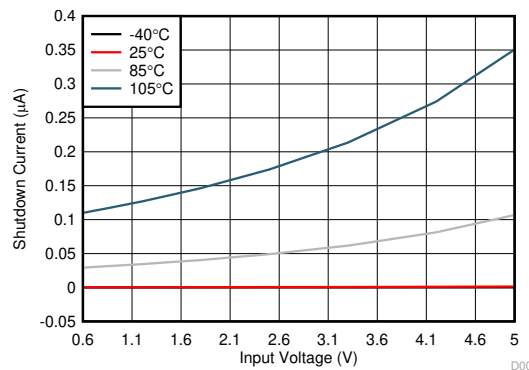

$$V_{BIAS} = 5 \text{ V} \quad V_{ON} = 0 \text{ V} \quad V_{OUT} = 0 \text{ V}$$

Note: -40°C and 25°C curves have similar values, therefore only one line is visible.

图 6-6. Off-State  $V_{IN}$  Current vs Input Voltage Single Channel

### 6.10 Typical DC Characteristics (continued)



图 6-7. On-Resistance vs Input Voltage Single Channel - Across Ambient Temperatures (TPS22976)



图 6-8. On-Resistance vs Input Voltage Single Channel - Across Ambient Temperatures (TPS22976)

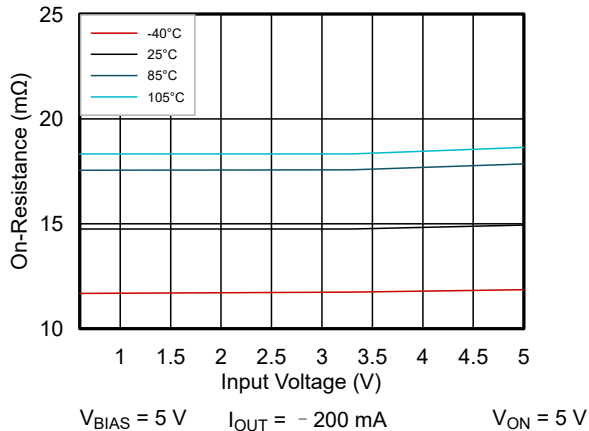

图 6-9. On-Resistance vs Ambient Temperature Single Channel (TPS22976)

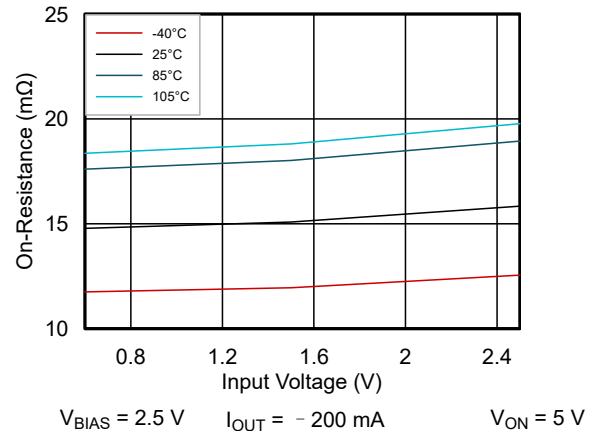

图 6-10. On-Resistance vs Ambient Temperature Single Channel (TPS22976)

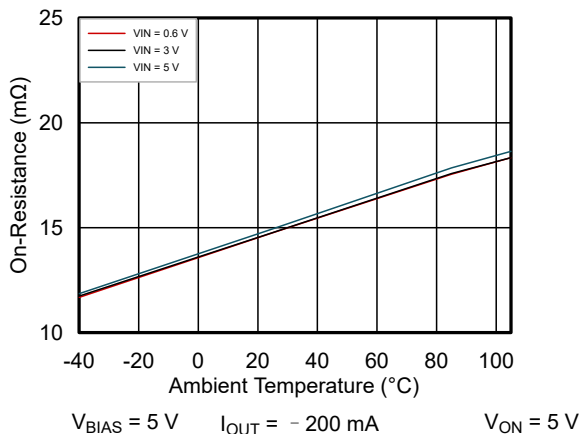

图 6-11. On-Resistance vs Ambient Temperature Single Channel (TPS22976A, TPS22976N)

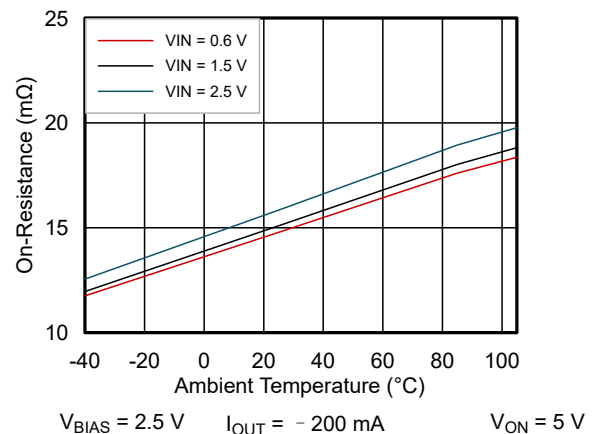

图 6-12. On-Resistance vs Ambient Temperature Single Channel (TPS22976A, TPS22976N)

### 6.10 Typical DC Characteristics (continued)

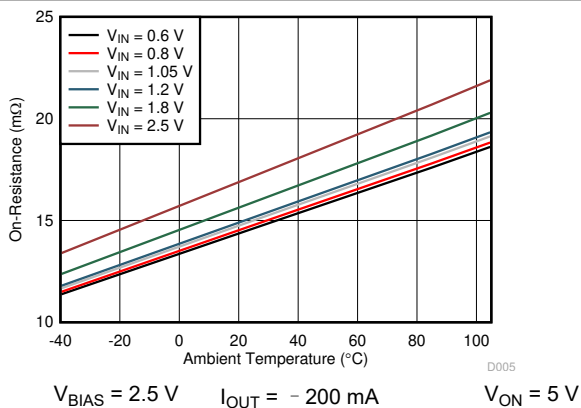

图 6-13. On-Resistance vs Input Voltage Single Channel - Across Ambient Temperatures (TPS22976A, TPS22976N)

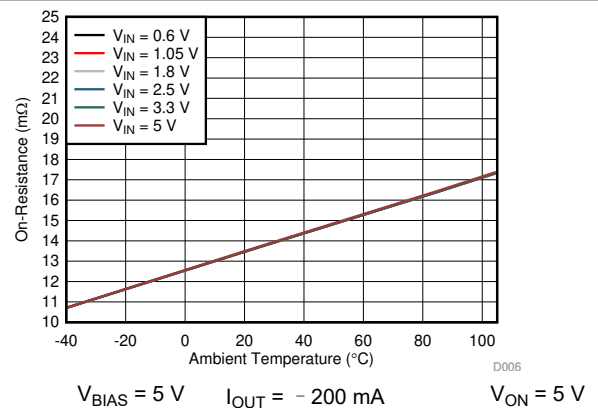

图 6-14. On-Resistance vs Input Voltage Single Channel - Across Ambient Temperatures (TPS22976A, TPS22976N)

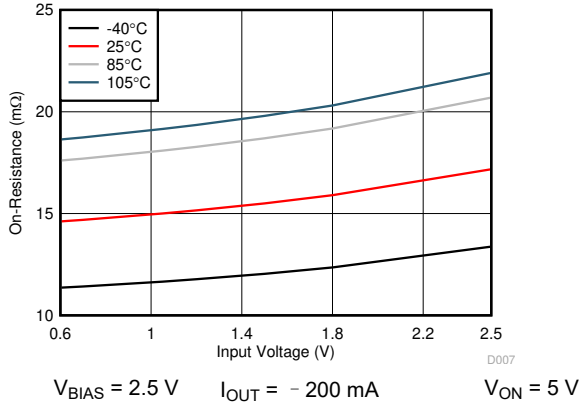

图 6-15. Pulldown Resistance vs Bias Voltage Single Channel

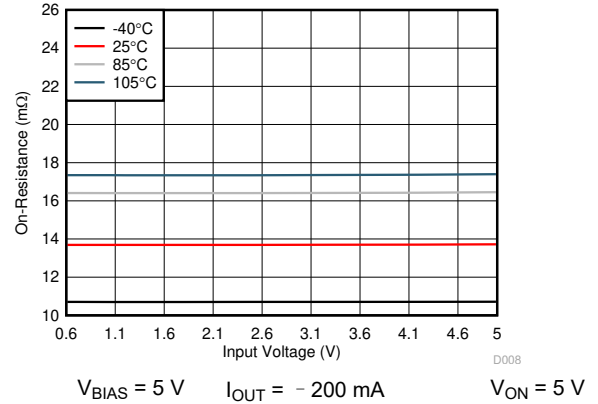

图 6-16. High-Level Input Voltage vs Bias Voltage

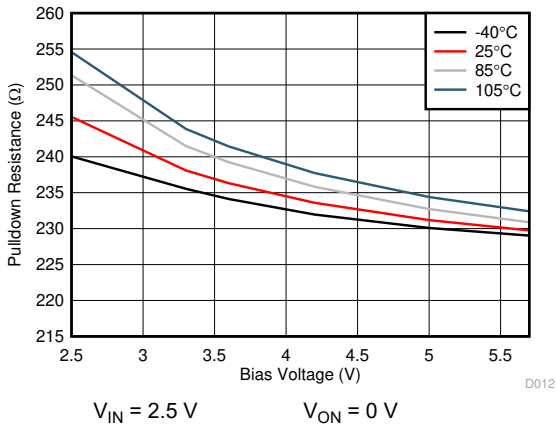

图 6-17. Low-Level Input Voltage vs Bias Voltage

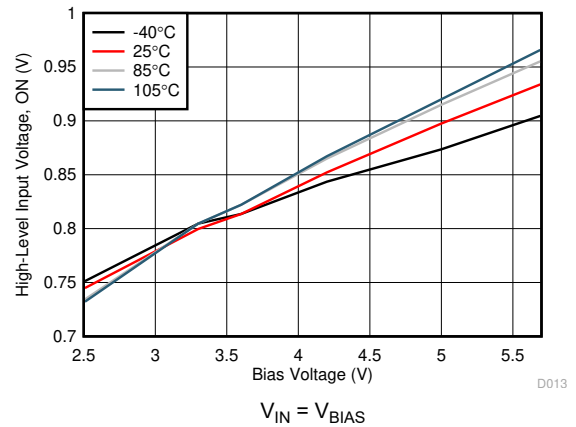

图 6-18. Voltage Input Hysteresis vs Bias Voltage

## 6.11 Typical AC Characteristics

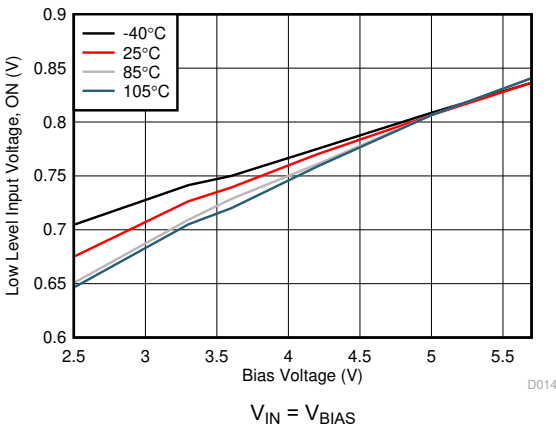
### AC Characteristics (TPS22976, TPS22976N)

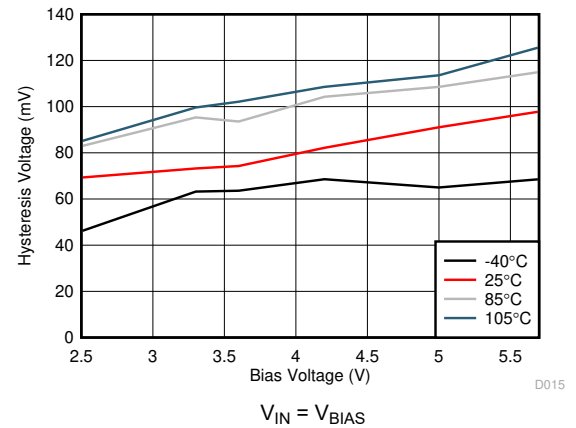

图 6-19. Delay Time vs Input Voltage



图 6-20. Delay Time vs Input Voltage

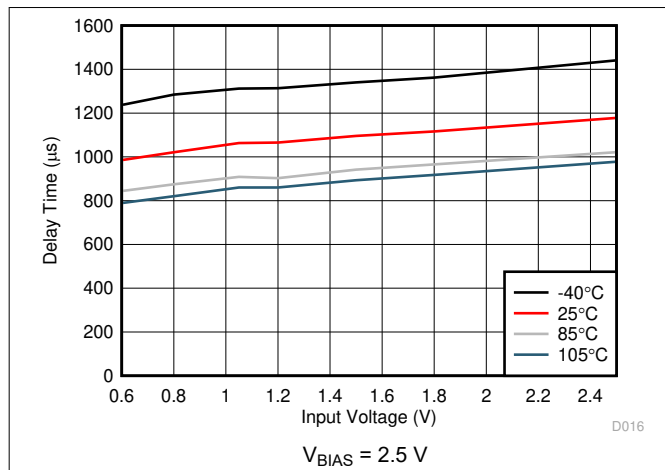

图 6-21. Fall Time vs Input Voltage

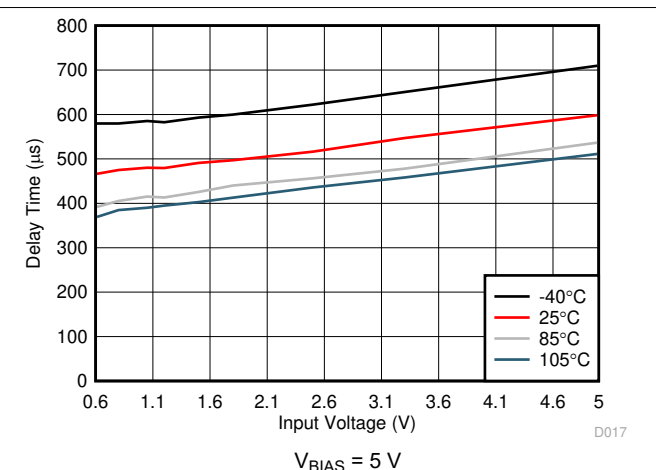

图 6-22. Fall Time vs Input Voltage

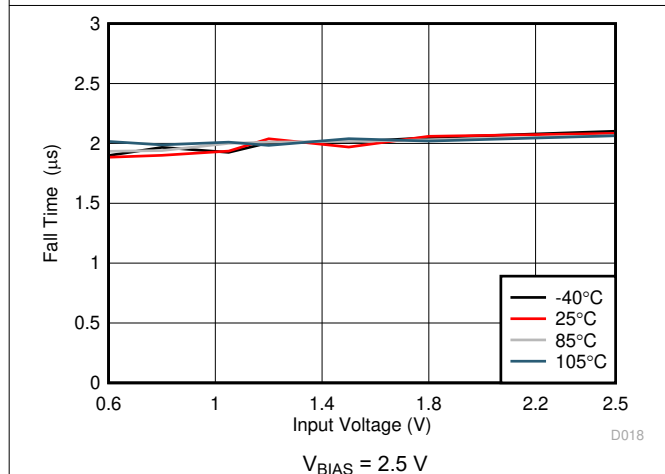

图 6-23. Turnoff Time vs Input Voltage (TPS22976)

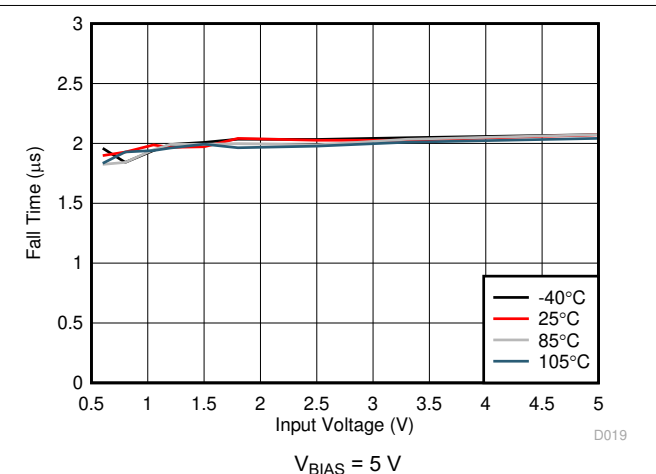

图 6-24. Turnoff Time vs Input Voltage (TPS22976)

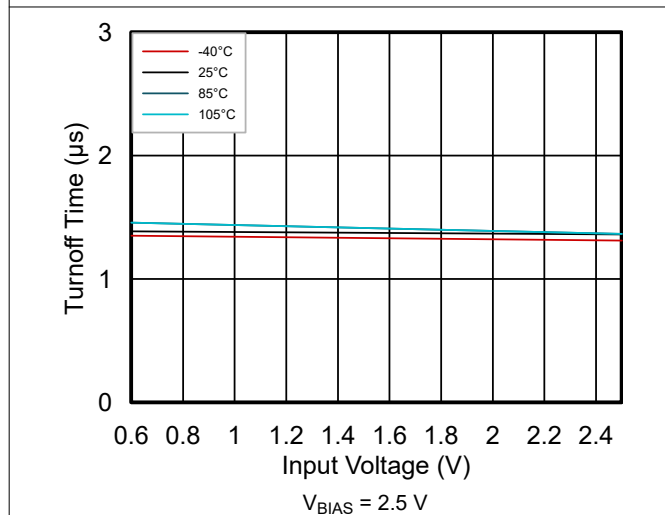

### 6.11 Typical AC Characteristics (continued)

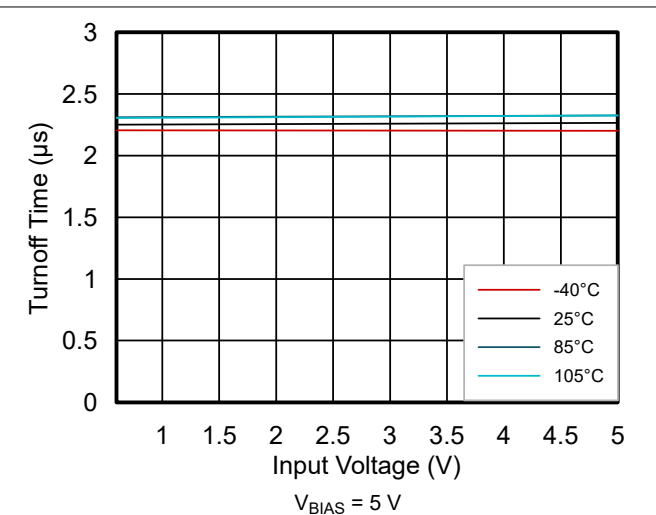

图 6-25. Turnoff Time vs Input Voltage (TPS22976N)



图 6-26. Turnoff Time vs Input Voltage (TPS22976N)

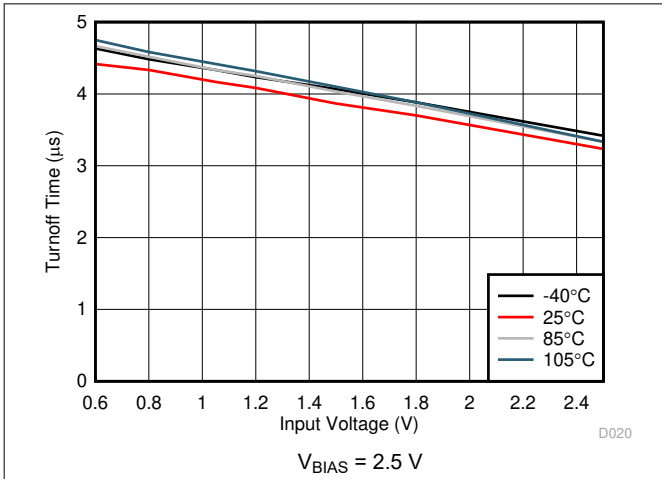

图 6-27. Turnon Time vs Input Voltage

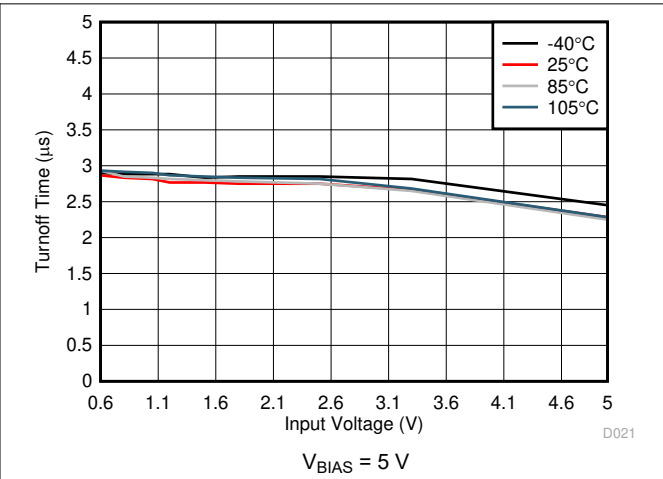

图 6-28. Turnon Time vs Input Voltage

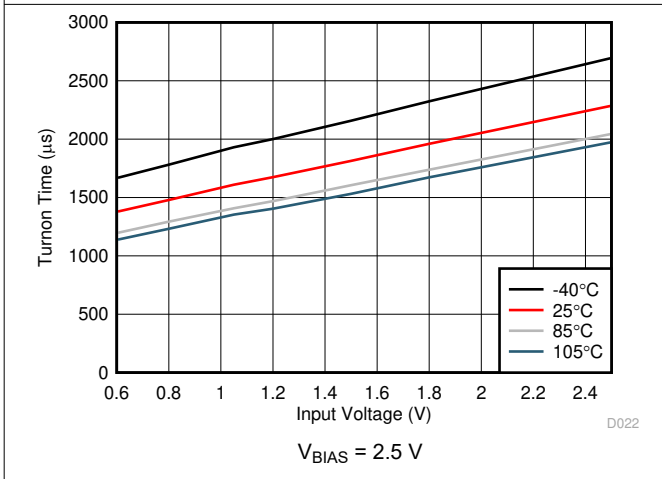

图 6-29. Rise Time vs Input Voltage

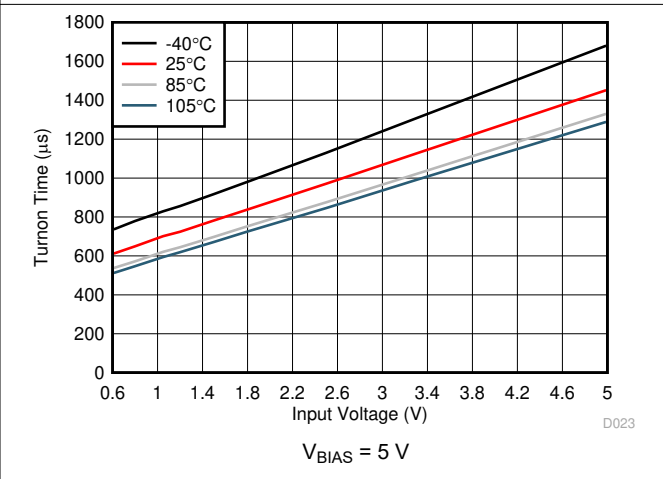

图 6-30. Rise Time vs Input Voltage

### 6.11 Typical AC Characteristics (continued)

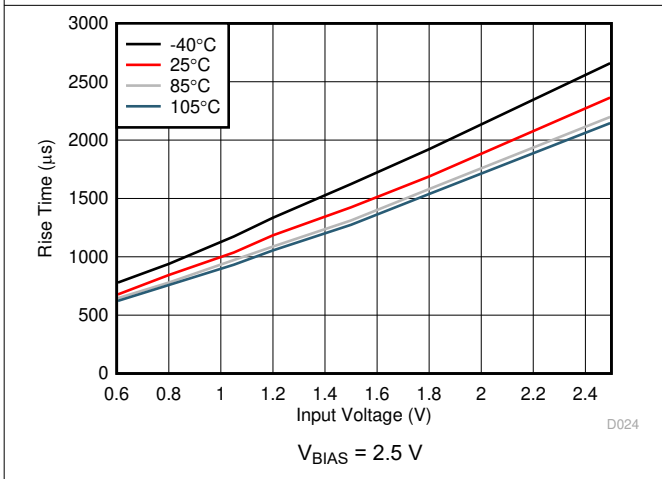

图 6-31. Turnon Response Time

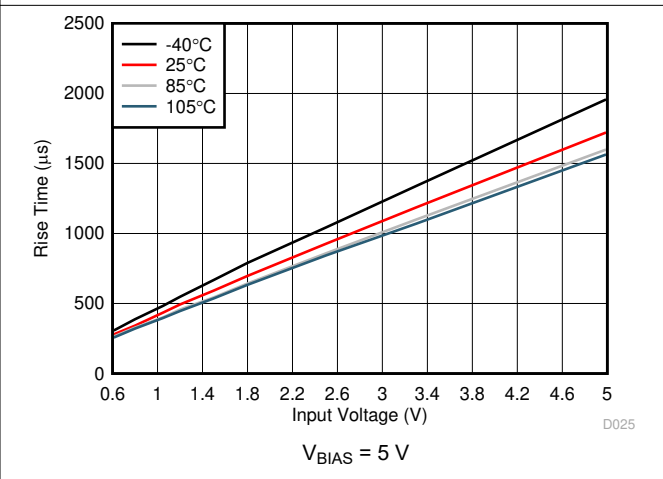

图 6-32. Turnon Response Time

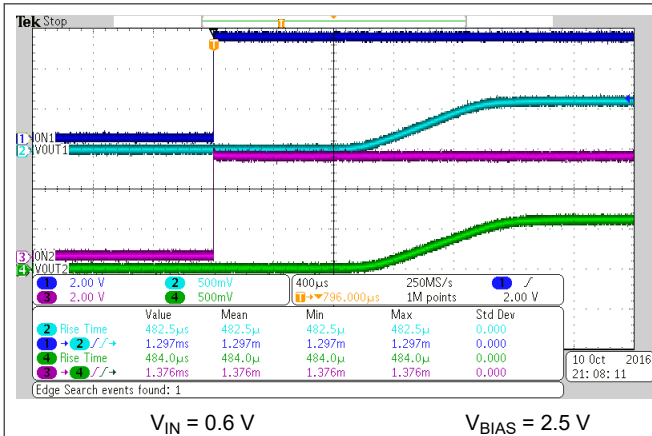

图 6-33. Turnon Response Time

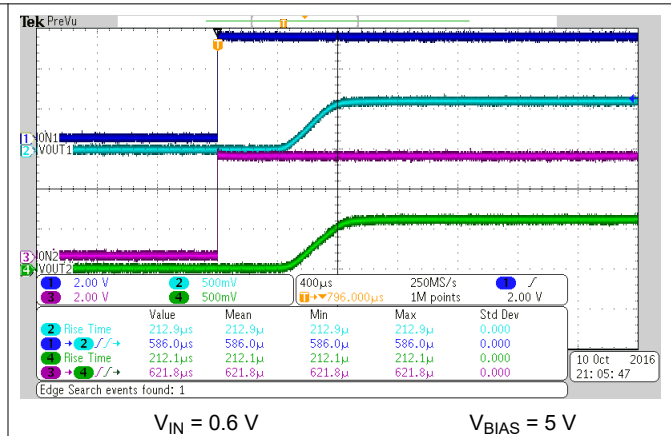

图 6-34. Turnon Response Time

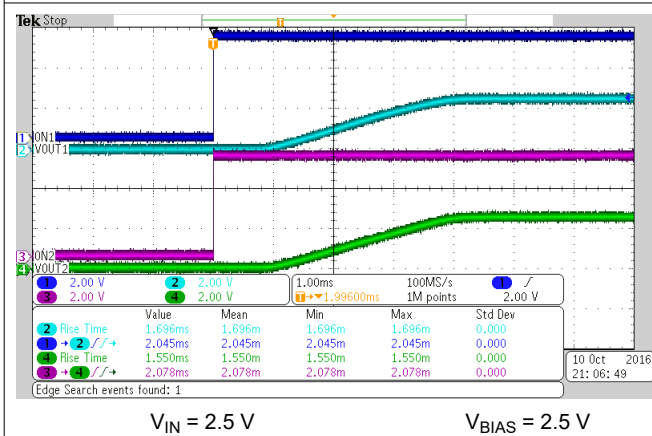

图 6-35. Turnoff Response Time

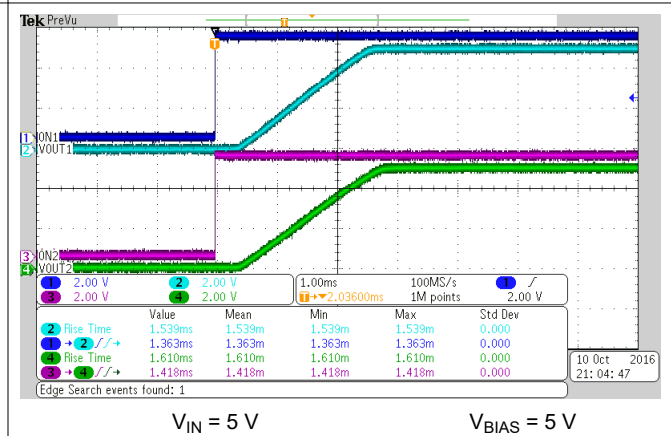

图 6-36. Turnoff Response Time

### 6.11 Typical AC Characteristics

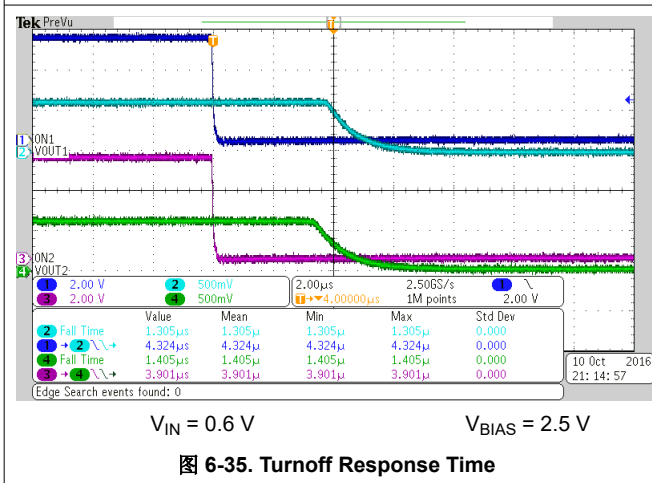

图 6-37. Turnoff Response Time

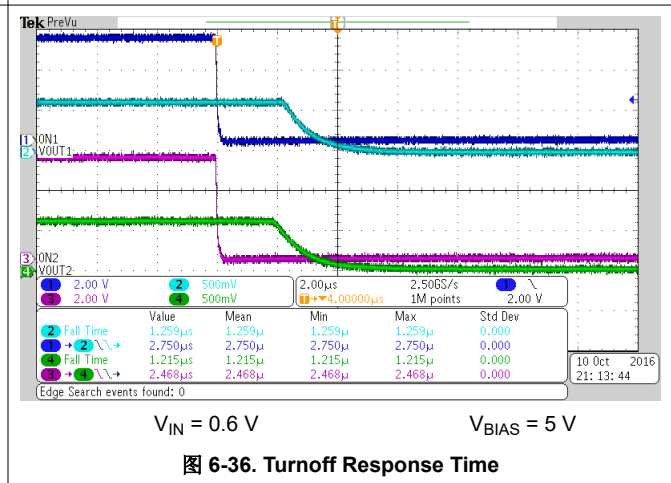

图 6-38. Turnoff Response Time

### AC Characteristics (TPS22976A)

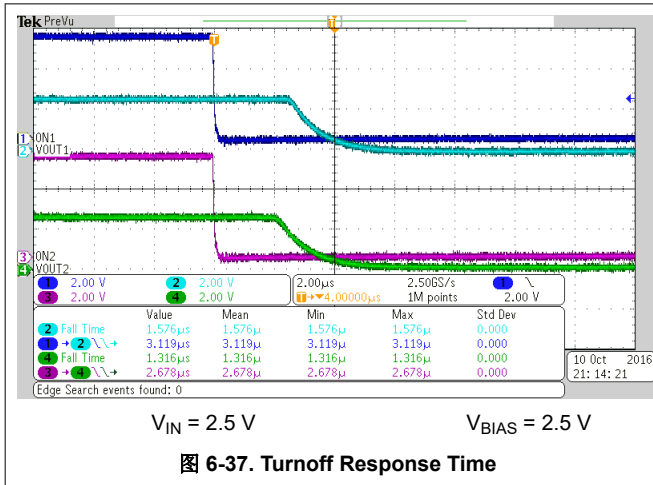

图 6-39. Delay Time vs Input Voltage

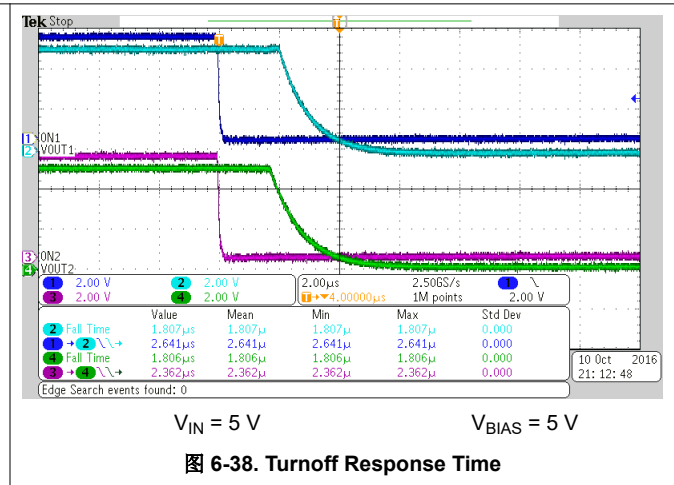

图 6-40. Delay Time vs Input Voltage

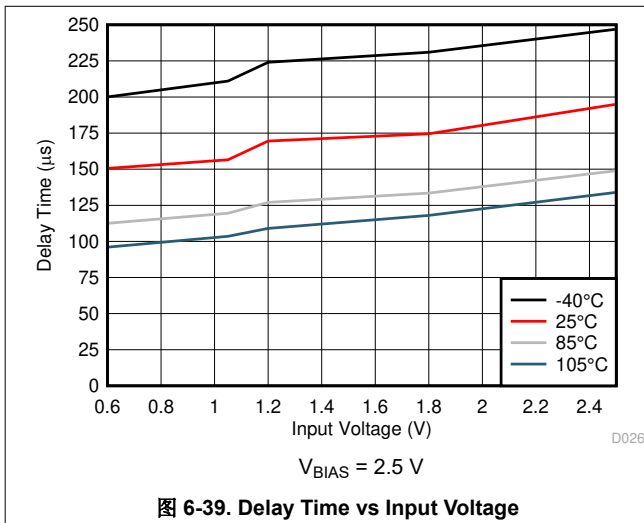

图 6-41. Turnon Time vs Input Voltage

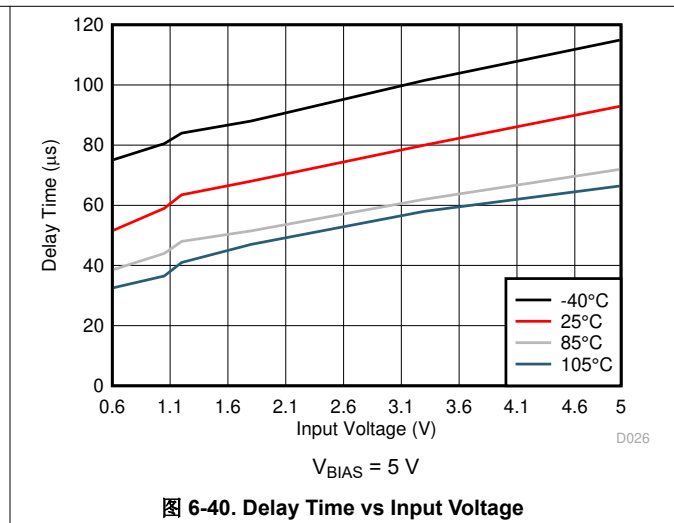

图 6-42. Turnon Time vs Input Voltage

### 6.11 Typical AC Characteristics (continued)

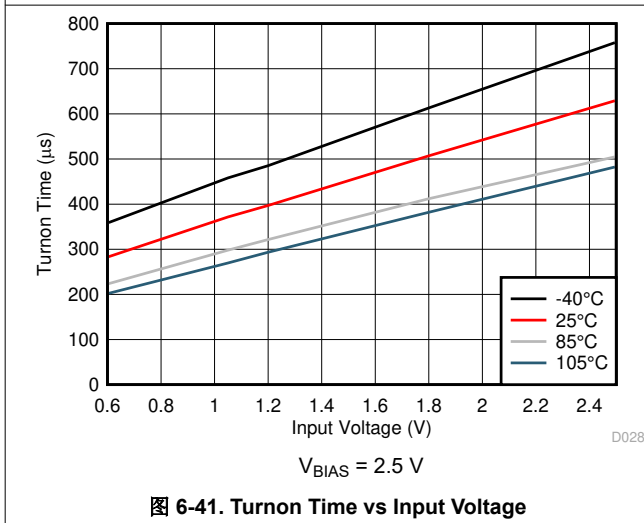

图 6-43. Rise Time vs Input Voltage

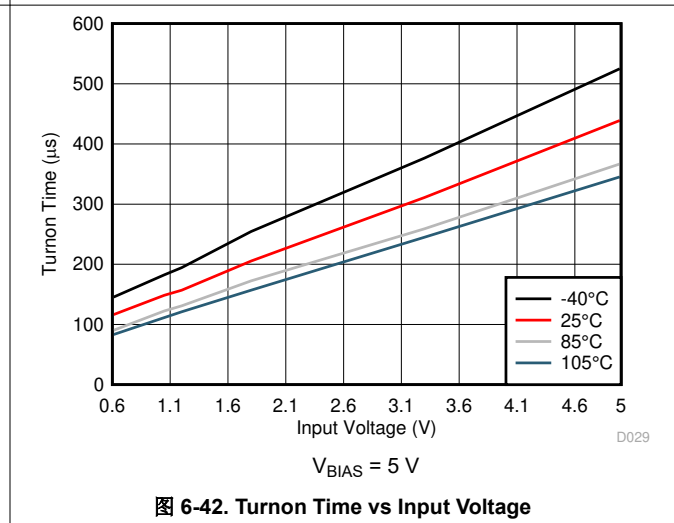

图 6-44. Rise Time vs Input Voltage

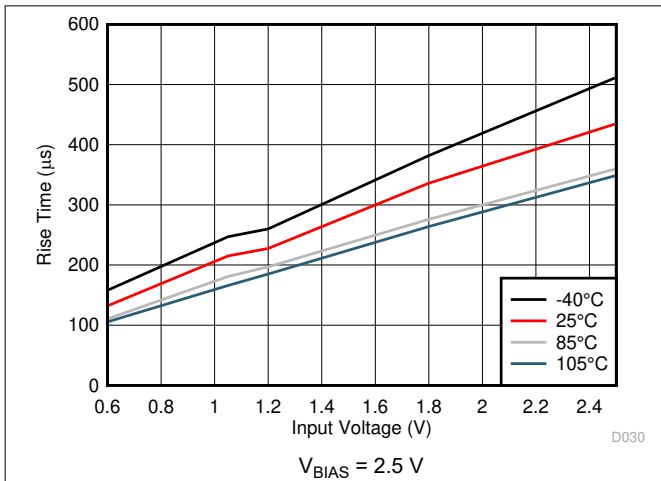

图 6-45. Turnon Response Time

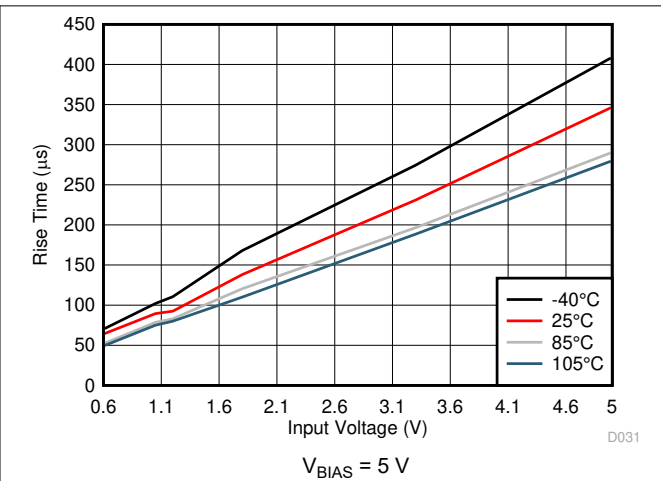

图 6-46. Turnoff Response Time

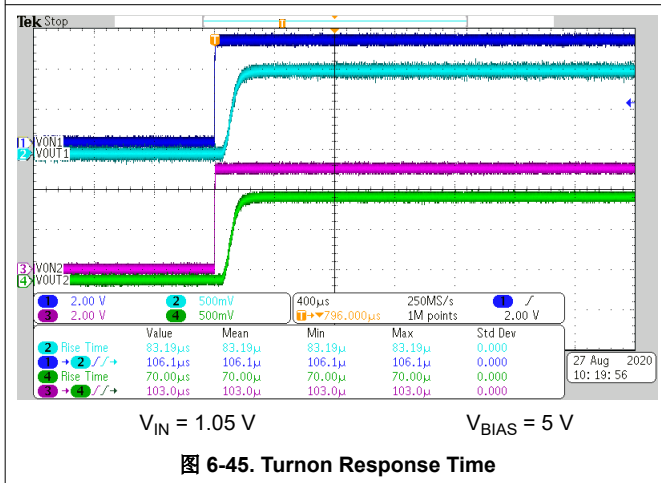

图 6-47. Turnon Response Time

## 7 Parameter Measurement Information

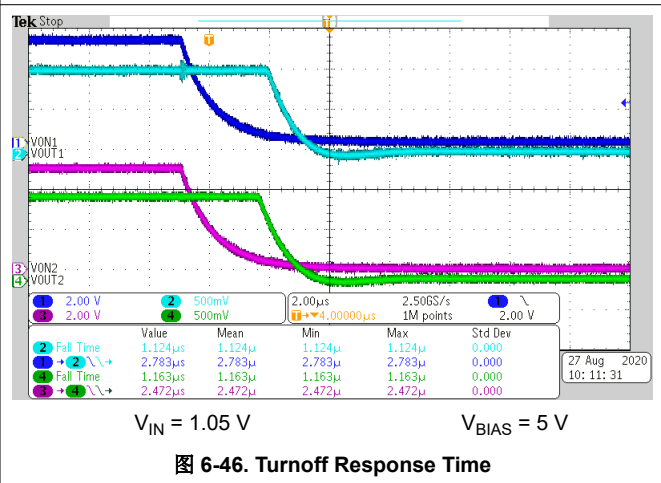

图 7-1. Test Circuit

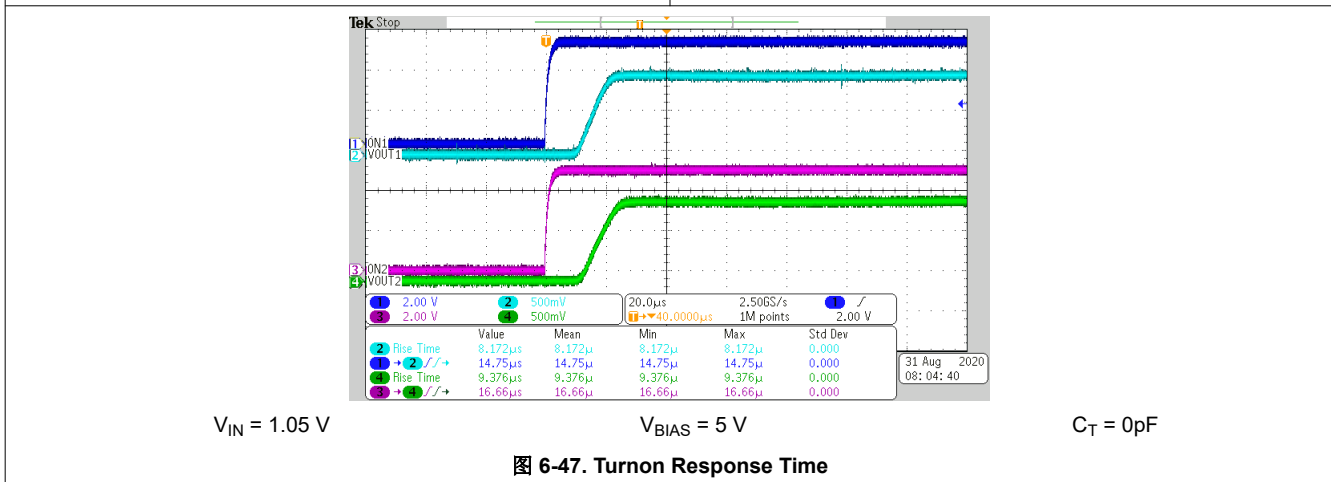

图 7-2.  $t_{ON}$  and  $t_{OFF}$  Waveforms

## 8 Detailed Description

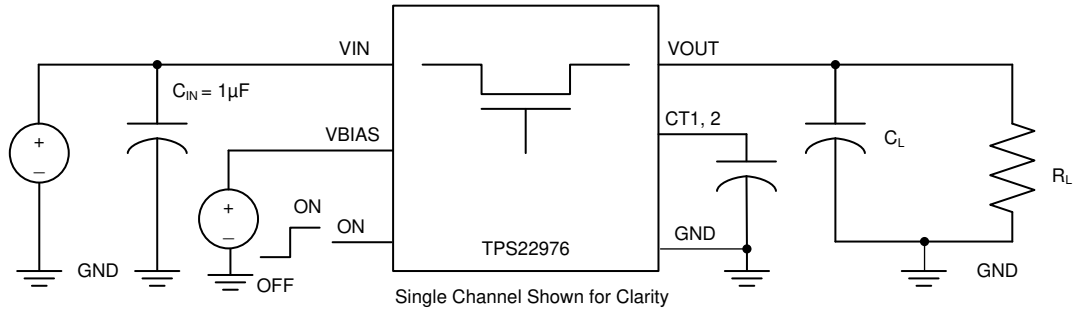
### 8.1 Overview

The TPS22976 is a 5.7-V, dual-channel, 14-m $\Omega$  (typical) R<sub>ON</sub> load switch in a 14-pin WSON package. Each channel can support a maximum continuous current of 6 A and is controlled by an on and off GPIO-compatible input. To reduce the voltage drop in high current rails, the device implements N-channel MOSFETs. Note that the ON pins must be connected and cannot be left floating. The device has a configurable slew rate for applications that require specific rise-time, which controls the inrush current. By controlling the inrush current, power supply sag can be reduced during turnon. Furthermore, the slew rate is proportional to the capacitor on the CT pin. See the [Adjustable Rise Time](#) section to determine the correct CT value for a desired rise time.

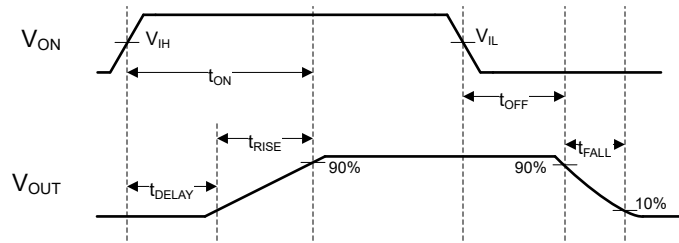
The internal circuitry is powered by the V<sub>BIAS</sub> pin, which supports voltages from 2.5 V to 5.7 V. This circuitry includes the charge pump, QOD (optional), and control logic. When a voltage is applied to V<sub>BIAS</sub>, and the ON<sub>1,2</sub> pins transition to a low state, the QOD functionality is activated. This connects V<sub>OUT1</sub> and V<sub>OUT2</sub> to ground through the on-chip resistor. The typical pulldown resistance (R<sub>PD</sub>) is 230  $\Omega$ .

During the off state, the device prevents downstream circuits from pulling high standby current from the supply. The integrated control logic, driver, power supply, and output discharge FET eliminates the need for any external components, reducing solution size and bill of materials (BOM) count.

## 8.2 Functional Block Diagram

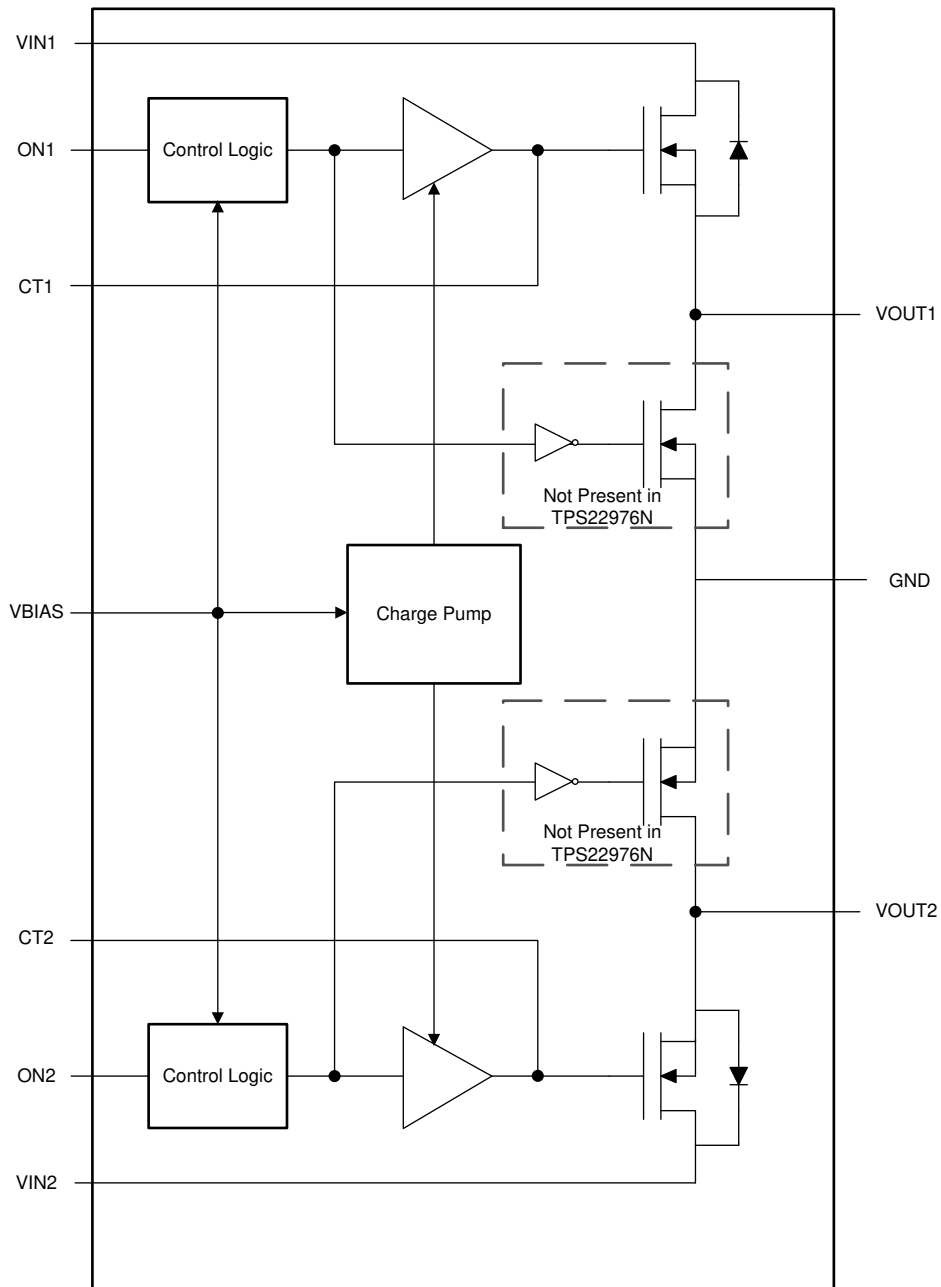

Copyright © 2016, Texas Instruments Incorporated

图 8-1. TPS22976 Functional Block Diagram

## 8.3 Feature Description

### 8.3.1 ON and OFF Control

The ON pins control the state of the switch. Asserting ON high enables the switch. ON is active high with a low threshold, making it capable of interfacing with low-voltage signals. The ON pin is compatible with standard GPIO logic threshold. It can be used with any microcontroller with 1.2 V or higher GPIO voltage. This pin cannot be left floating and must be tied either high or low for proper functionality.

### 8.3.2 Input Capacitor (Optional)

To limit the voltage drop on the input supply caused by transient inrush currents when the switch turns on into a discharged load capacitor, a capacitor needs to be placed between  $V_{IN}$  and GND. A 1- $\mu$ F ceramic capacitor,  $C_{IN}$ , placed close to the pins is usually sufficient. Higher values of  $C_{IN}$  can be used to further reduce the voltage drop during high-current application. When switching heavy loads, it is recommended to have an input capacitor about 10 times higher than the output capacitor to avoid excessive voltage drop.

### 8.3.3 Output Capacitor (Optional)

Due to the integrated body diode in the NMOS switch, a  $C_{IN}$  greater than  $C_L$  is highly recommended. A  $C_L$  greater than  $C_{IN}$  can cause  $V_{OUT}$  to exceed  $V_{IN}$  when the system supply is removed. This could result in current flow through the body diode from  $V_{OUT}$  to  $V_{IN}$ . A  $C_{IN}$  to  $C_L$  ratio of 10 to 1 is recommended for minimizing  $V_{IN}$  dip caused by inrush currents during startup, however a 10 to 1 ratio for capacitance is not required for proper functionality of the device. A ratio smaller than 10 to 1 (such as 1 to 1) could cause slightly more  $V_{IN}$  dip upon turnon due to inrush currents. This can be mitigated by increasing the capacitance on the CT pin for a longer rise time (see the [Adjustable Rise Time](#) section).

### 8.3.4 Quick Output Discharge (QOD) (Not Present in TPS22976N)

The TPS22976 and TPS22976A include a QOD feature. When the switch is disabled, an internal discharge resistance is connected between  $V_{OUT}$  and GND to remove the remaining charge from the output. This resistance prevents the output from floating while the switch is disabled. For best results, it is recommended that the device gets disabled before  $V_{BIAS}$  falls below the minimum recommended voltage.

### 8.3.5 Thermal Shutdown

Thermal Shutdown protects the part from internally or externally generated excessive temperatures. When the device temperature exceeds  $T_{SD}$  (typical 160°C), the switch is turned off. The switch automatically turns on again if the temperature of the die drops 20 degrees below the  $T_{SD}$  threshold.

## 8.4 Device Functional Modes

表 8-1 lists the TPS22976 and TPS22976A functions.

表 8-1. TPS22976 and TPS22976A Functions Table

ON	$V_{IN}$ to $V_{OUT}$	$V_{OUT}$
L	Off	GND
H	On	$V_{IN}$

表 8-2 lists the TPS22976N functions.

表 8-2. TPS22976N Functions Table

ON	$V_{IN}$ to $V_{OUT}$	$V_{OUT}$
L	Off	Floating
H	On	$V_{IN}$



## 9 Application and Implementation

### 备注

以下应用部分中的信息不属于 TI 器件规格的范围，TI 不担保其准确性和完整性。TI 的客户应负责确定器件是否适用于其应用。客户应验证并测试其设计，以确保系统功能。

### 9.1 Application Information

This section highlights some of the design considerations for implementing the device in various applications. A PSpice model for this device is also available on the product page for additional information.

#### 9.1.1 Parallel Configuration

To increase current capabilities and to lower  $R_{ON}$ , both channels can be placed in parallel as seen in 图 9-1. With this configuration, the CT1 and CT2 pins can be tied together to use one capacitor, CT.

See the [TPS22966 Dual-Channel Load Switch in Parallel Configuration](#) application report and [Parallel Load Switches for Higher Output Current & Reduced ON-Resistance Design Guide](#) for more information.



图 9-1. Parallel Configuration

#### 9.1.2 Standby Power Reduction

Battery powered end equipments often have strict power budgets, in which there is a need to reduce current consumption. The TPS22976 significantly reduces system current consumption by disabling the supply voltage to subsystems in standby states. Alternatively, the TPS22976 reduces the leakage current overhead of the modules in standby mode as achieved in 图 9-2. Note that standby power reduction can be achieved on either channel, as well as dual-channel operation.

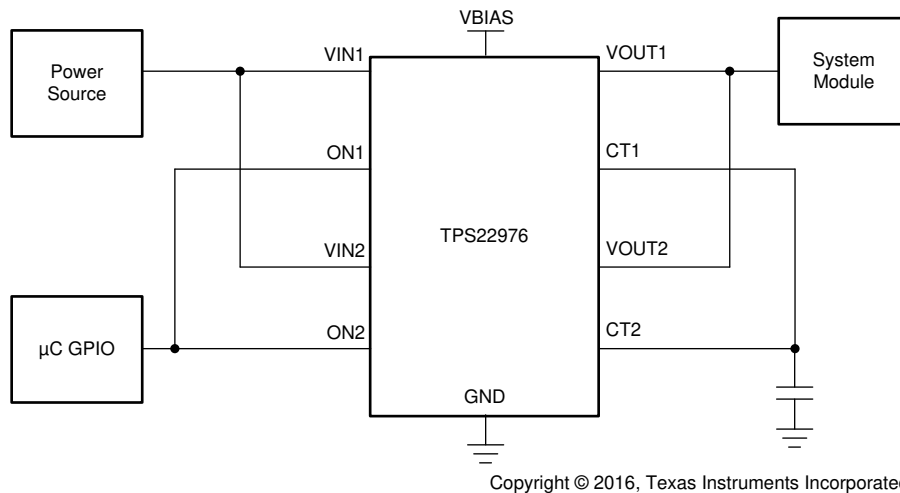
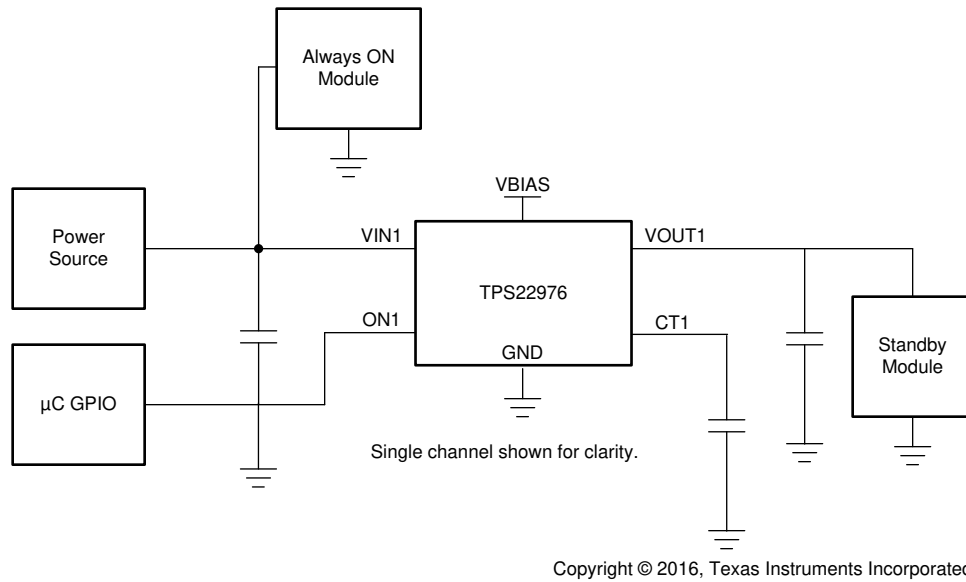

**图 9-2. Standby Power Reduction**

### 9.1.3 Power Supply Sequencing without GPIO Input

Sequential startup of several subsystems is often burdensome and adds complexity for several end equipments. The TPS22976 provides a power sequencing solution that reduces the overall system complexity, as seen in [图 9-3](#).

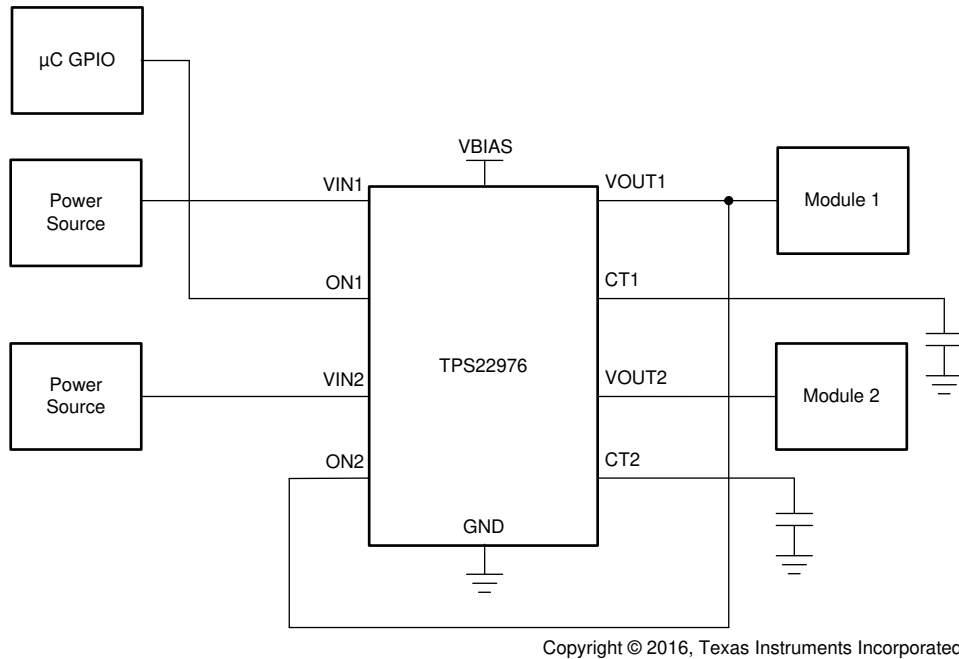

**图 9-3. Power Sequencing without a GPIO Input**

### 9.1.4 Reverse Current Blocking

Reverse current blocking is often desired in specific applications, as it prevents current from flowing from the output to the input of the load switch when the device is disabled. With the configuration illustrated in 图 9-4, the TPS22976 can be converted into a single-channel switch with reverse current blocking. VIN1 or VIN2 can be used as the input and VIN2 or VIN1 as the output.

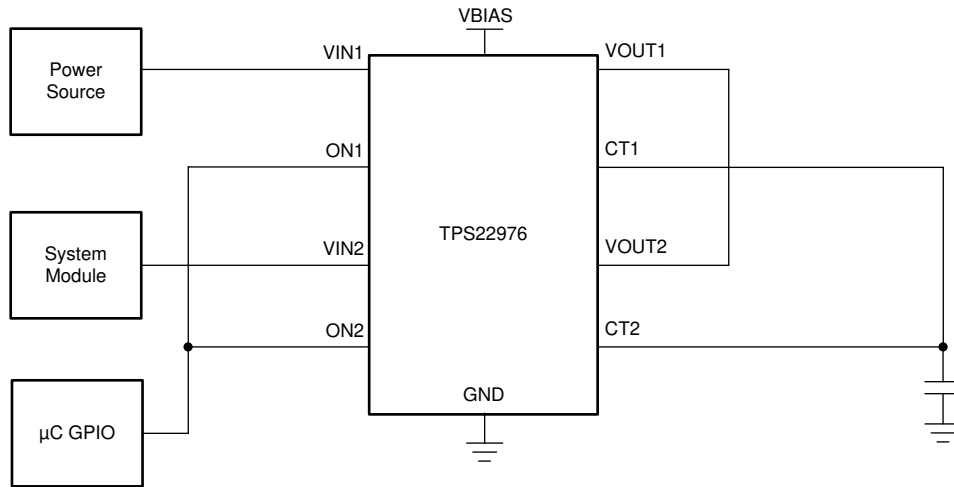

Copyright © 2016, Texas Instruments Incorporated

图 9-4. Reverse Current Blocking

### 9.2 Typical Application

This application demonstrates how the TPS22976 can be used to limit the inrush current when powering on downstream modules.

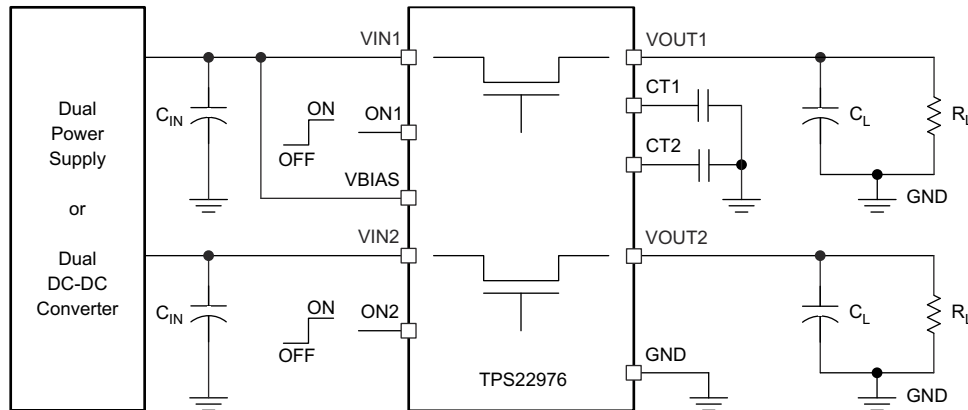

Copyright © 2016, Texas Instruments Incorporated

图 9-5. Typical Application Circuit

## 9.2.1 Design Requirements

表 9-1 shows the TPS22976 design parameters.

表 9-1. Design Parameters

DESIGN PARAMETER	VALUE
Input voltage	3.3 V
Bias voltage	5 V
Load capacitance ( $C_L$ )	22 $\mu$ F
Maximum acceptable inrush current	400 mA

## 9.2.2 Detailed Design Procedure

### 9.2.2.1 Inrush Current

When the switch is enabled, the output capacitors must be charged up from 0 V to the set value (3.3 V in this example). This charge arrives in the form of inrush current. Inrush current can be calculated using 方程式 1.

$$\text{Inrush Current} = C \times dV/dt \quad (1)$$

where

- C is the output capacitance
- dV is the output voltage
- dt is the rise time

The TPS22976 offers adjustable rise time for VOUT. This feature allows the user to control the inrush current during turnon. The appropriate rise time can be calculated using 表 9-1 and the inrush current equation. See 方程式 2 and 方程式 3.

$$400 \text{ mA} = 22 \mu\text{F} \times 3.3 \text{ V}/dt \quad (2)$$

$$dt = 181.5 \mu\text{s} \quad (3)$$

To ensure an inrush current of less than 400 mA, choose a CT value that yields a rise time of more than 181.5  $\mu$ s. See the oscilloscope captures in the [Application Curves](#) section for an example of how the CT capacitor can be used to reduce inrush current.

### 9.2.2.2 Adjustable Rise Time

A capacitor to GND on the CT pins sets the slew rate for each channel. To ensure desired performance, a capacitor with a minimum voltage rating of 25 V must be used on either CT pins. An approximate formula for the relationship between CT and slew rate is shown in Equation 4, and this is valid for TPS22976 and TPS22976N. The TPS22976A has a faster rise time and is represented by Equation 5.

Equation 4 and Equation 5 account for 10% to 90% measurement on  $V_{OUT}$  and do not apply for  $CT < 100$  pF. Use 表 9-2 to determine rise times for when  $CT = 0$  pF.

#### TPS22976, TPS22976N:

$$SR = 0.42 \times CT + 66 \quad (4)$$

#### TPS22976A:

$$SR = 0.0606 \times CT + 22 \quad (5)$$

where

- SR is the slew rate (in  $\mu\text{s}/\text{V}$ )
- CT is the capacitance value on the CT pin (in pF)
- The units for the constants 66 and 22 are in  $\mu\text{s}/\text{V}$ .

Rise time can be calculated by multiplying the input voltage by the slew rate. Table 10-2 shows rise time values measured on a typical device. Rise times shown below are only valid for the power-up sequence where  $V_{IN}$  and  $V_{BIAS}$  are already in steady state condition, and the ON pin is asserted high.

表 9-2. Rise Time Values (TPS22976, TPS22976N)

CT (pF)	RISE TIME ( $\mu\text{s}$ ) 10% - 90%, $C_L = 0.1 \mu\text{F}$ , $C_{IN} = 1 \mu\text{F}$ , $R_L = 10 \Omega$ <sup>(1)</sup>						
	5 V	3.3 V	1.8 V	1.5 V	1.2 V	1.05 V	0.6 V
0	149	112	77	70	60	56	42
220	548	388	236	206	173	154	103
470	968	673	401	342	289	256	169
1000	1768	1220	711	608	505	445	286
2200	3916	2678	1554	1332	1097	949	627
4700	8040	5477	3179	2691	2240	1964	1249
10000	16520	11150	6410	5401	4430	3933	2526

(1) TYPICAL VALUES at 25°C,  $V_{BIAS} = 5$  V, 25 V X7R 10% CERAMIC CAP

### 9.2.3 Application Curves

$V_{BIAS} = 5$  V ;  $V_{IN} = 3.3$  V ;  $C_L = 22 \mu\text{F}$

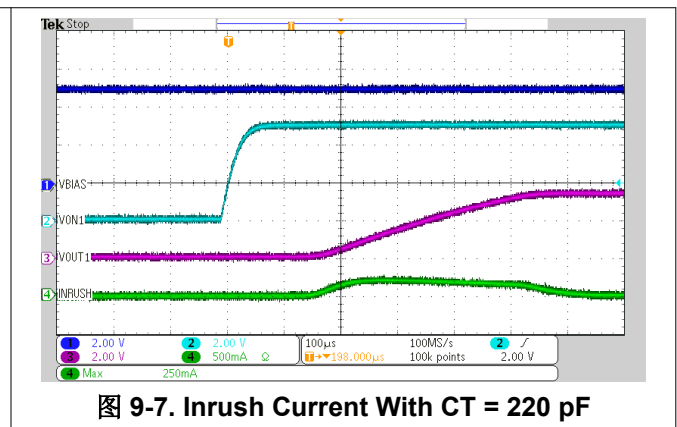
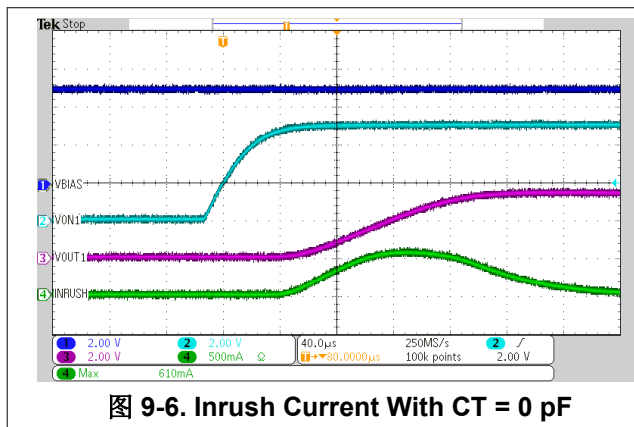

### 9.3 Power Supply Recommendations

The device is designed to operate from a  $V_{BIAS}$  range of 2.5 V to 5.7 V and a  $V_{IN}$  range of 0.6 V to  $V_{BIAS}$ .

### 9.4 Layout

#### 9.4.1 Layout Guidelines

For best performance, all traces must be as short as possible. To be most effective, the input and output capacitors must be placed close to the device to minimize the effects that parasitic trace inductances may have on normal operation. Using wide traces for  $V_{IN}$ ,  $V_{OUT}$ , and GND helps minimize the parasitic electrical effects along with minimizing the case to ambient thermal impedance.

#### 9.4.2 Layout Example

Notice the thermal vias located under the exposed thermal pad of the device. This allows for thermal diffusion away from the device.



图 9-8. PCB Layout Example

#### 9.4.3 Power Dissipation

The maximum IC junction temperature must be restricted to 125°C under normal operating conditions. To calculate the maximum allowable power dissipation,  $P_{D(max)}$  for a given output current and ambient temperature, use 方程式 6.

$$P_{D(max)} = \frac{T_{J(max)} - T_A}{\theta_{JA}} \quad (6)$$

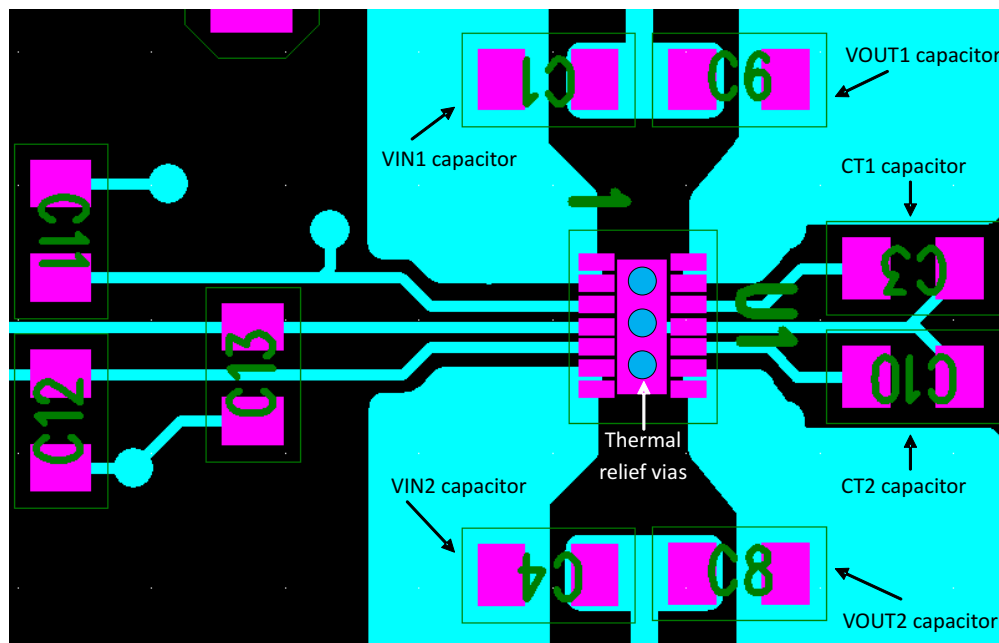
where

- $P_{D(max)}$  is the maximum allowable power dissipation.
- $T_{J(max)}$  is the maximum allowable junction temperature (125°C for the TPS22976).
- $T_A$  is the ambient temperature of the device.
- $\theta_{JA}$  is the junction to air thermal impedance. See the [Thermal Information](#) section. This parameter is highly dependent upon board layout.

## 10 Device and Documentation Support

### 10.1 Device Support

#### 10.1.1 Developmental Support

For the TPS22976N PSpice Transient Model, see [SLVMBV5](#).

For the TPS22976 PSpice Transient Model, see [SLVMBV6](#).

### 10.2 Documentation Support

#### 10.2.1 Related Documentation

For related documentation see the following:

[TPS22976 Evaluation Module User's Guide](#)

### 10.3 接收文档更新通知

要接收文档更新通知，请导航至 [ti.com](#) 上的器件产品文件夹。点击 [通知](#) 进行注册，即可每周接收产品信息更改摘要。有关更改的详细信息，请查看任何已修订文档中包含的修订历史记录。

### 10.4 支持资源

[TI E2E™ 中文支持论坛](#) 是工程师的重要参考资料，可直接从专家处获得快速、经过验证的解答和设计帮助。搜索现有解答或提出自己的问题，获得所需的快速设计帮助。

链接的内容由各个贡献者“按原样”提供。这些内容并不构成 TI 技术规范，并且不一定反映 TI 的观点；请参阅 TI 的 [使用条款](#)。

### 10.5 Trademarks

TI E2E™ is a trademark of Texas Instruments.  
所有商标均为其各自所有者的财产。

### 10.6 静电放电警告



静电放电 (ESD) 会损坏这个集成电路。德州仪器 (TI) 建议通过适当的预防措施处理所有集成电路。如果不遵守正确的处理和安装程序，可能会损坏集成电路。

ESD 的损坏小至导致微小的性能降级，大至整个器件故障。精密的集成电路可能更容易受到损坏，这是因为非常细微的参数更改都可能会导致器件与其发布的规格不相符。

### 10.7 术语表

[TI 术语表](#) 本术语表列出并解释了术语、首字母缩略词和定义。

## 11 Revision History

注：以前版本的页码可能与当前版本的页码不同

Changes from Revision C (September 2020) to Revision D (December 2023)	Page
• Updated $R_{ON}$ for TPS22976 in the <i>Device Comparison Table</i> .....	3
• Updated $I_{Q,VBIAS}$ for TPS22976 in the <i>Electrical Characteristics (VBIAS = 5V)</i> .....	5
• Updated $R_{ON}$ for TPS22976 in the <i>Electrical Characteristics (VBIAS = 5V)</i> .....	5
• Updated $R_{ON}$ for TPS22976 in the <i>Electrical Characteristics (VBIAS = 2.5V)</i> .....	5
• Updated $t_{OFF}$ for TPS22976 in the <i>Switching Characteristics (TPS22976)</i> .....	5
• Updated four On-resistance plots for TPS22976 in the <i>Typical DC Characteristics</i> .....	13
• Updated two turnoff time plots for TPS22976 in the <i>Typical AC Characteristics</i> .....	16

Changes from Revision B (September 2017) to Revision C (September 2020)	Page
• 在 <a href="#">特性</a> 列表中添加了 TPS22976A 静态电流和上升时间.....	1

• 在 <a href="#">器件信息</a> 表中添加了 TPS22976A.....	1
• Added <a href="#">Switching Characteristics (TPS22976A)</a> table.....	5
• Added a line for quiescent current for TPS22976A in all of the <a href="#">Specifications</a> tables.....	5
• Added two quiescent current graphs in <a href="#">Typical DC Characteristics</a> for the TPS22976A.....	13
• Added section for the TPS22976A in <a href="#">Typical AC Characteristics</a> .....	16
• Added CT pin equation for the TPS22976A in <a href="#">Adjustable Rise Time</a> section.....	29

---

## 12 Mechanical, Packaging, and Orderable Information

The following pages include mechanical, packaging, and orderable information. This information is the most-current data available for the designated devices. This data is subject to change without notice and without revision of this document. For browser-based versions of this data sheet, see the left-hand navigation pane.



**PACKAGING INFORMATION**

Orderable Device	Status (1)	Package Type	Package Drawing	Pins	Package Qty	Eco Plan (2)	Lead finish/ Ball material (6)	MSL Peak Temp (3)	Op Temp (°C)	Device Marking (4/5)	Samples
TPS22976ADPUR	ACTIVE	WSON	DPU	14	3000	RoHS & Green	NIPDAU	Level-1-260C-UNLIM	-40 to 105	22976A	<a href="#">Samples</a>
TPS22976DPUR	ACTIVE	WSON	DPU	14	3000	RoHS & Green	NIPDAU	Level-1-260C-UNLIM	-40 to 105	22976	<a href="#">Samples</a>
TPS22976DPUT	ACTIVE	WSON	DPU	14	250	RoHS & Green	NIPDAU	Level-1-260C-UNLIM	-40 to 105	22976	<a href="#">Samples</a>
TPS22976NDPUR	ACTIVE	WSON	DPU	14	3000	RoHS & Green	NIPDAU	Level-1-260C-UNLIM	-40 to 105	22976N	<a href="#">Samples</a>
TPS22976NDPUT	ACTIVE	WSON	DPU	14	250	RoHS & Green	NIPDAU	Level-1-260C-UNLIM	-40 to 105	22976N	<a href="#">Samples</a>

(1) The marketing status values are defined as follows:

**ACTIVE:** Product device recommended for new designs.

**LIFEBUY:** TI has announced that the device will be discontinued, and a lifetime-buy period is in effect.

**NRND:** Not recommended for new designs. Device is in production to support existing customers, but TI does not recommend using this part in a new design.

**PREVIEW:** Device has been announced but is not in production. Samples may or may not be available.

**OBSELETE:** TI has discontinued the production of the device.

(2) **RoHS:** TI defines "RoHS" to mean semiconductor products that are compliant with the current EU RoHS requirements for all 10 RoHS substances, including the requirement that RoHS substance do not exceed 0.1% by weight in homogeneous materials. Where designed to be soldered at high temperatures, "RoHS" products are suitable for use in specified lead-free processes. TI may reference these types of products as "Pb-Free".

**RoHS Exempt:** TI defines "RoHS Exempt" to mean products that contain lead but are compliant with EU RoHS pursuant to a specific EU RoHS exemption.

**Green:** TI defines "Green" to mean the content of Chlorine (Cl) and Bromine (Br) based flame retardants meet JS709B low halogen requirements of <=1000ppm threshold. Antimony trioxide based flame retardants must also meet the <=1000ppm threshold requirement.

(3) MSL, Peak Temp. - The Moisture Sensitivity Level rating according to the JEDEC industry standard classifications, and peak solder temperature.

(4) There may be additional marking, which relates to the logo, the lot trace code information, or the environmental category on the device.

(5) Multiple Device Markings will be inside parentheses. Only one Device Marking contained in parentheses and separated by a "~" will appear on a device. If a line is indented then it is a continuation of the previous line and the two combined represent the entire Device Marking for that device.

(6) Lead finish/Ball material - Orderable Devices may have multiple material finish options. Finish options are separated by a vertical ruled line. Lead finish/Ball material values may wrap to two lines if the finish value exceeds the maximum column width.

**Important Information and Disclaimer:** The information provided on this page represents TI's knowledge and belief as of the date that it is provided. TI bases its knowledge and belief on information provided by third parties, and makes no representation or warranty as to the accuracy of such information. Efforts are underway to better integrate information from third parties. TI has taken and continues to take reasonable steps to provide representative and accurate information but may not have conducted destructive testing or chemical analysis on incoming materials and chemicals. TI and TI suppliers consider certain information to be proprietary, and thus CAS numbers and other limited information may not be available for release.

In no event shall TI's liability arising out of such information exceed the total purchase price of the TI part(s) at issue in this document sold by TI to Customer on an annual basis.

**TAPE AND REEL INFORMATION**

**QUADRANT ASSIGNMENTS FOR PIN 1 ORIENTATION IN TAPE**

\*All dimensions are nominal

Device	Package Type	Package Drawing	Pins	SPQ	Reel Diameter (mm)	Reel Width W1 (mm)	A0 (mm)	B0 (mm)	K0 (mm)	P1 (mm)	W (mm)	Pin1 Quadrant
TPS22976ADPUR	WSON	DPU	14	3000	180.0	8.4	2.25	3.25	1.05	4.0	8.0	Q1
TPS22976DPUR	WSON	DPU	14	3000	180.0	8.4	2.25	3.25	1.05	4.0	8.0	Q1
TPS22976DPUR	WSON	DPU	14	3000	180.0	8.4	2.25	3.25	1.05	4.0	8.0	Q1
TPS22976DPUT	WSON	DPU	14	250	180.0	8.4	2.25	3.25	1.05	4.0	8.0	Q1
TPS22976NDPUR	WSON	DPU	14	3000	180.0	8.4	2.25	3.25	1.05	4.0	8.0	Q1
TPS22976NDPUT	WSON	DPU	14	250	180.0	8.4	2.25	3.25	1.05	4.0	8.0	Q1

**TAPE AND REEL BOX DIMENSIONS**

\*All dimensions are nominal

Device	Package Type	Package Drawing	Pins	SPQ	Length (mm)	Width (mm)	Height (mm)
TPS22976ADPUR	WSON	DPU	14	3000	182.0	182.0	20.0
TPS22976DPUR	WSON	DPU	14	3000	210.0	185.0	35.0
TPS22976DPUR	WSON	DPU	14	3000	182.0	182.0	20.0
TPS22976DPUT	WSON	DPU	14	250	182.0	182.0	20.0
TPS22976NDPUR	WSON	DPU	14	3000	182.0	182.0	20.0
TPS22976NDPUT	WSON	DPU	14	250	182.0	182.0	20.0

DPU (R-PWSON-N14)

PLASTIC SMALL OUTLINE NO-LEAD

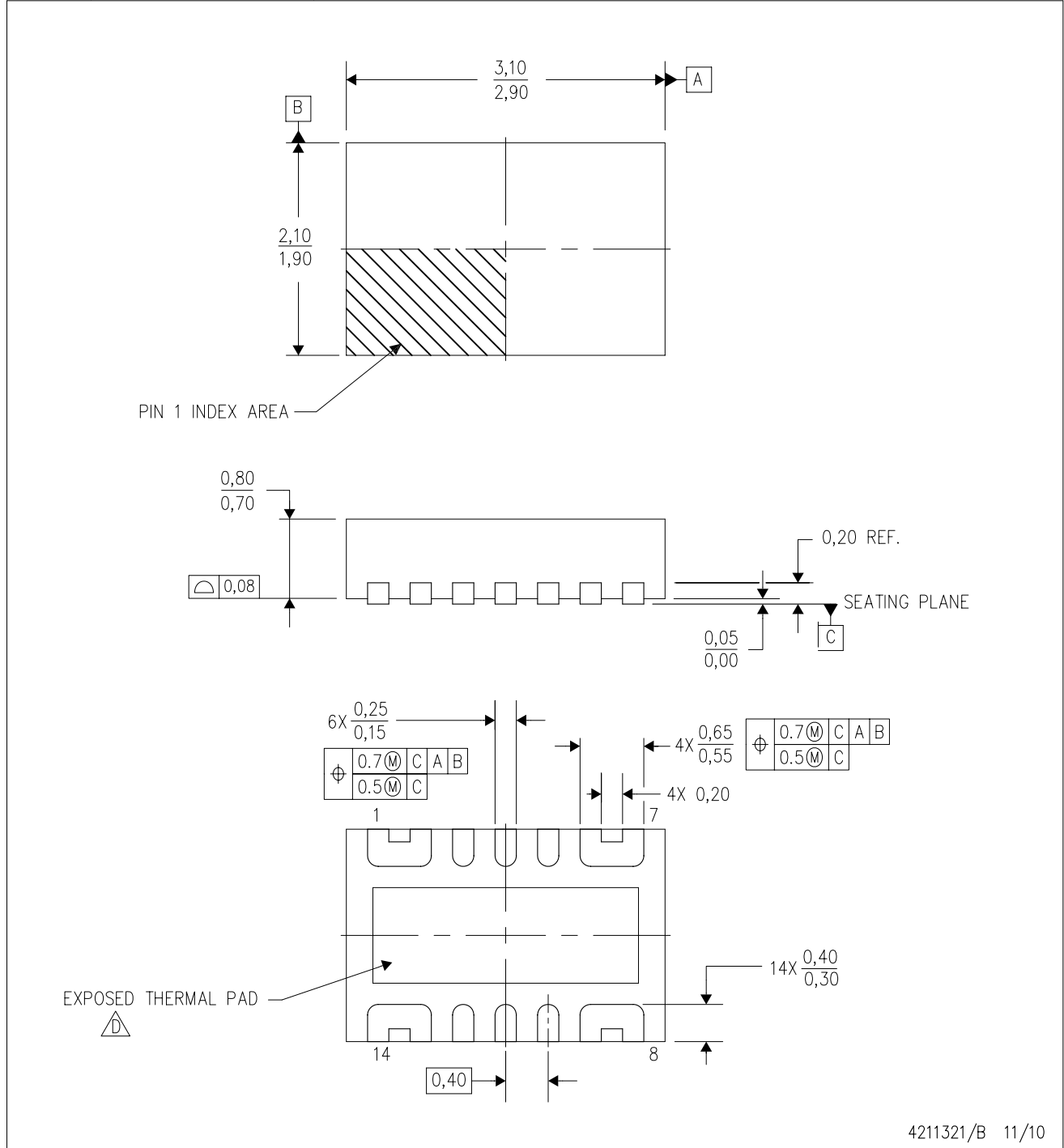

4211321/B 11/10

- NOTES:
- A. All linear dimensions are in millimeters. Dimensioning and tolerancing per ASME Y14.5M-1994.
  - B. This drawing is subject to change without notice.
  - C. Small Outline No-Lead (SON) package configuration.
  -  D. The package thermal pad must be soldered to the board for thermal and mechanical performance. See the Product Data Sheet for details regarding the exposed thermal pad dimensions.
  - E. This package is Pb-free.

## THERMAL PAD MECHANICAL DATA

DPU (R-PWSON-N14)

PLASTIC SMALL OUTLINE NO-LEAD

### THERMAL INFORMATION

This package incorporates an exposed thermal pad that is designed to be attached directly to an external heatsink. The thermal pad must be soldered directly to the printed circuit board (PCB). After soldering, the PCB can be used as a heatsink. In addition, through the use of thermal vias, the thermal pad can be attached directly to the appropriate copper plane shown in the electrical schematic for the device, or alternatively, can be attached to a special heatsink structure designed into the PCB. This design optimizes the heat transfer from the integrated circuit (IC).

For information on the Quad Flatpack No-Lead (QFN) package and its advantages, refer to Application Report, QFN/SON PCB Attachment, Texas Instruments Literature No. SLUA271. This document is available at [www.ti.com](http://www.ti.com).

The exposed thermal pad dimensions for this package are shown in the following illustration.

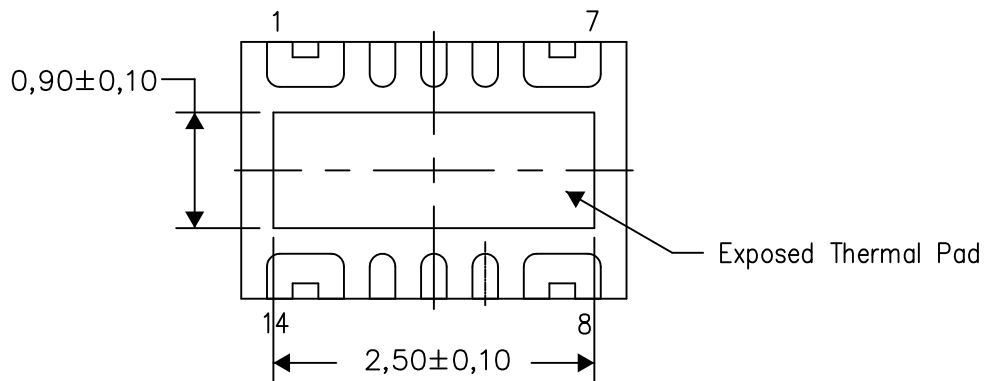

Bottom View

Exposed Thermal Pad Dimensions

4211395/C 04/15

NOTE: All linear dimensions are in millimeters

DPU (R-PWSON-N14)

PLASTIC SMALL OUTLINE NO-LEAD

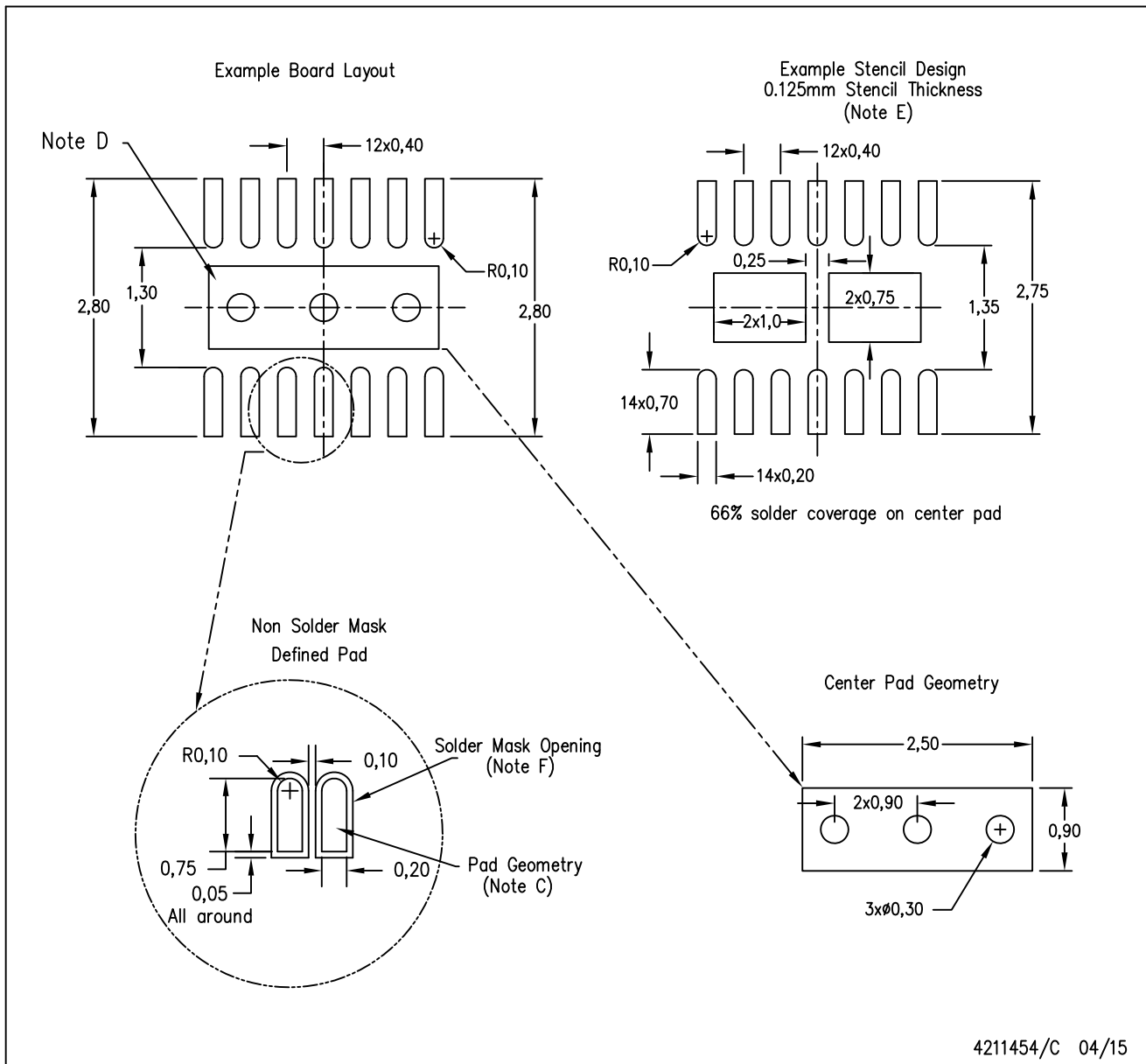

- NOTES:
- All linear dimensions are in millimeters.
  - This drawing is subject to change without notice.
  - Publication IPC-7351 is recommended for alternate designs.
  - This package is designed to be soldered to a thermal pad on the board. Refer to Application Note, QFN/SON PCB Attachment, Texas Instruments Literature No. SLUA271, and also the Product Data Sheets for specific thermal information, via requirements, and recommended board layout. These documents are available at [www.ti.com](http://www.ti.com) <<http://www.ti.com>>.
  - Laser cutting apertures with trapezoidal walls and also rounding corners will offer better paste release. Customers should contact their board assembly site for stencil design recommendations. Refer to IPC 7525 for stencil design considerations.
  - Customers should contact their board fabrication site for minimum solder mask web tolerances between signal pads.

## 重要声明和免责声明

TI“按原样”提供技术和可靠性数据（包括数据表）、设计资源（包括参考设计）、应用或其他设计建议、网络工具、安全信息和其他资源，不保证没有瑕疵且不做任何明示或暗示的担保，包括但不限于对适销性、某特定用途方面的适用性或不侵犯任何第三方知识产权的暗示担保。

这些资源可供使用 TI 产品进行设计的熟练开发人员使用。您将自行承担以下全部责任：(1) 针对您的应用选择合适的 TI 产品，(2) 设计、验证并测试您的应用，(3) 确保您的应用满足相应标准以及任何其他功能安全、信息安全、监管或其他要求。

这些资源如有变更，恕不另行通知。TI 授权您仅可将这些资源用于研发本资源所述的 TI 产品的应用。严禁对这些资源进行其他复制或展示。您无权使用任何其他 TI 知识产权或任何第三方知识产权。您应全额赔偿因在这些资源的使用中对 TI 及其代表造成的任何索赔、损害、成本、损失和债务，TI 对此概不负责。

TI 提供的产品受 [TI 的销售条款](#) 或 [ti.com](#) 上其他适用条款/TI 产品随附的其他适用条款的约束。TI 提供这些资源并不会扩展或以其他方式更改 TI 针对 TI 产品发布的适用的担保或担保免责声明。

TI 反对并拒绝您可能提出的任何其他或不同的条款。

邮寄地址：Texas Instruments, Post Office Box 655303, Dallas, Texas 75265  
Copyright © 2024，德州仪器 (TI) 公司