

## 带有 $V_{BATT}$ 短路保护功能的 TPS254900A-Q1 汽车 USB 主机充电器

### 1 特性

- 符合汽车应用要求
- 具有符合 AEC-Q100 标准的下列特性：
  - 器件温度等级 1：-40°C 至 +125°C 环境温度范围
  - 器件 HBM ESD 分类等级 H2
  - 器件 CDM ESD 分类等级 C5
- 4.5V 至 6.5V 的输入工作电压范围
- 3.5V (典型值) UVLO 支持启动/停止
- 集成型 45mΩ (典型值) 高侧 MOSFET
- 3.2A 最大连续输出电流
- 连接器上的电缆补偿精度  $V_{BUS} \pm 5\%$
- 支持 USB BC 1.2 充电下行端口 (CDP) 和标准下行端口 (SDP) 模式
- OUT、DP\_IN 和 DM\_IN 引脚上具备电池短路保护
- DP\_IN 和 DM\_IN 上的保护等级符合 IEC 61000-4-2 标准
  - $\pm 8kV$  接触放电和  $\pm 15kV$  空气放电
- 20 引脚 4mm x 3mm 四方扁平无引线 (QFN) 封装

### 2 应用

- 汽车类 USB 充电端口 (主机和集线器)
- 汽车类 USB 保护

### 3 说明

TPS254900A-Q1 器件是一款具有电池短路保护功能的 USB 充电端口控制器和电源开关。该特性为 OUT、DM\_IN 和 DP\_IN 引脚提供保护。这三个引脚最高可承受 18V 电压。

当发生电池短路条件时，内部 MOSFET 迅速关断。迅速关断功能对于保护上行直流/直流转换器、处理器或集线器数据线路来说非常重要。

TPS254900A-Q1 具有低至 3.5V 的 UVLO 电压，因此电源开关在启动/停止期间不会关断。

TPS254900A-Q1 45mΩ 电源开关具有两个可选可调节电流限值，可通过在相邻端口承载高负载时切换至较低电流限值来支持端口电源管理。对于具有多个端口且上行电源容量有限的系统而言，这一功能非常重要。

TPS254900A-Q1 具有一个能够控制上行电源的电流检测输出，即使在充电电流过大时也能在 USB 端口保持 5V 的电压。该功能对于 USB 电缆较长的系统而言至关重要，因为在对便携式设备进行快速充电的过程中会产生大幅压降。

凭借电流监视器，系统能够通过监视 IMON 电压来实时监视负载电流。电流监视器非常有用，可用于端口电源动态管理。

TPS254900A-Q1 器件还为 DP\_IN 和 DM\_IN 引脚提供符合 IEC 61000-4-2 标准的 4 级 ESD 保护功能。

#### 器件信息<sup>(1)</sup>

器件型号	封装	封装尺寸 (标称值)
TPS254900A-Q1	WQFN (20)	4.00mm × 3.00mm

(1) 如需了解所有可用封装，请参阅数据表末尾的可订购产品附录。

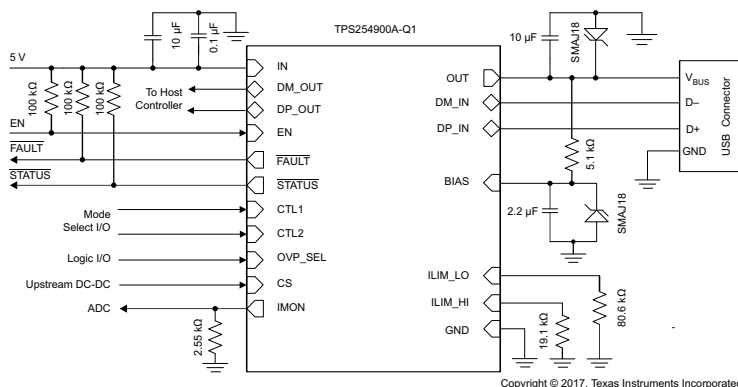

原理图



## Table of Contents

<b>1 特性</b> .....	1	8.4 Device Functional Modes.....	24
<b>2 应用</b> .....	1	<b>9 Application and Implementation</b> .....	27
<b>3 说明</b> .....	1	9.1 Application Information.....	27
<b>4 Revision History</b> .....	2	9.2 Typical Application.....	27
<b>5 Pin Configuration and Functions</b> .....	3	<b>10 Power Supply Recommendations</b> .....	31
<b>6 Specifications</b> .....	4	<b>11 Layout</b> .....	31
6.1 Absolute Maximum Ratings.....	4	11.1 Layout Guidelines.....	31
6.2 ESD Ratings.....	4	11.2 Layout Example.....	33
6.3 Recommended Operating Conditions.....	4	<b>12 Device and Documentation Support</b> .....	34
6.4 Thermal Information.....	5	12.1 Device Support.....	34
6.5 Electrical Characteristics.....	5	12.2 Documentation Support.....	34
6.6 Switching Characteristics.....	9	12.3 接收文档更新通知.....	34
6.7 Typical Characteristics.....	10	12.4 支持资源.....	34
<b>7 Parameter Measurement Information</b> .....	16	12.5 Trademarks.....	34
<b>8 Detailed Description</b> .....	17	12.6 静电放电警告.....	34
8.1 Overview.....	17	12.7 术语表.....	34
8.2 Functional Block Diagram.....	18	<b>13 Mechanical, Packaging, and Orderable Information</b> .....	34
8.3 Feature Description.....	18		

## 4 Revision History

注：以前版本的页码可能与当前版本的页码不同

Changes from Revision A (January 2018) to Revision B (July 2020)	Page
• 更新了整个文档中的表格、图和交叉参考的编号格式.....	1
• Added Footnote to the <a href="#">Recommended Operating Conditions</a> regarding operating at output current greater than 3.2 A.....	4
• Added three I <sub>OS</sub> spec rows to the Current Limit section for differing Test Conditions.....	5

---

Changes from Revision * (November 2017) to Revision A (January 2018)	Page
• 将“预告信息”更改为“量产数据”.....	1

## 5 Pin Configuration and Functions



图 5-1. RVC Package 20-Pin WQFN Top View

### Pin Functions

PIN		TYPE <sup>(1)</sup>	DESCRIPTION
NAME	NO.		
BIAS	12	PWR	Used for IEC protection. Typically, connect a 2.2- $\mu$ F capacitor and a transient-voltage suppressor (TVS) to ground and 5.1 k $\Omega$ to OUT.
CS	6	O	Linear cable compensation current. Connect to divider resistor of front-end dc-dc converter.
CTL1	8	I	Logic-level control input for controlling the charging mode and the signal switches; see the <a href="#">Device Truth Table (TT)</a> .
CTL2	9	I	Logic-level control input for controlling the charging mode and the signal switches; see the <a href="#">Device Truth Table (TT)</a> .
DM_IN	14	I/O	D - data line to downstream connector
DM_OUT	4	I/O	D - data line to upstream USB host controller
DP_IN	13	I/O	D+ data line to downstream connector
DP_OUT	5	I/O	D+ data line to upstream USB host controller
EN	7	I	Logic-level control input for turning the power and signal switches on or off. When EN is low, the device is disabled, and the signal and power switches are OFF.
FAULT	18	O	Active-low, open-drain output, asserted during overtemperature, overcurrent, and overvoltage conditions.
GND	11	—	Ground connection; should be connected externally to the thermal pad.
ILIM_HI	20	I	External resistor used to set the high current-limit threshold.
ILIM_LO	19	I	External resistor used to set the low current-limit threshold and the load-detection current threshold.
IMON	1	O	This pin sources a scaled-down ratio of current through the internal FET. A resistor from this pin to GND converts current to proportional voltage; used as an analog current monitor.
IN	2,3	PWR	Input supply voltage; connect a 0.1- $\mu$ F or greater ceramic capacitor from IN to GND as close to the IC as possible.
OUT	15,16	PWR	Power-switch output

### Pin Functions (continued)

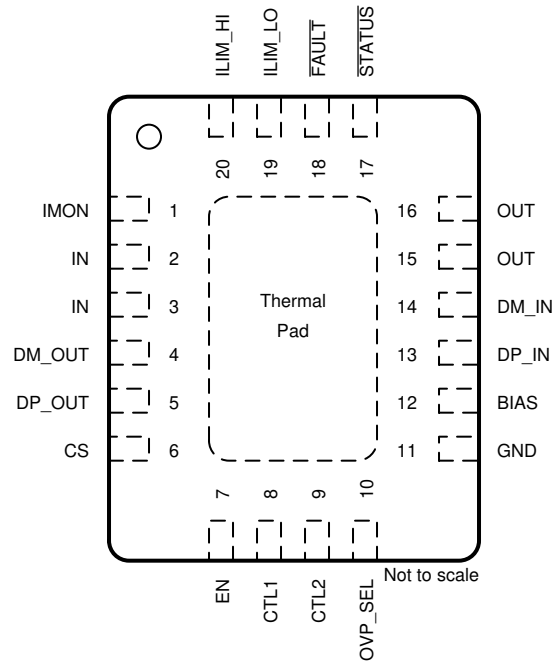
PIN		TYPE <sup>(1)</sup>	DESCRIPTION
NAME	NO.		
OVP_SEL	10	I	Logic-level control input for choosing the OUT overvoltage threshold. When OVP_SEL is low, $V_{(OV\_OUT\_LOW)}$ is active. When OVP_SEL is high, $V_{(OV\_OUT\_HIGH)}$ is active.
STATUS	17	O	Active-low open-drain output, asserted in load-detect conditions
Thermal pad	—	—	Thermal pad on the bottom of the package

(1) I = Input, O = Output, I/O = Input and output, PWR = Power

## 6 Specifications

### 6.1 Absolute Maximum Ratings

Voltages are with respect to GND unless otherwise noted<sup>(1)</sup>

		MIN	MAX	UNIT
Voltage range	CS, CTL1, CTL2, EN, FAULT, ILIM_HI, ILIM_LO, IN, IMON, OVP_SEL, STATUS	- 0.3	7	V
	DM_OUT, DP_OUT	- 0.3	5.7	
	BIAS, DM_IN, DP_IN, OUT	- 0.3	18	
Continuous current	DM_IN to DM_OUT or DP_IN to DP_OUT	- 100	100	mA
	OUT	Internally limited		
Continuous output source current, $I_{SRC}$	ILIM_HI, ILIM_LO, IMON	Internally limited		A
Continuous output sink current, $I_{SNK}$	FAULT, STATUS	25		mA
	CS	Internally limited		
Operating junction temperature, $T_J$		- 40	Internally limited	°C
Storage temperature, $T_{stg}$		- 65	150	°C

(1) Stresses beyond those listed under *Absolute Maximum Ratings* may cause permanent damage to the device. These are stress ratings only, which do not imply functional operation of the device at these or any other conditions beyond those indicated under *Recommended Operating Conditions*. Exposure to absolute-maximum-rated conditions for extended periods may affect device reliability.

### 6.2 ESD Ratings

		VALUE	UNIT	
$V_{(ESD)}$	Electrostatic discharge	Human-body model (HBM), per AEC Q100-002 <sup>(1)</sup>	V	
		Charged-device model (CDM), per AEC Q100-011		
		IEC 61000-4-2 contact discharge		DP_IN and DM_IN pins <sup>(4)</sup>
		IEC 61000-4-2 air discharge		DP_IN and DM_IN pins <sup>(4)</sup>

(1) AEC Q100-002 indicates that HBM stressing shall be in accordance with the ANSI/ESDA/JEDEC JS-001 specification.

(2) The passing level per AEC-Q100 Classification H2.

(3) The passing level per AEC-Q100 Classification C5

(4) Surges per IEC 61000-4-2, level 4, 1999 applied from DP\_IN and DM\_IN to output ground of the TPS254900Q1EVM-817 (SLUUBI0) evaluation module.

### 6.3 Recommended Operating Conditions

Voltages are with respect to GND unless otherwise noted.

			MIN	NOM	MAX	UNIT
$V_{(IN)}$	Supply voltage	IN	4.5		6.5	V
	Input voltage	CTL1, CTL2, EN, OVP_SEL	0		6.5	V
		DM_IN, DM_OUT, DP_IN, DP_OUT	0		3.6	V
$I_{(OUT)}$	Output continuous current	OUT ( - 40°C ≤ $T_A$ ≤ 85°C)			3.2 <sup>(1)</sup>	A
		DM_IN to DM_OUT or DP_IN to DP_OUT	- 30		30	mA

Voltages are with respect to GND unless otherwise noted.

		MIN	NOM	MAX	UNIT
Continuous output sink current	FAULT, STATUS			10	mA
$R_{(ILIM\_xx)}$	Current-limit-set resistors	9.6		1000	k $\Omega$
$T_J$	Operating junction temperature	- 40		125	$^{\circ}\text{C}$

(1) Operating at output continuous current greater than 3.2A is possible, however lifetime will be degraded.

## 6.4 Thermal Information

THERMAL METRIC <sup>(1)</sup>		TPS254900A-Q1	UNIT
		RVC (WQFN)	
		20 PINS	
$R_{\theta JA}$	Junction-to-ambient thermal resistance	37.9	$^{\circ}\text{C}/\text{W}$
$R_{\theta JC(top)}$	Junction-to-case (top) thermal resistance	39.9	$^{\circ}\text{C}/\text{W}$
$R_{\theta JB}$	Junction-to-board thermal resistance	11.9	$^{\circ}\text{C}/\text{W}$
$\psi_{JT}$	Junction-to-top characterization parameter	0.5	$^{\circ}\text{C}/\text{W}$
$\psi_{JB}$	Junction-to-board characterization parameter	11.8	$^{\circ}\text{C}/\text{W}$
$R_{\theta JC(bot)}$	Junction-to-case (bottom) thermal resistance	3.2	$^{\circ}\text{C}/\text{W}$

(1) For more information about traditional and new thermal metrics, see the [Semiconductor and IC Package Thermal Metrics](#) application report.

## 6.5 Electrical Characteristics

Unless otherwise noted,  $-40^{\circ}\text{C} \leq T_J \leq 125^{\circ}\text{C}$  and  $4.5\text{ V} \leq V_{(IN)} \leq 6.5\text{ V}$ ,  $V_{(EN)} = V_{(CTL1)} = V_{(CTL2)} = V_{(IN)}$ ,  $R_{(FAULT)} = R_{(STATUS)} = 10\text{ k}\Omega$ ,  $R_{(IMON)} = 2.55\text{ k}\Omega$ ,  $R_{(ILIM\_HI)} = 19.1\text{ k}\Omega$ ,  $R_{(ILIM\_LO)} = 80.6\text{ k}\Omega$ . Positive currents are into pins. Typical values are at  $25^{\circ}\text{C}$ . All voltages are with respect to GND.

PARAMETER	TEST CONDITIONS	MIN	TYP	MAX	UNIT	
OUT - POWER SWITCH						
$r_{DS(on)}$	On-resistance <sup>(1)</sup>	$T_J = 25^{\circ}\text{C}$		45	55	m $\Omega$
		$-40^{\circ}\text{C} \leq T_J \leq 85^{\circ}\text{C}$		45	69	
		$-40^{\circ}\text{C} \leq T_J \leq 125^{\circ}\text{C}$		45	77	
$I_{lkg}$	Reverse leakage current	$V_{OUT} = 6.5\text{ V}$ , $V_{IN} = V_{EN} = 0\text{ V}$ , $-40^{\circ}\text{C} \leq T_J \leq 85^{\circ}\text{C}$ , measure $I_{(IN)}$		0.01	2	$\mu\text{A}$
OUT - DISCHARGE						
$R_{(DCHG)}$	Discharge resistance (mode change)	400	500	630	$\Omega$	
CTL1, CTL2, EN, OVP_SEL INPUTS						
	Input pin rising logic threshold voltage	0.8	1.35	2	V	
	Input pin falling logic threshold voltage	0.7	1.15	1.65	V	
	Hysteresis <sup>(2)</sup>		200		mV	
	Input current	Pin voltage = 0 V or 6.5 V		- 1	1	$\mu\text{A}$
CURRENT LIMIT						

Unless otherwise noted,  $-40^{\circ}\text{C} \leq T_j \leq 125^{\circ}\text{C}$  and  $4.5\text{ V} \leq V_{(\text{IN})} \leq 6.5\text{ V}$ ,  $V_{(\text{EN})} = V_{(\text{CTL1})} = V_{(\text{CTL2})} = V_{(\text{IN})}$ ,  $R_{(\text{FAULT})} = R_{(\text{STATUS})} = 10\text{ k}\Omega$ ,  $R_{(\text{IMON})} = 2.55\text{ k}\Omega$ ,  $R_{(\text{ILIM\_HI})} = 19.1\text{ k}\Omega$ ,  $R_{(\text{ILIM\_LO})} = 80.6\text{ k}\Omega$ . Positive currents are into pins. Typical values are at  $25^{\circ}\text{C}$ . All voltages are with respect to GND.

PARAMETER		TEST CONDITIONS	MIN	TYP	MAX	UNIT
I <sub>os</sub>	OUT short-circuit current limit	R <sub>(ILIM_LO)</sub> = 210 kΩ	190	240	290	mA
		R <sub>(ILIM_LO)</sub> = 80.6 kΩ	555	620	680	
		R <sub>(ILIM_LO)</sub> = 21.5 kΩ	2145	2300	2460	
		R <sub>(ILIM_LO)</sub> = 19.1 kΩ	2420	2590	2760	
		R <sub>(ILIM_HI)</sub> = 18.2 kΩ	2545	2720	2895	
		R <sub>(ILIM_HI)</sub> = 14.3 kΩ	3240	3455	3670	
		R <sub>(ILIM_HI)</sub> = 13.5 kΩ	3435	3660	3890	
		R <sub>(ILIM_HI)</sub> = 11.8 kΩ	3930	4180	4440	
		R <sub>(ILIM_HI)</sub> = 9.6 kΩ	4835	5135	5450	
		R <sub>(ILIM_HI)</sub> shorted to GND	5000	6500	8000	

Unless otherwise noted,  $-40^{\circ}\text{C} \leq T_J \leq 125^{\circ}\text{C}$  and  $4.5\text{ V} \leq V_{(\text{IN})} \leq 6.5\text{ V}$ ,  $V_{(\text{EN})} = V_{(\text{CTL1})} = V_{(\text{CTL2})} = V_{(\text{IN})}$ ,  $R_{(\text{FAULT})} = R_{(\text{STATUS})} = 10\text{ k}\Omega$ ,  $R_{(\text{IMON})} = 2.55\text{ k}\Omega$ ,  $R_{(\text{ILIM\_HI})} = 19.1\text{ k}\Omega$ ,  $R_{(\text{ILIM\_LO})} = 80.6\text{ k}\Omega$ . Positive currents are into pins. Typical values are at  $25^{\circ}\text{C}$ . All voltages are with respect to GND.

PARAMETER		TEST CONDITIONS	MIN	TYP	MAX	UNIT
<b>SUPPLY CURRENT</b>						
$I_{(\text{IN\_OFF})}$	Disabled IN supply current	$V_{(\text{EN})} = 0\text{ V}$ , $V_{(\text{OUT})} = 0\text{ V}$ , $-40^{\circ}\text{C} \leq T_J \leq 85^{\circ}\text{C}$ , no 5.1-k $\Omega$ resistor (open) between BIAS and OUT		0.1	5	$\mu\text{A}$
$I_{(\text{IN\_ON})}$	Enabled IN supply current	SDP mode (CTL1, CTL2 = 0, 1)		170	250	$\mu\text{A}$
		CDP mode (CTL1, CTL2 = 1, 1)		200	280	
		Client mode (CTL1, CTL2 = 0, 0)		120	210	
<b>UNDERVOLTAGE LOCKOUT, IN</b>						
$V_{(\text{UVLO})}$	UVLO threshold voltage	IN rising	3.9	4.1	4.3	V
		IN falling	3.3	3.5	3.7	
<b>FAULT</b>						
	Output low voltage	$I_{(\text{FAULT})} = 1\text{ mA}$			100	mV
	Off-state leakage	$V_{(\text{FAULT})} = 6.5\text{ V}$			2	$\mu\text{A}$
<b>STATUS</b>						
	Output low voltage	$I_{(\text{STATUS})} = 1\text{ mA}$			100	mV
	Off-state leakage	$V_{(\text{STATUS})} = 6.5\text{ V}$			2	$\mu\text{A}$
<b>THERMAL SHUTDOWN</b>						
$T_{(\text{OTSD2})}$	Thermal shutdown threshold		155			$^{\circ}\text{C}$
$T_{(\text{OTSD1})}$	Thermal shutdown threshold in current-limit		135			$^{\circ}\text{C}$
	Hysteresis <sup>(3)</sup>			20		$^{\circ}\text{C}$
<b>LOAD DETECT (<math>V_{\text{CTL1}} = V_{\text{CTL2}} = V_{\text{IN}}</math>)</b>						
$I_{(\text{LD})}$	$I_{\text{OUT}}$ load detection threshold	$R_{(\text{ILIM\_LO})} = 80.6\text{ k}\Omega$ , rising load current	585	650	715	mA
	Hysteresis <sup>(3)</sup>			50		mA
<b>DM_IN AND DP_IN OVERVOLTAGE PROTECTION</b>						
$V_{(\text{OV\_Data})}$	Protection trip threshold	DP_IN and DM_IN rising	3.3	3.9	4.15	V
	Hysteresis <sup>(3)</sup>			100		mV
$R_{(\text{DCHG\_Data})}$	Discharge resistor after OVP <sup>(2)</sup>	DP_IN = DM_IN = 18 V, IN = 5 V or 0 V		200		k $\Omega$
		DP_IN = DM_IN = 5 V, IN = 5 V		370		
		DP_IN = DM_IN = 5 V, IN = 0		390		
<b>OUT OVERVOLTAGE PROTECTION</b>						
$V_{(\text{OV\_OUT\_LOW})}$	Protection trip threshold	OUT rising	5.65	6	6.35	V
	Hysteresis <sup>(3)</sup>			90		mV
$V_{(\text{OV\_OUT\_HIGH})}$	Protection trip threshold	OUT rising	6.6	6.95	7.3	V
	Hysteresis <sup>(3)</sup>			130		mV
$R_{(\text{DCHG\_OUT})}$	Discharge resistor	OUT = 18 V, IN = 5 V		55	85	k $\Omega$
		OUT = 18 V, IN = 0		80	120	
<b>CABLE COMPENSATION</b>						
$I_{(\text{CS})}$	Sink current	Load = 3.2 A, $2.5\text{ V} \leq V_{(\text{CS})} \leq 6.5\text{ V}$	250	262	275	$\mu\text{A}$
		Load = 3 A, $2.5\text{ V} \leq V_{(\text{CS})} \leq 6.5\text{ V}$	234	246	258	
		Load = 2.4 A, $2.5\text{ V} \leq V_{(\text{CS})} \leq 6.5\text{ V}$	187	197	207	
		Load = 2.1 A, $2.5\text{ V} \leq V_{(\text{CS})} \leq 6.5\text{ V}$	163	172	181	
		Load = 1 A, $2.5\text{ V} \leq V_{(\text{CS})} \leq 6.5\text{ V}$	77	82	87	

Unless otherwise noted,  $-40^{\circ}\text{C} \leq T_J \leq 125^{\circ}\text{C}$  and  $4.5\text{ V} \leq V_{(\text{IN})} \leq 6.5\text{ V}$ ,  $V_{(\text{EN})} = V_{(\text{CTL}1)} = V_{(\text{CTL}2)} = V_{(\text{IN})}$ ,  $R_{(\text{FAULT})} = R_{(\text{STATUS})} = 10\text{ k}\Omega$ ,  $R_{(\text{IMON})} = 2.55\text{ k}\Omega$ ,  $R_{(\text{ILIM\_HI})} = 19.1\text{ k}\Omega$ ,  $R_{(\text{ILIM\_LO})} = 80.6\text{ k}\Omega$ . Positive currents are into pins. Typical values are at  $25^{\circ}\text{C}$ . All voltages are with respect to GND.

PARAMETER		TEST CONDITIONS	MIN	TYP	MAX	UNIT
CURRENT MONITOR OUTPUT (IMON)						
$I_{(\text{IMON})}$	Source current	Load = 3.2 A, $0 \leq V_{(\text{IMON})} \leq 2.5\text{ V}$	306	333	359	$\mu\text{A}$
		Load = 3 A, $0 \leq V_{(\text{IMON})} \leq 2.5\text{ V}$	287	312	337	
		Load = 2.4 A, $0 \leq V_{(\text{IMON})} \leq 2.5\text{ V}$	230	250	270	
		Load = 2.1 A, $0 \leq V_{(\text{IMON})} \leq 2.5\text{ V}$	201	218	235	
		Load = 1 A, $0 \leq V_{(\text{IMON})} \leq 2.5\text{ V}$	94	104	114	
		Load = 0.5 A, $0 \leq V_{(\text{IMON})} \leq 2.5\text{ V}$	44	52	60	
HIGH-BANDWIDTH ANALOG SWITCH						
$R_{(\text{HS\_ON})}$	DP and DM switch on-resistance	$V_{(\text{DP\_OUT})} = V_{(\text{DM\_OUT})} = 0\text{ V}$ , $I_{(\text{DP\_IN})} = I_{(\text{DM\_IN})} = 30\text{ mA}$		3.2	6.5	$\Omega$
		$V_{(\text{DP\_OUT})} = V_{(\text{DM\_OUT})} = 2.4\text{ V}$ , $I_{(\text{DP\_IN})} = I_{(\text{DM\_IN})} = -15\text{ mA}$		3.8	7.6	
$ \Delta R_{(\text{HS\_ON})} $	Switch resistance mismatch between DP and DM channels	$V_{(\text{DP\_OUT})} = V_{(\text{DM\_OUT})} = 0\text{ V}$ , $I_{(\text{DP\_IN})} = I_{(\text{DM\_IN})} = 30\text{ mA}$		0.05	0.15	$\Omega$
		$V_{(\text{DP\_OUT})} = V_{(\text{DM\_OUT})} = 2.4\text{ V}$ , $I_{(\text{DP\_IN})} = I_{(\text{DM\_IN})} = -15\text{ mA}$		0.05	0.15	
$C_{(\text{IO\_OFF})}$	DP and DM switch off-state capacitance <sup>(4)</sup>	$V_{\text{EN}} = 0\text{ V}$ , $V_{(\text{DP\_IN})} = V_{(\text{DM\_IN})} = 0.3\text{ V}$ , $V_{\text{ac}} = 0.03\text{ V}_{\text{PP}}$ , $f = 1\text{ MHz}$		8.8		pF
$C_{(\text{IO\_ON})}$	DP and DM switch on-state capacitance <sup>(4)</sup>	$V_{(\text{DP\_IN})} = V_{(\text{DM\_IN})} = 0.3\text{ V}$ , $V_{\text{ac}} = 0.03\text{ V}_{\text{PP}}$ , $f = 1\text{ MHz}$		10.9		pF
	Off-state isolation <sup>(3)</sup>	$V_{(\text{EN})} = 0\text{ V}$ , $f = 250\text{ MHz}$		8		dB
	On-state cross-channel isolation <sup>(4)</sup>	$f = 250\text{ MHz}$		30		dB
$I_{\text{kg}(\text{OFF})}$	Off-state leakage current	$V_{\text{EN}} = 0\text{ V}$ , $V_{(\text{DP\_IN})} = V_{(\text{DM\_IN})} = 3.6\text{ V}$ , $V_{(\text{DP\_OUT})} = V_{(\text{DM\_OUT})} = 0\text{ V}$ , measure $I_{(\text{DP\_OUT})}$ and $I_{(\text{DM\_OUT})}$		0.1	1.5	$\mu\text{A}$
BW	Bandwidth ( - 3 dB) <sup>(4)</sup>	$R_{(\text{L})} = 50\ \Omega$		940		MHz
CHARGING DOWNSTREAM PORT DETECT						
$V_{(\text{DM\_SRC})}$	DM_IN CDP output voltage	$V_{(\text{DP\_IN})} = 0.6\text{ V}$ , $-250\ \mu\text{A} < I_{(\text{DM\_IN})} < 0\ \mu\text{A}$	0.5	0.6	0.7	V
$V_{(\text{DAT\_REF})}$	DP_IN rising lower window threshold for $V_{(\text{DM\_SRC})}$ activation		0.36		0.4	V
	Hysteresis <sup>(4)</sup>			50		mV
$V_{(\text{LGC\_SRC})}$	DP_IN rising upper window threshold for $V_{(\text{DM\_SRC})}$ de-activation		0.8		0.88	V
$V_{(\text{LGC\_SRC\_HYS})}$	Hysteresis <sup>(4)</sup>			100		mV
$I_{(\text{DP\_SINK})}$	DP_IN sink current	$V_{(\text{DP\_IN})} = 0.6\text{ V}$	40	75	100	$\mu\text{A}$

- (1) Pulse-testing techniques maintain junction temperature close to ambient temperature. Thermal effects must be taken into account separately.
- (2) This parameter is provided for reference only and does not constitute part of TI's published device specifications for purposes of TI's product warranty.
- (3) This parameter is provided for reference only and does not constitute part of TI's published device specifications for purposes of TI's product warranty.
- (4) This parameter is provided for reference only and does not constitute part of TI's published device specifications for purposes of TI's product warranty.



## 6.6 Switching Characteristics

Unless otherwise noted  $-40^{\circ}\text{C} \leq T_J \leq 125^{\circ}\text{C}$  and  $4.5\text{ V} \leq V_{(IN)} \leq 6.5\text{ V}$ ,  $V_{(EN)} = V_{(IN)}$ ,  $V_{(CTL1)} = V_{(CTL2)} = V_{(IN)}$ .  $R_{(FAULT)} = R_{(STATUS)} = 10\text{ k}\Omega$ ,  $R_{(IMON)} = 2.55\text{ K}\Omega$ ,  $R_{(ILIM\_HI)} = 19.1\text{ k}\Omega$ ,  $R_{(ILIM\_LO)} = 80.6\text{ k}\Omega$ . Positive currents are into pins. Typical values are at  $25^{\circ}\text{C}$ . All voltages are with respect to GND.

PARAMETER		TEST CONDITIONS	MIN	TYP	MAX	UNIT
$t_r$	OUT voltage rise time	$V_{(IN)} = 5\text{ V}$ , $C_{(L)} = 1\text{ }\mu\text{F}$ , $R_{(L)} = 100\text{ }\Omega$	1.05	1.75	3.1	ms
$t_f$	OUT voltage fall time		0.27	0.47	0.82	ms
$t_{on}$	OUT voltage turnon time	$V_{(IN)} = 5\text{ V}$ , $C_{(L)} = 1\text{ }\mu\text{F}$ , $R_{(L)} = 100\text{ }\Omega$		7.5	11	ms
$t_{off}$	OUT voltage turnoff time			2.7	5	ms
$t_{(DCHG\_S)}$	Discharge hold time (mode change)	Time $V_{(OUT)} < 0.7\text{ V}$	1.1	2	2.9	s
$t_{(IOS)}$	OUT short-circuit response time <sup>(1)</sup>	$V_{(IN)} = 5\text{ V}$ , $R_{(SHORT)} = 50\text{ m}\Omega$		2		$\mu\text{s}$
$t_{(OC\_OUT\_FAULT)}$	OUT FAULT deglitch time	Bidirectional deglitch applicable to current-limit condition only (no deglitch assertion for OTSD)	5.5	8.5	11.5	ms
$t_{pd}$	Analog switch propagation delay <sup>(1)</sup>	$V_{(IN)} = 5\text{ V}$		0.14		ns
$t_{(SK)}$	Analog switch skew between opposite transitions of the same port ( $t_{PHL} - t_{PLH}$ ) <sup>(1)</sup>	$V_{(IN)} = 5\text{ V}$		0.02		ns
$t_{(LD\_SET)}$	Load-detect set time	$V_{(IN)} = 5\text{ V}$	120	210	280	ms
$t_{(LD\_RESET)}$	Load-detect reset time	$V_{(IN)} = 5\text{ V}$	1.8	3	4.2	s
$t_{(OV\_Data)}$	DP_IN and DM_IN overvoltage protection response time			5		$\mu\text{s}$
$t_{(OV\_OUT)}$	OUT overvoltage protection response time			0.3		$\mu\text{s}$
$t_{(OV\_D\_FAULT)}$	DP_IN and DM_IN FAULT-asserted deglitch time		11	16	23	ms
	OUT FAULT-asserted deglitch time		11	16	23	ms

(1) These parameters are provided for reference only and do not constitute part of TI's published device specifications for purposes of TI's product warranty.

### 6.7 Typical Characteristics

$T_A = 25^\circ\text{C}$ ,  $V_{(IN)} = 5\text{ V}$ ,  $V_{(EN)} = 5\text{ V}$ ,  $V_{(CTL1)} = V_{(CTL2)} = 5\text{ V}$ ,  $\overline{\text{FAULT}}$  and  $\overline{\text{STATUS}}$  connect to  $V_{(IN)}$  via a 10-k $\Omega$  pullup resistor (unless stated otherwise)

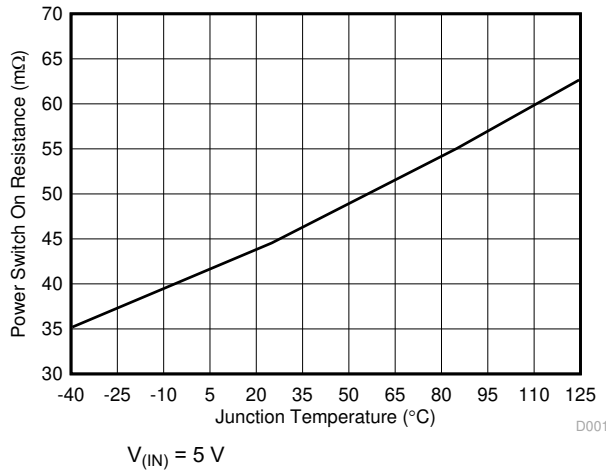

**图 6-1. Power Switch On-Resistance vs Temperature**

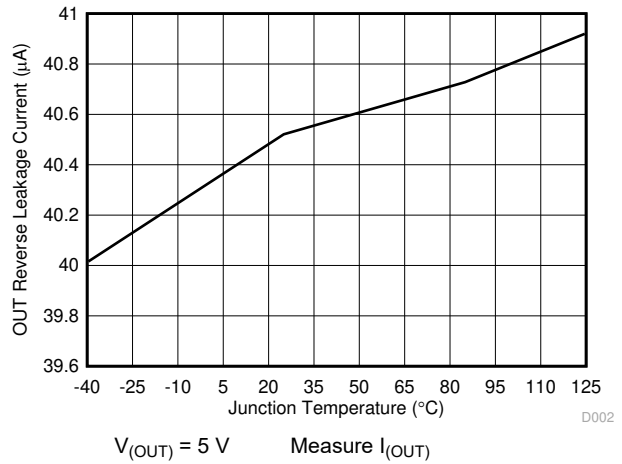

**图 6-2. Reverse Leakage Current vs Temperature**

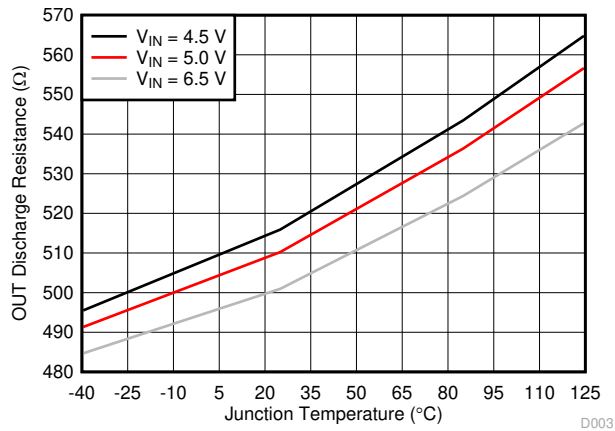

**图 6-3. OUT Discharge Resistance (Mode Change) vs Temperature**

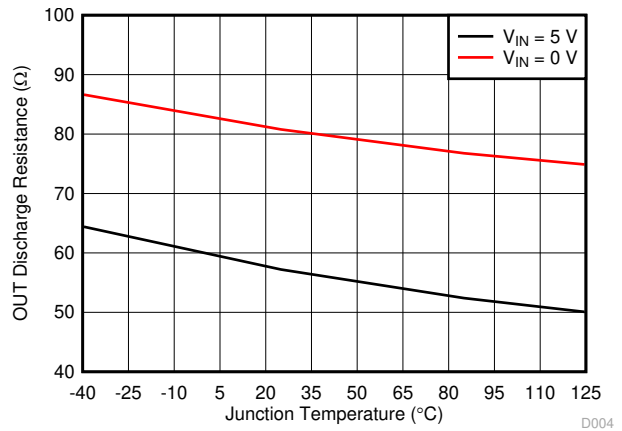

**图 6-4. OUT Discharge Resistance (OVP) vs Temperature**



图 6-5. OUT Short-Circuit Current Limit vs Temperature I



图 6-6. OUT Short-Circuit Current Limit vs Temperature II

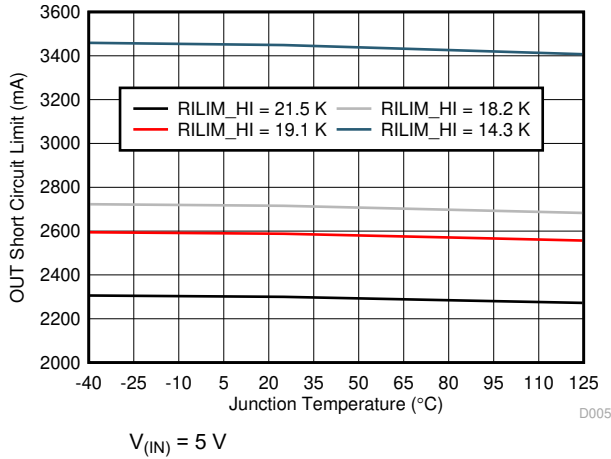

图 6-7. Disabled IN Supply Current vs Temperature

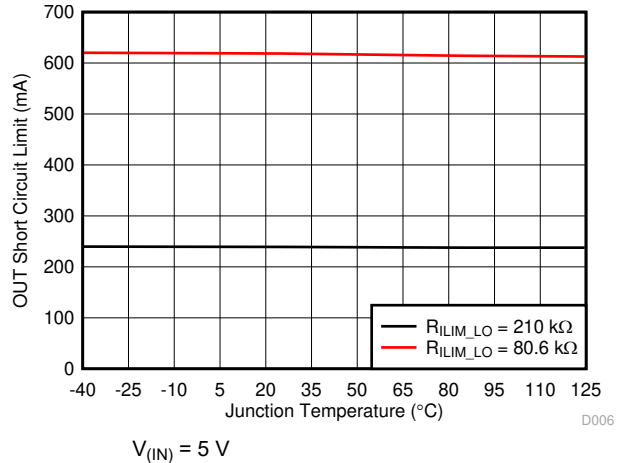

图 6-8. Enabled IN Supply Current - CDP (11) vs Temperature

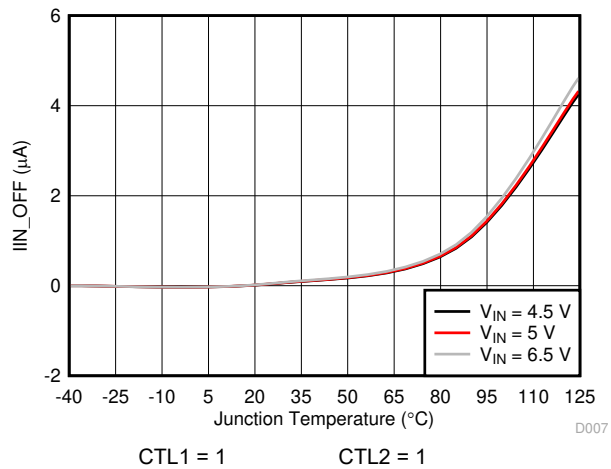

图 6-9. I<sub>(OUT)</sub> Rising Load-Detect Threshold and OUT Short-Circuit Limit vs Temperature

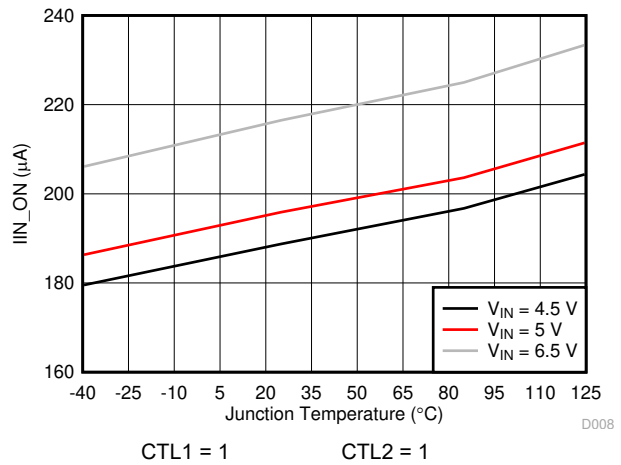

图 6-10. DP\_IN Overvoltage Protection Threshold vs Temperature

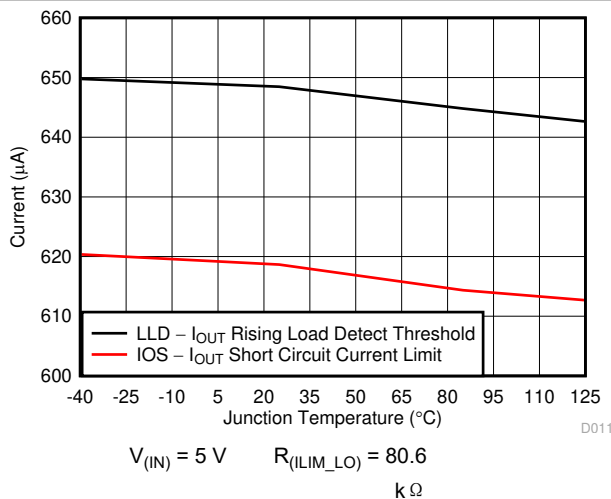

图 6-11. OUT Overvoltage Protection Threshold vs Temperature

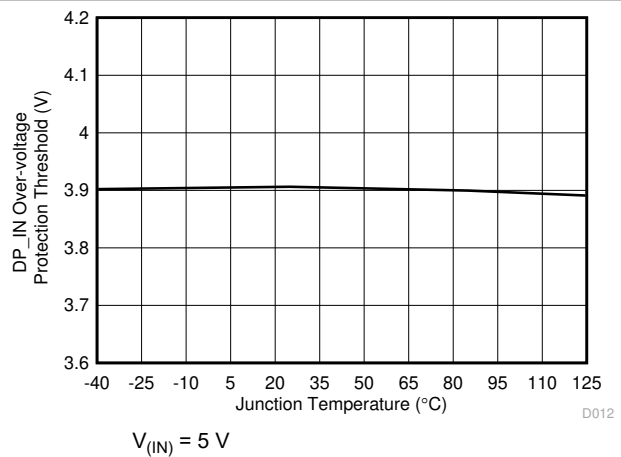

图 6-12. I<sub>(CS)</sub> vs Temperature

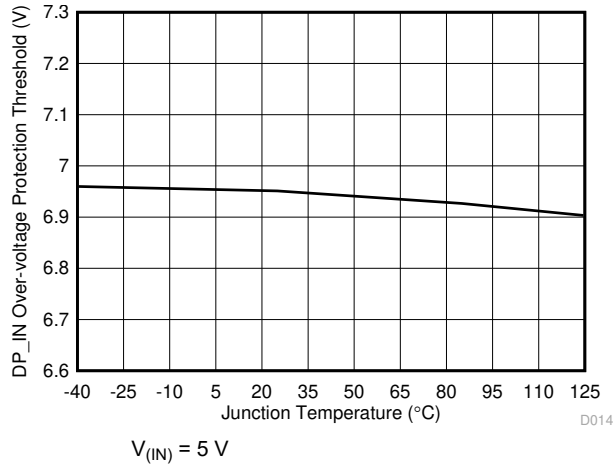

图 6-13. I<sub>(CS)</sub> vs V<sub>(CS)</sub> Voltage

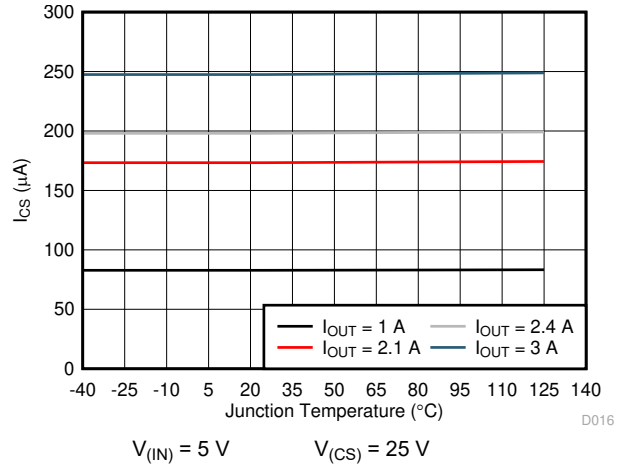

图 6-14. I<sub>(IMON)</sub> vs Temperature

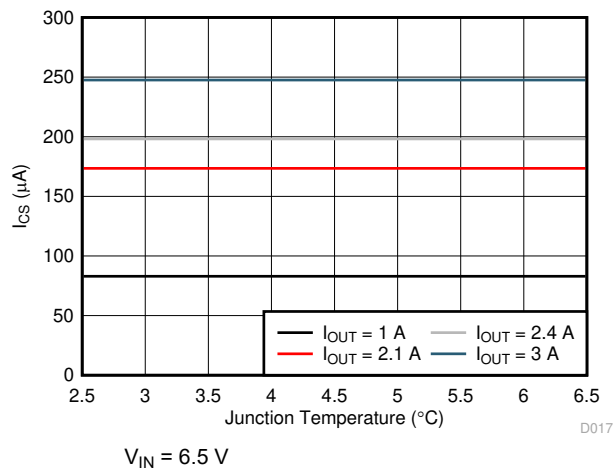

图 6-15. I<sub>(IMON)</sub> vs V<sub>(CS)</sub> Voltage

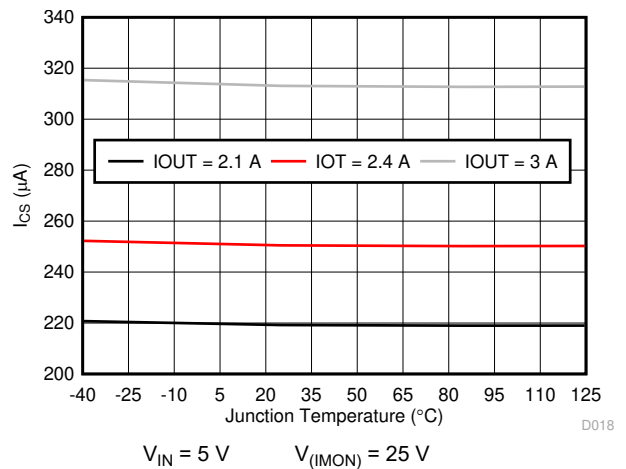

Measured on EVM with 10-cm cable

图 6-16. Bypassing the TPS254900A-Q1 Data Switch

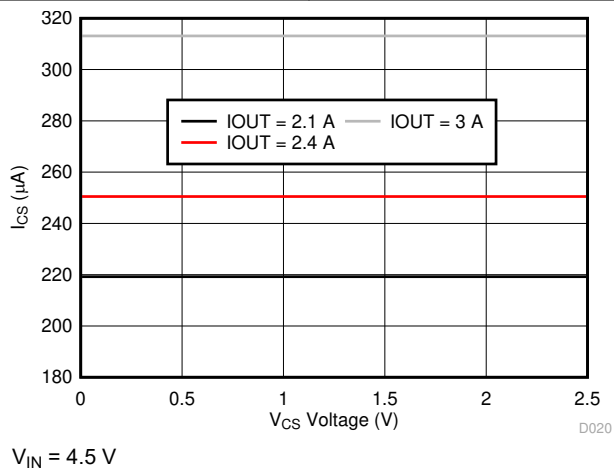
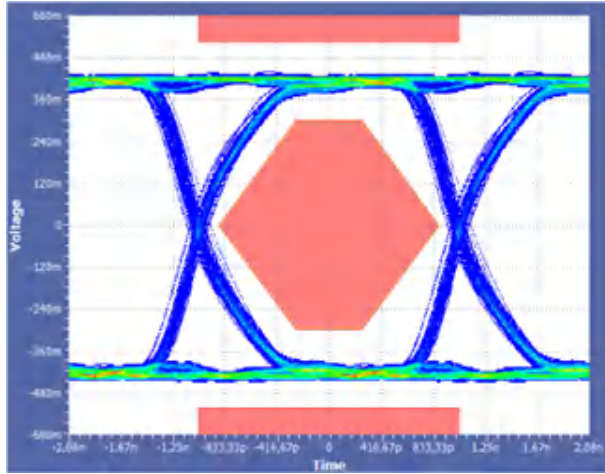
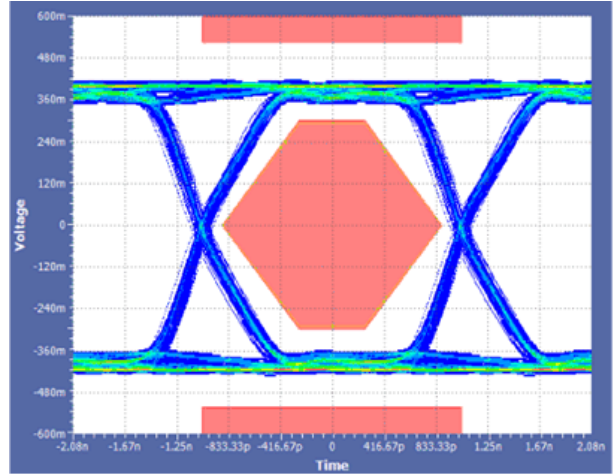

Measured on EVM with 10-cm cable

图 6-17. Through the TPS254900A-Q1 Data Switch



图 6-18. Turnon Response



图 6-19. Turnoff Response

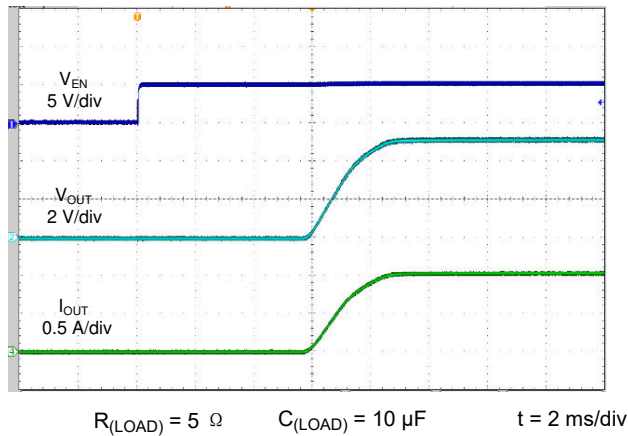

图 6-20. Enable Into Short (SDP)

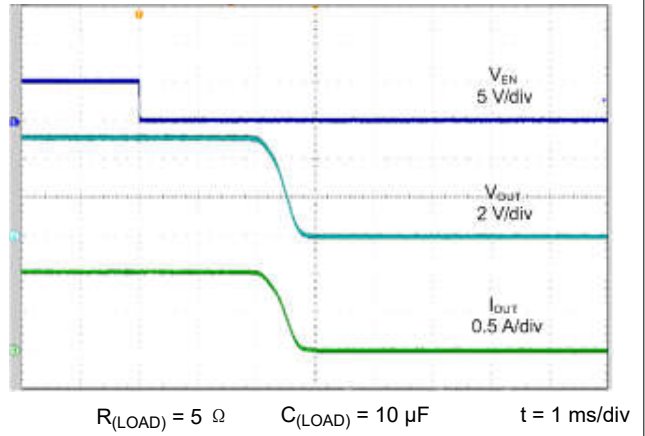

图 6-21. Enable Into Short (CDP) - Thermal Cycling

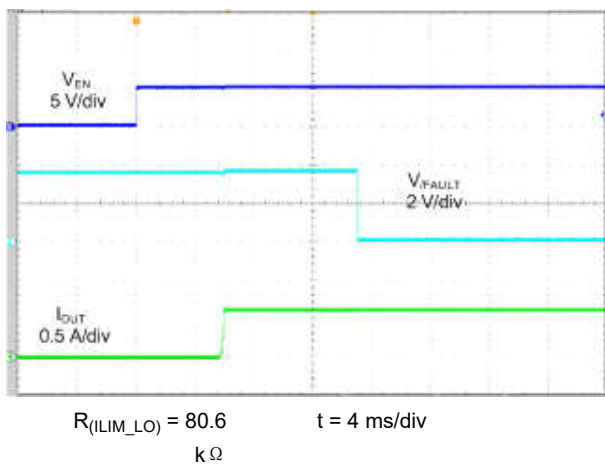

$R_{(ILIM\_LO)} = 80.6 \text{ k}\Omega$

图 6-22. Short Circuit to No Load (SDP)

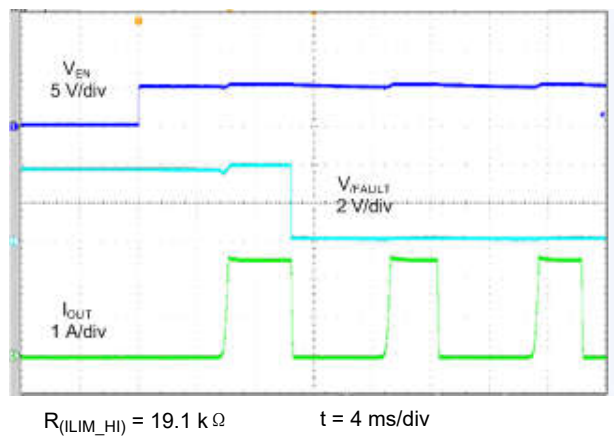
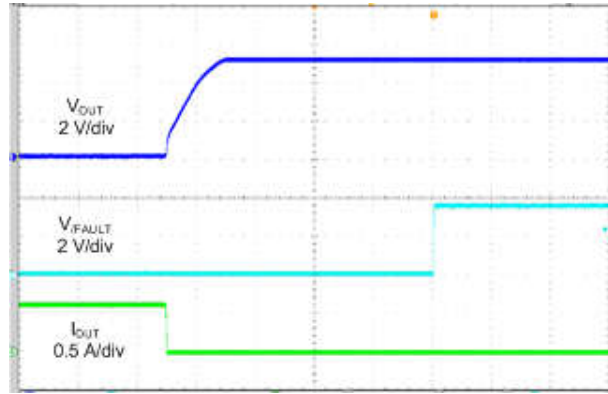
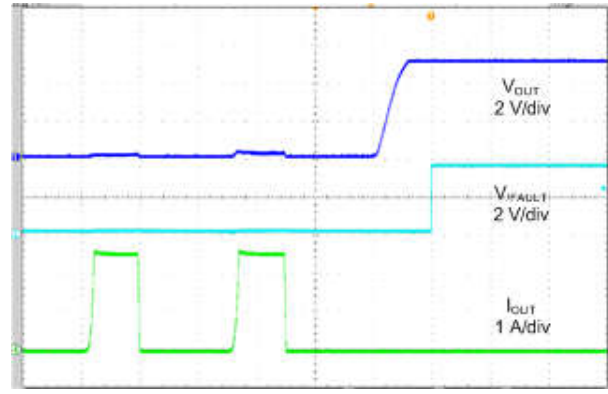

$R_{(ILIM\_HI)} = 19.1 \text{ k}\Omega$

图 6-23. Short Circuit to No Load (CDP)

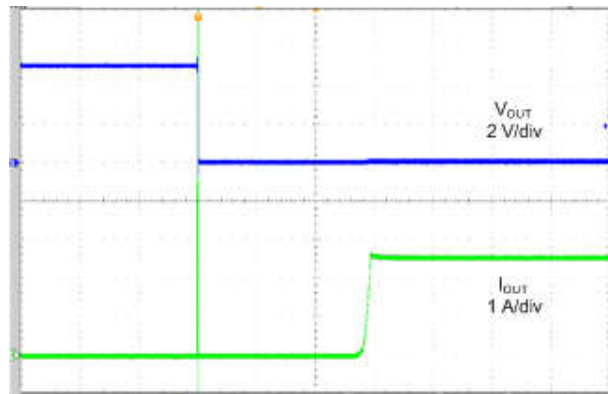

$R_{(ILIM\_HI)} = 19.1 \text{ k}\Omega$      $R_{(short)} = 50 \text{ m}\Omega$      $t = 2 \text{ ms/div}$

图 6-24. Hot Short

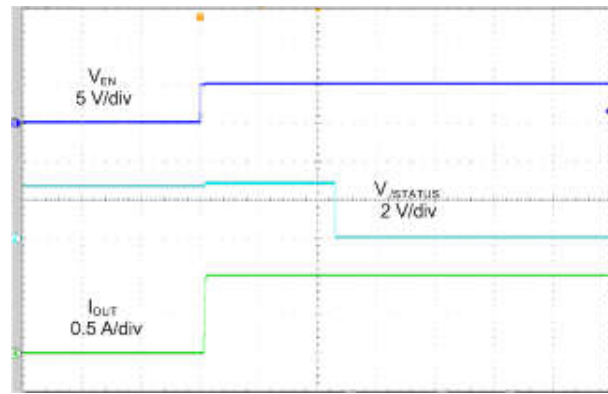

$R_{(ILIM\_LO)} = 80.6 \text{ k}\Omega$      $t = 100 \text{ ms/div}$

图 6-25. Load-Detection Set Time

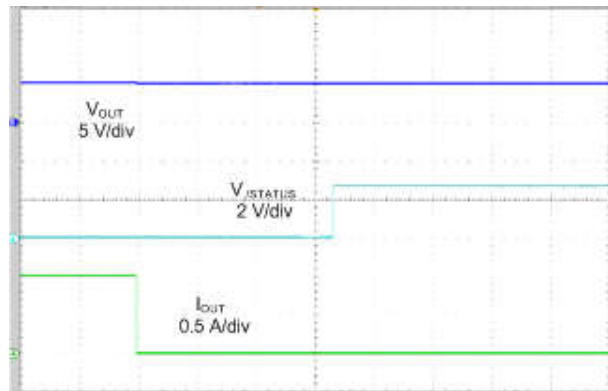

$R_{(ILIM\_LO)} = 80.6 \text{ k}\Omega$

图 6-26. Load-Detection Reset Time



图 6-27. OUT Short to Battery



$t = 100 \text{ ms/div}$   
**图 6-28. OUT Short-to-Battery Recovery**

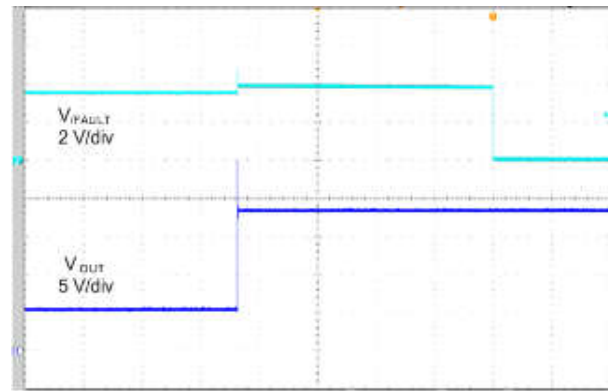
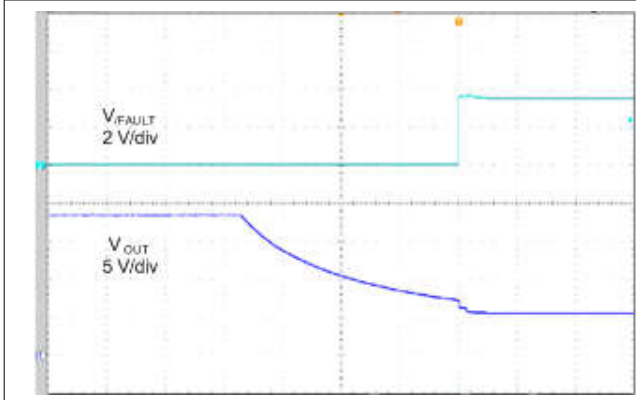
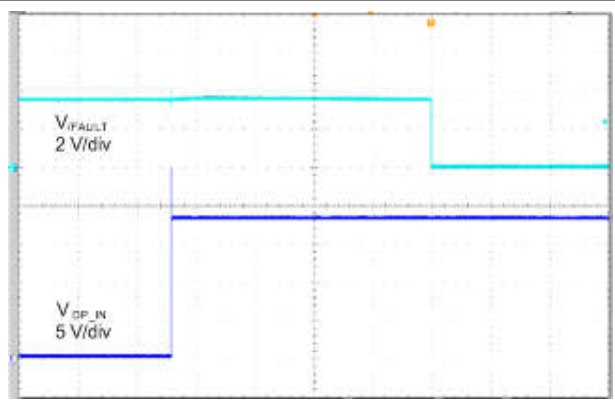

$t = 4 \text{ ms/div}$   
**图 6-29. DP\_IN Short to Battery**

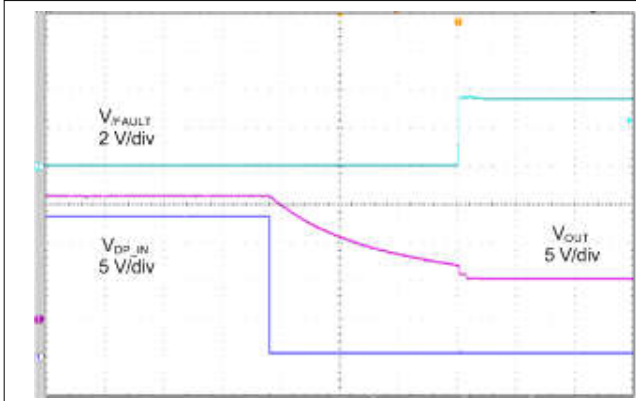

$R_{(BIAS)} = 5.1 \text{ k}\Omega$       $t = 100 \text{ ms/div}$   
**图 6-30. DP\_IN Short-to-Battery Recovery**

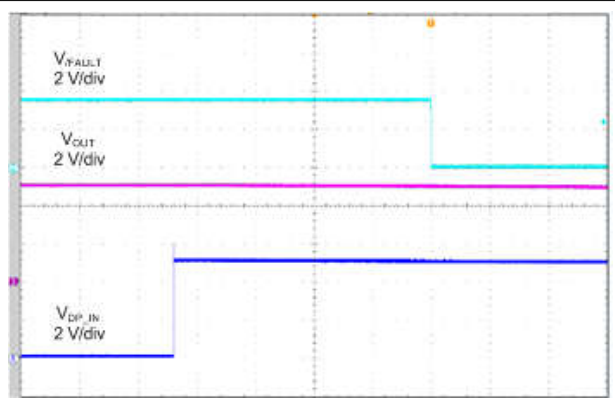

$R_{(BIAS)} = 5.1 \text{ k}\Omega$       $t = 4 \text{ ms/div}$   
**图 6-31. DP\_IN Short to  $V_{BUS}$**

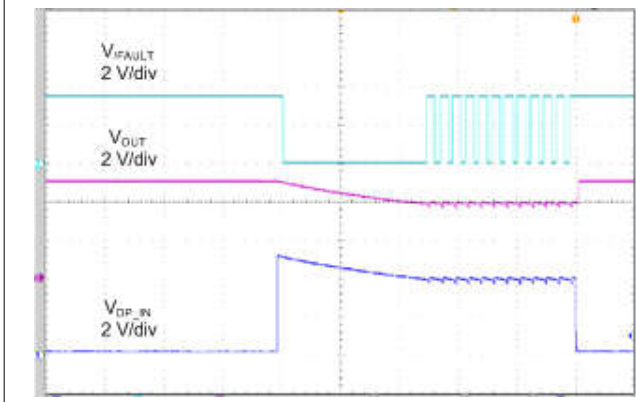

$R_{(BIAS)} = 5.1 \text{ k}\Omega$       $t = 200 \text{ ms/div}$   
**图 6-32. DP\_IN Short-to- $V_{BUS}$  and Recovery**



**图 6-33. Data Transmission Characteristics vs Frequency**



图 6-34. Off-State Data-Switch Isolation vs Frequency



图 6-35. On-State Cross-Channel Isolation vs Frequency

### 7 Parameter Measurement Information

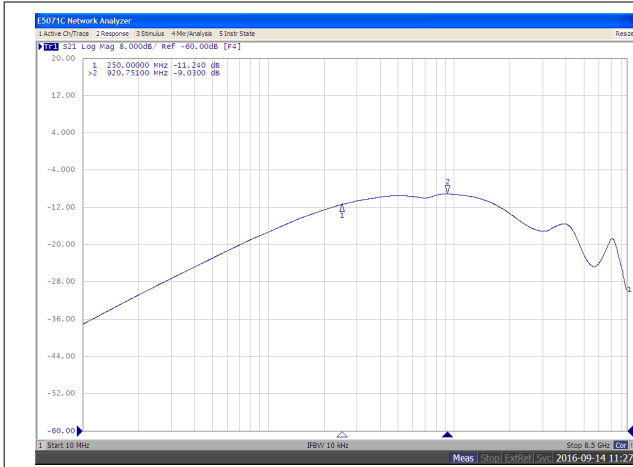

Copyright © 2017, Texas Instruments Incorporated

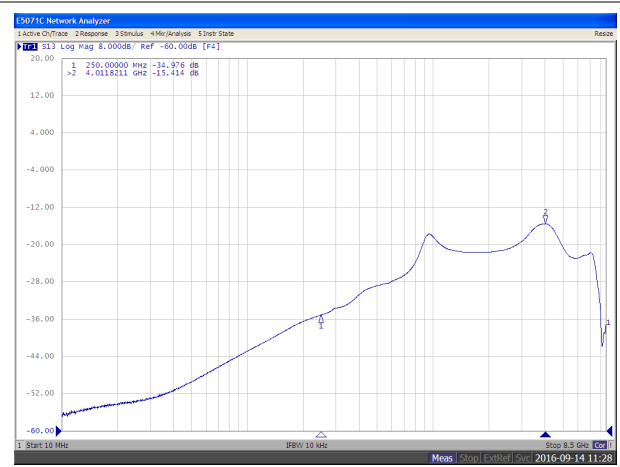
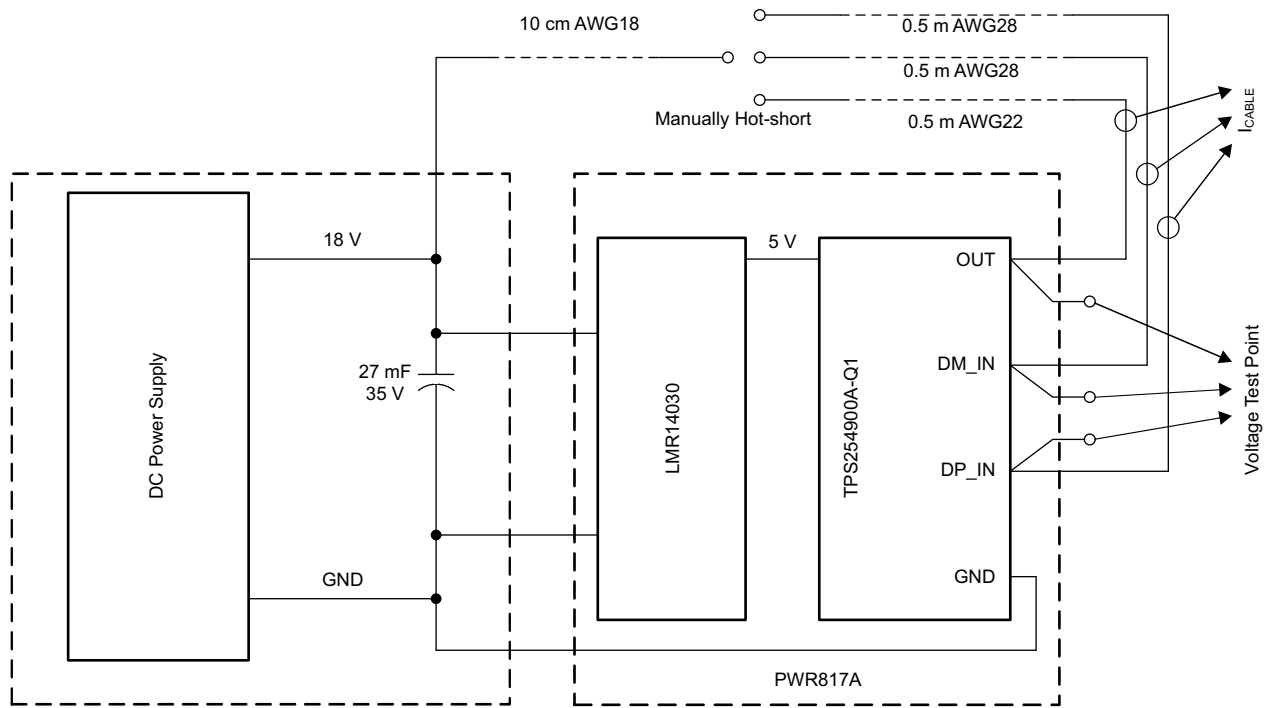
图 7-1. Short-to-Battery System Test Setup



## 8 Detailed Description

### 8.1 Overview

The TPS254900A-Q1 device is a USB charging controller and power switch which integrates D+ and D - short-to-battery protection, cable compensation, current monitor (IMON), and IEC ESD protection suitable for automotive USB charging and USB port protection applications.

The integrated power distribution switch uses N-channel MOSFETs suitable for applications where short circuits or heavy capacitive loads will be encountered. The device allows the user to adjust the current-limit thresholds using external resistors. The device enters constant-current mode when the load exceeds the current-limit threshold.

The TPS254900A-Q1 device provides  $V_{BUS}$ , D+, and D - short-to-battery protection. This protects the upstream voltage regulator, automotive processor, and hub when these pins are exposed to fault conditions.

The device also integrates CDP mode, defined in the BC1.2 specification, to enable up to 1.5-A fast charging of most portable devices during data communication.

The TPS254900A-Q1 device integrates a cable compensation (CS) feature to compensate for long-cable voltage drop. This keeps the remote USB port output voltage constant to enhance the user experience under high-current charging conditions.

The TPS254900A-Q1 device provides a current-monitor function (IMON) by connecting a resistor from the IMON pin to GND to provide a positive voltage linearly with load current. This can be used for system power or dynamic power management.

Additionally, the device provides ESD protection up to  $\pm 8$  kV (contact discharge) and  $\pm 15$  kV (air discharge) per IEC 61000-4-2 on DP\_IN and DM\_IN.

## 8.2 Functional Block Diagram

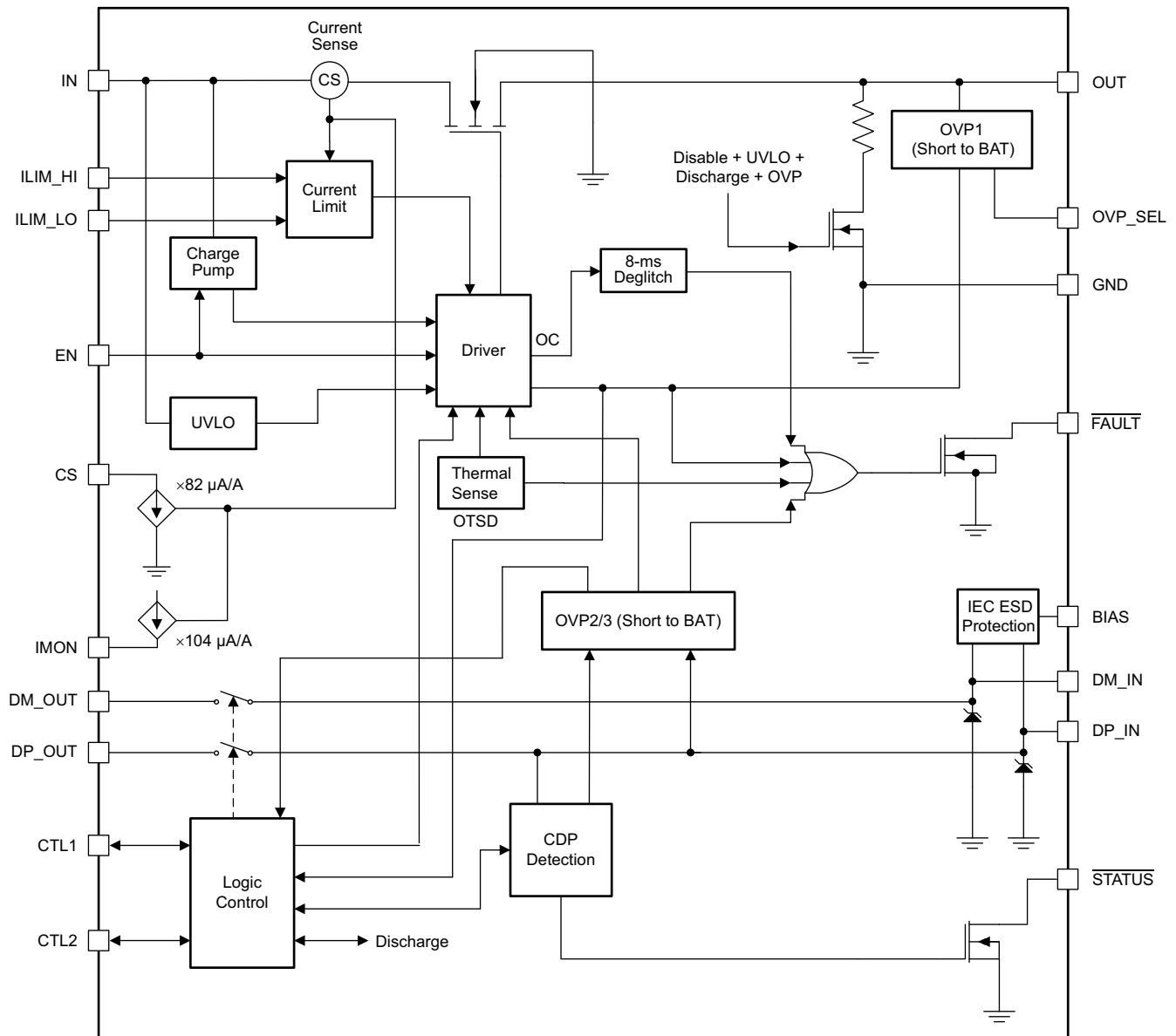

Copyright © 2016, Texas Instruments Incorporated

## 8.3 Feature Description

### 8.3.1 FAULT Response

The device features an active-low, open-drain fault output.  $\overline{\text{FAULT}}$  goes low when there is a fault condition. Fault detection includes overtemperature, overcurrent, or overvoltage on  $V_{\text{BUS}}$ ,  $\text{DP\_IN}$  and  $\text{DM\_IN}$ . Connect a 10-k $\Omega$  pullup resistor from  $\overline{\text{FAULT}}$  to IN.

表 8-1 summarizes the conditions that generate a fault and actions taken by the device.

表 8-1. Fault Conditions

EVENT	CONDITION	ACTION
Overvoltage on the data lines	$V_{(DP\_IN)}$ or $V_{(DM\_IN)} > 3.9\text{ V}$	The device immediately shuts off the USB data switches and the internal power switch. The fault indicator asserts with a 16-ms deglitch, and deasserts without deglitch.
Overvoltage on $V_{(OUT)}$	$V_{(OUT)} > 6\text{ V}$ or $6.95\text{ V}$	The device immediately shuts off the internal power switch and the USB data switches. The fault indicator asserts with a 16-ms deglitch and deasserts without deglitch.
Overcurrent on $V_{(OUT)}$	$I_{(OUT)} > I_{(OS)}$	The device regulates switch current at $I_{(OS)}$ until thermal cycling occurs. The fault indicator asserts and deasserts with an 8-ms deglitch (the device does not assert FAULT on overcurrent in SDP1 mode).
Overtemperature	$T_J > OTSD2$ in non-current-limited or $T_J > OTSD1$ in current-limited mode.	The device immediately shuts off the internal power switch and the USB data switches. The fault indicator asserts immediately when the junction temperature exceeds OTSD2 or OTSD1 while in a current-limiting condition. The device has a thermal hysteresis of $20^\circ\text{C}$ .

### 8.3.2 Cable Compensation

When a load draws current through a long or thin wire, there is an IR drop that reduces the voltage delivered to the load. In the vehicle from the voltage regulator 5-V output to the  $V_{PD\_IN}$  (input voltage of portable device), the total resistance of power switch  $r_{DS(on)}$  and cable resistance causes an IR drop at the PD input. So the charging current of most portable devices is less than their expected maximum charging current.



图 8-1. Voltage Drop

The TPS254900A-Q1 device detects the load current and applies a proportional sink current that can be used to adjust the output voltage of the upstream regulator to compensate for the IR drop in the charging path. The gain  $G_{(CS)}$  of the sink current proportional to load current is  $82\ \mu\text{A/A}$ .

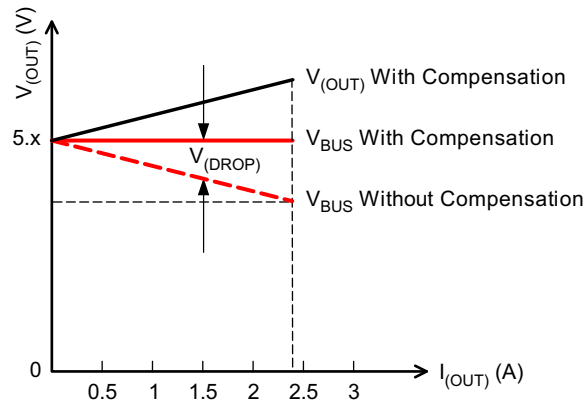

图 8-2. Cable Compensation Equivalent Circuit

### 8.3.2.1 Design Procedure

To start the procedure, the total resistance, including the power switch  $r_{DS(on)}$  and wire resistance  $R_{(WIRE)}$ , must be known.

1. Choose  $R_{(G)}$  following the voltage-regulator feedback resistor-divider design guideline.
2. Calculate  $R_{(FA)}$  according to [方程式 1](#).

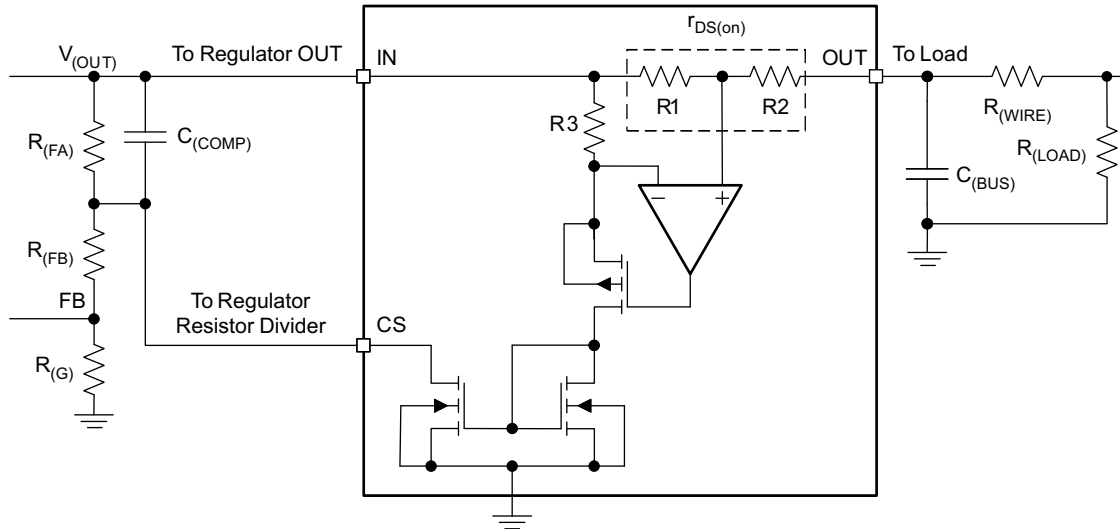
$$R_{FA} = (r_{DS(on)} + R_{(WIRE)}) / G_{(CS)} \quad (1)$$

3. Calculate  $R_{(FB)}$  according to [Equation 2](#).

$$R_{(FB)} = \frac{V_{(OUT)}}{V_{(FB)} / R_{(G)}} - R_{(G)} - R_{(FA)} \quad (2)$$

4.  $C_{(COMP)}$  in parallel with  $R_{(FA)}$  is required to stabilize  $V_{(OUT)}$  when  $C_{(BUS)}$  is large. Start with  $C_{(COMP)} \geq 3 \times G_{(CS)} \times C_{(OUT)}$ , then adjust  $C_{(COMP)}$  to optimize the load transient of the voltage regulator output.  $V_{(OUT)}$  stability should always be verified in the end application circuit.

### 8.3.3 D+ and D - Protection

D+ and D - protection consists of ESD and OVP (overvoltage protection). The DP\_IN and DM\_IN pins provide ESD protection up to  $\pm 15$  kV (air discharge) and  $\pm 8$  kV (contact discharge) per IEC 61000-4-2 (see the [节 6.2](#) section for test conditions).

The ESD stress seen at DP\_IN and DM\_IN is impacted by many external factors, like the parasitic resistance and inductance between ESD test points and the DP\_IN and DM\_IN pins. For air discharge, the temperature and humidity of the environment can cause some difference, so the IEC performance should always be verified in the end-application circuit.

The IEC ESD performance of the TPS254900A-Q1 device depends on the capacitance connected from BIAS to GND. A 2.2- $\mu$ F capacitor placed close to the BIAS pin is recommended. Connect the BIAS pin to OUT using a 5.1-k $\Omega$  resistor as a discharge path for the ESD stress.

OVP protection is provided for short-to- $V_{BUS}$  or short-to-battery conditions in the vehicle harness, preventing damage to the upstream USB transceiver or hub. When the voltage on DP\_IN or DM\_IN exceeds 3.9 V (typical), the TPS254900A-Q1 device quickly responds to block the high-voltage reverse connection to DP\_OUT and DM\_OUT. Overcurrent short-to-GND protection for D+ and D - is provided by the upstream USB transceiver.

### 8.3.4 V<sub>BUS</sub> OVP Protection

The TPS254900A-Q1 OUT pin can withstand up to 18 V. The internal MOSFET turns off quickly when a short-to-battery condition occurs.

The TPS254900A-Q1 device has two OVP thresholds; one is 6 V (typical) and the other is 6.95 V (typical). Set the OVP threshold using the external OVP\_SEL pin.

### 8.3.5 Output and D+ or D - Discharge

To allow a charging port to renegotiate current with a portable device, the TPS254900A-Q1 device uses the OUT discharge function. During mode change, the TPS254900A-Q1 device turns off the power switch while discharging OUT with a 500-Ω resistance, then turning back on the power switches to reassert the OUT voltage.

When an OVP condition occurs on DP\_IN or DM\_IN, the TPS254900A-Q1 device enables an internal 200-kΩ discharge resistance from DP\_IN to ground and from DM\_IN to ground. The analog switches are also turned off. The TPS254900A-Q1 device automatically disables the discharge paths and turns on the analog switches once the OVP condition is removed.

When an OVP condition occurs on OUT, the TPS254900A-Q1 device turns on an internal discharge path (see [表 8-2](#) for the discharge resistance). The TPS254900A-Q1 device automatically turns off the discharge path and turns on the power switch once the OVP condition is removed.

**表 8-2. OUT Discharge Resistance**

VIN <sup>(1)</sup>	EN <sup>(1)</sup>	OVP <sup>(1)</sup>	OUT DISCHARGE RESISTANCE <sup>(2)</sup>
0	0	0	—
0	0	1	80 kΩ
0	1	0	—
0	1	1	80 kΩ
1	0	0	500 Ω
1	0	1	500 Ω or 55 kΩ
1	1	0	—
1	1	1	55 kΩ

(1) 0 = inactive, 1 = active

(2) — = no discharge resistance

### 8.3.6 Port Power Management (PPM)

PPM is the intelligent and dynamic allocation of power. PPM is for systems that have multiple charging ports but cannot power them all simultaneously.

#### 8.3.6.1 Benefits of PPM

The benefits of PPM include the following:

- Delivers better user experience
- Prevents overloading of system power supply
- Allows for dynamic power limits based on system state
- Allows every port potentially to be a high-power charging port
- Allows for smaller power-supply capacity because loading is controlled

#### 8.3.6.2 PPM Details

All ports are allowed to broadcast high-current charging. The current limit is based on ILIM\_HI. The system monitors the  $\overline{\text{STATUS}}$  pin to see when high-current loads are present. Once the allowed number of ports asserts  $\overline{\text{STATUS}}$ , the remaining ports are toggled to a non-charging port. The current limit of the non-charging port is

based on the ILIM\_LO setting. The non-charging ports are automatically toggled back to charging ports when a charging port deasserts STATUS.

STATUS asserts in a charging port when the load current is above ILIM\_LO + 30 mA for 210 ms (typical). STATUS deasserts in a charging port when the load current is below ILIM\_LO - 20 mA for 3 seconds (typical).

### 8.3.6.3 Implementing PPM in a System With Two Charging Ports (CDP and SDP1)

Figure 8-3 shows the implementation of the two charging ports with data communication, each with a TPS254900A-Q1 device and configured in CDP mode. In this example, the 5-V power supply for the two charging ports is rated at less than 3.5 A. Both TPS254900A-Q1 devices have R<sub>(ILIM)</sub> chosen to correspond to the low (1-A) and high (2.4-A) current-limit setting for the port. In this implementation, the system can support only one of the two ports at 2.4-A charging current, whereas the other port is set to the SDP1 mode and I<sub>OS</sub> corresponds to 1 A.

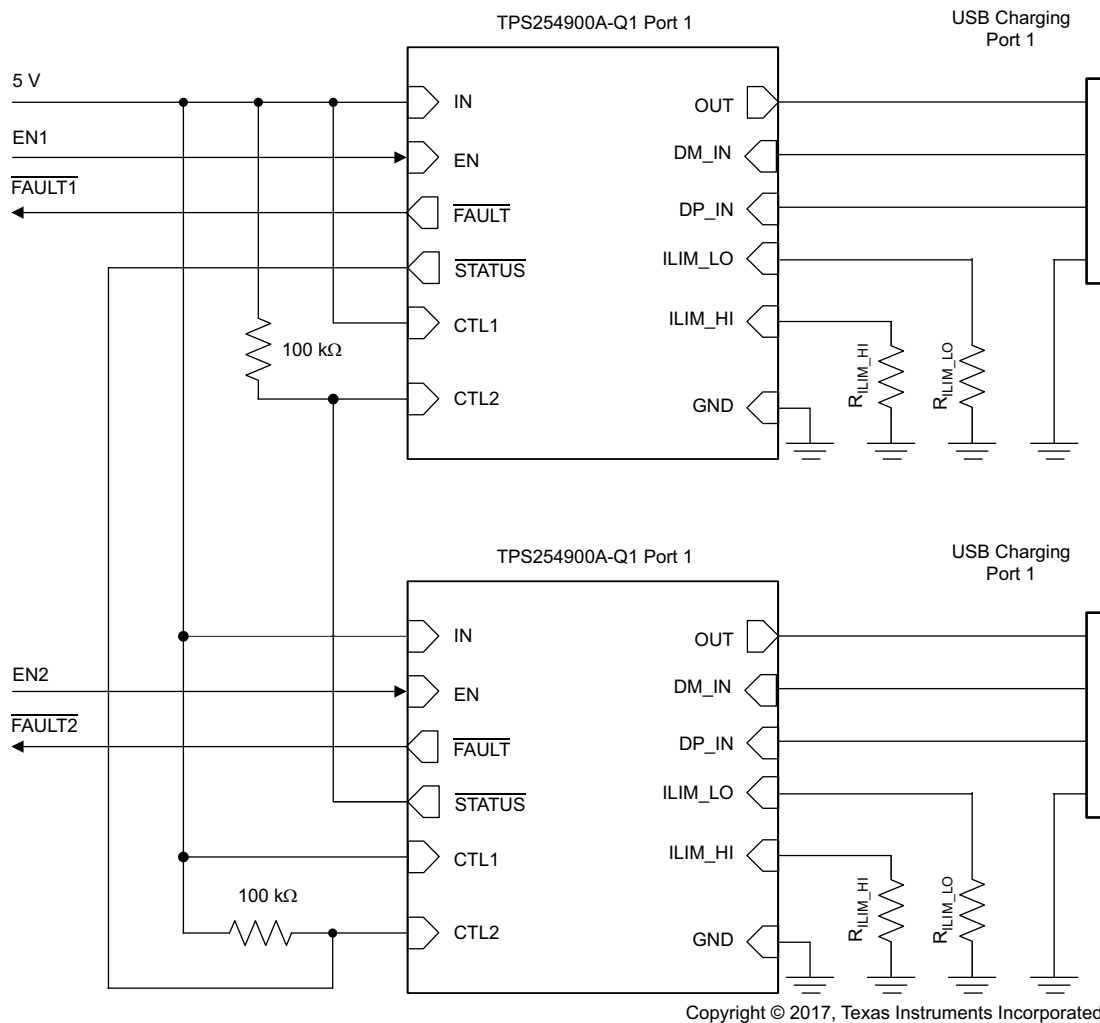

Figure 8-3. PPM Between CDP and SDP1

### 8.3.7 Overcurrent Protection

When an overcurrent condition is detected, the device maintains a constant output current and reduces the output voltage accordingly. Two possible overload conditions can occur. In the first condition, the output is shorted before the device is enabled or before the application of V<sub>(IN)</sub>. The TPS254900A-Q1 device senses the short and immediately switches into a constant-current output. In the second condition, a short or an overload occurs while the device is enabled. At the instant the overload occurs, high currents flow for 1 to 2 μs (typical) before the current-limit circuit reacts. The device operates in constant-current mode after the current-limit circuit

has responded. Complete shutdown occurs only if the fault is present long enough to activate thermal limiting. The device remains off until the junction temperature cools approximately 20°C and then restarts. The device continues to cycle on and off until the overcurrent condition is removed.

### 8.3.8 Undervoltage Lockout

The undervoltage-lockout (UVLO) circuit disables the power switch until the input voltage reaches the UVLO turnon threshold. Built-in hysteresis prevents unwanted oscillations on the output due to input voltage drop from large current surges.

### 8.3.9 Thermal Sensing

Two independent thermal-sensing circuits protect the TPS254900A-Q1 device if the temperature exceeds recommended operating conditions. These circuits monitor the operating temperature of the power-distribution switch and disable operation. The power dissipation in the package is proportional to the voltage drop across the power switch, so the junction temperature rises during an overcurrent condition. The first thermal sensor turns off the power switch when the die temperature exceeds 135°C and the device is in current limit. The second thermal sensor turns off the power switch when the die temperature exceeds 155°C regardless of whether the power switch is in current limit. Hysteresis is built into both thermal sensors, and the switch turns on after the device has cooled by approximately 20°C. The switch continues to cycle off and then on until the fault is removed. The open-drain false-reporting output, FAULT, is asserted (low) during an overtemperature shutdown condition.

### 8.3.10 Current-Limit Setting

The TPS254900A-Q1 has two independent current-limit settings that are each adjusted externally with a resistor. The ILIM\_HI setting is adjusted with  $R_{(ILIM\_HI)}$  connected between ILIM\_HI and GND. The ILIM\_LO setting is adjusted with  $R_{(ILIM\_LO)}$  connected between ILIM\_LO and GND. Consult the device truth table (表 8-3) to see when each current limit is used. Both settings have the same relation between the current limit and the adjusting resistor.

The following equation calculates the value of resistor for adjusting the typical current limit:

$$I_{OS(nom)} \text{ (mA)} = \frac{48687 \text{ V}}{R_{(ILIM\_xx)}^{0.9945} \text{ k}\Omega} \quad (3)$$

Many applications require that the current limit meet specific tolerance limits. When designing to these tolerance limits, both the tolerance of the TPS254900A-Q1 current limit and the tolerance of the external adjusting resistor must be taken into account. The following equations approximate the TPS254900A-Q1 minimum and maximum current limits to within a few milliamperes and are appropriate for design purposes. The equations do not constitute part of TI's published device specifications for purposes of TI's product warranty. These equations assume an ideal—no variation—external adjusting resistor. To take resistor tolerance into account, first determine the minimum and maximum resistor values based on its tolerance specifications and use these values in the equations. Because of the inverse relation between the current limit and the adjusting resistor, use the maximum resistor value in the  $I_{OS(min)}$  equation and the minimum resistor value in the  $I_{OS(max)}$  equation.

$$I_{OS(min)} \text{ (mA)} = \frac{46464 \text{ V}}{R_{(ILIM\_xx)}^{0.9974} \text{ k}\Omega} - 32 \quad (4)$$

$$I_{OS(max)} \text{ (mA)} = \frac{51820 \text{ V}}{R_{(ILIM\_xx)}^{0.9987} \text{ k}\Omega} + 38 \quad (5)$$

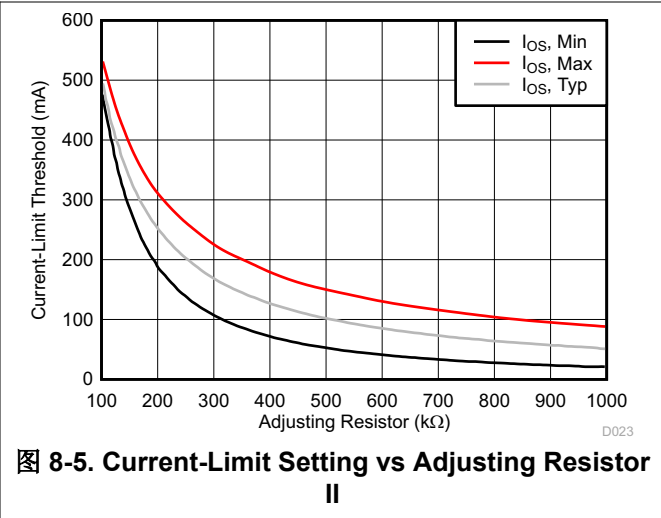
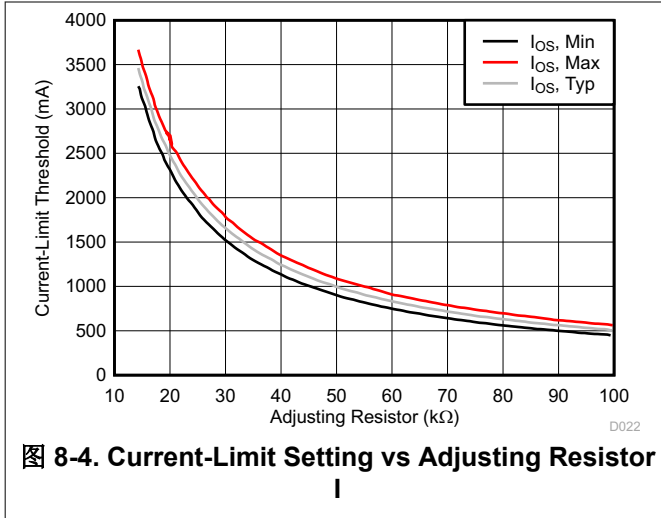

The routing of the traces to the  $R_{(ILIM\_xx)}$  resistors should have a sufficiently low resistance so as not to affect the current-limit accuracy. The ground connection for the  $R_{(ILIM\_xx)}$  resistors is also very important. The resistors must reference back to the TPS254900A-Q1 GND pin. Follow normal board layout practices to ensure that current flow from other parts of the board does not impact the ground potential between the resistors and the TPS254900A-Q1 GND pin.

## 8.4 Device Functional Modes

### 8.4.1 Device Truth Table (TT)

The device truth table (表 8-3) lists all valid combinations for both control pins (CTL1 and CTL2), and the corresponding charging mode. The TPS254900A-Q1 device monitors the CTL inputs and transitions to the charging mode to which it is commanded.

表 8-3. Truth Table

CTL1	CTL2	CURRENT LIMIT SELECTED	MODE	STATUS FOR LOAD DETECT	CS FOR CABLE COMPENSATION	IMON FOR CURRENT MONITOR	FAULT REPORT	NOTES
0	0	N/A	Client mode <sup>(1)</sup>	OFF	OFF	OFF	OFF	Power switch is disabled, only analog switch is on.
0	1	ILIM_LO	SDP	OFF	ON	ON	ON	Standard SDP
1	0	ILIM_LO	SDP1 <sup>(2)</sup>	OFF	ON	ON	ON <sup>(3)</sup>	No OUT discharge between CDP and SDP1 for PPM
1	1	ILIM_HI	CDP <sup>(2)</sup>	ON	ON	ON	ON	

- (1) No 5.1-kΩ resistor from BIAS to OUT (open between the pins), or OUT still has 5-V voltage from an external downstream port; client mode is still active.
- (2) No OUT discharge when changing from 10 to 11 or from 11 to 10.
- (3) A fault only trips OTSD, OUT, DP\_IN, DM\_IN, and OVP.

### 8.4.2 USB BC1.2 Specification Overview

The BC1.2 specification includes three different port types:

- Standard downstream port (SDP)
- Charging downstream port (CDP)
- Dedicated charging port (DCP)



BC1.2 defines a charging port as a downstream-facing USB port that provides power for charging portable equipment. Under this definition, CDP and DCP are defined as charging ports.

表 8-4 lists the difference between these port types.

**表 8-4. Operating Modes Table**

PORT TYPE	SUPPORTS USB 2.0 COMMUNICATION	MAXIMUM ALLOWABLE CURRENT DRAWN BY PORTABLE EQUIPMENT (A)
SDP (USB 2.0)	YES	0.5
SDP (USB 3.0)	YES	0.9
CDP	YES	1.5
DCP	NO	1.5

### 8.4.3 Standard Downstream Port (SDP) Mode — USB 2.0 and USB 3.0

An SDP is a traditional USB port that follows the USB 2.0 or USB 3.0 protocol. An SDP supplies a minimum of 500 mA per port for USB 2.0 and 900 mA per port for USB 3.0. USB 2.0 and USB 3.0 communication is supported, and the host controller must be active to allow charging.

### 8.4.4 Charging Downstream Port (CDP) Mode

A CDP is a USB port that follows the USB BC1.2 specification and supplies a minimum of 1.5 A per port. A CDP provides power and meets the USB 2.0 requirements for device enumeration. USB 2.0 communication is supported, and the host controller must be active to allow charging. The difference between CDP and SDP is the host-charge handshaking logic that identifies this port as a CDP. A CDP is identifiable by a compliant BC1.2 client device and allows for additional current draw by the client device.

The CDP handshaking process occurs in two steps. During the first step, the portable equipment outputs a nominal 0.6-V output on the D+ line and reads the voltage input on the D - line. The portable device detects the connection to an SDP if the voltage is less than the nominal data-detect voltage of 0.3 V. The portable device detects the connection to a CDP if the D - voltage is greater than the nominal data-detect voltage of 0.3 V and optionally less than 0.8 V.

The second step is necessary for portable equipment to determine whether the equipment is connected to a CDP or a DCP. The portable device outputs a nominal 0.6-V output on the D - line and reads the voltage input on the D+ line. The portable device concludes the equipment is connected to a CDP if the data line being read remains less than the nominal data detects voltage of 0.3 V. The portable device concludes it is connected to a DCP if the data line being read is greater than the nominal data-detect voltage of 0.3 V.

The TPS254900A-Q1 device integrates CDP detection protocol, used at a downstream port as the CDP controller to support CDP portable-device fast charge up to 1.5 A.

### 8.4.5 Client Mode

The TPS254900A-Q1 device integrates client mode as shown in  8-6. The internal power switch is OFF to block current flow from OUT to IN, and the signal switches are ON. This mode can be used for software upgrades from the USB port.

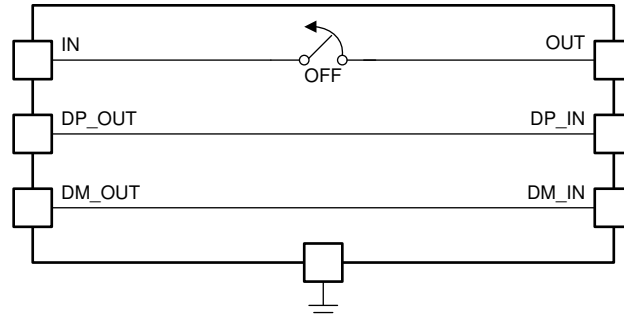

Copyright © 2016, Texas Instruments Incorporated

**图 8-6. Client-Mode Equivalent Circuit**

Passing the IEC 61000-4-2 test for DP\_IN and DM\_IN requires connecting a discharge resistor to OUT during USB 2.0 high-speed enumeration. In client mode, because the power switch is OFF, OUT must be 5 V so that the device can work normally (usually powered by an external downstream USB port). If the OUT voltage is low, the communication may not work properly.

#### 8.4.6 High-Bandwidth Data-Line Switch

The D+ and D- data lines pass through the device to enable monitoring and handshaking while supporting the charging operation. A wide-bandwidth signal switch allows data to pass through the device without corrupting signal integrity. The data-line switches are turned on in any of the CDP, SDP or client operating modes. The EN input must be at logic high for the data-line switches to be enabled.

#### 备注

- While in CDP mode, the data switches are ON, even during CDP handshaking.
- The data switches are only for the USB-2.0 differential pair. In the case of a USB-3.0 host, the super-speed differential pairs must be routed directly to the USB connector without passing through the TPS254900A-Q1 device.
- Data switches are OFF during OUT ( $V_{BUS}$ ) discharge.

## 9 Application and Implementation

### 备注

Information in the following applications sections is not part of the TI component specification, and TI does not warrant its accuracy or completeness. TI's customers are responsible for determining suitability of components for their purposes. Customers should validate and test their design implementation to confirm system functionality.

### 9.1 Application Information

The TPS254900A-Q1 device is a USB charging-port controller and power switch with cable compensation and short-to-battery protection for  $V_{BUS}$ , D+, and D-. The device is typically used for automotive USB port protection and as a USB charging controller. The following design procedure can be used to select components for the TPS254900A-Q1 device. This section presents a simplified discussion of how to choose external components for  $V_{BUS}$ , D+, and D- short-to-battery protection. For cable-compensation design information, see the data sheet (SLUSCE3) for the TPS2549-Q1 device, which has features and design considerations very similar to those of the TPS254900A-Q1 device.

### 9.2 Typical Application

For an automotive USB charging port, the  $V_{BUS}$ , D+, and D- pins are exposed and require a protection device. The protection required includes  $V_{BUS}$  overcurrent, D+ and D- ESD protection, and short-to-battery protection. This charging-port device protects the upstream dc-dc converter (bus line) and automotive SOC or hub chips (D+ and D- data lines). An application schematic of this circuit with short-to-battery protection is shown in [图 9-1](#).

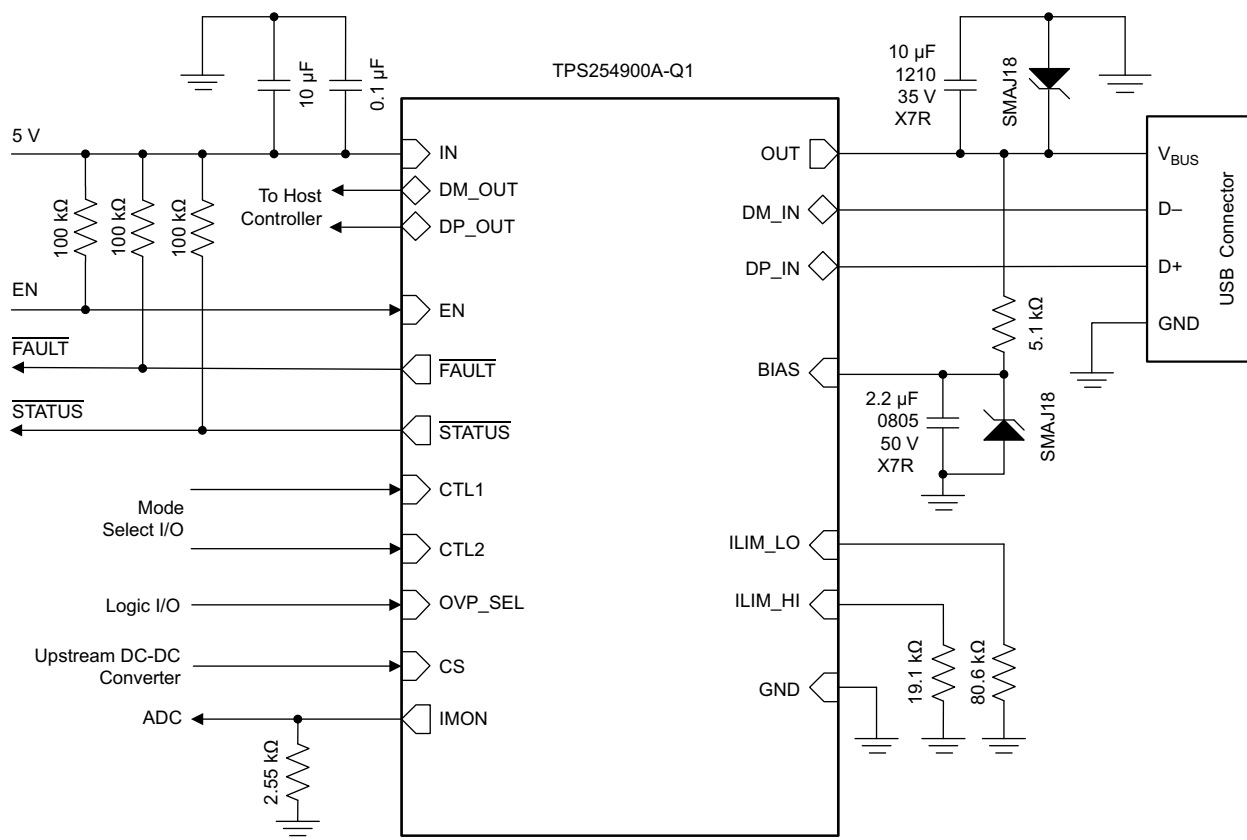

Copyright © 2017, Texas Instruments Incorporated

图 9-1. Typical Application Schematic: USB Port Charging With Cable Compensation

## 9.2.1 Design Requirements

For this design example, use the following as the input parameters.

DESIGN PARAMETER	EXAMPLE VALUE
Battery voltage, $V_{(BAT)}$	18 V
Short-circuit cable	0.5 m

## 9.2.2 Detailed Design Procedure

To begin the design process, the designer must know the following:

- The battery voltage
- The short-circuit cable length
- The maximum continuous output current for the charging port. The minimum current-limit setting of TPS254900A-Q1 device must be higher than this current.
- The maximum output current of the upstream dc-dc converter. The maximum current-limit setting of TPS254900A-Q1 device must be lower than this current.
- For cable compensation, the total resistance including power switch  $r_{DS(on)}$ , cable resistance, and connector contact resistance must be specified.

### 9.2.2.1 Input Capacitance

Consider the following application situations when choosing the input capacitors.

For all applications, TI recommends a 0.1- $\mu$ F or greater ceramic bypass capacitor between IN and GND, placed as close as possible to the device for local noise decoupling.

During output short or hot plug-in of a capacitive load, high current flows through the TPS254900A-Q1 device back to the upstream dc-dc converter until the TPS254900A-Q1 device responds (after  $t_{(IOS)}$ ). During this response time, the TPS254900A-Q1 input capacitance and the dc-dc converter output capacitance source current to keep  $V_{IN}$  above the UVLO of the TPS254900A-Q1 device and any shared circuits. Size the input capacitance for the expected transient conditions and keep the path between the TPS254900A-Q1 device and the dc-dc converter short to help minimize voltage drops.

Input voltage overshoots can be caused by either of two effects. The first cause is an abrupt application of input voltage in conjunction with input power-bus inductance and input capacitance when the IN pin is in the high-impedance state (before turnon). Theoretically, the peak voltage is 2 times the applied voltage. The second cause is due to the abrupt reduction of output short-circuit current when the TPS254900A-Q1 device turns off and energy stored in the input inductance drives the input voltage high. Applications with large input inductance (for example, a connection between the evaluation board and the bench power supply through long cables) may require large input capacitance to prevent the voltage overshoot from exceeding the absolute-maximum voltage of the device.

During the short-to-battery (EN = HIGH) condition, the input voltage follows the output voltage until OVP protection is triggered ( $t_{(OV\_OUT)}$ ). After the TPS254900A-Q1 device responds and turns off the power switch, the stored energy in the input inductance can cause ringing.

Based on the three situations described, 10- $\mu$ F and 0.1- $\mu$ F low-ESR ceramic capacitors, placed close to the input, are recommended.

### 9.2.2.2 Output Capacitance

Consider the following application situations when choosing the output capacitors.

After an output short occurs, the TPS254900A-Q1 device abruptly reduces the OUT current, and the energy stored in the output power-bus inductance causes voltage undershoot and potentially reverse voltage as it discharges.

Applications with large output inductance (such as from a cable) benefit from the use of a high-value output capacitor to control the voltage undershoot.

For USB port applications, because the  $V_{BUS}$  pin is exposed to IEC61000-4-2 level-4 ESD, use a low-ESR capacitance to protect OUT.

The TPS254900A-Q1 device is capable of handling up to 18-V battery voltage. When  $V_{BUS}$  is shorted to the battery, the LCR tank circuit formed can induce ringing. The peak voltage seen on the OUT pin depends on the short-circuit cable length. The parasitic inductance and resistance varies with length, causing the damping factor and peak voltage to differ. Longer cables with larger resistance reduce the peak current and peak voltage. Consider high-voltage derating for the ceramic capacitor, because the peak voltage can be higher than twice the battery voltage.

Based on the three situations described, a 10- $\mu$ F, 35-V, X7R, 1210 low-ESR ceramic capacitor placed close to OUT is recommended. If the battery voltage is 16 V and a 16-V transient voltage suppressor (TVS) is used, then the capacitor voltage can be reduced to 25 V. Considering temperature variation, placing an additional 35-V aluminum electrolytic capacitor can lower the peak voltage and make the system more robust.

### 9.2.2.3 BIAS Capacitance

The capacitance on the BIAS pin helps the IEC ESD performance on the DM\_IN and DP\_IN pins.

When a short to battery on DP\_IN, DM\_IN and/or OUT occurs, high voltage can be seen on the BIAS pin. Place a 2.2- $\mu$ F, 50-V, X7R, 0805, low-ESR ceramic capacitor close to the BIAS pin. The whole current path from BIAS to GND should be as short as possible. Additionally, use a 5.1-k $\Omega$  discharge resistor from BIAS to OUT.

### 9.2.2.4 Output and BIAS TVS

The TPS254900A-Q1 device can withstand high transient voltages due to LCR tank ringing, but in order to make OUT, DP\_IN, and DM\_IN robust, place one TVS close to the OUT pin, and another TVS close to the BIAS pin. When choosing the TVS, the reverse standoff voltage  $V_R$  depends on the battery voltage (16 V or 18 V). Considering the peak pulse power capability, a 400-W device is recommended such as an SMAJ16 for a 16-V battery or an SMAJ18 for an 18-V battery.

## 9.2.3 Application Curves



图 9-2. Disabled, 25-V, 1206, X7R  $C_{OUT}$  Capacitor Without SMAJ18



图 9-3. Disabled, 35-V, 1210, X7R  $C_{OUT}$  Capacitor Without SMAJ18

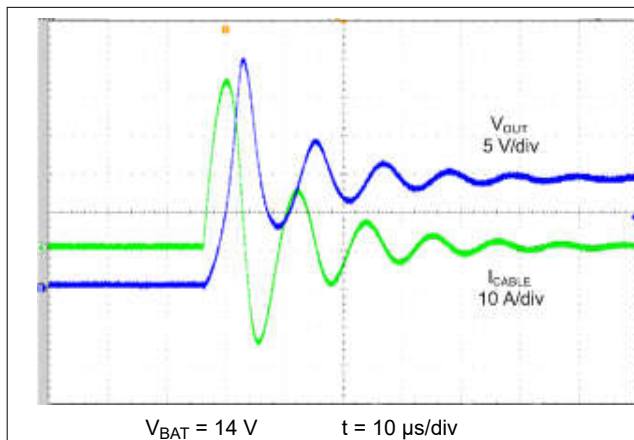

t = 10 μs/div

图 9-4. Disabled, 25-V, 1206, X7R C<sub>OUT</sub> Capacitor With SMAJ18, OUT Shorted to Battery

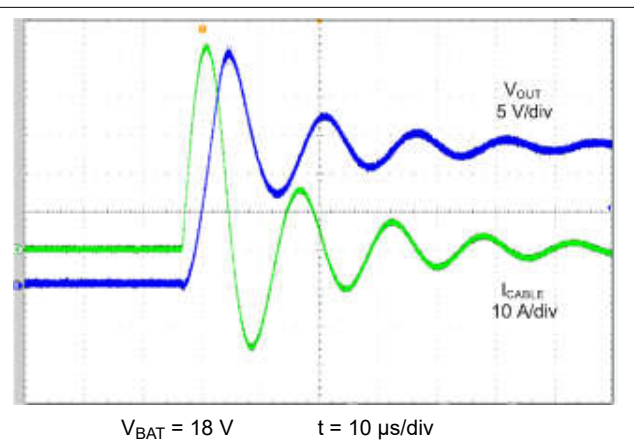
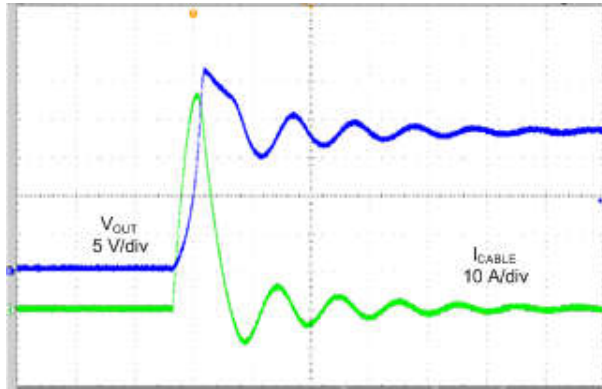
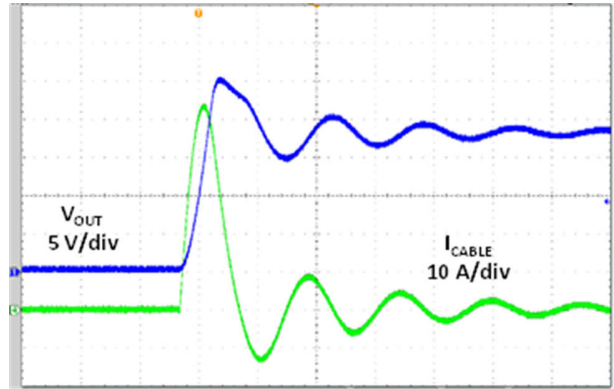

t = 10 μs/div

图 9-5. Disabled, 35-V, 1210, X7R C<sub>OUT</sub> Capacitor With SMAJ18, OUT Shorted to Battery

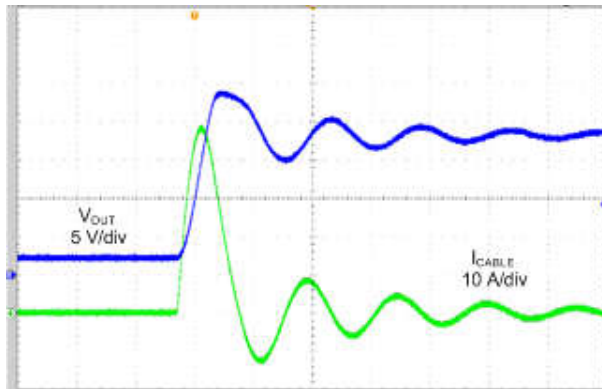

t = 10 μs/div

图 9-6. DC-DC Input Is Floating, OUT Shorted to Battery

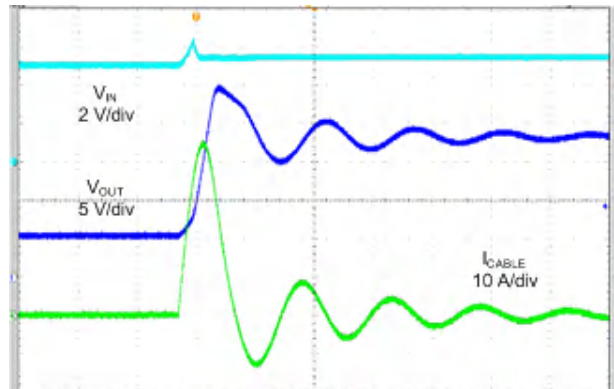

t = 10 μs/div

图 9-7. Enabled With OVP\_SEL = High, OUT Shorted to Battery

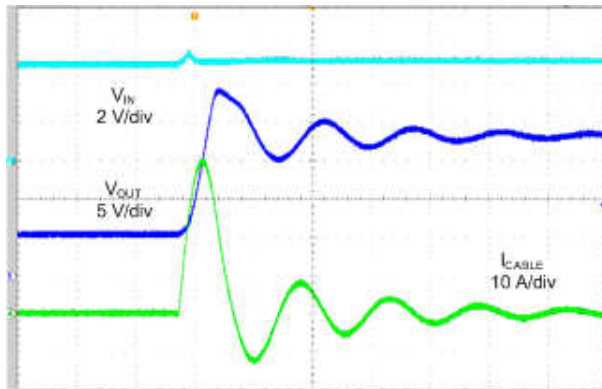

t = 10 μs/div

图 9-8. Enabled With OVP\_SEL = Low, OUT Shorted to Battery

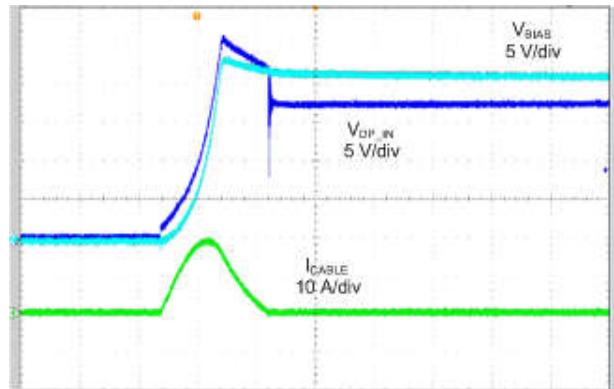

R<sub>BIAS</sub> = 5.1 kΩ

t = 2 μs/div

图 9-9. Disabled, DP\_IN Shorted to Battery

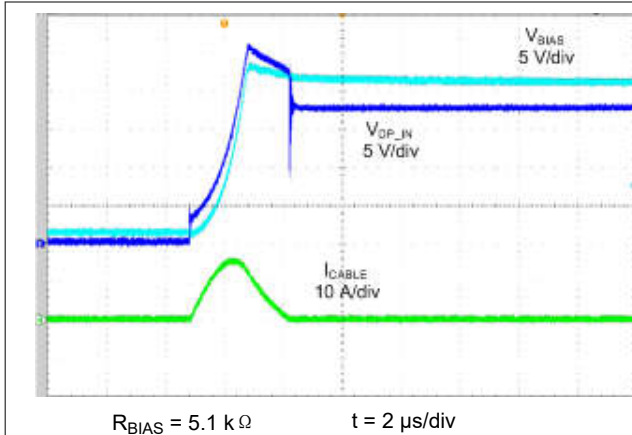

**图 9-10. DC-DC Input Is Floating, DP\_IN Shorted to Battery**

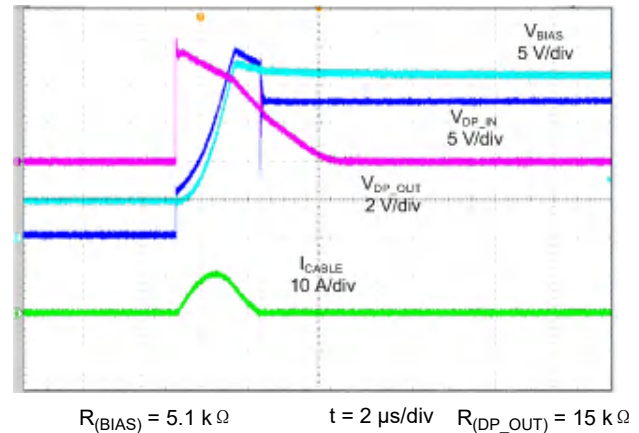

**图 9-11. Enabled, DP\_IN Shorted to Battery**

## 10 Power Supply Recommendations

The TPS254900A-Q1 device is designed for a supply voltage range of  $4.5\text{ V} \leq V_{\text{IN}} \leq 6.5\text{ V}$ , with its power switch used for protecting the upstream power supply when a fault such as overcurrent or short to ground occurs on the USB port. Therefore, the power supply should be rated higher than the current-limit setting to avoid voltage drops during overcurrent or short-circuit conditions.

## 11 Layout

### 11.1 Layout Guidelines

Layout best practices for the TPS254900A-Q1 device are listed as follows.

- Considerations for input and output power traces
  - Make the power traces as short as possible.
  - Make the power traces as wide as possible.
- Considerations for input-capacitor traces
  - For all applications, 10- $\mu\text{F}$  and 0.1- $\mu\text{F}$  low-ESR ceramic capacitors are recommended, placed close to the IN pin.
- The resistors attached to the ILIM\_HI and ILIM\_LO pins of the device have several requirements.
  - It is recommended to use 1% low-temperature-coefficient resistors.
  - The trace routing between these two pins and GND should be as short as possible to reduce parasitic effects on current limit. These traces should not have any coupling to switching signals on the board.
- Locate all TPS254900A-Q1 pullup resistors for open-drain outputs close to their connection pin. Pullup resistors should be 100 k $\Omega$ .
  - If a particular open-drain output is not used or needed in the system, tie it to GND.
- ESD considerations
  - The TPS254900A-Q1 device has built-in ESD protection for DP\_IN and DM\_IN. Keep trace lengths minimal from the USB connector to the DP\_IN and DM\_IN pins on the TPS254900A-Q1 device, and use minimal vias along the traces.
  - The capacitor on BIAS helps to improve the IEC ESD performance. A 2.2- $\mu\text{F}$  capacitor should be placed close to BIAS, and the current path from BIAS to GND across this capacitor should be as short as possible. Do not use vias along the connection traces.
  - A 10- $\mu\text{F}$  output capacitor should be placed close to the OUT pin and TVS.
  - See the *ESD Protection Layout Guide* ([SLVA680](#)) for additional information.
- TVS Considerations
  - For OUT, a TVS like SMAJ18 should be placed near the OUT pin.

- For BIAS, a TVS like SMAJ18 should be placed close to the BIAS pin, but behind the 2.2- $\mu$ F capacitor.
- The whole path from OUT to GND or BIAS to GND across the TVS should be as short as possible.
- DP\_IN, DM\_IN, DP\_OUT, and DM\_OUT routing considerations
  - Route these traces as microstrips with nominal differential impedance of 90  $\Omega$ .
  - Minimize the use of vias on the high-speed data lines.
  - Keep the reference GND plane devoid from cuts or splits above the differential pairs to prevent impedance discontinuities.
  - For more USB 2.0 high-speed D+ and D- differential routing information, see the *High Speed USB Platform Design Guideline* from Intel.
- Thermal Considerations
  - When properly mounted, the thermal-pad package provides significantly greater cooling ability than an ordinary package. To operate at rated power, the thermal pad must be soldered to the board GND plane directly under the device. The thermal pad is at GND potential and can be connected using multiple vias to inner-layer GND. Other planes, such as the bottom side of the circuit board, can be used to increase heat sinking in higher-current applications. See the *PowerPad™ Thermally Enhanced Package* application report ([SLMA002](#)) and *PowerPAD™ Made Easy* application brief ([SLMA004](#)) for more information on using this thermal pad package.



## 11.2 Layout Example

-  Top Layer Signal Trace
-  Top Layer Signal Ground Plane
-  Bottom Layer Signal Trace
-  Via to Bottom layer Signal Ground Plane
-  Via to Bottom layer Signal

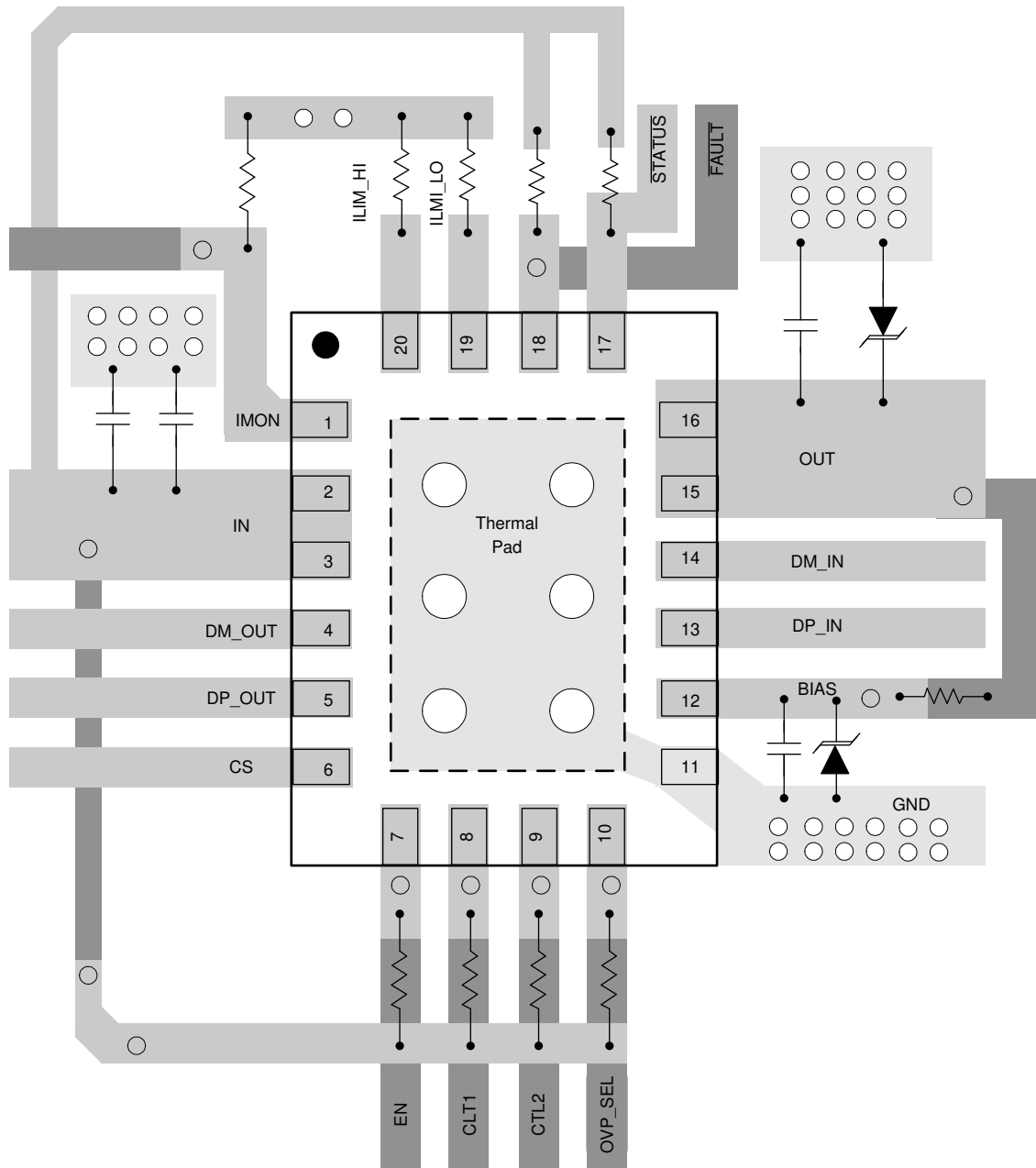

Copyright © 2016, Texas Instruments Incorporated

图 11-1. TPS254900A-Q1 Layout Diagram

## 12 Device and Documentation Support

### 12.1 Device Support

### 12.2 Documentation Support

#### 12.2.1 Related Documentation

For related documentation see the following:

- *High Speed USB Platform Design Guidelines*, Intel
- *TPS254900AQ1EVM-003 Evaluation Module User's Guide* ([SLVUB94](#))
- *TPS254900Q1EVM-817 Evaluation Module User's Guide* ([SLUUB10](#))
- *TPS2549-Q1 Automotive USB Charging Port Controller and Power Switch with Cable Compensation Data Sheet* ([SLUSCE3](#))

#### 12.3 接收文档更新通知

要接收文档更新通知，请导航至 [ti.com](#) 上的器件产品文件夹。点击 [订阅更新](#) 进行注册，即可每周接收产品信息更改摘要。有关更改的详细信息，请查看任何已修订文档中包含的修订历史记录。

#### 12.4 支持资源

[TI E2E™ 中文支持论坛](#) 是工程师的重要参考资料，可直接从专家处获得快速、经过验证的解答和设计帮助。搜索现有解答或提出自己的问题，获得所需的快速设计帮助。

链接的内容由各个贡献者“按原样”提供。这些内容并不构成 TI 技术规范，并且不一定反映 TI 的观点；请参阅 TI 的 [使用条款](#)。

#### 12.5 Trademarks

TI E2E™ is a trademark of Texas Instruments.

所有商标均为其各自所有者的财产。

#### 12.6 静电放电警告



静电放电 (ESD) 会损坏这个集成电路。德州仪器 (TI) 建议通过适当的预防措施处理所有集成电路。如果不遵守正确的处理和安装程序，可能会损坏集成电路。

ESD 的损坏小至导致微小的性能降级，大至整个器件故障。精密的集成电路可能更容易受到损坏，这是因为非常细微的参数更改都可能会导致器件与其发布的规格不相符。

#### 12.7 术语表

[TI 术语表](#) 本术语表列出并解释了术语、首字母缩略词和定义。

## 13 Mechanical, Packaging, and Orderable Information

The following pages include mechanical, packaging, and orderable information. This information is the most-current data available for the designated device. This data is subject to change without notice and without revision of this document. For browser-based versions of this data sheet, see the left-hand navigation pane.

**PACKAGING INFORMATION**

Orderable Device	Status (1)	Package Type	Package Drawing	Pins	Package Qty	Eco Plan (2)	Lead finish/ Ball material (6)	MSL Peak Temp (3)	Op Temp (°C)	Device Marking (4/5)	Samples
TPS254900AIRVCRQ1	ACTIVE	WQFN	RVC	20	3000	RoHS & Green	NIPDAU	Level-2-260C-1 YEAR	-40 to 85	25490AQ	<b>Samples</b>
TPS254900AIRVCTQ1	ACTIVE	WQFN	RVC	20	250	RoHS & Green	NIPDAU	Level-2-260C-1 YEAR	-40 to 85	25490AQ	<b>Samples</b>

(1) The marketing status values are defined as follows:

**ACTIVE:** Product device recommended for new designs.

**LIFEBUY:** TI has announced that the device will be discontinued, and a lifetime-buy period is in effect.

**NRND:** Not recommended for new designs. Device is in production to support existing customers, but TI does not recommend using this part in a new design.

**PREVIEW:** Device has been announced but is not in production. Samples may or may not be available.

**OBSELETE:** TI has discontinued the production of the device.

(2) **RoHS:** TI defines "RoHS" to mean semiconductor products that are compliant with the current EU RoHS requirements for all 10 RoHS substances, including the requirement that RoHS substance do not exceed 0.1% by weight in homogeneous materials. Where designed to be soldered at high temperatures, "RoHS" products are suitable for use in specified lead-free processes. TI may reference these types of products as "Pb-Free".

**RoHS Exempt:** TI defines "RoHS Exempt" to mean products that contain lead but are compliant with EU RoHS pursuant to a specific EU RoHS exemption.

**Green:** TI defines "Green" to mean the content of Chlorine (Cl) and Bromine (Br) based flame retardants meet JS709B low halogen requirements of <=1000ppm threshold. Antimony trioxide based flame retardants must also meet the <=1000ppm threshold requirement.

(3) MSL, Peak Temp. - The Moisture Sensitivity Level rating according to the JEDEC industry standard classifications, and peak solder temperature.

(4) There may be additional marking, which relates to the logo, the lot trace code information, or the environmental category on the device.

(5) Multiple Device Markings will be inside parentheses. Only one Device Marking contained in parentheses and separated by a "~" will appear on a device. If a line is indented then it is a continuation of the previous line and the two combined represent the entire Device Marking for that device.

(6) Lead finish/Ball material - Orderable Devices may have multiple material finish options. Finish options are separated by a vertical ruled line. Lead finish/Ball material values may wrap to two lines if the finish value exceeds the maximum column width.

**Important Information and Disclaimer:**The information provided on this page represents TI's knowledge and belief as of the date that it is provided. TI bases its knowledge and belief on information provided by third parties, and makes no representation or warranty as to the accuracy of such information. Efforts are underway to better integrate information from third parties. TI has taken and continues to take reasonable steps to provide representative and accurate information but may not have conducted destructive testing or chemical analysis on incoming materials and chemicals. TI and TI suppliers consider certain information to be proprietary, and thus CAS numbers and other limited information may not be available for release.

In no event shall TI's liability arising out of such information exceed the total purchase price of the TI part(s) at issue in this document sold by TI to Customer on an annual basis.



**TAPE AND REEL INFORMATION**

**QUADRANT ASSIGNMENTS FOR PIN 1 ORIENTATION IN TAPE**

\*All dimensions are nominal

Device	Package Type	Package Drawing	Pins	SPQ	Reel Diameter (mm)	Reel Width W1 (mm)	A0 (mm)	B0 (mm)	K0 (mm)	P1 (mm)	W (mm)	Pin1 Quadrant
TPS254900AIRVCRQ1	WQFN	RVC	20	3000	330.0	12.4	3.3	4.3	1.1	8.0	12.0	Q1
TPS254900AIRVCTQ1	WQFN	RVC	20	250	180.0	12.4	3.3	4.3	1.1	8.0	12.0	Q1

**TAPE AND REEL BOX DIMENSIONS**

\*All dimensions are nominal

Device	Package Type	Package Drawing	Pins	SPQ	Length (mm)	Width (mm)	Height (mm)
TPS254900AIRVCRQ1	WQFN	RVC	20	3000	367.0	367.0	35.0
TPS254900AIRVCTQ1	WQFN	RVC	20	250	210.0	185.0	35.0

## GENERIC PACKAGE VIEW

RVC 20

WQFN - 0.8 mm max height

PLASTIC QUAD FLATPACK - NO LEAD

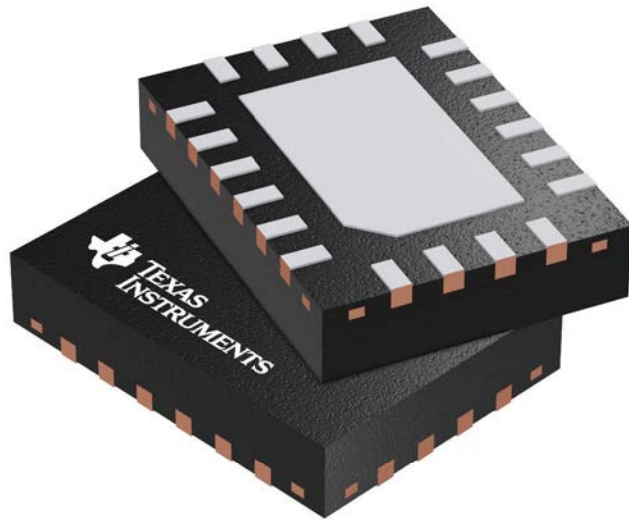

Images above are just a representation of the package family, actual package may vary.  
Refer to the product data sheet for package details.

4209819/B

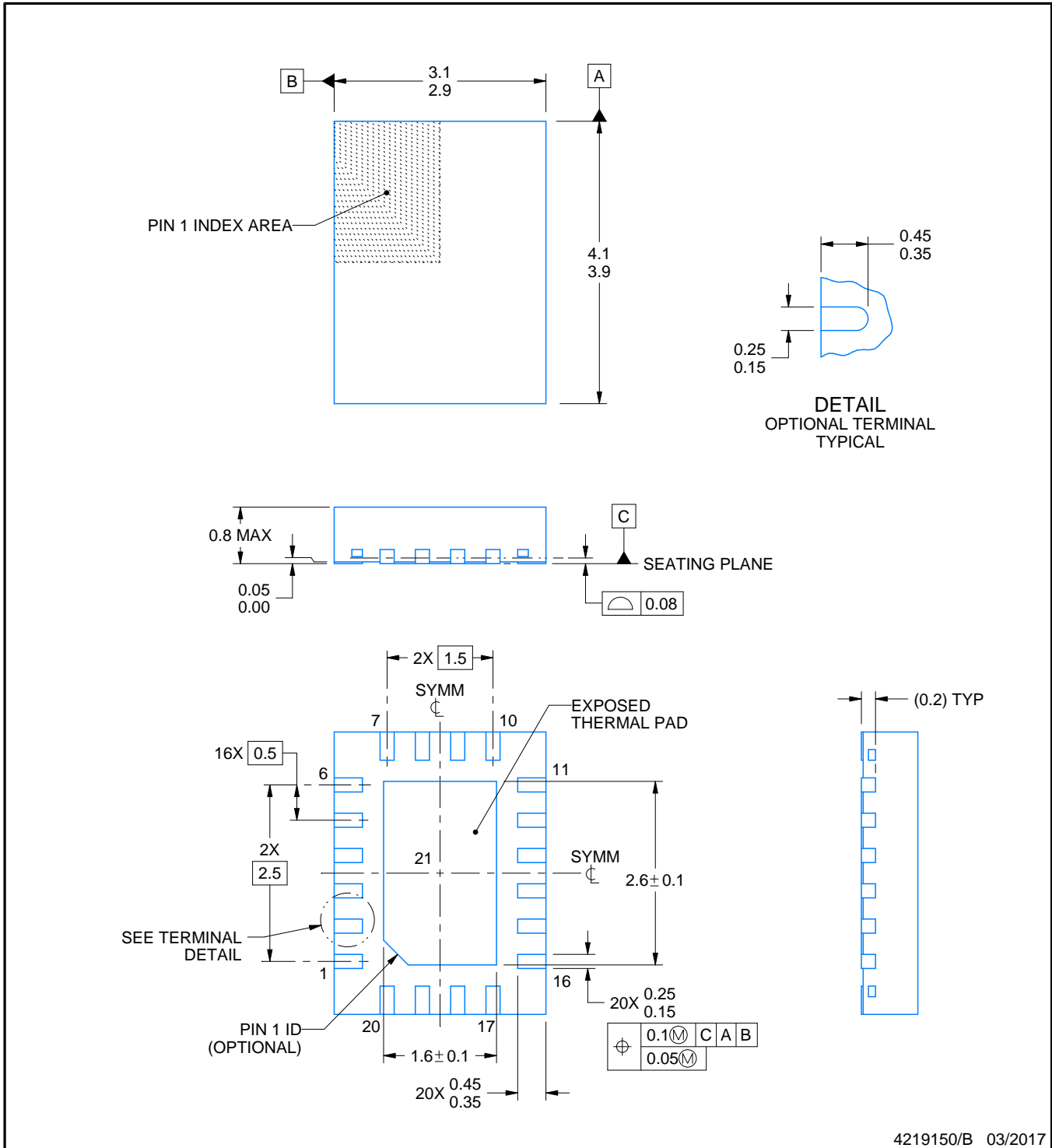
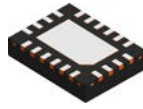

4219150/B 03/2017

NOTES:

1. All linear dimensions are in millimeters. Any dimensions in parenthesis are for reference only. Dimensioning and tolerancing per ASME Y14.5M.
2. This drawing is subject to change without notice.
3. The package thermal pad must be soldered to the printed circuit board for optimal thermal and mechanical performance.



# EXAMPLE BOARD LAYOUT

RVC0020A

WQFN - 0.8 mm max height

PLASTIC QUAD FLATPACK - NO LEAD

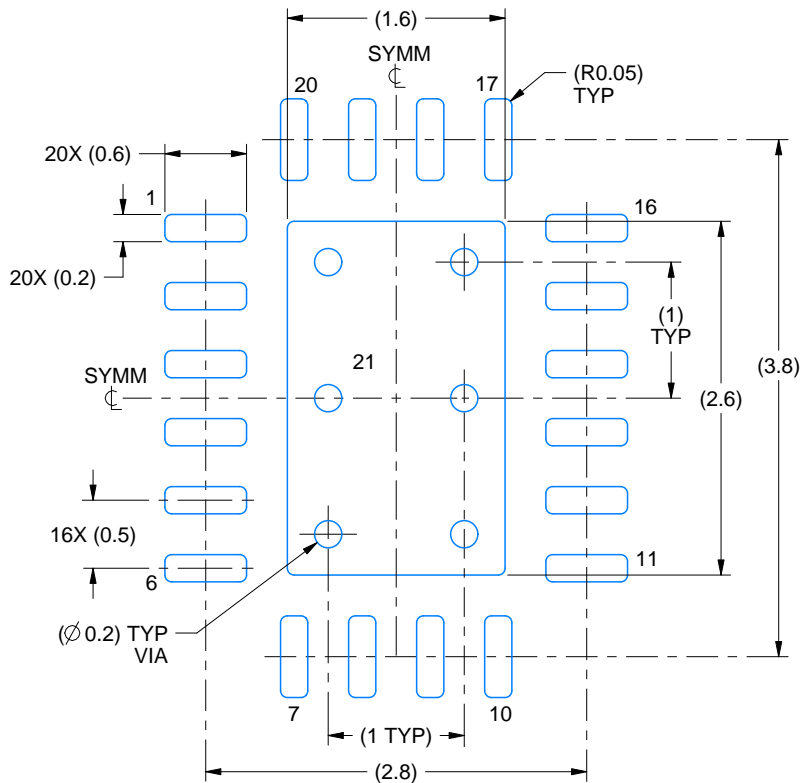

LAND PATTERN EXAMPLE  
EXPOSED METAL SHOWN  
SCALE:18X

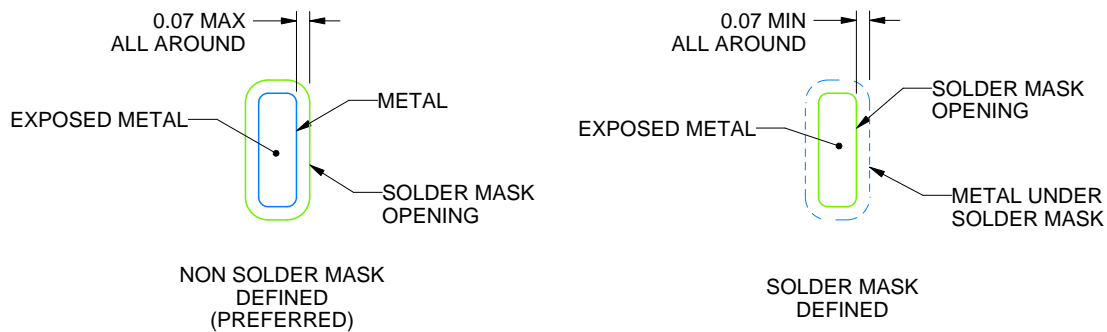

SOLDER MASK DETAILS

4219150/B 03/2017

NOTES: (continued)

4. This package is designed to be soldered to a thermal pad on the board. For more information, see Texas Instruments literature number SLUA271 ([www.ti.com/lit/slua271](http://www.ti.com/lit/slua271)).
5. Vias are optional depending on application, refer to device data sheet. If any vias are implemented, refer to their locations shown on this view. It is recommended that vias under paste be filled, plugged or tented.

# EXAMPLE STENCIL DESIGN

RVC0020A

WQFN - 0.8 mm max height

PLASTIC QUAD FLATPACK - NO LEAD

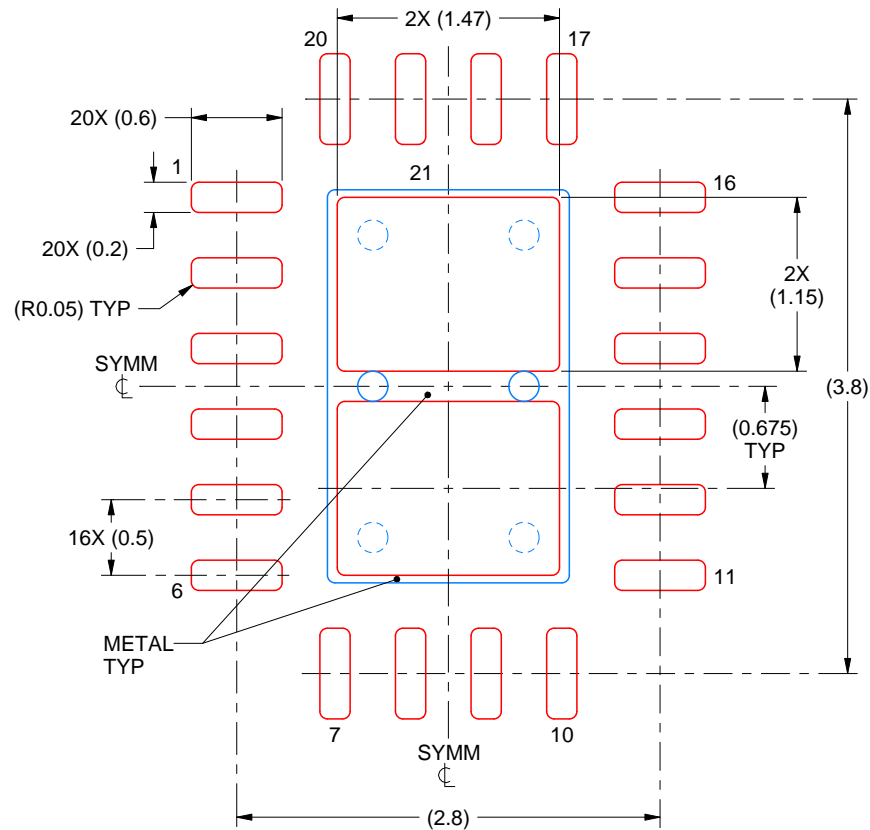

SOLDER PASTE EXAMPLE  
BASED ON 0.1 mm THICK STENCIL

EXPOSED PAD X  
81% PRINTED SOLDER COVERAGE BY AREA UNDER PACKAGE  
SCALE:20X

4219150/B 03/2017

NOTES: (continued)

6. Laser cutting apertures with trapezoidal walls and rounded corners may offer better paste release. IPC-7525 may have alternate design recommendations.

## 重要声明和免责声明

TI“按原样”提供技术和可靠性数据（包括数据表）、设计资源（包括参考设计）、应用或其他设计建议、网络工具、安全信息和其他资源，不保证没有瑕疵且不做任何明示或暗示的担保，包括但不限于对适销性、某特定用途方面的适用性或不侵犯任何第三方知识产权的暗示担保。

这些资源可供使用 TI 产品进行设计的熟练开发人员使用。您将自行承担以下全部责任：(1) 针对您的应用选择合适的 TI 产品，(2) 设计、验证并测试您的应用，(3) 确保您的应用满足相应标准以及任何其他功能安全、信息安全、监管或其他要求。

这些资源如有变更，恕不另行通知。TI 授权您仅可将这些资源用于研发本资源所述的 TI 产品的应用。严禁对这些资源进行其他复制或展示。您无权使用任何其他 TI 知识产权或任何第三方知识产权。您应全额赔偿因在这些资源的使用中对 TI 及其代表造成的任何索赔、损害、成本、损失和债务，TI 对此概不负责。

TI 提供的产品受 [TI 的销售条款](#) 或 [ti.com](#) 上其他适用条款/TI 产品随附的其他适用条款的约束。TI 提供这些资源并不会扩展或以其他方式更改 TI 针对 TI 产品发布的适用的担保或担保免责声明。

TI 反对并拒绝您可能提出的任何其他或不同的条款。

邮寄地址：Texas Instruments, Post Office Box 655303, Dallas, Texas 75265

Copyright © 2023，德州仪器 (TI) 公司