

TPS25990 带 PMBus® 数字遥测的 2.9V – 16V、0.79mΩ、60A 可堆叠电子保险丝

1 特性

- 输入工作电压范围：2.9 V 至 16 V
 - 输入端的绝对最大值为 20V
 - 输出端可耐受高达 -1V 的负电压
- 集成低导通电阻 FET：0.79mΩ（典型值）
 - 额定电流为 50A RMS 和 60A 峰值电流
- 可用作独立电子保险丝或在并联配置中用作主控制器
 - 支持多个电子保险丝并行连接，从而支持更高的电流
 - 启动和稳态期间的主动器件状态同步和负载共享，可实现巨大的可扩展性
- 用于遥测、控制、配置和调试的 PMBus® 接口
 - P_{IN}/E_{IN}/V_{IN}/V_{OUT}/I_{IN}/温度/故障监控
 - 使用单个命令进行下电上电
 - 片上非易失性配置存储器
 - 多个事件的黑盒故障记录，具有相对时间戳和存储在外部 EEPROM 上的选项
- 强大的过流保护
 - 可编程过流阈值 (I_{OC}P)：7 A 至 50 A，精度为 ±5%（最大）
 - 稳态期间的断路器响应，具有可编程瞬态消隐计时器 (OC_TIMER)，可支持峰值负载电流
 - 启动期间运行模式下的有效电流限制 (I_{LIM})
- 强大的短路保护
 - 快速跳变响应 (280ns)
 - 可编程阈值和固定阈值
 - 不受电源线路瞬变影响 - 无干扰性跳变
- 可编程过热保护 (OTP)
 - 确保 FET SOA：8W √s
- 集成式 FET 运行状况监测和报告
- 精确的模拟负载电流监控 (IMON)
 - ±2% 精度
 - 模拟带宽大于 500kHz
- 快速过压保护，具有可编程阈值
- 可编程输出转换率控制 (dVdt)
- 可编程插入延迟计时器
- 可编程欠压锁定 (UVLO)
- 模拟芯片温度监测器输出 (TEMP)
- 4 个可配置通用 I/O 引脚
- 小尺寸：QFN 封装 (4.5mm × 5mm，间距为 0.6mm)
 - 电源引脚和 GND 引脚之间的间隙为 29mil
- 100% 无铅

2 应用

- 服务器和高性能计算
- 网络接口卡
- 显卡和硬件加速器卡
- 数据中心交换机和路由器
- 输入热插拔
- 风扇托盘

3 说明

TPS25990 是采用小型封装的集成式大电流电路保护和电源管理器件。该器件只需很少的外部元件即可提供多种保护模式，能够非常有效地抵御过载、短路和过多浪涌电流。

集成的 PMBus® 接口允许主机控制器实时监测、控制和配置系统。关键系统参数可以通过远程遥测进行回读。各种保护、警告阈值和系数可通过 PMBus® 进行配置或存储在非易失性配置存储器中。黑盒故障记录功能有助于调试现场故障和退货。

该器件可用作独立电子保险丝，也可作为并联电子保险丝配置中的主控制器进行连接，以支持更高的电流。所有器件在启动和稳态期间均主动同步其运行状态并共享电流，以避免某些器件上出现过载情况而导致并行链过早关闭或部分关闭。

封装信息

器件型号	封装 ⁽¹⁾	封装尺寸
TPS25990ARQPR	RQP (QFN, 26)	4.50mm × 5.00mm

(1) 如需了解所有可用封装，请参阅数据表末尾的可订购产品附录。

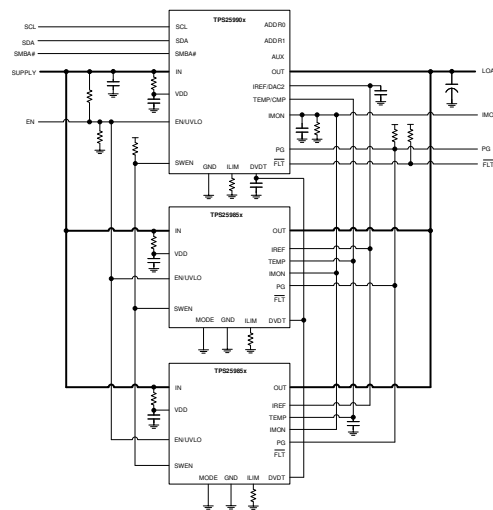

简化原理图



Table of Contents

1 特性.....	1	8.1 Overview.....	28
2 应用.....	1	8.2 Functional Block Diagram.....	29
3 说明.....	1	8.3 Feature Description.....	29
4 Revision History.....	2	8.4 Device Functional Modes.....	117
5 说明 (续).....	3	9 Application and Implementation.....	118
6 Pin Configuration and Functions.....	4	9.1 Application Information.....	118
7 Specifications.....	7	9.2 Typical Application: 12-V, 4-kW Power Path Protection with PMBus® Interface in Datacenter Servers.....	124
7.1 Absolute Maximum Ratings.....	7	9.3 Best Design Practices.....	133
7.2 ESD Ratings.....	7	9.4 Power Supply Recommendations.....	134
7.3 Recommended Operating Conditions.....	8	9.5 Layout.....	135
7.4 Thermal Information.....	8	10 Device and Documentation Support.....	138
7.5 Electrical Characteristics.....	9	10.1 Documentation Support.....	138
7.6 Logic Interface DC Characteristics.....	12	10.2 接收文档更新通知.....	138
7.7 Telemetry.....	12	10.3 支持资源.....	138
7.8 PMBus Interface Timing Characteristics.....	15	10.4 Trademarks.....	138
7.9 External EEPROM Interface Timing Characteristics.....	15	10.5 静电放电警告.....	138
7.10 Timing Requirements.....	16	10.6 术语表.....	138
7.11 Switching Characteristics.....	17	11 Mechanical, Packaging, and Orderable Information.....	138
7.12 Typical Characteristics.....	18		
8 Detailed Description.....	28		

4 Revision History

注：以前版本的页码可能与当前版本的页码不同

Changes from Revision A (September 2022) to Revision B (June 2023)	Page
• 将器件状态从 预告信息 更改为 量产数据	1
• 更新了器件说明.....	1
• Revised the graphs and experimental waveforms in typical characteristics.....	18
• Updated the functional block diagram.....	29
• Updated the feature description.....	29
• Deleted the <i>WRITE_PROTECT</i> (10h) register.....	53
• Added the <i>MFR_WRITE_PROTECT</i> (F8h) register.....	53
• Deleted the <i>EEPROM_DET_CMD</i> (F4h) register.....	53
• Changed the <i>STATUS_MFR_SPECIFIC_2</i> register command code from 7Fh to F3h	53
• Changed the SMBus transaction type of <i>STATUS_MFR_SPECIFIC_2</i> register from <i>Read Byte</i> to <i>Read Word</i>	53
• Updated the default value of the <i>MFR_REVISION</i> (9Bh) register from 0x61 to 0x01	53
• Changed the <i>READ_BB_EEPROM</i> register command code from BCh to F4h	53
• Changed the <i>CABLE_RESISTANCE</i> register command name to <i>CABLE_DROP</i>	53
• Deleted the <i>MFR_SPECIFIC_RESERVED</i> (B0h) register.....	53
• Revised the bit definitions of the <i>STATUS_BYTE</i> (78h), <i>STATUS_WORD</i> (79h), <i>STATUS_IN</i> (7Ch), <i>STATUS_IOUT</i> (7Bh), <i>STATUS_TEMP</i> (7Dh), <i>STATUS_MFR_SPECIFIC</i> (80h), <i>STATUS_MFR_SPECIFIC_2</i> (F3h), <i>STATUS_CML</i> (7Eh), <i>DEVICE_CONFIG</i> (E4h), <i>ADC_CONFIG_2</i> (E9h), <i>ALERT_MASK</i> (DBh) registers.....	53
• Revised the Blackbox timestamp tick interval.....	101
• Revised the overcurrent blanking timer values.....	102
• Revised the retry delay timer values.....	103
• Revised the insertion delay timer values.....	111
• Revised the ADC sampling frequency from 500 KSPS to 460 KSPS.....	112
• Added high performance ADC sampling mode.....	112

-
- Updated the m , b , R coefficients used in DIRECT format conversion..... 114
 - A minor modification to the application schematic..... 124
 - Revised the application performance plots..... 132
-

5 说明 (续)

集成的快速、准确检测模拟负载电流监测器有助于进行预测性维护，并且先进的动态平台电源管理技术（如 Intel® PSYS 和 PROCHOT）可更大限度地提高系统吞吐量和电源利用率。这与集成的数字示波器功能和黑盒相结合，有助于在关键系统中进行预测性维护。

此类器件的额定工作结温范围为 -40°C 至 +125°C。

6 Pin Configuration and Functions



图 6-1. TPS25990 RQP Package 26-pin QFN Top View

表 6-1. Pin Functions

PIN		TYPE	DESCRIPTION
NAME	NO.		
ADDR1	1	O	PMBus device I2C address configuration pin. Pin strap options to generate different address combinations in conjunction with ADDR0. Refer to 节 8.3.14.1 for more details.
ADDR0	2	O	PMBus device I2C address configuration pin. Pin strap options to generate different address combinations in conjunction with ADDR1. Refer to 节 8.3.14.1 for more details.
AUX	3	I	Auxiliary ADC input channel which can be used to monitor external analog signal through PMBus. Also functions as analog input for fast comparator with internal programmable threshold.
DVDT	4	O	Start-up output slew rate control pin. Leave this pin open to allow fastest start-up. Connect capacitor to ground to slow down the slew rate to manage inrush current. Refer to 节 8.3.4.1 for more details.

表 6-1. Pin Functions (continued)

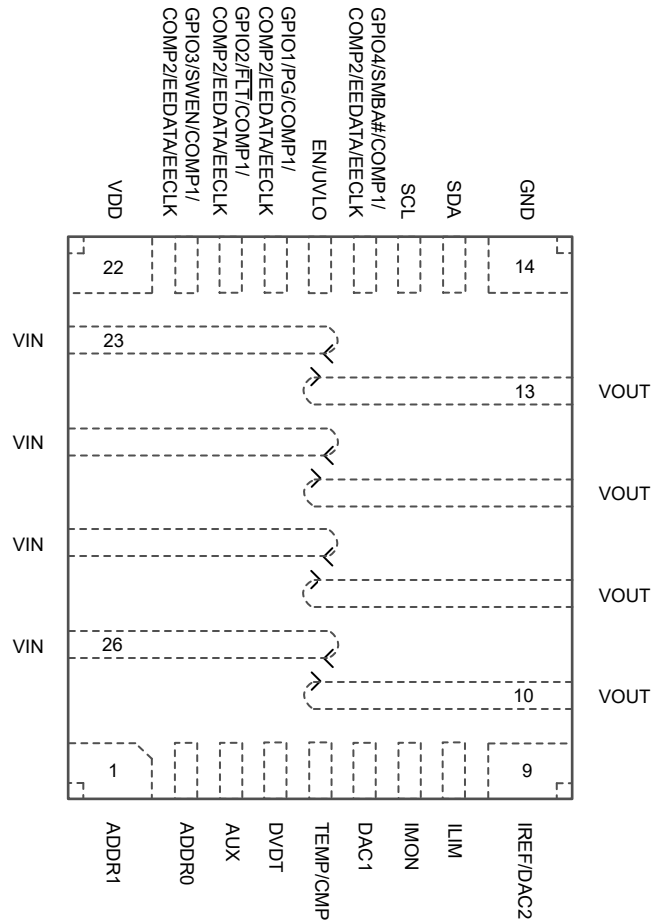
PIN		TYPE	DESCRIPTION
NAME	NO.		
TEMP/CMP	5	I/O	Dual function pin (digitally configurable) 1. Die junction temperature monitor analog voltage output. Can be tied together with TEMP outputs of multiple devices in a parallel configuration to indicate the peak temperature of the chain. Refer to 节 8.3.8 for more details. 2. Analog input for fast comparator with internal programmable threshold. Refer to 节 8.3.12 for more details.
DAC1	6	I/O	Programmable General Purpose DAC analog current output. Refer to 节 8.3.14.9 for more details.
IMON	7	O	An external resistor from this pin to GND sets the overcurrent protection threshold and fast-trip threshold during steady-state. This pin also acts as a fast and accurate analog output load current monitor signal during steady-state. <i>Do not leave floating.</i> Refer to 节 8.3.6 for more details.
ILIM	8	O	An external resistor from this pin to GND sets the current limit threshold and fast-trip threshold during start-up. This also sets the active current sharing threshold during steady-state. <i>Do not leave floating.</i> Refer to 节 8.3.4.3 for more details.
IREF/DAC2	9	I/O	Dual function pin (digitally configurable) 1. Programmable reference voltage for overcurrent, short-circuit protection and active current sharing blocks. Generated using internal DAC. Refer to 节 8.3.4.2 for more details. 2. Programmable analog voltage output generated using internal general-purpose DAC. Refer to 节 8.3.14.9 for more details.
OUT	10, 11, 12, 13	P	Power output. Must be soldered to output power plane uniformly to ensure proper heat dissipation and to maintain optimal current distribution through the device.
GND	14	G	Device ground reference pin. Connect to system ground.
SDA	15	I/O	I2C data line for PMBus interface. Refer to 节 8.3.14 for more details.
SCL	16	I/O	I2C clock line for PMBus interface. Refer to 节 8.3.14 for more details.
GPIO4/SMBA#/ COMP1/COMP2/ EEDATA/EECLK	17	I/O	General purpose digital I/O pin. Can be configured for various functions through PMBus. Refer to 节 8.3.14.7.1.59 register for more details. Default function is SMBus Alert output.
EN/UVLO	18	I	Active high enable input. Connect resistor divider from input supply to set the undervoltage threshold. <i>Do not leave floating.</i>
GPIO1/PG/ COMP1/COMP2/ EEDATA/EECLK	19	I/O	General purpose digital I/O pin. Can be configured for various functions through PMBus. Refer to 节 8.3.14.7.1.58 register for more details. Default function is Power-Good output (PG) indication. Refer to 节 8.3.10.2 for more details.
GPIO2/FLT/ COMP1/COMP2/ EEDATA/EECLK	20	I/O	General purpose digital I/O pin. Can be configured for various functions through PMBus. Refer to 节 8.3.14.7.1.58 register for more details. Default function is Fault output (FLT) indication. Refer to 节 8.3.10.1 for more details.
GPIO3/SWEN/ COMP1/COMP2/ EEDATA/EECLK	21	I/O	General purpose digital I/O pin. Can be configured for various functions through PMBus. Refer to 节 8.3.14.7.1.59 register for more details. Default pin function is set to SWEN, which is used to synchronize multiple eFuses in a parallel configuration. Refer to 节 8.3.10.3 for more details.
VDD	22	P	Controller power input pin. Can be used to power the internal control circuitry with a filtered and stable supply which is not affected by system transients. Connect this pin to VIN through a series resistor and add a decoupling capacitor to GND.

表 6-1. Pin Functions (continued)

PIN		TYPE	DESCRIPTION
NAME	NO.		
IN	23, 24, 25, 26	P	Power input. Must be soldered to input power plane uniformly to ensure proper heat dissipation and to maintain optimal current distribution through the device.

7 Specifications

7.1 Absolute Maximum Ratings

over operating free-air temperature range (unless otherwise noted)⁽¹⁾

Parameter		Pin	MIN	MAX	UNIT
V _{INMAX}	Maximum Input Voltage Range	IN	- 0.3	20	V
V _{DDMAX}	Maximum Supply Voltage Range	VDD	- 0.3	20	V
V _{OUTMAX}	Maximum Output Voltage Range	OUT	- 1	Min(20, V _{IN} + 0.3)	V
V _{ENMAX}	Maximum Enable Pin Voltage Range	EN/UVLO		20	V
V _{IREFMAX}	Maximum IREF/DAC2 Pin Voltage Range	IREF/DAC2		5.5	V
I _{IREFMAX}	Maximum IREF/DAC2 Pin Current	IREF/DAC2		10	mA
V _{AUXMAX}	Maximum AUX Pin Voltage Range	AUX		5.5	V
V _{DVDTMAX}	Maximum DVDT Pin Voltage Range	DVDT	Internally Limited		V
V _{I2CMAX}	Maximum I2C Signal Pin Voltage Range	SCL, SDA		5.5	V
V _{GPIOMAX}	Maximum GPIO Pin Voltage Range	GPIO1/2/3/4		5.5	V
I _{GPIOMAX}	Maximum GPIO Pin Sink Current	GPIO1/2/3/4		10	mA
V _{DAC2MAX}	Maximum DAC2 Output Voltage Range	IREF/DAC2	Internally Limited		V
V _{ADDRMAX}	Maximum ADDR0/1 Pin Voltage Range	ADDR0/1	Internally Limited		V
I _{ADDRMAX}	Maximum ADDR0/1 Pin Sink Current	ADDR0/1	Internally Limited		μA
I _{DAC1MAX}	Maximum DAC1 Pin Current	DAC1	Internally Limited		mA
V _{TEMPMAX}	Maximum TEMP/CMP Pin Voltage Range	TEMP/CMP		5.5	V
V _{ILIMMAX}	Maximum ILIM pin voltage	ILIM	Internally Limited		V
V _{IMONMAX}	Maximum IMON pin voltage	IMON	Internally Limited		V
I _{MAX}	Maximum Continuous Switch Current	IN to OUT	Internally Limited		A
T _{JMAX}	Junction temperature		Internally Limited		°C
T _{LEAD}	Maximum Soldering Temperature			300	°C
T _{STG}	Storage temperature		- 65	150	°C

- (1) Operation outside the Absolute Maximum Ratings may cause permanent device damage. Absolute Maximum Ratings do not imply functional operation of the device at these or any other conditions beyond those listed under Recommended Operating Conditions. If used outside the Recommended Operating Conditions but within the Absolute Maximum Ratings, the device may not be fully functional, and this may affect device reliability, functionality, performance, and shorten the device lifetime.

7.2 ESD Ratings

			VALUE	UNIT
V _(ESD)	Electrostatic discharge	Human body model (HBM), per ANSI/ESDA/ JEDEC JS-001 ⁽¹⁾	±2000	V
		Charged device model (CDM), per ANSI/ESDA/ JEDEC JS-002 ⁽²⁾	±500	

- (1) JEDEC document JEP155 states that 500-V HBM allows safe manufacturing with a standard ESD control process.
(2) JEDEC document JEP157 states that 250-V CDM allows safe manufacturing with a standard ESD control process.

7.3 Recommended Operating Conditions

over operating free-air temperature range (unless otherwise noted)

Parameter		Pin	MIN	MAX	UNIT
V _{IN}	Input Voltage Range	IN	2.9	16	V
V _{DD}	Supply Voltage Range (with in-system NVM programming support)	VDD	10	16	V
V _{DD}	Supply Voltage Range (without in-system NVM programming support)	VDD	4.5	16	V
V _{OUT}	Output Voltage Range	OUT		V _{IN}	V
V _{EN/UVLO}	Enable Pin Voltage Range	EN/UVLO	Min(V _{DD} + 1, V _{IN} + 1)		V
V _{DVDT}	DVDT Pin Cap Voltage Rating	DVDT	4		V
V _{I2C}	I2C Pull-up Voltage Range	SCL, SDA	1.8	5	V
C _{I2C}	I2C Parasitic Capacitance	SCL, SDA		200	pF
V _{GPIO}	GPIOx Pin Pull-up Voltage Range	GPIO1/2/3/4		5	V
V _{IREF}	IREF Pin Voltage Range	IREF/DAC2	0.3	1.2	V
V _{ILIM}	ILIM Pin Voltage Range	ILIM		0.4	V
V _{IMON}	IMON Pin Voltage Range	IMON		1.2	V
V _{TEMPCMP}	TEMP/CMP Pin Voltage Range	TEMP/CMP		1.2	V
V _{AUX}	AUX Pin Voltage Range	AUX		1.2	V
I _{MAX}	RMS Switch Current, T _J ≤ 125 °C	IN to OUT		50	A
I _{MAX, PLS}	Peak Output Current with 20% duty cycle, T _J ≤ 125 °C	IN to OUT		60	A
T _J	Junction temperature		- 40	125	°C

7.4 Thermal Information

THERMAL METRIC ^{(1) (2)}		TPS25990X	UNIT
		RQP (QFN)	
		26 PINS	
R _{θJA}	Junction-to-ambient thermal resistance	19.9	°C/W
Ψ _{JT}	Junction-to-top characterization parameter	0.2	°C/W
Ψ _{JB}	Junction-to-board characterization parameter	4.2	°C/W

- (1) For more information about traditional and new thermal metrics, see the [Semiconductor and IC Package Thermal Metrics](#) application report.
- (2) Based on simulations conducted with the device mounted on a JEDEC 8-layer PCB (4s4p)

7.5 Electrical Characteristics

(Test conditions unless otherwise noted) - $40^{\circ}\text{C} \leq T_J \leq 125^{\circ}\text{C}$, $V_{IN} = 12\text{ V}$, $V_{DD} = 12\text{ V}$, $\text{OUT} = \text{Open}$, $V_{EN/UVLO} = 2\text{ V}$, $\text{SWEN} = 10\text{ k}\Omega$ pull-up to 5 V , $R_{LIM} = 550\ \Omega$, $R_{IMON} = 1.1\text{ k}\Omega$, $\text{DVDT} = \text{Open}$, $\overline{\text{FLT}} = 10\text{ k}\Omega$ pull-up to 5 V , $\text{PG} = 10\text{ k}\Omega$ pull-up to 5 V , $\text{TEMP} = \text{Open}$, $\text{ADDR0} = \text{Open}$, $\text{ADDR1} = \text{Open}$, SCL , SDA and SMBA\# pulled up to 3.3 V . All voltages referenced to GND .

PARAMETER		TEST CONDITIONS	MIN	TYP	MAX	UNIT
INPUT SUPPLY (VDD)						
V_{DD}	VDD input operating voltage range		4.5		16	V
$I_{QON(VDD)}$	VDD ON state quiescent current	$V_{VDD} > V_{UVP(R)}$, $V_{EN} \geq V_{UVLO(R)}$		3.7	5.5	mA
$I_{QOFF(VDD)}$	VDD OFF state current	$V_{SD(R)} < V_{EN} < V_{UVLO(F)}$		3.7	5.5	mA
$I_{SD(VDD)}$	VDD shutdown current	$V_{EN} < V_{SD(F)}$		4	6	mA
$V_{UVP(R)}$	VDD undervoltage protection threshold	VDD Rising	4	4.26	4.5	V
$V_{UVP(F)}$	VDD undervoltage protection threshold	VDD Falling	3.9	4.07	4.4	V
INPUT SUPPLY (IN)						
V_{IN}	VIN input operating voltage range		2.9		16	V
$V_{UVPIN(R)}$	V_{IN} undervoltage protection threshold		2.71	2.81	2.91	V
$V_{UVPIN(F)}$	V_{IN} undervoltage protection threshold		2.59	2.59	2.60	V
$V_{UVLOIN(R)}$	V_{IN} undervoltage protection threshold	VIN Rising, $V_{IN_UV_FLT} = 0x8D$ (Default register value)	10.8 2	11.02	11.17	V
$V_{UVLOIN(F)}$	V_{IN} undervoltage protection threshold	VIN Falling, $V_{IN_UV_FLT} = 0x8D$ (Default register value)	10.5 2	10.78	10.9 7	V
$I_{QON(IN)}$	IN ON state quiescent current	$V_{EN} \geq V_{UVLO(R)}$		2.6	3.5	mA
$I_{QOFF(IN)}$	IN OFF state current	$V_{SD(R)} < V_{EN} < V_{UVLO(F)}$		2.6	3.5	mA
$I_{SD(IN)}$	IN shutdown current	$V_{EN} < V_{SD(F)}$		2.7	3.5	mA
ENABLE / UNDERVOLTAGE LOCKOUT (EN/UVLO)						
$V_{UVLO(R)}$	EN/UVLO pin voltage threshold for turning on, rising	EN/UVLO Rising	1.12	1.2	1.28	V
$V_{UVLO(F)}$	EN/UVLO pin voltage threshold for turning off and engaging QOD, falling	EN/UVLO Falling	1.02	1.1	1.18	V
$V_{SD(F)}$	Shutdown threshold	EN/UVLO Falling	0.6			V
I_{ENLKG}	EN/UVLO pin leakage current	$V_{EN} < \text{Min}(V_{IN} + 1\text{ V}, V_{DD} + 1\text{ V})$			0.1	μA
OVERVOLTAGE PROTECTION (IN)						
$V_{OVP(R)}$	V_{IN} overvoltage protection threshold (rising)	$V_{IN_OV_FLT} = 0x0E$ (Default setting), V_{IN} rising	16.3 9	16.73	17.0 8	V
$V_{OVP(F)}$	V_{IN} overvoltage protection threshold (falling)	$V_{IN_OV_FLT} = 0x0E$ (Default setting), V_{IN} falling	16.1	16.48	16.8	V
$V_{OVP(R)}$	V_{IN} overvoltage protection threshold (rising)	$V_{IN_OV_FLT} = 0x0B$, V_{IN} rising	13.3 2	13.74	14.1 5	V
$V_{OVP(F)}$	V_{IN} overvoltage protection threshold (falling)	$V_{IN_OV_FAULT} = 0x0B$, V_{IN} falling	13.1	13.49	13.8 9	V
$V_{OVP(R)}$	V_{IN} overvoltage protection threshold (falling)	$V_{IN_OV_FAULT} = 0x01$, V_{IN} rising	3.77	3.94	4.15	
$V_{OVP(F)}$	V_{IN} overvoltage protection threshold (falling)	$V_{IN_OV_FAULT} = 0x01$, V_{IN} falling	3.53	3.69	3.86	
ON-RESISTANCE (IN - OUT)						
R_{ON}	ON resistance	$T_J = 25^{\circ}\text{C}$		0.79	1.05	$\text{m}\Omega$
R_{ON}	ON resistance	$T_J = -40$ to 125°C			1.4	$\text{m}\Omega$
OUTPUT CURRENT MONITOR AND OVERCURRENT PROTECTION (IMON)						
G_{IMON}	Current Monitor Gain (IMON:IOUT)	Device in steady state (PG asserted)	17.8 7	18.18	18.5 5	$\mu\text{A/A}$
$I_{LKG(IMON)}$	IMON pin leakage/offset current				1.1	μA

7.5 Electrical Characteristics (continued)

(Test conditions unless otherwise noted) - $40^{\circ}\text{C} \leq T_J \leq 125^{\circ}\text{C}$, $V_{IN} = 12\text{ V}$, $V_{DD} = 12\text{ V}$, $\text{OUT} = \text{Open}$, $V_{EN/UVLO} = 2\text{ V}$, $\text{SWEN} = 10\text{ k}\Omega$ pull-up to 5 V , $R_{ILIM} = 550\ \Omega$, $R_{IMON} = 1.1\text{ k}\Omega$, $\text{DVDT} = \text{Open}$, $\overline{\text{FLT}} = 10\text{ k}\Omega$ pull-up to 5 V , $\text{PG} = 10\text{ k}\Omega$ pull-up to 5 V , $\text{TEMP} = \text{Open}$, $\text{ADDR0} = \text{Open}$, $\text{ADDR1} = \text{Open}$, SCL , SDA and SMBA\# pulled up to 3.3 V . All voltages referenced to GND .

PARAMETER		TEST CONDITIONS	MIN	TYP	MAX	UNIT
I_{OCP}	Steady-state overcurrent protection (Circuit-Breaker) threshold	$R_{\text{IMON}} = 1.1\text{ k}\Omega$, $V_{\text{IREF}} = 1\text{ V}$	48.3	50	51.7	A
		$R_{\text{IMON}} = 1.1\text{ k}\Omega$, $V_{\text{IREF}} = 0.5\text{ V}$	24	25	26	A
		$R_{\text{IMON}} = 1.1\text{ k}\Omega$, $V_{\text{IREF}} = 0.3\text{ V}$	14.4	15	15.6	A
		$R_{\text{IMON}} = 7.87\text{ k}\Omega$, $V_{\text{IREF}} = 0.1\text{ V}$	6.72	7	7.28	A
CURRENT LIMIT (ILIM)						
$G_{\text{ILIM(LIN)}}$	Current Monitor Gain (ILIM:IOUT) vs. IOUT.	Device in steady state (PG asserted)	17.8 7	18.18	18.5 5	$\mu\text{A/A}$
$CL_{\text{REF(SAT)}}$	Ratio of start-up current limit reference to steady-state circuit-breaker reference threshold	$V_{\text{OUT}} > V_{\text{FB}}$, PG not asserted	23.33			%
I_{LIM}	Start-up current limit regulation threshold	$R_{\text{ILIM}} = 314\ \Omega$, $V_{\text{IREF}} = 1.182\text{ V}$, $V_{\text{OUT}} > V_{\text{FB}}$	28	35	43.5	A
		$R_{\text{ILIM}} = 1.1\text{ k}\Omega$, $V_{\text{IREF}} = 1.182\text{ V}$, $V_{\text{OUT}} > V_{\text{FB}}$	9.8	14	18.2	A
		$R_{\text{ILIM}} = 1.54\text{ k}\Omega$, $V_{\text{IREF}} = 1.182\text{ V}$, $V_{\text{OUT}} > V_{\text{FB}}$	7	10	13	A
V_{FB}	Foldback voltage		1.5	2.0	2.5	V
CURRENT LIMIT REFERENCE (IREF/DAC2)						
V_{IREF}	Current Limit Reference DAC output voltage	$V_{\text{IREF}} = 0x32$ (Default), $\text{DEVICE_CONFIG}[6] = 0$	0.99	1.0	1.01	V
		$V_{\text{IREF}} = 0x00$, $\text{DEVICE_CONFIG}[6] = 0$	0.29	0.3	0.31	V
		$V_{\text{IREF}} = 0x3F$, $\text{DEVICE_CONFIG}[6] = 0$	1.17	1.182	1.19	V
DAC2 OUTPUT (IREF/DAC2)						
V_{DAC2}	General purpose DAC 2 output voltage	$\text{GPDAC2} = 0x00$, $\text{DEVICE_CONFIG}[6] = 1$	291	300	308	mV
		$\text{GPDAC2} = 0x1F$, $\text{DEVICE_CONFIG}[6] = 1$	725	733	742	mV
		$\text{GPDAC2} = 0x3F$, $\text{DEVICE_CONFIG}[6] = 1$	1174	1180	1189	mV
DAC1 OUTPUT						
I_{DAC1}	General purpose DAC 1 sink current	$\text{GPDAC1}[6:0] = 0000000b$	5.66	5.98	6.28	μA
		$\text{GPDAC1}[6:0] = 0011111b$	27.7 2	29.21	30.5 7	μA
		$\text{GPDAC1}[6:0] = 0111111b$	50.5 2	53.19	55.5 6	μA
		$\text{GPDAC1}[6:0] = 1xxxxxxb$	0.05			μA
SHORT-CIRCUIT PROTECTION						
I_{FFT}	Fixed fast-trip threshold	PG asserted High	90	113.2	158. 8	A
$SFT_{\text{REF(LIN)}}$	Scalable fast-trip threshold (IMON) to overcurrent protection threshold reference (IREF) ratio during steady-state	$\text{DEVICE_CONFIG}[12:11] = 11$	225			%
		$\text{DEVICE_CONFIG}[12:11] = 10$	200			%
		$\text{DEVICE_CONFIG}[12:11] = 01$	175			%
		$\text{DEVICE_CONFIG}[12:11] = 00$	150			%
$SFT_{\text{REF(SAT)}}$	Scalable fast-trip threshold (ILIM) to overcurrent protection threshold reference (IREF) ratio during inrush		50			%
ACTIVE CURRENT SHARING						
$R_{\text{ON(ACS)}}$	Maximum R_{ON} during steady-state active current sharing	$V_{\text{ILIM}} > CL_{\text{REF(ACS)}}\% \times V_{\text{IREF}}$	1 1.81			m Ω

7.5 Electrical Characteristics (continued)

(Test conditions unless otherwise noted) - $-40^{\circ}\text{C} \leq T_J \leq 125^{\circ}\text{C}$, $V_{IN} = 12\text{ V}$, $V_{DD} = 12\text{ V}$, $\text{OUT} = \text{Open}$, $V_{EN/UVLO} = 2\text{ V}$, $\text{SWEN} = 10\text{ k}\Omega$ pull-up to 5 V , $R_{ILIM} = 550\ \Omega$, $R_{IMON} = 1.1\text{ k}\Omega$, $\text{DVDT} = \text{Open}$, $\overline{\text{FLT}} = 10\text{ k}\Omega$ pull-up to 5 V , $\text{PG} = 10\text{ k}\Omega$ pull-up to 5 V , $\text{TEMP} = \text{Open}$, $\text{ADDR0} = \text{Open}$, $\text{ADDR1} = \text{Open}$, SCL , SDA and SMBA\# pulled up to 3.3 V . All voltages referenced to GND .

PARAMETER		TEST CONDITIONS	MIN	TYP	MAX	UNIT
$G_{\text{IMON(ACS)}}$	IMON:IOUT ratio during active current sharing	PG asserted High, $V_{\text{ILIM}} > \text{CL}_{\text{REF(ACS)}}\% \times V_{\text{IREF}}$	18.0	18.36	18.7	$\mu\text{A/A}$
$\text{CL}_{\text{REF(ACS)}}$	Ratio of active current sharing trigger threshold to steady state overcurrent protection threshold	PG asserted High		36.67		%
INRUSH CURRENT PROTECTION (DVDT)						
I_{DVDT}	dVdt pin charging current	DEVICE_CONFIG[10:9] = 11	2.38	3	4	μA
		DEVICE_CONFIG[10:9] = 10	1.4	2	2.9	μA
		DEVICE_CONFIG[10:9] = 01	1	1.5	2	μA
		DEVICE_CONFIG[10:9] = 00	0.79	1	1.33	μA
G_{DVDT}	dVdt gain		20.7		V/V	
R_{DVDT}	dVdt pin to GND discharge resistance		510		Ω	
GHI						
$R_{\text{ON(GHI)}}$	R_{ON} when PG is asserted		1	1.81		$\text{m}\Omega$
QUICK OUTPUT DISCHARGE (QOD)						
I_{QOD}	Quick output discharge internal pull-down current on OUT	$V_{\text{SD(F)}} < V_{\text{EN}} < V_{\text{UVLO(F)}}$	10.8	22.1	38	mA
OVERTEMPERATURE PROTECTION (OTP)						
TSD	Thermal shutdown threshold	T_J Rising		149		$^{\circ}\text{C}$
TSD_{HYS}	Thermal shutdown hysteresis	T_J Falling		11		$^{\circ}\text{C}$
TEMPERATURE SENSOR OUTPUT (TEMP/CMP)						
G_{TMP}	TEMP sensor gain		2.58	2.65	2.72	$\text{mV}/^{\circ}\text{C}$
V_{TMP}	TEMP pin output voltage	$T_J = 25^{\circ}\text{C}$	672	678	685	mV
I_{TMPSRC}	TEMP pin sourcing current		75	93.4	115.6	μA
I_{TMPSNK}	TEMP pin sinking current		7.6	10	14	μA
COMPARATORS (TEMP/CMP, AUX)						
I_{CMPLKG}	TEMP/CMP input leakage current	$0 \leq V_{\text{TEMP/CMP}} \leq 1.2\text{ V}$, TEMP/CMP pin configured as comparator 1 input			1	μA
I_{AUXLKG}	AUX input leakage current	$0 \leq V_{\text{AUX}} \leq 1.2\text{ V}$			1	μA
V_{CMP1REF}	Comparator 1 reference voltage	VCMPXREF[3:0] = 0000	176	199.5	224	mV
		VCMPXREF[3:0] = 0011	476	501.8	524	mV
		VCMPXREF[3:0] = 0111	876	900.4	923	mV
		VCMPXREF[3:0] = 1111	1676	1700.4	1722	mV
V_{CMP2REF}	Comparator 2 reference voltage	VCMPXREF[7:4] = 0000	176	199.4	224	mV
		VCMPXREF[7:4] = 0011	476	500.1	524	mV
		VCMPXREF[7:4] = 0111	876	899.7	923	mV
		VCMPXREF[7:4] = 1111	1677	1699.2	1722	mV
FET HEALTH MONITOR						
V_{DSFLT}	FET D-S Fault Threshold	SWEN = L	0.35	0.49	0.59	V
ADDRESS SELECT (ADDR0/1)						

7.5 Electrical Characteristics (continued)

(Test conditions unless otherwise noted) - $-40^{\circ}\text{C} \leq T_J \leq 125^{\circ}\text{C}$, $V_{IN} = 12\text{ V}$, $V_{DD} = 12\text{ V}$, $\text{OUT} = \text{Open}$, $V_{EN/UVLO} = 2\text{ V}$, $\text{SWEN} = 10\text{ k}\Omega$ pull-up to 5 V , $R_{ILIM} = 550\ \Omega$, $R_{IMON} = 1.1\text{ k}\Omega$, $\text{DVDT} = \text{Open}$, $\overline{\text{FLT}} = 10\text{ k}\Omega$ pull-up to 5 V , $\text{PG} = 10\text{ k}\Omega$ pull-up to 5 V , $\text{TEMP} = \text{Open}$, $\text{ADDR0} = \text{Open}$, $\text{ADDR1} = \text{Open}$, SCL , SDA and SMBA\# pulled up to 3.3 V . All voltages referenced to GND .

PARAMETER		TEST CONDITIONS	MIN	TYP	MAX	UNIT
I_{ADDR}	ADDR0 pin pull-up current		3.85	5.05	6.25	μA
	ADDR1 pin pull-up current		3.85	5.05	6.25	μA
SINGLE POINT FAILURE (ILIM, IMON, IREF)						
$I_{\text{OC_BKP(LIN)}}$	Back-up overcurrent protection threshold (steady -state)		65	90	131	A
$I_{\text{OC_BKP(SAT)}}$	Back-up overcurrent protection threshold (start-up)		55	90	112	A

7.6 Logic Interface DC Characteristics

over operating free-air temperature range (unless otherwise noted)

PARAMETER		TEST CONDITIONS	MIN	TYP	MAX	UNIT
GPIOx						
V_{OL}	GPIOx output logic low	Pin configured as output, de-asserted Low. Sink current = 20 mA .			0.27	V
V_{OH}	GPIOx output logic high	Pin configured as output, asserted high	1.7			V
V_{IH}	GPIOx input logic high	Pin configured as input	1.65			V
V_{IL}	GPIOx input logic low	Pin configured as input			0.75	V
R_{GPIO}	GPIOx pin pull-down resistance	Pin configured as output, de-asserted Low			13	Ω
$I_{\text{GPIO LKG}}$	GPIOx pin leakage current	Pin configured as output, asserted high			1	μA
PMBus (SCL/SDA)						
$C_{\text{PMB-BUS}}$	PMBus Bus Capacitance				400	pF
$C_{\text{PMB-PIN}}$	PMBus Pin Capacitance - SCL				10	pF
$C_{\text{PMB-PIN}}$	PMBus Pin Capacitance - SDA				10	pF
$V_{\text{PULLUP_PMBus}}$	PMBus interface pull ups		1.62		3.63	V
$V_{\text{IL_PMBus}}$	SDA Input logic low				0.85	V
$V_{\text{IL_PMBus}}$	SCL Input logic low				0.85	V
$V_{\text{IH_PMBus}}$	SCL Input logic high		1.35			V
$V_{\text{IH_PMBus}}$	SDA Input logic high		1.35			V
$V_{\text{OL_PMBus}}$	Low-level output voltage - SCL	$I_{\text{OL}} = -20\text{ mA}$			0.4	V
$V_{\text{OL_PMBus}}$	Low-level output voltage - SDA	$I_{\text{OL}} = -20\text{ mA}$			0.4	V

7.7 Telemetry

over operating free-air temperature range (unless otherwise noted)

PARAMETER	TEST CONDITIONS	MIN	TYP	MAX	UNIT
Telemetry					
ADC Resolution			10		bits
ADC Voltage reference (V_{REF})			1.95		V
Analog Input Range		0		V_{REF}	V

7.7 Telemetry (continued)

over operating free-air temperature range (unless otherwise noted)

PARAMETER	TEST CONDITIONS	MIN	TYP	MAX	UNIT
Sampling rate	ADC normal mode (Default)		460		KHz
	ADC high performance mode (DEVICE_CONFIG[3] = 1)		270		KHz
DNL	ADC normal mode (Default)			4	LSB
	ADC high performance mode (DEVICE_CONFIG[3] = 1)			0.75	LSB
INL	ADC normal mode (Default)			6	LSB
	ADC high performance mode (DEVICE_CONFIG[3] = 1)			2.9	LSB
V _{AUX} Absolute error	ADC normal mode (Default), V _{AUX} = 1.95 V (Full-scale), 1 sample	- 1.5		1.5	%FS
	ADC high performance mode (DEVICE_CONFIG[3] = 1), V _{AUX} = 1.95 V (Full-scale), 1 sample	- 1		1	%FS
	ADC normal mode (Default), V _{AUX} = 1.95 V (Full-scale), 128 sample average	- 1		1	%FS
	ADC high performance mode (DEVICE_CONFIG[3] = 1), V _{AUX} = 1.95 V (Full-scale), 128 sample average	- 0.5		0.5	%FS
V _{IN} Absolute error	ADC high performance mode (DEVICE_CONFIG[3] = 1), V _{IN} = 12 V, 1 sample	- 1.5		1.5	%FS
	ADC high performance mode (DEVICE_CONFIG[3] = 1), V _{IN} = 12 V, 128 sample average	- 0.75		0.75	%FS
V _{OUT} Absolute error	ADC high performance mode (DEVICE_CONFIG[3] = 1), V _{OUT} = 12 V, 1 sample	- 1.5		1.5	%FS
	ADC high performance mode (DEVICE_CONFIG[3] = 1), V _{OUT} = 12 V, 128 sample average	- 0.75		0.75	%FS
V _{TEMP} Absolute error	ADC high performance mode (DEVICE_CONFIG[3] = 1), V _{TEMP} = 1.95 V (Full-scale), 1 sample	- 10		10	°C
	ADC high performance mode (DEVICE_CONFIG[3] = 1), V _{TEMP} = 1.95 V (Full-scale), 128 sample average	- 8		8	°C
IMON Absolute error	ADC high performance mode (DEVICE_CONFIG[3] = 1), V _{IMON} = 0.8 V, 1 sample	- 1		1	%FS
	ADC high performance mode (DEVICE_CONFIG[3] = 1), V _{IMON} = 0.8 V, 128 sample average	- 0.5		0.5	%FS
P _{IN} Absolute error	ADC high performance mode (DEVICE_CONFIG[3] = 1), V _{IN} = 12 V, V _{IMON} = 1.95 V (Full-scale), 1 sample	- 2		2	%FS
	ADC high performance mode (DEVICE_CONFIG[3] = 1), V _{IN} = 12 V, V _{IMON} = 1.95 V (Full-scale), 128 sample average	- 1.25		1.25	%FS

7.7 Telemetry (continued)

over operating free-air temperature range (unless otherwise noted)

PARAMETER	TEST CONDITIONS	MIN	TYP	MAX	UNIT
E_{IN} absolute error	ADC high performance mode (DEVICE_CONFIG[3] = 1), Accumulated energy over 5 ms interval, $V_{IN} = 12$ V, $V_{MON} = 0.8$ V	- 2.5		2.5	%

7.8 PMBus Interface Timing Characteristics

over operating free-air temperature range (unless otherwise noted)

PARAMETER		TEST CONDITIONS	MIN	TYP	MAX	UNIT
PMBus Timing Characteristics						
PMB _{CLKR}	PMBus clock frequency range	PMBus Clock Requirements	0.05		1.2	MHz
t _{PMB-BUF}	PMBus Free time between STOP and START conditions		0.5			μs
t _{PMB-HD-STA}	Hold time after Repeated Start Condition		0.26			μs
t _{PMB-SU-STO}	Stop condition Setup time		0.26			μs
t _{PMB-HD-DAT}	SDA Hold Time		0			μs
t _{PMB-SU-DAT}	SDA Setup Time		50			ns
t _{PMB-TIMEOUT}	SCLK low timeout		25		35	ms
t _{PMB-LOW}	SCLK low time		0.5			μs
t _{PMB-HIGH}	SCLK high time		0.26		50	μs
t _{R-PMB}	SDA/SCLK rise time (V _{IL(MAX)} -150 mV to V _{IH(MIN)} +150 mV)	100 kHz Class			300	ns
		400 kHz Class			300	ns
		1000 kHz Class			120	ns
t _{F-PMB}	SDA/SCLK fall time, (V _{IH(MIN)} +150 mV to V _{IL(MAX)} + 150 mV)	100 kHz Class			1000	ns
		400 kHz Class			300	ns
		1000 kHz Class			120	ns

7.9 External EEPROM Interface Timing Characteristics

over operating free-air temperature range (unless otherwise noted)

PARAMETER		TEST CONDITIONS	MIN	TYP	MAX	UNIT
EE Interface Timing Characteristics						
EE _{CLKR}	EECLK clock frequency range			0.4		MHz
t _{EE-SU-STO}	Stop condition Setup time		0.26			μs
t _{EE-HD-DAT}	EEDATA Hold Time		0			μs
t _{EE-SU-DAT}	EEDATA Setup Time		50			ns
t _{HD-STA}	Hold time after (REPEATED) START Condition		0.6			μs
t _{EE-LOW}	EECLK low time		0.5			μs
t _{EE-HIGH}	EECLK high time		0.26		50	μs
t _{R-EE}	EEDATA/EECLK rise time (V _{IL(MAX)} -150 mV to V _{IH(MIN)} +150 mV)	400 kHz Class			300	ns
t _{F-EE}	EEDATA/EECLK fall time, (V _{IH(MIN)} +150 mV to V _{IL(MAX)} + 150 mV)	400 kHz Class			300	ns

7.10 Timing Requirements

PARAMETER		TEST CONDITIONS	MIN	TYP	MAX	UNIT
t_{OVP}	Overvoltage protection response time	$V_{IN} > V_{OVP(R)}$ to SWEN ↓		1.2		μs
t_{Insdl}	Insertion delay	$V_{DD} > V_{UVP(R)}$ to SWEN ↑, INS_DLY = 0x00		14		ms
		$V_{DD} > V_{UVP(R)}$ to SWEN ↑, INS_DLY = 0x07		560		ms
t_{FFT}	Fixed Fast-Trip response time Hard Short	$I_{OUT} > 1.3 \times I_{FFT}$ to $I_{OUT} \downarrow$		267		ns
t_{SFT}	Scalable Fast-Trip response time	$I_{OUT} > 3 \times I_{OCP}$ to $I_{OUT} \downarrow$		343		ns
t_{CMP1}	TEMP/CMP pin comparator (COMP1) response time	VCMP1THR = 1 V, $V_{TEMP/CMP} > 1.2 \times$ VCMP1THR to CMP1OUT ↑		377		ns
t_{CMP2}	AUX pin comparator (COMP2) response time	VCMP2THR = 1 V, $V_{AUX} > 1.2 \times$ VCMP1THR to CMP2OUT ↑		377		ns
t_{OC_TIMER}	Overcurrent blanking interval	$I_{OUT} = 1.3 \times I_{OCP}$, OC_TIMER = 0x00		0		ms
		$I_{OUT} = 1.3 \times I_{OCP}$, OC_TIMER = 0x14 (Default)		2.1		ms
		$I_{OUT} = 1.3 \times I_{OCP}$, OC_TIMER = 0xFF		27.3		ms
t_{RETRY}	Auto-Retry Interval	RETRY_CONFIG[2:0] = 000		55		ms
		RETRY_CONFIG[2:0] = 111		6940		ms
$t_{EN(DG)}$	EN/UVLO de-glitch time			12.2		μs
t_{SU_TMR}	Start-up timeout interval	SWEN ↑ to FLT ↓		232		ms
t_{QOD}	QOD enable timer	$V_{SD(F)} < V_{EN/UVLO} < V_{UVLO(F)}$		4.38		ms
$t_{Discharge}$	QOD discharge time (90% to 10% of V_{OUT})	$V_{SD(F)} < V_{EN/UVLO} < V_{UVLO(F)}$, $V_{IN} = 12$ V, $C_{OUT} = 1$ mF		488		ms
t_{PGA}	PG assertion delay	DEVICE_CONFIG[15] = 0, Device in steady state, $V_{OUT} > V_{OUT_PGTH}$ to PG ↑		98		μs
t_{PGA}	PG assertion delay	DEVICE_CONFIG[15] = 1, Device in steady state, $V_{OUT} > V_{OUT_PGTH}$ to PG ↑		36.6		ms
t_{PGD}	PG De-assertion de-glitch	Device in steady state, $V_{OUT} < V_{OUT_PGTH}$ to PG ↓		34		μs

7.11 Switching Characteristics

The output rising slew rate is internally controlled and constant across the entire operating voltage range to ensure the turn on timing is not affected by the load conditions. The rising slew rate can be adjusted by adding capacitance from the dVdt pin to ground. As C_{dVdt} is increased it will slow the rising slew rate (SR). See Slew Rate and Inrush Current Control (dVdt) section for more details. The Turn-Off Delay and Fall Time, however, are dependent on the RC time constant of the load capacitance (C_{OUT}) and Load Resistance (R_L). The Switching Characteristics are only valid for the power-up sequence where the supply is available in steady state condition and the load voltage is completely discharged before the device is enabled. Typical values are taken at $T_J = 25^\circ\text{C}$ unless specifically noted otherwise. $V_{IN} = 12\text{ V}$, $R_{OUT} = 500\ \Omega$, $C_{OUT} = 1\text{ mF}$

PARAMETER		$C_{dVdt} = 22\text{ nF}$, DEVICE_CONF IG[10:9] = 10	$C_{dVdt} = 22\text{ nF}$, DEVICE_CONF IG[10:9] = 00	$C_{dVdt} = 22\text{ nF}$, DEVICE_CONF IG[10:9] = 11	$C_{dVdt} = 33\text{ nF}$, DEVICE_CONF IG[10:9] = 10	$C_{dVdt} = 33\text{ nF}$, DEVICE_CONF IG[10:9] = 00	$C_{dVdt} = 33\text{ nF}$, DEVICE_CONF IG[10:9] = 11	UNITS
SR_{ON}	Output rising slew rate	1.99	0.96	2.92	1.34	0.66	2.01	V/ms
$t_{D,ON}$	Turn on delay	1.47	2.99	0.98	2.19	4.37	1.42	ms
t_R	Rise time	5.07	10.36	3.41	7.40	15.2	4.94	ms
t_{ON}	Turn on time	6.55	13.36	4.39	9.53	19.57	6.36	ms
$t_{D,OFF}$	Turn off delay	1.1	1.1	1.1	1.1	1.1	1.1	ms
t_F	Fall time	Depends on R_{OUT} and C_{OUT}						ms

7.12 Typical Characteristics



图 7-1. ON Resistance Across Temperature



图 7-2. VDD Undervoltage Thresholds Across Temperature

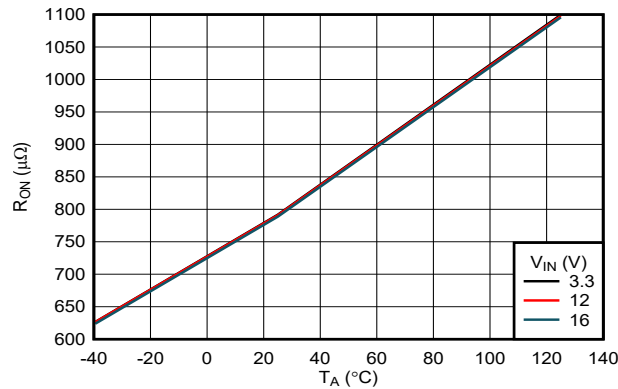

图 7-3. VIN Undervoltage Thresholds Across Temperature

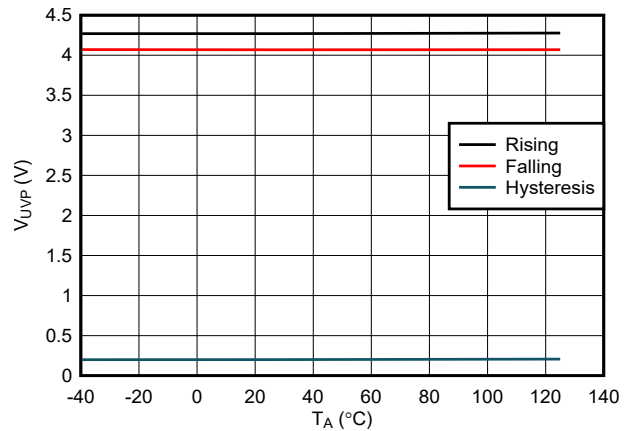

图 7-4. VIN Undervoltage Thresholds Across Temperature (VIN_UV_FLT = 0x38)

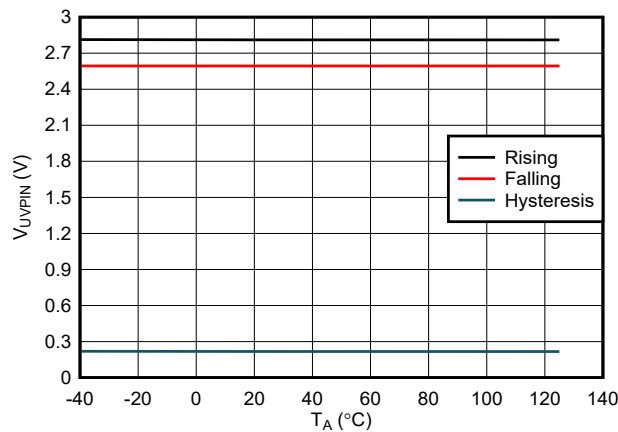

图 7-5. VIN Undervoltage Thresholds Across Temperature (VIN_UV_FLT = 0x8D)

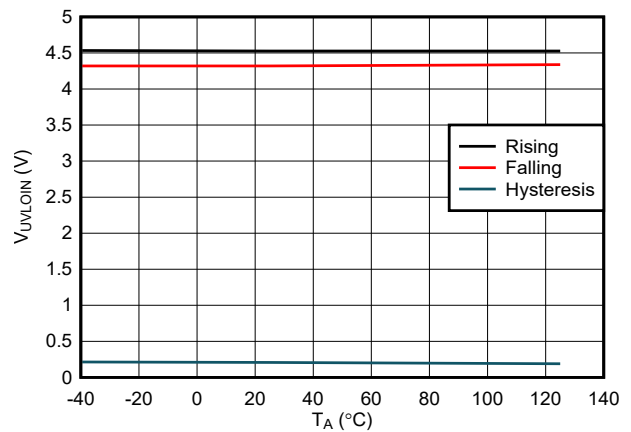

图 7-6. VIN Overvoltage Protection Threshold Across Temperature (VIN_OV_FLT = 0x0E (Default))

7.12 Typical Characteristics (continued)

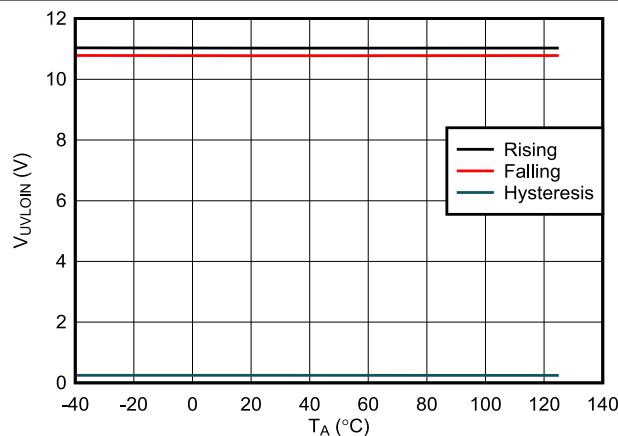

图 7-7. VIN Overvoltage Protection Threshold Across Temperature (VIN_OV_FLT = 0x01)

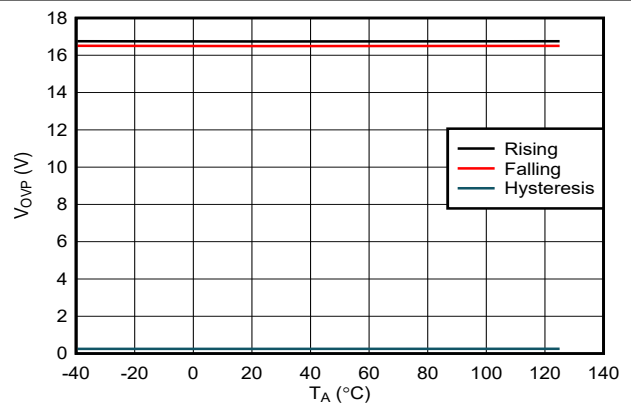

图 7-8. VIN Overvoltage Protection Threshold Across Temperature (VIN_OV_FLT = 0x0B)

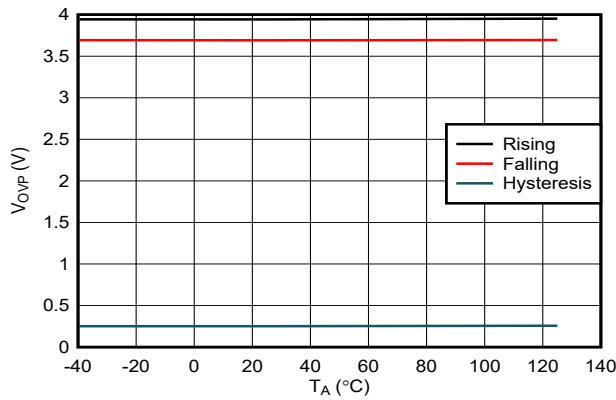

图 7-9. EN/UVLO Based Turn-off Thresholds Across Temperature

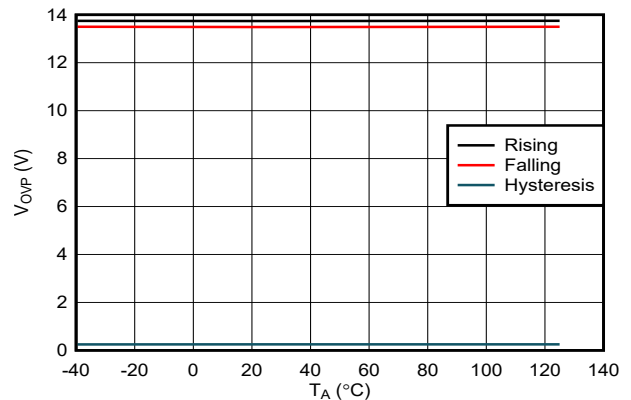

图 7-10. EN/UVLO Based Shutdown Thresholds Across Temperature

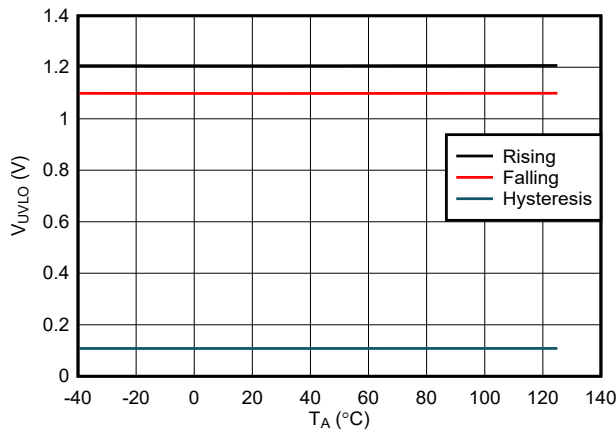

图 7-11. IMON Gain Across Load and Temperature

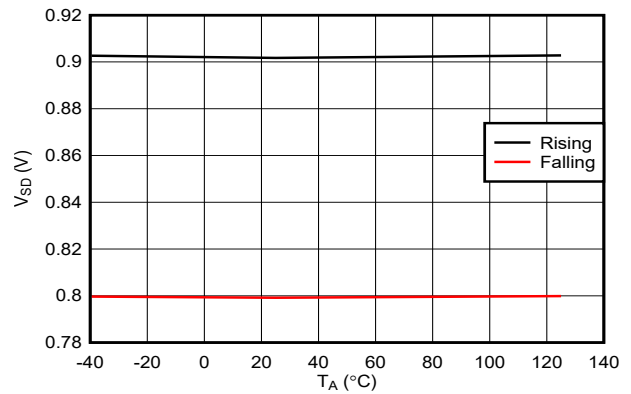

图 7-12. IMON Gain Accuracy Across Process, Voltage and Temperature Corners

7.12 Typical Characteristics (continued)

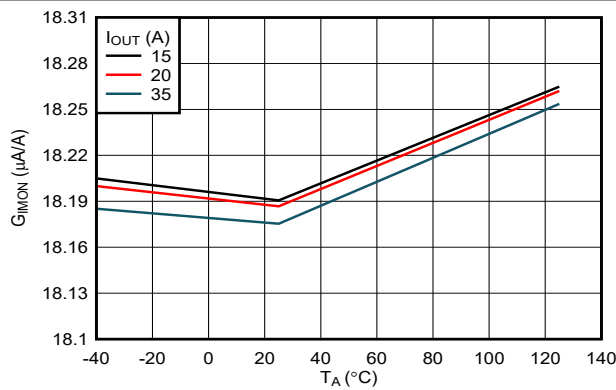

图 7-13. VIREF DAC Transfer Function

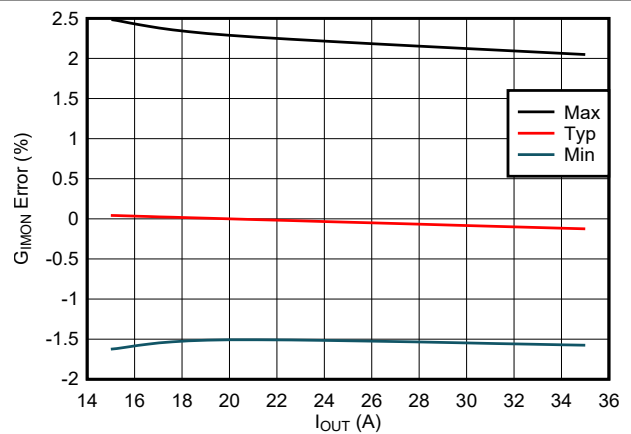

图 7-14. Steady-state Overcurrent Protection Threshold (Circuit-Breaker) Accuracy

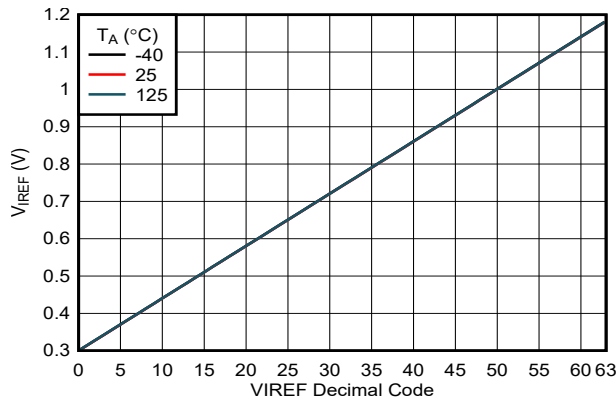

图 7-15. ILIM Gain Across Load and Temperature

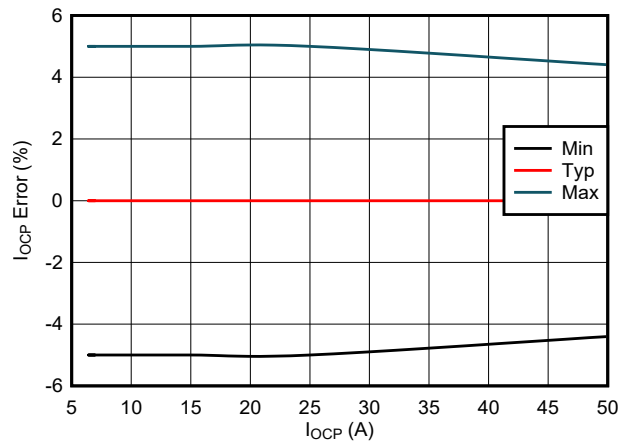

图 7-16. Startup Overcurrent Protection Threshold (Current Limit) Accuracy

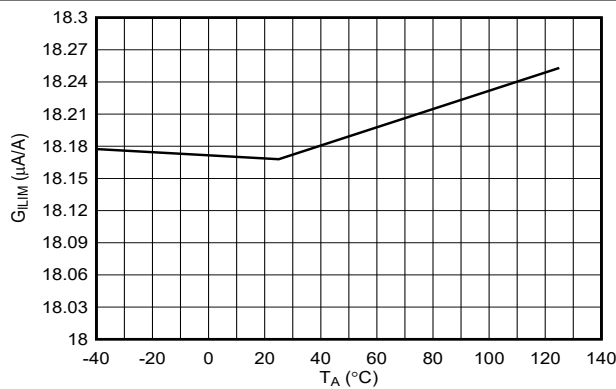

图 7-17. Scalable Fast-trip Threshold Ratio Across Temperature (Steady-state)

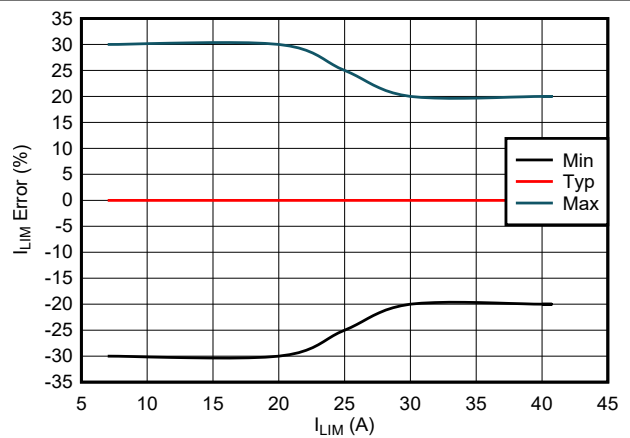

图 7-18. Scalable Fast-trip Threshold Ratio Across Temperature (Startup)

7.12 Typical Characteristics (continued)

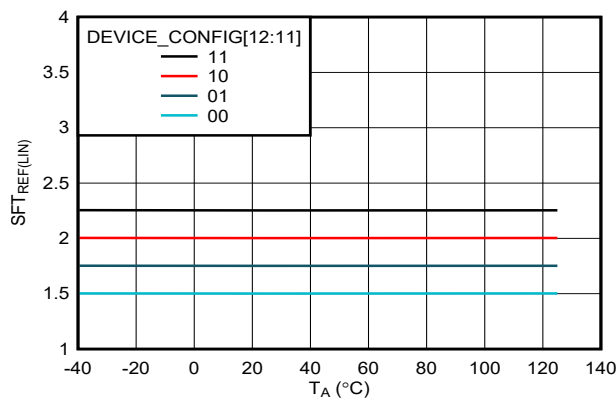

图 7-19. Fixed Fast-trip Threshold Across Temperature

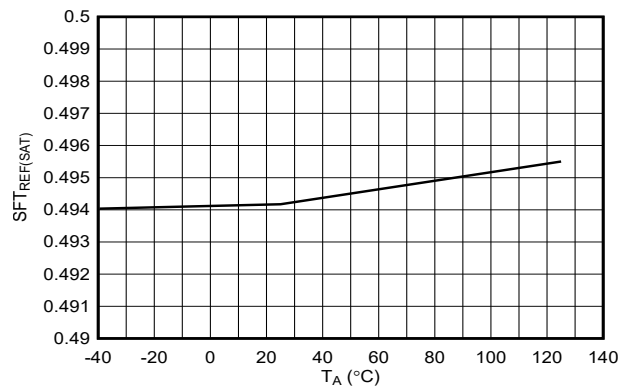

图 7-20. Backup Overcurrent Protection Threshold (Startup) Accuracy

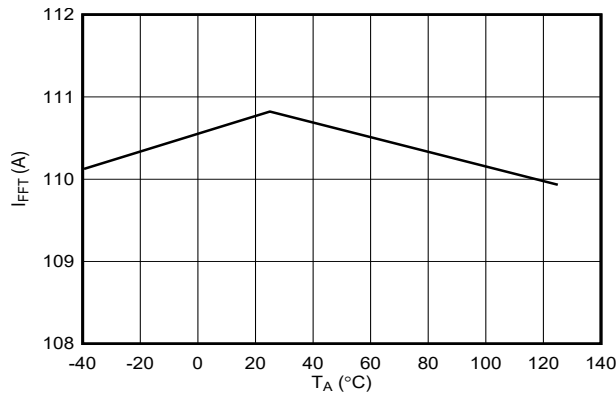

图 7-21. Backup Overcurrent Protection Threshold (Steady-state) Accuracy

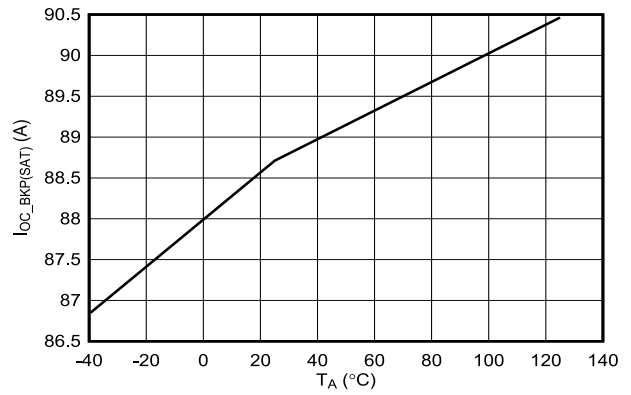

图 7-22. DVDT Pin Charging Current Across Temperature

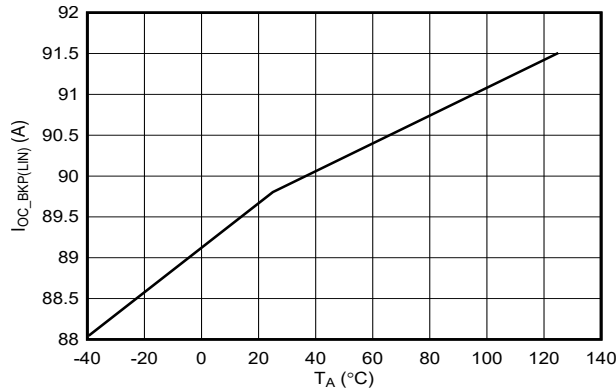

图 7-23. DVDT Gain Across Temperature

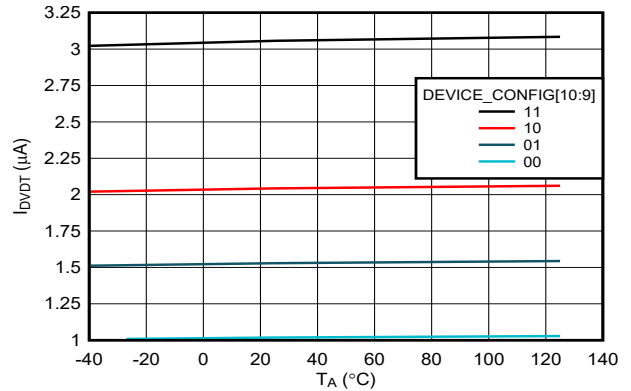

ADC high performance mode (DEVICE_CONFIG[3] = 1)

图 7-24. ADC INL

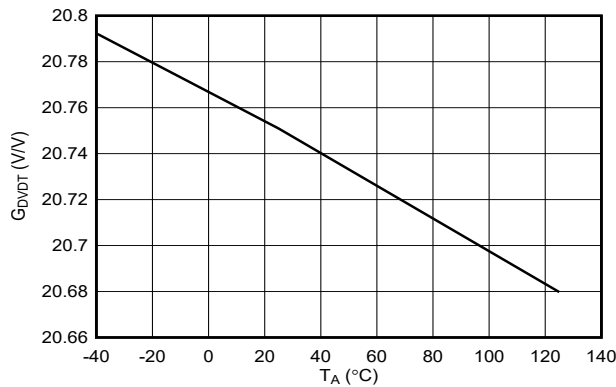
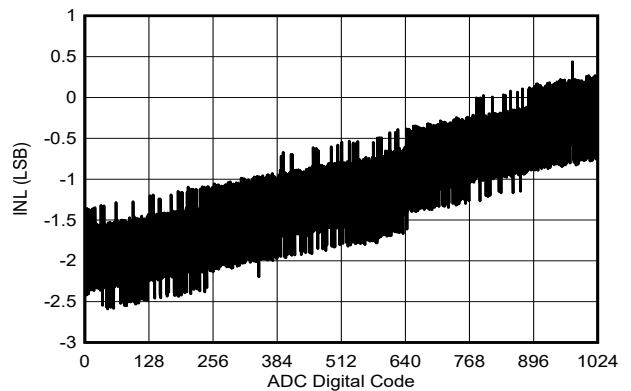
7.12 Typical Characteristics (continued)



图 7-25. ADC Histogram (Mid-scale Analog Input)



图 7-26. General Purpose DAC1 Transfer Function

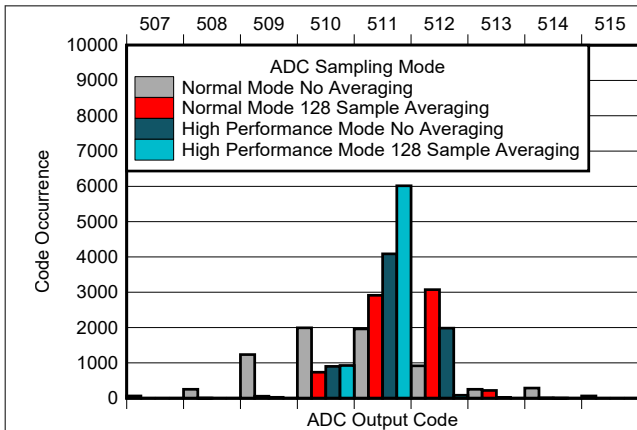

图 7-27. General Purpose DAC2 Transfer Function

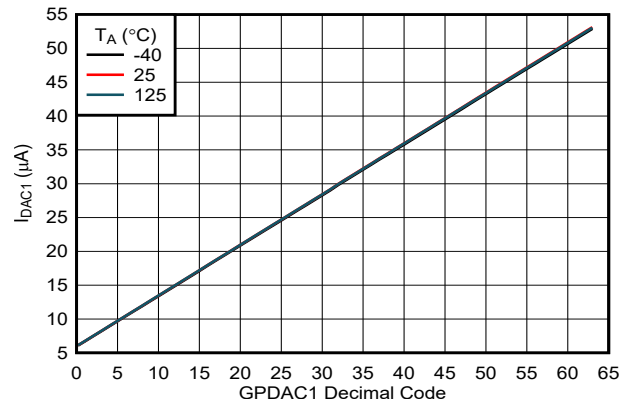

图 7-28. General Purpose Comparators Reference DAC Transfer Function

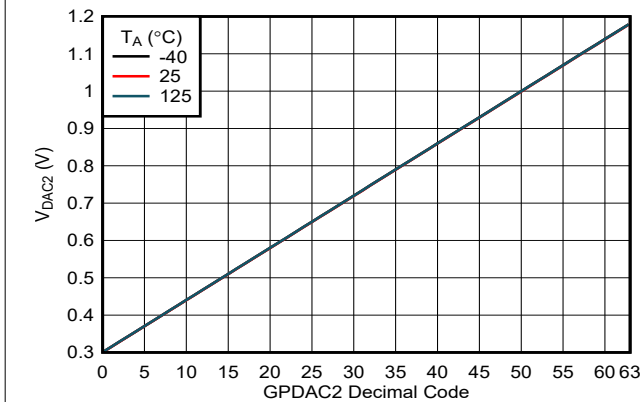

图 7-29. SWEN/General Purpose Input Pin Logic Thresholds Across Temperature

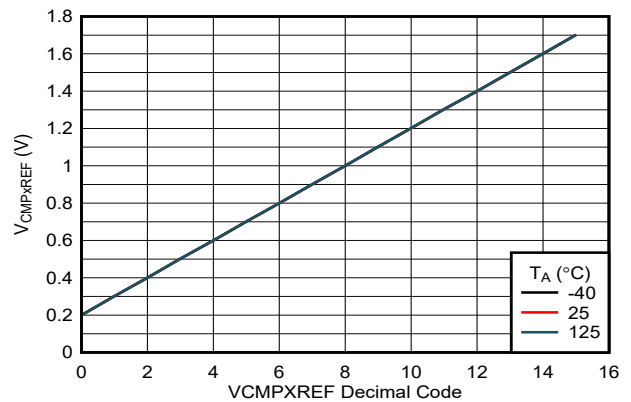

图 7-30. PGOOD/FLT/General Purpose Output Pin Logic Level Across Temperature

7.12 Typical Characteristics (continued)

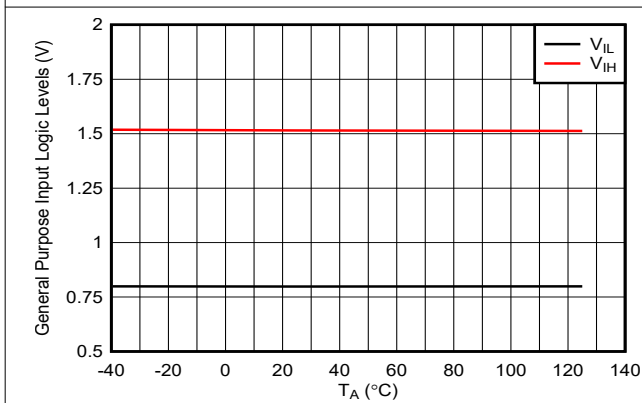

图 7-31. QOD Sink Current Across Temperature

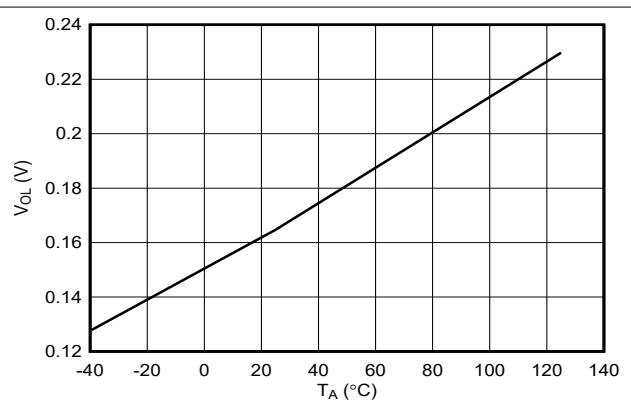

图 7-32. Junction Temperature vs Load Current (No Air-Flow)

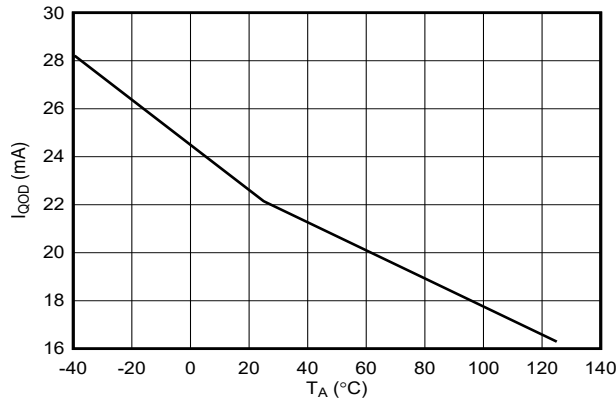

图 7-33. Junction Temperature vs Load Current (With Air-Flow)

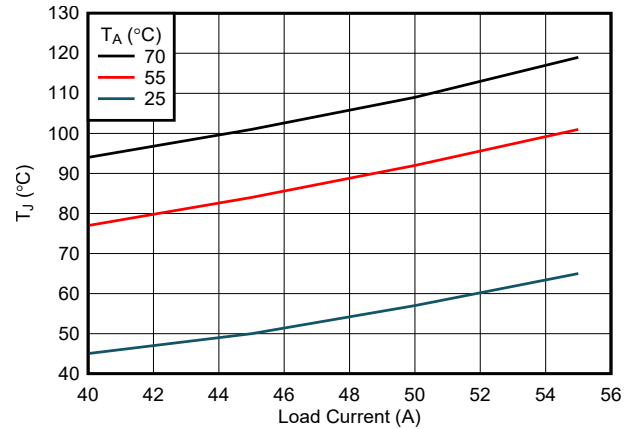

EN held high, IN supply ramped up to 12 V. $C_{OUT} = 18$ mF, $C_{dVdt} = 33$ nF

图 7-34. Power Up Using Supply

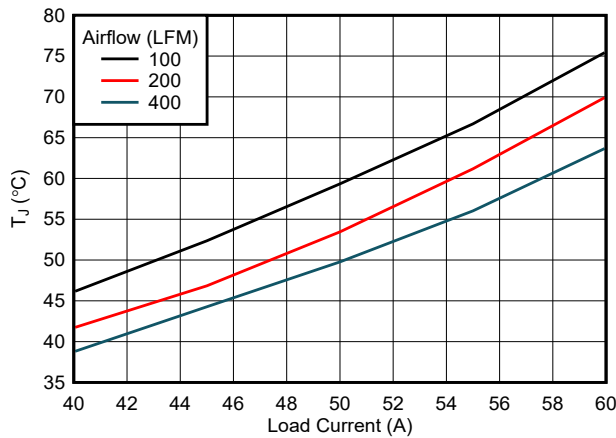
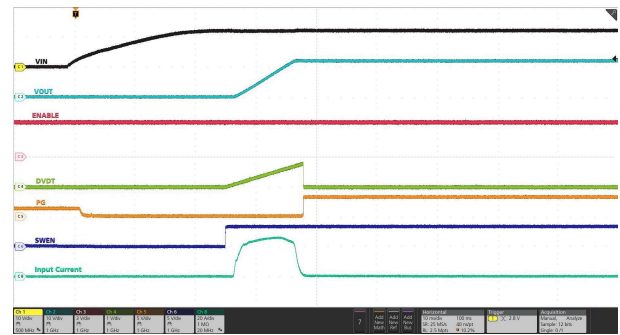
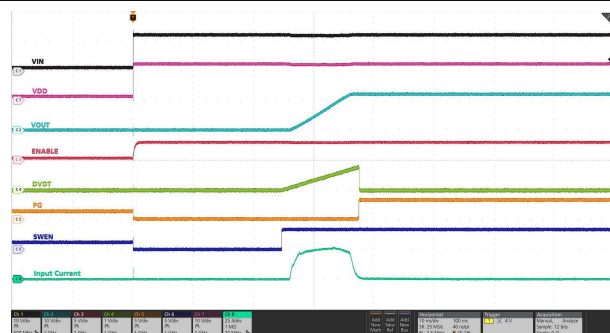

IN hot-plugged to 12 V supply. $C_{OUT} = 18$ mF, $C_{dVdt} = 33$ nF, Insertion Delay programmed to 25 ms ($INS_DLY = 0x01$)

图 7-35. Input Hot Plug



IN hot-plugged to 12 V supply. $C_{OUT} = 18$ mF, $C_{dVdt} = 33$ nF, Insertion Delay programmed to 560 ms ($INS_DLY = 0x07$)

图 7-36. Input Hot Plug

7.12 Typical Characteristics (continued)



IN supply held steady at 12 V, EN pin held high, PMBus OPERATION OFF Command. $C_{OUT} = 18\text{ mF}$, $C_{dVdt} = 33\text{ nF}$

图 7-37. Power Down Using PMBus Command

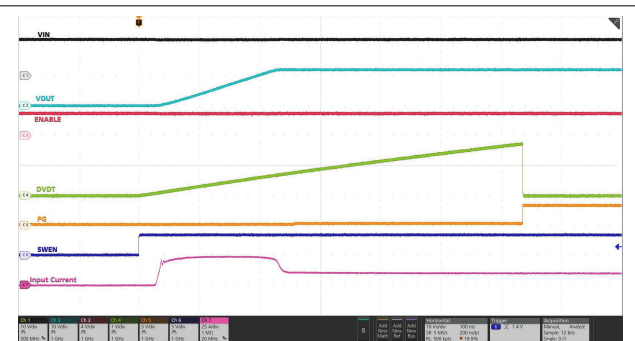

IN supply held steady at 12 V, EN pin held high, PMBus OPERATION ON Command. $C_{OUT} = 18\text{ mF}$, $C_{dVdt} = 33\text{ nF}$

图 7-38. Power Up Using PMBus Command

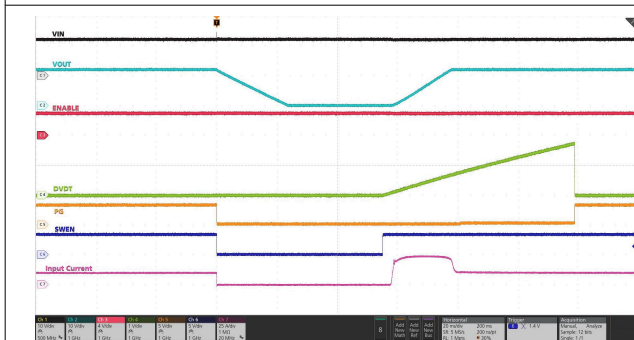

IN supply held steady at 12 V, EN pin held high, PMBus POWER_CYCLE Command. $C_{OUT} = 18\text{ mF}$, $C_{dVdt} = 33\text{ nF}$, Default delay setting (RETRY_CONFIG[2:0] = 000b)

图 7-39. Power Cycle Using PMBus Command



IN supply held steady at 12 V, EN pin toggled from low to high. $C_{OUT} = 18\text{ mF}$, $C_{dVdt} = 33\text{ nF}$

图 7-40. Power Up Using EN

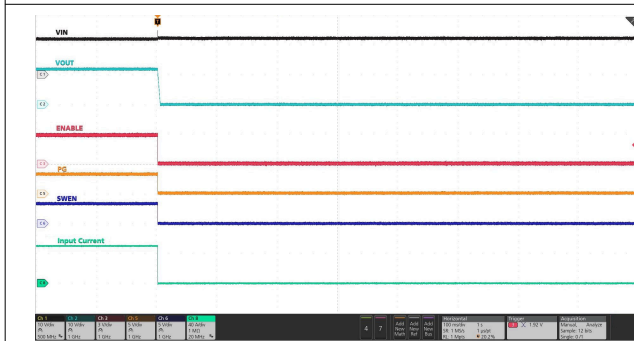

IN supply held steady at 12 V, EN pin toggled from high to low. $C_{OUT} = 18\text{ mF}$, $C_{dVdt} = 33\text{ nF}$, $I_{LOAD} = 50\text{ A}$

图 7-41. Power Down Using EN

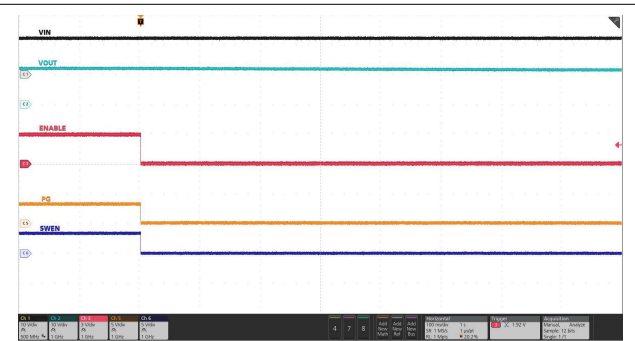

IN supply held steady at 12 V, EN pin toggled from high to low. $C_{OUT} = 18\text{ mF}$, $C_{dVdt} = 33\text{ nF}$, $I_{LOAD} = 0\text{ A}$

图 7-42. Power Down Using EN Without Output Discharge

7.12 Typical Characteristics (continued)

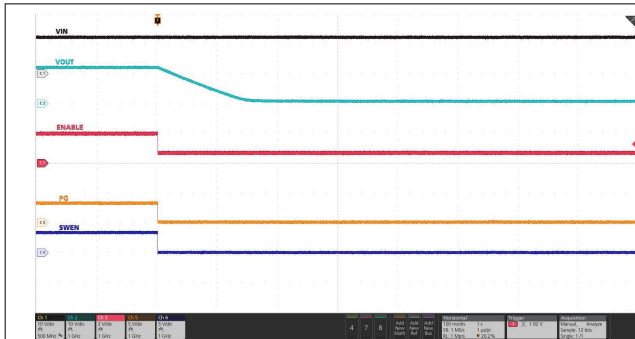

IN supply held steady at 12 V, EN pin pulled down to 1 V for > 5 ms. $C_{OUT} = 18\text{ mF}$, $C_{dVdt} = 33\text{ nF}$, $I_{LOAD} = 0\text{ A}$

图 7-43. Power Down Using EN With Output Discharge

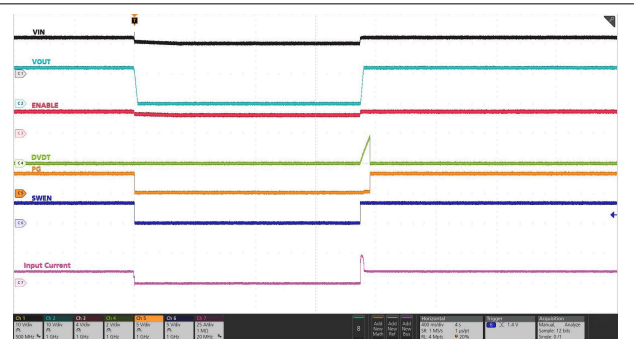

VIN Undervoltage falling threshold programmed to 10.8 V ($VIN_UV_FLT = 0x8D$), EN held high, IN supply ramped down from 12 V to 10.5 V and then ramped up again to 12 V. $C_{OUT} = 18\text{ mF}$, $C_{dVdt} = 33\text{ nF}$

图 7-44. Input Undervoltage Protection

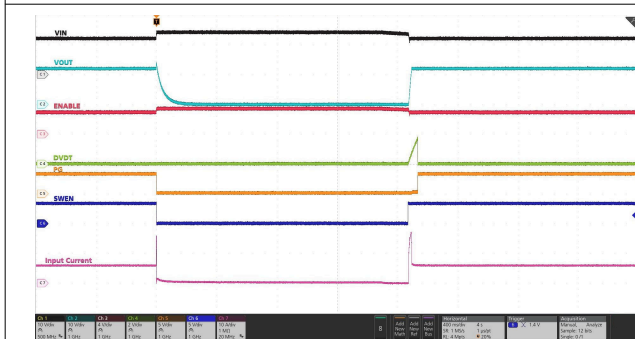

VIN Overvoltage rising threshold programmed to 13.78 V ($VIN_OV_FLT = 0x0B$), EN held high, IN supply ramped up from 12 V to 15 V and then ramped down again to 12 V. $C_{OUT} = 18\text{ mF}$, $C_{dVdt} = 33\text{ nF}$

图 7-45. Input Overvoltage Protection

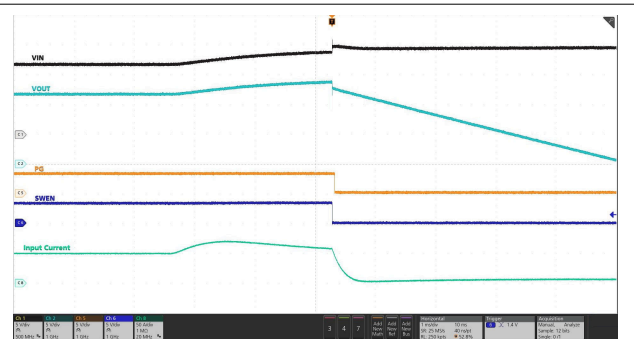

VIN Overvoltage rising threshold programmed to 13.78 V ($VIN_OV_FLT = 0x0B$), EN held high, IN supply ramped up from 12 V to 15 V and then ramped down again to 12 V. $C_{OUT} = 18\text{ mF}$, $C_{dVdt} = 33\text{ nF}$

图 7-46. Input Overvoltage Protection



IN supply held steady at 12 V, EN toggled from low to high. $C_{OUT} = 18\text{ mF}$, $C_{dVdt} = 33\text{ nF}$, DVDT scaling at 100 % (default), $DEVICE_CONFIG[10:9] = 10b$

图 7-47. Inrush Current Control

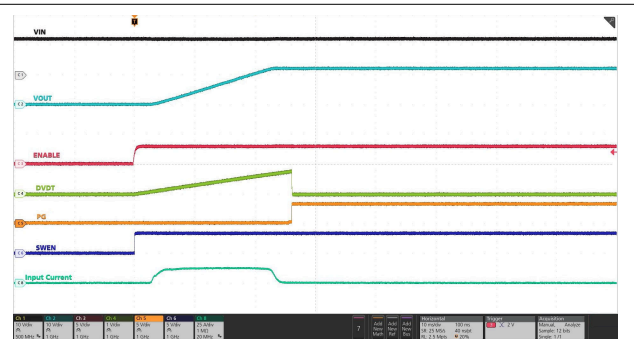

IN supply held steady at 12 V, EN toggled from low to high. $C_{OUT} = 18\text{ mF}$, $C_{dVdt} = 33\text{ nF}$, DVDT scaling at 50 % ($DEVICE_CONFIG[10:9] = 00b$)

图 7-48. Inrush Current Control

7.12 Typical Characteristics (continued)

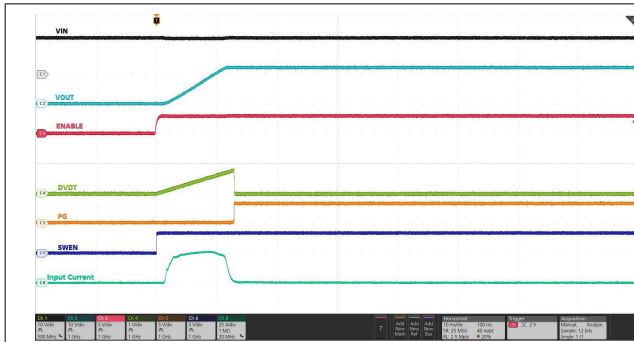

IN supply held steady at 12 V, EN toggled from low to high.
 $C_{OUT} = 18\text{ mF}$, $C_{dVdt} = 33\text{ nF}$, Default PG delay setting
 (DEVICE_CONFIG[15] = 0b)

图 7-49. Power Good Assertion

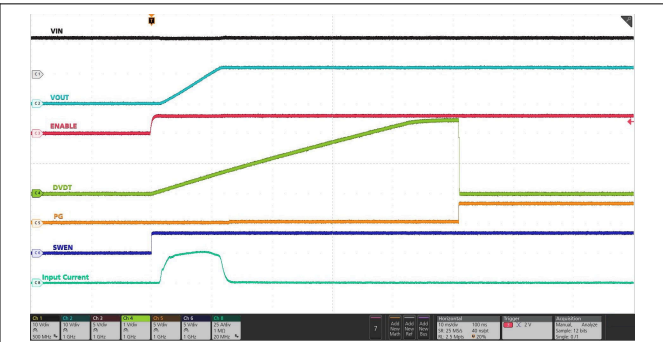

IN supply held steady at 12 V, EN toggled from low to high.
 $C_{OUT} = 18\text{ mF}$, $C_{dVdt} = 33\text{ nF}$, Higher PG delay setting
 (DEVICE_CONFIG[15] = 1b)

图 7-50. Power Good Assertion



Device in steady-state, Load current ramped up from 50 A to 70 A for 10 ms and then ramped down to 50 A. OCP threshold set to 55 A, Overcurrent blanking delay set to 15 ms (OC_TIMER = 0x89)

图 7-51. Transient Overcurrent Blanking

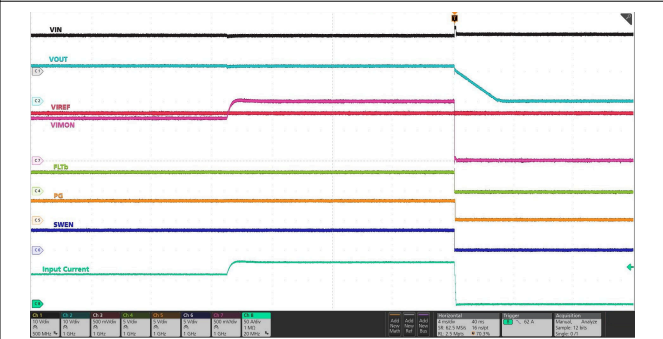

Device in steady-state, Load current ramped up from 50 A to 70 A for > 15 ms. OCP threshold set to 55 A, Overcurrent blanking delay set to 15 ms (OC_TIMER = 0x89)

图 7-52. Overcurrent Protection



Device in steady-state, Load current ramped up from 50 A to 70 A for > 15 ms. OCP threshold set to 55 A, Overcurrent blanking delay set to 15 ms (OC_TIMER = 0x89), Latch-off configuration (Default, RETRY_CONFIG[5:3] = 000b)

图 7-53. Fault Response - Latch-off

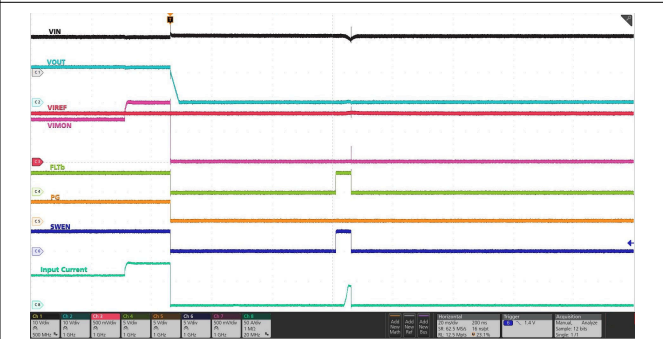

Device in steady-state, Load current ramped up from 50 A to 70 A for 100 ms. OCP threshold set to 55 A, Overcurrent blanking delay set to 15 ms (OC_TIMER = 0x89), Auto-retry 1 times configuration (RETRY_CONFIG[5:3] = 001b), Auto-retry delay set to 55 ms (RETRY_CONFIG[2:0] = 000b)

图 7-54. Fault Response - Auto-retry

7.12 Typical Characteristics (continued)

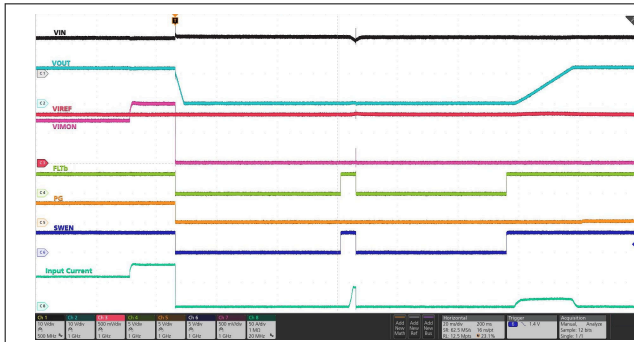

Device in steady-state, Load current ramped up from 50 A to 70 A for 100 ms and then ramped down to 0 A. OCP threshold set to 55 A, Overcurrent blanking delay set to 15 ms (OC_TIMER = 0x89), Auto-retry 4 times configuration (RETRY_CONFIG[5:3] = 010b), Auto-retry delay set to 55 ms (RETRY_CONFIG[2:0] = 000b)

图 7-55. Fault Response Followed By Recovery With Auto-retry

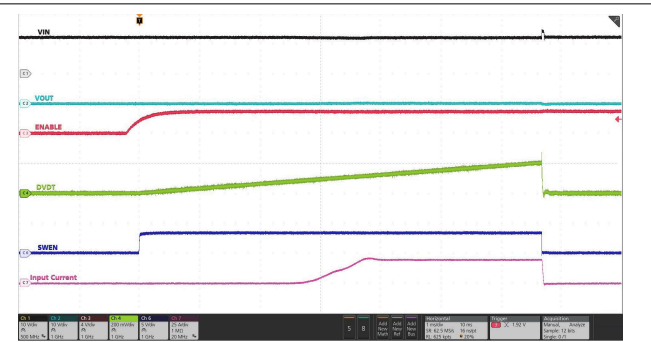

OUT shorted to GND. IN supply held steady at 12 V, EN pin toggled from low to high.

图 7-56. Power Up into Short-Circuit Protection

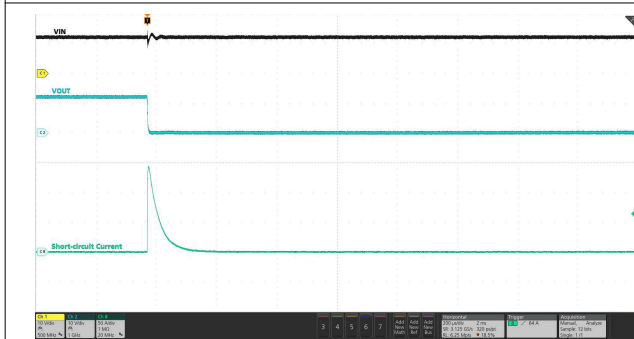

Device in steady-state, OUT shorted to GND. OCP threshold set to 55 A, Short-circuit fast recovery disabled (Default, DEVICE_CONFIG[13] = 0b)

图 7-57. Short-Circuit Protection During Steady-state

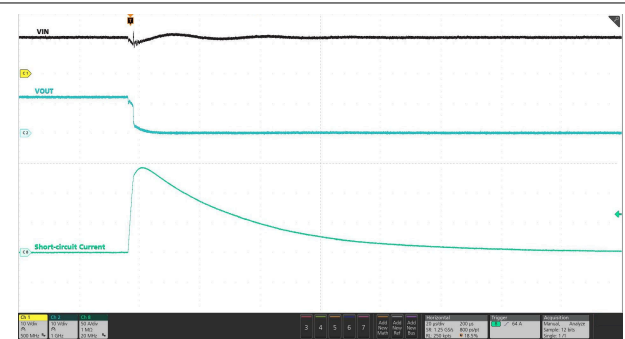

Device in steady-state, OUT shorted to GND. OCP threshold set to 55 A, Short-circuit fast recovery disabled (Default, DEVICE_CONFIG[13] = 0b)

图 7-58. Short-Circuit Protection During Steady-state

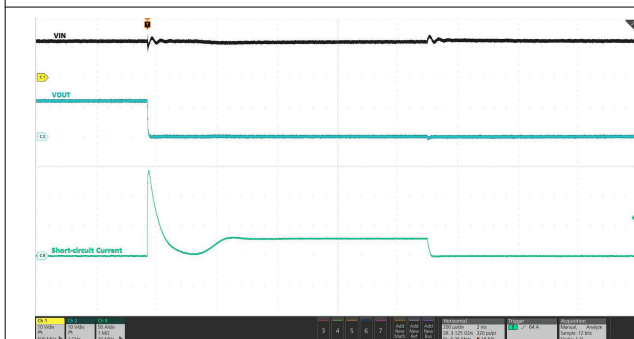

Device in steady-state, OUT shorted to GND. OCP threshold set to 55 A, Short-circuit fast recovery enabled (Default, DEVICE_CONFIG[13] = 1b)

图 7-59. Short-Circuit Protection During Steady-state With Fast Recovery Enabled

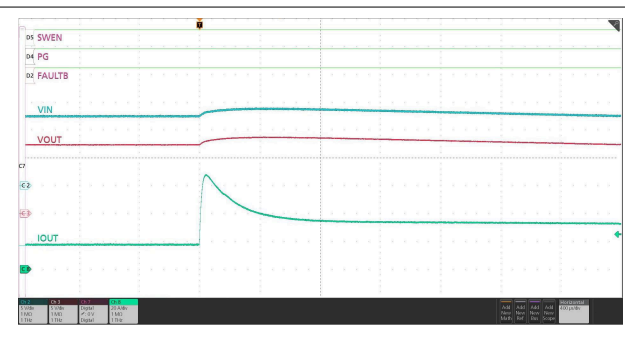

Sudden step in input supply voltage during steady-state causes output current spike without triggering a false fast-trip.

图 7-60. Input Line Transient Response

8 Detailed Description

8.1 Overview

The TPS25990 is an eFuse with integrated power switch to manage load voltage and load current. The device is equipped with a PMBus compatible digital interface which allows a host to control, configure, monitor and debug the device. The device starts its operation by monitoring the VDD and IN bus. When V_{DD} and V_{IN} exceed the respective Undervoltage Protection (UVP) thresholds, the device waits for the insertion delay timer duration to wait for the supply to stabilize before starting up. Next the device samples the EN/UVLO pin and SWEN pins. A high level on both these pins enables the internal MOSFET to start conducting and allows current to flow from IN to OUT. When either EN/UVLO or SWEN is held low, the internal MOSFET is turned off.

After a successful start-up sequence, the TPS25990 device now actively monitors its load current and input voltage, and controls the internal FET to ensure that the programmed overcurrent threshold is not exceeded and input overvoltage spikes are cut off. This action keeps the system safe from harmful levels of voltage and current. At the same time, a user-programmable overcurrent blanking timer allows the system to pass transient peaks in the load current profile without tripping the eFuse. Similarly, voltage transients on the supply line are intelligently masked to prevent nuisance trips. This feature ensures a robust protection solution against real faults which is also immune to transients, thereby ensuring maximum system uptime.

The TPS25990 allows the host to monitor various system parameters and status over the PMBus interface. It is also possible to change the device configuration over the PMBus interface to control device behavior as per system needs. This includes various warning/fault thresholds, timers and pin functions. The configuration values can also be stored in the internal non-volatile OTP memory or an external EEPROM so that the device can start up with some pre-defined configuration without host intervention at every power-up.

The TPS25990 also provides advanced telemetry features such as high speed ADC sample buffering ("digital oscilloscope") and Blackbox fault recording which simplify system design and debugging and facilitate predictive maintenance.

The device has an integrated high accuracy and high bandwidth analog load current monitor, which allows the system to precisely monitor the load current in steady state as well as during transients. This feature facilitates the implementation of advanced dynamic platform power management techniques such as Intel PSYS to maximize system power usage and throughput without sacrificing safety and reliability.

For systems needing higher load current support, the TPS25990 can be connected in parallel with other high current eFuses like TPS25985x. The TPS25990 acts as a primary controller and enables control, telemetry and configuration of the whole chain over PMBus.

All devices share current during start-up as well as steady-state to avoid over-stressing some of the devices more than others which can result in premature or partial shutdown of the parallel chain. The devices synchronize their operating states to ensure graceful start-up, shutdown and response to faults. This makes the whole chain function as a single very high current eFuse rather than a bunch of independent eFuses operating asynchronously.

The device has integrated protection circuits to ensure device safety and reliability under recommended operating conditions. The internal FET SOA is protected at all times using a thermal shutdown mechanism, which turns off the FET whenever the junction temperature (T_J) becomes too high for the FET to operate safely.

8.2 Functional Block Diagram



图 8-1. TPS25990 Functional Block Diagram

8.3 Feature Description

The TPS25990 eFuse is a highly integrated, advanced power management device that provides monitoring, detection, protection and reporting in the event of system faults.

8.3.1 Undervoltage Protection

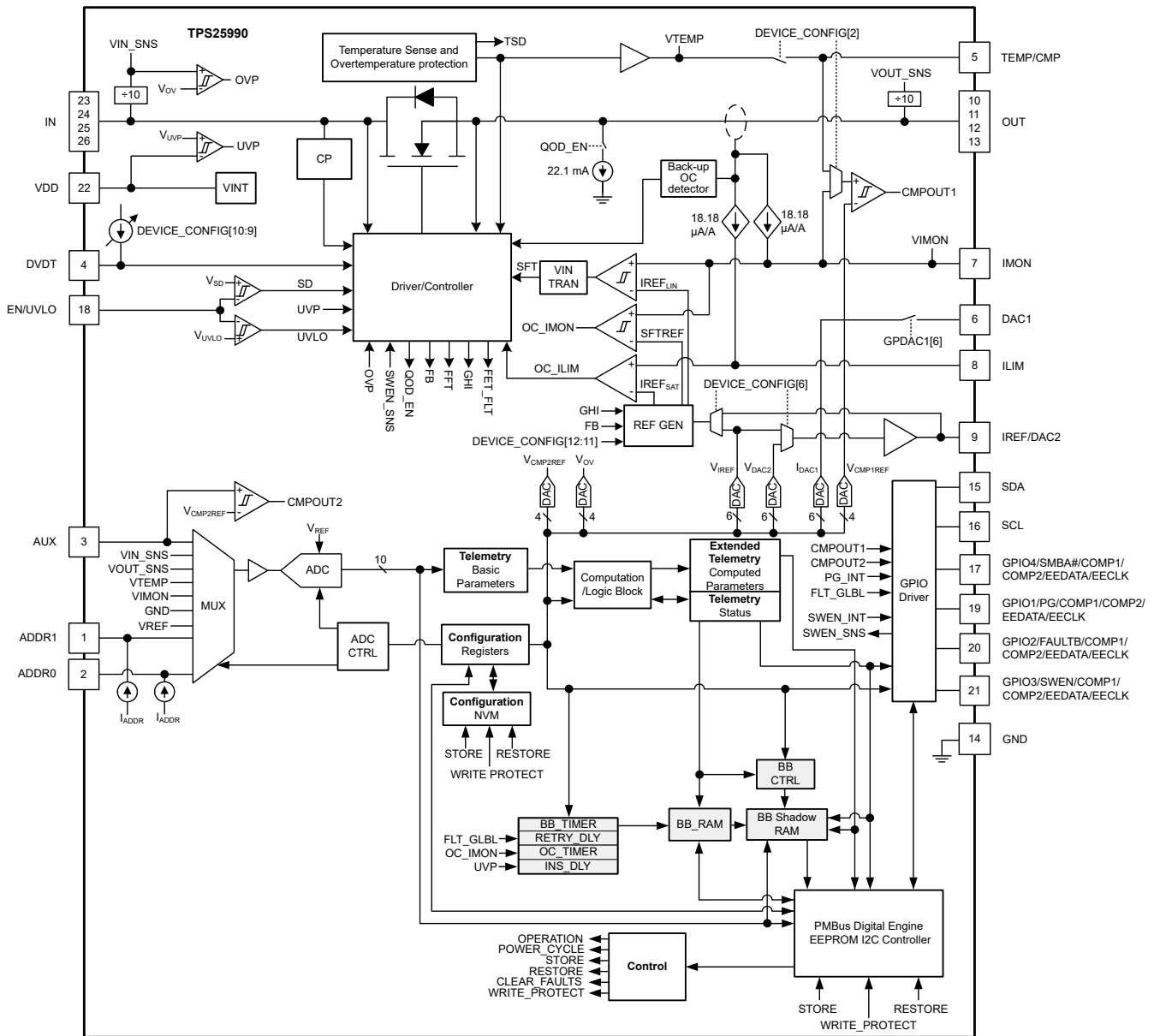
The TPS25990 implements undervoltage lockout on VDD and VIN in case the applied voltage becomes too low for the system or device to properly operate. The undervoltage lockout has a default internal threshold (V_{UVLP}) on VDD and programmable threshold (V_{UVLOIN}) on VIN. Alternatively, the UVLO comparator on the EN/UVLO pin allows the undervoltage protection threshold to be externally adjusted to a user defined value. 图 8-2 和 方程式 1 show how a resistor divider can be used to set the UVLO set point for a given voltage supply.



图 8-2. Adjustable Undervoltage Protection

$$V_{IN(UV)} = V_{UVLO(R)} \frac{R_1 + R_2}{R_2} \quad (1)$$

The VIN UVLO fault threshold can also be programmed using PMBus® writes to VIN_UV_FLT register.

The EN/UVLO pin implements a bi-level threshold and can be used to control the device from an external host.

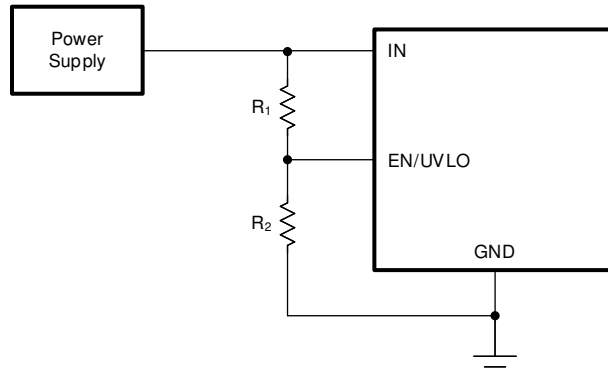
1. $V_{EN} > V_{UVLO(R)}$: Device is fully ON.
2. $V_{SD(F)} < V_{EN} < V_{UVLO(F)}$: The FET along with most of the controller circuitry is turned OFF, except for some critical bias and digital circuitry. Holding the EN/UVLO pin in this state for a duration greater than t_{QOD} activates the Output Discharge function.
3. $V_{EN} < V_{SD(F)}$: All active circuitry inside the part is turned OFF and it retains no digital state memory. It also resets latched faults, status flags and configuration values written to the registers through PMBus® writes.

8.3.2 Insertion Delay

The TPS25990 implements insertion delay at start-up to ensure the supply has stabilized before the device tries to turn on the power to the load. This is helpful in hotswap applications where a card is hot-plugged into a live backplane and can have some contact bounce before the card is firmly plugged into the connector. The device initially waits for the VDD supply to rise above the V_{UVP} threshold and all the internal bias voltages to settle. After that, the device remains off for an additional delay of t_{INSPLY} irrespective of the EN/UVLO pin condition. This action helps to prevent any unexpected behavior in the system if the device tries to turn on before the card has made firm contact with the backplane or if there is any supply ringing or noise during start-up.

The insertion delay can be changed by programming the [INS_DLY](#) register value in the Non-volatile memory/EEPROM using PMBus®.

8.3.3 Overvoltage Protection

The TPS25990 implements overvoltage lockout to protect the load from input overvoltage conditions. If the input voltage on IN exceeds the OVP rising threshold, the power FET is turned OFF within t_{OVP} . The OVP comparator on the IN pin uses a default internal overvoltage protection threshold of $V_{OVP(R)}$, which can be changed by programming the non-volatile configuration memory or dynamically through PMBus® register writes to the [VIN_OV_FLT](#) register. The OVP comparator has in-built hysteresis for improved noise immunity. After the voltage on IN falls below the OVP falling threshold ($V_{OVP(F)}$), the FET is turned ON in a dVdt controlled manner.



图 8-3. Input Overvoltage Protection Response

8.3.4 Inrush Current, Overcurrent, and Short-Circuit Protection

TPS25990 incorporates four levels of protection against overcurrent:

1. Adjustable slew rate (dVdt) for inrush current control
2. Active current limit with an adjustable threshold (I_{LIM}) for overcurrent protection during start-up
3. Circuit-breaker with an adjustable threshold (I_{OCP}) and blanking timer (t_{OC_TIMER}) for overcurrent protection during steady-state
4. Fast-trip response to severe overcurrent faults with a programmable threshold to quickly protect against severe short-circuits under all conditions, as well as a fixed threshold (I_{FFT}) during steady state

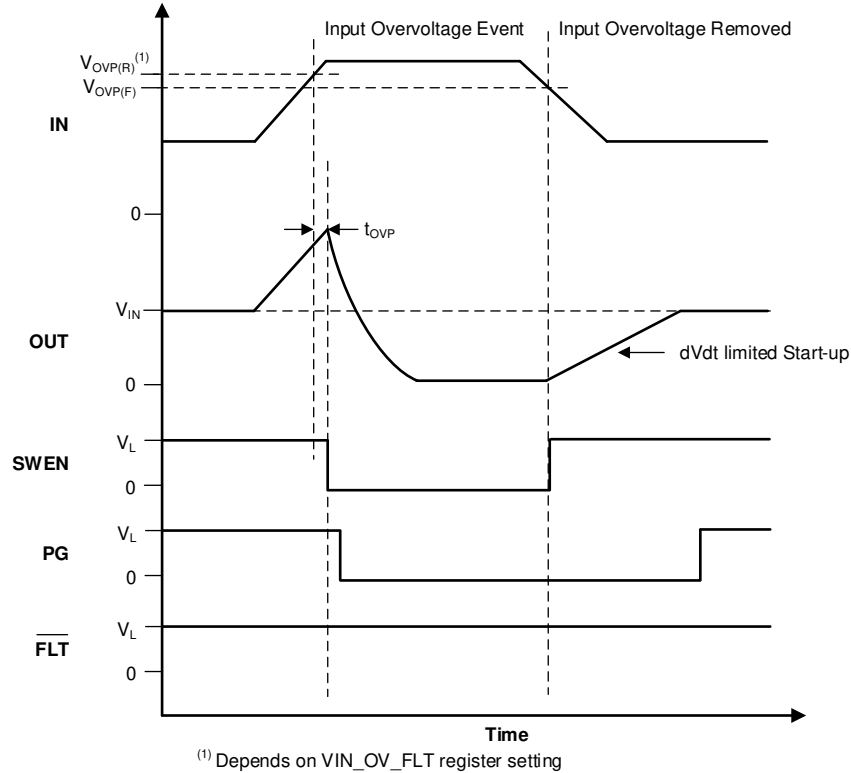
8.3.4.1 Slew rate (dVdt) and Inrush Current Control

During hot-plug events or while trying to charge a large output capacitance, there can be a large inrush current. If the inrush current is not managed properly, it can put excessive stress on the system power supply causing it to droop and even damage the input connectors. This action can lead to unexpected restarts elsewhere in the system. The inrush current during turn-on is directly proportional to the load capacitance and rising slew rate. 方程式 2 can be used to find the slew rate (SR) required to limit the inrush current (I_{INRUSH}) for a given load capacitance (C_{LOAD}):

$$SR \left(\frac{V}{ms} \right) = \frac{I_{INRUSH} (mA)}{C_{OUT} (\mu F)} \quad (2)$$

A capacitor can be added to the DVDT pin to control the rising slew rate and lower the inrush current during turn-on. This is also a function of the dVdt rate scaling factor which can be digitally programmed through PMBus® writes to the **DEVICE_CONFIG** register. The required C_{dVdt} capacitance to produce a given slew rate can be calculated using 方程式 3.

$$C_{dVdt} (pF) = \frac{42000 \times k}{SR \left(\frac{V}{ms} \right)} \quad (3)$$

where $k = 1$, if `DEVICE_CONFIG[10:9] = 10` (Default)

$k = 0.5$, if `DEVICE_CONFIG[10:9] = 00`

$k = 0.75$, if `DEVICE_CONFIG[10:9] = 01`

$k = 1.5$, if `DEVICE_CONFIG[10:9] = 11`

The fastest output slew rate is achieved by leaving the dVdt pin open and setting `DEVICE_CONFIG[10:9] = 11`.

备注

High turn-on slew rates in combination with high input power path inductance can result in oscillations during start-up. This can be mitigated using one or more of the following steps:

1. Reduce the input inductance.
 2. Increase the capacitance on VIN pin.
 3. Increase the DVDT pin capacitor value or change the DVDT scaling factor using `DEVICE_CONFIG[10:9]` register bits to reduce the slew rate or increase the start-up time. TI recommends using a minimum start-up time of 5 ms.
-

8.3.4.1.1 Start-Up Timeout

If the start-up is not completed, that is, the FET is not fully turned on within a certain timeout interval (t_{SU_TMR}) after SWEN is asserted, the device registers it as a fault. The fault status is reported in the `STATUS_MFR_SPECIFIC` register Bit[6]. `FLT` is asserted low and the device goes into latch-off or auto-retry mode depending on the `RETRY_CONFIG` register setting.

8.3.4.2 Steady-State Overcurrent Protection (Circuit-Breaker)

The TPS25990 responds to output overcurrent conditions during steady-state by performing a circuit-breaker action after a user-adjustable transient fault blanking interval. This action allows the device to support a higher peak current for a short user-defined interval but also ensures robust protection in case of persistent output faults.

The device constantly senses the output load current and provides an analog current output (I_{IMON}) on the IMON pin which is proportional to the load current, which in turn produces a proportional voltage (V_{IMON}) across the IMON pin resistor (R_{IMON}) as per [方程式 4](#).

$$V_{IMON} = I_{OUT} \times G_{IMON} \times R_{IMON} \quad (4)$$

Where G_{IMON} is the current monitor gain ($I_{IMON} : I_{OUT}$)

The overcurrent condition is detected by comparing this voltage against the voltage on the IREF pin as a reference. The reference voltage (V_{IREF}) can be controlled in two ways, which sets the overcurrent protection threshold (I_{OCP}) accordingly.

- The reference voltage (V_{IREF}) can be generated using internal DAC and can be changed by programming the non-volatile configuration memory or dynamically through PMBus® writes to the `VIREF` register.
- It is also possible to drive the IREF pin from an external low impedance precision reference voltage source.

The overcurrent protection threshold during steady-state (I_{OCP}) can be calculated using [方程式 5](#).

$$I_{OCP} = \frac{V_{IREF}}{G_{IMON} \times R_{IMON}} \quad (5)$$

备注

TI recommends to add a 1 nF capacitor from IREF pin to GND for improved noise immunity.

After an overcurrent condition is detected, that is the load current exceeds the programmed current limit threshold (I_{OCP}), but stays lower than the short-circuit threshold (I_{SCP}), the device starts running the internal overcurrent blanking digital timer (`OC_TIMER`). If the load current drops below the current limit threshold before

the **OC_TIMER** expires, the circuit-breaker action is not engaged. This action allows short overload transient pulses to pass through the device without tripping the circuit. At the same time, the **OC_TIMER** is reset so that it is at its default state before the next overcurrent event. This ensures the full blanking timer interval is provided for every overcurrent event.

If the overcurrent condition persists, the **OC_TIMER** continues to run and after it expires, the circuit-breaker action turns off the FET immediately.

方程式 6 可以 用于 计算 所需的 过流 阈值 R_{IMON} 的 值。

$$R_{IMON} = \frac{V_{IREF}}{G_{IMON} \times I_{OCP}} \quad (6)$$

The duration for which transients are allowed can be programmed using **OC_TIMER** register setting through PMBus® writes.

图 8-4 说明了 TPS25990 eFuse 的过流响应。在部分由于电路断路器故障而关闭后，它要么保持锁定关闭，要么根据 **RETRY_CONFIG** 寄存器设置自动重新启动。



图 8-4. Steady-state Overcurrent (Circuit-Breaker) Response

When a transient overcurrent condition (the load current exceeds the programmed current limit threshold but the OC_TIMER does not expire) is detected, the device:

- sets the OC_DET bit in the [STATUS_MFR_SPECIFIC_2](#) register
- fills-up one of the Blackbox RAM registers (if available to write) writing the event identifier as OC_DET and relative time stamp information
- increases the Blackbox RAM address pointer in the [BB_TIMER](#) register by one (1) if it was previously less than six (6), otherwise resets to zero (0). This change in the address pointer only occurs if one of the Blackbox RAM registers is available to write.

备注

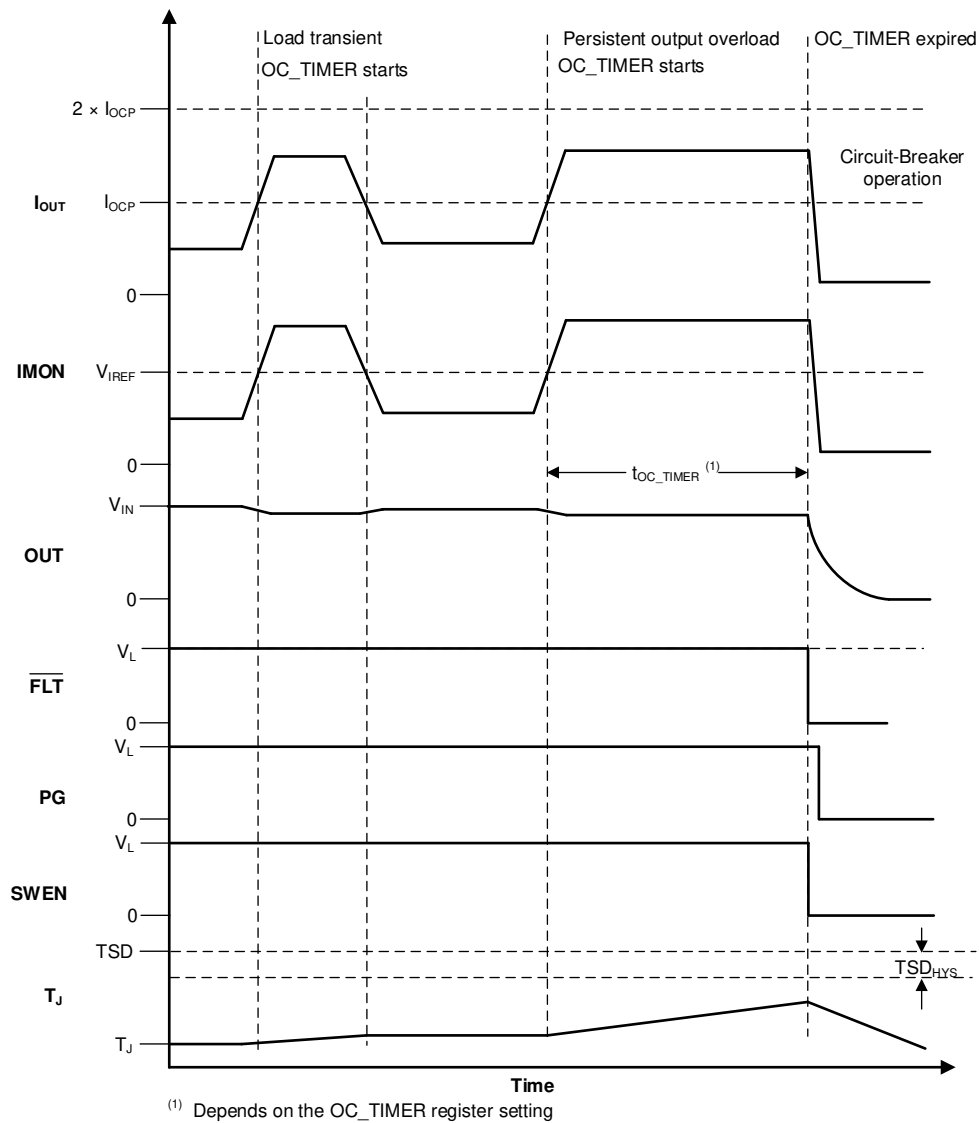
It is assumed that the [VIN_UV_WARN](#) , [VIN_OV_WARN](#), and [VOUT_UV_WARN](#) events are not triggered because of a step load transient.

When a persistent overcurrent condition (the load current exceeds the programmed current limit threshold and the OC_TIMER expires) is detected, the device:

- sets the FET_OFF and NONE_OF_THE_ABOVE/UNKNOWN bits in the [STATUS_BYTE](#) register
- sets the OUT_STATUS, INPUT_STATUS, PGOODB, and NONE_OF_THE_ABOVE/UNKNOWN bits in the upper byte of the [STATUS_WORD](#) register
- sets the VOUT_UV_WARN bit in the [STATUS_OUT](#) register
- sets the OC_FLT bit in the [STATUS_INPUT](#) register
- sets the PGOODB bit in the [STATUS_MFR_SPECIFIC_2](#) register
- notifies the host by asserting $\overline{\text{SMBA}}$, if it is not masked setting the STATUS_IN, PGOODB, and STATUS_OUT bits in the [ALERT_MASK](#) register and the GPIO4 pin is configured as SMBA Output in the [GPIO_CONFIG_34](#) register
- deasserts the external PG signal, if the GPIO1 pin is configured as PGOOD Output in the [GPIO_CONFIG_12](#) register
- asserts the $\overline{\text{FLT}}$ signal, if it is not masked setting the OC_FLT bit high in the [FAULT_MASK](#) register and the GPIO2 pin is configured as FLT Output in the [GPIO_CONFIG_12](#) register

备注

It is assumed that the [VIN_UV_WARN](#) and [VIN_OV_WARN](#) events are not triggered because of a step load transient.

8.3.4.3 Active Current Limiting During Start-Up

The TPS25990 responds to output overcurrent conditions during start-up by actively limiting the current. The device constantly senses the current flowing through the device (I_{DEVICE}) and provides an analog current output (I_{ILIM}) on the ILIM pin, which in turn produces a proportional voltage (V_{ILIM}) across the ILIM pin resistor (R_{ILIM}) as per [方程式 7](#).

$$V_{\text{ILIM}} = I_{\text{DEVICE}} \times G_{\text{ILIM}} \times R_{\text{ILIM}} \quad (7)$$

Where G_{ILIM} is the current monitor gain ($I_{\text{ILIM}} : I_{\text{DEVICE}}$)

The overcurrent condition is detected by comparing this voltage against a threshold which is a scaled voltage ($\text{CLREF}_{\text{SAT}}$) derived from the reference voltage (V_{IREF}) on the IREF pin as presented in [方程式 8](#).

$$\text{CLREF}_{\text{SAT}} = \frac{0.7 \times V_{\text{IREF}}}{3} \quad (8)$$

The reference voltage (V_{IREF}) can be controlled in two ways, which sets the overcurrent protection threshold (I_{LIM}) accordingly.

- The reference voltage (V_{IREF}) can be generated using internal DAC and can be changed by programming the non-volatile configuration memory or dynamically through PMBus® writes to the [VIREF](#) register.
- It is also possible to drive the IREF pin from an external low impedance precision reference voltage source.

The active current limit (I_{LIM}) threshold during start-up can be calculated using [方程式 9](#).

$$I_{LIM} = \frac{CLREF_{SAT}}{G_{LIM} \times R_{LIM}} \quad (9)$$

When the load current during start-up exceeds I_{LIM} , the device tries to regulate and hold the load current at I_{LIM} .

During current regulation, the output voltage drops, resulting in increased device power dissipation across the FET. If the device internal temperature (T_J) exceeds the thermal shutdown threshold, the FET is turned off. After the part shuts down due to a TSD fault, it either stays latched off or restarts automatically after a delay based on the [RETRY_CONFIG](#) register setting. See [Overtemperature protection](#) section for more details on device response to overtemperature.

备注

The active current limit block employs a foldback mechanism during start-up based on the output voltage (V_{OUT}). When V_{OUT} is below the foldback threshold (V_{FB}), the current limit threshold is further lowered.

8.3.4.4 Short-Circuit Protection

During an output short-circuit event, the current through the device increases very rapidly. When an output short-circuit is detected, the internal fast-trip comparator triggers a fast protection sequence to prevent the current from building up further and causing any damage or excessive input supply droop. This action enables the user to adjust the fast-trip threshold as per system rating, rather than using a high fixed threshold which may not be suitable for all systems. The fast-trip comparator employs a scalable threshold (I_{SFT}) which is a function of the circuit-breaker threshold (I_{OCP}) and a digitally programmable scaling factor. The default fast-trip threshold is equal to $2 \times I_{OCP}$ during steady-state and $1.5 \times I_{LIM}$ during inrush. The scaling factor for steady-state fast-trip threshold can be programmed to a different value using the [DEVICE_CONFIG\[12:11\]](#) register bits. Available programming options are $1.5 \times$, $2 \times$, $1.75 \times$ and $2.25 \times$. After the current exceeds the fast-trip threshold, the TPS25990 turns off the FET within t_{SFT} .

The device also employs a higher fixed fast-trip threshold (I_{FFT}) to provide fast protection against hard short-circuits during steady-state (FET in linear region). After the current exceeds I_{FFT} , the FET is turned off completely within t_{FFT} .

The device response after a fast-trip event can be configured using the SC_RETRY bit in the [DEVICE_CONFIG](#) register through PMBus® register writes or non-volatile configuration memory. There are 2 programming options available:

1. **SC_RETRY = 0 (Default setting):** The device latches a fault and remains off till a restart is triggered either externally or through internal auto-retry mechanism as per the [RETRY_CONFIG](#) register setting.

When a short-circuit fault occurs with the SC_RETRY bit in the [DEVICE_CONFIG](#) register low, the device:

- sets the FET_OFF and NONE_OF_THE_ABOVE/UNKNOWN bits in the [STATUS_BYTE](#) register
- sets the OUT_STATUS, PGOODB, and NONE_OF_THE_ABOVE/UNKNOWN bits in the upper byte of the [STATUS_WORD](#) register
- sets the VOUT_UV_WARN bit in the [STATUS_OUT](#) register
- sets the PGOODB and SC_FLT bits in the [STATUS_MFR_SPECIFIC_2](#) register
- notifies the host by asserting SMBA#, if it is not masked setting the PGOODB and STATUS_OUT bits in the [ALERT_MASK](#) register and the GPIO4 pin is configured as SMBA# Output in the [GPIO_CONFIG_34](#) register

- deasserts the external PG signal, if the GPIO1 pin is configured as PGOOD Output in the [GPIO_CONFIG_12](#) register
 - asserts the $\overline{\text{FLT}}$ signal, if it is not masked setting the SC_FLT bit high in the [FAULT_MASK](#) register and the GPIO2 pin is configured as ' $\overline{\text{FLT}}$ Output' in the [GPIO_CONFIG_12](#) register
2. **SC_RETRY = 1:** The device attempts to turn the FET back ON fully after a short de-glitch interval (30 μ s). This allows the FET to try and recover quickly after a transient overcurrent event and minimizes the output voltage droop. However, if the fault is persistent, the device enters current limit causing the junction temperature to rise and eventually enter thermal shutdown. The device latches a fault and remains off till a restart is triggered either externally or through internal auto-retry mechanism as per the [RETRY_CONFIG](#) register setting. See [Overtemperature Protection](#) section for details on the device response to overtemperature.

When a short-circuit fault occurs with the SC_RETRY bit in the [DEVICE_CONFIG](#) register high, the device:

- sets the FET_OFF, STATUS_TEMP, and NONE_OF_THE_ABOVE/UNKNOWN bits in the [STATUS_BYTE](#) register
- sets the OUT_STATUS, MFR_STATUS, PGOODB, and NONE_OF_THE_ABOVE/UNKNOWN bits in the upper byte of the [STATUS_WORD](#) register
- sets the VOUT_UV_WARN bit in the [STATUS_OUT](#) register
- sets the OT_FLT bit in the [STATUS_TEMP](#) register
- sets the SOA_FLT bit in the [STATUS_MFR_SPECIFIC](#) register
- sets the PGOODB bit in the [STATUS_MFR_SPECIFIC_2](#) register
- notifies the host by asserting SMBA#, if it is not masked setting the PGOODB, MFR_STATUS, STATUS_TEMP, and STATUS_OUT bits in the [ALERT_MASK](#) register and the GPIO4 pin is configured as SMBA# Output in the [GPIO_CONFIG_34](#) register
- deasserts the external PG signal, if the GPIO1 pin is configured as PGOOD Output in the [GPIO_CONFIG_12](#) register
- asserts the $\overline{\text{FLT}}$ signal, if it is not masked setting the SOA_FLT and TEMP_FLT bits high in the [FAULT_MASK](#) register and the GPIO2 pin is configured as ' $\overline{\text{FLT}}$ Output' in the [GPIO_CONFIG_12](#) register

 **8-5** illustrates the short-circuit response for TPS25990 eFuse.

In some of the systems, for example blade servers and telecom equipment which house multiple hot-pluggable blades or line cards connected to a common supply backplane, there can be transients on the supply due to switching of large currents through the inductive backplane. This can result in current spikes on adjacent cards which can potentially be large enough to trigger the fast-trip comparator of the eFuse. The TPS25990 uses a proprietary algorithm to avoid nuisance tripping in such cases thereby facilitating uninterrupted system operation.

备注

- The VIN_TRAN status bit in [STATUS_MFR_SPECIFIC_2](#) register is set to indicate if an input line transient event was detected and masked.
 - The input line transient masking feature can be optionally disabled by setting the VIN_TRAN_DIS bit high in the [DEVICE_CONFIG](#) register.
-



图 8-5. Short-Circuit Response

8.3.5 Single Point Failure Mitigation

The TPS25990 relies on the proper component connections and biasing on the IMON, ILIM and IREF pins along with the appropriate threshold digital configurations to provide overcurrent and short-circuit protection under all circumstances. As an added safety measure, the device uses the following mechanisms to ensure that the device provides some form of overcurrent protection even if any of these pins are not connected correctly in the system or the associated components have a failure in the field or if the configuration registers are not programmed correctly.

8.3.5.1 IMON Pin Single Point Failure

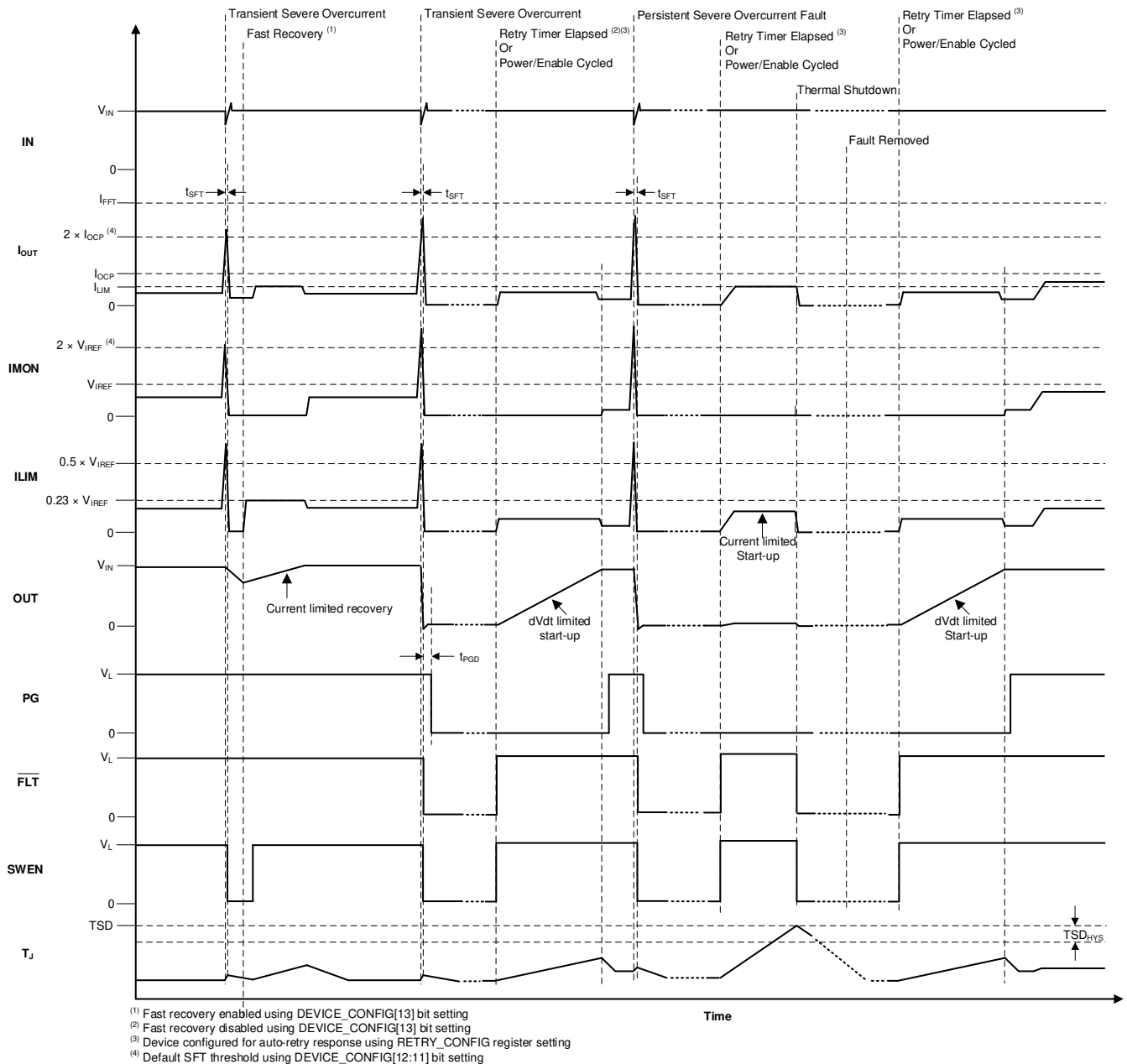
- **IMON pin open:** In this case, the IMON pin voltage is internally pulled up to a higher voltage and exceeds the threshold (V_{IREF}), causing the part to perform a circuit-breaker action even if there is no significant current flowing through the device.

- **IMON pin shorted to GND directly or through a very low resistance:** In this case, the IMON pin voltage is held at a low voltage and is not allowed to exceed the threshold (V_{IREF}) even if there is significant current flowing through the device, thereby rendering the primary overcurrent protection mechanism ineffective. The device relies on an internal overcurrent sense mechanism to provide some protection as a backup. If the device detects that the backup current sense threshold (I_{OC_BKP}) is exceeded but at the same time the primary overcurrent detection on IMON pin fails, it triggers single point failure detection and latches a fault. The FET is turned off and the \overline{FLT} pin is asserted. At the same time, the SPFAIL status bit in [STATUS_MFR_SPECIFIC_2](#) register is set and the SMBA# signal is asserted.

8.3.5.2 ILIM Pin Single Point Failure

- **ILIM pin open:** In this case, the ILIM pin voltage is internally pulled up to a higher voltage and exceeds the V_{IREF} threshold, causing the part to engage the current limit even if there is no significant current flowing through the device.
- **ILIM pin shorted to GND directly or through a very low resistance:** In this case, the ILIM pin voltage is held at a low voltage and is not allowed to exceed the start-up current limit threshold even if there is significant current flowing through the device, thereby rendering the primary current limit mechanism ineffective during start-up. The device relies on an internal overcurrent detection mechanism to provide some protection as a backup. If the device detects that the load current exceeds the backup overcurrent threshold (I_{OC_BKP}) but at the same time the primary overcurrent detection on ILIM pin fails, it triggers single point failure detection and latches a fault. The FET is turned off and the \overline{FLT} pin is asserted. At the same time, the SPFAIL status bit in [STATUS_MFR_SPECIFIC_2](#) register is set and the SMBA# signal is asserted.

8.3.5.3 IREF Pin Single Point Failure

- **IREF DAC set incorrectly or externally forced to higher voltage:** In this case, the IREF pin (V_{IREF}) is pulled up internally or externally to a voltage which is higher than the target value as per the recommended I_{OCP} or I_{LIM} calculations, preventing the primary circuit-breaker, active current limit, and short-circuit protection from getting triggered even if there is significant current flowing through the device. The device relies on an internal overcurrent detection mechanism to provide some protection as a backup. If the device detects that the load current exceeds backup overcurrent threshold (I_{OC_BKP}) but at the same the primary overcurrent or short-circuit detection on ILIM or IMON pin fails, it triggers single point failure detection and latches a fault. The FET is turned off and the \overline{FLT} pin is asserted. At the same time, the SPFAIL status bit in [STATUS_MFR_SPECIFIC_2](#) register is set and the SMBA# signal is asserted.
- **IREF pin shorted to GND:** In this case, the V_{IREF} threshold is set to 0 V, causing the part to perform active current limit or circuit-breaker action even if there is no significant current flowing through the device.

8.3.6 Analog Load Current Monitor (IMON)

The TPS25990 allows the system to monitor the output load current accurately by providing an analog current on the IMON pin which is proportional to the current through the FET. The benefit of having a current output is that the signal can be routed across a board without adding significant errors due to voltage drop or noise coupling from adjacent traces. The current output also allows the IMON pins of multiple eFuse devices (TPS25990 or TPS25985x) to be tied together to get the total current in a parallel configuration. The IMON signal can be converted to a voltage by dropping it across a resistor at the point of monitoring. The user can sense the voltage (V_{IMON}) across the R_{IMON} to get a measure of the output load current using [方程式 10](#).

$$I_{OUT} = \frac{V_{IMON}}{R_{IMON} \times R_{IMON}} \quad (10)$$

The TPS25990 IMON circuit is designed to provide high bandwidth and high accuracy across load and temperature conditions, irrespective of board layout and other system operating conditions. This design allows the IMON signal to be used for advanced dynamic platform power management techniques such as Intel PSYS or PROCHOT to maximize system power usage and platform throughput without sacrificing safety or reliability.



图 8-6. Analog Load Current Monitor Response

备注

1. The IMON pin provides load current monitoring information only during steady-state. During inrush, the IMON pin reports zero load current.
2. The ILIM pin reports the individual device load current at all times and can also be used as an analog load current monitor for each individual device.
3. TI recommends adding a 22 pF capacitor from IMON pin to GND for noise filtering purposes.
4. Care must be taken to minimize parasitic capacitance on the ILIM pin to avoid any impact on the overcurrent and short-circuit protection timing during start-up.

8.3.7 Overtemperature Protection

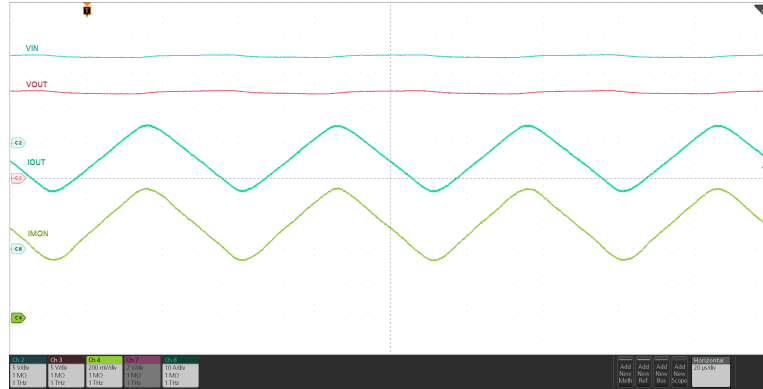
The TPS25990 employs an internal thermal shutdown mechanism to protect itself when the internal FET becomes too hot to operate safely. When the TPS25990 detects thermal overload, it shuts down. Thereafter it either remains latched-off until the device is power cycled or re-enabled, or restarts automatically after delay based on the device Auto-retry configuration.

The overtemperature threshold has a default threshold (TSD) which can be digitally programmed to a lower value using the [OT_FLT](#) register based on system needs.

表 8-1. Overtemperature Protection Summary

Auto-Retry Configuration	Enter TSD	Exit TSD
Latch-Off	$V_{TEMP} \geq OT_FLT$ threshold or $T_J \geq TSD$	$V_{TEMP} < OT_FLT - OT_{Hys}$ or $T_J < TSD - TSD_{Hys}$ VDD cycled to 0 V and then above $V_{UVP(R)}$ or EN/ UVLO toggled below $V_{SD(F)}$
Auto-Retry	$V_{TEMP} \geq OT_FLT$ threshold or $T_J \geq TSD$	$V_{TEMP} < OT_FLT - OT_{Hys}$ or $T_J < TSD - TSD_{Hys}$ Retry Timer expired or VDD cycled to 0 V and then above $V_{UVP(R)}$ or EN/UVLO toggled below $V_{SD(F)}$

8.3.8 Analog Junction Temperature Monitor (TEMP)

The TPS25990 allows the system to monitor the junction temperature (T_J) accurately by providing an analog voltage on the TEMP pin which is proportional to the temperature of the die. This voltage is sensed by an ADC input and reported using the [READ_TEMPERATURE_1](#) PMBus® command for digital telemetry. In a multi-device parallel configuration involving TPS25990 and TPS25985x, the TEMP outputs of all devices can be tied together. In this configuration, the TEMP signal reports the temperature of the hottest device in the chain.

备注

1. The TEMP pin voltage is used only for external monitoring and does not interfere with the overtemperature protection scheme of each individual device which is based purely on the internal temperature monitor.
2. TI recommends to add a capacitance of 22 pF on the TEMP pin to filter out glitches during system transients.

8.3.9 FET Health Monitoring

The TPS25990 can detect and report certain conditions which are indicative of a failure of the power path FET. If undetected or unreported, these conditions can compromise system performance either by not providing power to the load correctly or the necessary level of protection. After a FET failure is detected, the TPS25990 tries to turn off the internal FET by pulling the gate low and asserts the \overline{FLT} pin. The specific FET fault type is also reported in the [STATUS_MFR_SPECIFIC](#) status register.

- **D-S short:** D-S short can result in a constant uncontrolled power delivery path formed from source to load, either due to a board assembly defect or due to internal FET failure. This condition is detected at start-up by checking if $V_{IN-OUT} < V_{DSFLT}$ before the FET is turned ON. If yes, the device engages the internal output discharge to try and discharge the output. If the V_{OUT} doesn't discharge below V_{FB} within a certain allowed interval, the device asserts the \overline{FLT} pin and sets the FET_FAULT_DS bit in the [STATUS_MFR_SPECIFIC](#) status register.

备注

There is an option to disable the D-S fault detection digitally by setting the DIS_VDSFLT bit in the [DEVICE_CONFIG](#) register. This allows the device start-up into a pre-charged output without triggering the D-S fault.

- **G-D short:** The TPS25990 detects this kind of FET failure at all times by checking if the gate voltage is close to V_{IN} even when the internal control logic is trying to hold the FET in OFF condition. If this condition is detected, the device asserts the \overline{FLT} pin and sets the FET_FAULT_GD bit in the [STATUS_MFR_SPECIFIC](#) status register.
- **G-S short:** The TPS25990 detects this kind of FET failure during start-up by checking if the FET G-S voltage fails to reach the necessary overdrive voltage within a certain timeout period (t_{SU_TMR}) after the gate driver is turned ON. While in steady-state, if the G-S voltage becomes low before the controller logic has signaled to the gate driver to turn off the FET, it is latched as a fault. If this condition is detected, the device asserts the \overline{FLT} pin and sets the FET_FAULT_GS bit in the [STATUS_MFR_SPECIFIC](#) status register.

8.3.10 General Purpose Digital Input/Output Pins

The TPS25990 has four (4) general purpose digital input/output pins which can be configured for different functions as per system needs.

1. General Purpose Digital Input
2. General Purpose Digital Output
3. Fault (\overline{FLT}) Indication Output
4. Power Good (PG) Indication Output
5. SWEN Input/Output
6. SMBus Alert (SMBA#) Indication Output
7. General Purpose Comparator-1 Output
8. General Purpose Comparator-2 Output
9. External EEPROM I2C Clock (EECLK)
10. External EEPROM I2C Data (EEDATA)

8.3.10.1 Fault Response and Indication (\overline{FLT})

表 8-2 summarizes the device response to various fault conditions.

表 8-2. Fault Summary

Event or Condition	Device Response	Fault Latched Internally	FLT Pin Status	Pin Indication Masking Option	Delay
Steady-state	None	N/A	H	N/A	
Inrush	None	N/A	H	N/A	
Overtemperature	Shutdown	Y	L	Y	
Undervoltage (EN/UVLO)	Shutdown	N	H	N/A	
Undervoltage (VDD UVP)	Shutdown	N	H	N/A	
Undervoltage (VIN UVP)	Shutdown	N	H	N/A	
Overvoltage (VIN OVP)	Shutdown	N	H	N/A	
Transient overcurrent	None	N	H	N/A	
Persistent overcurrent (steady-state)	Circuit-Breaker	Y	L	Y	t _{TIMER}
Persistent overcurrent (start-up)	Current Limit	N	H	N/A	
Output short-circuit	Fast-trip	Y	L	Y	t _{FT}
Output short-circuit (Fast recovery configuration)	Fast-trip followed by current limited Start-up	N	H	N/A	
ILIM pin open (start-up)	Shutdown	Y	L	Y	
ILIM pin short (start-up)	Shutdown (if I _{OUT} > I _{OC_BKP})	Y	L	Y	
ILIM pin open (steady-state)	Active current sharing loop always active	N	H	N/A	
ILIM pin short (steady-state)	Active current sharing loop disabled	N	H	N/A	
IMON pin open (steady-state)	Shutdown	Y	L	Y	
IMON pin short (steady-state)	Shutdown (If I _{OUT} > I _{OC_BKP})	Y	L	Y	45 μs
IREF pin open (start-up)	Shutdown (If I _{OUT} > I _{OC_BKP})	Y	L	Y	
IREF pin open (steady-state)	Shutdown (if I _{OUT} > I _{OC_BKP})	Y	L	Y	t _{TIMER}
IREF pin short (steady-state)	Shutdown	Y	L	Y	
IREF pin short (start-up)	Shutdown	Y	L	Y	
Start-up timeout	Shutdown	Y	L	N	t _{SU_TMR}
FET health fault (G-S)	Shutdown	Y	L	Y	10 μs
FET health fault (G-D)	Shutdown	Y	L	Y	
FET health fault (D-S)	Shutdown	N	L	Y	t _{SU_TMR}
External fault (SWEN pulled low externally while device is not in UV or OV)	Shutdown	Y	L	Y	

表 8-2. Fault Summary (continued)

Event or Condition	Device Response	Fault Latched Internally	FLT Pin Status	Pin Indication Masking Option	Delay
Comparator-1 fault	Configurable through DEVICE_CONFIG register	Y	L	Y	
Comparator-2 fault	Configurable through DEVICE_CONFIG register	Y	L	Y	

备注

GPIO2 pin is configured as $\overline{\text{FLT}}$ by default to provide an active low fault indication. $\overline{\text{FLT}}$ is an open-drain pin and must be pulled up to an external supply. Refer to [GPIO_CONFIG_12](#) register for more details and configuration options.

The device response after a fault varies based on the [RETRY_CONFIG](#) register setting. The device latches a fault as per the table above and thereafter follows an auto-retry or latch-off response. For auto-retry configuration, the latched faults also trigger the start of the Auto-Retry Timer, while keeping the FLT pin pulled low. On expiry of the timer period (t_{RETRY}), the FLT pin pull-down is released and the device is ready to restart automatically. When the device turns on again, it follows the usual DVDT limited start-up sequence.

The only exception to this is during Short-circuit fault when the device is configured for fast recovery using the SC_RETRY bit in the [DEVICE_CONFIG](#) register. In this case, the device turns off quickly and then automatically turns back on in a current limited manner. This allows the system to try and recover quickly from any transient faults. See [Short-Circuit Protection](#) section for more details.

For faults that are latched internally, power cycling the part or pulling the EN/UVLO pin voltage below $V_{\text{SD(F)}}$ clears the fault and the FLT pin is de-asserted. This action also clears the Auto-retry timer. Pulling the EN/UVLO just below the UVLO threshold has no impact on the device in this condition. This is true in case of latch-off and auto-retry configurations.

In a parallel eFuse configuration involving TPS25990 and TPS25985x, the fault response is determined by the TPS25990 as the primary device. However, if the primary device fails to register a fault, there is a fail-safe mechanism in the secondary device to take control and turn off the entire chain by pulling the SWEN pin low and enter a latch-off condition. Thereafter, the device can be turned on again only by power cycling VDD below $V_{\text{UVP(F)}}$ or by cycling EN/UVLO pin below $V_{\text{SD(F)}}$.

8.3.10.2 Power Good Indication (PG)

Power Good is an active high digital output which is asserted high to indicate when the device is in steady-state and capable of delivering maximum power.

表 8-3. PG Indication Summary

Event or Condition	FET Status	PG Pin Status	PG Delay
Device disabled ($V_{\text{EN}} < V_{\text{UVLO}}$)	OFF	L	t_{PGD}
VIN Undervoltage ($V_{\text{IN}} < V_{\text{UVP}}$ or $V_{\text{IN}} < V_{\text{IN_UV_FLT}}$)	OFF	L	
VDD Undervoltage ($V_{\text{DD}} < V_{\text{UVP}}$)	OFF	L	
VIN Overvoltage ($V_{\text{IN}} > V_{\text{IN_OV_FLT}}$)	OFF	L	t_{PGD}
Steady-state	ON	H	t_{PGA}
Inrush	ON	L	t_{PGA}

表 8-3. PG Indication Summary (continued)

Event or Condition	FET Status	PG Pin Status	PG Delay
Transient overcurrent	ON	H	N/A
Circuit-breaker (persistent overcurrent followed by OC_TIMER expiry)	OFF	L	$t_{OC_TIMER} + t_{PGD}$
Fast-trip	OFF	L ($V_{OUT} < V_{OUT_PGTH}$) H ($V_{OUT} > V_{OUT_PGTH}$)	t_{PGD} N/A
Overtemperature	Shutdown	L	t_{PGD}

备注

GPIO1 pin is configured as PG output by default. Refer to [GPIO_CONFIG_12](#) register for more details and configuration options.

After power up, PG is pulled low initially. The device initiates an inrush sequence in which the gate driver circuit starts charging the gate capacitance from the internal charge pump. When the FET gate voltage reaches the full overdrive indicating that the inrush sequence is complete and the device is capable of delivering full power, the PG pin is asserted high after a de-glitch time (t_{PGA}). The PG assertion delay can be optionally increased by setting the PG_DVDT_DLY bit in the [DEVICE_CONFIG](#) register.

The PG is de-asserted if the output voltage falls below a threshold at any point during normal operation or the device detects a fault (except short-circuit). The PG de-assertion threshold can be digitally programmed through the [VOUT_PGTH](#) register. The PG de-assertion de-glitch time is t_{PGD} .



图 8-7. TPS25990 PG Timing Diagram

The PG is an open-drain pin and must be pulled up to an external supply.

备注

When there is no supply to the device, the PG pin is expected to stay low. However, there is no active pulldown in this condition to drive this pin all the way down to 0 V. If the PG pin is pulled up to an independent supply which is present even if the device is unpowered, there can be a small voltage seen on this pin depending on the pin sink current, which is a function of the pullup supply voltage and resistor. Minimize the sink current to keep this pin voltage low enough not to be detected as a logic HIGH by associated external circuits in this condition.

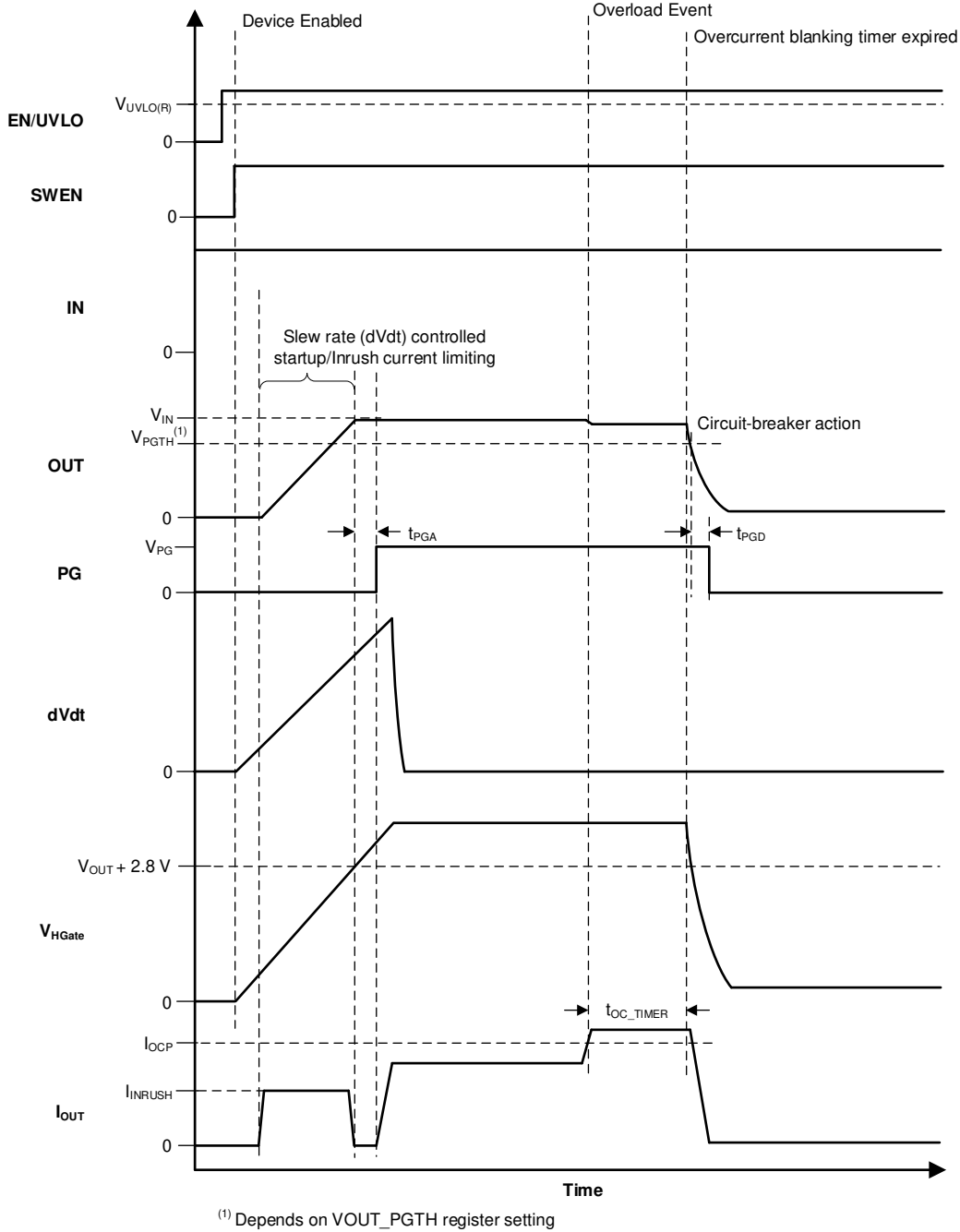
8.3.10.3 Parallel Device Synchronization (SWEN)

The SWEN pin is a signal which is driven high when the FET must be turned ON. When the SWEN pin is driven low (internally or externally), it signals the driver circuit to turn OFF the FET. This pin serves both as a control and handshake signal and allows multiple devices in a parallel configuration to synchronize their FET ON and OFF transitions.

表 8-4. SWEN Summary

Device State	FET Driver Status	SWEN
Steady-state	ON	H
Inrush	ON	H
Overtemperature shutdown	OFF	L
Auto-retry timer running	OFF	L
Device disabled ($V_{EN} < V_{UVLO}$)	OFF	L
VIN Undervoltage ($V_{IN} < V_{UVP}$ or $V_{IN} < V_{IN_UV_FLT}$)	OFF	L
VDD Undervoltage ($V_{DD} < V_{UVP}$)	OFF	L
Insertion delay	OFF	L
VIN Overvoltage ($V_{IN} > V_{IN_OV_FLT}$)	OFF	L
Transient overcurrent	ON	H
Circuit-breaker (persistent overcurrent followed by OC_TIMER expiry)	OFF	L
Fast-trip	OFF	L
Fast-trip response mono-shot running (DEVICE_CONFIG[13] = 1)	OFF	L
Fast-trip response mono-shot running (DEVICE_CONFIG[13] = 1)	ON	H
FET health fault	OFF	L
External fault (SWEN pulled low by secondary device in parallel chain)	OFF	L (held low by TPS25990 even if secondary device releases the pull down after some time)

The SWEN is an open-drain pin and must be pulled up through a 100 k Ω resistance to an external supply generated using the input voltage to the eFuse.

备注

- GPIO3 pin is configured as SWEN by default. Refer to [GPIO_CONFIG_34](#) register for more details and configuration options.
- The SWEN pullup supply needs to be powered up before the eFuse is turned on. TI recommends to use a system standby rail which is derived from the input of the eFuse and is powered up before the eFuse. The exception to this is when TPS25990 is used as a standalone device and the GPIO3 pin is digitally configured for some function other than SWEN.

In a primary and secondary parallel configuration, the SWEN pin is used by the primary device to control the ON and OFF transitions of the secondary devices. At the same time, it allows the secondary devices to communicate any faults or other conditions which can prevent it from turning on the primary device.

To maintain state machine synchronization, the devices rely on SWEN level transitions as well as timing for handshakes. This ensures all the devices turn ON and OFF synchronously and in the same manner (for

example, dVdt controlled or current limited start-up). There are also fail-safe mechanisms in the SWEN control and handshake logic to ensure the entire chain is turned off safely even if the primary device is unable to take control in case of a fault.

备注

TI recommends to keep the parasitic loading on the SWEN pin to a minimum to avoid synchronization timing issues.

8.3.11 Stacking Multiple eFuses for Unlimited Scalability

For systems needing higher current than supported by a single TPS25990, it is possible to connect TPS25990 in parallel with one or more TPS25985x devices to deliver the desired total system current. Conventional eFuses do not share current evenly between themselves during steady-state due to mismatches in their path resistances (which includes the individual device $R_{\text{DS(on)}}$ variation from part to part, as well as the parasitic PCB trace resistance). This fact can lead to multiple problems in the system:

1. Some devices always carry higher current as compared to other devices, which can result in accelerated failures in those devices and an overall reduction in system operational lifetime.
2. As a result, thermal hotspots form on the board, devices, traces, and vias carrying higher current, leading to reliability concerns for the PCB. In addition, this problem makes thermal modeling and board thermal management more challenging for designers.
3. The devices carrying higher current can hit their individual circuit-breaker threshold prematurely even while the total system load current is lower than the overall circuit-breaker threshold. This action can lead to false tripping of the eFuse chain during normal operation. This has the effect of lowering the current-carrying capability of the parallel chain. In other words, the current rating of the parallel eFuse chain needs to be de-rated as compared to the sum of the current ratings of the individual eFuses. This de-rating factor is a function of the path resistance mismatch, the number of devices in parallel, and the individual eFuse circuit-breaker accuracy.

The need for de-rating has an adverse impact on the system design. The designer is forced to make one of these trade-offs:

1. Limit the operating load current of the system to below the derated overcurrent threshold of the eFuse chain. Essentially, it means lower platform capabilities than are supported by the power supply (PSU).
2. Increase the overall circuit-breaker threshold to allow the desired system load current to pass through without tripping. As a consequence, the power supply (PSU) must be oversized to deliver higher currents during faults to account for the degradation of the overall circuit-breaker accuracy.

In either case, the system suffers from poor power supply utilization, which can mean sub-optimal system throughput or increased installation and operating costs, or both.

The TPS25990 and TPS25985x devices use a proprietary technique to address these problems and provide unlimited scalability of the solution by paralleling as many eFuses as needed. This is incorporated without significant current imbalance or any degradation in accuracy.

For this scheme to work correctly, the devices must be connected in the following manner:

- The SWEN pins of all the devices are connected together.
- The IMON pins of all the devices need to be connected together. The R_{IMON} resistor value on the combined IMON pin can be calculated using [方程式 11](#).

$$R_{\text{IMON}} = \frac{V_{\text{IREF}}}{G_{\text{IMON}} \times I_{\text{OCP(TOTAL)}}} \quad (11)$$

- The IREF pins of all the devices need to be connected together. The TPS25990 generates the V_{IREF} reference voltage for the whole chain using its internal DAC which can be programmed using PMBus® writes to the [VIREF](#) register. This allows the overcurrent protection thresholds to be dynamically adjusted during

system operation. It is also possible to drive the IREF pin using a low impedance external precision voltage reference.

- The start-up current limit and active current sharing threshold for each device is set independently using the ILIM pin. The R_{ILIM} value for the TPS25990 must be selected based on the following equation.

$$R_{ILIM(25990)} = \frac{1.1 \times (4N - 1) \times R_{IMON}}{9} \quad (12)$$

The R_{ILIM} value for each TPS25985x must be selected based on the following equation.

$$R_{ILIM(25985)} = \frac{1.1 \times (4N - 1) \times R_{IMON}}{12} \quad (13)$$

Where N = Number of devices in parallel chain ($1 \times$ TPS25990 + $(N - 1) \times$ TPS25985)

备注

- The active current sharing scheme is engaged when the current through any eFuse while in steady-state exceeds the individual current sharing threshold set by the R_{ILIM} based on [方程式 14](#).

$$R_{ILIM} = \frac{1.1 \times V_{IREF}}{3 \times I_{ILIM} \times I_{LIM(ACS)}} \quad (14)$$

- The active current sharing scheme is disengaged when the total system current exceeds the system overcurrent (circuit-breaker) threshold ($I_{OCP(TOTAL)}$).

8.3.11.1 Current Balancing During Start-Up

The TPS25990 implements a proprietary current balancing mechanism during start-up, which allows TPS25990 and TPS25985x devices connected in parallel to share the inrush current and distribute the thermal stress across all the devices. This feature helps to complete a successful start-up with all the devices and avoid a scenario where some of the eFuses hit thermal shutdown prematurely. This in effect increases the inrush current capability of the parallel chain. The improved inrush performance makes it possible to support very large load capacitors on high current platforms without compromising the inrush time or system reliability.

8.3.12 General Purpose Comparators

The device has two (2) general purpose comparators (CMP1 and CMP2) whose inputs, thresholds and outputs can be digitally configured. This allows the user complete flexibility to use these comparators as per system needs.

Comparator-1:

- The positive input of the comparator can be connected to either the TEMP/CMP pin, or internally to the IMON pin. Refer to the [DEVICE_CONFIG](#) register for more details and configuration options.
- The comparator threshold can be digitally configured using an internal DAC (CMP1REF). Refer to the [VCMPxREF](#) register for more details and configuration options.
- The comparator output can be digitally configured to be an output on one of the GPIO pins or used to trigger a fault which controls the FET ON/OFF status internally. Also, the comparator output polarity can be digitally configured. Refer to the [GPIO_CONFIG_12](#), [GPIO_CONFIG_34](#), and [DEVICE_CONFIG](#) registers for more details and configuration options.

Comparator-2:

- The comparator's positive input is internally connected to the AUX pin.
- The comparator threshold can be digitally configured using an internal DAC (CMP2REF). Refer to the [VCMPxREF](#) register for more details and configuration options.
- The comparator output can be digitally configured to be an output on one of the GPIO pins or used to trigger a fault which controls the FET ON/OFF status internally. Also, the comparator output polarity can be digitally configured. Refer to the [GPIO_CONFIG_12](#), [GPIO_CONFIG_34](#), and [DEVICE_CONFIG](#) registers for more details and configuration options.

These comparators can be used for various purposes. Here is one such example:

- **Programmable fast overcurrent detect (PROCHOT#):** Comparator-1 is configured to take IMON pin as the input and an appropriate reference voltage is set using the internal DAC (CMP1REF) in the **VCMPxREF** register. The comparator output is configured to be brought out on one of the General Purpose I/O pins. This pin is connected to the PROCHOT# pin of the processor. When the load current crosses the set threshold, the GPIOx goes low and signals the processor to throttle down immediately.



图 8-8. Programmable Fast Overcurrent (PROCHOT#) Detect Using Internal Comparator and General Purpose I/O



图 8-9. PROCHOT# Response Using Internal Comparator

8.3.13 Output Discharge

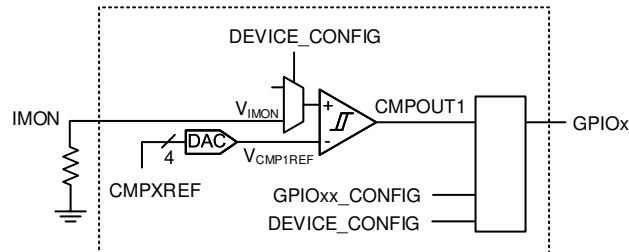
The TPS25990 has an integrated output discharge function which discharges the capacitors on the OUT pin using an internal constant current (I_{QOD}) sink path to GND. The output discharge function is activated when the EN/UVLO is held low ($V_{SD(F)} < V_{EN} < V_{UVLO(F)}$) for a minimum interval (t_{QOD}). The output discharge function helps to rapidly remove the residual charge left on large output capacitors and prevents the bus from staying at some undefined voltage for extended periods of time. The output discharge is disengaged when $V_{OUT} < V_{FB}$ or if the device detects a fault.

The output discharge function can result in excessive power dissipation inside the device leading to an increase in junction temperature (T_J). The output discharge is disabled if the junction temperature (T_J) crosses the device overtemperature threshold (TSD) to avoid long-term degradation of the part.

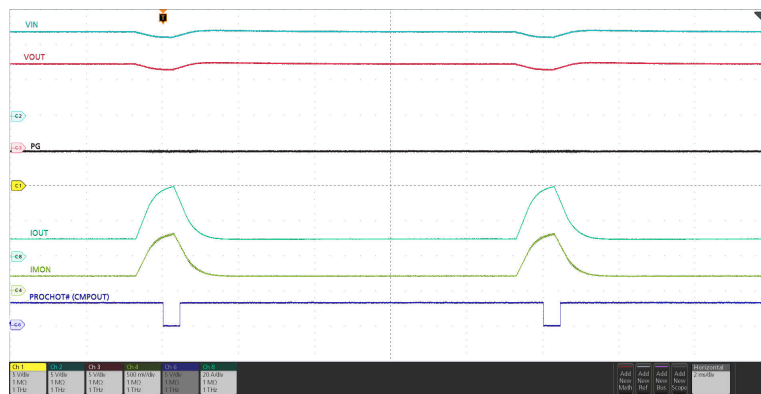
备注

In a primary and secondary parallel eFuse configuration, TI recommends to hold EN/UVLO voltage below the $V_{UVLO(F)}$ threshold of the secondary eFuse to activate output discharge for all the eFuses in the chain.

8.3.14 PMBus® Digital Interface

The TPS25990 is a PMBus® target device with an embedded digital telemetry controller block. This enables bi-directional communication with a host controller using a pre-defined set of commands to control, configure, monitor and debug the system.

The TPS25990 is compliant with PMBus® specifications version 1.3 Part I and Part II.

8.3.14.1 PMBus® Device Addressing

The TPS25990 uses 7-bit I2C device addressing. Up to 25 different addresses can be generated using different pin-strapping combinations on the ADDR0 and ADDR1 pins as shown in [表 8-5](#). This allows multiple devices to be connected to the same I2C bus.

表 8-5. TPS25990 PMBus® Address Decoding

ADDR0 Pin	ADDR1 Pin	PMBus® Device Address
Open	Open	0x40 (Default). Can be overwritten with a user defined address programmed into PMBUS_ADDR register in the Config NVM space.
Open	GND	0x41
Open	75 kΩ to GND	0x42
Open	150 kΩ to GND	0x43
Open	267 kΩ to GND	0x44
GND	Open	0x45
GND	GND	0x46
GND	75 kΩ to GND	0x47
GND	150 kΩ to GND	0x48
GND	267 kΩ to GND	0x49
75 kΩ to GND	Open	0x4A
75 kΩ to GND	GND	0x4B
75 kΩ to GND	75 kΩ to GND	0x4C
75 kΩ to GND	150 kΩ to GND	0x4D
75 kΩ to GND	267 kΩ to GND	0x4E
150 kΩ to GND	Open	0x50
150 kΩ to GND	GND	0x51
150 kΩ to GND	75 kΩ to GND	0x52
150 kΩ to GND	150 kΩ to GND	0x53
150 kΩ to GND	267 kΩ to GND	0x54
267 kΩ to GND	Open	0x55
267 kΩ to GND	GND	0x56
267 kΩ to GND	75 kΩ to GND	0x57
267 kΩ to GND	150 kΩ to GND	0x58
267 kΩ to GND	267 kΩ to GND	0x59

备注

1. TI recommends using low tolerance resistors on ADDR0 and ADDR1 to avoid address decoding errors.
2. TI recommends connecting 10 pF capacitors in parallel with resistors on ADDR0 and ADDR1 pins to improve noise immunity for correct address decoding.

8.3.14.2 SMBus™ Protocol

TPS25990 PMBus® interface is implemented over SMBus protocol using an I2C physical interface (SCL, SDA) for robust link. The following features are supported:

- Fast mode support (up to 1 MHz I2C clock speed)
- Bus timeout
- Support for Byte, Word and Block Read/Write with and without PEC
- Group command support
- SMBus Alert output pin (SMBA#) to alert/interrupt the host during certain system warning/fault events.
- Alert Response Address (ARA) support

8.3.14.3 SMBus™ Message Formats

TPS25990 supports the following SMBus message formats.

备注

All these commands can be used with or without the optional PEC byte.



图 8-10. Send Byte



图 8-11. Receive Byte

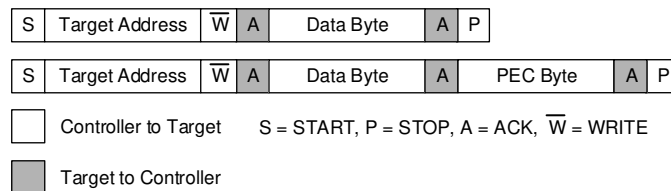

图 8-12. Write Byte

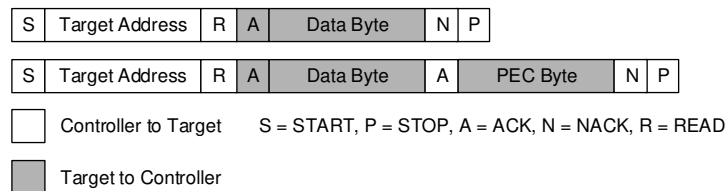

图 8-13. Read Byte

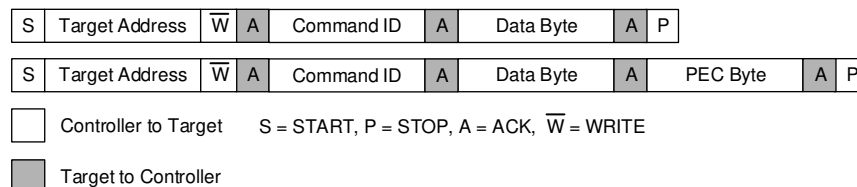

图 8-14. Write Word

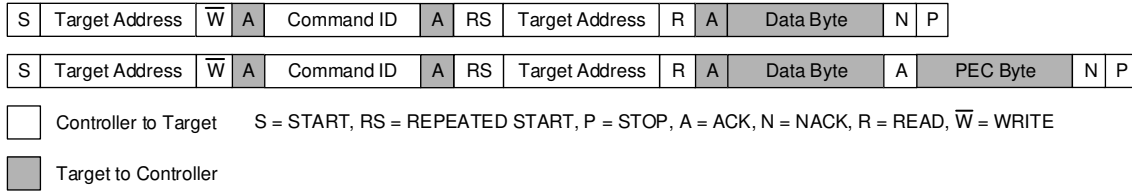

图 8-15. Read Word

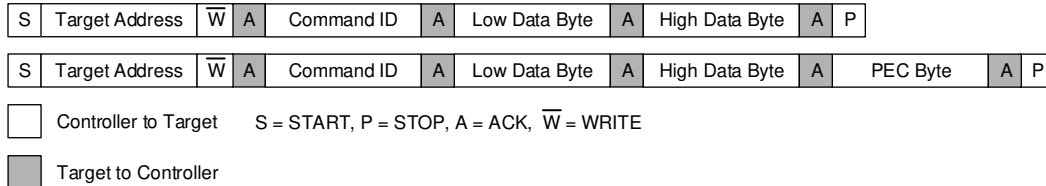

图 8-16. Block Read

8.3.14.4 Packet Error Checking

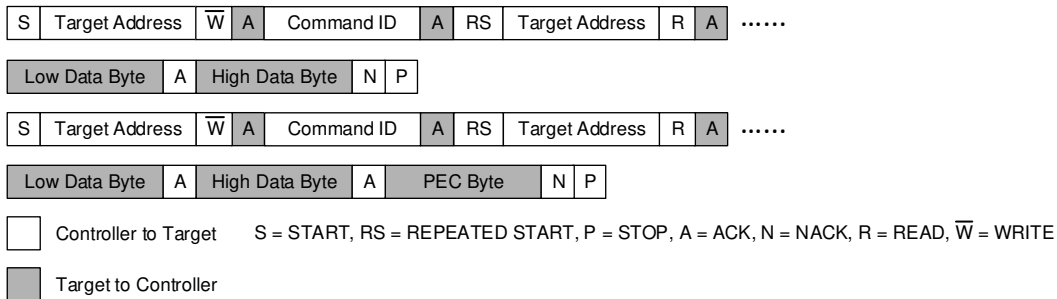
TPS25990 supports optional PEC for all SMBus transactions.

When using packet error checking, an additional byte is added before the stop bit in each transaction.

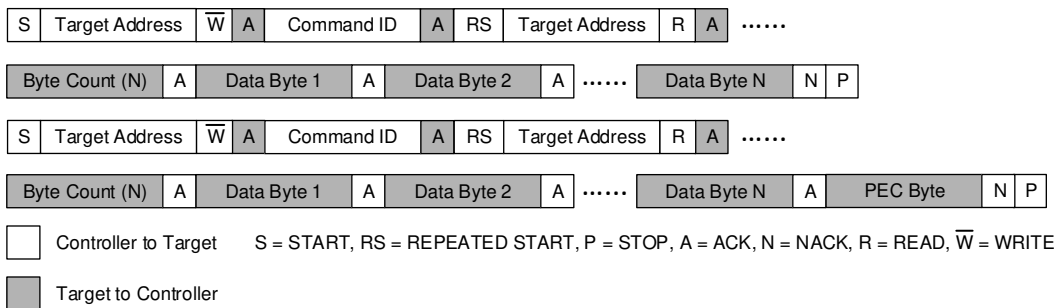
For reads, the PEC byte is read from the target and the controller compares it to its own PEC byte calculation. For writes, the PEC byte is sent to the target from the controller, and the target compares it to its own PEC byte calculation.

After the comparison, if the PEC bytes differ, the target detects a PEC error. Thereafter, it takes the following actions as per the PMBus® Specification:

- Does not respond to or act upon the command
- Flushes the command code and any received data
- Sets the CML_ERR bit in the [STATUS_BYTE](#) register

- Sets the INV_PEC bit in the [STATUS_CML](#) register

and

- Notifies the controller of a fault condition by pulling the SMBA# line low

8.3.14.5 Group Commands

As required by PMBus® specification, TPS25990 supports the Group Command Protocol. The Group Command Protocol is used to send commands to more than one PMBus® target device. The commands are sent in one continuous transmission. When the target devices detect the STOP condition that ends the sending of commands, they all begin executing the command they received.

It is not necessary that all target devices receive the same command.

No more than one command can be sent to any one device in one Group Command packet.

The Group Command Protocol must not be used with commands that require the receiving device to respond with data, such as the [STATUS_BYTE](#) command.

The Group Command Protocol uses REPEATED START conditions to separate commands for each device. The Group Command Protocol begins with the START condition, followed by the seven bit address of the first target device to receive a command and then by the write bit zero (0). The secondary device ACKs and the host controller sends a command with the associated data byte or bytes.

After the last data byte is sent to the first device, the host controller does NOT send a STOP condition. Instead, it sends a REPEATED START condition, followed by the seven bit address of the second device to receive a command, a write bit and the command code and the associated data bytes.

If, and only if, this is the last target device to receive a command, the host controller sends a STOP condition. Otherwise, the host controller sends a REPEATED START condition and starts transmitting the address of the third device to receive a command.

This process continues until all target devices have received their command codes, data bytes, and if used and supported, PEC byte. Then when all target devices have received their information, the host controller sends a STOP condition.

If PEC is used, then each target device's sub-packet has its own PEC byte, computed only for that device's sub-packet, including that target device's address.

When the target devices who have received a command through this protocol detect the STOP condition, they are to begin execution immediately of the received command.

When using Packet Error Checking with the Group Command Protocol, the PEC byte is calculated using only the address, command and data bytes for each target device. For example, PEC 1 is calculated using Device Address 1 including the Write bit, Command Code 1, and the data associated with Command Code 1. PEC 1 need only be calculated by the device at Device Address 1.

Similarly, PEC Byte 2 is calculated using Device Address 2 including the Write bit, Command Code 2, and the data associated with Command Code 2. Device 1 must not continue calculating PEC 1 after it sees the Repeated Start.

8.3.14.6 SMBus™ Alert Response Address (ARA)

When there are multiple target devices on the bus with their SMBA# pins also tied together, if one or more target devices assert the SMBA#, the host controller needs a way to identify those target devices on the bus. It does so using the ARA mechanism, which is initiated by sending a read command to the ARA broadcast address 0x0C.



图 8-17. ARA Message Protocol

The ARA Automatic Mask is a mask that is set in response to a successful ARA read. An ARA read operation returns the PMBus® address of the lowest addressed target device on the bus that has its SMBA# asserted. A successful ARA read means that this target device was the one that returned its address. When a target device responds to the ARA read, it releases the SMBA# signal. When the last target device on the bus that has an SMBA# set has successfully reported its address, the SMBA# signal will de-asserted.

The way that the TPS25990 releases the SMBA# signal is by setting the ARA Automatic mask bit for all fault conditions present at the time of the ARA read. All status registers will still show the fault condition, but it will not generate an SMBA# alert on that fault again until the ARA Automatic mask is cleared by the host issuing the [CLEAR_FAULTS](#) command to this part. This must be done as a routine part of servicing an SMBA# condition on a part, even if the ARA read is not done.

8.3.14.7 PMBus® Commands

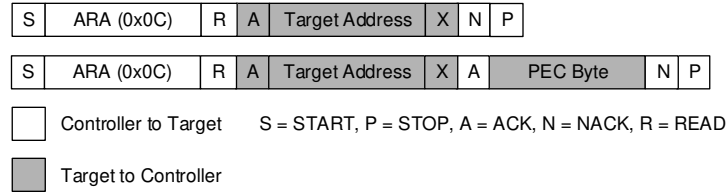
表 8-6 shows the list of PMBus® commands supported by the TPS25990 eFuse.

表 8-6. TPS25990 PMBus® Commands List

Command Name	Code	Type	Description	PMBus®Transaction	Default Value	Stored in On-chip Non-volatile Memory	Stored in EEPROM
OPERATION	01h	Control	eFuse ON/OFF control	Read/Write byte w/ PEC	0x80	N/A	N/A
CLEAR_FAULTS	03h	Control	Clear all fault status bits and Blackbox RAM	Send byte w/ PEC	N/A	N/A	N/A
RESTORE_FACTORY_DEFAULTS	12h	Control	Initialize/Reset all configuration registers to their factory default values	Send byte w/ PEC	N/A	N/A	N/A
STORE_USER_ALL	15h	Control	Store configuration values to NVM/EEPROM	Send byte w/ PEC	N/A	N/A	N/A
RESTORE_USER_ALL	16h	Control	Initialize all configuration registers with the user programmed values stored in NVM/EEPROM	Send byte w/ PEC	N/A	N/A	N/A
BB_ERASE	F5h	Control	Erase Blackbox data in external EEPROM	Send byte w/ PEC	N/A	N/A	N/A
FETCH_BB_EEPROM	F6h	Control	Fetch Blackbox EEPROM contents into internal shadow registers	Send byte w/ PEC	N/A	N/A	N/A
POWER_CYCLE	D9h	Control	Power down output and restart after a delay programmed through the RETRY_CONFIG register	Send byte w/ PEC	N/A	N/A	N/A

表 8-6. TPS25990 PMBus® Commands List (continued)

Command Name	Code	Type	Description	PMBus® Transaction	Default Value	Stored in On-chip Non-volatile Memory	Stored in EEPROM
MFR_WRITE_PROTECT	F8h	Control	Enable/Disable write protection for OPERATION & POWER_CYCLE commands, configuration registers, NVM, and EEPROM	Read/write byte w/ PEC	0x00	N/A	N/A
CAPABILITY	19h	Telemetry	Supported PMBus® features	Read byte w/ PEC	0xD0	Y	N
STATUS_BYTE	78h	Telemetry	Status register lower byte	Read byte w/ PEC	Undefined	N	N
STATUS_WORD	79h	Telemetry	Status register word	Read word w/ PEC	Undefined	N	Y
STATUS_OUT	7Ah	Telemetry	OUT bus status	Read byte w/ PEC	Undefined	N	N
STATUS_IOUT	7Bh	Telemetry	OUT current status	Read byte w/ PEC	Undefined	N	N
STATUS_INPUT	7Ch	Telemetry	IN bus status	Read byte w/ PEC	Undefined	N	Y
STATUS_TEMP	7Dh	Telemetry	Device temperature status	Read byte w/ PEC	Undefined	N	N
STATUS_CML	7Eh	Telemetry	Communications, Memory, Logic status	Read byte w/ PEC	Undefined	N	N
STATUS_MFR_SPECIFIC	80h	Telemetry	Manufacturer specific fault status	Read byte w/ PEC	Undefined	N	Y
STATUS_MFR_SPECIFIC_2	F3h	Telemetry	Additional manufacturer specific fault status	Read word w/ PEC	Undefined	N	N
PMBUS_REVISION	98h	Telemetry	PMBus® Specifications Part I and II rev 1.3	Read byte w/ PEC	0x33	Y	N
MFR_ID	99h	Telemetry	Manufacturer name	Block read 2 bytes w/ PEC	"TI"	Y	N
MFR_MODEL	9Ah	Telemetry	Device name	Block read 8 bytes w/ PEC	"TPS25990"	Y	N
MFR_REVISION	9Bh	Telemetry	Device revision	Block read 1 byte w/ PEC	0x01	Y	N
READ_VIN	88h	Telemetry	Input voltage	Read word w/ PEC	Undefined	N	N
READ_VOUT	8Bh	Telemetry	Output voltage	Read word w/ PEC	Undefined	N	N
READ_IIN	89h	Telemetry	Input current	Read word w/ PEC	Undefined	N	N
READ_TEMPERATURE_1	8Dh	Telemetry	Device temperature	Read word w/ PEC	Undefined	N	N
READ_VAUX	D0h	Telemetry	Auxiliary analog input voltage	Read word w/ PEC	Undefined	N	N
READ_PIN	97h	Telemetry	Instantaneous input power	Read word w/ PEC	Undefined	N	N
READ_EIN	86h	Telemetry	Accumulated input energy	Block read 6 bytes w/ PEC	Undefined	N	N
READ_VIN_AVG	DCh	Telemetry	Average input voltage	Read word w/ PEC	Undefined	N	N
READ_VIN_MIN	D1h	Telemetry	Minimum input voltage	Read word w/ PEC	Undefined	N	N

表 8-6. TPS25990 PMBus® Commands List (continued)

Command Name	Code	Type	Description	PMBus® Transaction	Default Value	Stored in On-chip Non-volatile Memory	Stored in EEPROM
READ_VIN_PEAK	D2h	Telemetry	Peak input voltage	Read word w/ PEC	Undefined	N	Y
READ_VOUT_AVG	DDh	Telemetry	Average output voltage	Read word w/ PEC	Undefined	N	N
READ_VOUT_MIN	DAh	Telemetry	Minimum output voltage	Read word w/ PEC	Undefined	N	N
READ_IIN_AVG	DEh	Telemetry	Average input current	Read word w/ PEC	Undefined	N	N
READ_IIN_PEAK	D4h	Telemetry	Peak input current	Read word w/ PEC	Undefined	N	Y
READ_TEMP_AVG	D6h	Telemetry	Average device temperature	Read word w/ PEC	Undefined	N	N
READ_TEMP_PEAK	D7h	Telemetry	Peak device temperature	Read word w/ PEC	Undefined	N	Y
READ_PIN_AVG	DFh	Telemetry	Average input power	Read word w/ PEC	Undefined	N	N
READ_PIN_PEAK	D5h	Telemetry	Peak input power	Read word w/ PEC	Undefined	N	N
READ_SAMPLE_BUF	D8h	Telemetry	ADC sample buffer	Block read 64 bytes w/ PEC	Undefined	N	N
READ_BB_RAM	FDh	Telemetry	Blackbox RAM registers	Block read 7 bytes w/ PEC	Undefined	N	Y
READ_BB_EEPROM	F4h	Telemetry	Blackbox EEPROM content	Block read 16 bytes w/ PEC	Undefined	N	Y
BB_TIMER	FAh	Telemetry	Blackbox tick timer	Read byte w/ PEC	Undefined	N	Y
PMBUS_ADDR	FBh	Configuration	PMBus® device address for ADDR0 = Open and ADDR1 = Open setting	Read/write byte w/ PEC	0x40	Y	Y
VIN_UV_WARN	58h	Configuration	Input undervoltage warning threshold	Read/write word w/ PEC	0x0095	N	N
VIN_UV_FLT	59h	Configuration	Input undervoltage fault threshold	Read/write word w/ PEC	0x008D	Y	Y
VIN_OV_WARN	57h	Configuration	Input overvoltage warning threshold	Read/write word w/ PEC	0x00A5	N	N
VIN_OV_FLT	55h	Configuration	Input overvoltage fault threshold	Read/write word w/ PEC	0x000E	Y	Y
VOUT_UV_WARN	43h	Configuration	Output undervoltage warning threshold	Read/write word w/ PEC	0x0095	N	N
VOUT_PGTH	5Fh	Configuration	Output threshold for Power Good de-assertion	Read/write word w/ PEC	0x008D	Y	Y
OT_WARN	51h	Configuration	Overtemperature warning threshold	Read/write word w/ PEC	0x007E	N	N
OT_FLT	4Fh	Configuration	Overtemperature fault threshold	Read/write word w/ PEC	0x0085	Y	Y

表 8-6. TPS25990 PMBus® Commands List (continued)

Command Name	Code	Type	Description	PMBus® Transaction	Default Value	Stored in On-chip Non-volatile Memory	Stored in EEPROM
PIN_OP_WARN	6Bh	Configuration	Input overpower warning threshold	Read/write word w/ PEC	0x00FF	N	N
IIN_OC_WARN	5Dh	Configuration	Input overcurrent warning threshold	Read/write word w/ PEC	0x00FF	N	N
VIREF	E0h	Configuration	Reference voltage for current regulation and protection blocks	Read/write byte w/ PEC	0x32	Y	Y
GPIO_CONFIG_1 2	E1h	Configuration	GPIO1 & GPIO2 configuration	Read/write byte w/ PEC	0x00	Y	Y
GPIO_CONFIG_3 4	E2h	Configuration	GPIO3 & GPIO4 configuration	Read/write byte w/ PEC	0x00	Y	Y
ALERT_MASK	DBh	Configuration	SMB Alert assertion mask	Read/write word w/ PEC	0x0100	N	N
FAULT_MASK	E3h	Configuration	FLT assertion mask	Read/write word w/ PEC	0x0000	Y	Y
DEVICE_CONFIG	E4h	Configuration	Device configuration	Read/write word w/ PEC	0x1400	Y	Y
BB_CONFIG	E5h	Configuration	Blackbox configuration	Read/write byte w/ PEC	0x00	Y	Y
OC_TIMER	E6h	Configuration	Transient overcurrent blanking timer	Read/write byte w/ PEC	0x14	N	N
RETRY_CONFIG	E7h	Configuration	Auto-retry configuration	Read/write byte w/ PEC	0x84	Y	Y
ADC_CONFIG_1	E8h	Configuration	ADC Configuration	Read/write byte w/ PEC	0x00	N	N
ADC_CONFIG_2	E9h	Configuration	ADC Configuration	Read/write byte w/ PEC	0x00	N	N
PK_MIN_AVG	EAh	Configuration	Peak/Min/Average configuration	Read/write byte w/ PEC	0x00	N	N
VCMPxREF	EBh	Configuration	General purpose comparator reference thresholds	Read/write byte w/ PEC	0xFF	Y	Y
PSU_VOLTAGE	ECh	Configuration	PSU nominal voltage	Read/write byte w/ PEC	0x9D	N	N
CABLE_DROP	EDh	Configuration	Maximum cable voltage drop expected	Read/write byte w/ PEC	0xFF	N	N
GPDAC1	F0h	Configuration	General purpose DAC1 output current	Read/write byte w/ PEC	0x00	Y	Y
GPDAC2	F1h	Configuration	General purpose DAC1 output voltage	Read/write byte w/ PEC	0x00	Y	Y
INS_DLY	F9h	Configuration	Insertion delay	Read/write byte w/ PEC	0x00	Y	Y

8.3.14.7.1 Detailed Descriptions of PMBus® Commands

8.3.14.7.1.1 OPERATION (01h, Read/Write Byte)

OPERATION is a PMBus® standard command that controls the FET inside the eFuse in conjunction with the input from the EN/UVLO pin. This command may be used to switch the eFuse ON and OFF under host control. It is also used to re-enable the eFuse after a fault-triggered shutdown.

This command uses the PMBus® read or write byte protocol.

表 8-7. OPERATION Command Description

Bit	Name	Value	Description	Default	Access
7	ON	1	<i>Enable</i> eFuse output enabled	1	Read/Write
		0	eFuse output disabled		
6:0	RESERVED	0000000	N/A	0000000	

备注

- This command should be preceded by the [MFR_WRITE_PROTECT](#) command to unlock the device first to prevent accidental/spurious writes.
- Writing an OFF command followed by an ON command will clear all the fault and warning bits in the status registers. Writing only an ON command after a fault-triggered shutdown will not clear the status registers.
- OFF command engages quick output discharge (QOD).

8.3.14.7.1.2 CLEAR_FAULTS (03h, Send Byte)

CLEAR_FAULTS is a standard PMBus® command that resets all latched warning/fault/status flags and de-asserts the SMBA# signal. If a fault or warning condition still exists when the CLEAR_FAULTS command is executed, the SMBA# signal may re-assert almost immediately or may not de-assert at all. Issuing the CLEAR_FAULTS command alone will not cause the eFuse to switch back ON in the event of a turn-off due to any fault. That must be done by issuing an [OPERATION OFF](#) command followed by [OPERATION ON](#) command or a [POWER_CYCLE](#) command after the fault condition is cleared, or through an auto-retry sequence. This command also clears the [BB_RAM](#) contents and resets the [BB_TIMER](#) register to zero (0). This command has no effect on Blackbox EEPROM memory contents.

This command uses the PMBus® send byte protocol. There is no data byte for this command. This command is write only.

备注

TI recommends sending the CLEAR_FAULTS command after every successful power-up of the device to clear the warning and fault bits set in the status registers during initialization, if any. This also ensures the SMBA# is de-asserted.

8.3.14.7.1.3 RESTORE_FACTORY_DEFAULTS (12h, Send Byte)

RESTORE_FACTORY_DEFAULTS is a standard PMBus® command that initializes or resets all the configuration RAM registers to their hardware defaults. Read the INIT_DONE bit in the [STATUS_MFR_SPECIFIC_2](#) register to check if initialization was completed successfully.

This command uses the PMBus® send byte protocol. There is no data byte for this command. This command is write only.

备注

This command should be preceded by the [MFR_WRITE_PROTECT](#) command to unlock the device first to prevent accidental/spurious writes.

8.3.14.7.1.4 STORE_USER_ALL (15h, Send Byte)

STORE_USER_ALL is a standard PMBus® command that writes the contents of the certain Configuration RAM registers to their respective non-volatile configuration memory (NVM) or EEPROM locations. The TPS25990 has two (2) one-time programmable banks in the NVM which are available to the users to store their custom

configurations. This command will try to write to NVM Bank-1 first if it's not programmed yet. If NVM Bank-1 is already programmed, it will attempt to write to NVM Bank-2 if it's not programmed. If NVM Bank-2 is already programmed, it will attempt to write to Page-2 of an external EEPROM if available and configured.

This command uses the PMBus® send byte protocol. There is no data byte for this command. This command is write only.

备注

- This command should be preceded by the [MFR_WRITE_PROTECT](#) command to unlock the device first to prevent accidental/spurious writes.
 - The external EEPROM needs to be enabled by setting the EXT_EEPROM bit in the [DEVICE_CONFIG](#) register. In addition, it is done by configuring two (2) of the four (4) GPIOs as EECLK and EEDATA appropriately in the [GPIO_CONFIG_12](#) and [GPIO_CONFIG_34](#) registers. Make sure those two (2) selected GPIO pins are physically connected to the EEPROM clock and data pins respectively on the board.
 - The MEMORY_FLT bit in the [STATUS_CML](#) register gets set if the STORE_USER_ALL command is unsuccessful. TI recommends reading the [STATUS_CML](#) register after sending the STORE_USER_ALL command to verify whether it was successful or not.
 - The NVM inside the TPS25990x eFuse only has **two (2)** one-time programmable banks available for user programming. If an external EEPROM is not used, before sending the STORE_USER_ALL command the user should ensure that at least one bank of internal NVM is available for programming by reading the CONFIG_NVM_STAT bit in the [STATUS_MFR_SPECIFIC_2](#) register.
-

8.3.14.7.1.5 RESTORE_USER_ALL (16h, Send Byte)

RESTORE_USER_ALL is a standard PMBus® command that initializes certain configuration RAM registers to their user programmed values from NVM or EEPROM.

This command uses the PMBus® send byte protocol. There is no data byte for this command. This command is write only.

The device follows the following sequence in response to the command:

- If NVM Bank-2 is programmed, the device will read from Bank-2. If the computed checksum matches the saved original checksum, the NVM configuration values will be loaded into the respective registers.
- Next, if an external EEPROM is connected as described in [节 8.3.14.7.1.4](#), and there is a valid configuration file in Page-2 of the connected EEPROM, the device will try to read from EEPROM Page-2. If the calculated checksum matches the stored checksum, the configuration values from EEPROM will be transferred into the device configuration registers.
- If NVM Bank-2 is not programmed, the device reads NVM Bank-1. If the calculated checksum matches the stored checksum, NVM configuration values will be loaded into the configuration registers. If NVM Bank-1 is not programmed, factory default values will be retained in the registers.

备注

- This command should be preceded by the [MFR_WRITE_PROTECT](#) command to unlock the device first to prevent accidental/spurious writes.
 - Read the MEMORY_FLT bit in the [STATUS_CML](#) register and the INIT_DONE bit in the [STATUS_MFR_SPECIFIC_2](#) register to check if initialization was completed successfully.
-

8.3.14.7.1.6 BB_ERASE (F5h, Send Byte)

BB_ERASE is a manufacturer specific command which fills the EEPROM Page-0 (where Blackbox information is stored) with all zeroes (0).

This command uses the PMBus® send byte protocol. There is no data byte for this command. This command is write only.

备注

This command should be preceded by the [MFR_WRITE_PROTECT](#) command to unlock the device first to prevent accidental accidental/spurious writes.

8.3.14.7.1.7 [FETCH_BB_EEPROM \(F6h, Send Byte\)](#)

[FTECH_BB_EEPROM](#) is a manufacturer specific command which loads the Blackbox contents from the external EEPROM (Page-0) into the Blackbox shadow registers internal to the device.

Those values can then be read back through PMBus® using the [READ_BB_EEPROM](#) command.

This command uses the PMBus® send byte protocol. There is no data byte for this command. This command is write only.

8.3.14.7.1.8 [POWER_CYCLE \(D9h, Send Byte\)](#)

[POWER_CYCLE](#) is a manufacturer specific command used to power down the output and power ON after a delay. The delay can be configured using the [RETRY_CONFIG](#) register.

This command uses the PMBus® send byte protocol. There is no data byte for this command. This command is write only.

备注

- This command should be preceded by the [MFR_WRITE_PROTECT](#) command to unlock the device first to prevent accidental/spurious writes.
 - If the device is turned OFF due a fault, issuing a [POWER_CYCLE](#) command alone doesn't alter the state of the device. This command should be preceded by a [CLEAR_FAULTS](#) command.
 - This command only attempts to reset the power path. Device state and register contents are preserved.
 - This command also engages quick output discharge (QOD) to discharge the output load and checks if the output is fully discharged before starting again.
-

8.3.14.7.1.9 [MFR_WRITE_PROTECT \(F8h, Read/Write Byte\)](#)

[MFR_WRITE_PROTECT](#) is a manufacturer specific command used to lock or unlock access to the configuration registers, NVM and EEPROM to prevent accidental/spurious PMBus® writes from altering the device configuration. It also blocks access to the [OPERATION](#), [RESTORE_FACTORY_DEFAULTS](#), [STORE_USER_ALL](#), [RESTORE_USER_ALL](#), [BB_ERASE](#), and [POWER_CYCLE](#) commands to prevent accidental/spurious PMBus® writes from altering the device state. The device is locked by default after power up or enable recycling.

This command uses the PMBus® read or write byte protocol.

A valid unlock command contains a data byte with Bit[7] equal to one (1) followed by a 7-bit password that matches a predefined pattern of 0x0100010. Writing 0xA2h in the [MFR_WRITE_PROTECT](#) register unlocks the device. Writing 0x00h in the [MFR_WRITE_PROTECT](#) register locks the device.

备注

Writing a data byte other than 0xA2h or 0x00h in the [MFR_WRITE_PROTECT](#) register will not change the lock status of the device, but will generate a CML error and set the [INV_DATA](#) bit in [STATUS_CML](#) register.

表 8-8. MFR_WRITE_PROTECT Command Description

Bit	Name	Value	Description	Default	Access
7	UNLOCK	0	<i>Lock Bit</i> Configuration register/NVM space locked	0	Read/Write
		1	Configuration register/NVM space unlocked		
6:0	PWD	0000000	<i>Password</i> Configuration register/NVM space locked	0000000	
		0100010	Configuration register/NVM space unlocked		

8.3.14.7.1.10 CAPABILITY (19h, Read Byte)

CAPABILITY is a standard PMBus® command that allows a host system to determine some key capabilities of a PMBus® device.

This command uses the PMBus® read byte protocol. There is one data byte formatted as shown in 表 8-9.

表 8-9. CAPABILITY Register Description

Bit	Name	Value	Description	Default	Access
7	PEC Support	1	<i>Packet Error Correction (PEC) support</i> PEC supported	1	Read
		0	PEC not supported		
6:5	Bus Speed	00	<i>Maximum bus interface speed</i> 100 kHz	10	
		01	400 kHz		
		10	1 MHz		
		11	Reserved for future use		
4	SMBA/ARA	1	<i>SMB Alert/Alert Response Address support</i> SMBA/ARA supported	1	
		0	SMBA/ARA not supported		
3:0	Reserved	0000	Reserved	0000	

8.3.14.7.1.11 STATUS_BYTE (78h, Read Byte)

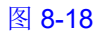
The TPS25990 implements all PMBus® status registers relevant to an eFuse/Hot-swap power controller.  8-18 shows a bit map of the TPS25990 status register.

STATUS_BYTE is a standard PMBus® command that returns one byte of information with a summary of the most critical faults.

This command uses the PMBus® read byte protocol.

To clear bits in this register, the underlying faults must be removed and the **CLEAR_FAULTS** command must be issued by the host controller.

表 8-10. STATUS_BYTE Register Description

Bit	Name	Value	Description	Default	Access
7	BUSY	1	<i>Device busy status</i> Device is busy	0	Read
		0	Device is not busy		
6	FET_OFF	1	<i>FET drive status</i> FET gate driver disabled	0	
		0	FET gate drive enabled		
5:4	Reserved	00	Reserved	00	
3	VIN_UV_FLT	1	<i>VIN undervoltage</i> VIN UV fault detected	0	
		0	VIN UV fault not detected		
2	STATUS_TEMP	1	<i>Overtemperature fault</i> Active bits set in STATUS_TEMP register	0	
		0	No active bits set in STATUS_TEMP register		
1	CML_ERR	1	<i>Communication, Memory or Logic error</i> Active bits set in STATUS_CML register	0	
		0	No active bits set in STATUS_CML register		
0	NONE_OF_THE_ABOVE	1	An event other than the ones listed in bits 7:1 has occurred	0	
		0	An event other than the ones listed in bits 7:1 has not occurred		

8.3.14.7.1.12 STATUS_WORD (79h, Read Word)

STATUS_WORD is a standard PMBus® command that returns two bytes of information with a summary of the eFuse fault conditions.

This command uses the PMBus® read word protocol.

To clear the bits in this register, the underlying faults must be removed and the CLEAR_FAULTS command must be issued by the host controller.

The low byte of STATUS_WORD is the same register as the STATUS_BYTE command. The STATUS_WORD register contents are described in 图 8-18 and 表 8-11.



图 8-18. Status Register Bit Map

表 8-11. STATUS_WORD Register Description

Bit	Name	Value	Description	Default	Access
15	OUT_STATUS	1	<i>OUTPUT fault status</i> Active bits set in the STATUS_OUT register	0	Read
		0	No active bits set in the STATUS_OUT register		
14	IOUT_STATUS	1	<i>IOUT fault status</i> Active bits set in the STATUS_IOUT register	0	
		0	No active bits set in the STATUS_IOUT register		
13	INPUT_STATUS	1	<i>INPUT fault status</i> Active bits set in the STATUS_INPUT register	0	
		0	No active bits set in the STATUS_INPUT register		
12	MFR_STATUS	1	<i>Manufacturer specific fault status</i> Active bits set in the STATUS_MFR_SPECIFIC register	0	
		0	No active bits set in the STATUS_MFR_SPECIFIC register		
11	PGOODB	1	<i>Power Good status</i> PGOOD de-asserted	1	
		0	PGOOD asserted		
10:9	Reserved	00	Reserved	00	
8	UNKNOWN	1	An event other than the ones listed in bits 15:1 has occurred	0	
		0	An event other than the ones listed in bits 15:1 has not occurred		
7:0	Same as STATUS_BYTE register				

 **8-19** depicts the relationship between the [STATUS_BYTE](#) register, the STATUS_WORD register and the more detailed status registers.

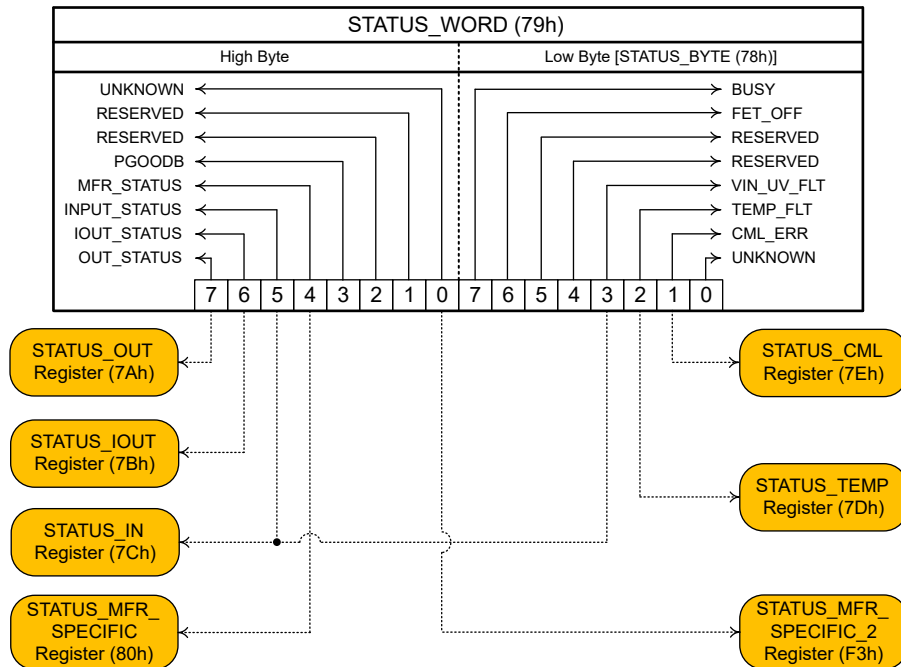
Based on the information in these bytes, the host can get more insight by reading the appropriate status registers.



图 8-19. Summary of the Status Registers

8.3.14.7.1.13 STATUS_OUT (7Ah, Read Byte)

STATUS_OUT is a standard PMBus® command that returns one data byte with contents as shown in 表 8-12.

This command uses the PMBus® read byte protocol.

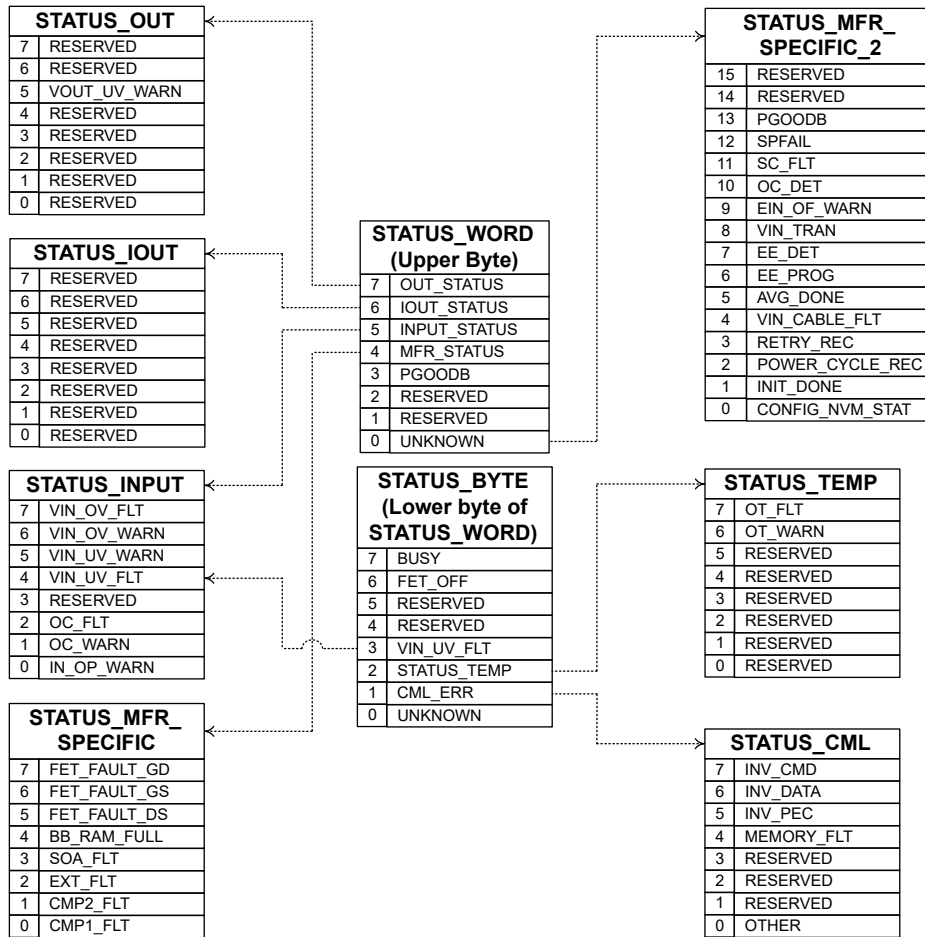
To clear the bits in this register, the underlying faults must be removed and the CLEAR_FAULTS command must be issued by the host controller.

表 8-12. STATUS_OUT Register Description

Bit	Name	Value	Description	Default	Access
7:6	Reserved	00	Reserved	00	Read
5	VOUT_UV_WARN	1	VOUT undervoltage warning VOUT UV warning threshold crossed	0	
		0	VOUT UV warning threshold not crossed		
4:0	Reserved	00	Reserved	00	

8.3.14.7.1.14 STATUS_IOUT (7Bh, Read Byte)

STATUS_IOUT is a standard PMBus® command that returns one data byte with contents as shown in [表 8-13](#).

表 8-13. STATUS_IOUT Register Description

Bit	Name	Value	Description	Default	Access
7:0	Reserved	00000000	Reserved	00000000	Read

备注

The input and output current information is identical for this device, so all the bits in this register are reserved. Refer to the [STATUS_INPUT](#) register instead for status information.

8.3.14.7.1.15 STATUS_INPUT (7Ch, Read Byte)

STATUS_INPUT is a standard PMBus® command that returns the status flags related to input voltage, current, and power as shown in [表 8-14](#).

This command uses the PMBus® read byte protocol.

To clear the bits in this register, the underlying faults must be removed and the [CLEAR_FAULTS](#) command must be issued by the host controller.

表 8-14. STATUS_INPUT Register Description

Bit	Name	Value	Description	Default	Access
7	VIN_OV_FLT	1	<i>VIN overvoltage fault</i> VIN OV fault threshold crossed	0	Read
		0	VIN OV fault threshold not crossed		
6	VIN_OV_WARN	1	<i>VIN overvoltage warning</i> VIN OV warning threshold crossed	0	
		0	VIN OV warning threshold not crossed		
5	VIN_UV_WARN	1	<i>VIN undervoltage warning</i> VIN UV warning threshold crossed	0	
		0	VIN UV warning threshold not crossed		
4	VIN_UV_FLT	1	<i>VIN undervoltage fault</i> VIN UV fault threshold crossed	0	
		0	VIN UV fault threshold not crossed		
3	Reserved	0	Reserved	0	
2	OC_FLT	1	<i>Overcurrent fault (Inrush & steady-state)</i> Input current crossed overcurrent fault threshold (Inrush) or OC_TIMER expired after input current crossed overcurrent fault threshold (steady-state)	0	
		0	Input current below overcurrent fault threshold or OC_TIMER not expired		

表 8-14. STATUS_INPUT Register Description (continued)

Bit	Name	Value	Description	Default	Access
1	OC_WARN	1	<i>Overcurrent warning (Inrush & steady-state)</i> Input current crossed overcurrent warning threshold	0	
		0	Input current below overcurrent warning threshold		
0	IN_OP_WARN	1	<i>Overpower warning</i> Input overpower warning threshold crossed	0	
		0	Input overpower warning threshold not crossed		

8.3.14.7.1.16 STATUS_TEMP (7Dh, Read Byte)

STATUS_TEMP is a standard PMBus® command that returns the status flags related to the overtemperature fault and warning as shown in [表 8-15](#).

This command uses the PMBus® read byte protocol.

To clear the bits in this register, the underlying faults must be removed and the [CLEAR_FAULTS](#) command must be issued by the host controller.

表 8-15. STATUS_TEMP Register Description

Bit	Name	Value	Description	Default	Access
7	OT_FLT	1	<i>Overtemperature fault</i> Device temperature crossed overtemperature fault threshold (TSD/OT_FLT)	0	Read
		0	Device temperature below overtemperature fault threshold (TSD/OT_FLT)		
6	OT_WARN	1	<i>Overtemperature warning</i> Device temperature crossed overtemperature warning threshold	0	
		0	Device temperature below overtemperature warning threshold		
5:0	Reserved	000000	Reserved	000000	

8.3.14.7.1.17 STATUS_CML (7Eh, Read Byte)

STATUS_CML is a standard PMBus® command that returns the status flags related to communication, logic, and memory faults as shown in 表 8-16.

This command uses the PMBus® read byte protocol.

To clear the bits in this register, the underlying faults must be removed and the [CLEAR_FAULTS](#) command must be issued by the host controller.

表 8-16. STATUS_CML Register Description

Bit	Name	Value	Description	Default	Access
7	INV_CMD	1	<i>Command status</i> Invalid/unsupported command received	0	Read
		0	Valid/supported command received		
6	INV_DATA	1	<i>Data status</i> Invalid/unsupported data received	0	
		0	Valid/supported data received		
5	INV_PEC	1	<i>Packet Error Check status</i> PEC failed	0	
		0	PEC passed		
4	MEMORY_FLT	1	<i>Memory fault status</i> Memory related fault - Configuration Memory Content Invalid (Empty or corrupted) OR STORE_USER_ALL or RESTORE_USER_A LL commands unsuccessful	0	
		0	No memory related fault		
3:1	Reserved	000	Reserved	000	
0	OTHER	Other communications failure		0	

备注

The SMBA# signal may be asserted due to a CML fault if the CML_ERR is unmasked in the [ALERT_MASK](#) register. If there are multiple PMBus® devices on the same bus, TI recommends unmasking the CML_ERR only while communicating with the TPS25990 and masking it at all other times. This prevents TPS25990 from asserting the SMBA# due to CML faults generated by other devices on the bus.

8.3.14.7.1.18 STATUS_MFR_SPECIFIC (80h, Read Byte)

STATUS_MFR_SPECIFIC is a standard PMBus® command that returns manufacturer-specific status information as shown in [表 8-17](#).

This command uses the PMBus® read byte protocol.

To clear the bits in this register, the underlying faults must be removed and the [CLEAR_FAULTS](#) command must be issued by the host controller.

表 8-17. STATUS_MFR_SPECIFIC Register Description

Bit	Name	Value	Description	Default	Access
7	FET_FAULT_GD	1	<i>FET fault type</i> Gate to drain fault	0	Read
		0	No gate to drain fault		
6	FET_FAULT_GS	1	<i>FET fault type</i> Gate to source fault	0	
		0	No gate to source fault		
5	FET_FAULT_DS	1	<i>FET fault type</i> Drain to source fault	0	
		0	No drain to source fault		
4	BB_RAM_FULL	1	<i>BB RAM fill status</i> Seven (7) events have been recorded	0	
		0	Seven (7) events not yet recorded		
3	SOA_FLT	1	<i>FET SOA status</i> Device turned off due to SOA limit violation	0	
		0	FET operating within SOA limit		
2	EXT_FLT	1	<i>External fault</i> Device turned off due to SWEN pin being pulled low externally by another device in parallel chain	0	
		0	SWEN pin not pulled low externally by another device in parallel chain		
1	CMP2_FLT	1	<i>AUX (CMP2) comparator fault indication</i> CMP2 fault detected	0	
		0	CMP2 fault not detected		
0	CMP1_FLT	1	<i>TEMP/CMP (CMP1) comparator fault indication</i> CMP1 fault detected	0	
		0	CMP1 fault not detected		

8.3.14.7.1.19 STATUS_MFR_SPECIFIC_2 (F3h, Read Word)

STATUS_MFR_SPECIFIC_2 is a manufacturer specific command which returns additional status information as shown in [表 8-18](#).

This command uses the PMBus® read word protocol.

To clear the bits in this register, the underlying faults must be removed and the [CLEAR_FAULTS](#) command must be issued by the host controller.

表 8-18. STATUS_MFR_SPECIFIC_2 Register Description

Bit	Name	Value	Description	Default	Access
15:14	Reserved	00	Reserved	00	Read
13	PGOODB	1	<i>PGOOD status</i> PGOOD low	0	
		0	PGOOD high		
12	SPFAIL	1	<i>Single point failure (ILIM/IMON/IREF)</i> Single point failure detected	0	
		0	Single point failure not detected		
11	SC_FLT	1	<i>Short-circuit fault</i> Short-circuit fault threshold crossed	0	
		0	Short-circuit fault threshold not crossed		
10	OC_DET	1	<i>Overcurrent detected (Inrush & steady-state)</i> Input current crossed overcurrent fault threshold but OC_TIMER not expired	0	
		0	Input current below overcurrent fault threshold		
9	EIN_OF_WARN	1	<i>EIN register overflow</i> EIN register overflowed	0	
		0	EIN register not overflowed		
8	VIN_TRAN	1	<i>VIN transient warning indication</i> VIN transient detected	0	
		0	VIN transient not detected		
7	EE_DET	1	<i>External EEPROM detect status</i> External EEPROM detected	0	
		0	External EEPROM not detected		

表 8-18. STATUS_MFR_SPECIFIC_2 Register Description (continued)

Bit	Name	Value	Description	Default	Access
6	EE_PROG	1	<i>External EEPROM programmed status</i> External EEPROM programmed	0	Read
		0	External EEPROM not programmed		
5	AVG_DONE	1	<i>Average computation complete status</i> Average computation done	0	
		0	Average computation ongoing		
4	VIN_CABLE_FLT	1	<i>Input cable fault indication</i> Cable fault detected	0	
		0	Cable fault not detected		
3	RETRY_REC	1	<i>Fault recovery/retry status</i> Device has recovered from fault through auto-retry	0	
		0	Normal power up i.e. Device has not recovered from fault through auto-retry		
2	POWER_CYCLE_RE C	1	<i>Power Cycle command status</i> Device has recovered from power cycle	0	Read
		0	Normal power up i.e. Device has not recovered from power cycle		
1	INIT_DONE	1	<i>Register Initialization status</i> Register Initialization Complete, All default/ Config values loaded into RAM	0	Read
		0	Register Initialization not complete		

表 8-18. STATUS_MFR_SPECIFIC_2 Register Description (continued)

Bit	Name	Value	Description	Default	Access
0	CONFIG_NVM_STAT	1	Configuration NVM Not available to be programmed	0	Read
		0	Available to be programmed		Read

8.3.14.7.1.20 PMBUS_REVISION (98h, Read Byte)

PMBUS_REVISION is a standard PMBus® command which returns the revision of the PMBus® standard to which the device conforms.

The command has one data byte. Bits[7:4] indicate the revision of PMBus® specification Part I to which the device is compliant. Bits[3:0] indicate the revision of PMBus® specification Part II to which the device is compliant. To access this command, use the PMBus® read byte protocol.

This command returns 0x33h from the TPS25990x eFuse. This implies the device is compliant with Part I rev 1.3 and Part II rev 1.3.

8.3.14.7.1.21 MFR_ID (99h, Block Read)

MFR_ID is a standard PMBus® command that returns the manufacturer name.

This command uses the PMBus® block read protocol with a block size of two (2). This register contains 0x5449h, which represents "TI" in ASCII.

8.3.14.7.1.22 MFR_MODEL (9Ah, Block Read)

MFR_MODEL is a standard PMBus® command that returns the device part number.

This command uses the PMBus® block read protocol with a block size of eight (8). This register contains 0x5450533235393930h, which represents "TPS25990" in ASCII.

8.3.14.7.1.23 MFR_REVISION (9Bh, Block Read)

MFR_REVISION is a standard PMBus® command that returns the device revision.

This command uses the PMBus® block read protocol with a block size of one (1). This register contains 0x01h.

8.3.14.7.1.24 READ_VIN (88h, Read Word)

READ_VIN is a standard PMBus® command that returns the 10-bit measured input voltage value.

This command uses the PMBus® read word protocol.

Follow the PMBus® DIRECT format conversion using the coefficients in 表 8-67 and 方程式 19, to convert the hexadecimal data read from this register into a real-world value in V.

表 8-19. READ_VIN Register Description

Bit	Name	Description	Minimum Value	Maximum Value	Access
15:0	READ_VIN	Value measured for input voltage	0x0000 (0 V)	0x03FF (19.48 V)	Read

8.3.14.7.1.25 READ_VOUT (8Bh, Read Word)

READ_VOUT is a standard PMBus® command that returns the 10-bit measured output voltage value.

This command uses the PMBus® read word protocol.

Follow the PMBus® DIRECT format conversion using the coefficients in 表 8-67 and 方程式 19, to convert the hexadecimal data read from this register into a real-world value in V.

表 8-20. READ_VOUT Register Description

Bit	Name	Description	Minimum Value	Maximum Value	Access
15:0	READ_VOUT	Value measured for output voltage	0x0000 (0 V)	0x03FF (19.48 V)	Read

8.3.14.7.1.26 READ_IIN (89h, Read Word)

READ_IIN is a standard PMBus® command that returns the 10-bit measured input current value.

This command uses the PMBus® read word protocol.

Follow the PMBus® DIRECT format conversion using the coefficients in 表 8-67 and 方程式 19, to convert the hexadecimal data read from this register into a real-world value in A.

表 8-21. READ_IIN Register Description

Bit	Name	Description	Minimum Value	Maximum Value	Access
15:0	READ_IIN	Value measured for input current	0x0000 (0 A)	0x03FF (107250/R _{IMON} A)	Read

8.3.14.7.1.27 READ_TEMPERATURE_1 (8Dh, Read Word)

READ_TEMPERATURE_1 is a standard PMBus® command that returns the 10-bit measured device temperature value.

This command uses the PMBus® read word protocol.

Follow the PMBus® DIRECT format conversion using the coefficients in 表 8-67 and 方程式 19, to convert the hexadecimal data read from this register into a real-world value °C.

表 8-22. READ_TEMPERATURE_1 Register Description

Bit	Name	Description	Minimum Value	Maximum Value	Access
15:0	READ_TEMPERATU RE_1	Value measured for device temperature	0x0000 (-229 °C)	0x03FF (501 °C)	Read

8.3.14.7.1.28 READ_VAUX (D0h, Read Word)

READ_VAUX is a manufacturer specific command that reports the 10-bit measured voltage on the AUX pin.

This command uses the PMBus® read word protocol.

Follow the PMBus® DIRECT format conversion using the coefficients in 表 8-67 and 方程式 19, to convert the hexadecimal data read from this register into a real-world value in V.

表 8-23. READ_VAUX Register Description

Bit	Name	Description	Minimum Value	Maximum Value	Access
15:0	READ_VAUX	Value measured for auxiliary voltage source connected at the AUX pin	0x0000 (0 V)	0x03FF (1.95 V)	Read

备注

Voltages greater than or equal to 1.95 V to ground are reported as full scale (0x03FFh). Voltages less than or equal to 0 V referenced to ground are reported as 0 V (0x0000h).

8.3.14.7.1.29 READ_PIN (97h, Read Word)

READ_PIN is a PMBus® standard command which returns the input power (input voltage multiplied by input current).

This command uses the PMBus® read word protocol.

Follow the PMBus® DIRECT format conversion using the coefficients in 表 8-67 and 方程式 19, to convert the hexadecimal data read from this register into a real-world value in W.

表 8-24. READ_PIN Register Description

Bit	Name	Description	Minimum Value	Maximum Value	Access
15:0	READ_PIN	Value measured for input power	0x0000 (0 W)	0x03FF (2089230/R _{IMON} W)	Read

8.3.14.7.1.30 READ_EIN (86h, Block Read)

The READ_EIN command is a standard PMBus® command which returns information to the host for computing the accumulated energy and average power consumption by a system powered by the eFuse. The information provided by this command is independent of any device specific averaging period, sampling frequency, or calculation algorithm.

This command uses the PMBus® block read protocol with a block size of six (6).

This command returns six (6) bytes of data. The first two (2) bytes are the two's complement and signed output of an accumulator that continuously sums samples of the instantaneous input power (the product of the samples of the input voltage and input current). These two data bytes are encoded in the DIRECT format as described in 节 8.3.14.10. The accumulator values are scaled so that the units are in “watt-samples”. This value in “watt-samples” must be multiplied by the effective ADC sampling period to obtain the real world value of energy accumulation in joules. If Bit[3] of the DEVICE_CONFIG register is set to high, the effective ADC sampling period is 18 µs (typical). Otherwise, it will be 11 µs (typical) by default.

The third data byte, ROLLOVER_COUNT is a count of rollover events for the accumulator. This byte is an unsigned integer indicating the number of times the accumulator has rolled over from its maximum positive value of 7FFFh to zero. The ROLLOVER_COUNT will periodically roll over from its maximum positive value to zero. It is up to the host to keep track of the state of the ROLLOVER_COUNT and account for the rollovers.

The other three (3) data bytes are a 24-bit unsigned integer that counts the number of samples of the instantaneous input power accumulated till now. This value will also roll over periodically from its maximum positive value to zero.

The combination of the accumulator and the rollover count may overflow within a few seconds. It is left to the host software to detect this overflow and handle it appropriately. Similarly, the sample count value will overflow. However, this event only occurs every five (5) minutes if Bit[3] of the DEVICE_CONFIG register is set to high, otherwise every three (3) minutes.

表 8-25. READ_EIN Register Description

BYTE	Description	DEFAULT	Access
0	Power Accumulator Low Byte	0x00	Read
1	Power Accumulator High Byte	0x00	
2	Power Accumulator Rollover Count	0x00	
3	Sample Count Low byte	0x00	
4	Sample Count Mid byte	0x00	
5	Sample Count High byte	0x00	

The host uses the accumulator value and rollover count to calculate the current “energy count” in “watt-samples” using [方程式 15](#).

$$Energy_Count = (Rollover_Count \times Accumulator_Roll_Over_Value) + Accumulator_Value \quad (15)$$

Where the Accumulator_Roll_Over_Value is the maximum possible positive value of the accumulator plus one (1). It is necessary to add one (1) to the maximum accumulator value to make the average power calculation correctly. The Accumulator_Roll_Over_Value is calculated using [方程式 16](#).

$$Accumulator_Roll_Over_Value = \frac{1}{m} \left[\{ (Y_{MAX} + 1) \times 10^{-R} \} - b \right] = \frac{1}{m} \left[\{ (2^{15}) \times 10^{-R} \} - b \right] \quad (16)$$

[表 8-67](#) includes the "m, b, R" coefficients used in [方程式 16](#). Accumulator_Value is obtained using the coefficients in [表 8-67](#) and [方程式 19](#). The real world value of energy accumulation in joules is calculated using [方程式 17](#).

$$Accumulated_Energy = Energy_Count \times Effective_ADC_Sampling_Period \quad (17)$$

If Bit[3] of the [DEVICE_CONFIG](#) register is set to high, the Effective_ADC_Sampling_Period is 18 μs (typical). Otherwise, it will be 11 μs (typical) by default. The host calculates the average power in watt since the last reading using [方程式 18](#).

$$Average_Power = \frac{Current_Energy_Count - Last_Energy_Count}{Current_Sample_Count - Last_Sample_Count} \quad (18)$$

备注

The ADC HI PERF bit in the [DEVICE_CONFIG](#) register) defines the ADC internal operating modes. The effective ADC sampling period is 11 μs in normal mode and 18 μs in high performance mode. The device is configured for normal mode by default. If it is necessary to change the ADC internal modes, it must be done before the downstream loads are enabled. It should not be changed under normal operation. This results in the wrong real world value for energy accumulation.

8.3.14.7.1.31 READ_VIN_AVG (DCh, Read Word)

READ_VIN_AVG is a manufacturer-specific command that reports 10-bit average value of input voltage.

This command uses the PMBus® read word protocol.

Follow the PMBus® DIRECT format conversion using the coefficients in [表 8-67](#) and [方程式 19](#), to convert the hexadecimal data read from this register into a real-world value in V.

表 8-26. READ_VIN_AVG Register Description

Bit	Name	Description	Minimum Value	Maximum Value	Access
15:0	READ_VIN_AVG	Value measured for average input voltage	0x0000 (0 V)	0x03FF (19.48 V)	Read

The sample count for averaging can be programmed through PMBus® using Bit[2:0] in the [PK_MIN_AVG](#) register. The contents of READ_VIN_AVG register can be reset to zero (0x0000h) by setting Bit[6] in the [PK_MIN_AVG](#) register.

8.3.14.7.1.32 READ_VIN_MIN (D1h, Read Word)

READ_VIN_MIN is a manufacturer-specific command that reports 10-bit minimum input voltage measured since a power-on reset or the last RESET_MIN (Bit[5] in the [PK_MIN_AVG](#) register) made high.

This command uses the PMBus® read word protocol.

Follow the PMBus® DIRECT format conversion using the coefficients in [表 8-67](#) and [方程式 19](#), to convert the hexadecimal data read from this register into a real-world value in V.

表 8-27. READ_VIN_MIN Register Description

Bit	Name	Description	Minimum Value	Maximum Value	Access
15:0	READ_VIN_MIN	Value measured for minimum input voltage since reset or last clear	0x0000 (0 V)	0x03FF (19.48 V)	Read

8.3.14.7.1.33 READ_VIN_PEAK (D2h, Read Word)

READ_VIN_PEAK is a manufacturer-specific command that reports 10-bit maximum input voltage measured since a power-on reset or the last RESET_PEAK (Bit[7] in the PK_MIN_AVG register) command issued.

This command uses the PMBus® read word protocol.

Follow the PMBus® DIRECT format conversion using the coefficients in 表 8-67 and 方程式 19, to convert the hexadecimal data read from this register into a real-world value in V.

表 8-28. READ_VIN_PEAK Register Description

Bit	Name	Description	Minimum Value	Maximum Value	Access
15:0	READ_VIN_PEAK	Value measured for maximum input voltage since reset or last clear	0x0000 (0 V)	0x03FF (19.48 V)	Read

8.3.14.7.1.34 READ_VOUT_AVG (DDh, Read Word)

READ_VOUT_AVG is a manufacturer-specific command that reports 10-bit average values of output voltage telemetry. Data are updated with each data cycle, reducing averaged telemetry read latency. Average count can be programmed through PMBus® using Bit[2:0] in the PK_MIN_AVG register. The contents of READ_VOUT_AVG register can be reset to zero (0x0000h) by setting Bit[6] in the PK_MIN_AVG register high.

This command uses the PMBus® read word protocol.

Follow the PMBus® DIRECT format conversion using the coefficients in 表 8-67 and 方程式 19, to convert the hexadecimal data read from this register into a real-world value in V.

表 8-29. READ_VOUT_AVG Register Description

Bit	Name	Description	Minimum Value	Maximum Value	Access
15:0	READ_VOUT_AVG	Value measured for average output voltage	0x0000 (0 V)	0x03FF (19.48 V)	Read

8.3.14.7.1.35 READ_VOUT_MIN (DAh, Read Word)

READ_VOUT_MIN is a manufacturer-specific command that reports 10-bit minimum output voltage measured since a power-on reset or the last RESET_MIN (Bit[5] in the PK_MIN_AVG register) made high.

This command uses the PMBus® read word protocol.

Follow the PMBus® DIRECT format conversion using the coefficients in 表 8-67 and 方程式 19, to convert the hexadecimal data read from this register into a real-world value in V.

表 8-30. READ_VOUT_MIN Register Description

Bit	Name	Description	Minimum Value	Maximum Value	Access
15:0	READ_VOUT_MIN	Value measured for minimum output voltage since reset or last clear	0x0000 (0 V)	0x03FF (19.48 V)	Read

8.3.14.7.1.36 READ_IIN_AVG (DEh, Read Word)

READ_IIN_AVG is a manufacturer-specific command that reports 10-bit average values of input current telemetry. Data are updated with each data cycle, reducing averaged telemetry read latency. Average count can be programmed through PMBus® using Bit[2:0] in the [PK_MIN_AVG](#) register. The contents of READ_IIN_AVG register can be reset to zero (0x0000h) by setting Bit[6] in the [PK_MIN_AVG](#) register to high.

This command uses the PMBus® read word protocol.

Follow the PMBus® DIRECT format conversion using the coefficients in [表 8-67](#) and [方程式 19](#), to convert the hexadecimal data read from this register into a real-world value in A.

表 8-31. READ_IIN_AVG Register Description

Bit	Name	Description	Minimum Value	Maximum Value	Access
15:0	READ_IIN_AVG	Value measured for average input current	0x0000 (0 A)	0x03FF (107250/R _{IMON} A)	Read

8.3.14.7.1.37 READ_IIN_PEAK (D4h, Read Word)

READ_IIN_PEAK is a manufacturer-specific command that reports 10-bit maximum input current measured since a power-on reset or the last RESET_PEAK (Bit[7] in the [PK_MIN_AVG](#) register) made high.

This command uses the PMBus® read word protocol.

Follow the PMBus® DIRECT format conversion using the coefficients in [表 8-67](#) and [方程式 19](#), to convert the hexadecimal data read from this register into a real-world value in A.

表 8-32. READ_IIN_PEAK Register Description

Bit	Name	Description	Minimum Value	Maximum Value	Access
15:0	READ_IIN_PEAK	Value measured for maximum input current since reset or last clear	0x0000 (0 A)	0x03FF (107250/R _{IMON} A)	Read

8.3.14.7.1.38 READ_TEMP_AVG (D6h, Read Word)

The READ_TEMP_AVG command is a manufacturer-specific command that reports 10-bit average values of device temperature or auxiliary input voltage telemetry based on the state of Bit[7] in the [ADC_CONFIG_2](#) register. If this bit is set high, the READ_TEMP_AVG command reports average values of auxiliary input voltage telemetry, otherwise average values of device temperature telemetry. Default state of Bit[7] in the [ADC_CONFIG_2](#) register is low. Data are updated with each data cycle, reducing averaged telemetry read latency. Average count can be programmed through PMBus® using Bit[2:0] in the [PK_MIN_AVG](#) register. The contents of READ_TEMP_AVG register can be reset to zero (0x0000h) by setting Bit[6] in the [PK_MIN_AVG](#) register high.

This command uses the PMBus® read word protocol.

Follow the PMBus® DIRECT format conversion using the coefficients in [表 8-67](#) and [方程式 19](#), to convert the hexadecimal data read from this register into a real-world value in °C or V.

表 8-33. READ_TEMP_AVG Register Description

Bit	Bit[7] in the ADC_CONFIG_2 register	Name	Description	Minimum Value	Maximum Value	Access
15:0	1	READ_VAUX_AVG	Value measured for average auxiliary input voltage	0x0000 (0 V)	0x03FF (1.95 V)	Read
	0	READ_TEMP_AVG	Value measured for average device temperature	0x0000 (-229 °C)	0x03FF (501 °C)	

Make sure to use the DIRECT format calculation coefficients correctly based on the state of Bit[7] in the [ADC_CONFIG_2](#) register.

8.3.14.7.1.39 READ_TEMP_PEAK (D7h, Read Word)

READ_TEMP_PEAK is a manufacturer-specific command that reports 10-bit maximum device temperature measured since a power-on reset or the last RESET_PEAK (Bit[7] in the [PK_MIN_AVG](#) register) made high.

This command uses the PMBus® read word protocol.

Follow the PMBus® DIRECT format conversion using the coefficients in [表 8-67](#) and [方程式 19](#), to convert the hexadecimal data read from this register into a real-world value in °C.

表 8-34. READ_TEMP_PEAK Register Description

Bit	Name	Description	Minimum Value	Maximum Value	Access
15:0	READ_TEMP_PEAK	Value measured for maximum device temperature since reset or last clear	0x0000 (-229 °C)	0x03FF (501 °C)	Read

8.3.14.7.1.40 READ_PIN_AVG (DFh, Read Word)

READ_PIN_AVG is a manufacturer-specific command that reports 10-bit average values of input power telemetry. Data are updated with each data cycle, reducing averaged telemetry read latency. Average count can be programmed through PMBus® using Bit[2:0] in the [PK_MIN_AVG](#) register. The contents of this register can be reset to zero (0x0000h) by setting Bit[6] in the [PK_MIN_AVG](#) register high.

This command uses the PMBus® read word protocol.

Follow the PMBus® DIRECT format conversion using the coefficients in [表 8-67](#) and [方程式 19](#), to convert the hexadecimal data read from this register into a real-world value in W.

表 8-35. READ_PIN_AVG Register Description

Bit	Name	Description	Minimum Value	Maximum Value	Access
15:0	READ_PIN_AVG	Value measured for average input power	0x0000 (0 W)	0x03FF (2089230/R _{IMON} W)	Read

8.3.14.7.1.41 READ_PIN_PEAK (D5h, Read Word)

READ_PIN_PEAK is a manufacturer-specific command that reports 10-bit maximum input power measured since a power-on reset or the last RESET_PEAK (Bit[7] in the [PK_MIN_AVG](#) register) made high.

This command uses the PMBus® read word protocol.

Follow the PMBus® DIRECT format conversion using the coefficients in [表 8-67](#) and [方程式 19](#), to convert the hexadecimal data read from this register into a real-world value in W.

表 8-36. READ_PIN_PEAK Register Description

Bit	Name	Description	Minimum Value	Maximum Value	Access
15:0	READ_PIN_PEAK	Value measured for maximum input power since reset or last clear	0x0000 (0 W)	0x03FF (2089230/R _{IMON} W)	Read

8.3.14.7.1.42 READ_SAMPLE_BUF (D8h, Block Read)

READ_SAMPLE_BUF is a manufacturer-specific command used to read the latest sixty-four (64) samples of a particular parameter from a round-robin ADC buffer available in the device RAM. This allows multiple ADC samples to be captured at a higher speed and read out at on go without the bottleneck of reading individual samples sequentially over the PMBus® serial interface. This allows the system designer to reconstruct the time domain profile/waveform of that parameter in a given time interval. This could be useful during design or system debugging by functioning like an in-built "digital oscilloscope". The rate at which ADC samples are updated in the buffer depends on the effective ADC sampling period and the decimation rate/sample skip count. If Bit[3] of the [DEVICE_CONFIG](#) register is set to high, the effective ADC sampling period is 18 μs (typical). Otherwise, it will be 11 μs (typical) by default. The ADC channel to sample for buffering and the decimation rate/sample skip count can be configured through the [ADC_CONFIG_2](#) register. By selecting different decimation rates, users can choose between “fine time resolution with short aperture” and “coarse time resolution with wide aperture” .

This command uses the PMBus® block read protocol with a block size of sixty-four (64).

Follow the PMBus® DIRECT format conversion using the coefficients in [表 8-67](#) and [方程式 19](#), to convert the hexadecimal data bytes into their real-world values in the appropriate unit.

The ADC sample buffer starts buffering as soon as the device powers up. The buffering is paused under two different conditions:

1. The instant READ_SAMPLE_BUF command is issued. This ensures the sample buffer is not overwritten with new values while the host is reading out the previous set of values. After sixty-four (64) bytes have been read, it will again start buffering new samples.
2. In the event of a fault, which is latched internally as shown in [表 8-2](#). This ensures the snapshot of the samples prior to the fault event is preserved even if there's a delay from host in reading out the sample buffer. After issuing the [CLEAR_FAULTS](#) command, or writing [OPERATION OFF](#) command followed by [OPERATION ON](#) command, or toggling the EN/UVLO pin, it will again start buffering new samples.

图 8-20. ADC Sample Buffering Example

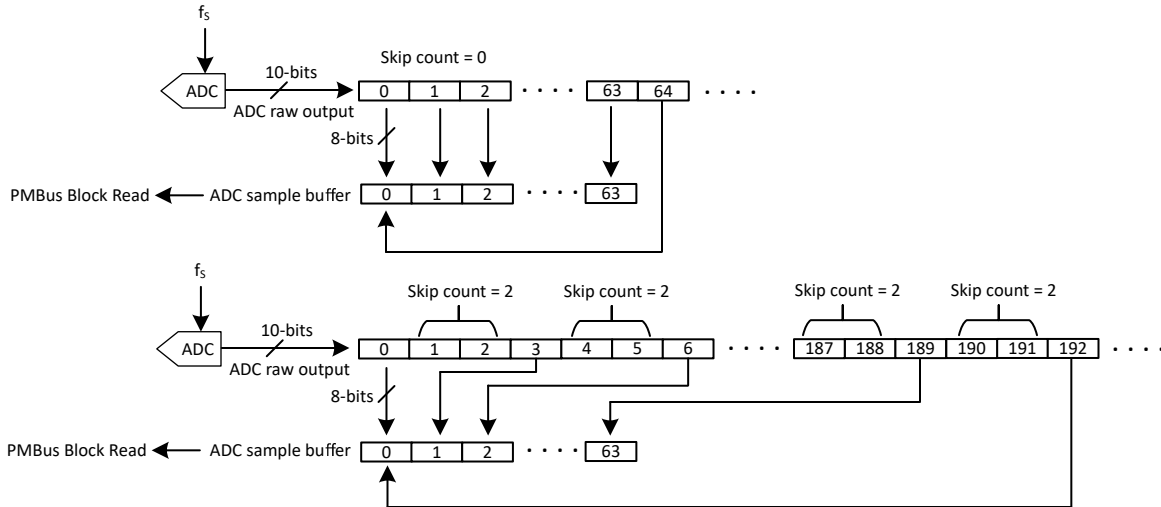

备注

The ADC samples are truncated from 10-bits to 8-bits while filling up the ADC sample buffer. Make sure to use the DIRECT format calculation coefficients correctly.

8.3.14.7.1.43 READ_BB_RAM (FDh, Block Read)

READ_BB_RAM is a manufacturer-specific command used to read the contents of the Blackbox buffer RAM, which is seven (7) bytes deep as described in 节 8.3.14.11.

This command uses the PMBus® block read protocol with a block size of seven (7).

表 8-37 presents details of the Blackbox RAM registers. There are seven (7) Blackbox RAM registers, starting from BB_RAM_0 to BB_RAM_6. Descriptions of all seven (7) registers (BB_RAM_0 to BB_RAM_6) are identical.

表 8-37. BB_RAM Register Description

Bit	Name	Value	Description	Default	Access
7:5	EVENT_ID	111	VIN_UV_WARN	000	Read
		110	VIN_OV_WARN		
		101	OC_WARN		
		100	OT_WARN		
		011	OC_DET		
		010	VIN_TRAN		
		001	IN_OP_WARN		
4	BB_TMR_EXP	1	Blackbox timer expired Blackbox timer overflowed at least once since the last event	0	Read
		0	Blackbox timer has not overflowed		
3:0	BB_TICK	0000	Blackbox tick timer	0000	Read

The Blackbox RAM contents get reset under the following events:

- Input power recycle at VIN or VDD pin
- ENABLE recycling
- [CLEAR_FAULTS](#) command
- [OPERATION OFF](#) command followed by [OPERATION ON](#) command
- Initiation of an auto-retry sequence

8.3.14.7.1.44 [READ_BB_EEPROM \(F4h, Block Read\)](#)

[READ_BB_EEPROM](#) is a manufacturer-specific command used to read contents stored in the Blackbox shadow registers internal to the TPS25990 eFuse. Before issuing this command, the [FETCH_BB_EEPROM](#) command needs to be sent to load the Blackbox contents from the external EEPROM (Page-0) as described in [节 8.3.14.11](#) into the Blackbox shadow registers. [READ_BB_EEPROM](#) retrieves sixteen (16) bytes of Blackbox information stored in the EEPROM as shown below.

- [BB_RAM_0](#) to [BB_RAM_6](#) [Seven (7) bytes]
- [BB_TIMER](#) [One (1) byte]
- [STATUS_WORD](#) [Two (2) bytes]
- [STATUS_MFR_SPECIFIC](#) [One (1) byte]
- [STATUS_INPUT](#) [One (1) byte]
- [VIN_PEAK](#) [One (1) byte, Eight (8) MSBs from the 10-bit ADC output data]
- [IIN_PEAK](#) [One (1) byte, Eight (8) MSBs from the 10-bit ADC output data]
- [TEMPERATURE_PEAK](#) [One (1) byte, Eight (8) MSBs from the 10-bit ADC output data]
- [CHECKSUM](#) [One (1) byte]

This command uses the PMBus® block read protocol with a block size of sixteen (16).

[VIN_PEAK](#), [IIN_PEAK](#), and [TEMPERATURE_PEAK](#) data use the PMBus® DIRECT format. Use the coefficients in [表 8-67](#) and [方程式 19](#) to convert the hexadecimal data read from these registers into their real-world value in the appropriate units.

备注

The peak input voltage, input current, and temperature values are truncated from 10-bits to 8-bits while stored in an external EEPROM. Make sure to use the DIRECT format calculation coefficients correctly.

8.3.14.7.1.45 [BB_TIMER \(FAh, Read Byte\)](#)

[BB_TIMER](#) is a manufacturer-specific command used to read the following:

- Blackbox RAM address pointer, indicating which Blackbox RAM has been filled to date. After filling up all seven (7) Blackbox RAM locations, it resets to zero.
- Blackbox timer expiry bit, showing if the Blackbox tick timer has overflowed at least once since the last event. This bit indicates if the Blackbox RAM event entries are relatively recent or old. This bit is latched when the timer overflows and resets to zero along with the free running timer when the next event occurs.
- Blackbox tick timer, a free running timer, which is reset to zero after every event. The timer update rate can be configured through the [BB_CONFIG](#) register. This allows users to tradeoff between fine resolution and longer time span depending on their debugging needs.

To access the [BB_TIMER](#) register, use the PMBus® read byte protocol. The whole content of this register resets to zero (0) at the instant the [CLEAR_FAULTS](#) command is issued. The details of the [BB_TIMER](#) register are shown in [表 8-38](#).

表 8-38. BB_TIMER Register Description

Bit	Name	Value	Description	Default	Access
7:5	BB_PTR	000	BB RAM address pointer Either all seven (7) Blackbox RAM registers are empty or all are filled up till date	000	Read
		001	BB_RAM_0 filled up till date		
		010	BB_RAM_0 and BB_RAM_1 filled up till date		
		011	BB_RAM_0, BB_RAM_1, and BB_RAM_2 filled up till date		
		100	BB_RAM_0, BB_RAM_1, BB_RAM_2, and BB_RAM_3 filled up till date		
		101	BB_RAM_0, BB_RAM_1, BB_RAM_2, BB_RAM_3, and BB_RAM_4 filled up till date		
		110	BB_RAM_0, BB_RAM_1, BB_RAM_2, BB_RAM_3, BB_RAM_4, and BB_RAM_5 filled up till date		
		111	Reserved		
4	BB_TMR_EXP	1	Blackbox timer expiry Blackbox timer overflowed at least once since the last event	0	
		0	Blackbox timer has not overflowed		
3:0	BB_TICK	Blackbox timer		0000	

8.3.14.7.1.46 PMBUS_ADDR (FBh, Read/Write Byte)

PMBUS_ADDR is a manufacturer-specific command used for reading and configuring a user-specific device address apart from the addresses mentioned in 表 8-5. The device uses this address for I2C communication

instead of the default value (0x40) when ADDR0 and ADDR1 pins are OPEN. This updated device address can be stored in the NVM and the device responds to this revised address upon power up next time.

This command uses the PMBus® read or write byte protocol.

8.3.14.7.1.47 VIN_UV_WARN (58h, Read/Write Word)

VIN_UV_WARN is a standard PMBus® command for configuring or reading an 8-bit threshold for the input undervoltage warning detection. This command uses the PMBus® DIRECT format. When reading and writing to this register, use the coefficients shown in 表 8-67, 方程式 19, and 方程式 20 to convert between real word units and hexadecimal values. This command uses the PMBus® read or write word protocol.

Contents of this register are compared to the VIN ADC telemetry value. If the measured VIN value falls below the value in this register, the VIN_UV_WARN flags are set in the respective registers. The SMBA# signal is asserted. When the input voltage rises above the VIN_UV_WARN threshold, and the CLEAR_FAULTS command is sent afterwards, this warning flag and alert are cleared.

表 8-39. VIN_UV_WARN Register Description

Bit	Name	Description	Minimum Value	Maximum Value	Default Value	Access
15:0	VIN_UV_WARN	Input undervoltage warning threshold	0x0000 (0 V)	0x00FF (19.42 V)	0x0095h (11.35 V)	Read/Write

When an input undervoltage warning is detected, the device:

- sets the NONE_OF_THE_ABOVE/UNKNOWN bit in the STATUS_BYTE register
- sets the INPUT_STATUS bit in the upper byte of the STATUS_WORD register
- sets the VIN_UV_WARN bit in the STATUS_INPUT register
- fills-up one of the Blackbox RAM registers (if available to write) writing the event identifier as VIN_UV_WARN and relative time stamp information
- increases the Blackbox RAM address pointer in the BB_TIMER register by one (1) if it was previously less than six (6), otherwise resets to zero (0). This change in the address pointer only occurs if one of the Blackbox RAM registers is available to write.
- notifies the host by asserting SMBA#, if it is not masked setting the STATUS_IN bit in the ALERT_MASK register and the GPIO4 pin is configured as SMBA# Output in the GPIO_CONFIG_34 register

备注

A write command to this register should be preceded by the MFR_WRITE_PROTECT command to unlock the device first to prevent accidental/spurious writes.

8.3.14.7.1.48 VIN_UV_FLT (59h, Read/Write Word)

VIN_UV_FLT is a standard PMBus® command for configuring or reading an 8-bit threshold for the input undervoltage fault detection. This command uses the PMBus® DIRECT format. When reading and writing to this register, use the coefficients shown in 表 8-67, 方程式 19, and 方程式 20 to convert between the real world units and hexadecimal values.

This command uses the PMBus® read or write word protocol.

Contents of this register are compared to the VIN ADC telemetry value. Once the input voltage has fallen below the undervoltage fault threshold, the output is turned off, and the VIN_UV_FLT flags are set in the respective registers. The SMBA# signal is asserted. 250 mV (typical) of hysteresis is added to the value in this register. This is to provide the rising threshold the input voltage must rise above for this fault to clear. Once the input voltage rises above the rising threshold, the output is turned back on. However, the fault flags and alerts remain until cleared by the host by sending the CLEAR_FAULTS command.

表 8-40. VIN_UV_FLT Register Description

Bit	Name	Description	Minimum Value	Maximum Value	Default Value	Access
15:0	VIN_UV_FLT	Input undervoltage fault threshold	0x0000 (0 V)	0x00FF (19.42 V)	0x008Dh (10.74 V)	Read/Write

When an input undervoltage fault is detected, the device:

- sets the FET_OFF, VIN_UV_FLT, and NONE_OF_THE_ABOVE/UNKNOWN bits in the [STATUS_BYTE](#) register
- sets the OUT_STATUS, INPUT_STATUS, PGOODB, and NONE_OF_THE_ABOVE/UNKNOWN bits in the upper byte of the [STATUS_WORD](#) register
- sets the VOUT_UV_WARN bit in the [STATUS_OUT](#) register
- sets the VIN_UV_FLT bit in the [STATUS_INPUT](#) register
- sets the PGOODB bit in the [STATUS_MFR_SPECIFIC_2](#) register
- notifies the host by asserting SMBA#, if it is not masked setting the STATUS_IN, PGOODB, and STATUS_OUT bits in the [ALERT_MASK](#) register and the GPIO4 pin is configured as SMBA# Output in the [GPIO_CONFIG_34](#) register
- deasserts the external PGOOD signal, if the GPIO1 pin is configured as PGOOD output in the [GPIO_CONFIG_12](#) register

备注

A write command to this register should be preceded by the [MFR_WRITE_PROTECT](#) command to unlock the device first to prevent accidental/spurious writes.

8.3.14.7.1.49 VIN_OV_WARN (57h, Read/Write Word)

VIN_OV_WARN is a standard PMBus® command for configuring or reading an 8-bit threshold for the input overvoltage warning detection. This command uses the PMBus® DIRECT format. When reading and writing to this register, use the coefficients shown in [表 8-67](#), [方程式 19](#), and [方程式 20](#) to convert between the real world units and hexadecimal values.

This command uses the PMBus® read or write word protocol.

Contents of this register are compared to the VIN ADC telemetry value. If the measured VIN value rises above the value in this register, the VIN_OV_WARN flags are set in the respective registers. The SMBA# signal is asserted. When the input voltage falls below the VIN_OV_WARN threshold, and the [CLEAR_FAULTS](#) command is sent afterwards, this warning flag and alert are cleared.

表 8-41. VIN_OV_WARN Register Description

Bit	Name	Description	Minimum Value	Maximum Value	Default Value	Access
15:0	VIN_OV_WARN	Input overvoltage warning threshold	0x0000 (0 V)	0x00FF (19.42 V)	0x00A5h (12.57 V)	Read/Write

When an input overvoltage warning is detected, the device:

- sets the NONE_OF_THE_ABOVE/UNKNOWN bit in the [STATUS_BYTE](#) register
- sets the INPUT_STATUS bit in the upper byte of the [STATUS_WORD](#) register
- sets the VIN_OV_WARN bit in the [STATUS_INPUT](#) register
- fills-up one of the Blackbox RAM registers (if available to write) writing the event identifier as VIN_OV_WARN and relative time stamp information
- increases the Blackbox RAM address pointer in the [BB_TIMER](#) register by one (1) if it was previously less than six (6), otherwise resets to zero (0). This change in the address pointer only occurs if one of the Blackbox RAM registers is available to write.

- notifies the host by asserting SMBA#, if it is not masked setting the STATUS_IN bit in the [ALERT_MASK](#) register and the GPIO4 pin is configured as SMBA# Output in the [GPIO_CONFIG_34](#) register

备注

A write command to this register should be preceded by the [MFR_WRITE_PROTECT](#) command to unlock the device first to prevent accidental accidental/spurious writes.

8.3.14.7.1.50 VIN_OV_FLT (55h, Read/Write Word)

VIN_OV_FLT is a standard PMBus® command for configuring or reading a 4-bit threshold for the input overvoltage fault detection. This command uses the PMBus® DIRECT format. When reading and writing to this register, use the coefficients shown in [表 8-67](#), [方程式 19](#), and [方程式 20](#) to convert between the real world units and hexadecimal values.

This command uses the PMBus® read or write word protocol.

Contents of this register drive a DAC to set the thresholds for a comparator monitoring the input voltage. Once the input voltage exceeds the overvoltage fault rising threshold, the output is turned off, and the VIN_OV_FLT flags are set in the respective registers. The SMBA# signal is asserted. 250 mV (typical) of hysteresis is subtracted from the value in this register. This is to provide the falling threshold the input voltage must fall below for this fault to clear. Once the input voltage falls below the falling threshold, the output is turned back on. However, the fault flags and alerts remain until cleared by the host by sending the [CLEAR_FAULTS](#) command.

表 8-42. VIN_OV_FLT Register Description

Bit	Name	Description	Minimum Value	Maximum Value	Default Value	Access
15:0	VIN_OV_FLT	Input overvoltage fault threshold	0x0000h (2.96 V)	0x000Fh (17.72 V)	0x000Eh (16.74 V)	Read/Write

When an input overvoltage fault is detected, the device:

- sets the FET_OFF and NONE_OF_THE_ABOVE/UNKNOWN bits in the [STATUS_BYTE](#) register
- sets the OUT_STATUS, INPUT_STATUS, PGOODB and NONE_OF_THE_ABOVE/UNKNOWN bits in the upper byte of the [STATUS_WORD](#) register
- sets the VOUT_UV_WARN bit in the [STATUS_OUT](#) register
- sets the VIN_OV_FLT bit in the [STATUS_INPUT](#) register
- sets the PGOODB bit in the [STATUS_MFR_SPECIFIC_2](#) register
- notifies the host by asserting SMBA#, if it is not masked setting the STATUS_IN, PGOODB, and STATUS_OUT bits in the [ALERT_MASK](#) register and the GPIO4 pin is configured as SMBA# Output in the [GPIO_CONFIG_34](#) register
- deasserts the external PG signal, if the GPIO1 pin is configured as PGOOD output in the [GPIO_CONFIG_12](#) register

备注

A write command to this register should be preceded by the [MFR_WRITE_PROTECT](#) command to unlock the device first to prevent accidental accidental/spurious writes.

8.3.14.7.1.51 VOUT_UV_WARN (43h, Read/Write Word)

VOUT_UV_WARN is a standard PMBus® command for configuring or reading an 8-bit threshold for the output undervoltage warning detection. This command uses the PMBus® DIRECT format. When reading and writing to this register, use the coefficients shown in [表 8-67](#), [方程式 19](#), and [方程式 20](#) to convert between the real world units and hexadecimal values.

This command uses the PMBus® read or write word protocol.

Contents of this register are compared to the VOUT ADC telemetry value. If the measured VOUT value falls below the value in this register, the VOUT_UV_WARN flags are set in the respective registers. The SMBA# signal is asserted. When the output voltage rises above the VOUT_UV_WARN threshold, and the CLEAR_FAULTS command is sent afterwards, this warning flag and alert are cleared.

表 8-43. VOUT_UV_WARN Register Description

Bit	Name	Description	Minimum Value	Maximum Value	Default Value	Access
15:0	VIN_UV_WARN	Input undervoltage warning threshold	0x0000h (0 V)	0x00FFh (19.42 V)	0x0095h (11.35 V)	Read/Write

When an output undervoltage warning is detected, the device:

- sets the NONE_OF_THE_ABOVE/UNKNOWN bit in the STATUS_BYTE register
- sets the OUT_STATUS bit in the upper byte of the STATUS_WORD register
- sets the VOUT_OV_WARN bit in the STATUS_OUT register
- notifies the host by asserting SMBA#, if it is not masked setting the STATUS_OUT bit in the ALERT_MASK register and the GPIO4 pin is configured as SMBA# Output in the GPIO_CONFIG_34 register.

备注

A write command to this register should be preceded by the MFR_WRITE_PROTECT command to unlock the device first to prevent accidental/spurious writes.

8.3.14.7.1.52 VOUT_PGTH (5Fh, Read/Write Word)

VOUT_PGTH is a standard PMBus® command for setting or reading an 8-bit output voltage threshold at which Power Good (PGOOD) is de-asserted. This command uses the PMBus® DIRECT format. When reading and writing to this register, use the coefficients shown in 表 8-67, 方程式 19, and 方程式 20 to convert between the real world units and hexadecimal values.

This command uses the PMBus® read or write word protocol.

Contents of this register are compared to the VOUT ADC telemetry value. Once the output voltage has fallen below the VOUT_PGTH threshold at any point of time during normal operation or the device detects a fault (except short-circuit), the PGOOD is de-asserted, and the PGOODB flags are set in the respective registers. The SMBA# signal is also asserted. 250 mV (typical) of hysteresis is added to the value in this register. In order for the PGOOD to be asserted again, the output voltage must rise above this rising threshold after clearing all underlying faults and enabling the FET internal to the device. However, the fault flags and alerts remain until cleared by the host by sending the CLEAR_FAULTS command.

表 8-44. VOUT_PGTH Register Description

Bit	Name	Description	Minimum Value	Maximum Value	Default Value	Access
15:0	VOUT_PGTH	Output power good de-assertion threshold	0x0000h (0 V)	0x00FFh (19.42 V)	0x008Dh (10.74 V)	Read/Write

When the output voltage is less than VOUT_PGTH threshold, the device:

- sets the NONE_OF_THE_ABOVE/UNKNOWN bit in the STATUS_BYTE register
- sets the PGOODB and NONE_OF_THE_ABOVE/UNKNOWN bits in the upper byte of the STATUS_WORD register
- sets the PGOODB bit in the STATUS_MFR_SPECIFIC_2 register
- notifies the host by asserting SMBA#, if it is not masked setting the PGOODB bit in the ALERT_MASK register and the GPIO4 pin is configured as SMBA# Output in the GPIO_CONFIG_34 register

备注

A write command to this register should be preceded by the [MFR_WRITE_PROTECT](#) command to unlock the device first to prevent accidental accidental/spurious writes.

8.3.14.7.1.53 OT_WARN (51h, Read/Write Word)

OT_WARN is a standard PMBus® command for configuring or reading an 8-bit threshold for the device overtemperature warning detection. This command uses the PMBus® DIRECT format. When reading and writing to this register, use the coefficients shown in [表 8-67](#), [方程式 19](#), and [方程式 20](#) to convert between the real world units and hexadecimal values.

This command uses the PMBus® read or write word protocol.

Contents of this register are compared to the VTEMP ADC telemetry value. If the device temperature rises above the value in this register, the OT_WARN flags are set in the respective registers. The SMBA# signal is asserted. When the device temperature falls below the OT_WARN threshold, and the [CLEAR_FAULTS](#) command is sent afterwards, this warning flag and alert are cleared.

表 8-45. OT_WARN Register Description

Bit	Name	Description	Minimum Value	Maximum Value	Default Value	Access
15:0	OT_WARN	Device overtemperature warning threshold	0x0000h (-229 °C)	0x00FFh (500 °C)	0x007Eh (131 °C)	Read/Write

When an overtemperature warning is detected, the device:

- sets the STATUS_TEMP bit in the [STATUS_BYTE](#) register
- sets the OT_WARN bit in the [STATUS_TEMP](#) register
- fills-up one of the Blackbox RAM registers (if available to write) writing the event identifier as OT_WARN and relative time stamp information
- increases the Blackbox RAM address pointer in the [BB_TIMER](#) register by one (1) if it was previously less than six (6), otherwise resets to zero (0). This change in the address pointer only occurs if one of the Blackbox RAM registers is available to write
- notifies the host by asserting SMBA#, if it is not masked setting the STATUS_TEMP bit in the [ALERT_MASK](#) register and the GPIO4 pin is configured as SMBA# Output in the [GPIO_CONFIG_34](#) register

备注

A write command to this register should be preceded by the [MFR_WRITE_PROTECT](#) command to unlock the device first to prevent accidental accidental/spurious writes.

8.3.14.7.1.54 OT_FLT (4Fh, Read/Write Word)

OT_FLT is a standard PMBus® command for configuring or reading an 8-bit threshold for the device overtemperature fault detection. This command uses the PMBus® DIRECT format. When reading and writing to this register, use the coefficients shown in [表 8-67](#), [方程式 19](#), and [方程式 20](#) to convert between the real world units and hexadecimal values.

This command uses the PMBus® read or write word protocol.

Contents of this register are compared to the VTEMP ADC telemetry value. Once the device temperature exceeds the overtemperature fault threshold, the output is turned off, and the OT_FLT flags are set in the respective registers. The SMBA# signal is asserted. Refer to [节 8.3.7](#) for more details on thermal shutdown. After the device recovers from an overtemperature fault, the [CLEAR_FAULTS](#) command clears the OT_FLT flag and alert.

表 8-46. OT_FLT Register Description

Bit	Name	Description	Minimum Value	Maximum Value	Default Value	Access
15:0	OT_WARN	Device overtemperature fault threshold	0x0000h (-229 °C)	0x00FFh (500 °C)	0x0085h (151 °C)	Read/Write

When an overtemperature fault is detected, the device:

- sets the FET_OFF, STATUS_TEMP, and NONE_OF_THE_ABOVE/UNKNOWN bits in the [STATUS_BYTE](#) register
- sets the OUT_STATUS, PGOODB, and NONE_OF_THE_ABOVE/UNKNOWN bits in the upper byte of the [STATUS_WORD](#) register
- sets the VOUT_UV_WARN bit in the [STATUS_OUT](#) register
- sets the OT_FLT bit in the [STATUS_TEMP](#) register
- sets the PGOODB bit in the [STATUS_MFR_SPECIFIC_2](#) register
- notifies the host asserting SMBA#, if it is not masked setting the STATUS_TEMP, PGOODB, and STATUS_OUT bits high in the [ALERT_MASK](#) register and the GPIO4 pin is configured as SMBA# Output in the [GPIO_CONFIG_34](#) register
- deasserts the external PGOOD signal, if the GPIO1 pin is configured as PGOOD Output in the [GPIO_CONFIG_12](#) register
- asserts the $\overline{\text{FLT}}$ signal, if it is not masked setting the TEMP_FLT bit high in the [FAULT_MASK](#) register and the GPIO2 pin is configured as $\overline{\text{FLT}}$ Output in the [GPIO_CONFIG_12](#) register

备注

A write command to this register should be preceded by the [MFR_WRITE_PROTECT](#) command to unlock the device first to prevent accidental/spurious writes.

8.3.14.7.1.55 PIN_OP_WARN (6Bh, Read/Write Word)

PIN_OP_WARN is a standard PMBus® command for configuring or reading an 8-bit threshold for the input overpower warning detection. This command uses the PMBus® DIRECT format. When reading and writing to this register, use the coefficients shown in [表 8-67](#), [方程式 19](#), and [方程式 20](#) to convert between the real world units and hexadecimal values.

This command uses the PMBus® read or write word protocol.

Contents of this register are compared to the calculated telemetry power value. If the input power rises above the value in this register, the PIN_OP_WARN flags are set in the respective registers. The SMBA# signal is asserted. When the input power falls below the PIN_OP_WARN threshold, and the [CLEAR_FAULTS](#) command is sent afterwards, this warning flag and alert are cleared.

表 8-47. PIN_OP_WARN Register Description

Bit	Name	Description	Minimum Value	Maximum Value	Default Value	Access
15:0	PIN_OP_WARN	Input overpower warning threshold	0x0000h (0 W)	0x00FFh (2089230/R _{IMON} W)	0x00FFh (2089230/R _{IMON} W)	Read/Write

When an input overpower warning is detected, the device:

- sets the NONE_OF_THE_ABOVE/UNKNOWN bit in the [STATUS_BYTE](#) register
- sets the INPUT_STATUS and NONE_OF_THE_ABOVE/UNKNOWN bits in the upper byte of the [STATUS_WORD](#) register
- sets the IN_OP_WARN bit in the [STATUS_INPUT](#) register

- may set the EIN_OF_WARN bit in the [STATUS_MFR_SPECIFIC_2](#) register
- fills-up one of the Blackbox RAM registers (if available to write) writing the event identifier as IN_OP_WARN and relative time stamp information
- increments the Blackbox RAM address pointer in the [BB_TIMER](#) register by one (1) if it was previously less than six (6), otherwise resets to zero (0). This change in the address pointer only occurs if one of the Blackbox RAM registers is available to write.
- notifies the host by asserting SMBA#, if it is not masked setting the STATUS_IN bit in the [ALERT_MASK](#) register and the GPIO4 pin is configured as SMBA# Output in the [GPIO_CONFIG_34](#) register

备注

A write command to this register should be preceded by the [MFR_WRITE_PROTECT](#) command to unlock the device first to prevent accidental accidental/spurious writes.

8.3.14.7.1.56 IIN_OC_WARN (5Dh, Read/Write Word)

IIN_OC_WARN is a standard PMBus® command for configuring or reading an 8-bit threshold for the input overcurrent warning detection. This command uses the PMBus® DIRECT format. When reading and writing to this register, use the coefficients shown in [表 8-67](#), [方程式 19](#), and [方程式 20](#) to convert between the real world units and hexadecimal values.

This command uses the PMBus® read or write word protocol.

Contents of this register are compared to the VIMON ADC telemetry value. If the input current rises above the value in this register, the IIN_OC_WARN flags are set in the respective registers. The SMBA# signal is asserted. When the input current falls below the IIN_OC_WARN threshold, and the [CLEAR_FAULTS](#) command is sent afterwards, this warning flag and alert are cleared.

表 8-48. IIN_OC_WARN Register Description

Bit	Name	Description	Minimum Value	Maximum Value	Default Value	Access
15:0	IIN_OC_WARN	Input overcurrent warning threshold	0x0000h (0 A)	0x00FFh (107250/R _{VIMON} A)	0x00FFh (107250/R _{VIMON} A)	Read/Write

When an input overcurrent warning is detected, the device:

- sets the NONE_OF_THE_ABOVE/UNKNOWN bit in the [STATUS_BYTE](#) register
- sets the INPUT_STATUS bit in the upper byte of the [STATUS_WORD](#) register
- sets the OC_WARN bit in the [STATUS_INPUT](#) register
- may set the EIN_OF_WARN bit in the [STATUS_MFR_SPECIFIC_2](#) register
- fills-up one of the Blackbox RAM registers (if available to write) writing the event identifier as OC_WARN and relative time stamp information
- increments the Blackbox RAM address pointer in the [BB_TIMER](#) register by one (1) if it was previously less than six (6), otherwise resets to zero (0). This change in the address pointer only occurs if one of the Blackbox RAM registers is available to write.
- notifies the host by asserting SMBA#, if it is not masked setting the STATUS_IN bit high in the [ALERT_MASK](#) register and the GPIO4 pin is configured as SMBA# Output in the [GPIO_CONFIG_34](#) register

备注

A write command to this register should be preceded by the [MFR_WRITE_PROTECT](#) command to unlock the device first to prevent accidental accidental/spurious writes.

8.3.14.7.1.57 VIREF (E0h, Read/Write Byte)

VIREF is a manufacturer-specific command for configuring or reading a 6-bit reference threshold for overcurrent & short-circuit protections and active current sharing blocks as described in [节 8.3.4.2](#), [节 8.3.4.3](#), and [节 8.3.4.4](#).

This command uses the PMBus® DIRECT format. When reading and writing to this register, use the coefficients shown in 表 8-67, 方程式 19, and 方程式 20 to convert between the real world units and hexadecimal values.

This command uses the PMBus® read or write byte protocol.

Contents of this register drive a DAC to set the threshold for different comparators monitoring the input current. The details of this register are shown in 表 8-49.

表 8-49. VIREF Register Description

Bit	Name	Description	Minimum Value	Maximum Value	Default Value	Access
7:0	VIREF	Programmable reference voltage for overcurrent & short-circuit protections and active current sharing blocks	0x00h (0.3 V)	0x3Fh (1.186 V)	0x32h (1 V)	Read/Write

备注

A write command to this register should be preceded by the [MFR_WRITE_PROTECT](#) command to unlock the device first to prevent accidental accidental/spurious writes.

8.3.14.7.1.58 GPIO_CONFIG_12 (E1h, Read/Write Byte)

GPIO_CONFIG_12 is a manufacturer-specific command for configuring or reading functionalities of GPIO1 (Pin-19) and GPIO2 (Pin-20) as described in 节 8.3.10.

This command uses the PMBus® read byte protocol.

The details of this register are shown in 表 8-50.

表 8-50. GPIO_CONFIG_12 Register Description

Bit	Name	Value	Description	Default	Access
7:5	GPIO1 configuration	111	<i>GPIO1 functionality</i> Reserved	000	Read/Write
		110	EEDATA		
		101	EECLK		
		100	COMP1 output		
		011	COMP2 output		
		010	General purpose logic output		
		001	General purpose logic input		
		000	PGOOD Output		
4		1	<i>GPIO1 pin state when configured as general purpose input/output</i> Pin set to HI	0	
		0	Pin set to LO		
3:1	GPIO2 configuration	111	<i>GPIO2 functionality</i> Reserved	000	
		110	EEDATA		
		101	EECLK		
		100	COMP1 output		
		011	COMP2 output		
		010	General purpose logic output		
		001	General purpose logic input		
		000	FLT output		
0		1	<i>GPIO2 pin state when configured as general purpose input/output</i> Pin set to HI	0	
		0	Pin set to LO		

备注

A write command to this register should be preceded by the [MFR_WRITE_PROTECT](#) command to unlock the device first to prevent accidental accidental/spurious writes.

8.3.14.7.1.59 GPIO_CONFIG_34 (E2h, Read/Write Byte)

GPIO_CONFIG_34 is a manufacturer-specific command for configuring or reading functionalities of GPIO3 (PIN-21) and GPIO4 (PIN-17) as described in [节 8.3.10](#).

This command uses the PMBus® read byte protocol.

The details of this register are shown in 表 8-51.

表 8-51. GPIO_CONFIG_34 Register Description

Bit	Name	Value	Description	Default	Access
7:5	GPIO3 configuration	111	<i>GPIO3 functionality</i> Reserved	000	Read/Write
		110	EEDATA		
		101	EECLK		
		100	COMP1 output		
		011	COMP2 output		
		010	General purpose logic output		
		001	General purpose logic input		
		000	SWEN		
4		1	<i>GPIO3 pin state when configured as general purpose input/output</i> Pin set to HI	0	
		0	Pin set to LO		
3:1	GPIO4 configuration	111	<i>GPIO4 functionality</i> Reserved	000	
		110	EEDATA		
		101	EECLK		
		100	COMP1 output		
		011	COMP2 output		
		010	General purpose logic output		
		001	General purpose logic input		
0		000	SMBA# output	0	
		1	<i>GPIO4 pin state when configured as general purpose input/output</i> Pin set to HI		
		0	Pin set to LO		

备注

- A write command to this register should be preceded by the [MFR_WRITE_PROTECT](#) command to unlock the device first to prevent accidental/spurious writes.
- When using a TPS25990 eFuse with one or more TPS25985x eFuse(s) in parallel, GPIO3 must be in its default configuration i.e. SWEN.

8.3.14.7.1.60 ALERT_MASK (DBh, Read/Write Word)

ALERT_MASK is a manufacturer-specific command for configuring or reading the events which are allowed to assert the SMBA# signal.

This command uses the PMBus® read or write word protocol.

Each bit corresponds to one of the analog or digital faults or warnings that would normally result in SMBA# being asserted. When the corresponding bit is high, that condition does not cause SMBA# to be asserted. If that condition occurs, the registers where that condition is captured are still updated (STATUS registers and Blackbox) and the device ON/OFF control is still active. The details of this register are shown in [表 8-52](#).

表 8-52. ALERT_MASK Register Description

Bit	Name	Value	Description	Default	Access
15:9	Reserved	0000000	Reserved	0000000	Read/Write
8	UNKNOWN	1	UNKNOWN status bit doesn't assert SMBA#	1	
		0	UNKNOWN status bit asserts SMBA#		
7	PGOODB	1	PGOOD falling doesn't assert SMBA#	0	
		0	PGOOD falling asserts SMBA#		
6	GLBL_FLT	1	GLBL_FLT doesn't assert SMBA#	0	
		0	GLBL_FLT asserts SMBA#		
5	MFR_STATUS	1	Active bits set in STATUS_MFR_SPECIFIC register don't assert SMBA#	0	
		0	Active bits set in STATUS_MFR_SPECIFIC register assert SMBA#		
4	STATUS_TEMP	1	Active bits set in STATUS_TEMP register don't assert SMBA#	0	
		0	Active bits set in STATUS_TEMP register assert SMBA#		
3	STATUS_OUT	1	Active bits set in STATUS_OUT register don't assert SMBA#	0	
		0	Active bits set in STATUS_OUT register assert SMBA#		
2	STATUS_IN	1	Active bits set in STATUS_INPUT register don't assert SMBA#	0	
		0	Active bits set in STATUS_INPUT register assert SMBA#		
1	CML_ERR	1	Active bits set in STATUS_CML register don't assert SMBA#	0	
		0	Active bits set in STATUS_CML register assert SMBA#		
0	STATUS_IOUT	1	Active bits set in STATUS_IOUT register don't assert SMBA#	0	
		0	Active bits set in STATUS_IOUT register assert SMBA#		

备注

- A write command to this register should be preceded by the [MFR_WRITE_PROTECT](#) command to unlock the device first to prevent accidental accidental/spurious writes.
 - `GLBL_FLT` is a logical OR of the status bits unmasked using the [FAULT_MASK](#) register.
-

8.3.14.7.1.61 [FAULT_MASK](#) (E3h, Read/Write Word)

[FAULT_MASK](#) is a manufacturer-specific command for configuring or reading the events to govern the global fault (`GLBL_FLT`) bit in asserting `SMBA#` as described in the [ALERT_MASK](#) register and causing the external `FLT` signal to be asserted, if the GPIO2 pin is configured as `FLT` in the [GPIO_CONFIG_12](#) register.

This command uses the PMBus® read or write word protocol.

The details of this register are shown in [表 8-53](#).

表 8-53. FAULT_MASK Register Description

Bit	Name	Value	Description	Default	Access
15:11	Reserved	00000	Reserved	00000	Read/Write
10	EXT_FLT	1	EXT_FLT doesn' t assert $\overline{\text{FLT}}$	0	
		0	EXT_FLT asserts $\overline{\text{FLT}}$		
9	CMP1_FLT	1	CMP1_FLT doesn' t assert $\overline{\text{FLT}}$	0	
		0	CMP1_FLT asserts $\overline{\text{FLT}}$		
8	CMP2_FLT	1	CMP2_FLT doesn' t assert $\overline{\text{FLT}}$	0	
		0	CMP2_FLT asserts $\overline{\text{FLT}}$		
7	FET_HEALTH	1	FET_HEALTH doesn' t assert $\overline{\text{FLT}}$	0	
		0	FET_HEALTH asserts $\overline{\text{FLT}}$		
6	SPFAIL	1	SPFAIL doesn' t assert $\overline{\text{FLT}}$	0	
		0	SPFAIL asserts $\overline{\text{FLT}}$		
5	SOA_FLT	1	SOA_FLT doesn' t assert $\overline{\text{FLT}}$	0	
		0	SOA_FLT asserts $\overline{\text{FLT}}$		
4:3	Reserved	00	Reserved	00	
2	TEMP_FLT	1	TEMP_FLT doesn' t assert $\overline{\text{FLT}}$	0	
		0	TEMP_FLT asserts $\overline{\text{FLT}}$		
1	OC_FLT	1	OC_FLT doesn' t assert $\overline{\text{FLT}}$	0	
		0	OC_FLT asserts $\overline{\text{FLT}}$		
0	SC_FLT	1	SC_FLT doesn' t assert $\overline{\text{FLT}}$	0	
		0	SC_FLT asserts $\overline{\text{FLT}}$		

备注

- A write command to this register should be preceded by the [MFR_WRITE_PROTECT](#) command to unlock the device first to prevent accidental accidental/spurious writes.
- This command only allows the user to choose which events will cause assertion of the $\overline{\text{FLT}}$ pin. Masking any event in the FAULT_MASK register doesn' t prevent the respective event from turning OFF the device.

8.3.14.7.1.62 DEVICE_CONFIG (E4h, Read/Write Word)

DEVICE_CONFIG is a manufacturer-specific command for configuring or reading several key device setup related information of TPS25990 eFuse.

This command uses the PMBus® read or write word protocol.

The details of this register are shown in [表 8-54](#).

表 8-54. DEVICE_CONFIG Register Description

Bit	Name	Value	Description	Default	Access
15	PG_DVDT_DLY	1	Internal PG delay for discharging DVDT capacitor 38 ms	0	Read/Write
		0	110 μs		
14	DIS_VDSFLT	1	Disable FET drain to source fault detection at start-up Low drain to source voltage doesn't trigger a fault	0	
		0	Low drain to source voltage triggers a fault		
13	SC_RETRY	1	Retry after short-circuit fault (Fast-trip) Retry once into current limit (Not a latched fault)	0	
		0	Remain off (latched fault)		
12:11	SPFAIL	11	Scalable fast-trip threshold 225% of I _{OCP(TOTAL)}	10	
		10	200% of I _{OCP(TOTAL)}		
		01	175% of I _{OCP(TOTAL)}		
		00	150% of I _{OCP(TOTAL)}		
10:9	DVDT_CONFIG	11	DVDT current scaling 150%	10	
		10	100%		
		01	75%		
		00	50%		
8	VIN_TRAN_DIS	1	Input transient blanking control Disabled	0	
		0	Enabled		
7	EXT_EEPROM	1	External EEPROM connection External EEPROM connected	0	Read/Write
		0	External EEPROM not connected		

表 8-54. DEVICE_CONFIG Register Description (continued)

Bit	Name	Value	Description	Default	Access
6	IREF_DAC2_SEL	1	IREF/DAC2 pin output selection DAC2	0	Read/Write
		0	IREF DAC		
5	CMP2_POL	1	Comparator-2 (COMP2) polarity (AUX pin) Active Low	0	Read/Write
		0	Active High		
4	CMP1_POL	1	Comparator-1 (COMP1) polarity (TEMP/CMP pin) Active Low	0	Read/Write
		0	Active High		
3	ADC_HI_PERF	1	ADC performance and speed selection High performance mode (Effective throughput = 18 μ s)	0	Read/Write
		0	High speed mode (Effective throughput = 11 μ s)		
2	CMP1_IN_SEL	1	+ve input signal for the Comparator-1 (CMP1) at TEMP/CMP pin TEMP pin	0	Read/Write
		0	IMON pin		
1	CMP1_FLT	1	Comparator-1 (COMP1) fault (TEMP/CMP pin) CMP1_FLT is a latched fault and turns off the device	0	Read/Write
		0	CMP1_FLT is not a latched fault and doesn't turn off the device		

表 8-54. DEVICE_CONFIG Register Description (continued)

Bit	Name	Value	Description	Default	Access
0	CMP2_FLT	1	<i>Comparator-2 (COMP2) fault (AUX pin)</i> CMP2_FLT is a latched fault and turns off the device	0	Read/Write
		0	CMP2_FLT is not a latched fault and doesn't turn off the device		

备注

A write command to this register should be preceded by the [MFR_WRITE_PROTECT](#) command to unlock the device first to prevent accidental/spurious writes.

8.3.14.7.1.63 BB_CONFIG (E5h, Read/Write Byte)

BB_CONFIG is a manufacturer-specific command for configuring or reading the behavior of the Blackbox function as described in [节 8.3.14.11](#).

This command uses the PMBus® read or write byte protocol.

The details of this register are shown in [表 8-55](#).

表 8-55. BB_CONFIG Register Description

Bit	Name	Value	Description	Default	Access
7	FET_OFF_WR	1	BB EEPROM write trigger Power FET turning OFF triggers write to BB EEPROM	0	Read/Write
		0	Power FET turning OFF doesn't trigger write to BB EEPROM		
6	FLT_WR	1	BB EEPROM write trigger Global Fault triggers write to BB EEPROM	0	
		0	Global Fault doesn't trigger write to BB EEPROM		
5	ALERT_WR	1	BB EEPROM write trigger SMBA# assertion triggers write to BB EEPROM	0	
		0	SMBA# assertion doesn't trigger write to BB EEPROM		
4:2	Reserved	000	Reserved	000	
1:0	BB_TICK	11	Blackbox timestamp tick interval 3500 μ s	00	
		10	870 μ s		
		01	220 μ s		
		00	55 μ s		

备注

A write command to this register should be preceded by the [MFR_WRITE_PROTECT](#) command to unlock the device first to prevent accidental/spurious writes.

[BB_CONFIG\[5\]](#) needs to be used in conjunction with the [ALERT_MASK](#) register to determine which events trigger the Blackbox write to the external EEPROM. However, the [GLBL_FLT \(ALERT_MASK\[6\]\)](#) signal is excluded from the list of signals driving ALERT for Blackbox write even if they are unmasked in the [ALERT_MASK](#) register.

8.3.14.7.1.64 OC_TIMER (E6h, Read/Write Byte)

OC_TIMER is a manufacturer-specific register used to program the overcurrent blanking digital timer duration as described in [节 8.3.4.2](#).

This command uses the PMBus® read/write byte protocol.

The details of this register are shown in [表 8-56](#).

表 8-56. OC_TIMER Register Description

Bit	Name	Description	Value	Overcurrent Blanking Timer Duration (ms)	Default Value	Access
7:0	OC_TIMER	Overcurrent blanking digital timer	0x00h	0	0x14h	Read/Write
			0x01h	0.109		
			0x02h	0.218		
			0x03h	0.327		
			0x04h	0.436		
			0x05h	0.545		
			0x06h	0.654		
			0x07h	0.763		
			...			
			0x0Ah	1.09		
			...			
			0x14h	2.18		
			...			
			0x64h	10.9		
			...			
			0xC8h	21.8		
...						
0xFFh	27.8					

备注

A write command to this register should be preceded by the [MFR_WRITE_PROTECT](#) command to unlock the device first to prevent accidental accidental/spurious writes.

8.3.14.7.1.65 RETRY_CONFIG (E7h, Read/Write Byte)

RETRY_CONFIG is a manufacturer-specific command for configuring or reading the retry behavior of the TPS25990 eFuse in the event of a fault as depicted in [节 8.3.10.1](#).

This command uses the PMBus® read or write byte protocol.

The details of this register are shown in [表 8-57](#).

表 8-57. RETRY_CONFIG Register Description

Bit	Name	Value	Description	Default	Access
7:6	RESPONSE	10	Shutdown and retry	10	Read

表 8-57. RETRY_CONFIG Register Description (continued)

Bit	Name	Value	Description	Default	Access
5:3	RETRY_CNT		<i>Retry count</i>	000	Read/Write
		111	Retry indefinitely		
		110	Retry 64 times		
		101	Retry 32 times		
		100	Retry 16 times		
		011	Retry 8 times		
		010	Retry 4 times		
		001	Retry 1 times		
2:0	RETRY_DLY		<i>Retry delay timer value</i>	100	Read/Write
		111	7000 ms		
		110	3500 ms		
		101	1750 ms		
		100	870 ms		
		011	435 ms		
		010	220 ms		
		001	110 ms		
000	55 ms				

备注

- A write command to this register should be preceded by the [MFR_WRITE_PROTECT](#) command to unlock the device first to prevent accidental/spurious writes.
- The delay used in the [POWER_CYCLE](#) command is also configured through Bit[2:0] of this register.

8.3.14.7.1.66 ADC_CONFIG_1 (E8h, Read/Write Byte)

ADC_CONFIG_1 is a manufacturer-specific command for configuring or reading channel selections and modes for ADC sampling as described in [节 8.3.14.8](#).

This command uses the PMBus® read or write byte protocol.

The details of this register are shown in [表 8-58](#).

表 8-58. ADC_CONFIG_1 Register Description

Bit	Name	Value	Description	Default	Access
7	$\overline{\text{EOC}}$		<i>End of conversion indication (Active Low)</i>	0	Read
		1	ADC is busy (Conversion in progress)		
		0	Conversion done		

表 8-58. ADC_CONFIG_1 Register Description (continued)

Bit	Name	Value	Description	Default	Access
6	CONVST	1	Software conversion start control (used with MODE = 01) Start conversion	0	Read/Write
		0	Do not start conversion		
5:4	MODE	11	ADC sampling mode Continuous conversion - Single channel	00	
		10	Single channel single conversion - External pin controlled		
		01	Single channel single conversion - software controlled		
		00	Continuous conversion - auto sequenced		
3:0	CONV_CH_SEL	1001-1111	Parameter/ADC Channel selection for sampling (MODE = 01 or 10 or 11) Reserved	0000	
		1000	GND (Applicable only in MODE = 01 or 10)		
		0111	VIREF (Applicable only in MODE = 01 or 10)		
		0110	ADDR1 (Applicable only in MODE = 01 or 10)		
		0101	ADDR0 (Applicable only in MODE = 01 or 10)		
		0100	VAUX		
		0011	VTEMP		
		0010	IIN		
		0001	VOUT		
		0000	VIN		

备注

- A write command to this register should be preceded by the [MFR_WRITE_PROTECT](#) command to unlock the device first to prevent accidental/spurious writes.
- MODE = 10 or 01 are debug-only modes and not recommended to be used during normal operation as they prevent the ADC from sampling all the necessary signals needed for the eFuse protection features.

8.3.14.7.1.67 ADC_CONFIG_2 (E9h, Read/Write Byte)

ADC_CONFIG_2 is a manufacturer-specific command for configuring or reading parameter selection and decimation rate (sample skip count) for high speed ADC sample buffering as described in [节 8.3.14.7.1.42](#).

This command uses the PMBus® read or write byte protocol.

The details of this register are shown in [表 8-59](#).

表 8-59. ADC_CONFIG_2 Register Description

Bit	Name	Value	Description	Default	Access
7	VAUX_VTEMP_SEL	1	Average auxiliary voltage or average temperature telemetry selection Use VAUX ADC channel as input for AUX_AVG computation	0	Read/Write
		0	Use TEMP ADC channel as input for TEMP_AVG computation		
6	Reserved	0	Reserved	0	Read

表 8-59. ADC_CONFIG_2 Register Description (continued)

Bit	Name	Value	Description	Default	Access
5:3	BUF_CH_SEL	111	<i>Parameter selection for buffering</i> Reserved (Will default to IIN)	000	
		110	Reserved (Will default to IIN)		
		101	Reserved (Will default to IIN)		
		100	VAUX		
		011	VTEMP		
		010	IIN		
		001	VOUT		
		000	VIN		
2:0	DEC_RATE	111	<i>Decimation rate (sample skip count) for ADC sample buffering</i> Decimation rate (sample skip count) = 7	0000	Read/Write
		110	Decimation rate (sample skip count) = 6		
		101	Decimation rate (sample skip count) = 5		
		100	Decimation rate (sample skip count) = 4		
		011	Decimation rate (sample skip count) = 3		
		010	Decimation rate (sample skip count) = 2		
		001	Decimation rate (sample skip count) = 1		
		000	Decimation rate (sample skip count) = 0		

备注

A write command to this register should be preceded by the [MFR_WRITE_PROTECT](#) command to unlock the device first to prevent accidental accidental/spurious writes.

8.3.14.7.1.68 PK_MIN_AVG (EAh, Read/Write Byte)

PK_MIN_AVG is a manufacturer-specific command that resets all the maximum, minimum, and average telemetry registers, such as [READ_VIN_PEAK](#), [READ_IIN_PEAK](#), [READ_TEMP_PEAK](#), [READ_PIN_PEAK](#), [READ_VIN_MIN](#), [READ_VOUT_MIN](#), [READ_VIN_AVG](#), [READ_VOUT_AVG](#), [READ_IIN_AVG](#), [READ_TEMP_AVG](#), and [READ_PIN_AVG](#). This register is also used to program the number of ADC samples to be used for averaging. Averaging a higher number of samples improves the accuracy at the expense of higher latency.

This command uses the PMBus® read or write byte protocol.

The details of this register are shown in [表 8-60](#).

表 8-60. PK_MIN_AVG Register Description

Bit	Name	Value	Description	Default	Access
7	RESET_PEAK	1	Reset all peak registers to 0	0	Read/Write
		0	No action		
6	RESET_AVG	1	Reset all average registers to 0	0	
		0	No action		
5	RESET_MIN	1	Reset all minimum registers to 0	0	
		0	No action		
4:3	Reserved	00	Reserved	00	
2:0	AVG_CNT	111	Average count = 128	000	
		110	Average count = 64		
		101	Average count = 32		
		100	Average count = 16		
		011	Average count = 8		
		010	Average count = 4		
		001	Average count = 2		
		000	Average count = 1		

备注

- A write command to this register should be preceded by the [MFR_WRITE_PROTECT](#) command to unlock the device first to prevent accidental accidental/spurious writes.
- As soon as the PK_MIN_AVG command is executed to clear the peak, minimum, and average registers, the RESET_PEAK, READ_MIN, and READ_AVG bits are automatically cleared to zero (0).

8.3.14.7.1.69 VCMPxREF (EBh, Read/Write Byte)

VCMPxREF is a manufacturer-specific command for configuring or reading reference thresholds for general purpose comparators as described in [节 8.3.12](#).

This command uses the PMBus® read or write byte protocol.

A 4-bit reference threshold is defined by VCMPxREF[3:0] for Comparator-1 (CMP1) and by VCMPxREF[7:4] for Comparator-2 (CMP2). Individually, VCMPxREF[3:0] and VCMPxREF[7:4] use the PMBus® DIRECT format. When reading and writing to this register, use the coefficients shown in 表 8-67, 方程式 19, and 方程式 20 for VCMPxREF[3:0] and VCMPxREF[7:4] separately to define each individual comparator's threshold.

Contents of this register drive a DAC to set the thresholds for the two (2) general purpose comparators. The details of this register are shown in 表 8-61.

表 8-61. VCMPxREF Register Description

Bit	Name	Description	Minimum Value	Maximum Value	Default Value	Access
7:4	CMP2REF	Programmable reference voltage for Comparator-2 (CMP2)	0x0xh (0.2 V)	0xFxh (1.7 V)	0xFxh (1.7 V)	Read/Write
3:0	CMP1REF	Programmable reference voltage for Comparator-1 (CMP1)	0xx0h (0.2 V)	0xxFh (1.7 V)	0xxFh (1.7 V)	

备注

A write command to this register should be preceded by the [MFR_WRITE_PROTECT](#) command to unlock the device first to prevent accidental/spurious writes.

8.3.14.7.1.70 PSU_VOLTAGE (ECh, Read/Write Byte)

PSU_VOLTAGE is a manufacturer-specific command for configuring or reading an 8-bit data corresponding to the input power supply voltage for implementing the input cable fault detection feature.

This command uses the PMBus® read or write byte protocol.

- **Sending a value to the PSU_VOLTAGE register:**

Real world value of input power supply voltage in V is converted into a 10-bit binary data through PMBus® DIRECT format conversion using 方程式 20 and the 'm', 'b', & 'R' coefficients corresponding to [READ_VIN](#) in 表 8-67. Hexadecimal value corresponding to the eight least significant bits from this 10-bit binary data needs to be written in the PSU_VOLTAGE register.

- **Interpreting the received values from the PSU_VOLTAGE register:**

One byte of hexadecimal data read from the PSU_VOLTAGE register needs to be converted into a 10-bit binary data by appending the [READ_VIN](#)[9:8] bits to the left side. The hexadecimal value corresponding to this 10-bit binary data needs to be converted to a real world value of input power supply voltage in V through PMBus® DIRECT format conversion using 方程式 19 and the 'm', 'b', & 'R' coefficients corresponding to [READ_VIN](#) in 表 8-67.

The details of this register are shown in 表 8-62.

表 8-62. PSU_VOLTAGE Register Description

Bit	Name	Description	READ_VIN[9:8]	Minimum Value	Maximum Value	Default Value	Access
7:0	PSU_VOLTAGE	Nominal input power supply voltage	00	0x00h (0 V)	0xFFh (4.86 V)	0x9Dh (2.99 V)	Read/Write
			01	0x00h (4.87 V)	0xFFh (9.73 V)	0x9Dh (7.86 V)	
			10	0x00h (9.75 V)	0xFFh (14.61 V)	0x9Dh (12.74 V)	
			11	0x00h (14.63 V)	0xFFh (19.48 V)	0x9Dh (17.62 V)	

备注

A write command to this register should be preceded by the [MFR_WRITE_PROTECT](#) command to unlock the device first to prevent accidental accidental/spurious writes.

8.3.14.7.1.71 CABLE_DROP (EDh, Read/Write Byte)

CABLE_DROP is a manufacturer-specific command that allows configuring or reading an 8-bit reference threshold for the maximum cable voltage drop expected to implement the input cable fault detection feature. This command uses the PMBus® DIRECT format. When reading and writing to this register, use the coefficients shown in [表 8-67](#), [方程式 19](#), and [方程式 20](#).

This command uses the PMBus® read or write byte protocol.

Contents of this register are compared with the difference between [PSU_VOLTAGE](#) and VIN ADC telemetry values. If this difference value exceeds the value in the CABLE_DROP register, the VIN_CABLE_FAULT flags are set in the respective registers. The SMBA# signal is asserted. When the difference between [PSU_VOLTAGE](#) and VIN ADC telemetry value falls below the CABLE_DROP threshold, and the [CLEAR_FAULTS](#) command is sent afterwards, this warning flag and alert are cleared. The details of this register are shown in [表 8-49](#).

表 8-63. CABLE_DROP Register Description

Bit	Name	Description	Minimum Value	Maximum Value	Default Value	Access
7:0	CABLE_DROP	Maximum cable voltage drop expected	0x00h (0 V)	0xFFh (4.845 V)	0xFFh (4.845 V)	Read/Write

When the input cable fault is detected, the device:

- sets the NONE_OF_THE_ABOVE/UNKNOWN bit in the [STATUS_BYTE](#) register
- sets the NONE_OF_THE_ABOVE/UNKNOWN bit in the upper byte of the [STATUS_WORD](#) register
- sets the VIN_CABLE_FLT bit in the [STATUS_MFR_SPECIFIC_2](#) register
- notifies the host asserting SMBA#, if it is not masked setting the UNKNOWN bit low in the [ALERT_MASK](#) register

备注

A write command to this register should be preceded by the [MFR_WRITE_PROTECT](#) command to unlock the device first to prevent accidental accidental/spurious writes.

8.3.14.7.1.72 GPDAC1 (F0h, Read/Write Byte)

GPDAC1 is a manufacturer-specific command that allows configuring or reading a 6-bit data driving a general purpose DAC to generate a constant current output at PIN-6 (DAC1). This command uses the PMBus® DIRECT format. When reading and writing to this register, use the coefficients shown in [表 8-67](#), [方程式 19](#), and [方程式 20](#).

This command uses the PMBus® read or write byte protocol.

The details of this register are shown in [表 8-64](#).

表 8-64. GPDAC1 Register Description

Bit	Name	Description	Minimum Value	Maximum Value	Default Value	Access
7:0	GPDAC1	General purpose DAC output-1	0x00h (6 µA)	0x3Fh (53.25 µA)	0x00h (6 µA)	Read/Write

备注

- A write command to this register should be preceded by the [MFR_WRITE_PROTECT](#) command to unlock the device first to prevent accidental accidental/spurious writes.
- Writing 1xxxxxb in this register disconnects the DAC output from the DAC1 pin making the pin high-impedance and sink no current.

8.3.14.7.1.73 GPDAC2 (F1h, Read/Write Byte)

GPDAC2 is a manufacturer-specific command that allows configuring or reading a 6-bit data driving a general purpose DAC to generate a constant voltage output on the IREF/DAC2 pin. This command uses the PMBus® DIRECT format. When reading and writing to this register, use the coefficients shown in [表 8-67](#), [方程式 19](#), and [方程式 20](#).

This command uses the PMBus® read or write byte protocol. The details of this register are shown in [表 8-65](#).

表 8-65. GPDAC2 Register Description

Bit	Name	Description	Minimum Value	Maximum Value	Default Value	Access
7:0	GPDAC2	General purpose DAC output-2	0x00h (0.3 V)	0x3Fh (1.186 V)	0x00h (0.3 V)	Read/Write

备注

- A write command to this register should be preceded by the [MFR_WRITE_PROTECT](#) command to unlock the device first to prevent accidental accidental/spurious writes.
- The GPDAC2 output is multiplexed with the [VIREF](#) DAC output and either one of them can be brought out to the IREF/DAC2 pin at a time depending on [DEVICE_CONFIG\[6\]](#) bit setting.
- If the GPDAC2 output is brought out to the IREF/DAC2 pin, the [VIREF](#) DAC voltage is still connected internally to the overcurrent & short-circuit protections and active current sharing blocks. This ensures the protection thresholds are determined by the VIREF DAC setting and not by the voltage on the IREF/DAC2pin.
- When using a TPS25990 eFuse with one or more TPS25985 eFuse(s) in parallel, the VIREF output must be brought out on the IREF/DAC2 pin. The [DEVICE_CONFIG\[6\]](#) setting to bring the GPDAC2 output on the pin must not be used in this configuration. This is to ensure the [VIREF](#) setting controls the reference for overcurrent & short-circuit protections and active current sharing for all the devices in the parallel chain.

8.3.14.7.1.74 INS_DLY (F9h, Read/Write Byte)

INS_DLY is a manufacturer-specific command which is used to program the [insertion delay](#) at start-up. The device implements a fixed analog insertion delay of 14 ms (typical). As described in [表 8-66](#), the INS_DLY register specifies a delay in addition to the fixed 14 ms delay.

This command uses the PMBus® read/write byte protocol.

表 8-66. INS_DLY Register Description

Bit	Name	Description	Value	Effective Insertion Delay (ms)	Default Value	Access
7:0	INS_DLY	Insertion delay at start-up	0x00h	14	0x00h	Read/Write
			0x01h	25		
			0x02h	68		
			0x03h	123		
			0x04h	230		
			0x05h	340		
			0x06h	450		
			0x07h	560		

备注

A write command to this register should be preceded by the [MFR_WRITE_PROTECT](#) command to unlock the device first to prevent accidental accidental/spurious writes.

8.3.14.8 Analog-to-digital Converter

The TPS25590x integrates a 10-bit, 460 KSPS SAR ADC preceded by an analog MUX. The following signals are available for sampling by the ADC:

- VIN
- VOUT
- VIMON
- VTEMP
- VAUX
- ADDR0
- ADDR1

The ADC uses a 5 kHz low-pass filter at the input to suppress high frequency noise (outside the ADC Nyquist bandwidth) and prevent aliasing.

备注

The ADC also supports a high performance mode wherein the sampling rate is traded off in favor of improved DNL and INL. In this mode, the sampling rate is reduced to 270 KSPS. This mode can be selected by setting the ADC_HI_PERF bit in the [DEVICE_CONFIG](#) register.

During normal operation, the ADC automatically sequences the channels. The ADC channel sequencer manages MUX channel selection for sampling.

备注

- The ADDR0 and ADDR1 signals are sampled only at startup to decode the PMBus® target address.
- The ADC implements background self-calibration to eliminate offset and gain errors inherent to the ADC.

The device also supports buffering of multiple samples of a selected parameter in RAM, which can be read by the host using the [ADC_SAMPLE_BUF](#) block read command. This allows the system designer to reconstruct the time domain profile/waveform of that parameter in a given interval. This can be useful during design/debugging

by functioning like an in-built "digital oscilloscope". The ADC channel to sample for buffering and the decimation rate/sample skip count can be user configured using PMBus® writes to the [ADC_CONFIG_2](#) register.

The TPS25990 can post-process raw ADC sampled data to compute the following derived parameters:

1. VIN Average
2. VIN Peak
3. VIN Min
4. VOUT Average
5. VOUT Min
6. IIN Average
7. IIN Peak
8. PIN
9. PIN Average
10. PIN Peak
11. EIN
12. Temperature Average
13. Temperature Peak
14. Cable voltage drop

A single ADC sample can have higher errors due to internal noise. It's possible to improve the ADC SNR and the telemetry accuracy by averaging higher number of samples. The number of samples to be averaged is user-programmable using the [PK_MIN_AVG](#) register. The minimum, maximum, and average values can also be reset using the [PK_MIN_AVG](#) register.

The TPS25990 performs digital comparison on the ADC sampled data to detect the following system events.

1. VIN UV WARN
2. VIN UV FAULT
3. VIN OV WARN
4. VOUT PGOOD
5. IIN OC WARN
6. OT WARN
7. OT FAULT
8. PIN OP WARN
9. CABLE FAULT

The results of the comparisons are reflected in the PMBus® status registers and can be configured to trigger other actions e.g. FET turn OFF (protection response) and \overline{FLT} output assertion for faults, SMBA# signal assertion for faults/warnings and Blackbox RAM/EEPROM update.

8.3.14.9 Digital-to-analog Converters

The TPS25990 integrates multiple DACs which are used to set the thresholds or gains of various blocks:

1. **VIREF**: This is a 6-bit buffered voltage output DAC which provides a programmable threshold for overcurrent protection, short-circuit protection and active current sharing blocks. This can be programmed using the [VIREF](#) register. This signal is available internally always for these blocks, and optionally can be brought on the IREF/DAC2 pin to drive other devices in a parallel chain.
2. **IDVDT**: This is a 2-bit current output DAC which sources current on the DVDT pin to provide output Slew Rate (DVDT) control. This can be programmed using the [DEVICE_CONFIG\[10:9\]](#) register bits.
3. **DAC1**: This is a 6-bit general purpose current output DAC which can sink current on the DAC1 pin. This can be programmed using the [GPDAC1](#) register.
4. **DAC2**: This is a 6-bit general purpose voltage output DAC. This can be programmed using the [GPDAC2](#) register. This can be brought out to the IREF/DAC2 pin and is multiplexed with the VIREF DAC.
5. **VOV**: This is a 4-bit DAC which provides a programmable threshold for the VIN overvoltage protection comparator. This can be programmed using the [VIN_OV_FLT](#) register.
6. **CMP2REF**: This is a 4-bit voltage output DAC which provides a programmable threshold for general purpose analog comparator-2 (CMP2) on AUX pin. This can be programmed using the [VCMPxREF\[7:4\]](#) register bits.

7. **CMP1REF:** This is a 4-bit voltage output DAC which provides a programmable threshold for general purpose analog comparator-1 (CMP1) on TEMP/CMP pin. This can be programmed using the [VCMPxREF\[3:0\]](#) register bits.

8.3.14.10 DIRECT format Conversion

For telemetry and configuration parameters, the TPS25990 supports DIRECT format. Digital codes for telemetry or configuration parameters can be converted to their equivalent real world units using [方程式 19](#) and [方程式 20](#).

- **Interpreting received values:**

The host system uses [方程式 19](#) to convert the value received from the PMBus® device into a reading of V, A, °C, or W:

$$X = \frac{1}{m}(Y \times 10^{-R} - b) \quad (19)$$

Where:

- X, is the calculated, “real world” value in the appropriate units (V, A, °C, or W);
- m, the slope coefficient, is a two byte, two’ s complement integer;
- Y, is a two byte two’ s complement integer received from the PMBus® device;
- b, the offset, is a two byte, two’ s complement integer; and
- R, the exponent, is a one byte, two’ s complement integer.

- **Sending a value:**

To send a value, the host must use [方程式 20](#) to find the value of Y:

$$Y = (mX + b) \times 10^R \quad (20)$$

Where:

- Y is the two byte two’ s complement integer to be sent to the unit;
- m, the slope coefficient, is the two byte, two’ s complement integer;
- X, a “real world” value, in units such as V, A, °C, or W, to be converted for transmission;
- b, the offset, is the two byte, two’ s complement integer; and
- R, the exponent, is the decimal value equivalent to the one byte, two’ s complement integer.

表 8-67. TPS25990 PMBus® DIRECT format Conversion Guide

Parameter	Units	Zero Code Analog Value	Full scale Digital Code	Full-scale Analog Value	m	b	R
READ_VIN	V	0	0x3FF	19.48	5251	0	- 2
READ_VIN_PEAK	V	0	0x3FF	19.48	5251	0	- 2
READ_VIN_PEAK_EEPROM	V	0	0xFF	19.42	13128	0	- 3
READ_VIN_MIN	V	0	0x3FF	19.48	5251	0	- 2
READ_VIN_AVG	V	0	0x3FF	19.48	5251	0	- 2
VIN_UV_WARN	V	0	0xFF	19.42	13128	0	- 3
VIN_UV_FLT	V	0	0xFF	19.42	13128	0	- 3
VIN_OV_WARN	V	0	0xFF	19.42	13128	0	- 3
VIN_OV_FLT	V	2.95	0xF	17.72	10163	- 30081	- 4
READ_VOUT	V	0	0x3FF	19.48	5251	0	- 2
READ_VOUT_AVG	V	0	0x3FF	19.48	5251	0	- 2
READ_VOUT_MIN	V	0	0x3FF	19.48	5251	0	- 2

表 8-67. TPS25990 PMBus® DIRECT format Conversion Guide (continued)

Parameter	Units	Zero Code Analog Value	Full scale Digital Code	Full-scale Analog Value	m	b	R
VOUT_UV_WARN	V	0	0xFF	19.42	13128	0	-3
VOUT_PGTH	V	0	0xFF	19.42	13128	0	-3
READ_IIN	A	0	0x3FF	107250/R _{IMON}	9.538 × R _{IMON}	0	-3
READ_IIN_AVG	A	0	0x3FF	107250/R _{IMON}	9.538 × R _{IMON}	0	-3
READ_IIN_PEAK	A	0	0x3FF	107250/R _{IMON}	9.538 × R _{IMON}	0	-3
READ_IIN_PEAK_EEPROM	A	0	0xFF	107250/R _{IMON}	23.8 × R _{IMON}	0	-4
IIN_OC_WARN	A	0	0xFF	107250/R _{IMON}	23.8 × R _{IMON}	0	-4
READ_TEMPERATURE_1	°C	-229.3	0x3FF	501.4	140	32100	-2
READ_TEMP_AVG	°C	-229.3	0x3FF	501.4	140	32100	-2
READ_TEMP_PEAK	°C	-229.3	0x3FF	501.4	140	32100	-2
READ_TEMP_PEAK_EEPROM	°C	-228.7	0xFF	499.8	35	8006	-2
OT_WARN	°C	-228.7	0xFF	499.8	35	8006	-2
OT_FLT	°C	-228.7	0xFF	499.8	35	8006	-2
VAUX	V	0	0x3FF	1.95	5251	0	-1
VAUX_AVG	V	0	0x3FF	1.95	5251	0	-1
READ_PIN	W	0	0x3FF	2091375/R _{IMON}	4.901 × R _{IMON}	0	-4
READ_PIN_PEAK	W	0	0x3FF	2091375/R _{IMON}	4.901 × R _{IMON}	0	-4
READ_PIN_AVG	W	0	0x3FF	2091375/R _{IMON}	4.901 × R _{IMON}	0	-4
PIN_OP_WARN	W	0	0xFF	2091375/R _{IMON}	12.217 × R _{IMON}	0	-5
READ_EIN	J	0	0x7FFF	-	38.22 × R _{IMON}	0	-7
VIREF	V	0.3	0x3F	1.186	7111	-2133	-2
GPDAC1	μA	6	0x3F	53.25	1333	-8000	-3
GPDAC2	V	0.3	0x3F	1.186	7111	-2133	-2
CMP2REF {VCMXREF[7:4]}	V	0.2	0xF	1.7	10000	-2000	-3
CMP1REF {VCMXREF[3:0]}	V	0.2	0xF	1.7	10000	-2000	-3
CABLE_VOLTAGE_DROP	V	0	0xFF	4.845	5263	0	-2
READ_SAMPLE_BUF_VIN	V	0	0xFF	19.42	13128	0	-3
READ_SAMPLE_BUF_VOUT	V	0	0xFF	19.42	13128	0	-3
READ_SAMPLE_BUF_TEMP	°C	-228.7	0xFF	499.8	35	8006	-2
READ_SAMPLE_BUF_VAUX	V	0	0xFF	1.94	13128	0	-2
READ_SAMPLE_BUF_IIN	A	0	0xFF	107250/R _{IMON}	23.8 × R _{IMON}	0	-4

8.3.14.11 Blackbox Fault Recording

The Blackbox feature greatly enhances the ability of the system designer to debug power path related issues during design/development and in case of field returns. Along with a snapshot of the parametric data and event information through various status registers, the TPS25990 provides additional information which helps to re-create the sequence of events as they occurred in a certain interval of time. This information is available in both the on-chip volatile memory and the external I2C EEPROM (connected on the EECLK/EECDATA pins) and can be accessed through PMBus®.

备注

The PMBus® engine is up and running as soon as a stable supply is available on VDD, independent of VIN and other related internal nodes. This ensures that the Blackbox contents can be read back from a field return unit by applying power on VDD pin even if there's damage on VIN side or Power FET.

During the operation of the device, the Blackbox information is stored inside the Blackbox buffer RAM which is seven (7) bytes deep. At any point of time, issuing the [READ_BB_RAM](#) command will retrieve the most recent seven (7) events in a sequence along with the timestamp relative to each other. Each byte of this buffer RAM holds the following information about a single event:

1. A 3-bit event identifier
2. A 5-bit value which indicates the time lapse because the previous event. The lower 4 bits of the timer value represents a snapshot of the free running Blackbox tick timer at the instant of registering the event in the Blackbox RAM. The 5th bit indicates whether the timer has overflowed at least once since the last event.

The event identifier and relative timer information help the system designer to reconstruct a timeline of events as they occurred, thereby enhancing the debug capabilities as compared to viewing a single snapshot of status registers. The Blackbox tick timer is a free running timer which is reset to zero after every event. The timer update rate can be configured through the [BB_CONFIG](#) register. This allows the users to make a tradeoff between fine timing resolution and longer time span as per their debug needs. The [BB_TMR_EXP](#) bit in the [BB_TIMER](#) register indicates if the Blackbox tick timer has overflowed at least since the last event. This bit indicates whether the event entries in the RAM are relatively recent or old. This bit is latched when the timer overflows and reset to zero along with the free running timer when the next event occurs.

Here are the events which will trigger a write to the Blackbox RAM:

1. [VIN_UV_WARN](#)
2. [VIN_OV_WARN](#)
3. [OC_WARN](#)
4. [OT_WARN](#)
5. [OC_DET](#)
6. [VIN_TRAN](#)
7. [IN_OP_WARN](#)

Once the device encounters a global fault or alert event (based on the [ALERT_MASK](#)), the Blackbox RAM contents, along with the status registers, peak input voltage, peak input current, peak device temperature, and Blackbox timer values are written to an external EEPROM through the [EECLK/EEDATA](#) pins.

备注

The EEPROM interface is a standard I2C controller and operates at 400 kHz clock speed. TI recommends using an I2C EEPROM with minimum 1 Kbits of capacity and 16-byte page addressing. Examples of compatible EEPROM devices include 24LC04, 24AA04, etc.

The contents of the Blackbox RAM along with some status registers ([STATUS_WORD](#), [STATUS_MFR_SPECIFIC](#), and [STATUS_INPUT](#)) and certain parameters ([VIN_PEAK](#), [IIN_PEAK](#), and [TEMPERATURE_PEAK](#)) are stored into Page-0 of an external EEPROM when the following conditions are met. At the same time, Blackbox RAM contents and Blackbox tick timer values are locked.

1. An external EEPROM is successfully connected by setting the [EXT_EEPROM](#) bit high in the [DEVICE_CONFIG](#) register. In addition, it is done by configuring two (2) of the four (4) GPIOs as [EECLK](#) and [EEDATA](#) appropriately in the [GPIO_CONFIG_12](#) and [GPIO_CONFIG_34](#) registers. Make sure those two (2) selected GPIO pins are physically connected to the EEPROM clock and data pins respectively on the board.
2. Any one of the three BB EEPROM write trigger bits is set in the [BB_CONFIG](#) register.

Blackbox EEPROM contents:

1. BB_RAM_0 to BB_RAM_6 [Seven (7) bytes]
2. BB_TIMER [One (1) byte]
3. STATUS_WORD [Two (2) bytes]
4. STATUS_MFR_SPECIFIC [One (1) byte]
5. STATUS_INPUT [One (1) byte]
6. VIN_PEAK [One (1) byte, Eight (8) MSBs from the 10-bit ADC output data]
7. IIN_PEAK [One (1) byte, Eight (8) MSBs from the 10-bit ADC output data]
8. TEMPERATURE_PEAK [One (1) byte, Eight (8) MSBs from the 10-bit ADC output data]
9. CHECKSUM [One (1) byte]



图 8-21. Blackbox Operation Example

8.4 Device Functional Modes

The features of the device depend on the operating mode. 表 8-68 summarizes the device functional modes.

表 8-68. Device Functional Modes Based on EN/UVLO Pin

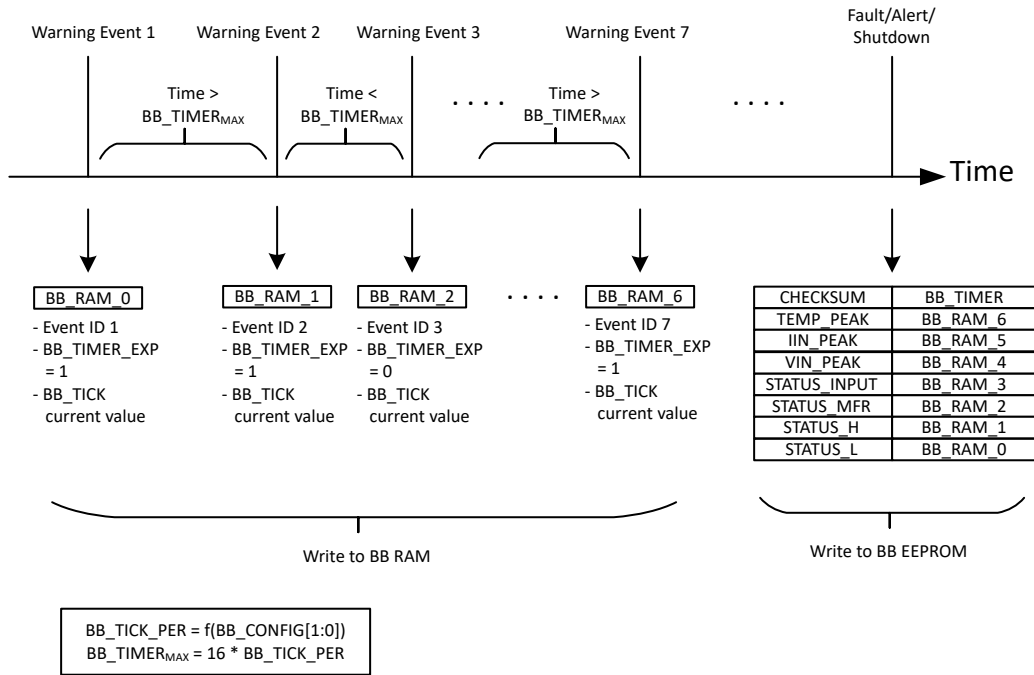
Pin Condition	Device State	Output Discharge
$EN/UVLO > V_{UVLO(R)}$	Fully ON	Disabled
$V_{SD(F)} < EN/UVLO < V_{UVLO(F)}$ (time $< t_{QOD}$)	FET OFF	Disabled
$V_{SD(F)} < EN/UVLO < V_{UVLO(F)}$ (time $> t_{QOD}$)	FET OFF	Enabled
$EN/UVLO < V_{SD(F)}$	Shutdown	Disabled

9 Application and Implementation

备注

Information in the following applications sections is not part of the TI component specification, and TI does not warrant its accuracy or completeness. TI's customers are responsible for determining suitability of components for their purposes, as well as validating and testing their design implementation to confirm system functionality.

9.1 Application Information

The TPS25990 is a high-current eFuse that is typically used for input power rail protection and monitoring applications. The device operates from 2.9 V to 16 V and supports various user adjustable and programmable protection options. The device provides ability to control inrush current and offers protection against overvoltage, overcurrent, short-circuit and overtemperature conditions. The device can be used in a variety of systems such as server motherboards, add-on cards, graphics cards, accelerator cards, enterprise switches, routers, and so forth. The design procedure explained in the subsequent sections can be used to select the supporting component values based on the application requirements. Additionally, a spreadsheet design tool, [TPS25990x Design Calculator](#) is available in the web product folder.

9.1.1 Single Device, Standalone Operation



图 9-1. Single Device, Standalone Operation

9.1.2 Multiple Devices, Parallel Connection

Applications which need higher current input protection along with digital interface for telemetry, control, configurability can use one or more TPS25985 devices in parallel with TPS25990 as shown in [图 9-2](#).

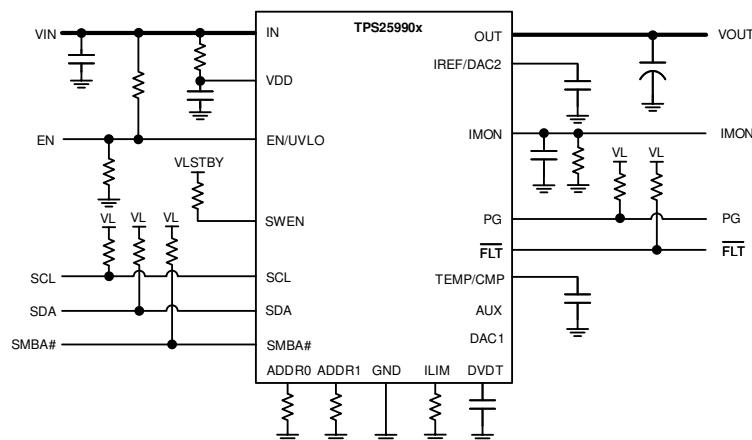

图 9-2. TPS25990 Connected in Parallel with TPS25985x For Higher Current Support With PMBus®

In this configuration, the TPS25990 acts as the primary device and controls the other TPS25985x devices in the chain which are designated as secondary devices. This configuration is achieved by connecting the primary device as follows:

1. VDD is connected to IN through an R-C filter.
2. DVDT is connected through capacitor to GND.
3. IREF is connected through capacitor to GND.
4. IMON is connected through resistor to GND.
5. ILIM is connected through resistor to GND.

SWEN is pulled up to a 3.3-V to 5-V standby rail. This rail must be powered up independent of the eFuse ON/OFF status.

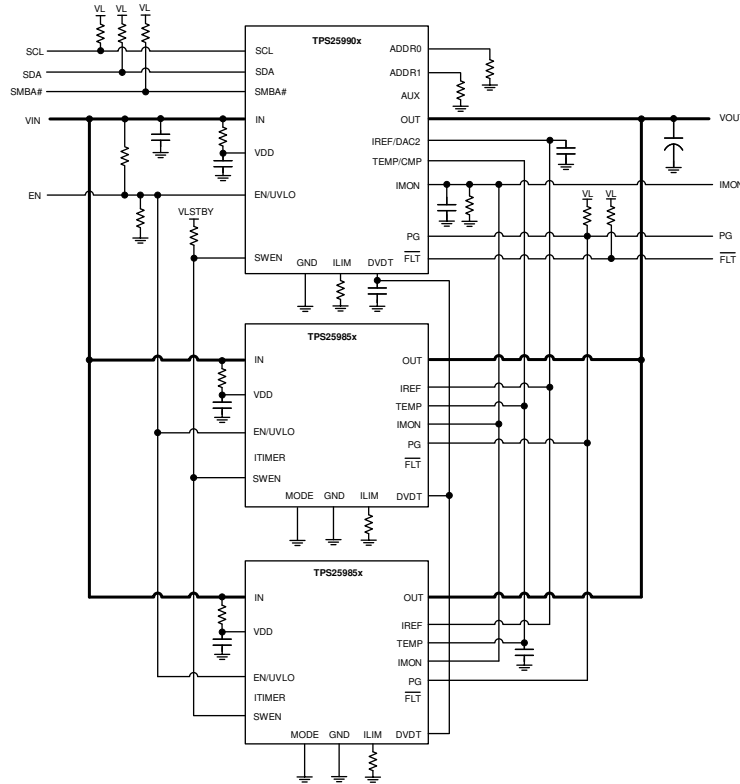
The secondary devices must be connected in the following manner:

1. VDD is connected to IN through a R-C filter.
2. MODE pin is connected to GND.
3. ITIMER pin is left OPEN.
4. ILIM is connected through resistor to GND.

The following pins of all devices must be connected together:

1. IN
2. OUT
3. EN/UVLO
4. DVDT
5. SWEN
6. PGOOD
7. IMON
8. IREF
9. TEMP

In this configuration, all the devices are powered up and enabled simultaneously.

- The TPS25990 monitors the combined VIN, VOUT, IMON, TEMP and reports it over the PMBus® telemetry interface.
- The OVLO threshold is set to max value in all devices by default. For TPS25985x devices, the OV threshold is fixed in hardware and cannot be changed. The TPS25990 OV threshold can be lowered through PMBus® writes to the [VIN_OV_FLT](#) register. In this case, the TPS25990 uses the SWEN pin to turn off the TPS25985x devices during OV conditions.
- The UVLO threshold for all devices is set by the external resistor divider from IN to GND on the EN/UVLO pin. The TPS25990 UV threshold can be changed through PMBus® writes to the [VIN_UV_FLT](#) register. In this case, the TPS25990 uses the SWEN pin to turn off the TPS25985x devices during UV conditions.
- During inrush, the output of all the devices are ramped together based on the DVDT capacitor. However, the TPS25990 DVDT sourcing current can be configured through the PMBus® writes to the [DEVICE_CONFIG\[10:9\]](#) register to change the inrush behavior of the whole chain. The TPS25990 controls the DVDT ramp rate for the whole chain and secondary devices simply follow the ramp rate.
- Due to the inherent difference in $R_{DS(ON)}$, the current carried by the TPS25990 is lower than the TPS25985x devices. Accordingly, the start-up current limit threshold and active current sharing threshold for the TPS25990 has to be set to a relatively lower value as compared to all the TPS25985x devices by connecting a proportionately higher ILIM resistor.
- The TPS25990 controls the overall overcurrent threshold of the parallel chain by setting the [VIREF](#) threshold voltage using its internal DAC. The VIREF voltage can be programmed through PMBus® to change the overcurrent threshold.
- The TPS25990 controls the transient overcurrent blanking interval (t_{OC_TIMER}) for the whole system through PMBus® writes to the [OC_TIMER](#) register. Once the digital timer expires, the TPS25990 pulls the SWEN pin low to signal all devices to break the circuit simultaneously.
- The system Power Good (PGOOD) indication is a combination of all the individual device PGOOD indications. All the devices hold their respective PGOOD pins low till their power FET is fully turned on. Once all devices have reached steady-state, they release their respective PGOOD pin pull-down and the PGOOD signal for the whole chain is asserted high. The TPS25985x secondary devices have control over the system PGOOD assertion only during startup. Once in steady state, only the TPS25990 controls the de-assertion of the PGOOD based on the [VOUT_PGTH](#) register setting.
- The fault indication (\overline{FLT}) for the whole system is provided by TPS25990. However, each secondary device also asserts its own \overline{FLT} independently.

Power up: After power up or enable, all the eFuse devices initially hold their SWEN low till the internal blocks are biased and initialized correctly. After that, each device releases its own SWEN. After all devices have released their SWEN, the combined SWEN goes high and the devices are ready to turn on their respective FETs at the same time.

Inrush: During inrush, because the DVDT pins are tied together to a single DVDT capacitor all the devices turn on the output with the same slew rate (SR). Choose the common DVDT capacitor (C_{DVDT}) as per [方程式 21](#) and [方程式 22](#).

$$SR \left(\frac{V}{ms} \right) = \frac{I_{INRUSH} (mA)}{C_{OUT} (\mu F)} \quad (21)$$

$$C_{dVdt} (pF) = \frac{42000 \times k}{SR \left(\frac{V}{ms} \right)} \quad (22)$$

Refer to [节 8.3.4.1](#) section for more details.

The internal balancing circuits ensure that the load current is shared among all devices during start-up. This action prevents a situation where some devices turn on faster than others and experience more thermal stress as compared to other devices. This can potentially result in premature or partial shutdown of the parallel chain, or even SOA damage to the devices. The current balancing scheme ensures the inrush capability of the chain scales according to the number of devices connected in parallel, thereby ensuring successful start-up with larger

output capacitances or higher loading during start-up. All devices hold their respective PGOOD signals low during start-up. After the output ramps up fully and reaches steady-state, each device releases its own PGOOD pulldown. Because the DVDT pins of all devices are tied together, the internal gate high detection of all devices is synchronized. There can be some threshold or timing mismatches between devices leading to PGOOD assertion in a staggered manner. However, because the PGOOD pins of all devices are tied together, the combined PGOOD signal becomes high only after all devices have released their PGOOD pulldown. This signals the downstream load that it is okay to draw power.

Steady-state: During steady-state, all devices share current nearly equally using the active current sharing mechanism which actively regulates the respective device $R_{DS(ON)}$ to evenly distribute current across all the devices in the parallel chain. Once PGOOD is asserted, de-assertion is controlled only by TPS25990 and based on **VOUT_PGTH** register setting.

备注

The TPS25985x current can be slightly higher as compared to TPS25990 higher owing to its lower on-resistance. This must be fine as long as the steady-state current does not exceed the recommended maximum continuous rating for the device.

Overcurrent during steady-state: The circuit-breaker threshold for the parallel chain is based on the total system current rather than the current flowing through individual devices. This is done by connecting the IMON pins of all the devices together to a single resistor (R_{IMON}) to GND. Similarly, the IREF pins of all devices are tied together and TPS25990 uses internal programmable DAC (**VIREF**) to generate a common reference for the overcurrent protection block in all the devices. This action helps minimize the contribution of V_{IREF} variation to the overall mismatch in overcurrent threshold between devices.

In this case, choose the R_{IMON} as per the following equation:

$$R_{IMON} = \frac{V_{IREF}}{G_{IMON} \times I_{OCP(TOTAL)}} \quad (23)$$

The start-up current limit and active current sharing threshold for each device is set independently using the ILIM pin. The R_{ILIM} value for the TPS25990 must be selected based on the following equation:

$$R_{ILIM(25990)} = \frac{1.1 \times (4N - 1) \times R_{IMON}}{9} \quad (24)$$

The R_{ILIM} value for each TPS25985x must be selected based on the following equation:

$$R_{ILIM(25985)} = \frac{1.1 \times (4N - 1) \times R_{IMON}}{12} \quad (25)$$

Where N = Number of devices in parallel chain ($1 \times$ TPS25990 + $(N - 1) \times$ TPS25985x)

Other variations: The IREF pin can be driven from an external precision voltage reference with low impedance.

During an overcurrent event, the overcurrent detection of all the devices is triggered simultaneously. This in turn triggers the overcurrent blanking timer (**OC_TIMER**) in TPS25990. The TPS25990 uses the OC_TIMER expiry event as a trigger to pull the SWEN low for all the devices, thereby initiating the circuit-breaker action for the whole chain at the same time. This mechanism ensures that mismatches in the current distribution, overcurrent thresholds and OC_TIMER intervals among the devices do not degrade the accuracy of the circuit-breaker threshold of the complete parallel chain or the overcurrent blanking interval. However, the secondary devices also maintain their backup overcurrent timer and can trigger the shutdown of the whole chain if the primary device fails to do so within a certain interval.

Severe overcurrent (short circuit): If there is a severe fault at the output (for example, output shorted to ground with a low impedance path), the current builds up rapidly to a high value and triggers the fast-trip response in each device. The devices use two thresholds for fast-trip protection – a user-adjustable threshold ($I_{SFT} = 2 \times I_{OCP}$ in steady-state or $I_{SFT} = 1.5 \times I_{LIM}$ during inrush) as well as a fixed threshold (I_{FFT} only during steady-state). After the fast-trip, the TPS25990 relies on the SC_RETRY configuration bit setting in the

DEVICE_CONFIG register to determine if the whole chain enters a latched fault or performs a fast recovery by restarting in current limit manner. If it enters a latched fault, the devices remain latched off till the device is power cycled or re-enabled, or auto-retry after a delay based on the **RETRY_CONFIG** register setting.

9.1.3 Multiple Devices, Independent Operation (Multi-zone)

Systems which need power from a common source to be distributed to different power zones can use multiple TPS25990 devices connected as shown in [图 9-3](#) to provide independent monitoring and protection for each zone.



图 9-3. Multiple TPS25990 Devices Delivering Power to Different Zones in a System

In this configuration, the following pins of each device are tied to the respective pins on the other devices.

1. IN
2. EN/UVLO
3. SCL
4. SDA
5. SMBA#

备注

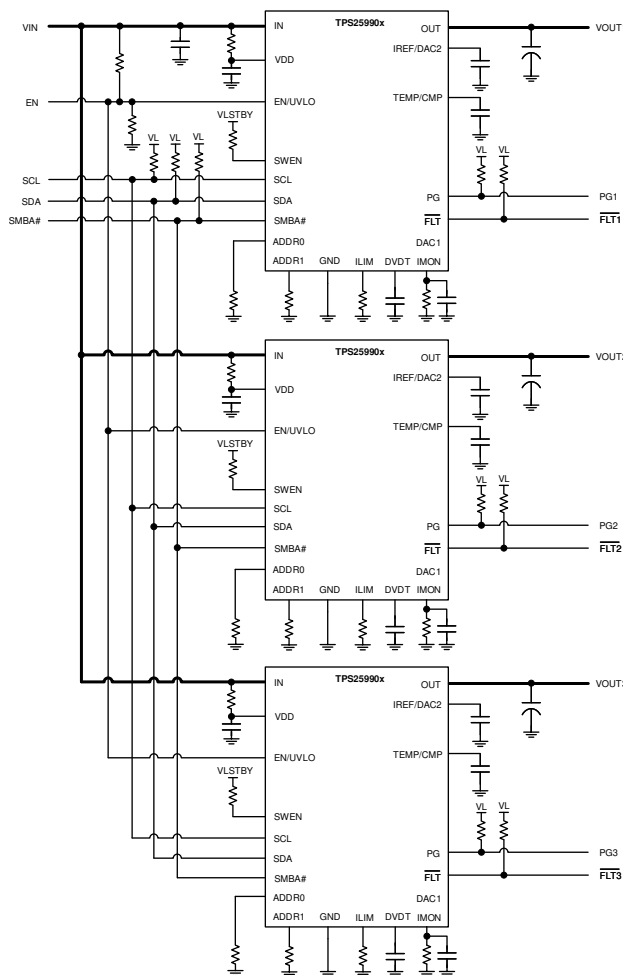
The EN/UVLO pins can be separated if each zone needs to have a different hardware control signal or UVLO threshold.

In this configuration, all the devices are monitored and controlled independently through the PMBus®. Because the devices share the same bus, they must have different device addresses, which can be set using different pin-strapping combinations on the ADDR0 and ADDR1 pins.

9.2 Typical Application: 12-V, 4-kW Power Path Protection with PMBus® Interface in Datacenter Servers

This design example considers a 12 V system operating voltage with a tolerance of ±10%. The maximum steady-state load current is 333 A. If the load current exceeds 367 A, the eFuse circuit must allow transient overload currents up to a 10 ms interval. For persistent overloads lasting longer than that, the eFuse circuit must break the circuit and then latch-off. The eFuse circuit must charge a bulk capacitance of 50 mF and support approximately 7.5% of the steady-state load during start-up. 图 9-4 shows the application schematic for this design example.



图 9-4. Application Schematic for a 12-V, 4-kW Power Path Protection Circuit with PMBus® Interface

9.2.1 Design Requirements

表 9-1 shows the design parameters for this application example.

表 9-1. Design Parameters

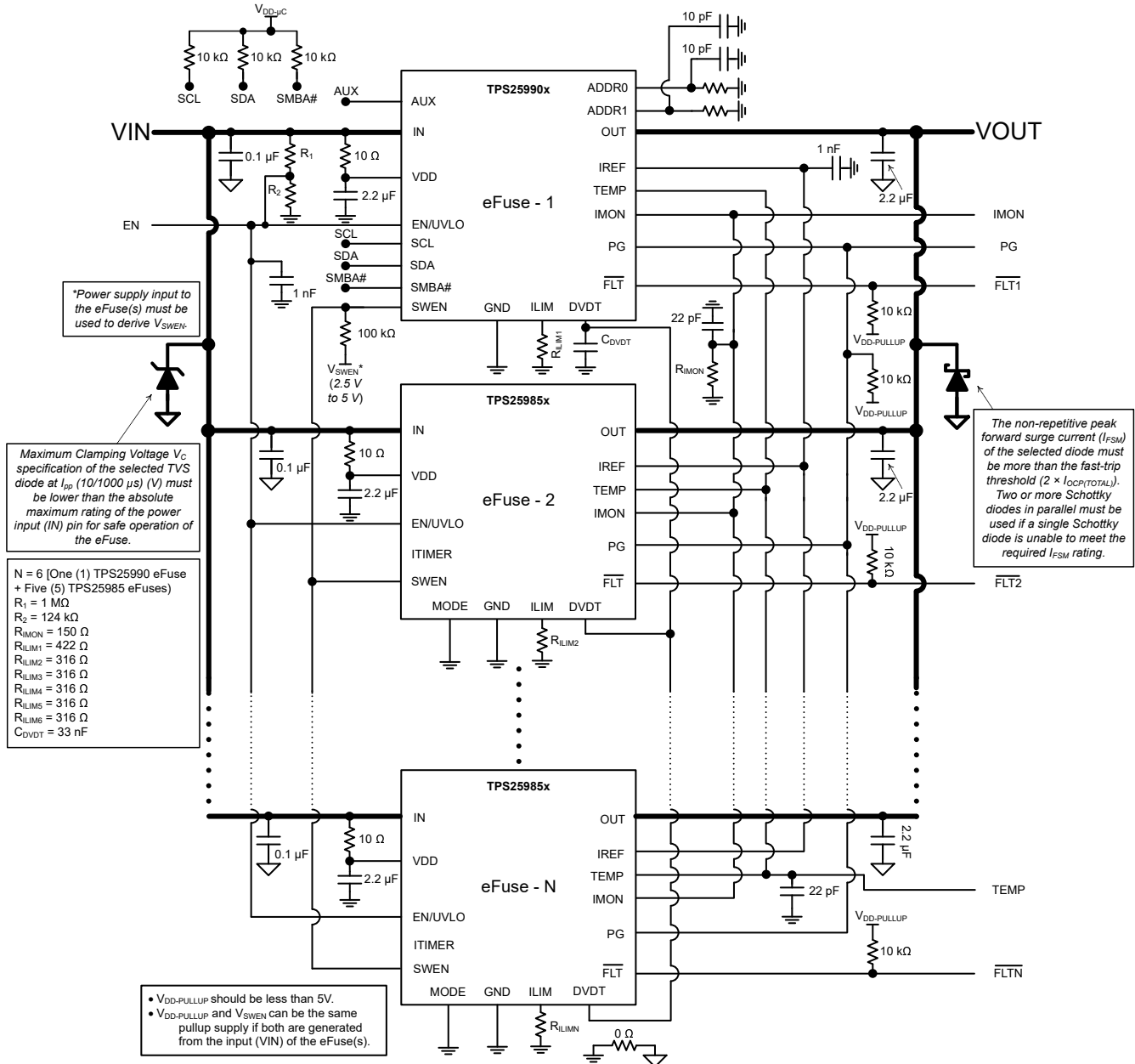
PARAMETER	VALUE
Input voltage range (V_{IN})	10.8 V - 13.2 V
Maximum DC load current ($I_{OUT(max)}$)	333 A
Maximum output capacitance (C_{LOAD})	50 mF
Are all the loads off until the PG is asserted?	No
Load at start-up ($R_{LOAD(Startup)}$)	0.48 Ω (equivalent to approximately 7.5% of the maximum steady-state load)
Maximum ambient temperature	55°C
Transient overload blanking timer	10 ms
Output voltage slew rate	1.2 V/ms
Need to survive a “hot-short” on output condition?	Yes
Need to survive a “power up into short” condition?	Yes
Can the board be hotplugged in or power cycled?	Yes
Load current monitoring needed?	Yes
Need PMBus® interface for telemetry, control, and configurability?	Yes
Fault response	Latch-off

9.2.2 Detailed Design Procedure

- **Determining the number of eFuse devices to be used in parallel**

As the design must have PMBus® functionality or interface for telemetry, control, and configuration, the TPS25990 eFuse must be used as a primary device in parallel with TPS25985x eFuse(s) as secondary devices in order to support the required steady-state thermal design current. By factoring in a small variation in the junction to ambient thermal resistance ($R_{\theta JA}$), each TPS25990 eFuse and TPS25985x eFuse is rated at maximum RMS currents of 50 A and 60 A respectively with a maximum junction temperature of 125 °C. Therefore, 方程式 26 can be used to calculate the number of TPS25985x eFuses (N-1) to be in parallel with a TPS25990 eFuse to support the maximum steady state DC load current ($I_{LOAD(max)}$), for which the solution must be designed.

$$(N - 1) \geq \frac{(I_{OUT(max)} - 50)}{60} \quad (26)$$

According to 表 9-1, $I_{OUT(max)}$ is 333 A. Therefore, one (1) TPS25990 and five (5) TPS25985x eFuses are connected in parallel to support the desired steady-state load current.

- **Setting up the primary and secondary devices in a parallel combination of TPS25990 and TPS25985x eFuses**

The TPS25990 functions as a primary device by default. By connecting the MODE pin of all the TPS25985x eFuses to GND, they are configured as secondary devices.

- **Selecting the C_{DVRT} capacitor to control the output slew rate and start-up time**

For a robust design, the junction temperature of the device must be kept below the absolute maximum rating during both dynamic (start-up) and steady-state conditions. Typically, dynamic power stresses are orders of

magnitude greater than static stresses, so it is crucial to establish the right start-up time and inrush current limit for the capacitance in the system and the associated loads to avoid thermal shutdown during start-up.

表 9-2 summarizes the formulas for calculating the average inrush power loss on the eFuses in the presence of different loads during start-up if the power good (PG) signal is not used to turn on all the downstream loads.

表 9-2. Calculation of Average Power Loss During Inrush

Type of Loads During Start-Up	Expressions to Calculate the Average Inrush Power Loss
Only output capacitor of C_{LOAD} (μF)	$\frac{V_{IN}^2 C_{LOAD}}{2T_{SS}} \quad (27)$
Output capacitor of C_{LOAD} (μF) and constant resistance of $R_{LOAD(Startup)}$ (Ω) with turn-ON threshold of V_{RTH} (V)	$\frac{V_{IN}^2 C_{LOAD}}{2T_{SS}} + \frac{V_{IN}^2}{R_{LOAD(Startup)}} \left[\frac{1}{6} - \left\{ \frac{1}{2} \left(\frac{V_{RTH}}{V_{IN}} \right)^2 \right\} + \left\{ \frac{1}{3} \left(\frac{V_{RTH}}{V_{IN}} \right)^3 \right\} \right] \quad (28)$
Output capacitor of C_{LOAD} (μF) and constant current of $I_{LOAD(Startup)}$ (A) with turn-ON threshold of V_{CTH} (V)	$\frac{V_{IN}^2 C_{LOAD}}{2T_{SS}} + V_{IN} I_{LOAD(Startup)} \left[\frac{1}{2} - \left(\frac{V_{CTH}}{V_{IN}} \right) + \left\{ \frac{1}{2} \left(\frac{V_{CTH}}{V_{IN}} \right)^2 \right\} \right] \quad (29)$
Output capacitor of C_{LOAD} (μF) and constant power of $P_{LOAD(Startup)}$ (W) with turn-ON threshold of V_{PTH} (V)	$\frac{V_{IN}^2 C_{LOAD}}{2T_{SS}} + P_{LOAD(Startup)} \left[\ln \left(\frac{V_{PTH}}{V_{IN}} \right) + \left(\frac{V_{PTH}}{V_{IN}} \right) - 1 \right] \quad (30)$

Where V_{IN} is the input voltage and T_{SS} is the start-up time.

With the different combinations of loads during start-up, the total average inrush power loss (P_{INRUSH}) can be calculated using the formulas described in 表 9-2. For a successful start-up, the system must satisfy the condition stated in 方程式 31.

$$P_{INRUSH}(W) \sqrt{T_{SS}(s)} < \{8 + 12(N - 1)\} \quad (31)$$

Where N denotes the total number of eFuses in parallel and $8 \text{ W} \sqrt{s}$ and $12 \text{ W} \sqrt{s}$ are the safe operating area (SOA) limits of a TPS25990 eFuse and a TPS25985x eFuse respectively. This equation can be used to obtain the maximum allowed T_{SS} .

备注

TI recommends to use a T_{SS} in the range of 5 ms to 120 ms to prevent start-up issues.

A capacitor (C_{DVDT}) must be added at the TPS25990 DVDT pin to GND to set the required value of T_{SS} as calculated above. 方程式 32 is used to compute the value of C_{DVDT} . The DVDT pins of all the eFuses in a parallel chain must be connected together.

$$C_{DVDT}(pF) = \frac{42000 \times k}{V_{IN}(V)/T_{SS}(ms)} \quad (32)$$

Refer to 节 8.3.4.1 section for more details. In this design example, $C_{LOAD} = 50 \text{ mF}$, $R_{LOAD(Startup)} = 0.48 \Omega$, $V_{RTH} = 0 \text{ V}$, $V_{IN} = 12 \text{ V}$, and $T_{SS} = 10 \text{ ms}$. P_{INRUSH} is calculated to be 410 W using the equations provided in the 表 9-2. It is verified that the system satisfies the condition stated in 方程式 31 and therefore capable of having a successful start-up. If 方程式 31 does not hold true, start-up loads or T_{SS} must be tuned to prevent the chances of thermal shutdown during start-up. Using $V_{IN} = 12 \text{ V}$, $T_{SS} = 10 \text{ ms}$, $k = 1$, and 方程式 32, the required C_{DVDT} value can be calculated to be 35 nF . The closest standard value of C_{DVDT} is 33 nF with 10% tolerance and DC voltage rating of 25 V .

备注

In some systems, there can be active load circuits (for example, DC-DC converters) with low turn-on threshold voltages which can start drawing power before the eFuse has completed the inrush sequence. This action can cause additional power dissipation inside the eFuse during start-up and can lead to thermal shutdown. TI recommends using the Power Good (PG) pin of the eFuse to enable and disable the load circuit. This action ensures that the load is turned on only when the eFuse has completed its start-up and is ready to deliver full power without the risk of hitting thermal shutdown.

• **Selecting the V_{IREF} to set the reference voltage for overcurrent protection and active current sharing**

The reference voltage (V_{IREF}) for overcurrent protection and active current sharing will be at 1 V by default. However, it can be programmed via PMBus® using the [VIREF](#) register if another reference voltage is needed in the range of 0.3 V to 1.2 V. When the voltage at the IMON pin (V_{IMON}) is used as an input to an ADC to monitor the system current or to implement the Platform Power Control (Intel PSYS) functionality inside the VR controller, V_{IREF} must be set to half of the maximum voltage range of the ISYS_IN input of the controller. This action provides the necessary headroom and dynamic range for the system to accurately monitor the load current up to the fast-trip threshold ($2 \times I_{OCP(TOTAL)}$). For improved noise immunity, place a 1 nF ceramic capacitor from the IREF pin to GND.

备注

Maintain V_{IREF} within the recommended voltage to ensure proper operation of overcurrent detection circuit.

• **Selecting the R_{IMON} resistor to set the overcurrent (circuit-breaker) and fast-trip thresholds during steady-state**

TPS25990 eFuse responds to the output overcurrent conditions during steady-state by turning off the output after a user-adjustable transient fault blanking interval. This eFuse continuously senses the total system current (I_{OUT}) and produces a proportional analog current output (I_{IMON}) on the IMON pin. This generates a voltage (V_{IMON}) across the IMON pin resistor (R_{IMON}) in response to the load current, which is defined as [方程式 33](#).

$$V_{IMON} = I_{OUT} \times G_{IMON} \times R_{IMON} \tag{33}$$

G_{IMON} is the current monitor gain ($I_{IMON} : I_{OUT}$), whose typical value is 18.18 $\mu\text{A}/\text{A}$. The overcurrent condition is detected by comparing the V_{IMON} against the V_{IREF} as a threshold. The circuit-breaker threshold during steady-state ($I_{OCP(TOTAL)}$) can be calculated using [方程式 34](#).

$$I_{OCP(TOTAL)} = \frac{V_{IREF}}{G_{IMON} \times R_{IMON}} \tag{34}$$

In this design example, $I_{OCP(TOTAL)}$ is considered to be around 1.1 times $I_{OUT(max)}$. Hence, $I_{OCP(TOTAL)}$ is required to be set at 367 A, and R_{IMON} can be calculated to be 150 Ω with G_{IMON} as 18.18 $\mu\text{A}/\text{A}$ and V_{IREF} as 1 V. The value of R_{IMON} is 150 Ω with 0.1% tolerance and power rating of 100 mW. This results in a circuit-breaker threshold of 367 A. For noise immunity, place a 22 pF ceramic capacitor from the IMON pin to GND.

备注

The total system output current (I_{OUT}) must be considered when selecting R_{IMON} , not the current carried by each individual device.

• **Selecting the R_{ILIM} resistor to set the current limit and fast-trip thresholds during start-up and the active sharing threshold during steady-state**

R_{ILIM} is used in setting up the active current sharing threshold during steady-state and the overcurrent limit during startup among the devices in a parallel chain. Each device continuously monitors the current flowing

through it (I_{DEVICE}) and outputs a proportional analog output current on its own ILIM pin. This in turn produces a proportional voltage (V_{ILIM}) across the respective ILIM pin resistor (R_{ILIM}), which is expressed as [方程式 35](#).

$$V_{ILIM} = I_{DEVICE} \times G_{ILIM} \times R_{ILIM} \quad (35)$$

G_{ILIM} is the current monitor gain ($I_{ILIM} : I_{DEVICE}$), whose typical value is 18.18 μ A/A.

- **Active current sharing during steady-state:** This mechanism operates only after the device reaches steady-state and acts independently by comparing its own load current information (V_{ILIM}) with the Active Current Sharing reference ($CLREF_{LIN}$) threshold, defined as [方程式 36](#).

$$CLREF_{LIN} = \frac{1.1 \times V_{IREF}}{3} \quad (36)$$

The typical values of R_{DSON} for TPS25990 and TPS25985x eFuses are 0.79 m Ω and 0.59 m Ω respectively. Therefore, when one (1) TPS25990 eFuse and one (1) TPS25985x eFuse are in parallel, it is expected that the TPS25990 eFuse will carry 0.75 times the current flowing through the TPS25985x eFuse in steady-state. Therefore, $R_{LIM(TPS25990)}$ must be calculated using [方程式 37](#) to define the active current sharing threshold as $3 \times I_{OCP(TOTAL)} / (4N - 1)$ for TPS25990 eFuse, where N is the total number of devices in parallel ($1 \times$ TPS25990 + $(N - 1) \times$ TPS25985x). Whereas, [方程式 38](#) needs to be followed to obtain the value of $R_{LIM(TPS25985)}$ in setting up the active current sharing threshold as $4 \times I_{OCP(TOTAL)} / (4N - 1)$ for each TPS25985x eFuse. Using $N = 6$, $R_{IMON} = 150 \Omega$, and [方程式 37](#), $R_{ILIM(TPS25990)}$ can be calculated to be 421.6 Ω . The closest standard value of 422 Ω with 0.1% tolerance and power rating of 100 mW resistance is selected as $R_{ILIM(TPS25990)}$ for TPS25990 eFuse. Using [方程式 38](#), $R_{ILIM(TPS25985)}$ is obtained as 316.2 Ω . The closest standard value of 316 Ω with 0.1% tolerance and power rating of 100 mW resistances are selected as $R_{ILIM(TPS25985)}$ for five (5) TPS25985x eFuses.

$$R_{ILIM(TPS25990)} = \frac{1.1 \times (4N - 1) \times R_{IMON}}{9} \quad (37)$$

$$R_{ILIM(TPS25985)} = \frac{1.1 \times (4N - 1) \times R_{IMON}}{12} \quad (38)$$

备注

To determine the value of R_{ILIM} , [方程式 39](#) must be used if a different threshold for active current sharing ($I_{LIM(ACS)}$) is desired.

$$R_{ILIM} = \frac{1.1 \times V_{IREF}}{3 \times G_{ILIM} \times I_{LIM(ACS)}} \quad (39)$$

When computing the current limit threshold during start-up in the next sub-section, ensure to use this R_{ILIM} value.

- **Overcurrent limit during start-up:** During inrush, the overcurrent condition for each device is detected by comparing its own load current information (V_{ILIM}) with a scaled reference voltage as depicted in [方程式 40](#).

$$CLREF_{SAT} = \frac{0.7 \times V_{IREF}}{3} \quad (40)$$

The current limit threshold during start-up can be calculated using [方程式 41](#).

$$I_{ILIM(Startup)} = \frac{CLREF_{SAT}}{G_{ILIM} \times R_{ILIM}} \quad (41)$$

By using a $R_{ILIM(TPS25990)}$ value of 422 Ω , the start-up current is limited to 30 A for TPS25990 with V_{IREF} of 1 V. Whereas, the start-up current is limited to 40 A for TPS25985x with V_{IREF} of 1 V using a $R_{ILIM(TPS25985)}$ value of 316 Ω . Hence, the total start-up current limit becomes ~230 A for this design example.

备注

The active current limit block employs a foldback mechanism during start-up based on V_{OUT} . When V_{OUT} is below the foldback threshold (V_{FB}) of 2 V, the current limit threshold is further lowered.

- **Selecting the overcurrent blanking timer duration (t_{OC_TIMER})**

The overcurrent blanking timer duration (t_{OC_TIMER}) for the entire parallel chain is controlled by TPS25990 and is set to 2.18 ms by default. However, it can be programmed via PMBus® using the OC_TIMER (E6h) register to a different value in the range of 0 ms to 27.8 ms in 100 μ s steps. The ITIMER pin for all the secondary TPS25985x devices must be left open.

- **Selecting the resistors to set the undervoltage lockout threshold**

The undervoltage lockout (UVLO) threshold is adjusted by employing the external voltage divider network of R_1 and R_2 connected between IN, EN/UVLO, and GND pins of the device as described in [Undervoltage protection](#) section. The resistor values required for setting up the UVLO threshold are calculated using [方程式 42](#).

$$V_{IN(UV)} = V_{UVLO(R)} \frac{R_1 + R_2}{R_2} \quad (42)$$

To minimize the input current drawn from the power supply, TI recommends using higher resistance values for R_1 and R_2 . The current drawn by R_1 and R_2 from the power supply is $I_{R12} = V_{IN} / (R_1 + R_2)$. However, the leakage currents due to external active components connected to the resistor string can add errors to these calculations. So, the resistor string current, I_{R12} must be 20 times greater than the leakage current at the EN/UVLO pin (I_{ENLKG}). From the device electrical specifications, I_{ENLKG} is 0.1 μ A (maximum) and UVLO rising threshold $V_{UVLO(R)} = 1.2$ V. From the design requirements, $V_{INUVLO} = 10.8$ V. First choose the value of $R_1 = 1$ M Ω and use Equation 13 to calculate $R_2 = 125$ k Ω . Use the closest standard 1% resistor values: $R_1 = 1$ M Ω and $R_2 = 124$ k Ω . For noise reduction, place a 1 nF ceramic capacitor across the EN/UVLO pin and GND.

- **Selecting the R-C filter between VIN and VDD for TPS25990 and TPS25985x**

VDD pin is intended to power the internal control circuitry of the eFuse with a filtered and stable supply, not affected by system transients. Therefore, use an R (10 Ω) - C (2.2 μ F) filter from the input supply (IN pin) to the VDD pin. This helps to filter out the supply noises and to hold up the controller supply during severe faults such as short-circuit at the output. In a parallel chain, this R-C filter must be employed for each device.

- **Selecting the pullup resistors and power supplies for SWEN, PG and \overline{FLT} pins**

\overline{FLT} , PG, and CMPOUT are open drain outputs. If these logic signals are used, the corresponding pins must be pulled up to the appropriate voltages (< 5 V) through 10 k Ω pull-up resistances.

备注

- SWEN pin must be pulled up to a voltage in the range of 2.5 V to 5 V through a 100-k Ω resistance. This pullup power supply must be generated from the input to the eFuse and available before the eFuse is enabled as discussed in [节 9.3](#), without which the eFuse does not start up.
- There can be some threshold or timing mismatches between devices leading to PG assertion in a staggered manner. Therefore, it is advisable to connect the PG pins of all the devices in parallel. This will ensure that the combined PG signal becomes high only after all devices have released their PG pulldowns.

- **Selecting the pullup resistors for PMBus® SCL, SDA, and SMBA# lines**

The SCL, SDA, and SMBA# lines can be pulled up to potentials less than 5 V in general with pull-up resistors of 10 k Ω . However, to obtain the appropriate values of these pull-up resistors in accordance with the system specifications, please refer to [I2C Bus Pullup Resistor Calculation](#).

- **Configuring the PMBus® target device address**

Place appropriate resistors across ADDR0 and ADDR1 to GND or leave these pins floating or connect them to GND as described in [节 8.3.14.1](#) to set the preferred device address. To improve the noise immunity for correct address decoding, connect 10 pF ceramic capacitors in parallel with the resistors on ADDR0 and ADDR1.

- **Selection of TVS diode at input and Schottky diode at output**

In the case of a short circuit and overload current limit when the device interrupts a large amount of current instantaneously, the input inductance generates a positive voltage spike on the input, whereas the output inductance creates a negative voltage spike on the output. The peak amplitudes of these voltage spikes (transients) are dependent on the value of inductance in series with the input or output of the device. Such transients can exceed the absolute maximum ratings of the device and eventually lead to failures due to electrical overstress (EOS) if appropriate steps are not taken to address this issue. Typical methods for addressing this issue include:

1. Minimize lead length and inductance into and out of the device.
2. Use a large PCB GND plane.
3. Addition of the Transient Voltage Suppressor (TVS) diodes to clamp the positive transient spike at the input.
4. Using Schottky diodes across the output to absorb negative spikes.

Refer to [TVS Clamping in Hot-Swap Circuits](#) and [Selecting TVS Diodes in Hot-Swap and ORing Applications](#) for details on selecting an appropriate TVS diode and the number of TVS diodes to be in parallel to effectively clamp the positive transients at the input below the absolute maximum ratings of the IN pin (20 V). These TVS diodes also help to limit the transient voltage at the IN pin during the Hot Plug event. Four (4) SMDJ12A are used in parallel in this design example.

备注

Maximum Clamping Voltage V_C specification of the selected TVS diode at I_{pp} (10/1000 μ s) (V) must be lower than the absolute maximum rating of the power input (IN) pin for safe operation of the eFuse.

Selection of the Schottky diodes must be based on the following criteria:

- The non-repetitive peak forward surge current (I_{FSM}) of the selected diode must be more than the fast-trip threshold ($2 \times I_{OCP(TOTAL)}$). Two or more Schottky diodes in parallel must be used if a single Schottky diode is unable to meet the required I_{FSM} rating. [方程式 43](#) calculates the number of Schottky diodes ($N_{Schottky}$) that must be used in parallel.

$$N_{Schottky} > \frac{2 \times I_{OCP(TOTAL)}}{I_{FSM}} \quad (43)$$

- Forward Voltage Drop (V_F) at near to I_{FSM} must be as small as possible. Ideally, the negative transient voltage at the OUT pin must be clamped within the absolute maximum rating of the OUT pin (-1 V).
- DC Blocking Voltage (V_{RM}) must be more than the maximum input operating voltage.
- Leakage current (I_R) must be as small as possible.

Three (3) SBR10U45SP5 are used in parallel in this design example.

- **Selecting C_{IN} and C_{OUT}**

TI recommends to add ceramic bypass capacitors to help stabilize the voltages on the input and output. The value of C_{IN} must be kept small to minimize the current spike during hot-plug events. For each device, 0.1 μ F

of C_{IN} is a reasonable target. Because C_{OUT} does not get charged during hot-plug, a larger value such as 2.2 μF can be used at the OUT pin of each device.

9.2.3 Application Performance Plots

All the waveforms below are captured on an evaluation setup with one (1) TPS25990 eFuse and five (5) TPS25985x eFuses in parallel. All the pullup supplies are derived from a separate standby rail.



图 9-5. Input Hot Plug: V_{IN} Stepped Up from 0 V to 12 V, $C_{LOAD} = 50$ mF, $R_{LOAD(Start-up)} = 0.48$ Ω , $C_{DVDT} = 33$ nF, $V_{IREF} = 1$ V, $R_{ILIM(TPS25990)} = 422$ Ω , and $R_{ILIM(TPS25985)} = 316$ Ω



图 9-6. Start-up with EN/UVLO: $V_{IN} = 12$ V, EN/UVLO Stepped Up From 0 V to 3 V, $C_{LOAD} = 50$ mF, $R_{LOAD(Start-up)} = 0.48$ Ω , $C_{DVDT} = 33$ nF, $V_{IREF} = 1$ V, $R_{ILIM(TPS25990)} = 422$ Ω , and $R_{ILIM(TPS25985)} = 316$ Ω



图 9-7. Power Up into Short: $V_{IN} = 12$ V, EN/UVLO Stepped Up From 0 V to 3 V, $V_{IREF} = 1$ V, $R_{ILIM(TPS25990)} = 422$ Ω , $R_{ILIM(TPS25985)} = 316$ Ω , and OUT Shorted to GND



图 9-8. Power Up into Short (Current distribution among six devices in parallel): $V_{IN} = 12$ V, EN/UVLO Stepped Up From 0 V to 3 V, $V_{IREF} = 1$ V, $R_{ILIM(TPS25990)} = 422$ Ω , $R_{ILIM(TPS25985)} = 316$ Ω , and OUT Shorted to GND



图 9-9. Transient Overload: $V_{IN} = 12$ V, $t_{OC_TIMER} = 10$ ms, $C_{LOAD} = 50$ mF, $R_{IMON} = 150$ Ω , $V_{IREF} = 1$ V, and Load Current Stepped from 333 A to 500 A then 333 A within 8.5 ms



图 9-10. Transient Overload (Current distribution among six devices in parallel): $V_{IN} = 12$ V, $t_{OC_TIMER} = 10$ ms, $C_{LOAD} = 50$ mF, $R_{IMON} = 150$ Ω , $V_{IREF} = 1$ V, and Load Current Stepped from 333 A to 500 A then 333 A within 8.5 ms

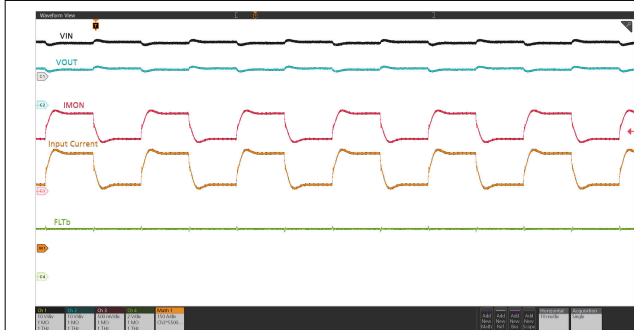

图 9-11. Circuit-Breaker Response: $V_{IN} = 12\text{ V}$, $t_{OC_TIMER} = 10\text{ ms}$, $C_{LOAD} = 50\text{ mF}$, $R_{IMON} = 150\ \Omega$, $V_{IREF} = 1\text{ V}$, and Load Current Stepped from 333 A to 530 A for more than 10 ms

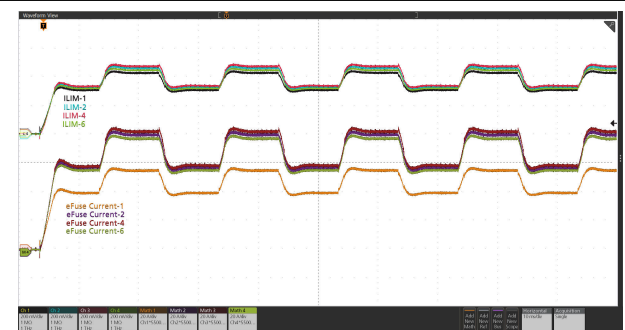

图 9-12. Circuit-Breaker Response (Current distribution among six devices in parallel): $V_{IN} = 12\text{ V}$, $t_{OC_TIMER} = 17\text{ ms}$, $C_{LOAD} = 50\text{ mF}$, $R_{IMON} = 150\ \Omega$, $V_{IREF} = 1\text{ V}$, and Load Current Stepped from 333 A to 530 A for more than 17 ms

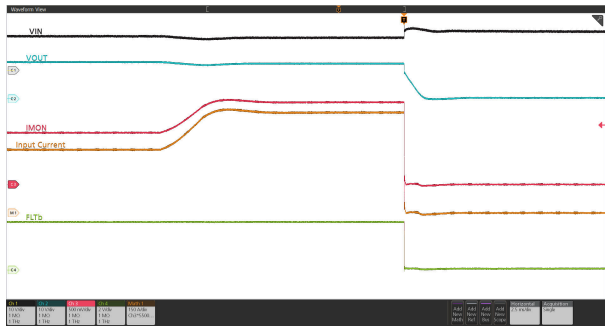

图 9-13. Output Hot-Short Response: $V_{IN} = 12\text{ V}$, $R_{IMON} = 150\ \Omega$, $V_{IREF} = 1\text{ V}$, and OUT Shorted to GND

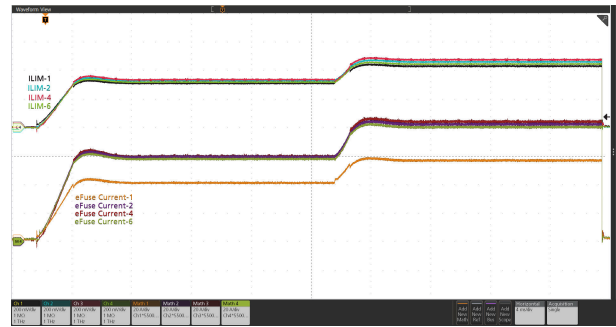

图 9-14. One (1) TPS25990 eFuse and one (1) TPS25985x eFuse in Parallel: Temperature Rise with 110-A DC Current at Room Temperature (No Air-Flow)

9.3 Best Design Practices

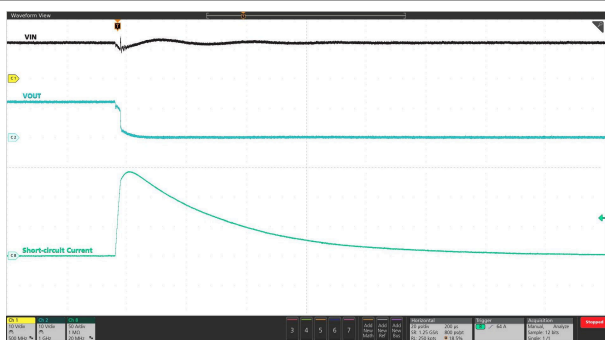
TPS25990 needs the SWEN pin to be pulled up to a supply rail which is powered up before the device is enabled. Failing this, the device is not able to turn on the output. The SWEN pullup supply must not be derived from the output of the eFuse. Use one of the following options to derive the pullup supply rail for SWEN.

1. Use an existing standby rail in the system, which is derived from the main power input and comes up before the eFuse is turned on.
2. Use an LDO (3.3 V or 5 V) powered from the main power input.

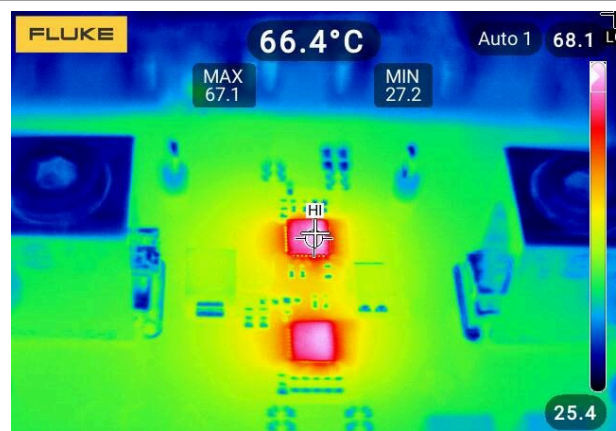

图 9-15. LDO Used as Pullup Supply for SWEN

3. Use a Zener regular powered from the main power input.

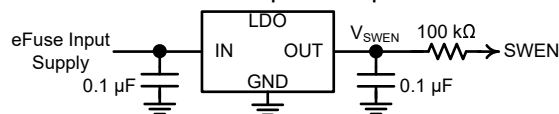

图 9-16. Zener Regulator Used as Pullup Supply for SWEN

4. Use the ITIMER pin of one of the secondary eFuses (TPS25985x). Ensure the ITIMER pin does not have excess loading which can interfere with the normal overcurrent blanking timer functionality.

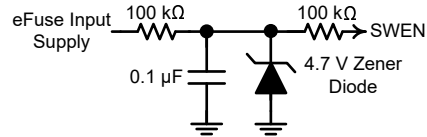

图 9-17. ITIMER Pin Used as Pullup Supply for SWEN

The ground connections for the various components around the TPS25990 & TPS25985 must be wired directly to each other and the GND pins of respective eFuses. This must be followed by connecting them to the system ground at one point. For more details, refer to [TPS25990EVM eFuse Evaluation Board](#). Do not connect the various component grounds through the high current system ground line.

9.4 Power Supply Recommendations

The TPS25990 devices are designed for a supply voltage in the range of 2.9 V to 16 V on the IN pin and 4.5 V to 16 V on the VDD pin. TI recommends using a minimum capacitance of 0.1 μ F on the IN pin of each device in parallel chain to avoid coupling of high slew rates during hot plug events. TI also recommends using an R-C filter from the IN supply to the VDD pin to filter out supply noise and to hold up the controller supply during severe faults such as short-circuit.

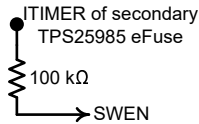
备注

1. If in-system programming of configuration register non-volatile memory is needed, then TI recommends using a minimum supply of 10 V on VDD.
2. The device can be used with VIN voltage rails down to 2.9 V as long as the VDD rail is supplied with an independent bias voltage of 4.5 V or higher.

9.4.1 Transient Protection

In the case of a short-circuit or circuit-breaker event, when the device interrupts current flow, the input inductance generates a positive voltage spike on the input, and the output inductance generates a negative voltage spike on the output. The peak amplitude of voltage spikes (transients) is dependent on the value of inductance in series to the input or output of the device. Such transients can exceed the absolute maximum ratings of the device if steps are not taken to address the issue. Typical methods for addressing transients include:

- Minimize lead length and inductance into and out of the device.
- Use a large PCB GND plane.
- Connect a Schottky diode from the OUT pin ground to absorb negative spikes.
- Connect a low ESR capacitor of 2.2 μ F or higher at the OUT pin very close to the device.
- Connect a ceramic capacitor $C_{IN} = 0.1 \mu$ F or higher at the IN pin very close to the device to dampen the rise time of input transients. The capacitor voltage rating must be at least twice the input supply voltage to be able to withstand the positive voltage excursion during inductive ringing.

The approximate value of input capacitance can be estimated with [方程式 44](#).

$$V_{SPIKE(Absolute)} = V_{IN} + I_{LOAD} \times \sqrt{\frac{L_{IN}}{C_{IN}}} \quad (44)$$

V_{IN} is the nominal supply voltage.

I_{LOAD} is the load current.

L_{IN} equals the effective inductance seen looking into the source.

C_{IN} is the capacitance present at the input.

- Some applications can require the addition of a Transient Voltage Suppressor (TVS) to prevent transients from exceeding the absolute maximum ratings of the device. In some cases, even if the maximum amplitude of the transients is below the absolute maximum rating of the device, a TVS can help to absorb the excessive energy dump and prevent it from creating very fast transient voltages on the input supply pin of the IC, which can couple to the internal control circuits and cause unexpected behavior.

The circuit implementation with optional protection components is shown in [图 9-18](#).



图 9-18. Circuit Implementation with Optional Protection Components

9.4.2 Output Short-Circuit Measurements

It is difficult to obtain repeatable and similar short-circuit testing results. The following contribute to variation in results:

- Source bypassing
- Input leads
- Circuit layout
- Component selection
- Output shorting method
- Relative location of the short
- Instrumentation

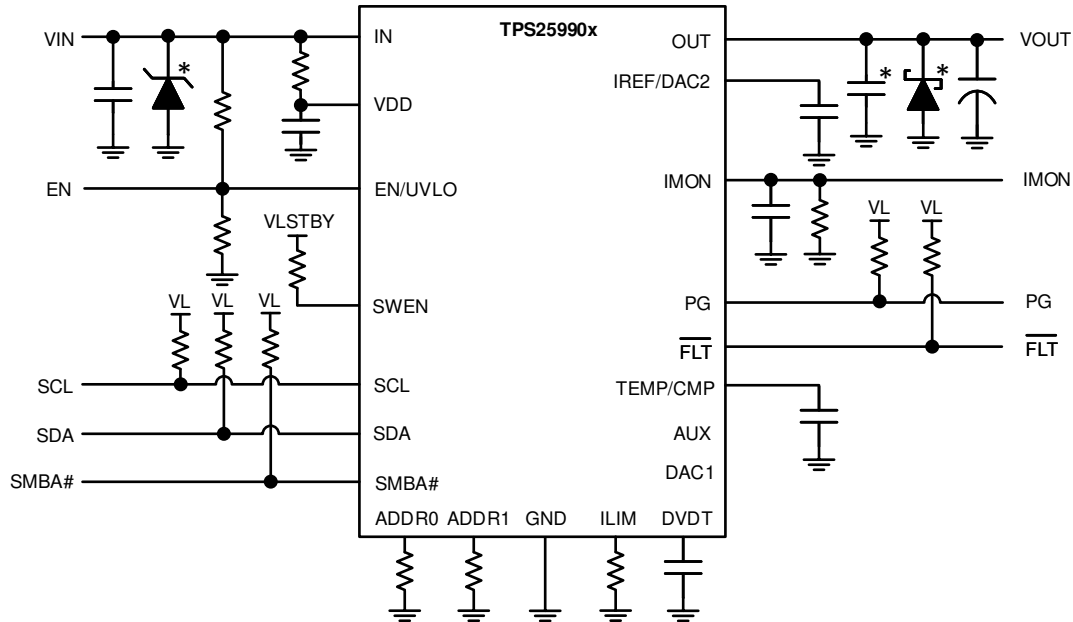
The actual short exhibits a certain degree of randomness because it microscopically bounces and arcs. Ensure that configuration and methods are used to obtain realistic results. Do not expect to see waveforms exactly like those in this data sheet because every setup is different.

9.5 Layout

9.5.1 Layout Guidelines

- For all applications, TI recommends a ceramic decoupling capacitor of 0.1 μ F or greater between the IN terminal and GND terminal.

- For all applications, TI recommends a ceramic decoupling capacitor of 2.2 μ F or greater between the OUT terminal and GND terminal.
- The optimal placement of the decoupling capacitor is closest to the IN and GND terminals of the device. Care must be taken to minimize the loop area formed by the bypass-capacitor connection, the IN terminal, and the GND terminal of the IC. See Figure below for a PCB layout example.
- High current-carrying power-path connections must be as short as possible and must be sized to carry at least twice the full-load current.
- The GND terminal must be tied to the PCB ground plane at the terminal of the IC. The PCB ground must be a copper plane or island on the board.
- The IN and OUT pins are used for Heat Dissipation. Connect to as much copper area as possible with thermal vias.
- Locate the following support components close to their connection pins:
 - C_{IN}
 - C_{OUT}
 - C_{VDD}
 - C_{TEMP}
 - R_{ILIM}
 - R_{IMON}
 - C_{IREF}
 - C_{DVDT}
 - Resistors for the EN/UVLO pin
 - Resistors for the ADDR0, ADDR1 pins
- Connect the other end of the component to the GND pin of the device with shortest trace length. The trace routing for the ADDR0, ADDR1, C_{IN} , C_{OUT} , C_{VDD} , C_{IREF} , R_{ILIM} , R_{IMON} , C_{TEMP} and C_{DVDT} components to the device must be as short as possible to reduce parasitic effects on the current limit and soft-start timing. These traces must not have any coupling to switching signals on the board.
- Because the IMON, ILIM and IREF pins directly control the overcurrent protection behavior of the device, the PCB routing of these nodes must be kept away from any noisy (switching) signals.
- TI recommends to keep the parasitic loading on SWEN pin to a minimum to avoid synchronization issues.
- Protection devices such as TVS, snubbers, capacitors, or diodes must be placed physically close to the device they are intended to protect. These protection devices must be routed with short traces to reduce inductance. For example, TI recommends a protection Schottky diode to address negative transients due to switching of inductive loads, and it must be physically close to the OUT pins.

9.5.2 Layout Example



图 9-19. TPS25990 and TPS25985x Parallel Devices Layout Example

10 Device and Documentation Support

TI offers an extensive line of development tools. Tools and software to evaluate the performance of the device, generate code, and develop solutions are listed below.

10.1 Documentation Support

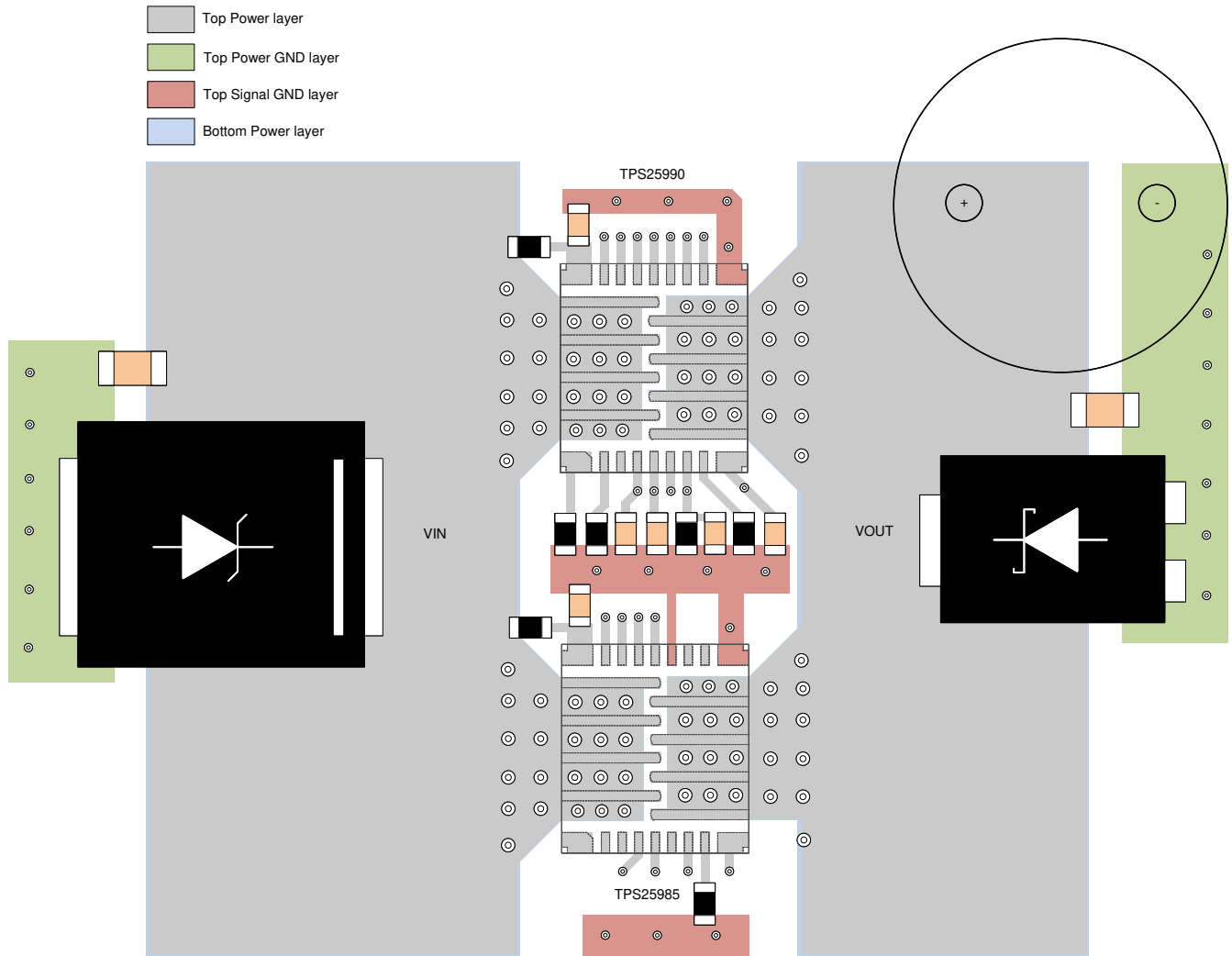
10.1.1 Related Documentation

For related documentation see the following:

- Texas Instruments, [TPS25990EVM eFuse Evaluation Board](#)
- Texas Instruments, [TPS25990x Design Calculator](#)

10.2 接收文档更新通知

要接收文档更新通知，请导航至 [ti.com](#) 上的器件产品文件夹。点击 [订阅更新](#) 进行注册，即可每周接收产品信息更改摘要。有关更改的详细信息，请查看任何已修订文档中包含的修订历史记录。

10.3 支持资源

TI E2E™ 支持论坛是工程师的重要参考资料，可直接从专家获得快速、经过验证的解答和设计帮助。搜索现有解答或提出自己的问题可获得所需的快速设计帮助。

链接的内容由各个贡献者“按原样”提供。这些内容并不构成 TI 技术规范，并且不一定反映 TI 的观点；请参阅 TI 的《[使用条款](#)》。

10.4 Trademarks

SMBus™ is a trademark of Intel.

TI E2E™ is a trademark of Texas Instruments.

PMBus® is a registered trademark of SMIF.

Intel® is a registered trademark of Intel.

所有商标均为其各自所有者的财产。

10.5 静电放电警告



静电放电 (ESD) 会损坏这个集成电路。德州仪器 (TI) 建议通过适当的预防措施处理所有集成电路。如果不遵守正确的处理和安装程序，可能会损坏集成电路。

ESD 的损坏小至导致微小的性能降级，大至整个器件故障。精密的集成电路可能更容易受到损坏，这是因为非常细微的参数更改都可能会导致器件与其发布的规格不相符。

10.6 术语表

[TI 术语表](#) 本术语表列出并解释了术语、首字母缩略词和定义。

11 Mechanical, Packaging, and Orderable Information

The following pages include mechanical, packaging, and orderable information. This information is the most current data available for the designated devices. This data is subject to change without notice and revision of this document. For browser-based versions of this data sheet, refer to the left-hand navigation.

PACKAGING INFORMATION

Orderable Device	Status (1)	Package Type	Package Drawing	Pins	Package Qty	Eco Plan (2)	Lead finish/ Ball material (6)	MSL Peak Temp (3)	Op Temp (°C)	Device Marking (4/5)	Samples
TPS25990ARQPR	ACTIVE	VQFN-HR	RQP	26	3000	RoHS & Green	SN	Level-2-260C-1 YEAR	-40 to 125	T25990 Z2	Samples

(1) The marketing status values are defined as follows:

ACTIVE: Product device recommended for new designs.

LIFEBUY: TI has announced that the device will be discontinued, and a lifetime-buy period is in effect.

NRND: Not recommended for new designs. Device is in production to support existing customers, but TI does not recommend using this part in a new design.

PREVIEW: Device has been announced but is not in production. Samples may or may not be available.

OBSOLETE: TI has discontinued the production of the device.

(2) **RoHS:** TI defines "RoHS" to mean semiconductor products that are compliant with the current EU RoHS requirements for all 10 RoHS substances, including the requirement that RoHS substance do not exceed 0.1% by weight in homogeneous materials. Where designed to be soldered at high temperatures, "RoHS" products are suitable for use in specified lead-free processes. TI may reference these types of products as "Pb-Free".

RoHS Exempt: TI defines "RoHS Exempt" to mean products that contain lead but are compliant with EU RoHS pursuant to a specific EU RoHS exemption.

Green: TI defines "Green" to mean the content of Chlorine (Cl) and Bromine (Br) based flame retardants meet JS709B low halogen requirements of <=1000ppm threshold. Antimony trioxide based flame retardants must also meet the <=1000ppm threshold requirement.

(3) MSL, Peak Temp. - The Moisture Sensitivity Level rating according to the JEDEC industry standard classifications, and peak solder temperature.

(4) There may be additional marking, which relates to the logo, the lot trace code information, or the environmental category on the device.

(5) Multiple Device Markings will be inside parentheses. Only one Device Marking contained in parentheses and separated by a "~" will appear on a device. If a line is indented then it is a continuation of the previous line and the two combined represent the entire Device Marking for that device.

(6) Lead finish/Ball material - Orderable Devices may have multiple material finish options. Finish options are separated by a vertical ruled line. Lead finish/Ball material values may wrap to two lines if the finish value exceeds the maximum column width.

Important Information and Disclaimer:The information provided on this page represents TI's knowledge and belief as of the date that it is provided. TI bases its knowledge and belief on information provided by third parties, and makes no representation or warranty as to the accuracy of such information. Efforts are underway to better integrate information from third parties. TI has taken and continues to take reasonable steps to provide representative and accurate information but may not have conducted destructive testing or chemical analysis on incoming materials and chemicals. TI and TI suppliers consider certain information to be proprietary, and thus CAS numbers and other limited information may not be available for release.

In no event shall TI's liability arising out of such information exceed the total purchase price of the TI part(s) at issue in this document sold by TI to Customer on an annual basis.

TAPE AND REEL INFORMATION

QUADRANT ASSIGNMENTS FOR PIN 1 ORIENTATION IN TAPE



*All dimensions are nominal

Device	Package Type	Package Drawing	Pins	SPQ	Reel Diameter (mm)	Reel Width W1 (mm)	A0 (mm)	B0 (mm)	K0 (mm)	P1 (mm)	W (mm)	Pin1 Quadrant
TPS25990ARQPR	VQFN-HR	RQP	26	3000	330.0	12.4	4.8	5.3	1.15	8.0	12.0	Q2

TAPE AND REEL BOX DIMENSIONS

*All dimensions are nominal

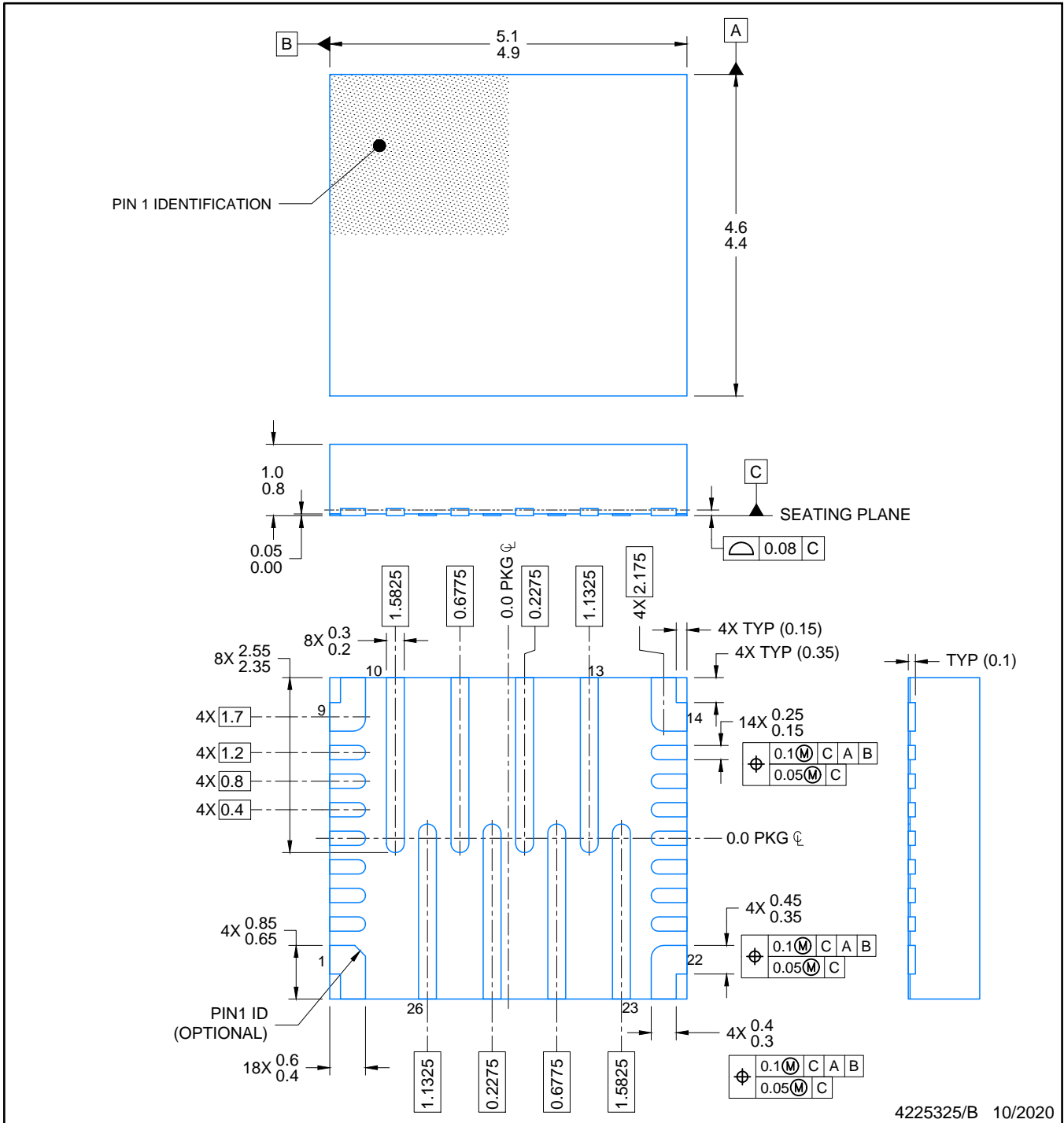
Device	Package Type	Package Drawing	Pins	SPQ	Length (mm)	Width (mm)	Height (mm)
TPS25990ARQPR	VQFN-HR	RQP	26	3000	360.0	360.0	36.0



4225325/B 10/2020

NOTES:

1. All linear dimensions are in millimeters. Any dimensions in parenthesis are for reference only. Dimensioning and tolerancing per ASME Y14.5M.
2. This drawing is subject to change without notice.

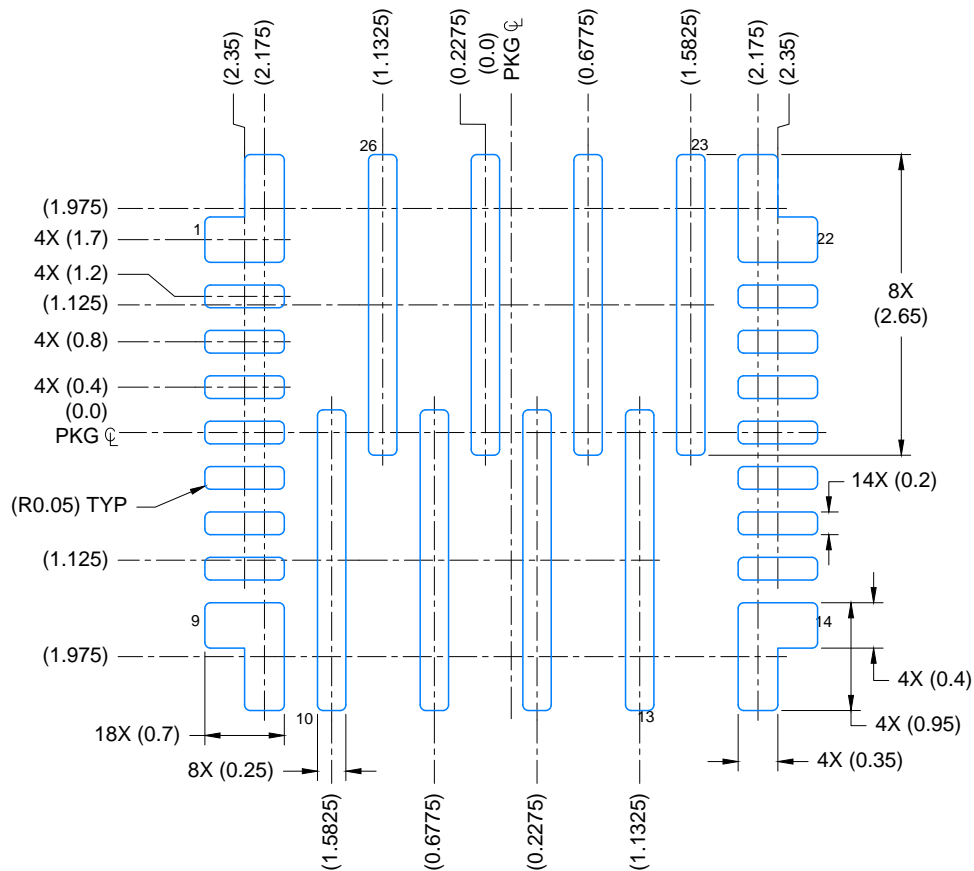

LAND PATTERN EXAMPLE
EXPOSED METAL SHOWN
SCALE: 15X

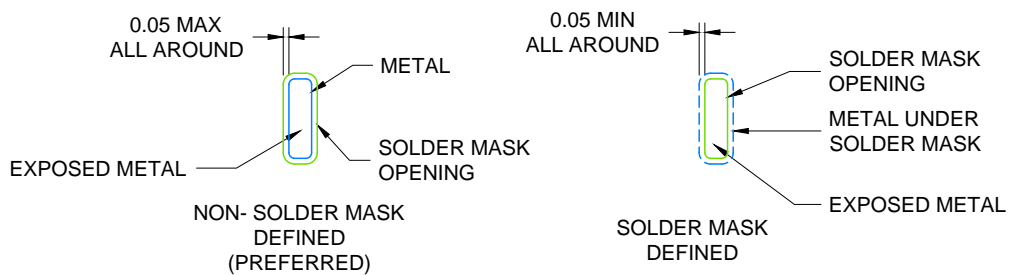

SOLDER MASK DETAILS
NOT TO SCALE

4225325/B 10/2020

NOTES: (continued)

3. For more information, see Texas Instruments literature number SLUA271 (www.ti.com/lit/sluea271).
4. Solder mask tolerances between and around signal pads can vary based on board fabrication site.

EXAMPLE STENCIL DESIGN

VQFN-HR - 1 mm max height

RQP0026A

PLASTIC QUAD FLATPACK-NO LEAD

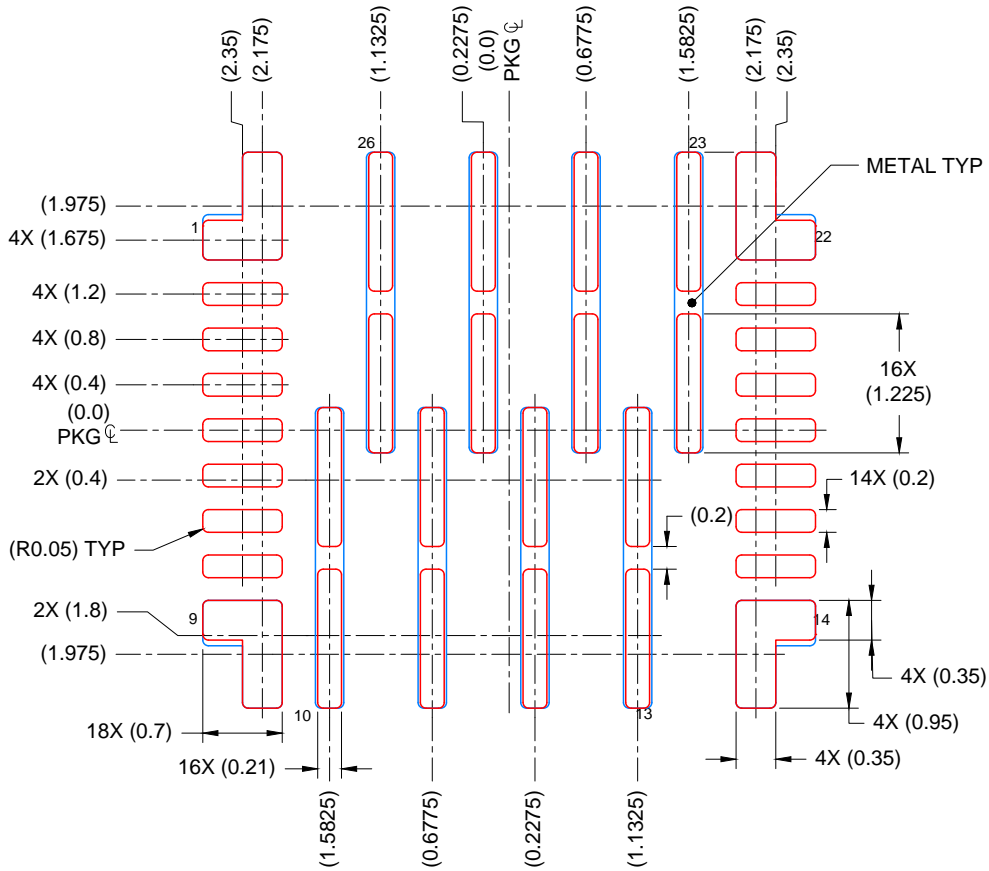

**SOLDER PASTE EXAMPLE
BASED ON 0.1mm THICK STENCIL**

PIN 1,9,14 & 22: 96%; PIN 10-13 & 23-26: 77%
SCALE: 15X

4225325/B 10/2020

NOTES: (continued)

5. Laser cutting apertures with trapezoidal walls and rounded corners may offer better paste release. IPC-7525 may have alternate design recommendations.

重要声明和免责声明

TI“按原样”提供技术和可靠性数据（包括数据表）、设计资源（包括参考设计）、应用或其他设计建议、网络工具、安全信息和其他资源，不保证没有瑕疵且不做任何明示或暗示的担保，包括但不限于对适销性、某特定用途方面的适用性或不侵犯任何第三方知识产权的暗示担保。

这些资源可供使用 TI 产品进行设计的熟练开发人员使用。您将自行承担以下全部责任：(1) 针对您的应用选择合适的 TI 产品，(2) 设计、验证并测试您的应用，(3) 确保您的应用满足相应标准以及任何其他功能安全、信息安全、监管或其他要求。

这些资源如有变更，恕不另行通知。TI 授权您仅可将这些资源用于研发本资源所述的 TI 产品的应用。严禁对这些资源进行其他复制或展示。您无权使用任何其他 TI 知识产权或任何第三方知识产权。您应全额赔偿因在这些资源的使用中对 TI 及其代表造成的任何索赔、损害、成本、损失和债务，TI 对此概不负责。

TI 提供的产品受 [TI 的销售条款](#) 或 [ti.com](#) 上其他适用条款/TI 产品随附的其他适用条款的约束。TI 提供这些资源并不会扩展或以其他方式更改 TI 针对 TI 产品发布的适用的担保或担保免责声明。

TI 反对并拒绝您可能提出的任何其他或不同的条款。

邮寄地址：Texas Instruments, Post Office Box 655303, Dallas, Texas 75265

Copyright © 2023，德州仪器 (TI) 公司