

## TPS40190 4.5V 至 15V 输入、电压模式、同步降压控制器

### 1 特性

- 输入工作电压范围：4.5V 至 15V
- 基准为 0.591V  $\pm$ 1%
- 电压模式控制
- 适用于内部管理、驱动器电源和轻外部负载的内部 5V 稳压器
- 可选短路保护阈值
- 预偏置输出安全保护
- 300kHz 固定开关频率
- 内部软启动
- 小型 3mm  $\times$  3mm、10 引脚 SON 封装
- 适用于 N 沟道 MOSFET 的自举驱动器
- 自适应反跨导功能
- 内部自举二极管
- 用于降低开关损耗的 1.2A 驱动器

### 2 应用

- 电缆调制解调器 CPE
- 数字机顶盒
- 显卡/音频卡
- 入门级和中端服务器

### 3 说明

TPS40190 是一款成本更低的同步降压控制器，额定工作电压范围为 4.5V 至 15V，并且可实现固定频率电压模式电源。该控制器使用自适应反跨导方案来预防高侧和整流器 MOSFET 同时打开，从而防止两个 MOSFET 中出现击穿电流。

该控制器还提供三个短路保护阈值数值，用户可从中择一。可通过从 COMP 连接到 GND 的单个外部电阻器对保护等级进行设置。在启动期间，可检测连接到 COMP 的阻抗，并将信息解码，以便在三个阈值中选择一个。如果控制器检测到输出短路，则会关闭两个 MOSFET，并在达到超时时间后尝试重启。这能在持续故障情况下实现有限的功率耗散。

TPS40190 可提供强大的驱动器以最大限度减小功率级中的开关损耗，降低 MOSFET 中积累的热量，并允许使用更大的 MOSFET 而不会影响开关时间。

器件信息<sup>(1)</sup>

器件型号	封装	封装尺寸（标称值）
TPS40190	VSON (10)	3.00mm $\times$ 3.00mm

(1) 如需了解所有可用封装，请参阅数据表末尾的可订购产品附录。

简化应用示意图

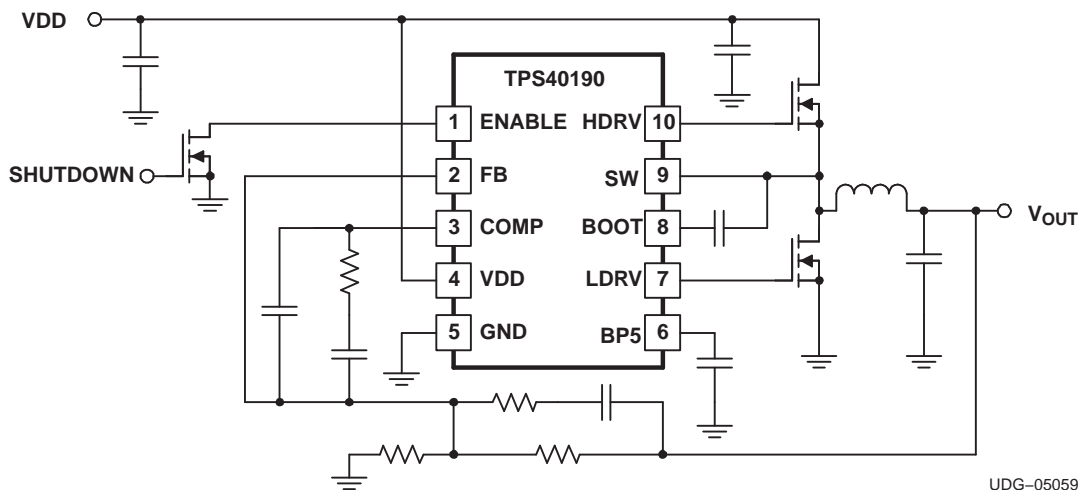

## 目录

<b>1</b>	特性 .....	<b>1</b>	<b>7.1</b>	Overview .....	<b>11</b>
<b>2</b>	应用 .....	<b>1</b>	<b>7.2</b>	Functional Block Diagram .....	<b>11</b>
<b>3</b>	说明 .....	<b>1</b>	<b>7.3</b>	Feature Description .....	<b>11</b>
<b>4</b>	修订历史记录 .....	<b>2</b>	<b>8</b>	<b>Application and Implementation</b> .....	<b>17</b>
<b>5</b>	<b>Pin Configuration and Functions</b> .....	<b>3</b>	<b>8.1</b>	Typical Applications .....	<b>17</b>
<b>6</b>	<b>Specifications</b> .....	<b>4</b>	<b>9</b>	<b>器件和文档支持</b> .....	<b>20</b>
	6.1 Absolute Maximum Ratings .....	<b>4</b>	<b>9.1</b>	文档支持 .....	<b>20</b>
	6.2 Dissipation Ratings .....	<b>4</b>	<b>9.2</b>	接收文档更新通知 .....	<b>20</b>
	6.3 Recommended Operating Conditions .....	<b>4</b>	<b>9.3</b>	社区资源 .....	<b>20</b>
	6.4 Electrical Characteristics .....	<b>5</b>	<b>9.4</b>	商标 .....	<b>20</b>
	6.5 Typical Characteristics .....	<b>7</b>	<b>9.5</b>	静电放电警告 .....	<b>20</b>
<b>7</b>	<b>Detailed Description</b> .....	<b>11</b>	<b>9.6</b>	Glossary .....	<b>20</b>
			<b>10</b>	<b>机械、封装和可订购信息</b> .....	<b>20</b>

## 4 修订历史记录

注：之前版本的页码可能与当前版本有所不同。

<b>Changes from Revision C (July 2012) to Revision D</b>	<b>Page</b>
• 仅有编辑更改，无技术性修订 .....	<b>1</b>
• 添加了特性说明部分，器件功能模式，应用和实施部分，电源相关建议部分，布局部分，器件和文档支持部分以及机械、封装和可订购信息部分 .....	<b>1</b>
• Deleted Ordering Information table .....	<b>3</b>

<b>Changes from Revision B (August 2007) to Revision C</b>	<b>Page</b>
• Added a new paragraph to the end of the Enable Functionality section .....	<b>14</b>

## 5 Pin Configuration and Functions

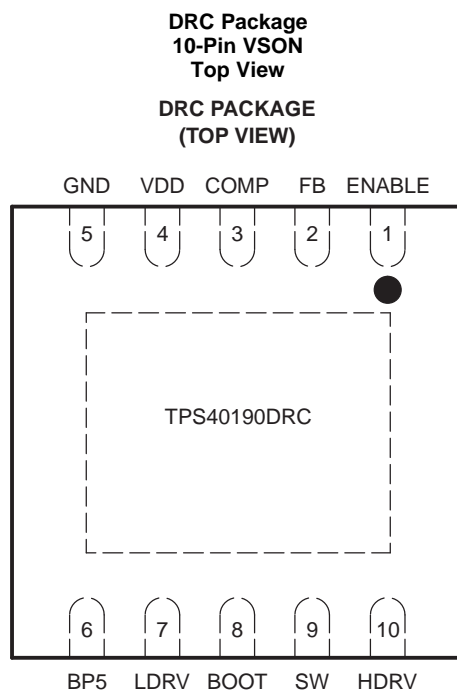

### Pin Functions

PIN		I/O	DESCRIPTION
NO.	NAME		
1	ENABLE	I	Logic level input that starts or stops the controller from an external user command. A high level turns the controller on. This pin has a high-impedance internal pull-up integrated into the device. Because this pin is high impedance, a 10-nF capacitor to ground or an external pull-up resistor (100 kΩ) to VDD is recommended to avoid noise coupling to this pin.
2	FB	I	Inverting input to the error amplifier
3	COMP	O	Output of the error amplifier. Connecting a resistance from COMP to GND sets the output short circuit detection threshold. See applications information for details.
4	VDD	I	Power input to the controller
5	GND	—	Common connection for the controller
6	BP5	O	Output bypass for the internal regulator. Connect 4.7-μF capacitor from this pin to GND. Low power, low noise loads may be connected here if desired. The sum of the external load and the gate drive requirements must not exceed 40 mA. The regulator is turned off when the ENABLE pin is pulled low.
7	LDRV	O	Output to the rectifier FET gate
8	BOOT	I	Power supply for the flying high-side driver
9	SW	I	Sense line for the adaptive anti cross conduction circuitry. Serves as common connection for the flying high side FET driver
10	HDRV	O	Bootstrapped output for driving the gate of the high side N channel FET.

## 6 Specifications

### 6.1 Absolute Maximum Ratings

over operating free-air temperature range (unless otherwise noted)<sup>(1)</sup>

		MIN	MAX	UNIT
Input voltage range	VDD	−0.3	16.5	V
	SW	−5	22	
	BOOT-SW, HDRV-SW (differential from BOOT or HDRV to SW)	−0.3	6	
	COMP	−0.3	3	
	FB, BP5, LDRV, ENABLE	−0.3	6	
Operating junction temperature, T <sub>J</sub>		−40	125	°C
Storage temperature, T <sub>stg</sub>		−55	150	°C

- (1) Stresses beyond those listed under *Absolute Maximum Ratings* may cause permanent damage to the device. These are stress ratings only, which do not imply functional operation of the device at these or any other conditions beyond those indicated under *Recommended Operating Conditions*. Exposure to absolute-maximum-rated conditions for extended periods may affect device reliability.

### 6.2 Dissipation Ratings

PACKAGE	R <sub>θJA</sub> High-K Board <sup>(1)</sup> (°C/W)	R <sub>θJC</sub> <sup>(2)</sup> (°C/W)
DRC	47.9	14.1

- (1) The JEDEC High-K (2s2p) board design used to derive this data was a 3-inch x 3-inch (7.5-cm x 7.5-cm), multilayer board with one-ounce internal power and ground planes and two-ounce copper traces on top and bottom of the board.
- (2) The junction-to-case impedance is measured from the die to the thermal pad on the device package.

### 6.3 Recommended Operating Conditions

		MIN	NOM	MAX	UNIT
V <sub>DD</sub>	Input voltage	4.5		15	V
T <sub>A</sub>	Operating free-air temperature	−40		85	°C

## 6.4 Electrical Characteristics

 $T_A = -40^{\circ}\text{C}$  to  $85^{\circ}\text{C}$ ,  $V_{\text{VDD}} = 12\text{ V}_{\text{dc}}$ ,  $T_A = T_J$ , and all parameters at zero power dissipation (unless otherwise noted)

PARAMETER		TEST CONDITIONS	MIN	TYP	MAX	UNIT
$V_{\text{FB}}$	Feedback voltage range	$0^{\circ}\text{C} \leq T_J \leq 85^{\circ}\text{C}$	585	591	597	mV
		$-40^{\circ}\text{C} \leq T_J \leq 85^{\circ}\text{C}$	582	591	597	
<b>INPUT SUPPLY</b>						
$V_{\text{VDD}}$	Input voltage range		4.5		15.0	V
$I_{\text{VDD}}$	Operating current	$V_{\text{ENABLE}} = 2.5\text{ V}$ , Outputs switching			2.5	mA
		$V_{\text{ENABLE}} = 0.6\text{ V}$			20	$\mu\text{A}$
<b>ON BOARD REGULATOR</b>						
$V_{\text{5VBP}}$	Output voltage	$V_{\text{VDD}} > 6\text{ V}$ , $I_{\text{5VBP}} \leq 10\text{ mA}$	5.1	5.3	5.5	V
$V_{\text{DO}}$	Regulator dropout voltage	$V_{\text{VDD}} - V_{\text{BP5}}$ , $V_{\text{VDD}} = 5\text{ V}$ , $I_{\text{BP5}} \leq 25\text{ mA}$		270	400	mV
$I_{\text{SC}}$	Regulator current limit threshold		40			mA
$I_{\text{BP5}}$	Average current <sup>(1)</sup>				40	
<b>OSCILLATOR</b>						
$f_{\text{SW}}$	Switching frequency		240	300	360	kHz
$V_{\text{RMP}}$	Ramp amplitude <sup>(2)</sup>			0.75		V
$V_{\text{VALLEY}}$	Valley voltage <sup>(2)</sup>			0.5		V
<b>PWM</b>						
$D_{\text{MAX}}$	Maximum duty cycle <sup>(2)</sup>		85%			
$t_{\text{ON(min)}}$	Minimum controlled pulse <sup>(2)</sup>				130	ns
$t_{\text{DEAD}}$	Output driver dead time	HDRV off to LDRV on		50		ns
		LDRV off to HDRV on		25		
<b>SOFT-START</b>						
$t_{\text{SS}}$	Soft-start time		3.0	4.7	7.0	ms
$t_{\text{SSDLY}}$	Soft-start delay time <sup>(3)</sup>			6		ms
$t_{\text{REG}}$	Time to regulation			10.5		ms
<b>ERROR AMPLIFIER</b>						
GBWP	Gain bandwidth product <sup>(2)</sup>		5			MHz
$A_{\text{OL}}$	DC gain <sup>(2)</sup>		60			dB
$I_{\text{IB}}$	Input bias current (current out of FB pin)		100		0	nA
$I_{\text{EAOP}}$	Output source current	$V_{\text{FB}} = 0\text{ V}$	1			mA
$I_{\text{EAOM}}$	Output sink current	$V_{\text{FB}} = 2\text{ V}$	1			mA
<b>SHORT CIRCUIT PROTECTION</b>						
$t_{\text{PSS(min)}}$	Minimum pulse during short circuit <sup>(2)</sup>				250	ns
$t_{\text{BLNK}}$	Blanking time <sup>(2)</sup>		100	140	180	ns
$t_{\text{OFF}}$	Off-time between restart attempts		25	95		ms
$V_{\text{ILIM}}$	Short circuit comparator threshold voltage	$R_{\text{COMP(GND)}} = \text{OPEN}$ , $T_J = 25^{\circ}\text{C}$	256	320	384	mV
		$R_{\text{COMP(GND)}} = 4\text{ k}\Omega$ , $T_J = 25^{\circ}\text{C}$	128	160	192	
		$R_{\text{COMP(GND)}} = 12\text{ k}\Omega$ , $T_J = 25^{\circ}\text{C}$	368	460	552	

(1) 40 mA is the current available for MOSFET gate drive, the device itself and any external loads. The sum of these must not exceed 40 mA.

(2) Specified by design. Not production tested.

(3) The delay time is the time delay from application of power to the device or from assertion of ENABLE until the output begins to rise.

**Electrical Characteristics (continued)**
 $T_A = -40^\circ\text{C}$  to  $85^\circ\text{C}$ ,  $V_{\text{VDD}} = 12 V_{\text{dc}}$ ,  $T_A = T_J$ , and all parameters at zero power dissipation (unless otherwise noted)

PARAMETER		TEST CONDITIONS	MIN	TYP	MAX	UNIT
<b>OUTPUT DRIVERS</b>						
$R_{\text{HDHI}}$	High-side driver pull-up resistance	$V_{\text{BOOT}} - V_{\text{SW}} = 4.5 \text{ V}$ , $I_{\text{HDRV}} = -100 \text{ mA}$		3	6	$\Omega$
$R_{\text{HDLO}}$	High-side driver pull-down resistance	$V_{\text{BOOT}} - V_{\text{SW}} = 4.5 \text{ V}$ , $I_{\text{HDRV}} = 100 \text{ mA}$		1.5	3	$\Omega$
$R_{\text{LDHI}}$	Low-side driver pull-up resistance	$I_{\text{LDRV}} = -100 \text{ mA}$		2.5	5	$\Omega$
$R_{\text{LDLO}}$	Low-side driver pull-down resistance	$I_{\text{LDRV}} = 100 \text{ mA}$		0.8	1.5	$\Omega$
$t_{\text{HRISE}}$	High-side driver rise time <sup>(2)</sup>	$C_{\text{LOAD}} = 1 \text{ nF}$		15	35	ns
$t_{\text{H FALL}}$	High-side driver fall time <sup>(2)</sup>	$C_{\text{LOAD}} = 1 \text{ nF}$		10	25	ns
$t_{\text{LRISE}}$	Low-side driver rise time <sup>(2)</sup>	$C_{\text{LOAD}} = 1 \text{ nF}$		15	35	ns
$t_{\text{L FALL}}$	Low-side driver fall time <sup>(2)</sup>	$C_{\text{LOAD}} = 1 \text{ nF}$		10	25	ns
<b>UNDERVOLTAGE LOCKOUT (UVLO)</b>						
$V_{\text{UVLO}}$	Turn-on voltage		4.1	4.25	4.4	V
$\text{UVLO}_{\text{HYST}}$	Hysteresis		270	320	370	mV
<b>SHUTDOWN</b>						
$V_{\text{IH}}$	High-level input voltage	ENABLE			2.8	V
$V_{\text{IL}}$	Low-level input voltage	ENABLE	0.6			V
<b>BOOT DIODE</b>						
$V_{\text{DFWD}}$	Bootstrap diode forward voltage	$I_{\text{BOOT}} = 5 \text{ mA}$	0.6	0.8	1.2	V

## 6.5 Typical Characteristics

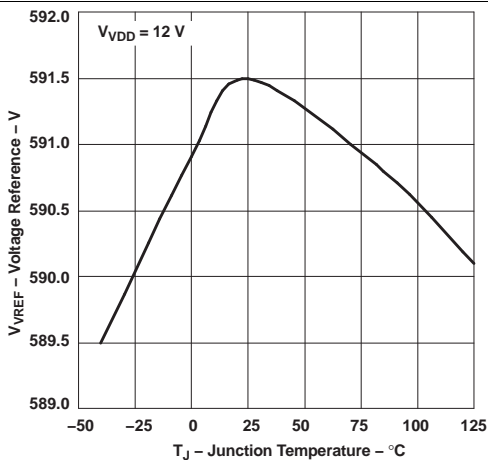

Figure 1. Reference Voltage vs Temperature

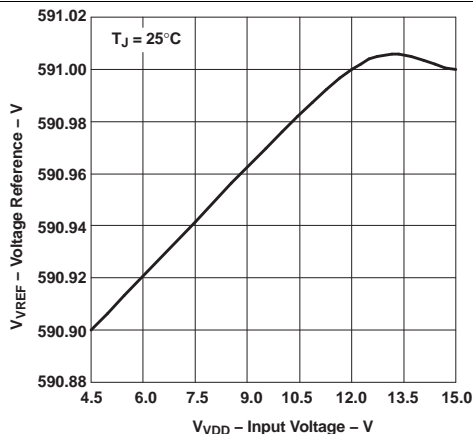

Figure 2. Reference Voltage vs Input Voltage

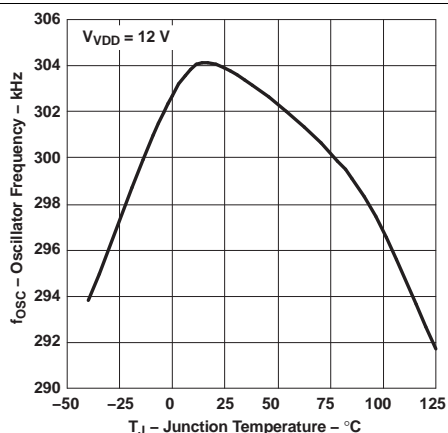

Figure 3. Oscillator Frequency vs Temperature

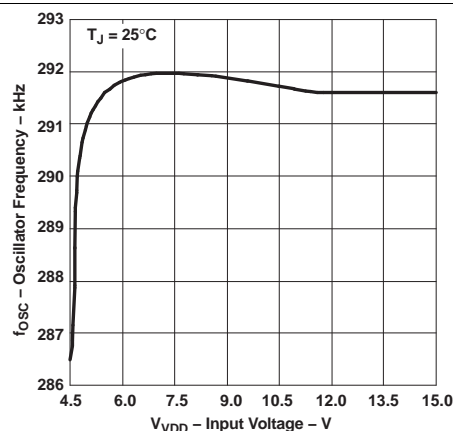

Figure 4. Oscillator Frequency vs Input Voltage

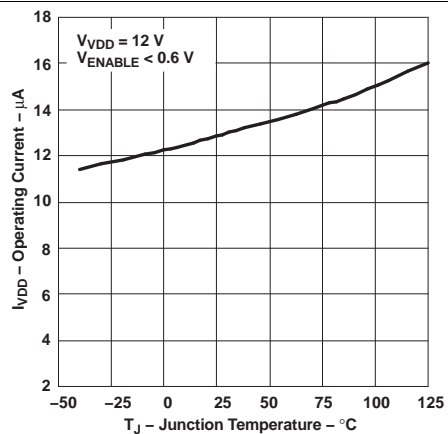

Figure 5. Operating Current vs Temperature

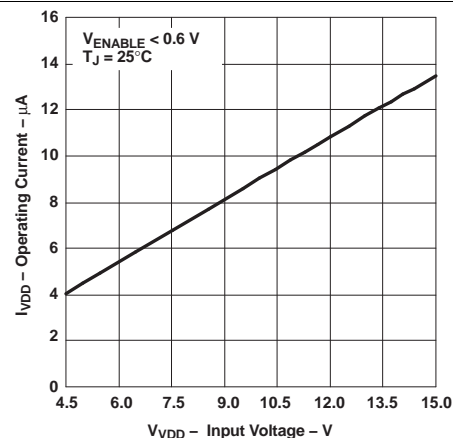

Figure 6. Operating Current vs Input Voltage

Typical Characteristics (continued)

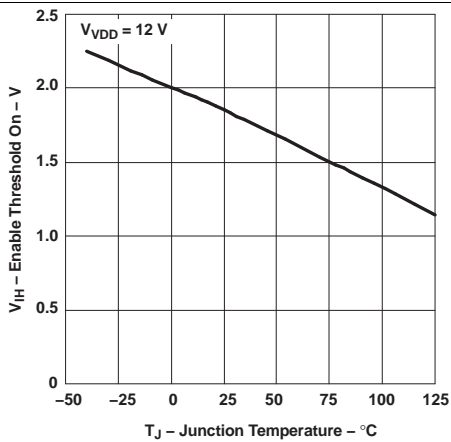

Figure 7. Enable Threshold On vs Temperature

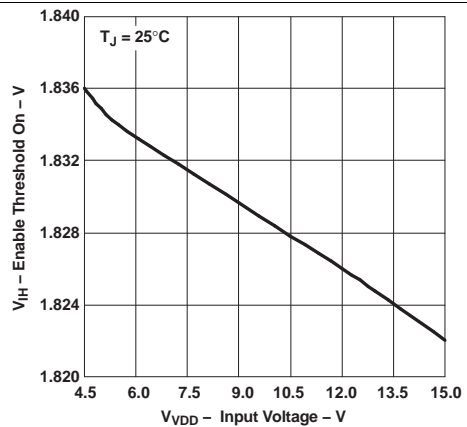

Figure 8. Enable Threshold On vs Input Voltage

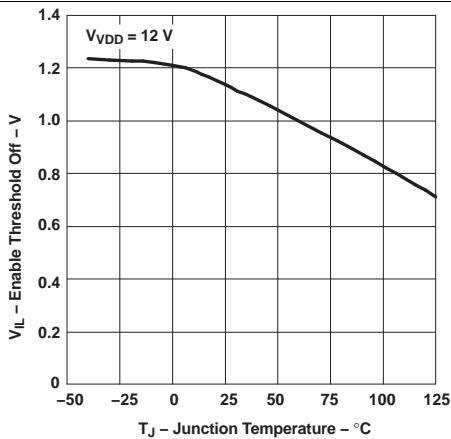

Figure 9. Enable Threshold Off vs Temperature

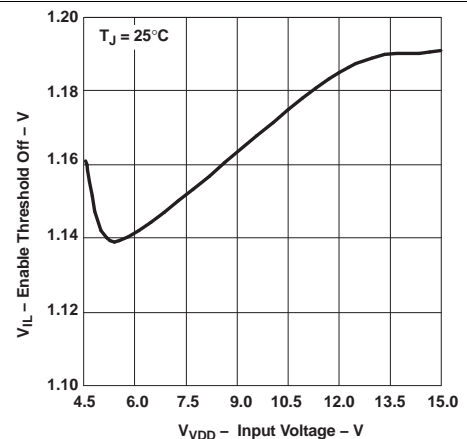

Figure 10. Enable Threshold Off vs Input Voltage

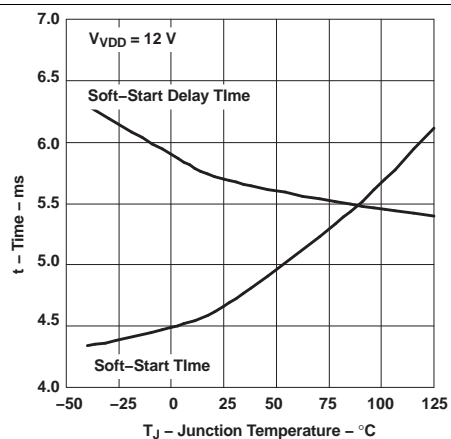

Figure 11. Soft Start Timing vs Temperature

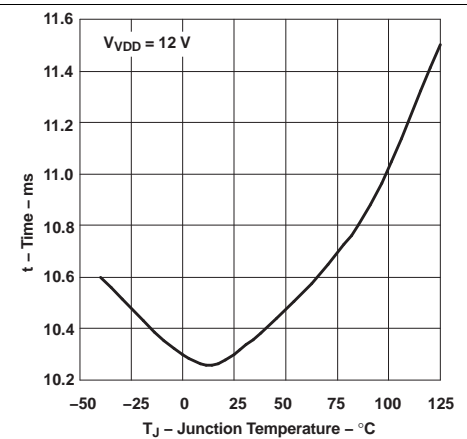

Figure 12. Total Startup Time vs Temperature



Typical Characteristics (continued)

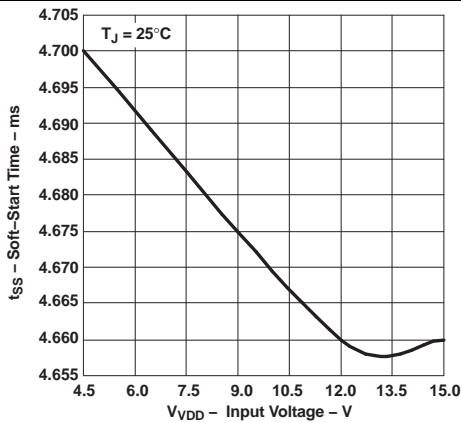

Figure 13. Soft Start Timing vs Input Voltage

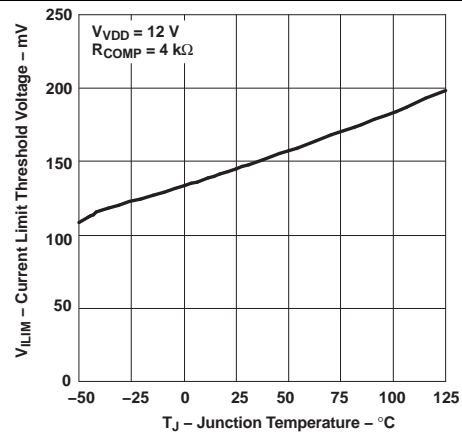

Figure 14. Current Limit Threshold vs Temperature

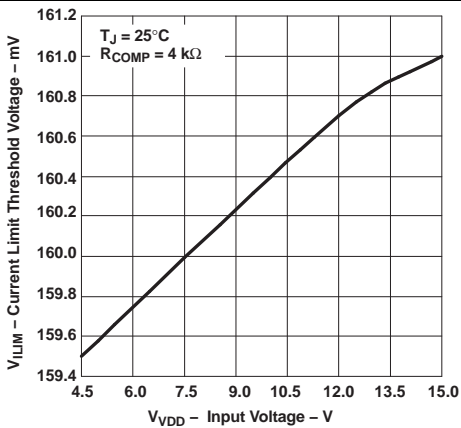

Figure 15. Current Limit Threshold vs Input Voltage

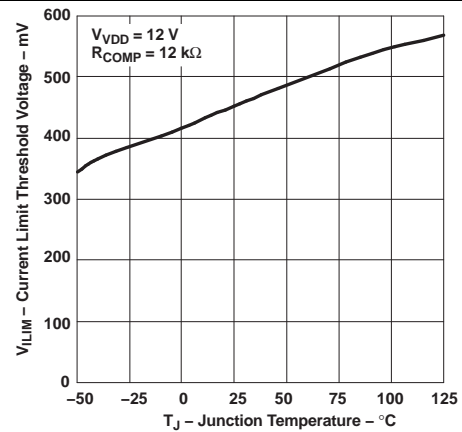

Figure 16. Current Limit Threshold vs Temperature

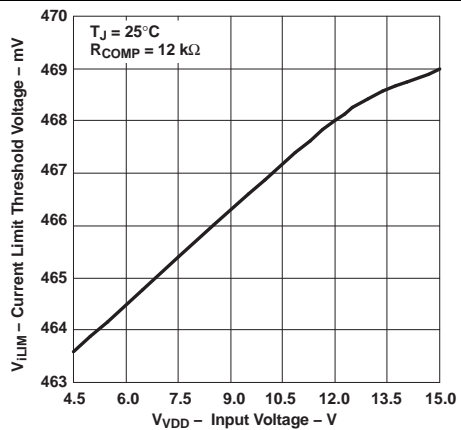

Figure 17. Current Limit Threshold vs Input Voltage

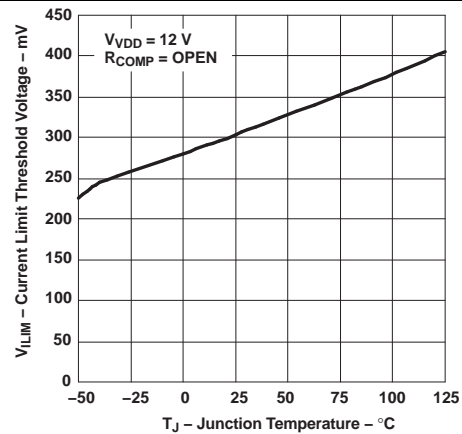

Figure 18. Current Limit Threshold vs Temperature

Typical Characteristics (continued)

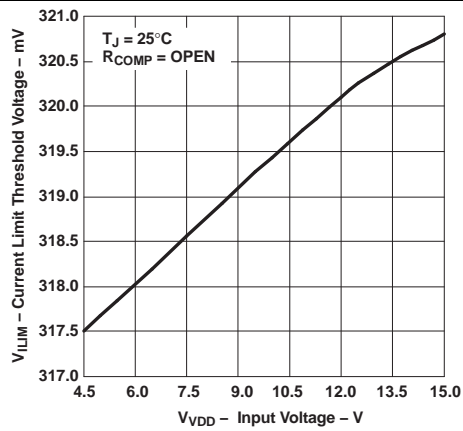

Figure 19. Current Limit Threshold vs Input Voltage

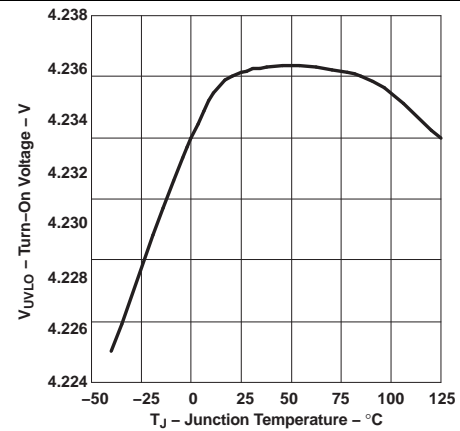

Figure 20. Undervoltage Lockout Turn On Voltage vs Temperature

## 7 Detailed Description

### 7.1 Overview

The TPS40190 is a cost optimized controller providing all the necessary features to construct a high-performance DC-DC converter while keeping costs to a minimum. Support for pre-biased outputs eliminates concerns about damaging sensitive loads during start-up. Strong gate drivers for the high side and rectifier N-channel MOSFETs decrease switching losses for increased efficiency. Adaptive gate drive timing minimizes body diode conduction in the rectifier MOSFET, also increasing efficiency. Selectable short circuit protection thresholds and hiccup output recovery from a short-circuit increase design flexibility and minimize power dissipation in the event of a prolonged output fault. A dedicated enable pin (ENABLE) allows the converter to be placed in a very low quiescent current shutdown mode.

Internally fixed switching frequency and soft-start time reduce external component count, simplifying design and layout, as well as reducing footprint and cost. The 3-mm x 3-mm package size also contributes to a reduced overall converter footprint.

### 7.2 Functional Block Diagram

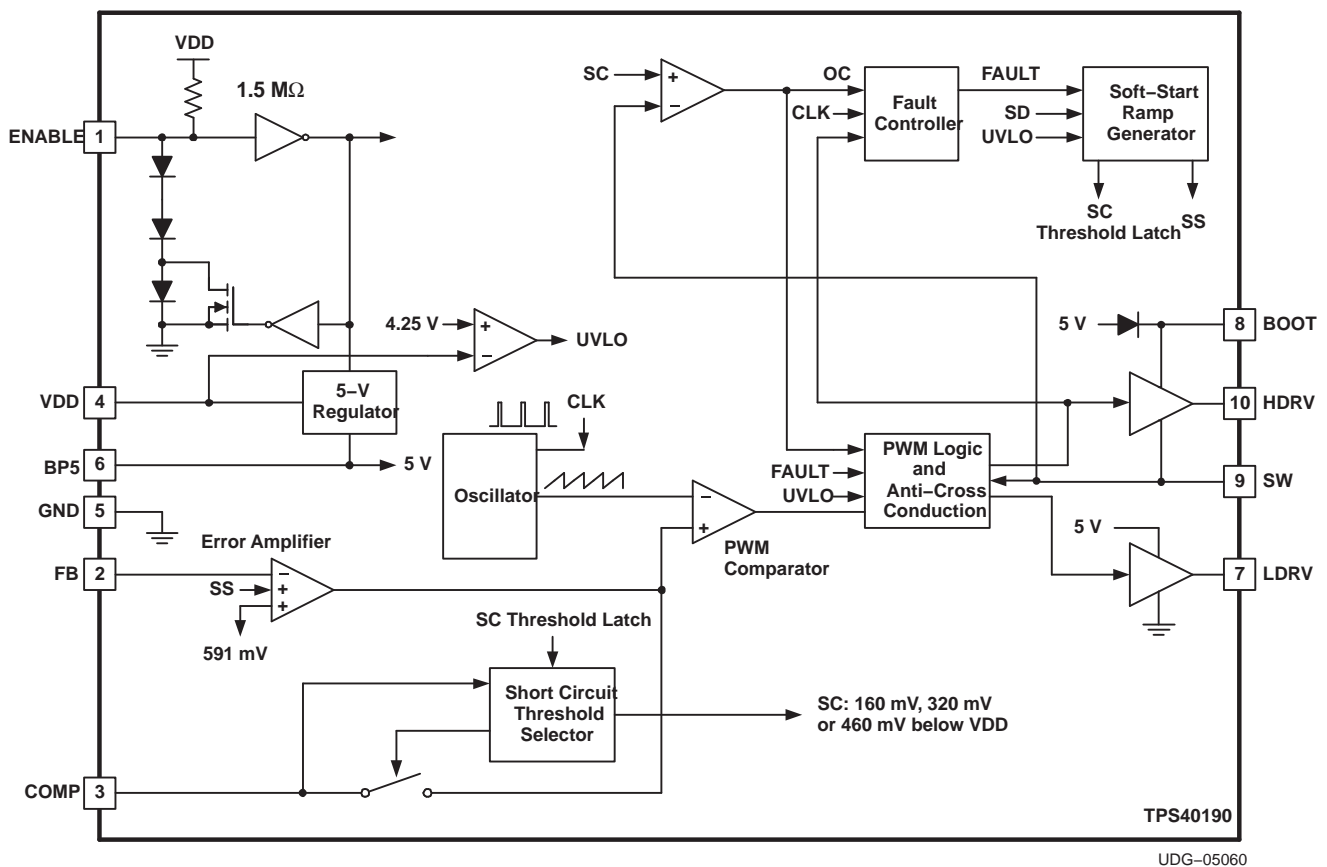

### 7.3 Feature Description

#### 7.3.1 Internally Fixed Parameters

The TPS40190 has a fixed internal switching frequency of 300 kHz. Soft-start time is fixed at 4.7 ms typical and the UVLO level is set between 4.1 V and 4.4 V.

## Feature Description (continued)

### 7.3.2 Output Short Circuit Protection

The short circuit detection in the TPS40190 is done by sensing the voltage drop across the high side FET when it is on. If the voltage drop across this FET exceeds the selected threshold in any given switching cycle, a counter counts up one count and the FET is turned off early. If the voltage drop across that FET does not exceed this threshold, the counter is decremented for that cycle and the FET is allowed to remain on for the normal pulse width commanded by the internal pulse width modulator. If the counter fills up (a count of 7) a fault condition is declared and the drivers turn both FETs off. After a timeout of approximately 95 ms, the controller attempts to restart. If a short circuit is still present at the output, the current ramps quickly up to the short-circuit threshold and another fault condition is declared. The device then waits 95 ms to attempt to restart again.

Typical waveforms during a short circuit event are shown in [Figure 21](#) and [Figure 22](#).

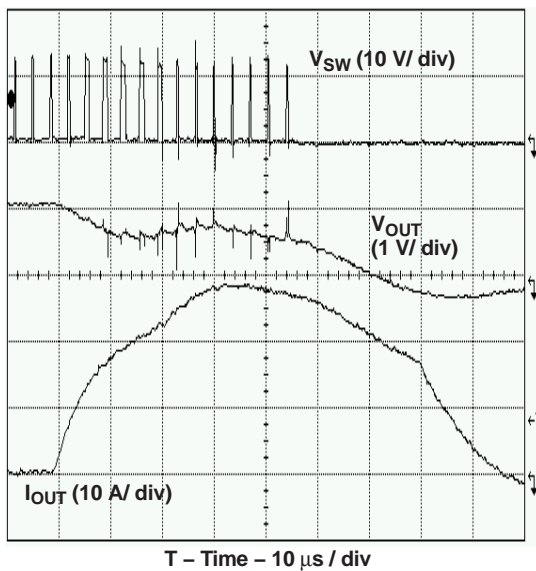

**Figure 21. Output Short Circuit Detected (Nominal Threshold 25 A)**

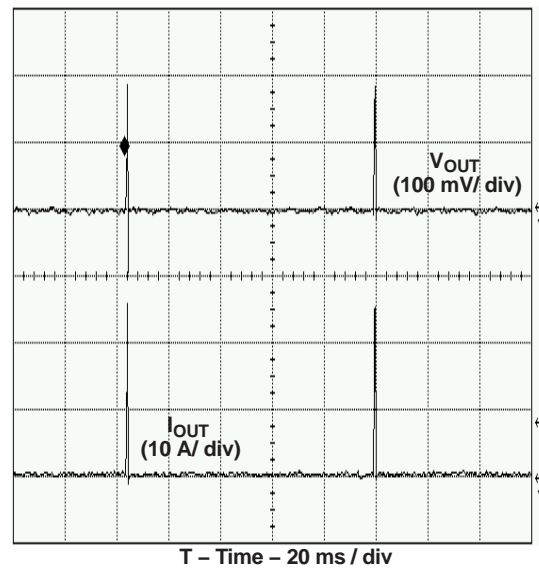

**Figure 22. Output Fault Hiccup Restart Timing**

The TPS40190 provides three selectable short circuit protection thresholds: 160 mV, 320 mV and 460 mV. The particular threshold is selected by connecting a resistor from COMP to GND. [Table 1](#) gives the short circuit thresholds for corresponding resistors from COMP to GND. Note that since the TPS40190 measures the resistance from COMP to GND during a 2-ms window, the compensation network from COMP to FB should have a time constant significantly less than 1 ms or there can be issues detecting the resistance and setting the correct short circuit threshold. This network should have no DC path from COMP to FB.

The short circuit detection threshold in the TPS40190 has some temperature compensation built in to help offset the high-side FET rise in resistance as its temperature rises. A typical FET has a resistance temperature coefficient of about 4500 ppm/°C. The temperature coefficient of the short circuit threshold is approximately 4200 ppm/°C. [Figure 23](#) shows how the short circuit threshold increases with temperature to help compensate for the FET resistance increase. The relative FET resistance change is based on an estimate of a linear 4500 ppm/°C temperature coefficient. The effectiveness of this compensation depends on how tight the thermal coupling between the TPS40190 and the high-side FET is. Better thermal coupling between the TPS40190 and the high-side FET gives better compensation effectiveness.

Feature Description (continued)

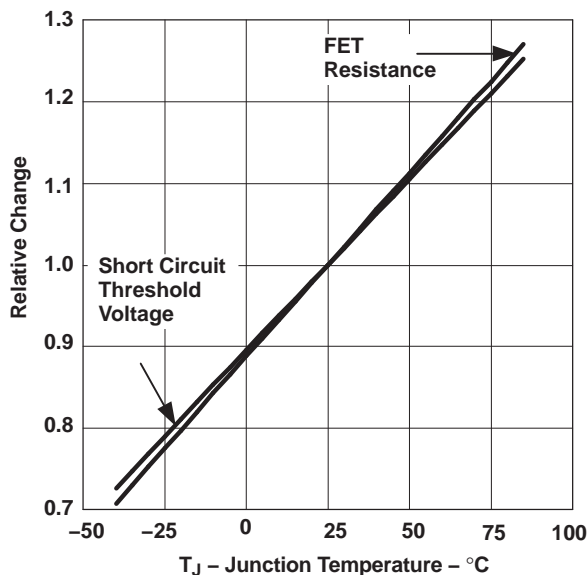

Figure 23. Relative Short Circuit Threshold Change vs Temperature

Table 1. Short Circuit Threshold Voltage Selection

SHORT CIRCUIT PROTECTION RESISTANCE, R <sub>COMP</sub> (kΩ)	NOMINAL CURRENT LIMIT VOLTAGE, V <sub>ILIM</sub> (mV)
10.8 to 13.2	460
OPEN	320
3.6 to 4.4	160

The range of short circuit current thresholds that can be expected is given by Equation 1 and Equation 2.

$$I_{SCP(max)} = \frac{V_{ILIM(max)}}{R_{DS(on)MIN}} \tag{1}$$

$$I_{SCP(min)} = \frac{V_{ILIM(min)}}{R_{DS(on)MAX}}$$

where

- I<sub>SCP</sub> is the short circuit current
  - V<sub>ILIM</sub> is the short circuit threshold
  - R<sub>DS(on)</sub> is the channel resistance of the high-side MOSFET
- (2)

7.3.3 Enable Functionality

The TPS40190 has a dedicated ENABLE pin. This simplifies user level interface design since no multiplexed functions exist. Another benefit is a true low power shutdown mode of operation. In this state, the BP5 regulator is turned off. When the ENABLE pin is pulled to GND, the TPS40190 consumes a typical 20-μA of current. A functionally equivalent circuit to the enable circuitry on the TPS40190 is shown in Figure 24.

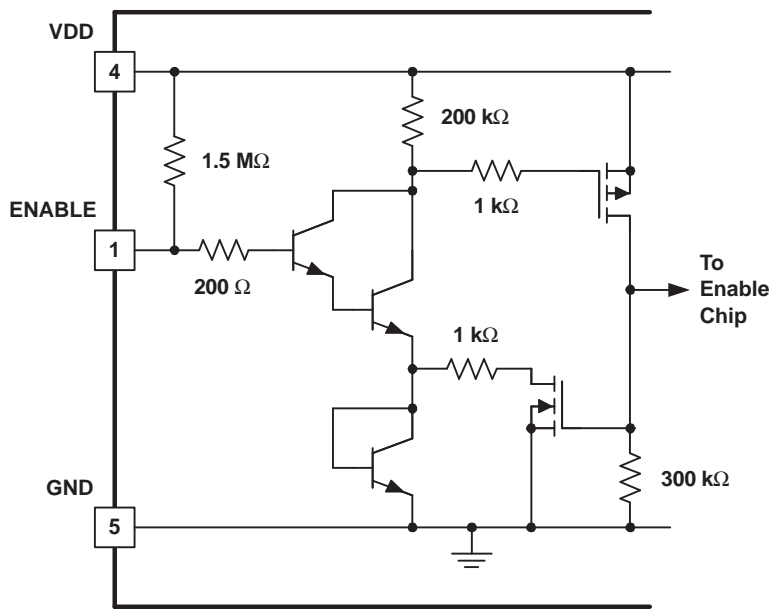

UDG-05061

**Figure 24. TPS40190 ENABLE Pin Internal Circuitry**

If the ENABLE pin is left floating, the chip starts automatically. The pin must be pulled to less than 600 mV to ensure that the TPS40190 is in shutdown mode. Note that the ENABLE pin is relatively high impedance. In some situations, there could be enough noise nearby to cause the ENABLE pin to swing below the 600 mV threshold and give erroneous shutdown commands to the rest of the device. There are two solutions to this problem should it arise.

1. Place a capacitor from ENABLE to GND. A side effect of this is to delay the start of the converter while the capacitor charges past the enable threshold
2. Place a resistor from VDD to ENABLE. This causes more current to flow in the shutdown mode, but does not delay converter startup. If a resistor is used, the total current into the ENABLE pin should be limited to no more than 500  $\mu$ A.

The ENABLE pin is self-clamping. The clamp voltage can be as low as 1 V with a 1-k $\Omega$  ground impedance. Due to this self-clamping feature, the pull-up impedance on the ENABLE pin should be selected to limit the sink current to less than 500  $\mu$ A. Driving the ENABLE pin with a low-impedance source voltage can result in damage to the device. Because of the self-clamping feature, it requires care when connecting multiple ENABLE pins together. For enabling multiple TPS4019x devices (TPS40190, TPS40192, TPS40193, TPS40195, TPS40197), see the Application Report [SLVA509](#).

Typical waveforms for startup and shutdown using the ENABLE pin are shown in [Figure 25](#) and [Figure 26](#).

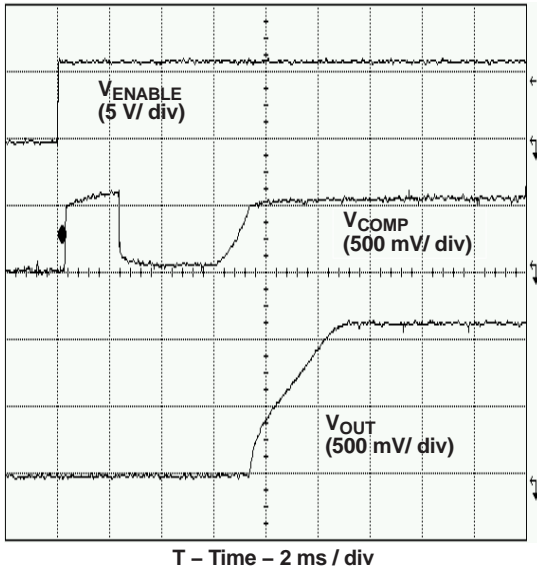

Figure 25. Startup Using ENABLE Pin

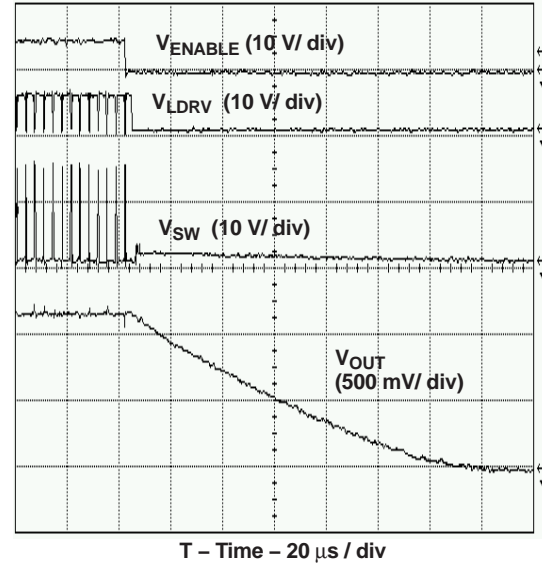

Figure 26. Shutdown Using ENABLE Pin

### 7.3.4 5-V Regulator

The TPS40190 has an on board 5-V regulator that allows the part to operate from a single voltage feed. No separate 5-V feed to the part is required. This regulator needs to have 4.7- $\mu$ F of capacitance on the BP5 pin for stability. A ceramic capacitor is suggested for this purpose.

This regulator can also be used to supply power to nearby circuitry, eliminating the need for a separate LDO in some cases. If this pin is used for external loads, keep in mind that this is the power supply for the internals of the TPS40190. While efforts have been made to reduce sensitivity, any noise induced on this line has an adverse effect on the overall performance of the internal circuitry and shows up as increased pulse jitter, or skewed reference voltage. This regulator is turned off when the ENABLE pin is pulled low.

The amount of power available from this pin varies with the size of the power MOSFETs that the drivers must operate. Larger MOSFETs require more gate drive current and reduces the amount of power available on this pin for other tasks.

The total amount of current required by the gate drive and the external circuitry should not exceed 40 mA. The current required to drive the FET gates can be found from [Equation 3](#).

$$I_G = f_{SW} \times (Q_{G(\text{high})} + Q_{G(\text{low})})$$

Where

- $I_G$  is the required gate drive current
  - $f_{SW}$  is the switching frequency (300 kHz)
  - $Q_{G(\text{high})}$  is the gate charge requirement for the high-side FET at 5 V  $V_{GS}$
  - $Q_{G(\text{low})}$  is the gate charge requirement for the low-side FET at 5 V  $V_{GS}$
- (3)

### 7.3.5 Startup Sequence and Timing

The TPS40190 startup sequence is as follows. After input power is applied, the 5-V onboard regulator comes up. Once this regulator comes up, the TPS40190 goes through a period where it samples the impedance at the COMP pin and decides the short circuit protection threshold voltage. This is accomplished by placing 400 mV on the COMP pin for approximately 2 ms. During this time, the current is measured and compared against internal thresholds to select the short circuit protection threshold. After this, the COMP pin is brought low for 4 ms. This ensures that the feedback loop is preconditioned at startup and no sudden output rise occurs at the output of the converter when the converter is allowed to start switching. After these initial 6 milliseconds, the internal soft-start circuitry is engaged and the converter is allowed to start. See [Figure 27](#).

### 7.3.6 Prebias Outputs

Some applications require that the converter not sink current during start-up if a pre-existing voltage is higher than the output. Because synchronous buck converters inherently sink current some method of overcoming this characteristic must be employed. Applications that require this operation are typically power rails for a multi supply processor or ASIC. The method used in this controller, is to not allow the low side or rectifier FET to turn on until there the output voltage commanded by the start up ramp is higher than the pre-existing output voltage. This is detected by monitoring the internal pulse width modulator (PWM) for its first output pulse. Because this controller uses a closed loop startup, the first output pulse from the PWM does not occur until the output voltage is commanded to be higher than the pre-existing voltage. This effectively limits the controller to sourcing current only during the startup sequence.

If the pre-existing voltage is higher than the intended regulation point for the output of the converter, the converter starts and sinks current when the soft-start time has completed. A typical pre-biased start-up is shown in [Figure 28](#).

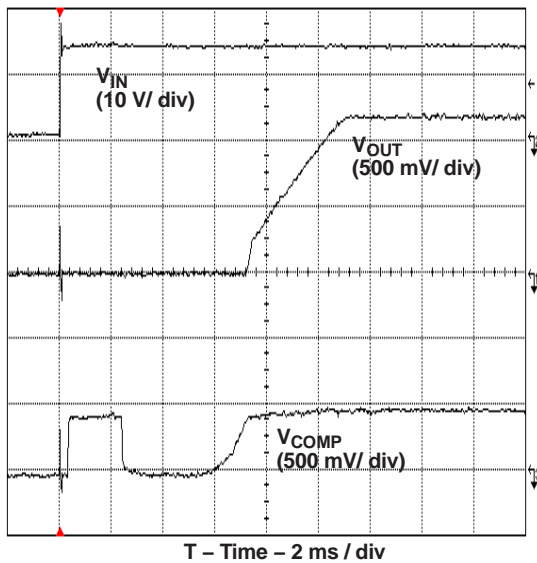

**Figure 27. TPS40190 Start-up Timing**

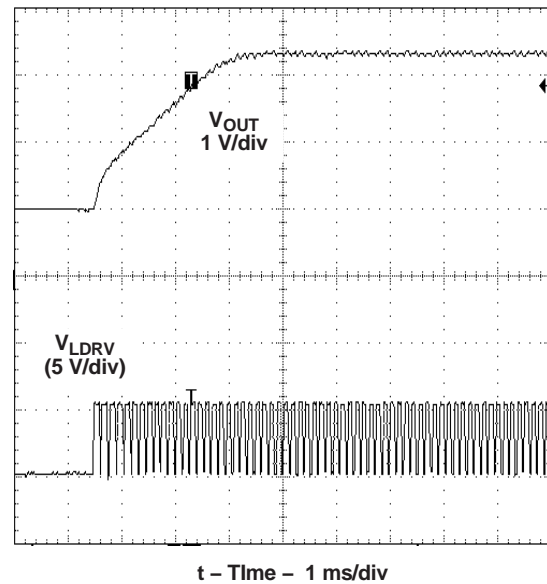

**Figure 28. Prebiased Start-up Timing**



## 8 Application and Implementation

### NOTE

Information in the following applications sections is not part of the TI component specification, and TI does not warrant its accuracy or completeness. TI's customers are responsible for determining suitability of components for their purposes. Customers should validate and test their design implementation to confirm system functionality.

### 8.1 Typical Applications

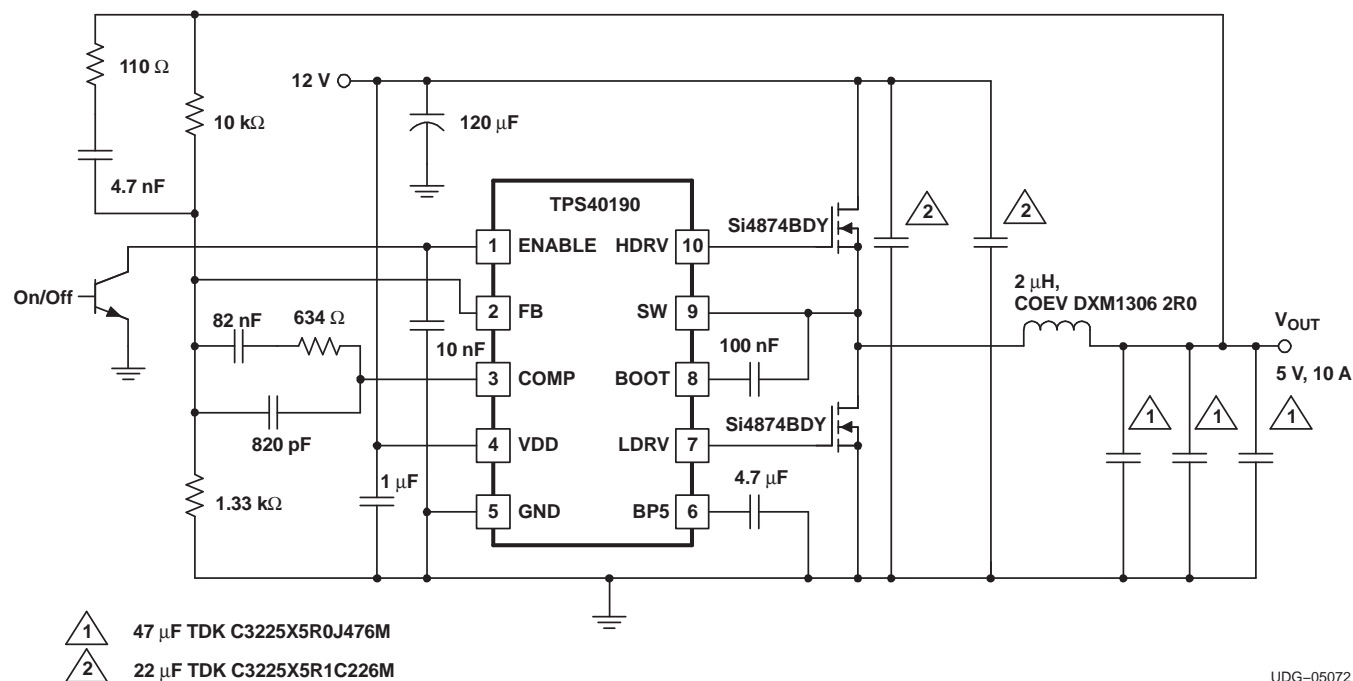

UDG-05072

Figure 29. 12-V to 5-V at 10 A

Typical Applications (continued)

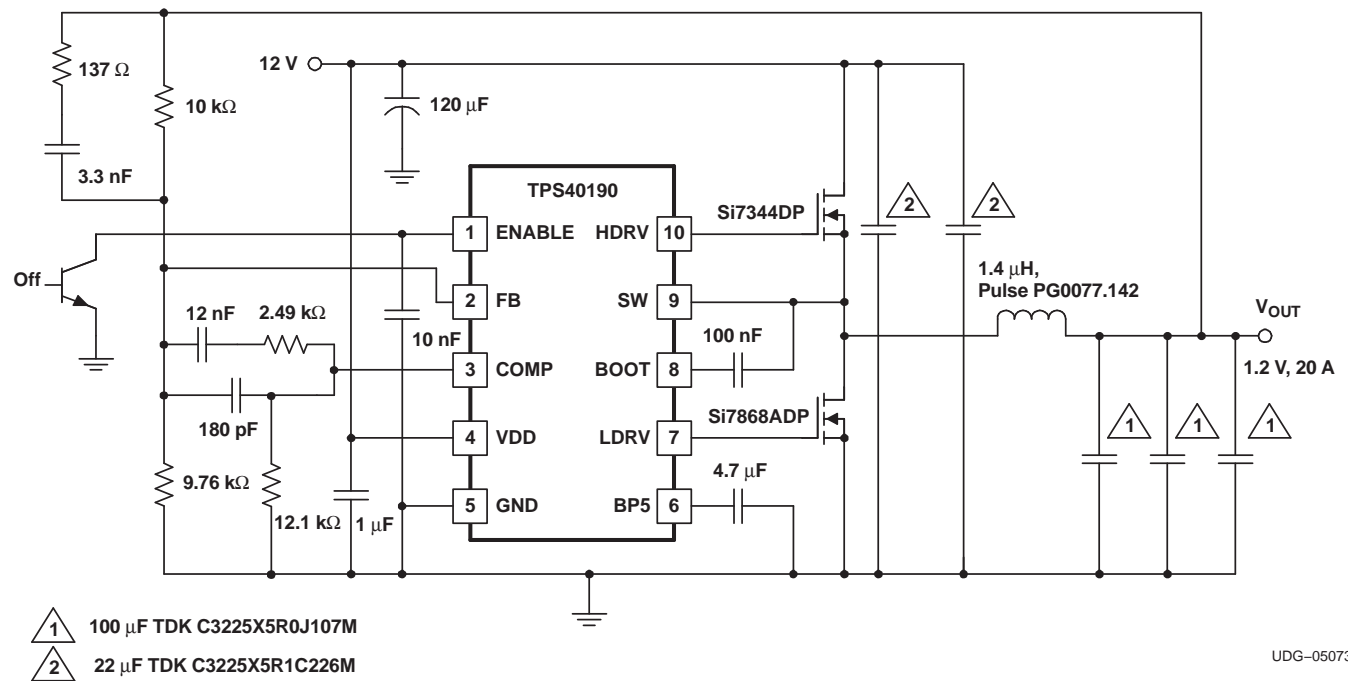

Figure 30. 12-V to 1.2-V at 20 A

Typical Applications (continued)

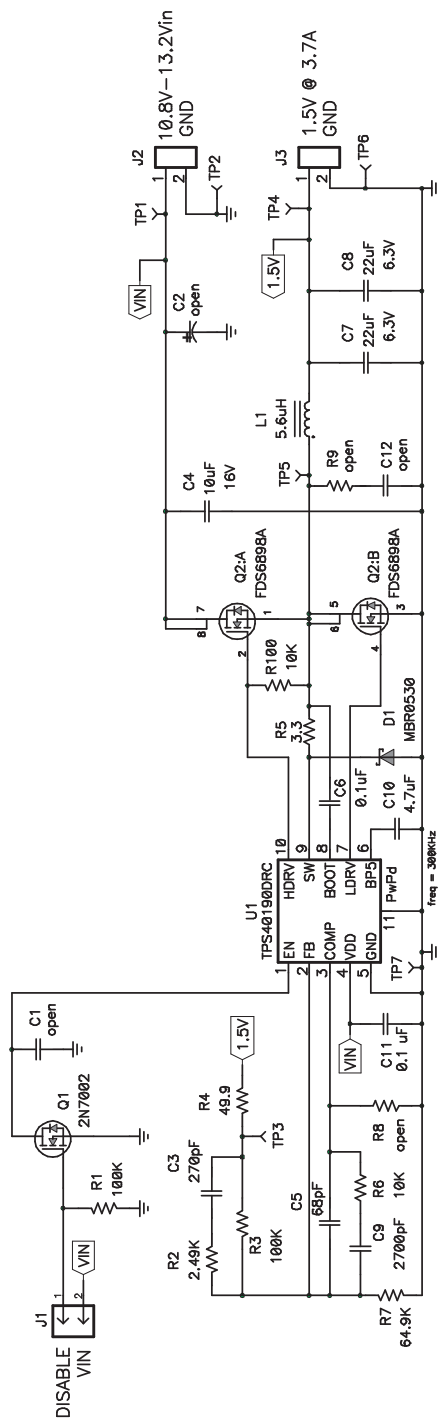

Figure 31. PMP1285, 12-V to 1.5-V, at 3.7 A

## 9 器件和文档支持

### 9.1 文档支持

#### 9.1.1 相关文档

请参阅如下相关文档：

- TI 应用报告，《启用多个 TPS4019x 器件》，[SLVA509](#)

### 9.2 接收文档更新通知

要接收文档更新通知，请导航至 [TI.com.cn](http://TI.com.cn) 上的器件产品文件夹。单击右上角的 [通知我](#) 进行注册，即可每周接收产品信息更改摘要。有关更改的详细信息，请查看任何已修订文档中包含的修订历史记录。

### 9.3 社区资源

The following links connect to TI community resources. Linked contents are provided "AS IS" by the respective contributors. They do not constitute TI specifications and do not necessarily reflect TI's views; see TI's [Terms of Use](#).

**TI E2E™ Online Community** *TI's Engineer-to-Engineer (E2E) Community*. Created to foster collaboration among engineers. At [e2e.ti.com](http://e2e.ti.com), you can ask questions, share knowledge, explore ideas and help solve problems with fellow engineers.

**Design Support** *TI's Design Support* Quickly find helpful E2E forums along with design support tools and contact information for technical support.

### 9.4 商标

E2E is a trademark of Texas Instruments.

All other trademarks are the property of their respective owners.

### 9.5 静电放电警告



这些装置包含有限的内置 ESD 保护。存储或装卸时，应将导线一起截短或将装置放置于导电泡棉中，以防止 MOS 门极遭受静电损伤。

### 9.6 Glossary

[SLYZ022](#) — *TI Glossary*.

This glossary lists and explains terms, acronyms, and definitions.

## 10 机械、封装和可订购信息

以下页面包含机械、封装和可订购信息。这些信息是指定器件的最新可用数据。数据如有变更，恕不另行通知，且不会对此文档进行修订。如需获取此数据表的浏览器版本，请查阅左侧的导航栏。

**PACKAGING INFORMATION**

Orderable part number	Status (1)	Material type (2)	Package   Pins	Package qty   Carrier	RoHS (3)	Lead finish/ Ball material (4)	MSL rating/ Peak reflow (5)	Op temp (°C)	Part marking (6)
<a href="#">TPS40190DRCR</a>	Active	Production	VSON (DRC)   10	3000   LARGE T&R	Yes	NIPDAU   NIPDAUAG	Level-2-260C-1 YEAR	-40 to 85	0190
TPS40190DRCR.A	Active	Production	VSON (DRC)   10	3000   LARGE T&R	Yes	NIPDAU	Level-2-260C-1 YEAR	-40 to 85	0190
TPS40190DRCR.B	Active	Production	VSON (DRC)   10	3000   LARGE T&R	Yes	NIPDAU	Level-2-260C-1 YEAR	-40 to 85	0190
TPS40190DRCRG4	Active	Production	VSON (DRC)   10	3000   LARGE T&R	Yes	NIPDAU	Level-2-260C-1 YEAR	-40 to 85	0190
<a href="#">TPS40190DRCT</a>	Active	Production	VSON (DRC)   10	250   SMALL T&R	Yes	NIPDAU	Level-1-260C-UNLIM	-40 to 85	0190
TPS40190DRCT.A	Active	Production	VSON (DRC)   10	250   SMALL T&R	Yes	NIPDAU	Level-1-260C-UNLIM	-40 to 85	0190
TPS40190DRCT.B	Active	Production	VSON (DRC)   10	250   SMALL T&R	Yes	NIPDAU	Level-1-260C-UNLIM	-40 to 85	0190
TPS40190DRCTG4	Active	Production	VSON (DRC)   10	250   SMALL T&R	Yes	NIPDAU	Level-1-260C-UNLIM	-40 to 85	0190

(1) **Status:** For more details on status, see our [product life cycle](#).

(2) **Material type:** When designated, preproduction parts are prototypes/experimental devices, and are not yet approved or released for full production. Testing and final process, including without limitation quality assurance, reliability performance testing, and/or process qualification, may not yet be complete, and this item is subject to further changes or possible discontinuation. If available for ordering, purchases will be subject to an additional waiver at checkout, and are intended for early internal evaluation purposes only. These items are sold without warranties of any kind.

(3) **RoHS values:** Yes, No, RoHS Exempt. See the [TI RoHS Statement](#) for additional information and value definition.

(4) **Lead finish/Ball material:** Parts may have multiple material finish options. Finish options are separated by a vertical ruled line. Lead finish/Ball material values may wrap to two lines if the finish value exceeds the maximum column width.

(5) **MSL rating/Peak reflow:** The moisture sensitivity level ratings and peak solder (reflow) temperatures. In the event that a part has multiple moisture sensitivity ratings, only the lowest level per JEDEC standards is shown. Refer to the shipping label for the actual reflow temperature that will be used to mount the part to the printed circuit board.

(6) **Part marking:** There may be an additional marking, which relates to the logo, the lot trace code information, or the environmental category of the part.

Multiple part markings will be inside parentheses. Only one part marking contained in parentheses and separated by a "-" will appear on a part. If a line is indented then it is a continuation of the previous line and the two combined represent the entire part marking for that device.

**Important Information and Disclaimer:** The information provided on this page represents TI's knowledge and belief as of the date that it is provided. TI bases its knowledge and belief on information provided by third parties, and makes no representation or warranty as to the accuracy of such information. Efforts are underway to better integrate information from third parties. TI has taken and continues to take reasonable steps to provide representative and accurate information but may not have conducted destructive testing or chemical analysis on incoming materials and chemicals. TI and TI suppliers consider certain information to be proprietary, and thus CAS numbers and other limited information may not be available for release.

In no event shall TI's liability arising out of such information exceed the total purchase price of the TI part(s) at issue in this document sold by TI to Customer on an annual basis.

## TAPE AND REEL INFORMATION



### QUADRANT ASSIGNMENTS FOR PIN 1 ORIENTATION IN TAPE



\*All dimensions are nominal

Device	Package Type	Package Drawing	Pins	SPQ	Reel Diameter (mm)	Reel Width W1 (mm)	A0 (mm)	B0 (mm)	K0 (mm)	P1 (mm)	W (mm)	Pin1 Quadrant
TPS40190DRCR	VSON	DRC	10	3000	330.0	12.4	3.3	3.3	1.0	8.0	12.0	Q2
TPS40190DRCR	VSON	DRC	10	3000	330.0	12.4	3.3	3.3	1.1	8.0	12.0	Q2
TPS40190DRCT	VSON	DRC	10	250	180.0	12.4	3.3	3.3	1.1	8.0	12.0	Q2

## TAPE AND REEL BOX DIMENSIONS



\*All dimensions are nominal

Device	Package Type	Package Drawing	Pins	SPQ	Length (mm)	Width (mm)	Height (mm)
TPS40190DRCR	VSON	DRC	10	3000	367.0	367.0	38.0
TPS40190DRCR	VSON	DRC	10	3000	346.0	346.0	33.0
TPS40190DRCT	VSON	DRC	10	250	182.0	182.0	20.0



## GENERIC PACKAGE VIEW

**DRC 10**

**VSON - 1 mm max height**

3 x 3, 0.5 mm pitch

PLASTIC SMALL OUTLINE - NO LEAD

This image is a representation of the package family, actual package may vary.  
Refer to the product data sheet for package details.



4226193/A

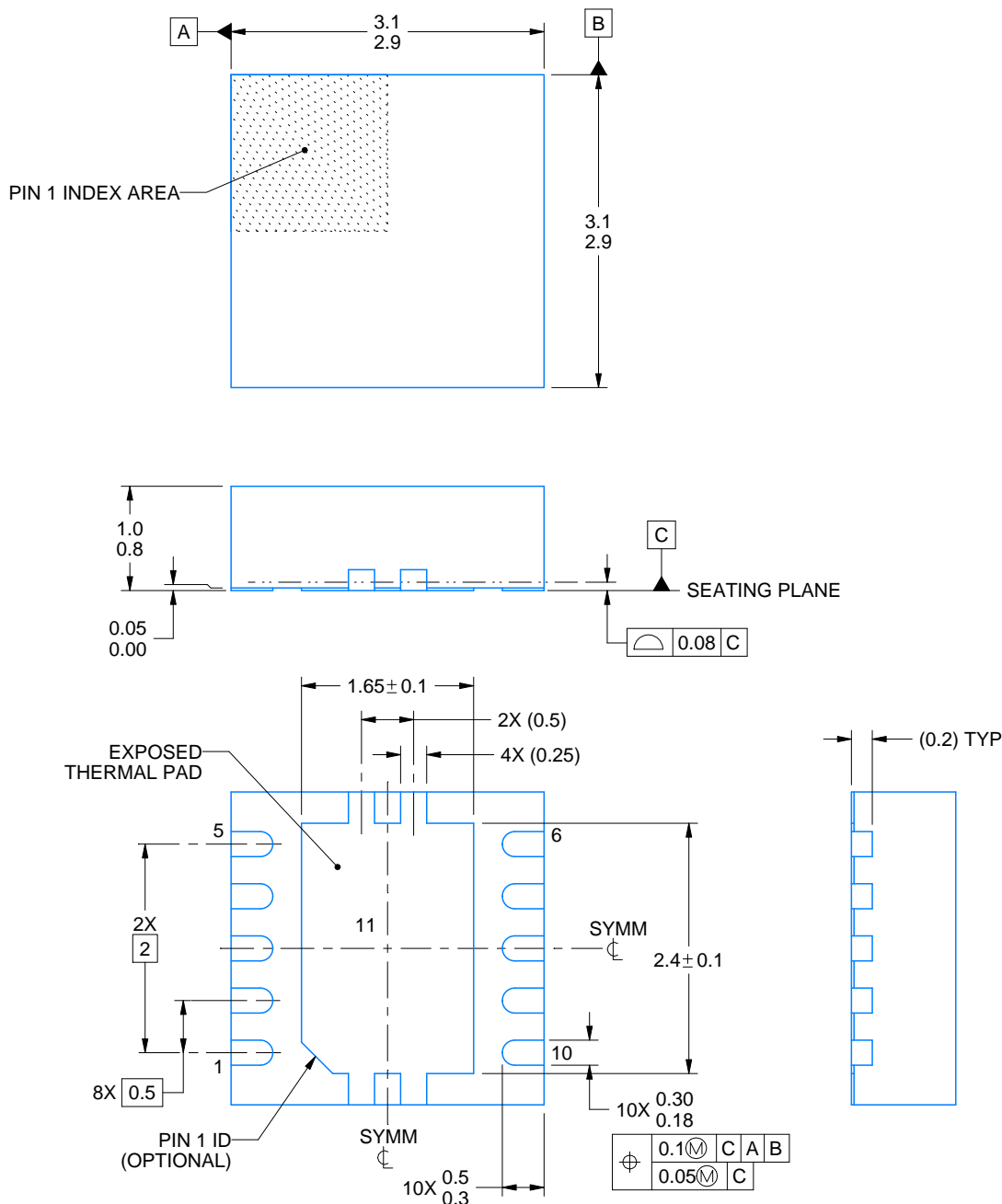

4218878/B 07/2018

NOTES:

1. All linear dimensions are in millimeters. Any dimensions in parenthesis are for reference only. Dimensioning and tolerancing per ASME Y14.5M.
2. This drawing is subject to change without notice.
3. The package thermal pad must be soldered to the printed circuit board for optimal thermal and mechanical performance.

# EXAMPLE BOARD LAYOUT

DRC0010J

VSON - 1 mm max height

PLASTIC SMALL OUTLINE - NO LEAD



LAND PATTERN EXAMPLE  
EXPOSED METAL SHOWN  
SCALE:20X



SOLDER MASK DETAILS

4218878/B 07/2018

NOTES: (continued)

4. This package is designed to be soldered to a thermal pad on the board. For more information, see Texas Instruments literature number SLUA271 ([www.ti.com/lit/sluea271](http://www.ti.com/lit/sluea271)).
5. Vias are optional depending on application, refer to device data sheet. If any vias are implemented, refer to their locations shown on this view. It is recommended that vias under paste be filled, plugged or tented.

# EXAMPLE STENCIL DESIGN

DRC0010J

VSON - 1 mm max height

PLASTIC SMALL OUTLINE - NO LEAD



SOLDER PASTE EXAMPLE  
BASED ON 0.125 mm THICK STENCIL

EXPOSED PAD 11:  
80% PRINTED SOLDER COVERAGE BY AREA  
SCALE:25X

4218878/B 07/2018

NOTES: (continued)

6. Laser cutting apertures with trapezoidal walls and rounded corners may offer better paste release. IPC-7525 may have alternate design recommendations.

## 重要通知和免责声明

TI“按原样”提供技术和可靠性数据（包括数据表）、设计资源（包括参考设计）、应用或其他设计建议、网络工具、安全信息和其他资源，不保证没有瑕疵且不做任何明示或暗示的担保，包括但不限于对适销性、与某特定用途的适用性或不侵犯任何第三方知识产权的暗示担保。

这些资源可供使用 TI 产品进行设计的熟练开发人员使用。您将自行承担以下全部责任：(1) 针对您的应用选择合适的 TI 产品，(2) 设计、验证并测试您的应用，(3) 确保您的应用满足相应标准以及任何其他安全、安保法规或其他要求。

这些资源如有变更，恕不另行通知。TI 授权您仅可将这些资源用于研发本资源所述的 TI 产品的相关应用。严禁以其他方式对这些资源进行复制或展示。您无权使用任何其他 TI 知识产权或任何第三方知识产权。对于因您对这些资源的使用而对 TI 及其代表造成的任何索赔、损害、成本、损失和债务，您将全额赔偿，TI 对此概不负责。

TI 提供的产品受 [TI 销售条款](#)、[TI 通用质量指南](#) 或 [ti.com](#) 上其他适用条款或 TI 产品随附的其他适用条款的约束。TI 提供这些资源并不会扩展或以其他方式更改 TI 针对 TI 产品发布的适用的担保或担保免责声明。除非德州仪器 (TI) 明确将某产品指定为定制产品或客户特定产品，否则其产品均为按确定价格收入目录的标准通用器件。

TI 反对并拒绝您可能提出的任何其他或不同的条款。

版权所有 © 2025，德州仪器 (TI) 公司

最后更新日期：2025 年 10 月