

TPS53659 Dual-Channel (4-Phase + 1-Phase) or (3-Phase + 2-Phase) D-CAP+™ Step-Down Multiphase Controller with NVM and PMBus™ for VR13 Server Memory

1 Device Overview

1.1 Features

- Full VR13 Server Feature Set Including Digital Input Power Monitor
- Programmable Loop Compensations
- Configurable with Non-Volatile Memory (NVM) for Low External Component Counts
- Individual Phase Current Calibrations and Reports
- Dynamic Phase Shedding with Programmable Current Threshold for Optimizing Efficiency at Light and Heavy Loads
- Fast Phase-Adding for Undershoot Reduction (USR)
- Backward VR12.0 and VR12.5 Compatible
- 8-Bit DAC with Selectable 5 mV or 10 mV Resolution and Output Ranges from 0.25 V to 1.52 V or 0.5 V to 2.8125 V for Dual Channels
- Driverless Configuration for Efficient High-Frequency Switching
- Fully Compatible with TI NextFET™ Power Stage for High-Density Solutions
- Accurate, Adjustable Voltage Positioning
- Frequency Selections with Closed-loop Frequency Control: 300 kHz to 1 MHz
- Patented AutoBalance™ Phase Balancing
- Selectable, 16-level Per-Phase Current Limit
- PMBus™ System Interface for Telemetry of Voltage, Current, Power, Temperature, and Fault Conditions
- Dynamic Output Voltage Transitions with Programmable Slew Rates via SVID or PMBus Interface
- Conversion Voltage Range: 4.5 V to 17 V
- Low Quiescent Current
- 5 mm x 5 mm, 40-Pin, WQFN PowerPad™ Package

1.2 Applications

- VR13 Memory Power of Server and Telecom Applications
- ASIC Needs Dual Power Rails
- High-Performance Processor Power

1.3 Description

The TPS53659 is a fully VR13 SVID compliant step-down controller with dual channels, built-in non-volatile memory (NVM), and PMBus™ interface, and is fully compatible with TI NexFET™ power stage. Advanced control features such as D-CAP+™ architecture with undershoot reduction (USR) provide fast transient response, low output capacitance, and good current sharing. The device also provides novel phase interleaving strategy and dynamic phase shedding for efficiency improvement at different loads. Adjustable control of V_{CORE} slew rate and voltage positioning round out the Intel® features. In addition, the device supports the PMBus communication interface for reporting the telemetry of voltage, current, power, temperature, and fault conditions to the systems. All programmable parameters can be configured by the PMBus interface and can be stored in NVM as the new default values to minimize the external component count.

The TPS53659 device is offered in a thermally enhanced 40-pin WQFN package and is rated to operate from –40°C to 125°C.

Table 1-1. Device Information⁽¹⁾

PART NUMBER	PACKAGE	BODY SIZE
TPS53659	WQFN (40)	5 mm x 5 mm

(1) For more information, see, *Mechanical, Packaging, and Orderable Information*.



Table of Contents

1	Device Overview	1			
	1.1 Features	1		3.1 Receiving Notification of Documentation Updates ...	4
	1.2 Applications	1		3.2 Community Resources	4
	1.3 Description	1		3.3 Trademarks	4
2	Revision History	3		3.4 Electrostatic Discharge Caution	4
3	Device and Documentation Support	4	4	3.5 Glossary	4
				Mechanical, Packaging, and Orderable Information	5

2 Revision History

NOTE: Page numbers for previous revisions may differ from page numbers in the current version.

DATE	REVISION	NOTES
November 2016	*	Initial release.

3 Device and Documentation Support

3.1 Receiving Notification of Documentation Updates

To receive notification of documentation updates, navigate to the device product folder on ti.com. In the upper right corner, click on *Alert me* to register and receive a weekly digest of any product information that has changed. For change details, review the revision history included in any revised document.

3.2 Community Resources

The following links connect to TI community resources. Linked contents are provided "AS IS" by the respective contributors. They do not constitute TI specifications and do not necessarily reflect TI's views; see TI's [Terms of Use](#).

TI E2E™ Online Community *TI's Engineer-to-Engineer (E2E) Community*. Created to foster collaboration among engineers. At e2e.ti.com, you can ask questions, share knowledge, explore ideas and help solve problems with fellow engineers.

Design Support *TI's Design Support* Quickly find helpful E2E forums along with design support tools and contact information for technical support.

3.3 Trademarks

NextFET, AutoBalance, PowerPad, PMBus, NexFET, D-CAP+, E2E are trademarks of Texas Instruments. Intel is a registered trademark of Intel. PMBus is a trademark of SMIF, Inc..

3.4 Electrostatic Discharge Caution



This integrated circuit can be damaged by ESD. Texas Instruments recommends that all integrated circuits be handled with appropriate precautions. Failure to observe proper handling and installation procedures can cause damage.

ESD damage can range from subtle performance degradation to complete device failure. Precision integrated circuits may be more susceptible to damage because very small parametric changes could cause the device not to meet its published specifications.

3.5 Glossary

[SLYZ022](#) — *TI Glossary*.

This glossary lists and explains terms, acronyms, and definitions.

4 Mechanical, Packaging, and Orderable Information

The following pages include mechanical, packaging, and orderable information. This information is the most current data available for the designated devices. This data is subject to change without notice and revision of this document. For browser-based versions of this data sheet, refer to the left-hand navigation.

PACKAGING INFORMATION

Orderable part number	Status (1)	Material type (2)	Package Pins	Package qty Carrier	RoHS (3)	Lead finish/ Ball material (4)	MSL rating/ Peak reflow (5)	Op temp (°C)	Part marking (6)
TPS53659RSBR	Active	Production	WQFN (RSB) 40	3000 LARGE T&R	Yes	Call TI Nipdauag	Level-2-260C-1 YEAR	-40 to 125	TPS 53659
TPS53659RSBR.A	Active	Production	WQFN (RSB) 40	3000 LARGE T&R	Yes	Call TI	Level-2-260C-1 YEAR	-40 to 125	TPS 53659
TPS53659RSBR.B	Active	Production	WQFN (RSB) 40	3000 LARGE T&R	Yes	Call TI	Level-2-260C-1 YEAR	-40 to 125	TPS 53659
TPS53659RSBT	Active	Production	WQFN (RSB) 40	250 SMALL T&R	Yes	NIPDAUAG	Level-2-260C-1 YEAR	-40 to 125	TPS 53659
TPS53659RSBT.A	Active	Production	WQFN (RSB) 40	250 SMALL T&R	Yes	NIPDAUAG	Level-2-260C-1 YEAR	-40 to 125	TPS 53659
TPS53659RSBT.B	Active	Production	WQFN (RSB) 40	250 SMALL T&R	Yes	NIPDAUAG	Level-2-260C-1 YEAR	-40 to 125	TPS 53659

(1) **Status:** For more details on status, see our [product life cycle](#).

(2) **Material type:** When designated, preproduction parts are prototypes/experimental devices, and are not yet approved or released for full production. Testing and final process, including without limitation quality assurance, reliability performance testing, and/or process qualification, may not yet be complete, and this item is subject to further changes or possible discontinuation. If available for ordering, purchases will be subject to an additional waiver at checkout, and are intended for early internal evaluation purposes only. These items are sold without warranties of any kind.

(3) **RoHS values:** Yes, No, RoHS Exempt. See the [TI RoHS Statement](#) for additional information and value definition.

(4) **Lead finish/Ball material:** Parts may have multiple material finish options. Finish options are separated by a vertical ruled line. Lead finish/Ball material values may wrap to two lines if the finish value exceeds the maximum column width.

(5) **MSL rating/Peak reflow:** The moisture sensitivity level ratings and peak solder (reflow) temperatures. In the event that a part has multiple moisture sensitivity ratings, only the lowest level per JEDEC standards is shown. Refer to the shipping label for the actual reflow temperature that will be used to mount the part to the printed circuit board.

(6) **Part marking:** There may be an additional marking, which relates to the logo, the lot trace code information, or the environmental category of the part.

Multiple part markings will be inside parentheses. Only one part marking contained in parentheses and separated by a "~" will appear on a part. If a line is indented then it is a continuation of the previous line and the two combined represent the entire part marking for that device.

Important Information and Disclaimer: The information provided on this page represents TI's knowledge and belief as of the date that it is provided. TI bases its knowledge and belief on information provided by third parties, and makes no representation or warranty as to the accuracy of such information. Efforts are underway to better integrate information from third parties. TI has taken and continues to take reasonable steps to provide representative and accurate information but may not have conducted destructive testing or chemical analysis on incoming materials and chemicals. TI and TI suppliers consider certain information to be proprietary, and thus CAS numbers and other limited information may not be available for release.

In no event shall TI's liability arising out of such information exceed the total purchase price of the TI part(s) at issue in this document sold by TI to Customer on an annual basis.

TAPE AND REEL INFORMATION

QUADRANT ASSIGNMENTS FOR PIN 1 ORIENTATION IN TAPE



*All dimensions are nominal

Device	Package Type	Package Drawing	Pins	SPQ	Reel Diameter (mm)	Reel Width W1 (mm)	A0 (mm)	B0 (mm)	K0 (mm)	P1 (mm)	W (mm)	Pin1 Quadrant
TPS53659RSBR	WQFN	RSB	40	3000	330.0	12.4	5.3	5.3	1.1	8.0	12.0	Q2
TPS53659RSBT	WQFN	RSB	40	250	180.0	12.4	5.3	5.3	1.1	8.0	12.0	Q2

TAPE AND REEL BOX DIMENSIONS

*All dimensions are nominal

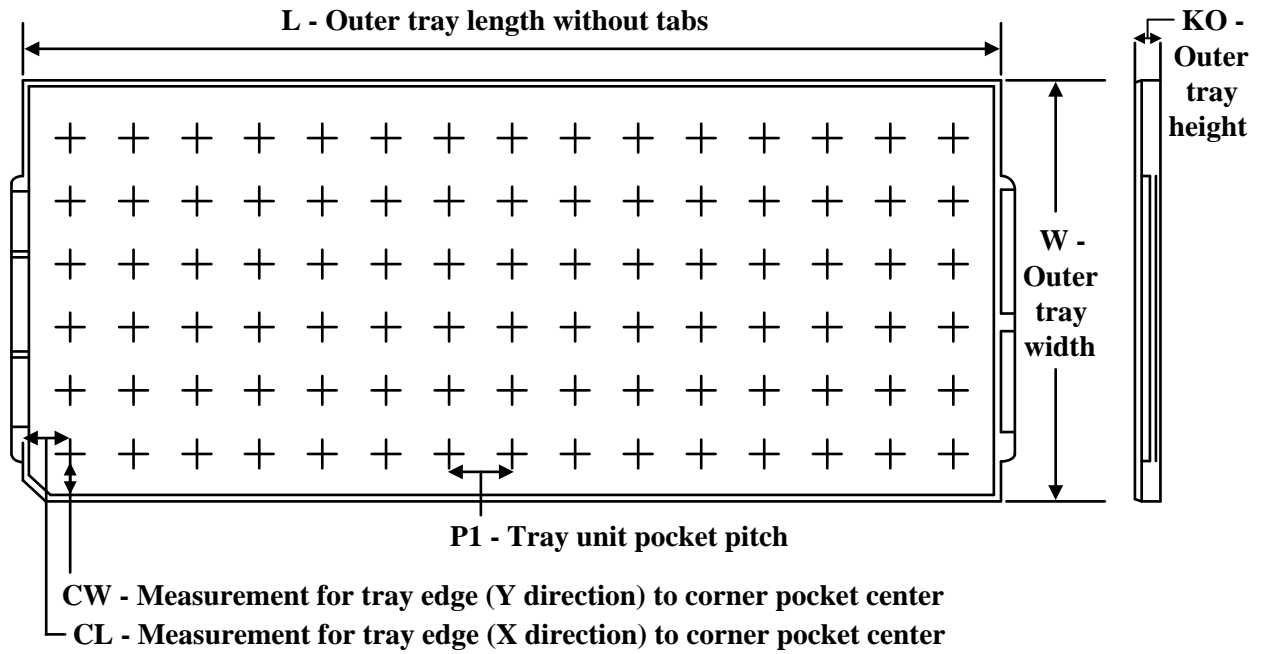
Device	Package Type	Package Drawing	Pins	SPQ	Length (mm)	Width (mm)	Height (mm)
TPS53659RSBR	WQFN	RSB	40	3000	346.0	346.0	33.0
TPS53659RSBT	WQFN	RSB	40	250	210.0	185.0	35.0

TRAY

Chamfer on Tray corner indicates Pin 1 orientation of packed units.

*All dimensions are nominal

Device	Package Name	Package Type	Pins	SPQ	Unit array matrix	Max temperature (°C)	L (mm)	W (mm)	K0 (µm)	P1 (mm)	CL (mm)	CW (mm)
TPS53659RSBT	RSB	WQFN	40	250	35 X 14	150	322.6	135.9	7620	8.8	7.9	8.15
TPS53659RSBT.A	RSB	WQFN	40	250	35 X 14	150	322.6	135.9	7620	8.8	7.9	8.15
TPS53659RSBT.B	RSB	WQFN	40	250	35 X 14	150	322.6	135.9	7620	8.8	7.9	8.15

RSB0040F

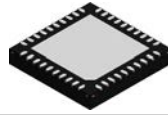

PACKAGE OUTLINE

WQFN - 0.8 mm max height

PLASTIC QUAD FLATPACK - NO LEAD

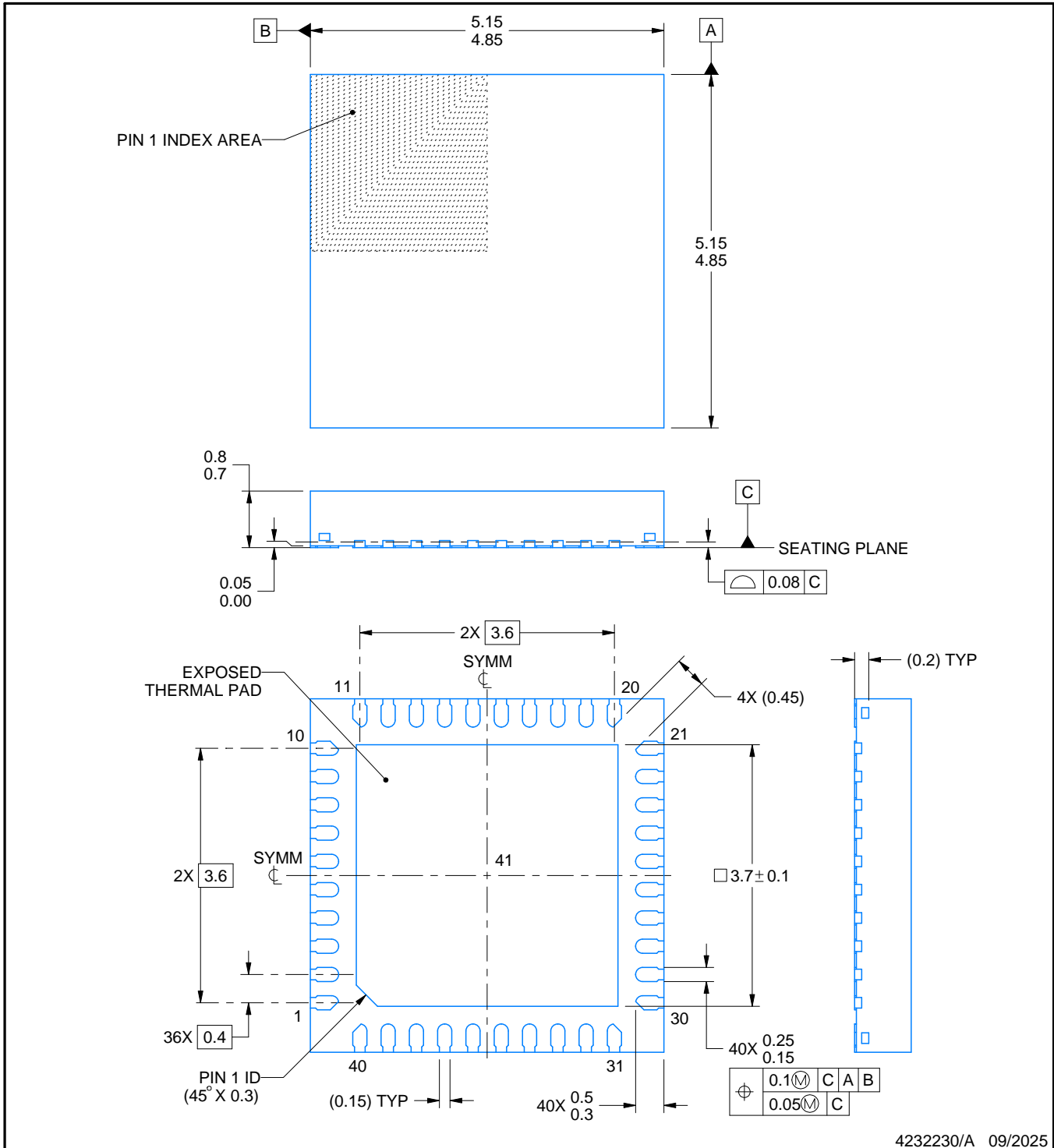

4232230/A 09/2025

NOTES:

1. All linear dimensions are in millimeters. Any dimensions in parenthesis are for reference only. Dimensioning and tolerancing per ASME Y14.5M.
2. This drawing is subject to change without notice.
3. The package thermal pad must be soldered to the printed circuit board for thermal and mechanical performance.

EXAMPLE BOARD LAYOUT

RSB0040F

WQFN - 0.8 mm max height

PLASTIC QUAD FLATPACK - NO LEAD

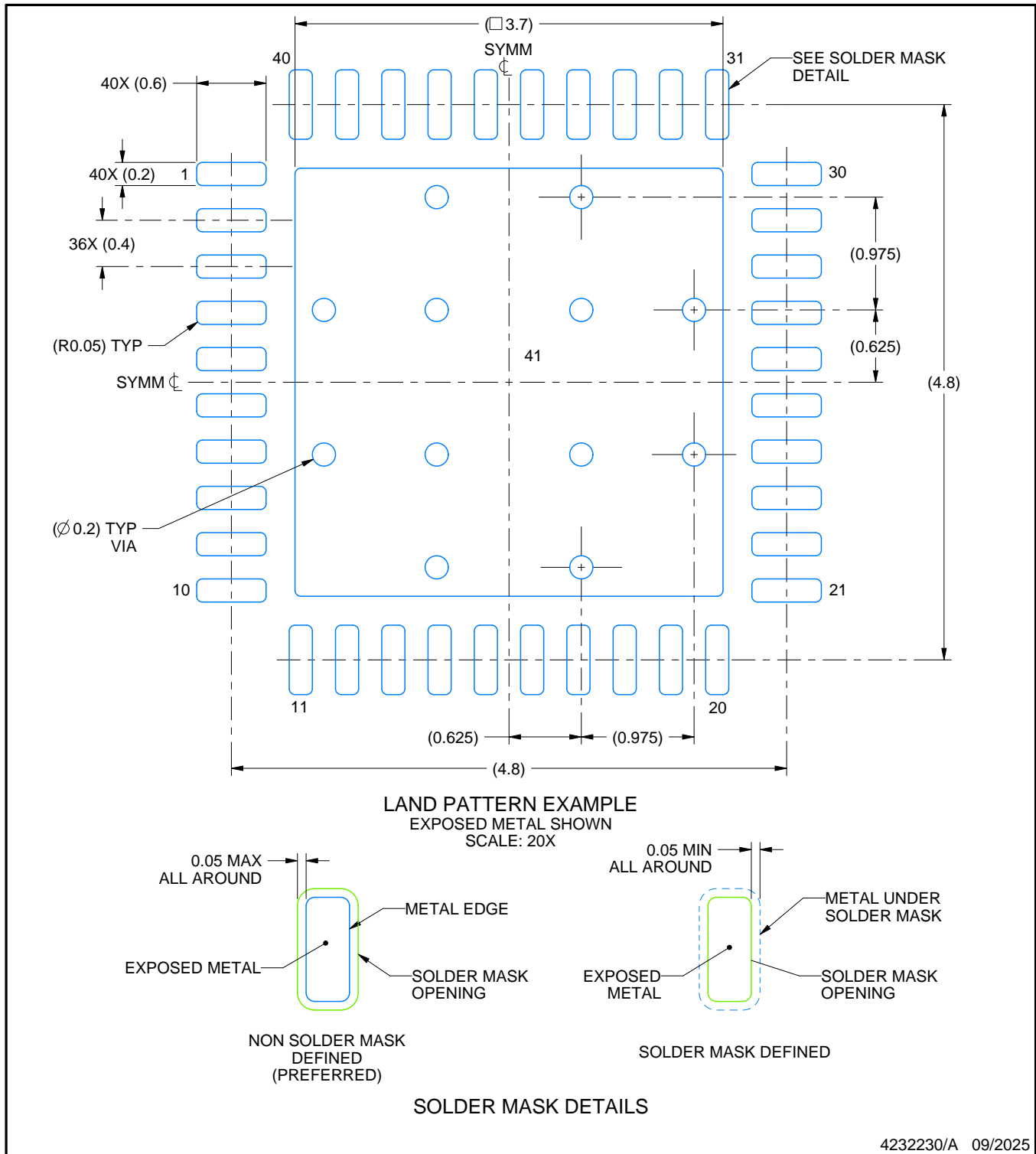

4232230/A 09/2025

NOTES: (continued)

4. This package is designed to be soldered to a thermal pad on the board. For more information, see Texas Instruments literature number SLUA271 (www.ti.com/lit/slua271).
5. Vias are optional depending on application, refer to device data sheet. If any vias are implemented, refer to their locations shown on this view. It is recommended that vias under paste be filled, plugged or tented.

EXAMPLE STENCIL DESIGN

RSB0040F

WQFN - 0.8 mm max height

PLASTIC QUAD FLATPACK - NO LEAD

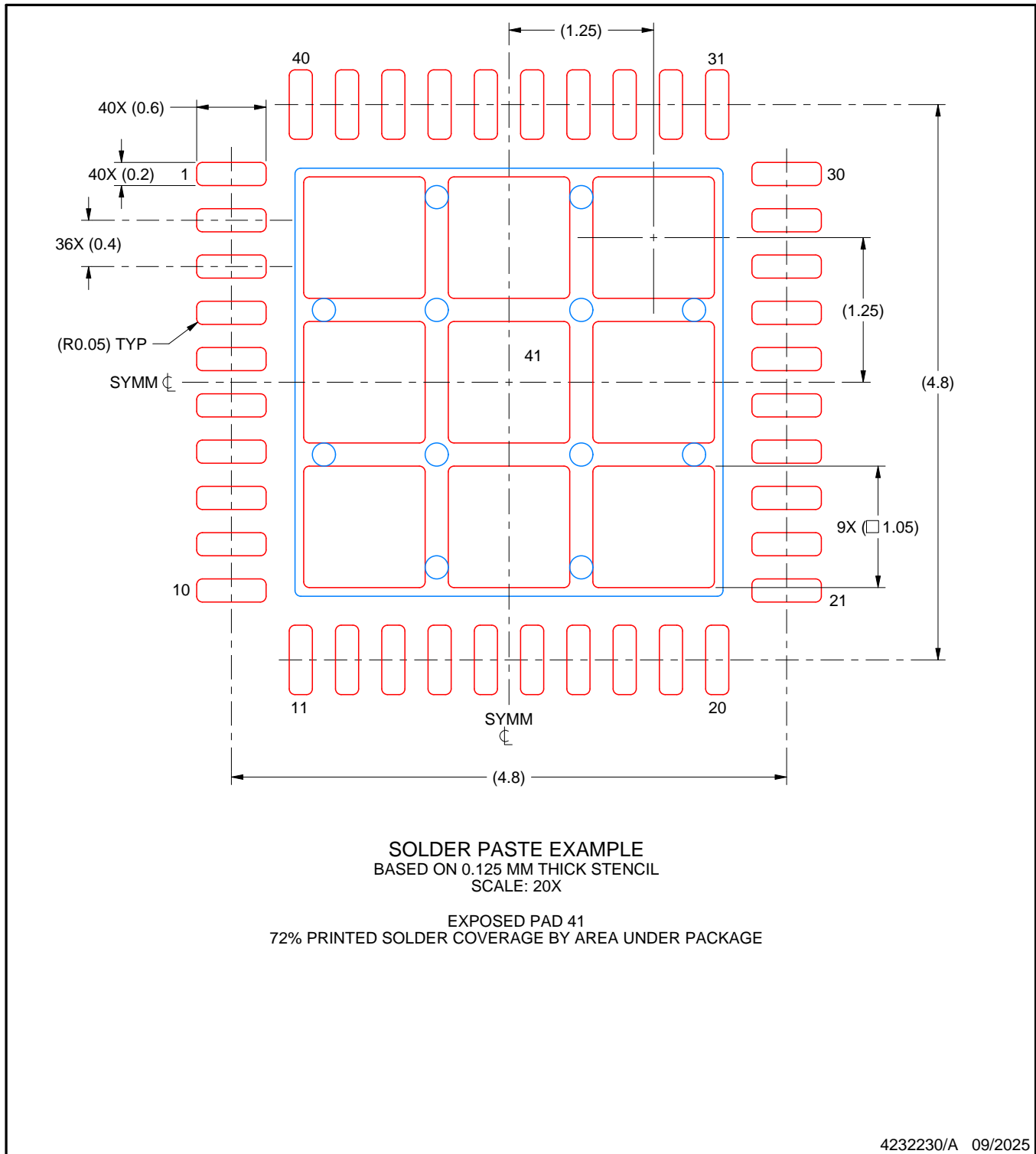

NOTES: (continued)

6. Laser cutting apertures with trapezoidal walls and rounded corners may offer better paste release. IPC-7525 may have alternate design recommendations.

RSB0040E

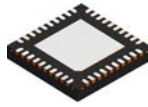

PACKAGE OUTLINE

WQFN - 0.8 mm max height

PLASTIC QUAD FLATPACK - NO LEAD

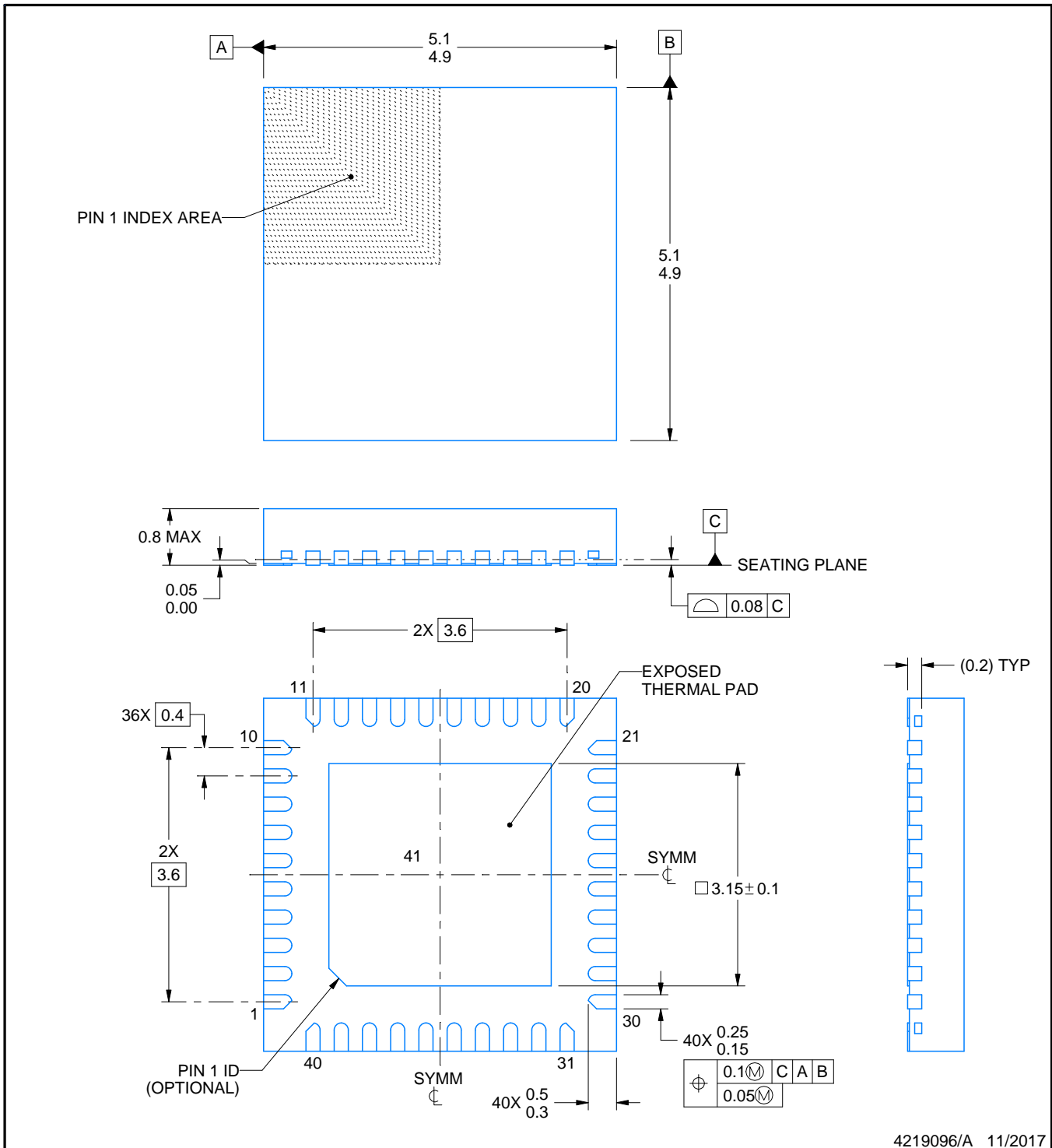

4219096/A 11/2017

NOTES:

1. All linear dimensions are in millimeters. Any dimensions in parenthesis are for reference only. Dimensioning and tolerancing per ASME Y14.5M.
2. This drawing is subject to change without notice.
3. The package thermal pad must be soldered to the printed circuit board for thermal and mechanical performance.

EXAMPLE BOARD LAYOUT

RSB0040E

WQFN - 0.8 mm max height

PLASTIC QUAD FLATPACK - NO LEAD

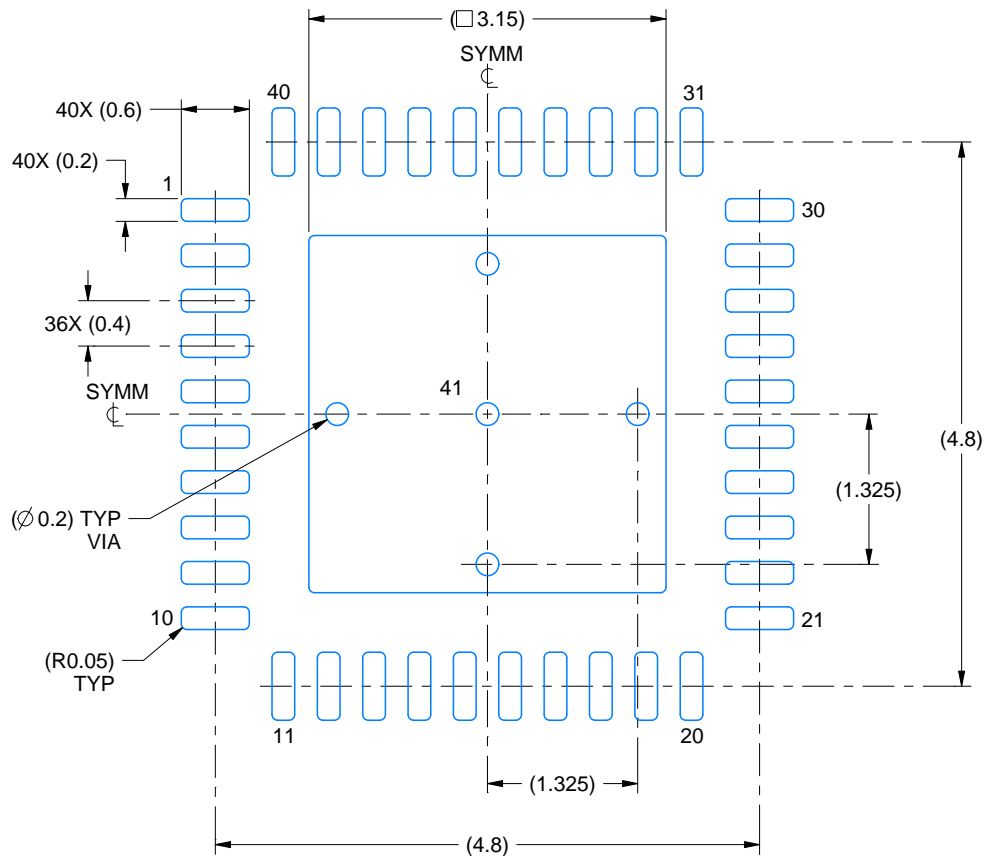

LAND PATTERN EXAMPLE
EXPOSED METAL SHOWN
SCALE:15X

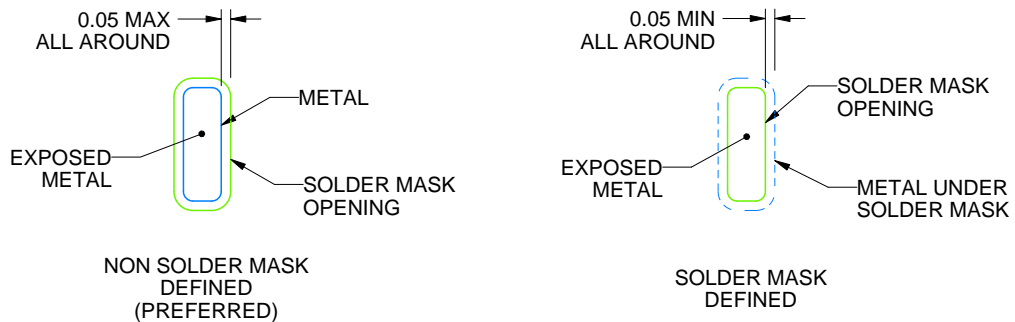

SOLDER MASK DETAILS

4219096/A 11/2017

NOTES: (continued)

- This package is designed to be soldered to a thermal pad on the board. For more information, see Texas Instruments literature number SLUA271 (www.ti.com/lit/slua271).
- Vias are optional depending on application, refer to device data sheet. If any vias are implemented, refer to their locations shown on this view. It is recommended that vias under paste be filled, plugged or tented.

EXAMPLE STENCIL DESIGN

RSB0040E

WQFN - 0.8 mm max height

PLASTIC QUAD FLATPACK - NO LEAD

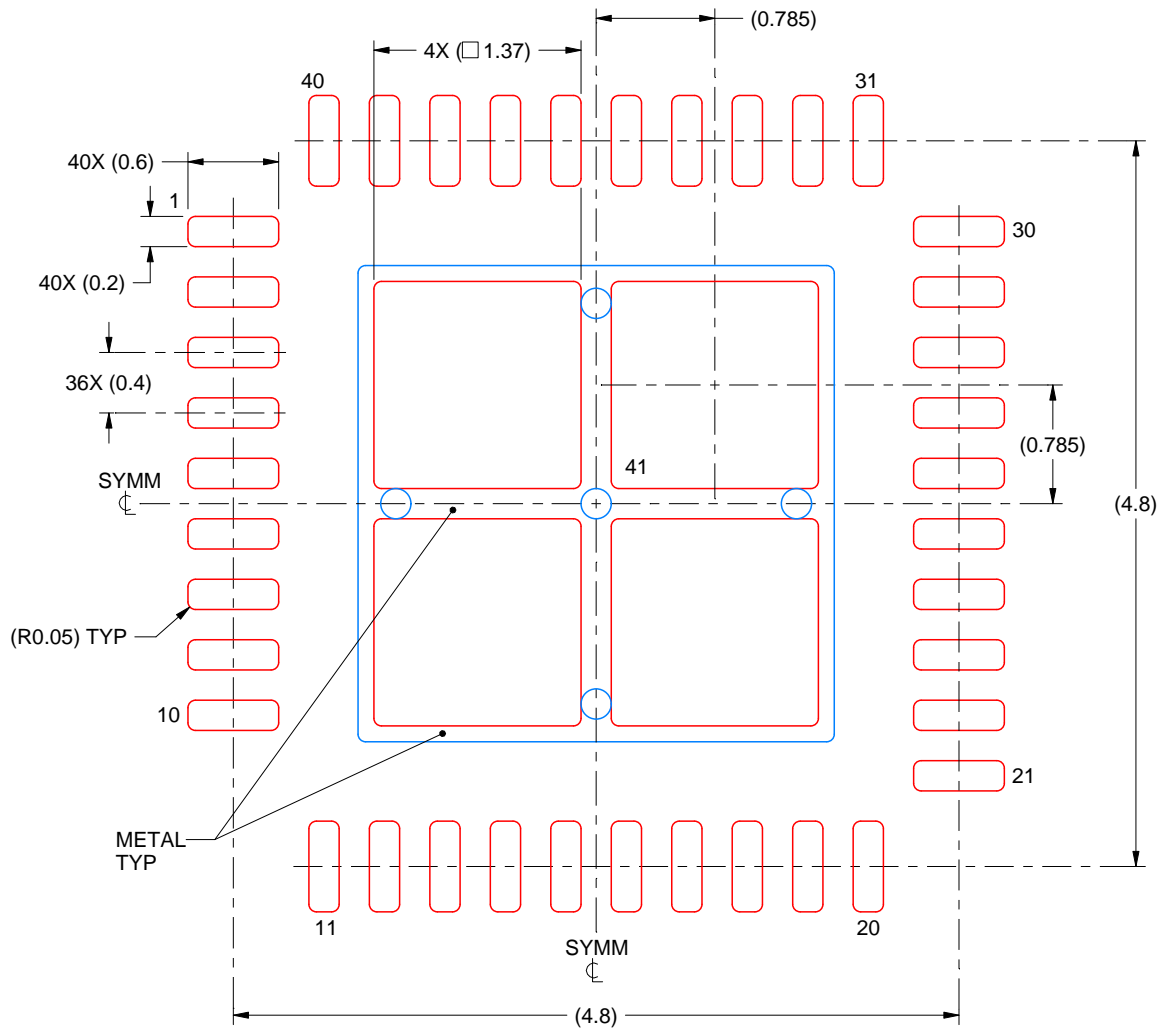

SOLDER PASTE EXAMPLE
BASED ON 0.1 mm THICK STENCIL

EXPOSED PAD 41
75% PRINTED SOLDER COVERAGE BY AREA UNDER PACKAGE
SCALE:20X

4219096/A 11/2017

NOTES: (continued)

6. Laser cutting apertures with trapezoidal walls and rounded corners may offer better paste release. IPC-7525 may have alternate design recommendations.

GENERIC PACKAGE VIEW

RSB 40

WQFN - 0.8 mm max height

5 x 5 mm, 0.4 mm pitch

PLASTIC QUAD FLATPACK - NO LEAD

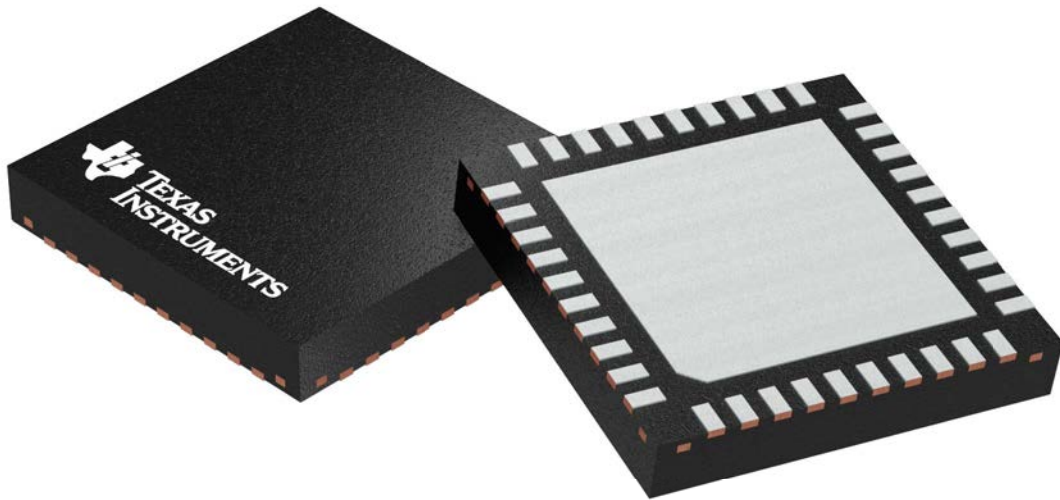

Images above are just a representation of the package family, actual package may vary.
Refer to the product data sheet for package details.

4207182/D

RSB0040E

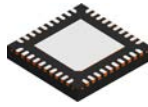

PACKAGE OUTLINE

WQFN - 0.8 mm max height

PLASTIC QUAD FLATPACK - NO LEAD

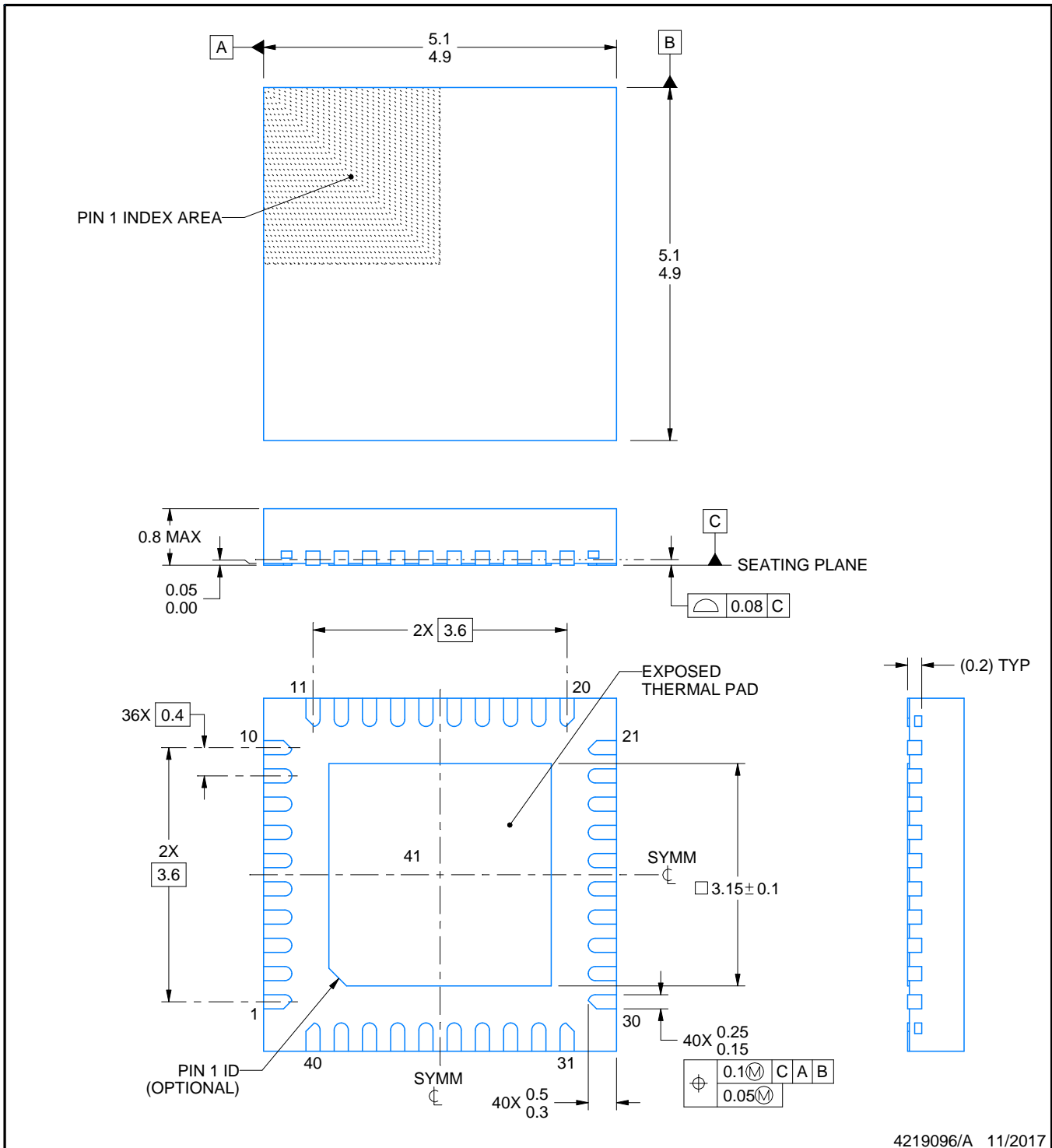

4219096/A 11/2017

NOTES:

1. All linear dimensions are in millimeters. Any dimensions in parenthesis are for reference only. Dimensioning and tolerancing per ASME Y14.5M.
2. This drawing is subject to change without notice.
3. The package thermal pad must be soldered to the printed circuit board for thermal and mechanical performance.

EXAMPLE BOARD LAYOUT

RSB0040E

WQFN - 0.8 mm max height

PLASTIC QUAD FLATPACK - NO LEAD

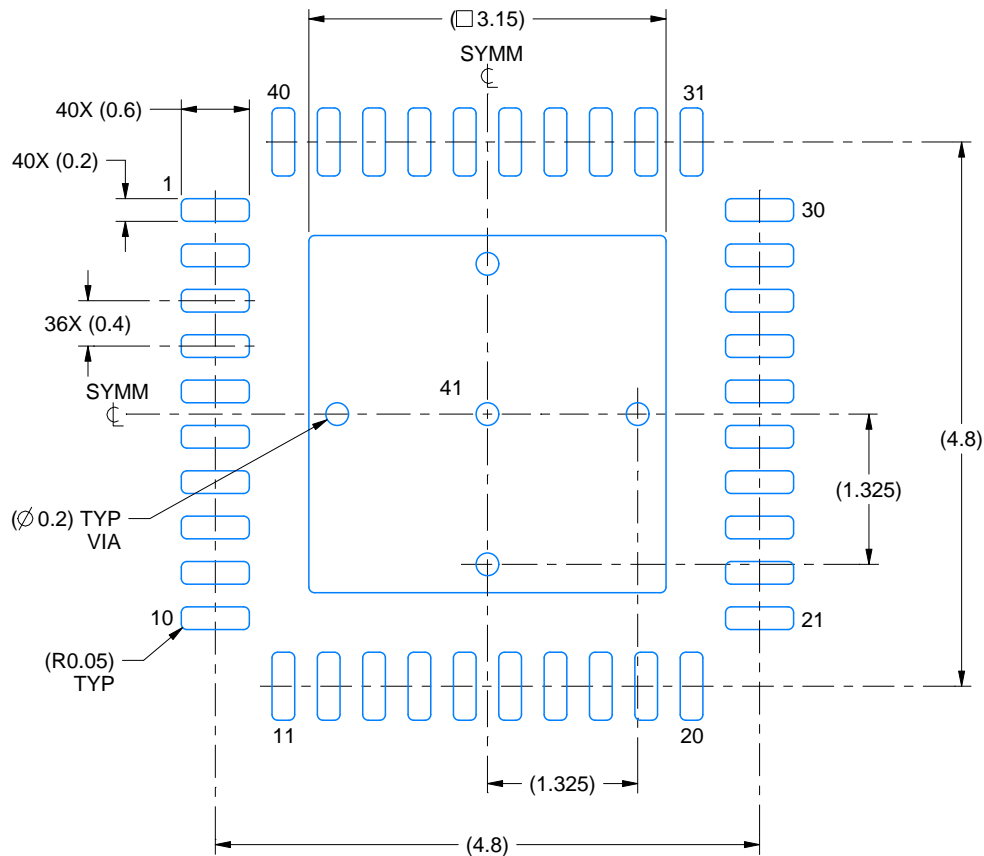

LAND PATTERN EXAMPLE
EXPOSED METAL SHOWN
SCALE:15X

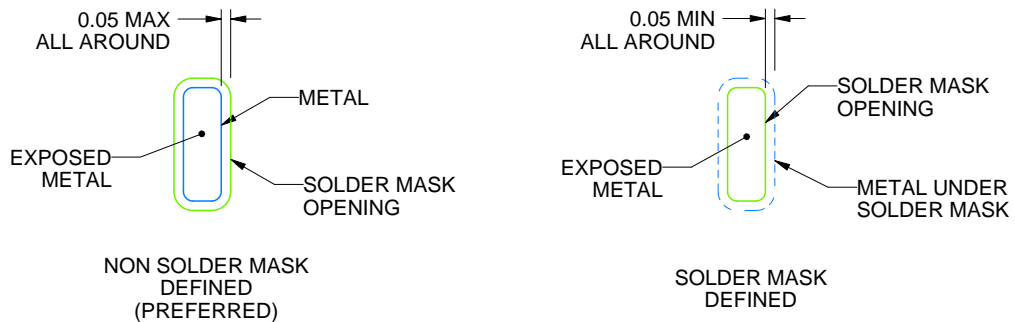

SOLDER MASK DETAILS

4219096/A 11/2017

NOTES: (continued)

4. This package is designed to be soldered to a thermal pad on the board. For more information, see Texas Instruments literature number SLUA271 (www.ti.com/lit/sluea271).
5. Vias are optional depending on application, refer to device data sheet. If any vias are implemented, refer to their locations shown on this view. It is recommended that vias under paste be filled, plugged or tented.

EXAMPLE STENCIL DESIGN

RSB0040E

WQFN - 0.8 mm max height

PLASTIC QUAD FLATPACK - NO LEAD

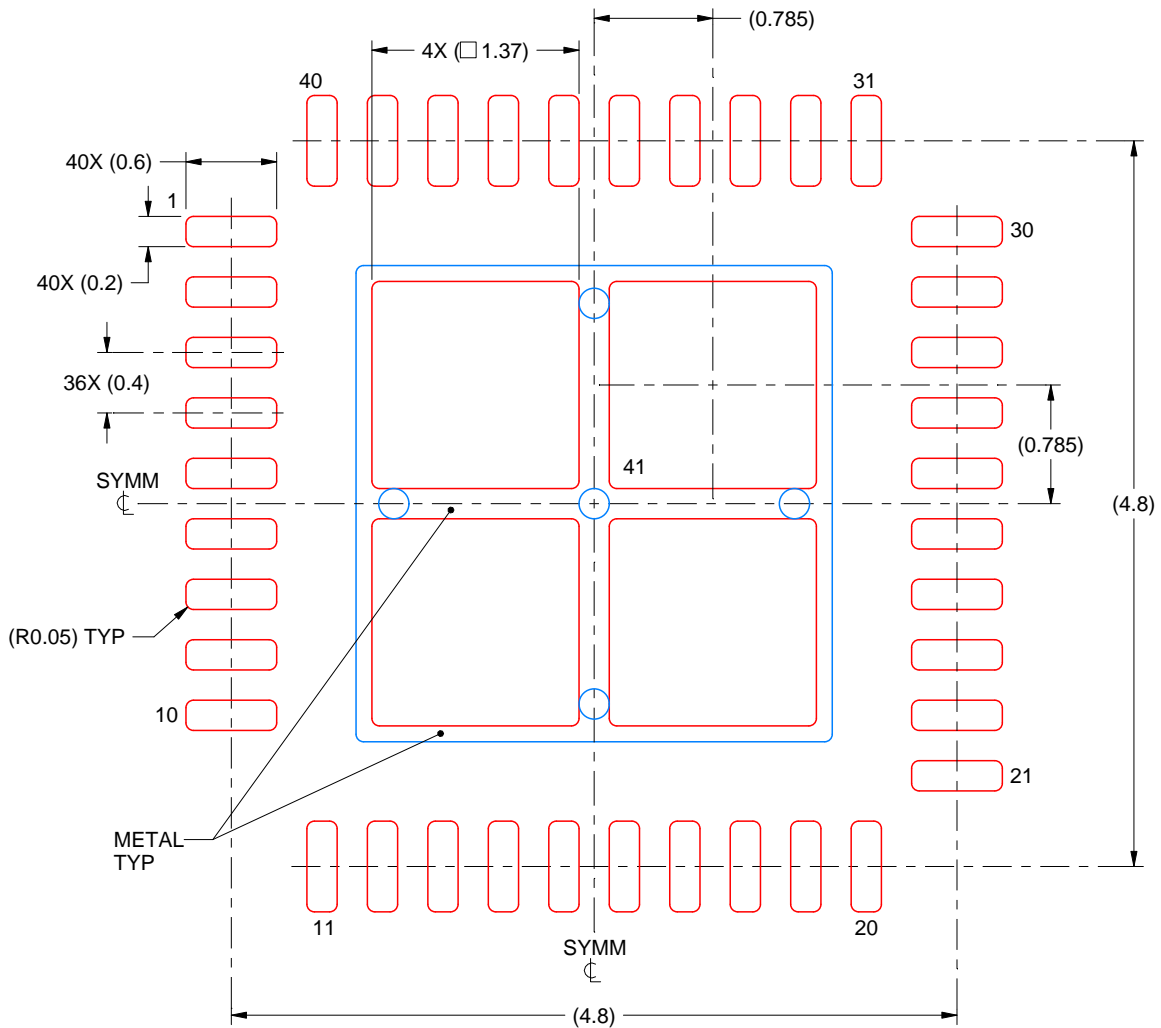

SOLDER PASTE EXAMPLE
BASED ON 0.1 mm THICK STENCIL

EXPOSED PAD 41
75% PRINTED SOLDER COVERAGE BY AREA UNDER PACKAGE
SCALE:20X

4219096/A 11/2017

NOTES: (continued)

6. Laser cutting apertures with trapezoidal walls and rounded corners may offer better paste release. IPC-7525 may have alternate design recommendations.

IMPORTANT NOTICE AND DISCLAIMER

TI PROVIDES TECHNICAL AND RELIABILITY DATA (INCLUDING DATASHEETS), DESIGN RESOURCES (INCLUDING REFERENCE DESIGNS), APPLICATION OR OTHER DESIGN ADVICE, WEB TOOLS, SAFETY INFORMATION, AND OTHER RESOURCES "AS IS" AND WITH ALL FAULTS, AND DISCLAIMS ALL WARRANTIES, EXPRESS AND IMPLIED, INCLUDING WITHOUT LIMITATION ANY IMPLIED WARRANTIES OF MERCHANTABILITY, FITNESS FOR A PARTICULAR PURPOSE OR NON-INFRINGEMENT OF THIRD PARTY INTELLECTUAL PROPERTY RIGHTS.

These resources are intended for skilled developers designing with TI products. You are solely responsible for (1) selecting the appropriate TI products for your application, (2) designing, validating and testing your application, and (3) ensuring your application meets applicable standards, and any other safety, security, regulatory or other requirements.

These resources are subject to change without notice. TI grants you permission to use these resources only for development of an application that uses the TI products described in the resource. Other reproduction and display of these resources is prohibited. No license is granted to any other TI intellectual property right or to any third party intellectual property right. TI disclaims responsibility for, and you fully indemnify TI and its representatives against any claims, damages, costs, losses, and liabilities arising out of your use of these resources.

TI's products are provided subject to [TI's Terms of Sale](#), [TI's General Quality Guidelines](#), or other applicable terms available either on [ti.com](#) or provided in conjunction with such TI products. TI's provision of these resources does not expand or otherwise alter TI's applicable warranties or warranty disclaimers for TI products. Unless TI explicitly designates a product as custom or customer-specified, TI products are standard, catalog, general purpose devices.

TI objects to and rejects any additional or different terms you may propose.

Copyright © 2025, Texas Instruments Incorporated

Last updated 10/2025