

TPS53688 Dual-Channel (N + M ≤ 8 phase) D-CAP+™, Step-Down, Digital Multiphase Controller with VR13.HC SVID

1 Features

- Input Voltage Range: 4.5 V to 17 V
- Output Voltage Range: 0.25 V to 5.5 V
- Intel® VR13.HC SVID Compliant
- Dual Output Supporting N+M Phase Configurations (N+M ≤ 8, M ≤ 4)
- Enhanced D-CAP+™ Control to Provide Super Transient Performance with Excellent Dynamic Current Sharing
- Programmable Loop Compensation
- Programmable Phase-Firing Order
- Individual Phase Current Calibrations and Reporting
- Dynamic Phase Shedding with Programmable Thresholds for Optimizing Efficiency at Light and Heavy Loads
- Fast Phase-Adding for Undershoot Reduction (USR)
- Driverless PWM Architecture for Efficient High-Frequency Switching
- Fully Compatible with TI NextFET™ Power Stage for High-Density Solutions
- Accurate, Adjustable, Adaptive Voltage Positioning (AVP)
- Patented AutoBalance™ Phase Current Balancing
- Cycle-by-cycle Per-Phase Current Limit
- PMBus™ v1.3.1 System Interface for Telemetry of Voltage, Current, Power, Temperature, and Fault Conditions
- 5 mm × 5 mm, 40-Pin, QFN Package

2 Applications

- [Data center & enterprise computing rack server](#)
- [Hardware accelerator](#)
- [Network interface card \(NIC\)](#)
- [ASIC and high-performance client](#)

3 Description

The TPS53688 is a fully VR13.HC SVID compliant step-down controller with two channels, built-in non-volatile memory (NVM), and PMBus™ interface, and is fully compatible with TI NextFET™ smart power stages. Advanced control features such as the D-CAP+™ architecture with undershoot reduction (USR) provide fast transient response, low output capacitance, and good dynamic current sharing. The device also provides a novel phase interleaving strategy and dynamic phase shedding, for efficiency improvement across loading conditions. Adjustable control of output voltage slew rate and adaptive voltage positioning are natively supported. In addition, the device supports the PMBus communication interface, for reporting the telemetry of voltage, current, power, temperature, and fault conditions to the host system. All programmable parameters can be configured through the PMBus interface and stored in NVM as new default values, to minimize the external component count.

The TPS53688 device is offered in a thermally enhanced 40-pin QFN packaged and is rated to operate from –40°C to 125°C.

Device Information

PART NUMBER	PACKAGE ⁽¹⁾	BODY SIZE (NOM)
TPS53688	QFN (40)	5 mm × 5 mm

(1) For all available packages, see the orderable addendum at the end of the data sheet.

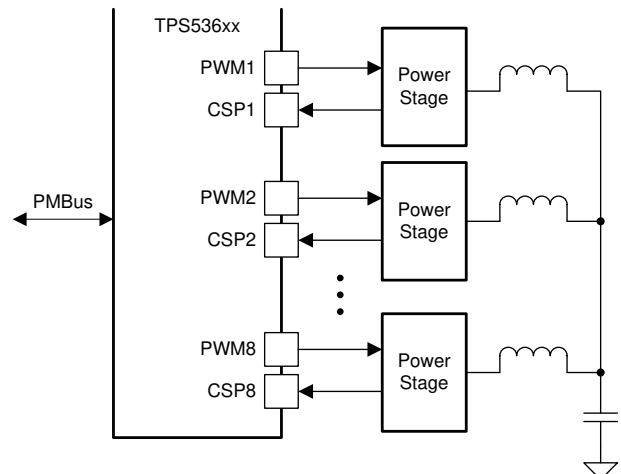

Simplified Schematic



Table of Contents

1 Features	1	5.2 Support Resources.....	3
2 Applications	1	5.3 Trademarks.....	3
3 Description	1	5.4 Electrostatic Discharge Caution.....	3
4 Revision History	2	5.5 Glossary.....	3
5 Device and Documentation Support	3	6 Mechanical, Packaging, and Orderable Information	4
5.1 Receiving Notification of Documentation Updates.....	3		

4 Revision History

NOTE: Page numbers for previous revisions may differ from page numbers in the current version.

Changes from Revision (May 2020) to Revision A (September 2020)	Page
• Updated the numbering format for tables, figures, and cross-references throughout the document.....	1
• Changed document status from <i>Advance Information</i> to <i>Production Data</i>	1

5 Device and Documentation Support

5.1 Receiving Notification of Documentation Updates

To receive notification of documentation updates, navigate to the device product folder on ti.com. Click on *Subscribe to updates* to register and receive a weekly digest of any product information that has changed. For change details, review the revision history included in any revised document.

5.2 Support Resources

[TI E2E™ support forums](#) are an engineer's go-to source for fast, verified answers and design help — straight from the experts. Search existing answers or ask your own question to get the quick design help you need.

Linked content is provided "AS IS" by the respective contributors. They do not constitute TI specifications and do not necessarily reflect TI's views; see TI's [Terms of Use](#).

5.3 Trademarks

D-CAP+™, NextFET™, AutoBalance™, NexFET™, the D-CAP+™, and TI E2E™ are trademarks of Texas Instruments.

PMBus™ is a trademark of SMIF, Inc..

Intel® is a registered trademark of Intel Corporation.

All other trademarks are the property of their respective owners.

5.4 Electrostatic Discharge Caution



This integrated circuit can be damaged by ESD. Texas Instruments recommends that all integrated circuits be handled with appropriate precautions. Failure to observe proper handling and installation procedures can cause damage.

ESD damage can range from subtle performance degradation to complete device failure. Precision integrated circuits may be more susceptible to damage because very small parametric changes could cause the device not to meet its published specifications.

5.5 Glossary

[TI Glossary](#)

This glossary lists and explains terms, acronyms, and definitions.

6 Mechanical, Packaging, and Orderable Information

The following pages include mechanical, packaging, and orderable information. This information is the most current data available for the designated devices. This data is subject to change without notice and revision of this document. For browser-based versions of this data sheet, refer to the left-hand navigation.

PACKAGING INFORMATION

Orderable Device	Status (1)	Package Type	Package Drawing	Pins	Package Qty	Eco Plan (2)	Lead finish/ Ball material (6)	MSL Peak Temp (3)	Op Temp (°C)	Device Marking (4/5)	Samples
TPS53688RSBR	ACTIVE	WQFN	RSB	40	3000	RoHS & Green	Call TI NIPDAUAG	Level-2-260C-1 YEAR	-40 to 125	TPS 53688	Samples
TPS53688RSBT	ACTIVE	WQFN	RSB	40	250	RoHS & Green	NIPDAUAG	Level-2-260C-1 YEAR	-40 to 125	TPS 53688	Samples

(1) The marketing status values are defined as follows:

ACTIVE: Product device recommended for new designs.

LIFEBUY: TI has announced that the device will be discontinued, and a lifetime-buy period is in effect.

NRND: Not recommended for new designs. Device is in production to support existing customers, but TI does not recommend using this part in a new design.

PREVIEW: Device has been announced but is not in production. Samples may or may not be available.

OBsolete: TI has discontinued the production of the device.

(2) **RoHS:** TI defines "RoHS" to mean semiconductor products that are compliant with the current EU RoHS requirements for all 10 RoHS substances, including the requirement that RoHS substance do not exceed 0.1% by weight in homogeneous materials. Where designed to be soldered at high temperatures, "RoHS" products are suitable for use in specified lead-free processes. TI may reference these types of products as "Pb-Free".

RoHS Exempt: TI defines "RoHS Exempt" to mean products that contain lead but are compliant with EU RoHS pursuant to a specific EU RoHS exemption.

Green: TI defines "Green" to mean the content of Chlorine (Cl) and Bromine (Br) based flame retardants meet JS709B low halogen requirements of <=1000ppm threshold. Antimony trioxide based flame retardants must also meet the <=1000ppm threshold requirement.

(3) MSL, Peak Temp. - The Moisture Sensitivity Level rating according to the JEDEC industry standard classifications, and peak solder temperature.

(4) There may be additional marking, which relates to the logo, the lot trace code information, or the environmental category on the device.

(5) Multiple Device Markings will be inside parentheses. Only one Device Marking contained in parentheses and separated by a "~" will appear on a device. If a line is indented then it is a continuation of the previous line and the two combined represent the entire Device Marking for that device.

(6) Lead finish/Ball material - Orderable Devices may have multiple material finish options. Finish options are separated by a vertical ruled line. Lead finish/Ball material values may wrap to two lines if the finish value exceeds the maximum column width.

Important Information and Disclaimer:The information provided on this page represents TI's knowledge and belief as of the date that it is provided. TI bases its knowledge and belief on information provided by third parties, and makes no representation or warranty as to the accuracy of such information. Efforts are underway to better integrate information from third parties. TI has taken and continues to take reasonable steps to provide representative and accurate information but may not have conducted destructive testing or chemical analysis on incoming materials and chemicals. TI and TI suppliers consider certain information to be proprietary, and thus CAS numbers and other limited information may not be available for release.

In no event shall TI's liability arising out of such information exceed the total purchase price of the TI part(s) at issue in this document sold by TI to Customer on an annual basis.

GENERIC PACKAGE VIEW

RSB 40

WQFN - 0.8 mm max height

5 x 5 mm, 0.4 mm pitch

PLASTIC QUAD FLATPACK - NO LEAD

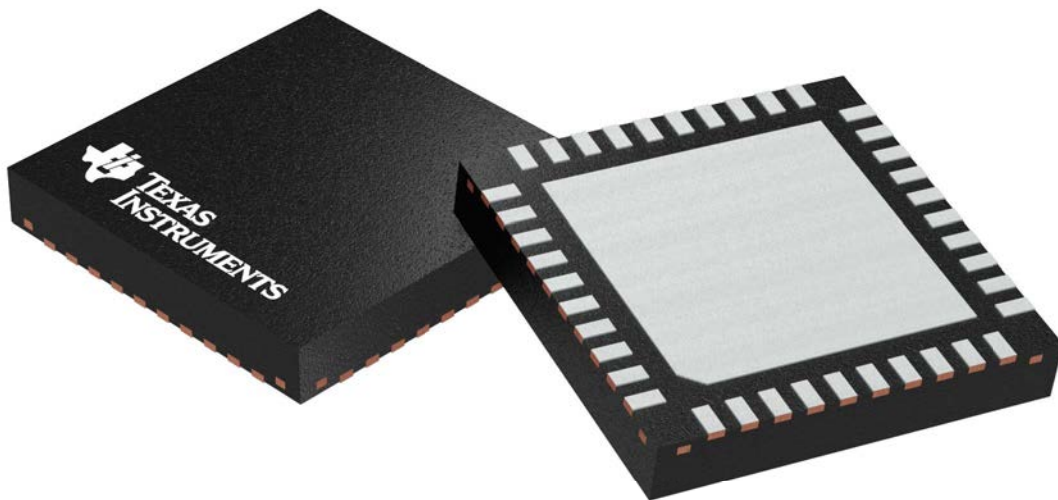

Images above are just a representation of the package family, actual package may vary.
Refer to the product data sheet for package details.

4207182/D

IMPORTANT NOTICE AND DISCLAIMER

TI PROVIDES TECHNICAL AND RELIABILITY DATA (INCLUDING DATA SHEETS), DESIGN RESOURCES (INCLUDING REFERENCE DESIGNS), APPLICATION OR OTHER DESIGN ADVICE, WEB TOOLS, SAFETY INFORMATION, AND OTHER RESOURCES "AS IS" AND WITH ALL FAULTS, AND DISCLAIMS ALL WARRANTIES, EXPRESS AND IMPLIED, INCLUDING WITHOUT LIMITATION ANY IMPLIED WARRANTIES OF MERCHANTABILITY, FITNESS FOR A PARTICULAR PURPOSE OR NON-INFRINGEMENT OF THIRD PARTY INTELLECTUAL PROPERTY RIGHTS.

These resources are intended for skilled developers designing with TI products. You are solely responsible for (1) selecting the appropriate TI products for your application, (2) designing, validating and testing your application, and (3) ensuring your application meets applicable standards, and any other safety, security, regulatory or other requirements.

These resources are subject to change without notice. TI grants you permission to use these resources only for development of an application that uses the TI products described in the resource. Other reproduction and display of these resources is prohibited. No license is granted to any other TI intellectual property right or to any third party intellectual property right. TI disclaims responsibility for, and you will fully indemnify TI and its representatives against, any claims, damages, costs, losses, and liabilities arising out of your use of these resources.

TI's products are provided subject to [TI's Terms of Sale](#) or other applicable terms available either on [ti.com](https://www.ti.com) or provided in conjunction with such TI products. TI's provision of these resources does not expand or otherwise alter TI's applicable warranties or warranty disclaimers for TI products.

TI objects to and rejects any additional or different terms you may have proposed.

Mailing Address: Texas Instruments, Post Office Box 655303, Dallas, Texas 75265
Copyright © 2024, Texas Instruments Incorporated