

具有 PMBus™ 的 TPS53819A 3V 至 28V 输入、40A、Eco-Mode™、D-CAP2™ 同步降压控制器

1 特性

- 转换输入电压：3V 至 28V
- VDD 输入电压：4.5V 至 28V
- 输出电压：0.6V 至 5.5V
- 支持全陶瓷输出电容器
- 基准电压：600mV \pm 0.5% 容差
- \pm 9% 电压调节，采用 PMBus™
- 内置 5V 低压降稳压器 (LDO)
- D-CAP2™ 模式，提供 100ns 的负载阶跃响应
- 自动跳跃 Eco-mode™ 可实现轻负载效率
- 自适应导通时间控制架构，具有八种频率设置可供选择，采用 PMBus
- 支持电压裕量调节，采用 PMBus
- 可编程软启动时间，采用 PMBus
- 可编程加电延迟，采用 PMBus
- 可编程 VDD UVLO 电平，采用 PMBus
- 故障报告，采用 PMBus
- 预充电启动能力
- 内置输出放电
- 具有可编程延迟的电源正常状态输出
- 内部过压、欠压和过流限制保护
- 热关断（非锁存）
- 3mm x 3mm 16 引脚 QFN 封装
- 使用 TPS53819A 并借助 WEBENCH® 电源设计器创建定制设计

2 应用

- 以下应用的负载点电源：
 - 存储计算机
 - 服务器计算机
 - 多功能打印机
 - 嵌入式计算

3 说明

TPS53819A 器件是一款具有自适应导通时间 D-CAP2 模式控制和 PMBus 的小型单路降压控制器。此器件适合用于低输出电压和高电流、系统电源轨或数字消费类产品中相似的负载点 (POL) 电源。具有最小引脚数量的小型封装节省了印刷电路板 (PCB) 上的空间，与此同时可通过 PMBus 实现的可编程性和故障报告简化了电源设计。轻载情况下的跳跃模式与强大的栅极驱动器和低侧 FET 导通电阻 ($R_{DS(on)}$) 电流感应相结合，可在广泛的负载范围内支持低损耗和高效率的运行。转换输入电压（即高侧 FET 漏极电压）的范围介于 3V 至 28V 之间。电源电压 (VDD) 介于 4.5V 至 28V 之间。输出电压范围介于 0.6V 至 5.5V 之间。此器件采用 16 引脚的 QFN 封装，额定工作温度范围为 -40°C 至 $+85^{\circ}\text{C}$ 。

器件信息(1)

器件型号	封装	封装尺寸 (标称值)
TPS53819A	四方扁平无引线 (QFN) (16)	3.00mm x 3.00mm

(1) 如需了解所有可用封装，请见数据表末尾的可订购产品附录。

简化应用

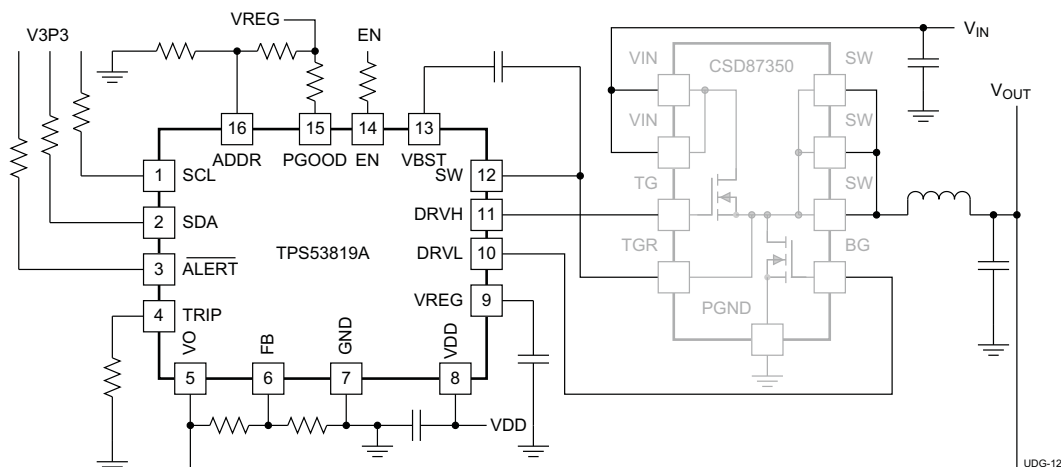

目录

1	特性	1	7.4	Device Functional Modes	19
2	应用	1	7.5	Programming	21
3	说明	1	7.6	Register Maps	24
4	修订历史记录	2	8	Application and Implementation	34
5	Pin Configuration and Functions	3	8.1	Application Information	34
6	Specifications	4	8.2	Typical Application	34
6.1	Absolute Maximum Ratings	4	9	Power Supply Recommendations	40
6.2	ESD Ratings	4	10	Layout	41
6.3	Recommended Operating Conditions	4	10.1	Layout Guidelines	41
6.4	Thermal Information	5	10.2	Layout Example	42
6.5	Electrical Characteristics	5	11	器件和文档支持	44
6.6	Timing Requirements	8	11.1	器件支持	44
6.7	Switching Characteristics	9	11.2	接收文档更新通知	44
6.8	Typical Characteristics	10	11.3	社区资源	44
7	Detailed Description	16	11.4	商标	44
7.1	Overview	16	11.5	静电放电警告	44
7.2	Functional Block Diagram	16	11.6	术语表	44
7.3	Feature Description	17	12	机械、封装和可订购信息	44

4 修订历史记录

注：之前版本的页码可能与当前版本有所不同。

Changes from Revision A (October 2015) to Revision B	Page
• 已添加 Webench 链接；编辑性更新 - 无技术数据更改	1

Changes from Original (November 2012) to Revision A	Page
• 已添加 ESD 额定值表，特性说明部分，器件功能模式部分，应用和实施部分，电源相关建议部分，布局部分，器件和文档支持部分以及机械、封装和可订购信息部分	1

5 Pin Configuration and Functions

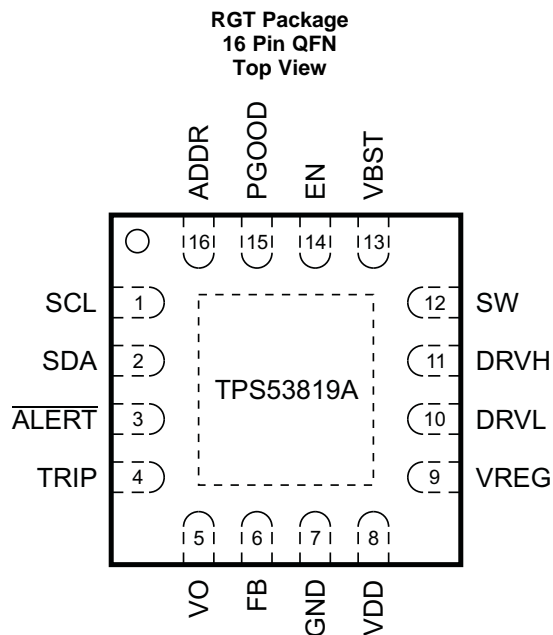

Pin Functions

PIN		I/O ⁽¹⁾	DESCRIPTION
NAME	NO.		
ADDR	16	I	PMBus address configuration. Connect this pin to a resistor divider between VREG and GND to program different address settings. (See Table 2 for details.)
$\overline{\text{ALERT}}$	3	O	Open-drain alert output for the PMBus interface.
DRVH	11	O	High-side MOSFET floating driver output that is referenced to SW node. The gate drive voltage is defined by the voltage across bootstrap capacitor between VBST and SW.
DRVL	10	O	Synchronous MOSFET driver output that is referenced to GND. The gate drive voltage is defined by VREG voltage.
EN	14	I	Enable pin that can turn on the DC/DC switching converter. EN pin works in conjunction with the CP bit in PMBus ON_OFF_CONFIG register.
FB	6	I	Output voltage feedback input. Connect this pin to a resistor divider between output voltage and GND.
GND	7	G	Ground pin.
PGOOD	15	O	Open drain power good status signal. Provides start-up delay time after FB voltage falls within specified limits. After FB voltage goes out of specified limits, PGOOD goes low within 2 μs .
SCL	1	I	Clock input for the PMBus interface.
SDA	2	I/O	Data I/O for the PMBus interface.
SW	12	P	Output switching terminal of power converter. Connect this pin to the output inductor.
TRIP	4	I/O	OCL detection threshold setting pin. A 10- μA current with a T_C of 4700ppm/ $^{\circ}\text{C}$ is sourced out of the TRIP pin and is used to set the OCL trip voltage as follows: $V_{\text{OCL}} = V_{\text{TRIP}}/8$ ($V_{\text{TRIP}} \leq 3 \text{ V}$, $V_{\text{OCL}} \leq 375 \text{ mV}$)
VBST	13	P	Supply rail for high-side gate driver (boost terminal). Connect bootstrap capacitor from this pin to SW node. Internally connected to VREG via bootstrap PMOS switch.
VDD	8	P	Controller power supply input.
VO	5	I	Output voltage.
VREG	9	P	5-V low-drop-out (LDO) output. Supplies the internal analog and driver circuitry.

(1) I=Input, O=Output, P=Power, G=Ground

6 Specifications

6.1 Absolute Maximum Ratings

over operating free-air temperature range (unless otherwise noted)⁽¹⁾

		MIN	MAX	UNIT	
Input voltage ⁽²⁾	VBST	-0.3	38	V	
	VBST ⁽³⁾	-0.3	6		
	EN	-0.3	7.7		
	VO, FB, SCL, SDA, ADDR	-0.3	6		
	VDD	-0.3	30		
	SW	DC	-3		32
	Pulse < 30% of the repetitive period	-5	32		
Output voltage ⁽²⁾	DRVH	DC	-3	38	V
		Pulse < 30% of the repetitive period	-5	38	
	DRVH ⁽³⁾ , DRVL	-0.3	6		
	ALERT, VREG, TRIP	-0.3	6		
	PGOOD	-0.3	7.7		
Junction temperature, T _J			150	°C	
Storage temperature, T _{stg}		-55	150	°C	

- (1) Stresses beyond those listed under *Absolute Maximum Ratings* may cause permanent damage to the device. These are stress ratings only, which do not imply functional operation of the device at these or any other conditions beyond those indicated under *Recommended Operating Conditions*. Exposure to absolute-maximum-rated conditions for extended periods may affect device reliability.
- (2) All voltage values are with respect to the network ground terminal unless otherwise noted.
- (3) Voltage values are with respect to the SW terminal.

6.2 ESD Ratings

		VALUE	UNIT
V _(ESD)	Electrostatic discharge	Human-body model (HBM), per ANSI/ESDA/JEDEC JS-001 ⁽¹⁾	±2000
		Charged-device model (CDM), per JEDEC specification JESD22-C101 ⁽²⁾	±500

- (1) JEDEC document JEP155 states that 500-V HBM allows safe manufacturing with a standard ESD control process.
- (2) JEDEC document JEP157 states that 250-V CDM allows safe manufacturing with a standard ESD control process.

6.3 Recommended Operating Conditions

over operating free-air temperature range (unless otherwise noted)

		MIN	NOM	MAX	UNIT
Input voltage range	VBST	-0.1		35.5	V
	VBST ⁽¹⁾	-0.1		5.5	
	EN	-0.1		6.5	
	VO, FB, SCL, SDA, ADDR	-0.1		5.5	
	VDD	4.5		28	V
	SW	DC	-3		
Pulse < 30% of the repetitive period		-4.5		30	
Output voltage range	DRVH	DC		35.5	V
		Pulse < 30% of the repetitive period		35.5	
	DRVH ⁽¹⁾ , DRVL	-0.1		5.5	V
	ALERT, VREG	-0.1		5.5	V
	PGOOD	-0.1		6.5	V
Operating free-air temperature, T _A		-40		85	°C

- (1) Voltage values are with respect to the SW terminal.

6.4 Thermal Information

THERMAL METRIC ⁽¹⁾		TPS53819A	UNIT
		RGT (QFN)	
		16 PINS	
R _{θJA}	Junction-to-ambient thermal resistance	51.3	°C/W
R _{θJC(top)}	Junction-to-case (top) thermal resistance	85.4	°C/W
R _{θJB}	Junction-to-board thermal resistance	20.1	°C/W
ψ _{JT}	Junction-to-top characterization parameter	1.3	°C/W
ψ _{JB}	Junction-to-board characterization parameter	19.4	°C/W
R _{θJC(bot)}	Junction-to-case (bottom) thermal resistance	6.0	°C/W

(1) For more information about traditional and new thermal metrics, see the *Semiconductor and IC Package Thermal Metrics* application report, [SPRA953](#).

6.5 Electrical Characteristics

over operating free-air temperature range, V_{REG} = 5 V, V_{EN} = 5 V (unless otherwise noted)

PARAMETER	TEST CONDITIONS	MIN	TYP	MAX	UNIT
SUPPLY CURRENT					
I _{VDD}	VDD bias current	T _A = 25°C, no load, power conversion enabled (no switching)		920	μA
I _{VDDSTBY}	VDD standby current	T _A = 25°C, no load, power conversion disabled		610	μA
INTERNAL REFERENCE AND FEEDBACK REGULATION VOLTAGE					
V _{FB}	Feedback regulation voltage	FB w/r/t GND, CCM condition		600	mV
V _{FBTOL}	Feedback voltage tolerance	FB w/r/t GND, 0°C ≤ T _J ≤ 85°C		597 600 603	mV
V _{DACTOL1}	DAC voltage tolerance 1	FB w/r/t GND, 0°C ≤ T _A ≤ 85°C, all settings with VOUT_ADJUSTMENT only		-4.8 4.8	mV
V _{DACTOL2}	DAC voltage tolerance 2	FB w/r/t GND, 0°C ≤ T _A ≤ 85°C, all settings with VOUT_MARGIN only		-4.8 4.8	mV
V _{DACTOL3}	DAC voltage tolerance 3	FB w/r/t GND, 0°C ≤ T _A ≤ 85°C, with VOUT_ADJUSTMENT = 0Dh and VOUT_MARGIN = 70h for +5%		-4.8 4.8	mV
V _{DACTOL4}	DAC voltage tolerance 4	FB w/r/t GND, 0°C ≤ T _A ≤ 85°C, with VOUT_ADJUSTMENT = 13h and VOUT_MARGIN = 07h for -5%		-4.8 4.8	mV
V _{IOS_LPCMP}	Loop comparator input offset voltage	V _{REF} to V _{FB} , T _A = 25°C		-2.5 2.5	mV
I _{FB}	FB pin input current	V _{FB} = 600 mV		-1 1	μA
OUTPUT VOLTAGE					
I _{VODIS}	VO discharge current	V _{VO} = 0.5 V, power conversion disabled		10 12	mA
DRIVER					
R _{DRVH}	DRVH resistance	Source, I _{DRVH} = 50 mA	1.6		Ω
		Sink, I _{DRVH} = 50 mA	0.6		
R _{DRVL}	DRVL resistance	Source, I _{DRVL} = 50 mA	0.9		
		Sink, I _{DRVL} = 50 mA	0.5		

Electrical Characteristics (continued)

 over operating free-air temperature range, $V_{VREG} = 5\text{ V}$, $V_{EN} = 5\text{ V}$ (unless otherwise noted)

PARAMETER		TEST CONDITIONS	MIN	TYP	MAX	UNIT
INTERNAL BOOT STRAP SWITCH						
V_F	Forward voltage	$V_{VREG-VBST}$, $T_A = 25^\circ\text{C}$, $I_F = 10\text{ mA}$		0.1	0.2	V
I_{VBST}	VBST leakage current	$T_A = 25^\circ\text{C}$, $V_{VBST} = 33\text{ V}$, $V_{SW} = 28\text{ V}$		0.01	1.5	μA
ENABLE LOGIC THRESHOLD						
V_L	EN low-level voltage				0.5	V
V_H	EN high-level voltage		1.8			V
V_{HYST}	EN hysteresis voltage			0.22		V
I_{LEAK}	EN input leakage current		-1	0	1	μA
POWER GOOD COMPARATOR						
V_{PGTH}	Powergood threshold	PGOOD in from higher	105%	108%	111%	
		PGOOD in from lower	89%	92%	95%	
		PGOOD out to higher	113%	116%	119%	
		PGOOD out to lower	81%	84%	87%	
I_{PG}	PGOOD sink current	$V_{PGOOD} = 0.5\text{ V}$		6.9		mA
I_{PGLK}	PGOOD leakage current	$V_{PGOOD} = 5.0\text{ V}$	-1	0	1	μA
CURRENT DETECTION						
I_{TRIP}	TRIP source current	$T_A = 25^\circ\text{C}$, $V_{TRIP} = 0.4\text{ V}$, $R_{DS(on)}$ sensing	9	10	11	μA
TC_{ITRIP}	TRIP source current temperature coefficient ⁽¹⁾	$R_{DS(on)}$ sensing		4700		ppm/°C
V_{TRIP}	TRIP voltage range	$R_{DS(on)}$ sensing	0.2		3	V
V_{OCLP}	Positive current limit threshold	$V_{TRIP} = 3.0\text{ V}$, $R_{DS(on)}$ sensing	360	375	390	mV
		$V_{TRIP} = 1.6\text{ V}$, $R_{DS(on)}$ sensing	190	200	210	
		$V_{TRIP} = 0.2\text{ V}$, $R_{DS(on)}$ sensing	20	25	30	
V_{OCLN}	Negative current limit threshold	$V_{TRIP} = 3.0\text{ V}$, $R_{DS(on)}$ sensing	-390	-375	-360	mV
		$V_{TRIP} = 1.6\text{ V}$, $R_{DS(on)}$ sensing	-212	-200	-188	
		$V_{TRIP} = 0.2\text{ V}$, $R_{DS(on)}$ sensing	-30	-25	-20	
V_{ZC}	Zero cross detection offset			0		mV
PROTECTIONS						
$V_{VREGUVLO}$	VREG UVLO threshold voltage	Wake-up		3.32		V
		Shutdown		3.11		
V_{OVP}	OVP threshold voltage	OVP detect voltage	117%	120%	123%	
t_{OVDPDY}	OVP propagation delay time	With 100-mV overdrive		430		ns
V_{UVP}	UVP threshold voltage	UVP detect voltage	65%	68%	71%	
THERMAL SHUTDOWN						
T_{SDN}	Thermal shutdown threshold	Shutdown temperature		140		°C
		Hysteresis		40		
LDO VOLTAGE						
V_{REG}	LDO output voltage	$V_{IN} = 12\text{ V}$, $I_{LOAD} = 10\text{ mA}$	4.5	5	5.5	V
V_{DOVREG}	LDO low droop drop-out voltage	$V_{IN} = 4.5\text{ V}$, $I_{LOAD} = 30\text{ mA}$, $T_A = 25^\circ\text{C}$			365	mV
$I_{LDO(max)}$	LDO overcurrent limit ⁽¹⁾	$V_{IN} = 12\text{ V}$, $T_A = 25^\circ\text{C}$		152		mA

(1) Specified by design. Not production tested.

Electrical Characteristics (continued)

over operating free-air temperature range, $V_{VREG} = 5\text{ V}$, $V_{EN} = 5\text{ V}$ (unless otherwise noted)

PARAMETER	TEST CONDITIONS	MIN	TYP	MAX	UNIT	
VDD UVLO VOLTAGE						
VDD _{UVLO}	VDD UVLO voltage	VDDINUVLO<2:0> = 0xx	10.2		V	
		VDDINUVLO<2:0> = 101	4.1	4.25		4.4
		VDDINUVLO<2:0> = 110		6.0		
		VDDINUVLO<2:0> = 111		8.1		
VDD _{HY-UVLO}	VDD UVLO hysteresis voltage	0°C ≤ T _J ≤ 85°C	0.2		V	
PMBus SCL and SDA INPUT BUFFER LOGIC THRESHOLDS						
V _{IL-PMBUS}	SCL and SDA low-level input voltage ⁽¹⁾	0°C ≤ T _J ≤ 85°C		0.8	V	
V _{IH-PMBUS}	SCL and SDA high-level input voltage ⁽¹⁾	0°C ≤ T _J ≤ 85°C	2.1		V	
V _{HY-PMBUS}	SCL and SDA hysteresis voltage ⁽¹⁾	0°C ≤ T _J ≤ 85°C	240		mV	
PMBus SDA and $\overline{\text{ALERT}}$ OUTPUT PULLDOWN						
V _{OL1-PMBUS}	SDA and $\overline{\text{ALERT}}$ low-level output voltage ⁽¹⁾	V _{DDPMBUS} = 5.5 V, R _{PULLUP} = 1.1 kΩ, 0°C ≤ T _J ≤ 85°C		0.4	V	
V _{OL2-PMBUS}	SDA and $\overline{\text{ALERT}}$ low-level output voltage ⁽¹⁾	V _{DDPMBUS} = 3.6 V, R _{PULLUP} = 0.7 kΩ, 0°C ≤ T _J ≤ 85°C		0.4	V	

6.6 Timing Requirements

		MIN	NOM	MAX	UNIT	
POWER-ON DELAY						
t_{PODLY}	Power-on delay time	Delay from enable to switching POD<2:0> = 000	356		μs	
		Delay from enable to switching POD<2:0> = 001	612		μs	
		Delay from enable to switching POD<2:0> = 010	1.124		ms	
		Delay from enable to switching POD<2:0> = 011	2.148		ms	
		Delay from enable to switching POD<2:0> = 100	4.196		ms	
		Delay from enable to switching POD<2:0> = 101	8.292		ms	
		Delay from enable to switching POD<2:0> = 110	16.48		ms	
		Delay from enable to switching POD<2:0> = 111	32.86		ms	
PGOOD DELAY						
t_{PGDLY}	PGOOD delay time	Delay for PGOOD going in PGD<2:0> = 000	165	256	320	μs
		Delay for PGOOD going in PGD<2:0> = 001	409	512	614	μs
		Delay for PGOOD going in PGD<2:0> = 010	0.819	1.024	1.228	ms
		Delay for PGOOD going in PGD<2:0> = 011	1.638	2.048	2.458	ms
		Delay for PGOOD going in PGD<2:0> = 100	3.276	4.096	4.915	ms
		Delay for PGOOD going in PGD<2:0> = 101	6.553	8.192	9.83	ms
		Delay for PGOOD going in PGD<2:0> = 110	13.104	16.38	19.656	ms
		Delay for PGOOD going in PGD<2:0> = 111	105	131	157	ms
	Delay for PGOOD coming out			2	μs	
SOFT START TIME						
t_{SS}	Soft-start time	SST<1:0> = 00	1.0		ms	
		SST<1:0> = 01	2.0			
		SST<1:0> = 10	4.0			
		SST<1:0> = 11	8.0			
FREQUENCY CONTROL						
$t_{\text{OFF(min)}}$	Minimum off-time	DRVH falling to rising	320		ns	
$t_{\text{ON(min)}}$	Minimum on-time ⁽¹⁾	DRVH rising to falling	60		ns	
PROTECTIONS						
t_{UVPDLY}	UVP filterdelay time		1		ms	
DRIVER						
t_{DEAD}	Dead time	DRVH-off to DRVL-on	10		ns	
		DRVL-off to DRVH-on	20			

(1) Specified by design. Not production tested.

6.7 Switching Characteristics

over operating free-air temperature range $V_{IN} = 12\text{ V}$, $V_{VO} = 3.3\text{ V}$ (unless otherwise noted)

PARAMETER		TEST CONDITIONS	MIN	TYP	MAX	UNIT
FREQUENCY CONTROL						
f_{sw}	VO pin switching frequency	FS <2:0> = 000		275		kHz
		FS <2:0> = 001		325		
		FS <2:0> = 010		425		
		FS <2:0> = 011		525		
		FS <2:0> = 100		625		
		FS <2:0> = 101		750		
		FS <2:0> = 110		850		
		FS <2:0> = 111		1000		

6.8 Typical Characteristics

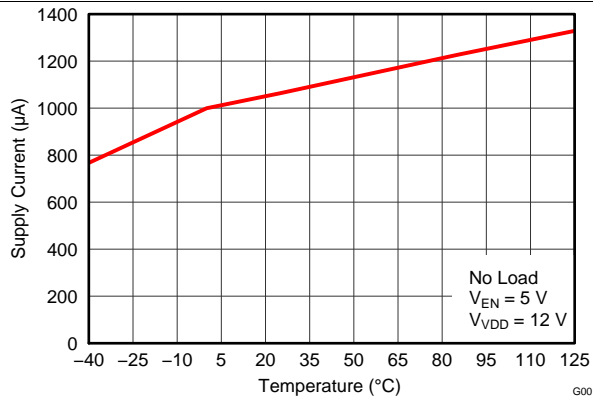

Figure 1. VDD Supply Current vs Temperature

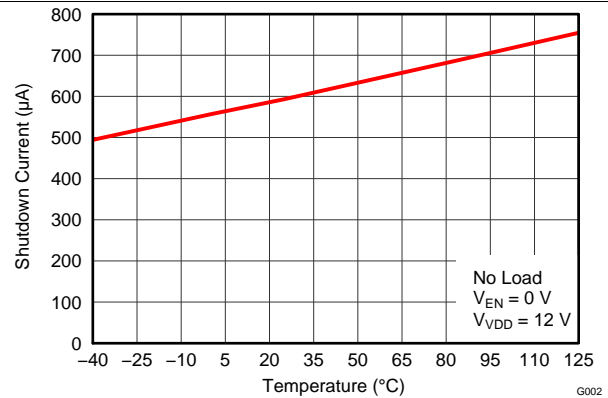

Figure 2. VDD Shutdown Current vs Temperature

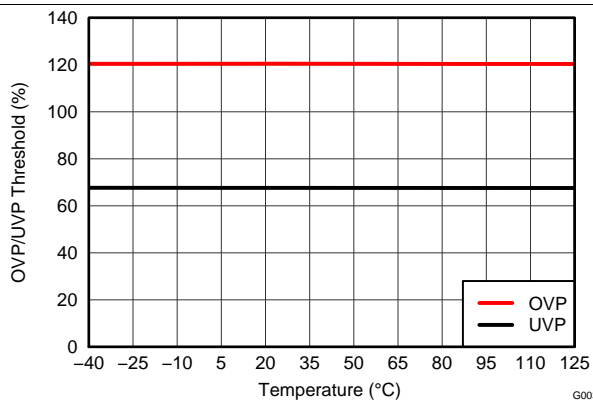

Figure 3. OVP/UVP Thresholds vs Temperature

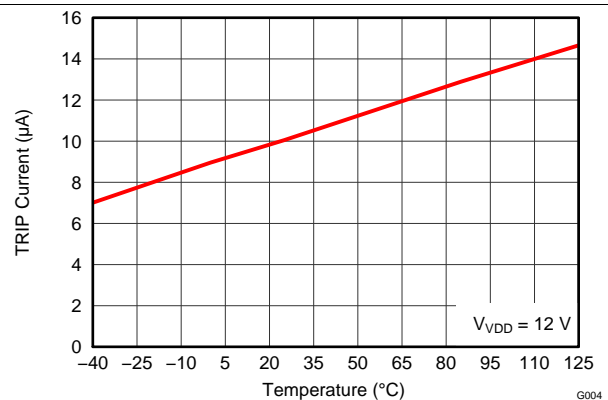

Figure 4. TRIP Pin Current vs Temperature

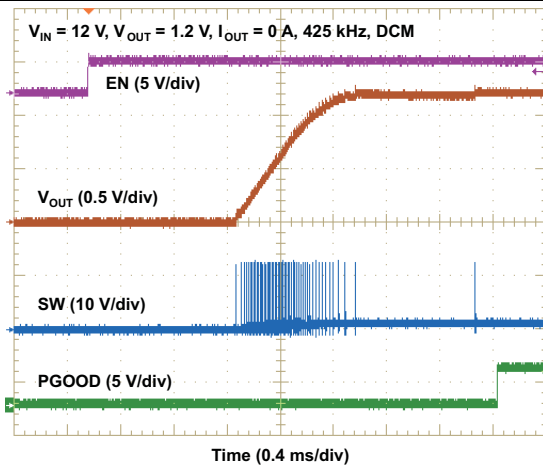

Figure 5. No-Load Start-Up Waveforms with DCM

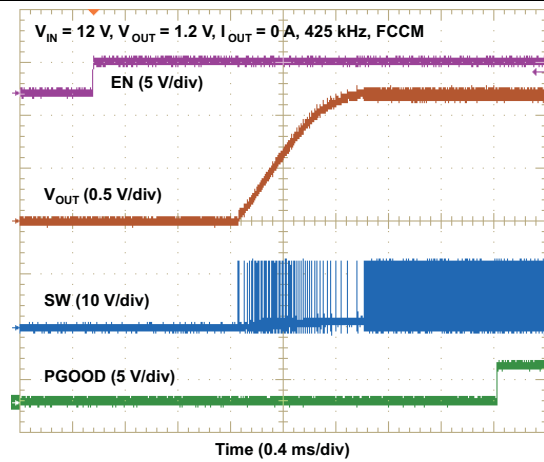

Figure 6. No-Load Start-Up Waveforms with FCCM

Typical Characteristics (continued)

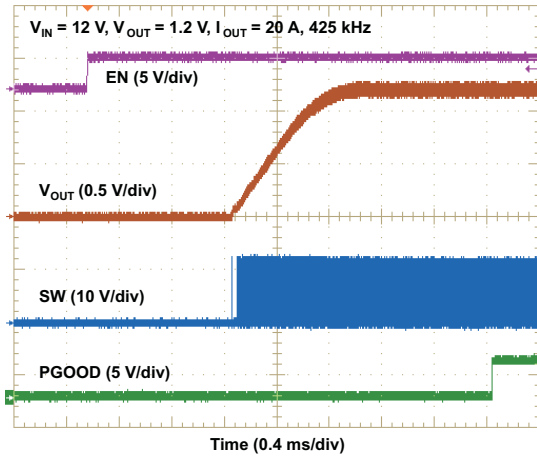

Figure 7. Full-Load Start-Up Waveforms

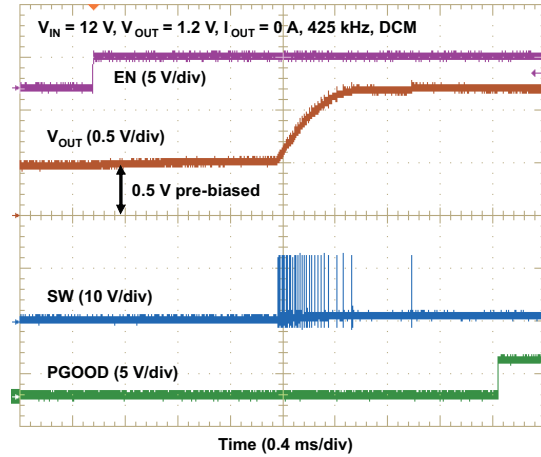

Figure 8. Pre-Bias Start-Up Waveforms with DCM

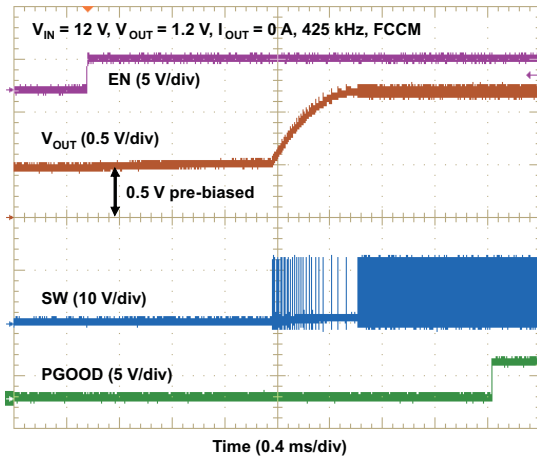

Figure 9. Pre-Bias Start-Up Waveforms with FCCM

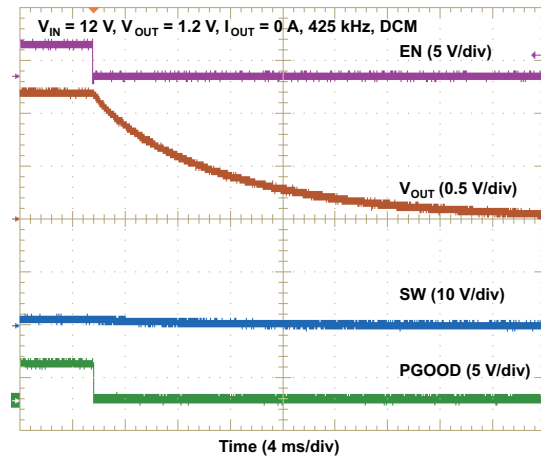

Figure 10. No-Load Shutdown Waveforms with DCM

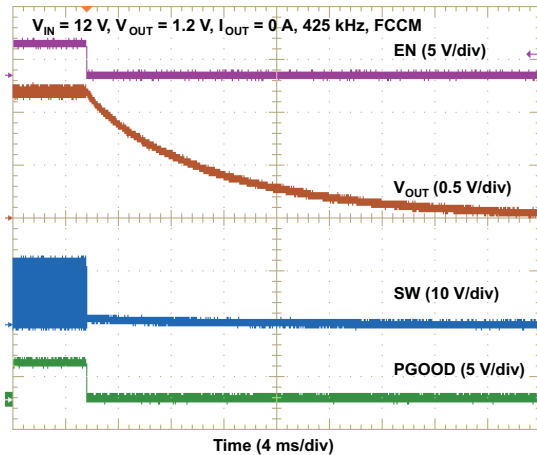

Figure 11. No-Load Shutdown Waveforms with FCCM

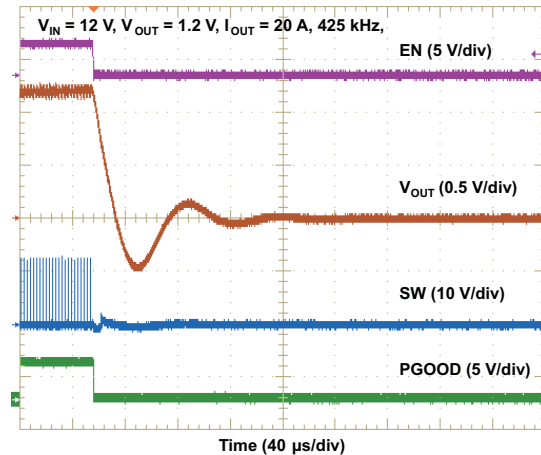

Figure 12. Full-Load Shutdown Waveforms

Typical Characteristics (continued)

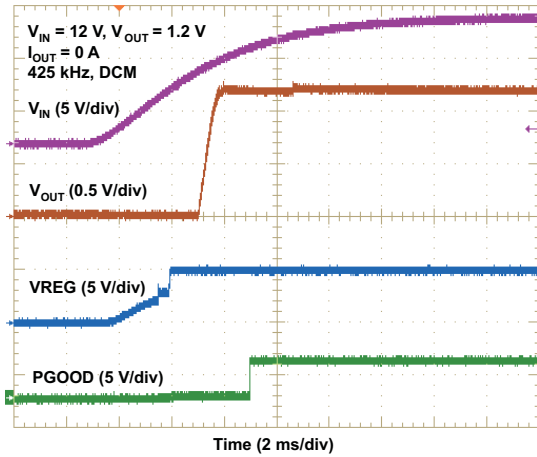

Figure 13. No-Load UVLO Start-Up Waveforms

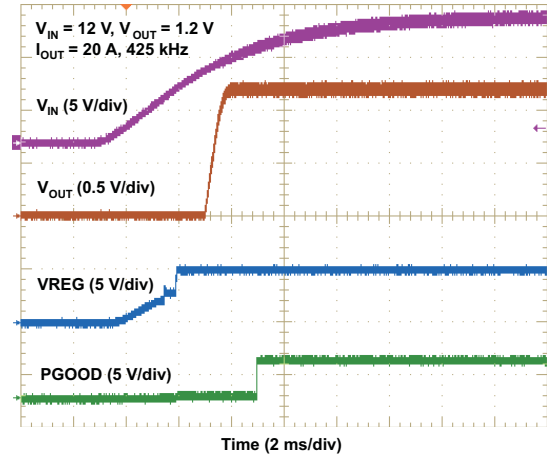

Figure 14. Full-Load UVLO Start-Up Waveforms

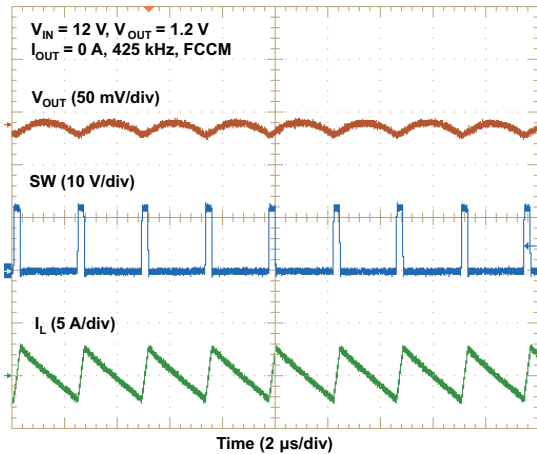

Figure 15. 1.2-V Output Ripple with FCCM

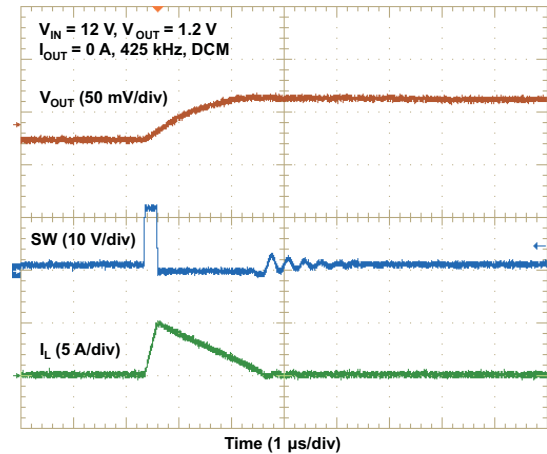

Figure 16. 1.2-V Output Ripple with DCM

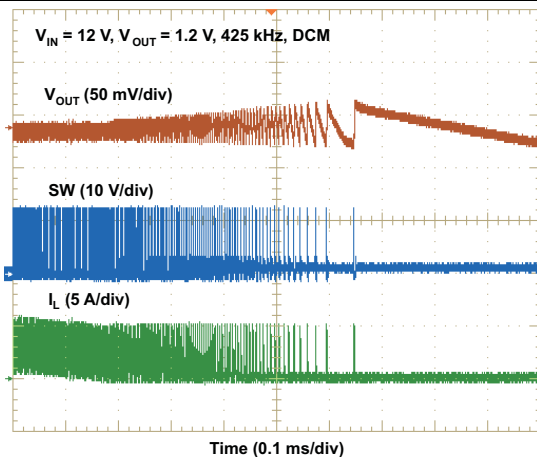

Figure 17. CCM to DCM Transitions

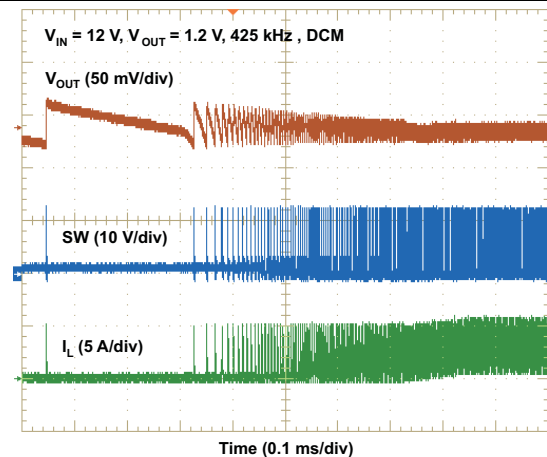

Figure 18. DCM to CCM Transitions

Typical Characteristics (continued)

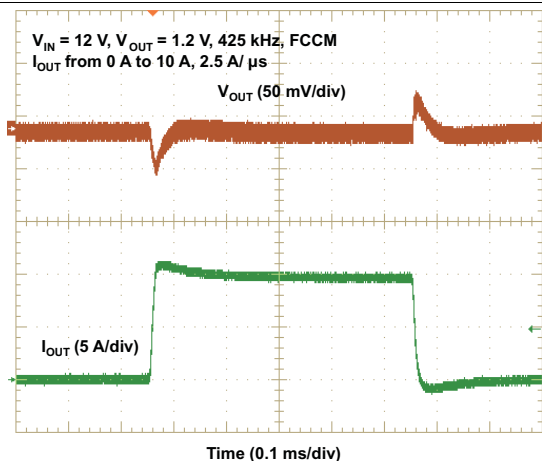

Figure 19. FCCM Load Transients

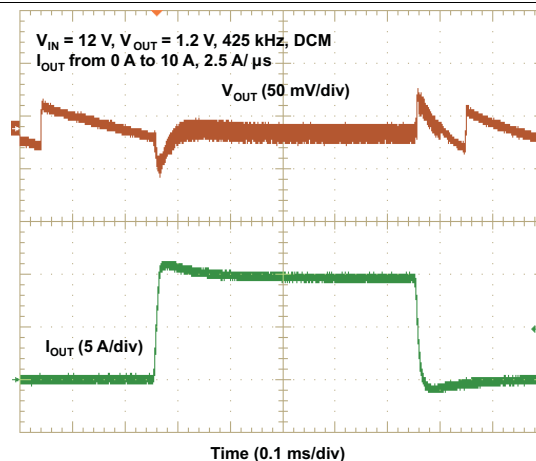

Figure 20. DCM Load Transients

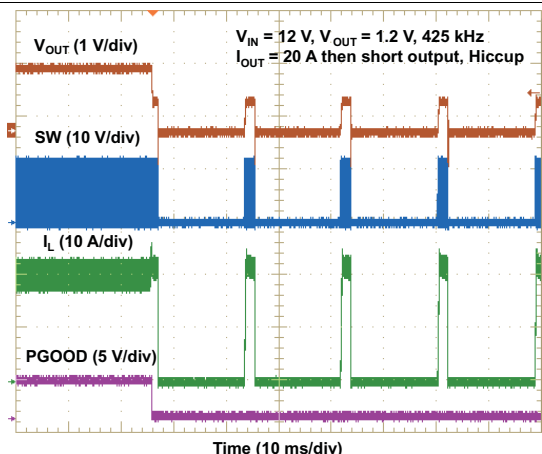

Figure 21. Output Short Circuit Protection with Hiccup

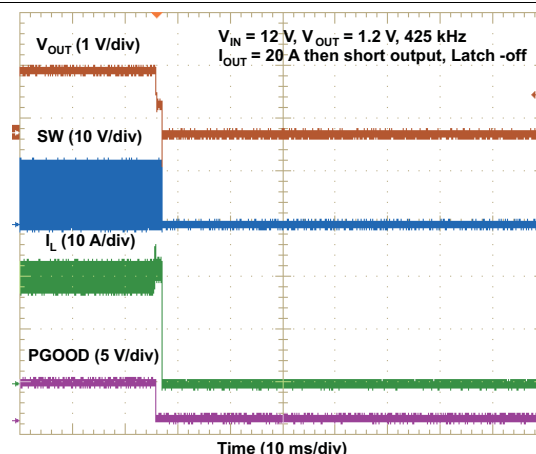

Figure 22. Output Short Circuit Protection with Latch-off

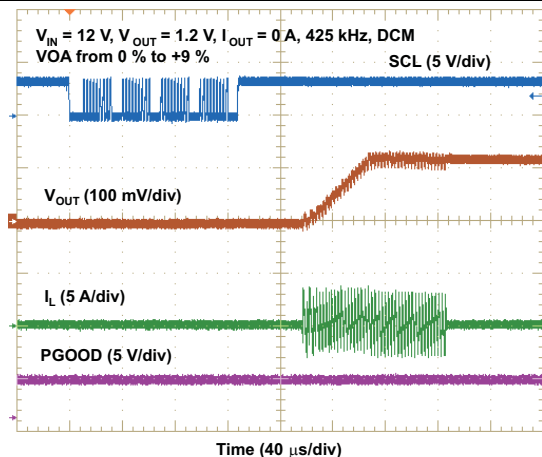

Figure 23. No-Load V_{OUT} Adjustment Waveforms

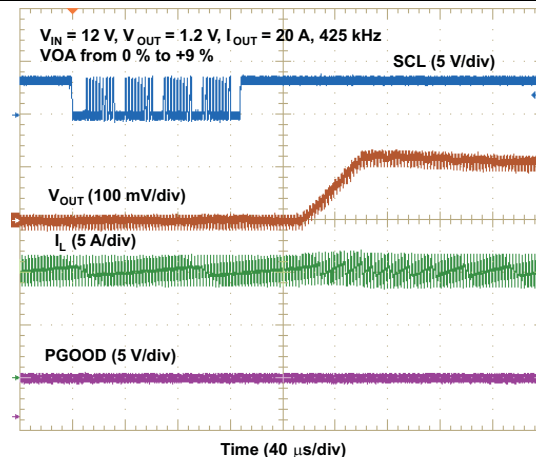

Figure 24. Full-Load V_{OUT} Adjustment Waveforms

Typical Characteristics (continued)

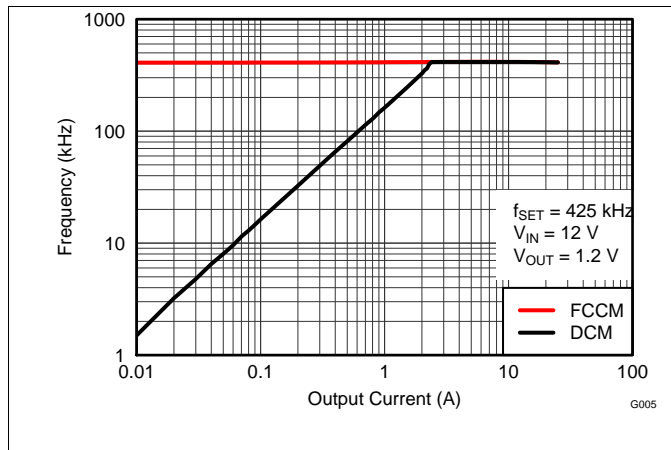

Figure 25. Switching Frequency vs. Output Current

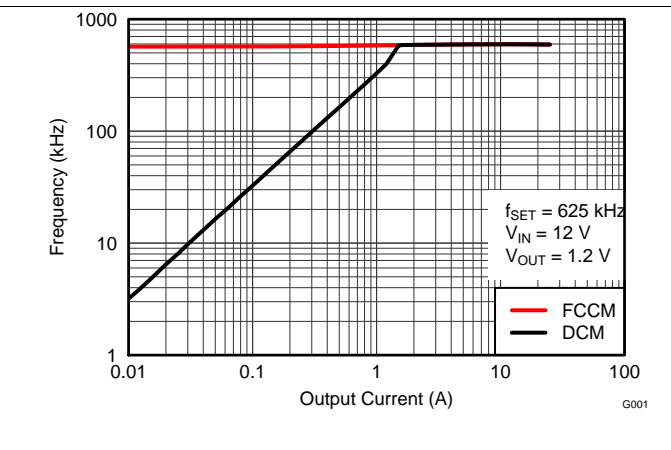

Figure 26. Switching Frequency vs. Output Current

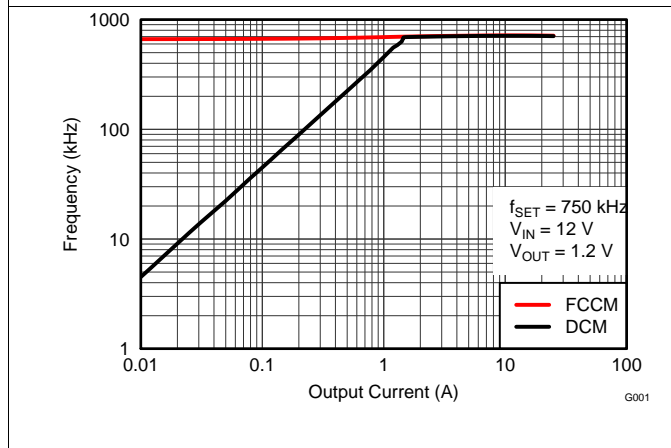

Figure 27. Switching Frequency vs. Output Current

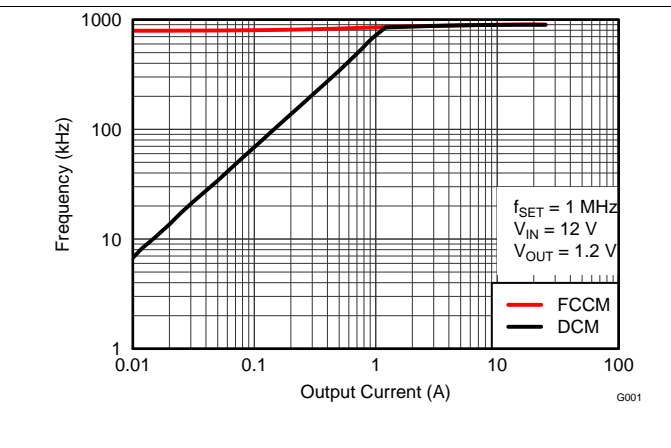

Figure 28. Switching Frequency vs. Output Current

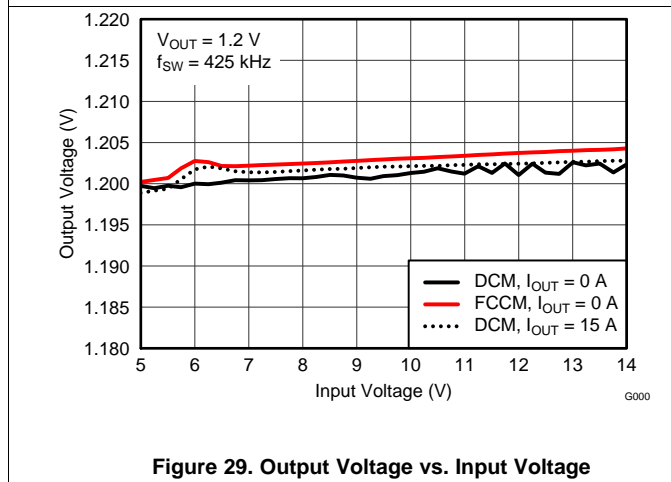

Figure 29. Output Voltage vs. Input Voltage

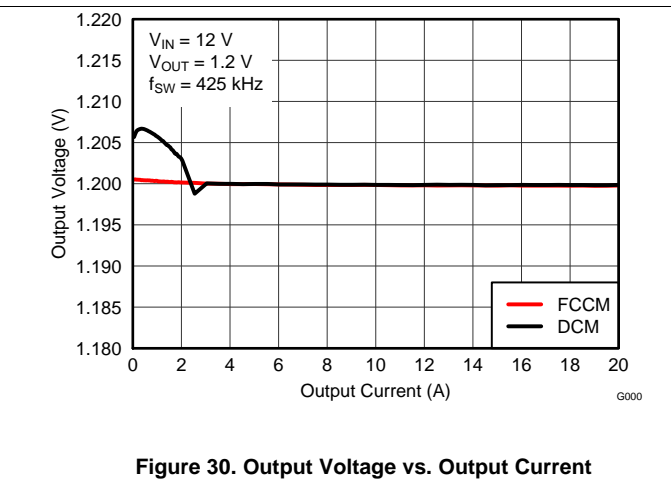
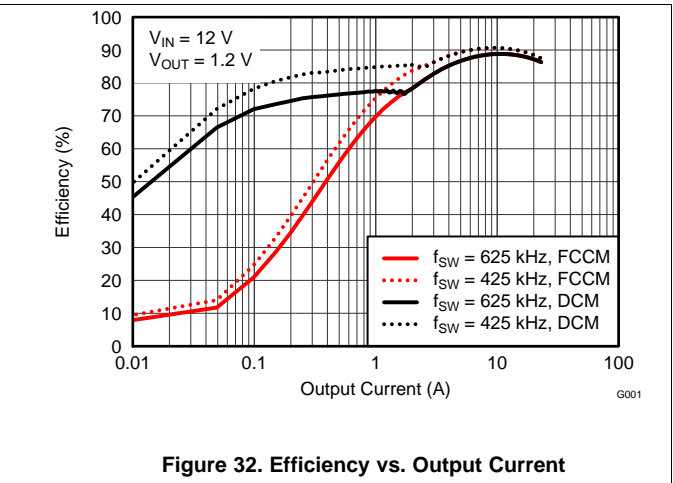
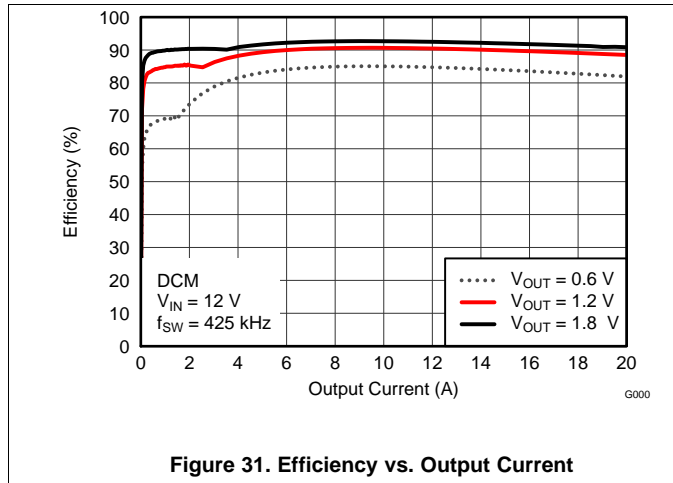

Figure 30. Output Voltage vs. Output Current

Typical Characteristics (continued)



7 Detailed Description

7.1 Overview

The TPS53819A is a high-efficiency, single-channel, synchronous buck regulator controller that uses the PMBus protocol. It is suitable for low output voltage, point-of-load applications in computing and similar digital consumer applications. The device features proprietary D-CAP2 mode control combined with adaptive on-time architecture. This combination is ideal for building modern low duty-ratio and ultra-fast load step response DC-DC converters. The output voltage ranges from 0.6 V to 5.5 V. The conversion input voltage range is from 3 V to 28 V. The D-CAP2 mode uses emulated current information to control the loop modulation. One advantage of this control scheme is that it does not require an external phase compensation network, which makes it easy to use. It also allows for a low external component count. The switching frequency is selectable from eight preset values through the PMBus interface. Adaptive on-time control tracks the preset switching frequency over a wide range of input and output voltages while increasing the switching frequency as needed during load step transient.

7.2 Functional Block Diagram

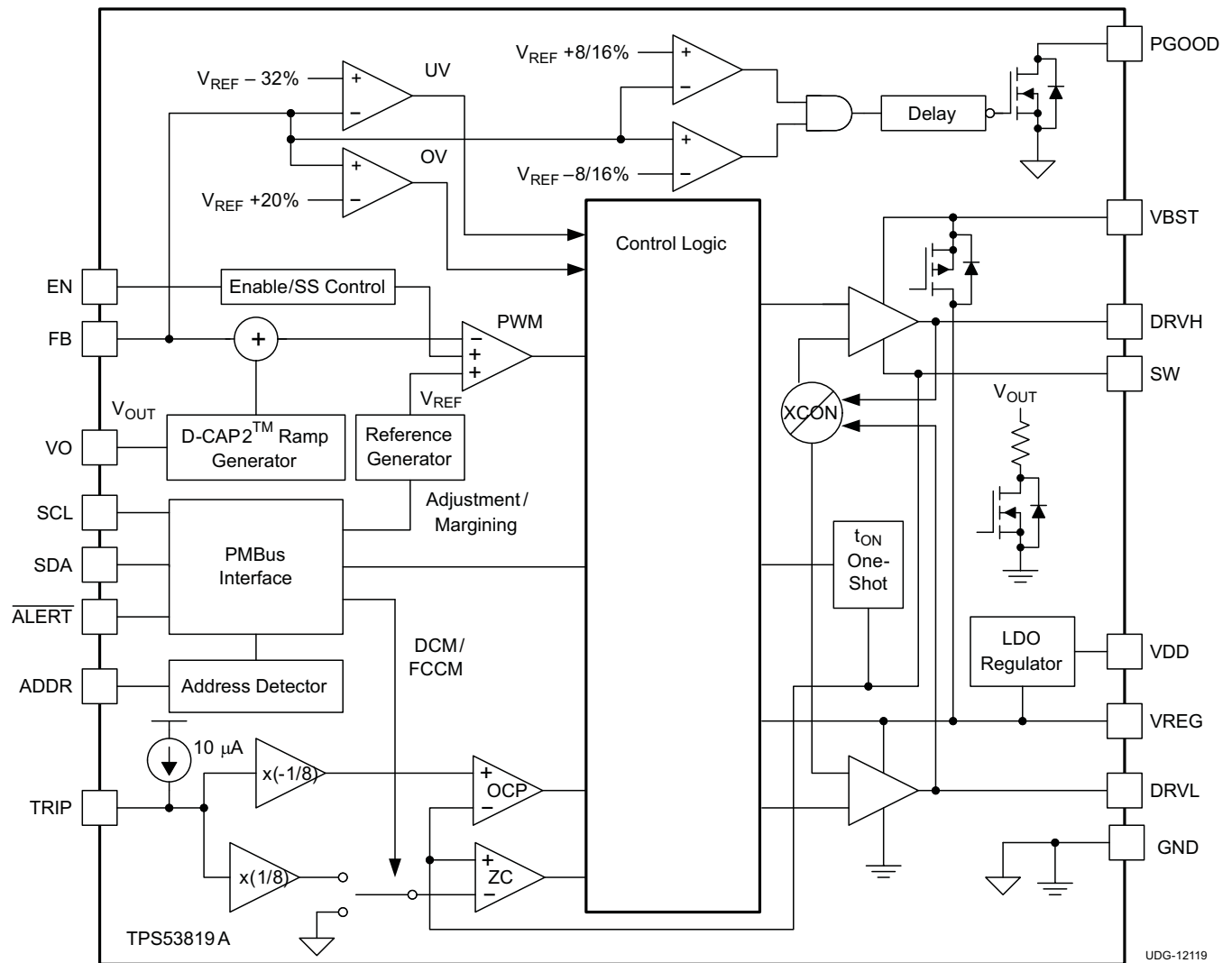

7.3 Feature Description

7.3.1 Enable and Soft-Start

When the EN pin voltage rises above the enable threshold voltage and/or ON_OFF bit is set via PMBus according to the setting in OPERATION command, the controller enters a start-up sequence. After a programmed power-on-delay duration from 0.35 ms to 32.86 ms, the internal DAC starts ramping up the reference voltage from 0 V to a target voltage (typically 0.6 V) with the programmed soft-start time from 1 ms to 8 ms. The device maintains a smooth and constant output voltage ramp-up during start-up regardless of load current.

7.3.2 Adaptive On-Time Control

The TPS53819A does not have a dedicated oscillator. The device operates with a pseudo-constant frequency by feed-forwarding the input and output voltages into the on-time one-shot timer. The adaptive on-time control adjusts the on-time to be inversely proportional to the input voltage and proportional to the output voltage ($t_{ON} \propto V_{OUT}/V_{IN}$). This makes the switching frequency fairly constant in steady state conditions over a wide input voltage range. The switching frequency is selectable from 275 kHz to 1 MHz via PMBus (FREQUENCY_CONFIG).

7.3.3 Zero Crossing Detection

The TPS53819A uses a low offset comparator to detect SW node zero crossing event in order to optimize turn-off timing of low-side MOSFET.

7.3.4 Output Discharge Control

When the EN pin voltage falls below the enable threshold voltage and/or ON_OFF bit is reset via PMBus according to the setting in OPERATION command, the TPS53819A discharges output capacitor using internal MOSFET connected between the VOUT pin and the GND pin while the high-side and low-side MOSFETs are maintained in the OFF state. The typical discharge resistance is 40 Ω .

7.3.5 Low-Side Driver

The low-side driver is designed to drive high-current, low- $R_{DS(on)}$, N-channel MOSFETs. The drive capability is represented by the internal resistance, which is 0.9 Ω for VREG to DRV_L and 0.5 Ω for DRV_L to GND. A dead-time period to prevent shoot through is internally generated between high-side MOSFET OFF to low-side MOSFET ON, and low-side MOSFET OFF to high-side MOSFET ON. The 5-V, VREG supply voltage delivers the bias voltage. A bypass capacitor connected between the VREG and GND pins supplies the instantaneous drive current. Equation 1 shows the average low-side gate drive current.

$$I_{GL} = C_{GL} \times V_{VDRV} \times f_{SW} \quad (1)$$

7.3.6 High-Side Driver

The high-side driver drives high current, low $R_{DS(on)}$, N-channel MOSFETs. When configured as a floating driver, the VREG pin supply delivers the bias voltage. Equation 2 shows the average high-side gate current.

$$I_{GH} = C_{GH} \times V_{VDRV} \times f_{SW} \quad (2)$$

The flying capacitor between the VBST and SW pins supplies the instantaneous drive current. The internal resistance, which is 1.6 Ω for VBST to DRV_H and 0.6 Ω for DRV_H to SW represents the drive capability. Equation 3 calculates the driver power dissipation required for the TPS53819A

$$P_{DRV} = (I_{GL} + I_{GH}) \times V_{VDRV} \quad (3)$$

7.3.7 Power Good

The TPS53819A indicates the switcher output is within the target range when the power-good output is high. The power-good function activates after the soft-start operation has finished. If the output voltage comes within $\pm 8\%$ of the target value, internal comparators detect power-good state and the power-good signal becomes high after a programmed delay time between 0.25 ms and 131 ms. If the output voltage goes outside of $\pm 16\%$ of the target value, the power-good signal becomes low after a 2- μ s internal delay. The power-good output is an open drain output and must be pulled up externally.

Feature Description (continued)

7.3.8 Current Sense and Overcurrent Protection

TPS53819A has cycle-by-cycle overcurrent limiting control. The inductor current is monitored during the OFF state and the controller maintains the OFF state during the period when inductor current is larger than the overcurrent trip level. In order to provide both good accuracy and cost effective solution, TPS53819A supports temperature compensated MOSFET on-resistance ($R_{DS(on)}$) sensing. The TRIP pin should be connected to GND through the trip voltage setting resistor, R_{TRIP} . The TRIP terminal sources I_{TRIP} current, which is 10 μ A typically at room temperature, and the trip level is set to the OCL trip voltage V_{TRIP} as shown in Equation 4. Note that the V_{TRIP} is limited up to approximately 3 V internally.

$$V_{TRIP} \text{ (mV)} = R_{TRIP} \text{ (k}\Omega\text{)} \times I_{TRIP} \text{ (}\mu\text{A)} \quad (4)$$

The inductor current is monitored by the voltage between GND pin and SW pin so that SW pin should be properly connected to the drain terminal of the low-side MOSFET. The TRIP current has a 4700-ppm/ $^{\circ}$ C temperature slope to compensate the temperature dependency of the on-resistance. The device uses the GND pin as the positive current sensing node. As the comparison occurs during the OFF state, V_{TRIP} sets the valley level of the inductor current. Thus, the average load current at the overcurrent threshold, I_{OCP} , is calculated as shown in Equation 5.

$$I_{OCP} = \frac{V_{TRIP}}{(8 \times R_{DS(on)})} + \frac{I_{IND(ripple)}}{2} = \frac{V_{TRIP}}{(8 \times R_{DS(on)})} + \frac{1}{2 \times L \times f_{SW}} \times \frac{(V_{IN} - V_{OUT}) \times V_{OUT}}{V_{IN}} \quad (5)$$

In an overcurrent condition, the load current exceeds the inductor current delivered to the output capacitor, thus the output voltage tends to fall. Eventually, it crosses the undervoltage protection threshold and the device shuts down. If hiccup mode is selected, then after a hiccup delay time (8.96 ms + 7x programmed soft-start time), the controller restarts. If the overcurrent condition remains, the procedure is repeated and the device enters hiccup mode. During the CCM, the negative current limit (NCL) protects the external FET from carrying too much current. The OCLN detect threshold is set at the same absolute value as positive current limit (OCLP) but with negative polarity. Note that the threshold still represents the valley value of the inductor current. When an OCLP or OCLN event occurs, the corresponding fault signals (IOUT_OC and IOUT) of the STATUS_WORD register is latched to indicate the faults and can be read via PMBus.

7.3.9 Overvoltage and Undervoltage Protection

TPS53819A monitors a resistor divided feedback voltage to detect overvoltage and undervoltage conditions. When the feedback voltage becomes lower than 68% of the target voltage, the undervoltage protection (UVP) comparator output goes high and an internal UVP delay time counter begins counting. After 1 ms, the device turns OFF both high-side and low-side MOSFETs drivers. If the hiccup mode is selected, then the controller restarts after a hiccup delay time (8.96 ms + 7 x programmed soft-start time). This function is enabled after the soft-start operation is completed. When the feedback voltage becomes higher than 120% of the target voltage, the overvoltage protection (OVP) comparator output goes high and the circuit latches OFF the high-side MOSFET driver and latches ON the low-side MOSFET driver. If the sensed inductor current reaches the negative current limit, then the low-side MOSFET driver is turned OFF, and high-side MOSFET driver is turned ON with an appropriate on-time to limit the inductor current while the output voltage discharges.

7.3.10 Out-of-Bound Protection

TPS53819A has an out-of-bound (OOB) overvoltage protection that tries to protect the output load at a much lower overvoltage threshold of 8% above the target voltage. OOB protection does not trigger an overvoltage fault, so the device is not latched off after an OOB event. OOB protection is intended as an early no-fault overvoltage protection mechanism, in addition to the official overvoltage protection as described in the [Overvoltage and Undervoltage Protection](#) section.

7.3.11 UVLO Protection

The TPS53819A has VDD undervoltage lockout protection (UVLO). When the VDD voltage is lower than the programmed UVLO threshold voltage, the switch mode power supply shuts OFF. This is a non-latch protection, but if VDD UVLO occurs when the switcher is enabled by either EN pin or ON_OFF bit via PMBus, the corresponding fault signals (VIN_UV and INPUT) of the STATUS_WORD register latch off to indicate the fault condition, and can be read via PMBus.

Feature Description (continued)

7.3.12 Thermal Shutdown

The TPS53819A has an over-temperature protection feature. If the temperature exceeds the threshold value (typically 140°C), the device is shut OFF. This is a non-latch protection, but when the temperature exceeds the threshold value, the corresponding fault signal (TEMP) of the STATUS_WORD register latches off to indicate the fault condition, and can be read via PMBus.

7.4 Device Functional Modes

7.4.1 Light-Load Condition in Auto-Skip Operation (Eco-mode)

If the discontinuous conduction mode (DCM) is selected via PMBus (MODE_SOFT_START_CONFIG), TPS53819A automatically reduces the switching frequency at light-load conditions to maintain high efficiency. Specifically, as the output current decreases from heavy load condition, the inductor current is also reduced and eventually comes to the point that its ripple valley current touches zero level, which is the boundary between continuous conduction mode (CCM) and discontinuous conduction mode (DCM). The synchronous MOSFET is turned OFF when this zero inductor current is detected. As the load current further decreases, the converter runs into DCM.

NOTE

The zero current must be detected for at least 16 switching cycles to switch from CCM to DCM.

The on-time remains almost the same as continuous conduction mode so that it takes longer time to discharge the output capacitor with smaller load current to the reference voltage level. The transition point to the light-load operation $I_{OUT(LL)}$ (i.e., the threshold between continuous and discontinuous conduction mode) is calculated in [Equation 6](#).

$$I_{OUT(LL)} = \frac{1}{2 \times L \times f_{SW}} \times \frac{(V_{IN} - V_{OUT}) \times V_{OUT}}{V_{IN}}$$

where

- f_{SW} is the PWM switching frequency (6)

Switching frequency versus output current in the light-load condition is a function of L , V_{IN} and V_{OUT} , but it decreases almost proportionally to the output current when below the $I_{OUT(LL)}$ given in [Equation 6](#). For example, it is 65 kHz at $I_{O(LL)}/5$ if the frequency setting is 325 kHz.

7.4.2 Forced Continuous Conduction Mode

When the forced continuous conduction mode (FCCM) is selected via PMBus (MODE_SOFT_START_CONFIG), the controller maintains continuous conduction mode even in light-load condition. In FCCM mode, switching frequency maintains a constant level over the entire load range which is suitable for applications that need tight control of the switching frequency at a cost of lower efficiency. During the soft-start time, the controller maintains discontinuous conduction mode, and then switches to continuous conduction mode if FCCM is selected after the soft-start operation is completed.

7.4.3 D-CAP2™ Mode

From small-signal loop analysis, a buck converter using D-CAP2™ mode control architecture can be simplified as shown in [Figure 33](#).

Device Functional Modes (continued)

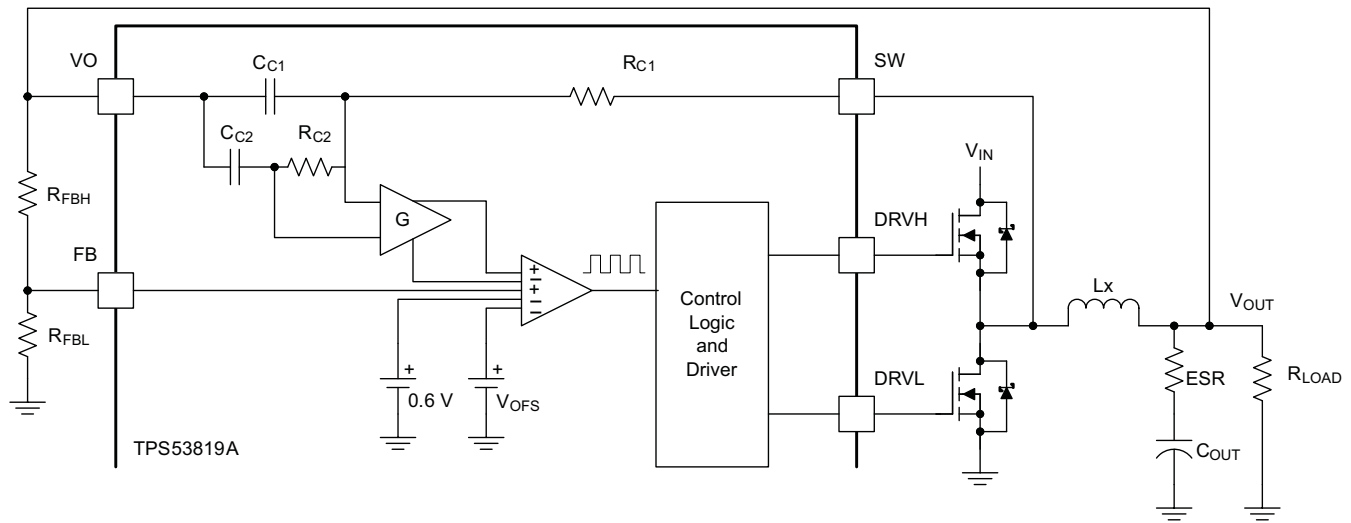

UDG-12120

Figure 33. Simplified Modulator Using D-CAP2™ Control Architecture

The D-CAP2 control architecture in TPS53819A includes an internal ripple generation network enabling the use of very low-ESR output capacitors such as multi-layer ceramic capacitors (MLCC). No external current sensing networks or compensators are required with D-CAP2 control architecture in order to simplify the power supply design. The role of the internal ripple generation network is to emulate the ripple component of the inductor current information and then combine it with the voltage feedback signal. V_{OFS} is the internal offset to compensate the offset caused by the internal ripple, and the typical V_{OFS} value is 4 mV. The 0-dB frequency of the D-CAP2 architecture can be approximated as shown in Equation 7.

$$f_0 = \frac{R_{C1} \times C_{C1} \times 0.6 \times (0.67 + D)}{2\pi \times G \times L_X \times C_{OUT} \times V_{OUT}}$$

where

- G is gain of the amplifier which amplifies the ripple current information generated by the network
- D is the duty ratio

(7)

The typical G value is 0.25. The $R_{C1}C_{C1}$ time constant value varies according to the selected switching frequency as shown in Table 1.

Table 1. Switching Frequency Selection

SWITCHING FREQUENCY (kHz)	$R_{C1}C_{C1}$ TIME CONSTANT (μ s)
275	75
325	
425	62
525	
625	48
750	
850	36
1000	

In order to secure enough phase margin, consider that f_0 should be lower than 1/3 of the switching frequency, but is also higher than 5 times the f_{C2} as shown in [Equation 8](#).

$$5 \times f_{C2} \leq f_0 \leq \frac{f_{SW}}{3}$$

where

- f_{C2} is determined by the internal network of R_{C2} and C_{C2} (1.4 kHz typ) (8)

This example describes a DC-DC converter with an input voltage range of 12-V and an output voltage of 1.2-V. If the switching frequency is 525 kHz and the inductor is given as 0.44μH, then C_{OUT} should be larger than 197 μF, and also be smaller than 4.9 mF based on the design requirements. The characteristics of the capacitors should be also taken into considerations. For MLCC, use X5R or better dielectric and take into account derating of the capacitance by both DC bias and AC bias. When derating by DC bias and AC bias are 80% and 50%, respectively, the effective derating is 40% because $0.8 \times 0.5 = 0.4$. The capacitance of specialty polymer capacitors may change depending on the operating frequency. Consult capacitor manufacturers for specific characteristics.

7.5 Programming

7.5.1 PMBus General Descriptions

The TPS53819A has seven internal custom user-accessible 8-bit registers. The PMBus interface has been designed for program flexibility, supporting a direct format for write operation. Read operations are supported for both combined format and stop separated format. While there is no auto increment or decrement capability in the TPS53819A PMBus logic, a tight software loop can be designed to randomly access the next register, regardless of which register was accessed first. The START and STOP commands frame the data packet and the REPEAT START condition is allowed when necessary.

The device can operate in either standard mode (100 kb/s) or fast mode (400 kb/s).

7.5.2 PMBus Slave Address Selection

The seven-bit slave address is $001A_3A_2A_1A_0x$, where $A_3A_2A_1A_0$ is set by the ADDR pin on the device. Bit 0 is the data direction bit, i.e., $001A_3A_2A_1A_00$ is used for write operation and $001A_3A_2A_1A_01$ is used for read operation.

7.5.3 PMBus Address Selection

The TPS53819A allows up to 16 different chip addresses for PMBus communication, with the first three bits fixed as 001. The address selection process is defined by the resistor divider ratio from VREG pin to ADDR pin, and the address detection circuit starts to work only after VDD input supply has risen above its UVLO threshold. The table below lists the divider ratio and some example resistor values. The 1% tolerance resistors with typical temperature coefficient of $\pm 100\text{ppm}/^\circ\text{C}$ are recommended. Higher performance resistors can be used if tighter noise margin is required for more reliable address detection, as shown in [Table 2](#).

Table 2. PMBus Address Selection Settings

PMBus ADDRESS	RESISTOR DIVIDER RATIO	DIVIDER RATIO RANGE		HIGH-SIDE RESISTANCE (k Ω)	LOW-SIDE RESISTANCE (k Ω)
		LOW	HIGH		
00111111	> 0.557	—		1	300
00111110	0.509	0.4958	0.5247	160	165
00111101	0.461	0.4482	0.4772	180	154
00111100	0.416	0.4073	0.4294	200	143
00110111	0.375	0.3662	0.3886	200	120
00110110	0.334	0.3249	0.3476	220	110
00110011	0.297	0.2905	0.3067	249	105
00110010	0.263	0.2560	0.2725	249	88.7
00101111	0.229	0.2215	0.2385	240	71.5
00101110	0.195	0.1870	0.2044	249	60.4
00101011	0.160	0.1524	0.1703	249	47.5
00101010	0.126	0.1179	0.1363	249	36.0
00100111	0.096	0.0900	0.1024	255	27.0
00100110	0.068	0.0622	0.0752	255	18.7
00100011	0.041	0.0340	0.0480	270	11.5
00100010	< 0.013	—		300	1

7.5.4 Supported Formats

The supported formats are described in this section.

7.5.4.1 Direct Format: Write

The simplest format for a PMBus write is direct format. After the start condition [S], the slave chip address is sent, followed by an eighth bit indicating a write. The TPS53819A then acknowledges that it is being addressed, and the master responds with an 8-bit register address byte. The slave acknowledges and the master sends the appropriate 8-bit data byte. Again the slave acknowledges and the master terminates the transfer with the stop condition [P].

7.5.4.2 Combined Format: Read

After the start condition [S], the slave chip address is sent, followed by an eighth bit indicating a write. The TPS53819A then acknowledges that it is being addressed, and the master responds with an 8-bit register address byte. The slave acknowledges and the master sends the repeated start condition [Sr]. Again the slave chip address is sent, followed by an eighth bit indicating a read. The slave responds with an acknowledge followed by previously addressed 8 bit data byte. The master then sends a non-acknowledge (NACK) and finally terminates the transfer with the stop condition [P].

7.5.4.3 Stop-Separated Reads

Stop-separated read features are also available. This format allows a master to initialize the register address pointer for a read and return to that slave at a later time to read the data. In this format the slave chip address followed by a write bit are sent after a start [S] condition. The TPS53819A then acknowledges it is being addressed, and the master responds with the 8-bit register address byte. The master then sends a stop or restart condition and may then address another slave. After performing other tasks, the master can send a start or restart condition to the device with a read command. The device acknowledges this request and returns the data from the register location that had been set up previously.

7.5.5 Supported PMBus Commands

The TPS53819A supports the PMBus commands shown in [Table 1](#) only. Not all features of each PMBus command are supported. The CLEAR_FAULTS, STORE_DEFAULT_ALL and RESTORE_DEFAULT_ALL commands have no data bytes. The non-volatile memory (NVM) cells inside the TPS53819A can permanently store some registers.

Table 3. Supported PMBus Commands

COMMAND	NOTES
OPERATION	Turn on or turn off switching converter only
ON_OFF_CONFIG	ON/OFF configuration
CLEAR_FAULTS	Clear all latched status flags
WRITE_PROTECT	Control writing to the PMBus device
STORE_DEFAULT_ALL	Store contents of user-accessible registers to non-volatile memory cells
RESTORE_DEFAULT_ALL	Copy contents of non-volatile memory cells to user-accessible registers
STATUS_WORD	PMBus read-only status and flag bits
CUSTOM_REG	MFR_SPECIFIC_00 (Custom Register 0): Custom register
DELAY_CONTROL	MFR_SPECIFIC_01 (Custom Register 1): Power on and power good delay times
MODE_SOFT_START_CONFIG	MFR_SPECIFIC_02 (Custom Register 2): Mode and soft-start time
FREQUENCY_CONFIG	MFR_SPECIFIC_03 (Custom Register 3): Switching frequency control
VOUT_ADJUSTMENT	MFR_SPECIFIC_04 (Custom Register 4): Output voltage adjustment control
VOUT_MARGIN	MFR_SPECIFIC_05 (Custom Register 5): Output voltage margin levels
UVLO_THRESHOLD	MFR_SPECIFIC_06 (Custom Register 6): Turn-on input voltage UVLO threshold

7.5.6 Unsupported PMBus Commands

Do not send any unsupported commands to the TPS53819A. Even though the device receives an unsupported commands, it can acknowledge the unsupported commands and any related data bytes by properly sending the ACK bits. However, the device ignores the unsupported commands and any related data bytes, which means they do not affect the device operation in any way. Although the TPS53819A may acknowledge but ignore unsupported commands and data bytes, it can however, set the CML bit in the STATUS_BYTE register and then pull down the ALERT pin to notify the host. For this reason, unsupported commands and data bytes should not be sent to TPS53819A.

7.6 Register Maps

7.6.1 OPERATION [01h] (R/W Byte)

The TPS53819A supports only the functions of the OPERATION command shown in [Table 4](#).

Table 4. OPERATION Command Supported Functions

COMMAND	DEFINITION	DESCRIPTION	NVM
OPERATION<7>	ON_OFF	0: turn off switching converter 1: turn on switching converter	—
OPERATION<6>	—	not supported and don't care	—
OPERATION<5:2>	OPMARGIN<3:0>	00xx: turn off output voltage margin function 0101: turn on output voltage margin low and ignore fault 0110: turn on output voltage margin low and act on fault 1001: turn on output voltage margin high and ignore fault 1010: turn on output voltage margin high and act on fault	—
OPERATION<1>	—	not supported and don't care	—
OPERATION<0>	—	not supported and don't care	—

7.6.2 ON_OFF_CONFIG [02h] (R/W Byte)

The TPS53819A supports only the functions of the ON_OFF_CONFIG command shown in [Table 5](#).

Table 5. ON_OFF_CONFIG Command Supported Functions

COMMAND	DEFINITION	DESCRIPTION	NVM
ON_OFF_CONFIG<7>	—	not supported and don't care	—
ON_OFF_CONFIG<6>	—	not supported and don't care	—
ON_OFF_CONFIG<5>	—	not supported and don't care	—
ON_OFF_CONFIG<4>	PU	not supported and always set to 1	—
ON_OFF_CONFIG<3>	CMD	0: ignore ON_OFF bit (OPERATION<7>) ⁽¹⁾ 1: act on ON_OFF bit (OPERATION<7>)	Yes
ON_OFF_CONFIG<2>	CP	0: ignore EN pin 1: act on EN pin ⁽¹⁾	Yes
ON_OFF_CONFIG<1>	PL	not supported and always set to 1	—
ON_OFF_CONFIG<0>	SP	not supported and always set to 1	—

(1) TI default.

Conditions required to enable the switcher:

- If CMD is cleared and CP is set, then the switcher can be enabled only by the EN pin.
- If CMD is set and CP is cleared, then the switcher can be enabled only by the ON_OFF bit (OPERATION<7>) via PMBus.
- If both CMD and CP are set, then the switcher can be enabled only when both the ON_OFF bit (OPERATION<7>) and the EN pin are commanding to enable the device.
- If both CMD and CP are cleared, then the switcher is automatically enabled after the ADDR detection sequence completes, regardless of EN pin and ON_OFF bit polarities.

7.6.3 WRITE_PROTECT [10h] (R/W Byte)

The WRITE_PROTECT command is used to control writing to the PMBus device. The intent of this command is to provide protection against accidental changes. This command has one data byte as described in [Table 6](#).

Table 6. WRITE_PROTECT Command Supported Functions

COMMAND	DEFINITION	DESCRIPTION	NVM	
WRITE_PROTECT<7:0>	WP<7:0>	10000000:	Disable all writes, except the WRITE_PROTECT command.	—
		01000000:	Disable all writes, except the WRITE_PROTECT and OPERATION commands.	—
		00100000:	Disable all writes, except the WRITE_PROTECT, OPERATION, and ON_OFF_CONFIG commands.	—
		00000000:	Enable writes to all commands.	—
		Others:	Fault data	—

7.6.4 CLEAR_FAULTS [03h] (Send Byte)

The CLEAR_FAULTS command is used to clear any fault bits in the STATUS_WORD and STATUS_BYTE registers that have been set. This command clears all bits in all status registers. Simultaneously, the TPS53819A releases its ALERT signal output if the device is asserting the ALERT signal. If the fault condition is still present when the bit is cleared, the fault bits shall immediately be set again, and the ALERT signal should also be re-asserted.

The CLEAR_FAULTS does not cause a unit that has latched off for a fault condition to restart. Units that have been shut down for a fault condition can be restarted with one of the following conditions.

- The output is commanded through the EN pin and/or ON_OFF bit based on the ON_OFF_CONFIG setting to turn off and then to turn back on.
- VDD power is cycled for TPS53819A

The CLEAR_FAULT command is used to clear the fault bits in the STATUS_WORD and STATUS_BYTE commands, and to release the ALERT pin. It is recommended not to send CLEAR_FAULT command when there is no fault to cause the ALERT pin to pull down.

7.6.5 STORE_DEFAULT_ALL [11h] (Send Byte)

The STORE_DEFAULT_ALL command instructs TPS53819A to copy the entire contents of the operating memory to the corresponding locations in the NVM. The updated contents in the non-volatile memory (NVM)s become the new default values. The STORE_DEFAULT_ALL command can be used while the device is operating. However, the device may be unresponsive during the copy operation with unpredictable results. (see *PMBus Power System Management Protocol Specification, Part II - Command Language, Revision, 1.2, 6 Sept. 2010. www.powerSIG.org*). It is recommended not to exceed 1000 write/erase cycles for non-volatile memory (NVM).

7.6.6 RESTORE_DEFAULT_ALL [12h] (Send Byte)

The RESTORE_DEFAULT_ALL command instructs TPS53819A to copy the entire contents of the NVMs to the corresponding locations in the operating memory. The values in the operating memory are overwritten by the value retrieved from the NVM. It is permitted to use the RESTORE_DEFAULT_ALL command while the device is operating. However, the device may be unresponsive during the copy operation with unpredictable results.

7.6.7 STATUS_WORD [79h] (Read Word)

The TPS53819A does not support all functions of the STATUS_WORD command. A list of supported functions appears in Table 7. A status bit reflects the current state of the converter. Status bit becomes high when the specified condition has occurred and goes low when the specified condition has disappeared. A flag bit is a latched bit that becomes high when the specified condition has occurred and does not go back low when the specified condition has disappeared. STATUS_BYTE command is a subset of the STATUS_WORD command, or more specifically the lower byte of the STATUS_WORD.

Table 7. STATUS_WORD Command Supported Functions

COMMAND	DEFINITION	DESCRIPTION
LOW BYTE: STATUS_BYTE [78h]		
Low STATUS_WORD<7>	BUSY	not supported and always set to 0
Low STATUS_WORD<6>	OFF	0: raw status indicating device is providing power to output voltage 1: raw status indicating device is not providing power to output voltage
Low STATUS_WORD<5>	VOUT_OV	0: latched flag indicating no output voltage overvoltage fault has occurred 1: latched flag indicating an output voltage overvoltage fault has occurred
Low STATUS_WORD<4>	IOUT_OC	0: latched flag indicating no output current overcurrent fault has occurred 1: latched flag indicating an output current overcurrent fault has occurred
Low STATUS_WORD<3>	VIN_UV	0: latched flag indicating input voltage is above the UVLO turn-on threshold 1: latched flag indicating input voltage is below the UVLO turn-on threshold
Low STATUS_WORD<2>	TEMP	0: latched flag indicating no OT fault has occurred 1: latched flag indicating an OT fault has occurred
Low STATUS_WORD<1>	CML	0: latched flag indicating no communication, memory or logic fault has occurred 1: latched flag indicating a communication, memory or logic fault has occurred
Low STATUS_WORD<0>	OTHER	not supported and always set to 0
HIGH BYTE		
High STATUS_WORD<7>	VOUT	0: latched flag indicating no output voltage fault or warning has occurred 1: latched flag indicating a output voltage fault or warning has occurred
High STATUS_WORD<6>	IOUT	0: latched flag indicating no output current fault or warning has occurred 1: latched flag indicating an output current fault or warning has occurred
High STATUS_WORD<5>	INPUT	0: latched flag indicating no input voltage fault or warning has occurred 1: latched flag indicating a input voltage fault or warning has occurred
High STATUS_WORD<4>	MFR	not supported and always set to 0
High STATUS_WORD<3>	$\overline{\text{PGOOD}}$	0: raw status indicating PGOOD pin is at logic high 1: raw status indicating PGOOD pin is at logic low
High STATUS_WORD<2>	FANS	not supported and always set to 0
High STATUS_WORD<1>	OTHER	not supported and always set to 0
High STATUS_WORD<0>	UNKNOWN	not supported and always set to 0

The latched flags of faults can be removed or corrected only until **one** of the following conditions occurs:

- The device receives a CLEAR_FAULTS command.
- The output is commanded through the EN pin and/or ON_OFF bit based on the ON_OFF_CONFIG setting to turn off and then to turn back on
- VDD power is cycled for TPS53819A

If the fault condition remains present when the bit is cleared, the fault bits are immediately set again, and the ALERT signal is re-asserted.

TPS53819A supports the $\overline{\text{ALERT}}$ pin to notify the host of fault conditions. Therefore, the best practice for monitoring the fault conditions from the host is to treat the $\overline{\text{ALERT}}$ pin as an interrupt source for triggering the corresponding interrupt service routine. It is recommended not to keep polling the STATUS_WORD or STATUS_BYTE registers from the host to reduce the firmware overhead of the host.

7.6.8 CUSTOM_REG (MFR_SPECIFIC_00) [D0h] (R/W Byte)

Custom register 0 provides the flexibility for users to store any desired non-volatile information. For example, users can program this register to track versions of implementation or other soft identification information. The details of each setting are listed in [Table 8](#).

Table 8. CUSTOM_REG (MFR_SPECIFIC_00) Settings

COMMAND	DEFINITION	DESCRIPTION	NVM
CUSTOM_REG<7>	—	not supported and don't care	—
CUSTOM_REG<6>	—	not supported and don't care	—
CUSTOM_REG<5:0>	CUSTOMWORD <5:0>	00000: ⁽¹⁾ can be used to store any desired non-volatile information.	Yes

(1) TI default

7.6.9 DELAY_CONTROL (MFR_SPECIFIC_01) [D1h] (R/W Byte)

Custom register 1 provides software control over key timing parameters of the controller: Power-on delay (POD) time and power-good delay (PGD) time. The details of each setting are listed in [Table 9](#).

Table 9. DELAY_CONTROL (MFR_SPECIFIC_01) Settings

COMMAND	DEFINITION	DESCRIPTION	NVM
DELAY_CONTROL<7>	—	not supported and don't care	—
DELAY_CONTROL<6>	—	not supported and don't care	—
DELAY_CONTROL<5:3>	PGD<2:0>	000: 256 μ s 001: 512 μ s 010: 1.024 ms ⁽¹⁾ 011: 2.048 ms 100: 4.096 ms 101: 8.192 ms 110: 16.384 ms 111: 131.072 ms	Yes
DELAY_CONTROL<2:0>	POD<2:0>	000: 356 μ s 001: 612 μ s 010: 1.124 ms ⁽¹⁾ 011: 2.148 ms 100: 4.196 ms 101: 8.292 ms 110: 16.484 ms 111: 32.868 ms	Yes

(1) TI default

7.6.10 MODE_SOFT_START_CONFIG (MFR_SPECIFIC_02) [D2h] (R/W Byte)

Custom register 2 provides software control over mode selection and soft-start time (t_{SS}). The details of each setting are listed in [Table 10](#).

Table 10. MODE_SOFT_START_CONFIG (MFR_SPECIFIC_02) Settings

COMMAND	DEFINITION	DESCRIPTION	NVM
MODE_SOFT_START_CONFIG<7>	—	not supported and don't care	—
MODE_SOFT_START_CONFIG<6>	—	not supported and don't care	—
MODE_SOFT_START_CONFIG<5>	—	not supported and don't care	—
MODE_SOFT_START_CONFIG<4>	—	not supported and don't care	—
MODE_SOFT_START_CONFIG<3:2>	SST<1:0>	00: 1 ms ⁽¹⁾ 01: 2 ms 10: 4 ms 11: 8 ms	Yes
MODE_SOFT_START_CONFIG<1>	HICLOFF	0: hiccup after UV ⁽¹⁾ Hiccup interval is (8.96 ms + soft-start time × 7) 1: latch-off after UV	Yes
MODE_SOFT_START_CONFIG<0>	CM	0: DCM ⁽¹⁾ 1: FCCM	Yes

(1) TI Default

[Figure 34](#) shows the soft-start timing diagram of TPS53819A with the programmable power-on delay time (t_{POD}), soft-start time (t_{SST}), and PGOOD delay time (t_{PGD}). During the soft-start time, the controller remains in discontinuous conduction mode (DCM), and then switches to forced continuous conduction mode (FCCM) at the end of soft-start if CM bit (MODE_SOFT_START_CONFIG<0>) is set.

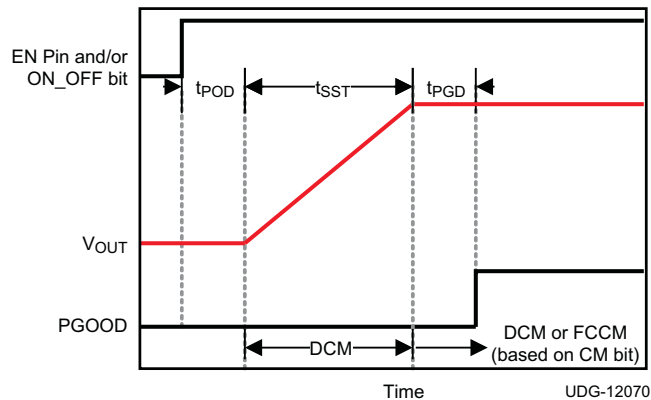

Figure 34. Programmable Soft-Start Timing

7.6.11 FREQUENCY_CONFIG (MFR_SPECIFIC_03) [D3h] (R/W Byte)

Custom register 3 provides software control over frequency setting (FS). The details of FS setting are listed in [Table 11](#).

Table 11. FREQUENCY_CONFIG (MFR_SPECIFIC_03) Settings

COMMAND	DEFINITION	DESCRIPTION	NVM
FREQUENCY_CONFIG<7>	—	not supported and don't care	—
FREQUENCY_CONFIG<6>	—	not supported and don't care	—
FREQUENCY_CONFIG<5>	—	not supported and don't care	—
FREQUENCY_CONFIG<4>	—	not supported and don't care	—
FREQUENCY_CONFIG<3>	—	not supported and don't care	—
FREQUENCY_CONFIG<2:0>	FS<2:0>	000: 275 kHz 001: 325 kHz 010: 425 kHz ⁽¹⁾ 011: 525 kHz 100: 625 kHz 101: 750 kHz 110: 850 kHz 111: 1 MHz	Yes

(1) TI default.

7.6.12 VOUT_ADJUSTMENT (MFR_SPECIFIC_04) [D4h] (R/W Byte)

Custom register 4 provides output voltage adjustment (VOA) in $\pm 0.75\%$ steps, with a total range of $\pm 9\%$. When fine adjustment is used together with the margin setting, the change in the output voltage is determined by the multiplication of the two settings.

Table 12. VOUT_ADJUSTMENT (MFR_SPECIFIC_04) Settings

COMMAND	DEFINITION	DESCRIPTION	NVM
VOUT_ADJUSTMENT<7>	—	not supported and don't care	—
VOUT_ADJUSTMENT<6>	—	not supported and don't care	—
VOUT_ADJUSTMENT<5>	—	not supported and don't care	—
VOUT_ADJUSTMENT<4:0>	VOA<4:0>	111xx: +9.00% 11011: +8.25% 11010: +7.50% 11001: +6.75% 11000: +6.00% 10111: +5.25% 10110: +4.50% 10101: +3.75% 10100: +3.00% 10011: +2.25% 10010: +1.50% 10001: +0.75% 10000: +0% ⁽¹⁾ 01111: -0% 01110: -0.75% 01101: -1.50% 01100: -2.25% 01011: -3.00% 01010: -3.75% 01001: -4.50% 01000: -5.25% 00111: -6.00% 00110: -6.75% 00101: -7.50% 00100: -8.25% 000xx: -9.00%	Yes

(1) TI default.

7.6.13 Output Voltage Fine Adjustment Soft Slew Rate

To prevent sudden buildup of voltage across inductor, output voltage fine adjustment setting cannot change output voltage instantaneously. The internal reference voltage must slew slowly to its final target, and SST<1:0> is used to provide further programmability. The details of output voltage fine adjustment slew rate are shown in [Table 13](#).

Table 13. Output Voltage Fine Adjustment Soft Slew Rate Settings

COMMAND	DEFINITION	DESCRIPTION	NVM
MODE_SOFT_START_CONFIG<3:2>	SST<1:0>	00: 1 step per 4 μs ⁽¹⁾ 01: 1 step per 8 μs 10: 1 step per 16 μs 11: 1 step per 32 μs	Yes

(1) TI default.

7.6.14 VOUT_MARGIN (MFR_SPECIFIC_05) [D5h] (R/W Byte)

Custom register 5 provides output voltage margin high (VOMH) and output voltage margin low (VOML) settings. This register works in conjunction with PMBus OPERATION command to raise or lower the output voltage by a specified amount. This register settings described in [Table 14](#) are also used together with the fine adjustment setting described in [Table 12](#). For example, setting fine adjustment to +9% and margin to +12% changes the output by +22.08%, whereas setting fine adjustment to –9% and margin to –9% change the output by –17.19%

Table 14. VOUT_MARGIN (MFR_SPECIFIC_05) Settings

COMMAND	DEFINITION	DESCRIPTION	NVM
VOUT_MARGIN<7:4>	VOMH<3:0>	11xx: +12.0% 1011: +10.9% 1010: +9.9% 1001: +8.8% 1000: +7.7% 0111: +6.7% 0110: +5.7% 0101: +4.7% ⁽¹⁾ 0100: +3.7% 0011: +2.8% 0010: +1.8% 0001: +0.9% 0000: +0%	Yes
VOUT_MARGIN<3:0>	VOML<3:0>	0000: –0% 0001: –1.1% 0010: –2.1% 0011: –3.2% 0100: –4.2% 0101: –5.2% ⁽¹⁾ 0110: –6.2% 0111: –7.1% 1000: –8.1% 1001: –9.0% 1010: –9.9% 1011: –10.7% 11xx: –11.6%	Yes

(1) TI default.

7.6.15 Output Voltage Margin Adjustment Soft-Slew Rate

Similar to the output voltage fine adjustment, margin adjustment also cannot change output voltage instantaneously. The soft-slew rate of margin adjustment is also programmed by SST<1:0>. The details are listed in Table 15.

Table 15. Output Voltage Margin Adjustment Soft-Slew Rate Settings

COMMAND	DEFINITION	DESCRIPTION	NVM
MODE_SOFT_START_CONFIG<3:2>	SST<1:0>	00: 1 step per 4 μ s ⁽¹⁾ 01: 1 step per 8 μ s 10: 1 step per 16 μ s 11: 1 step per 32 μ s	Yes

(1) TI default.

Figure 35 shows the timing diagram of the output voltage adjustment via PMBus. After receiving the write command of VOUT_ADJUSTMENT (MFR_SPECIFIC_04), the output voltage starts to be adjusted after t_p delay time (about 50 μ s). The time duration t_{DAC} for each DAC step change can be controlled by SST bits (MODE_SOFT_START_CONFIG<3:2> from 4 μ s to 32 μ s).

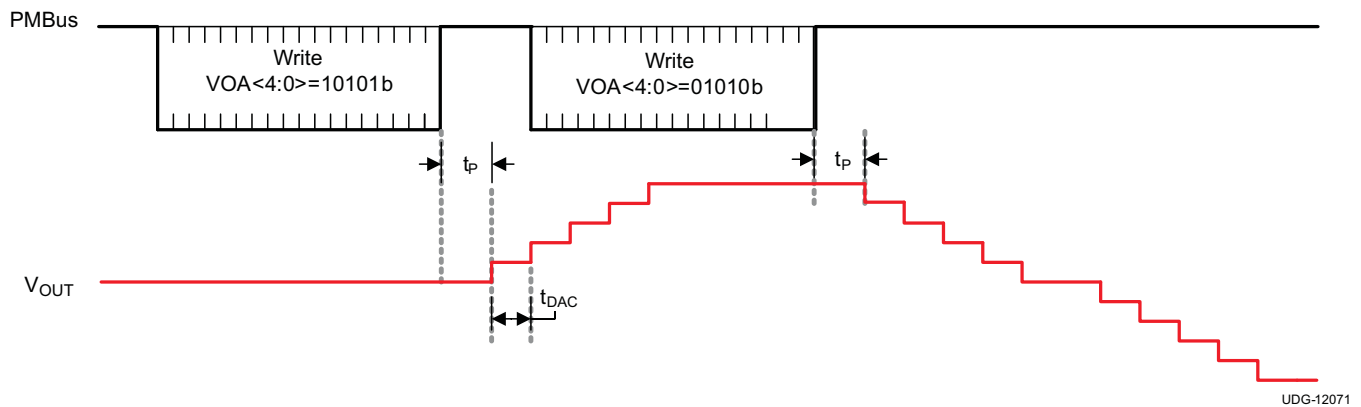

Figure 35. Output Voltage Adjustment via PMBus

The margining function is enabled by setting the OPERATION command, and the margining level is determined by the VOUT_MARGIN (MFR_SPECIFIC_05) command. Figure 36 and Figure 37 illustrate the timing diagrams of the output voltage margining via PMBus. Figure 36 shows setting the margining level first, and then enabling margining by writing OPERATION command. After the OPERATION margin high command enables the margin high setting (VOMH<3:0>), the output voltage starts to be adjusted after t_p delay time (about 50 μ s). The time duration t_{DAC} for each DAC step change can be controlled by SST bits (MODE_SOFT_START_CONFIG<3:2>) from 4 μ s to 32 μ s.

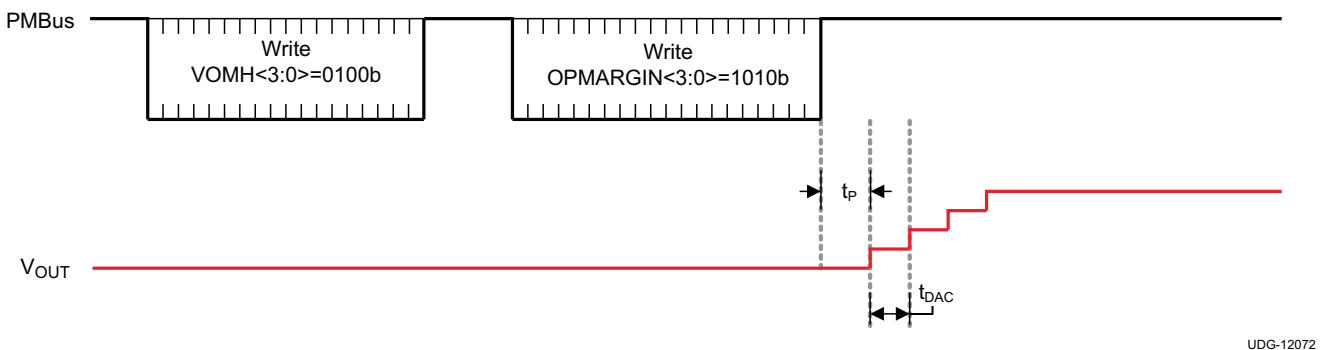
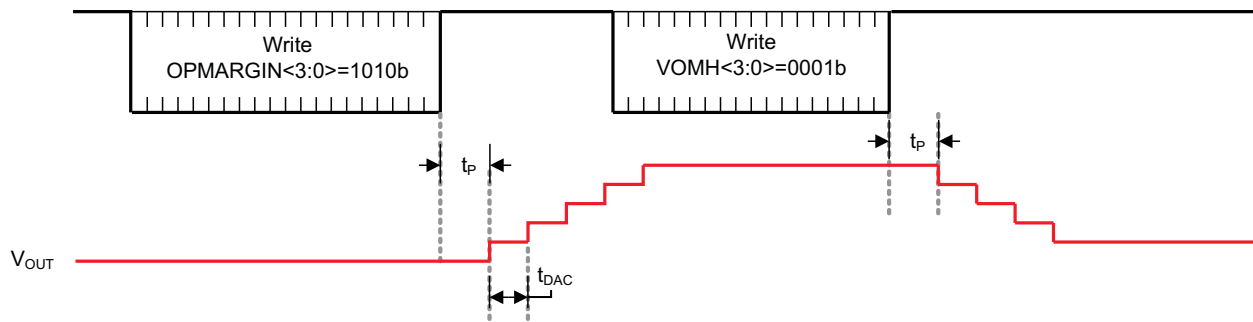

Figure 36. Setting the Margining Level First



UDG-12073

Figure 37. Enabling Margining First

As shown in Figure 37, the margining function is enabled first by a write command of OPERATION. The output voltage starts to be adjusted toward the default margin high level after t_P delay. Since the margining function has been enabled, the output voltage can be adjusted again by sending a different margin high level with a write command of VOUT_MARGIN. The time duration t_{DAC} for each DAC step change can be also controlled by SST bits (MODE_SOFT_START_CONFIG<3:2>) from 4 μ s to 32 μ s.

7.6.16 UVLO_THRESHOLD (MFR_SPECIFIC_06) [D6h]

Custom register 6 provides some limited programmability of input supply UVLO threshold, as described in Table 16. The default turn-on UVLO threshold is 4.25 V.

Table 16. UVLO_THRESHOLD (MFR_SPECIFIC_06) Settings

COMMAND	DEFINITION	DESCRIPTION	NVM
UVLO_THRESHOLD<7>	—	not supported and don't care	—
UVLO_THRESHOLD<6>	—	not supported and don't care	—
UVLO_THRESHOLD<5>	—	not supported and don't care	—
UVLO_THRESHOLD<4>	—	not supported and don't care	—
UVLO_THRESHOLD<3>	—	not supported and don't care	—
UVLO_THRESHOLD<2:0>	VDDINUVLO<2:0>	0xx: 10.2 V 100: not supported and should not be used 101: 4.25 V ⁽¹⁾ 110: 6.0 V 111: 8.1 V	Yes

(1) TI default.

8 Application and Implementation

NOTE

Information in the following applications sections is not part of the TI component specification, and TI does not warrant its accuracy or completeness. TI's customers are responsible for determining suitability of components for their purposes. Customers should validate and test their design implementation to confirm system functionality.

8.1 Application Information

The TPS53819A device is a small-sized, single buck controller with adaptive on-time D-CAP2 mode control and PMBus.

8.2 Typical Application

The following application shows a TPS53819A 12-V to 1.2-V point-of-load synchronous buck regulator.

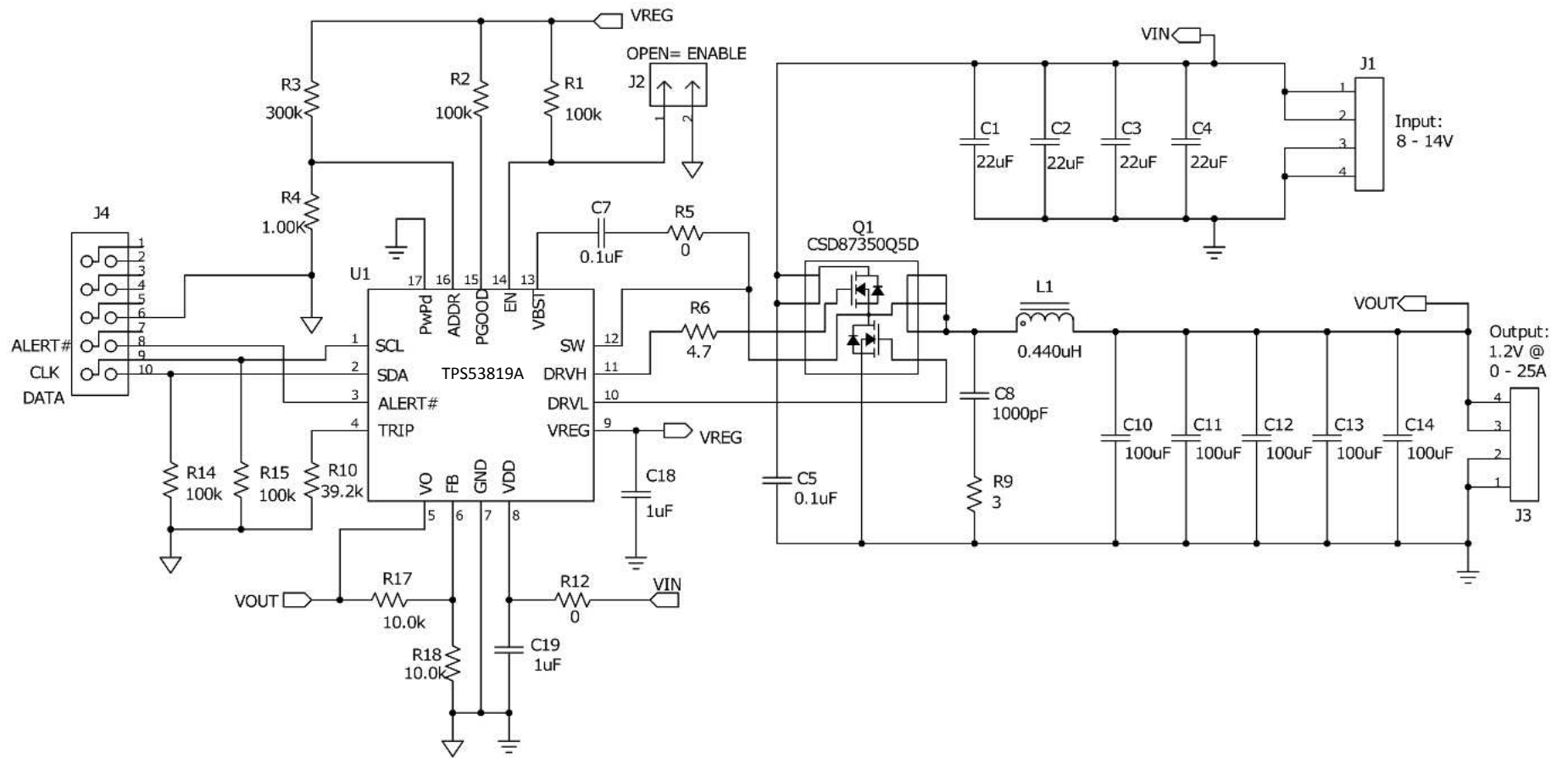

Figure 38. Typical Application Schematic, TPS53819A

8.2.1 Design Requirements

Table 17. Design Example Specifications

PARAMETER		MIN	TYP	MAX	UNIT
V _{VIN}	Input voltage range	8	12	14	V
V _{VIN(ripple)}	Input voltage ripple			240	mV _{PP}
V _{OUT}	Output voltage		1.2		V
V _{RIPPLE}	Output voltage ripple			12	mV _{PP}
I _{OUT}	Output load current	0		20	A
I _{OCL}	Output overcurrent		25		A
f _{SW}	Switching frequency		425		kHz

8.2.2 Detailed Design Procedure

Selecting external components is a simple process using D-CAP2™ Mode

8.2.2.1 Custom Design With WEBENCH® Tools

[Click here](#) to create a custom design using the TPS53819A device with the WEBENCH® Power Designer.

1. Start by entering the input voltage (V_{VIN}), output voltage (V_{OUT}), and output current (I_{OUT}) requirements.
2. Optimize the design for key parameters such as efficiency, footprint, and cost using the optimizer dial.
3. Compare the generated design with other possible solutions from Texas Instruments.

The WEBENCH Power Designer provides a customized schematic along with a list of materials with real-time pricing and component availability.

In most cases, these actions are available:

- Run electrical simulations to see important waveforms and circuit performance
- Run thermal simulations to understand board thermal performance
- Export customized schematic and layout into popular CAD formats
- Print PDF reports for the design, and share the design with colleagues

Get more information about WEBENCH tools at www.ti.com/WEBENCH.

8.2.2.2 Switching Frequency

The switching frequency must first be decided on and is set using the PMBus. When deciding on a frequency a tradeoff between component size and efficiency must be made. A lower frequency reduces the switching losses in the MOSFETs improving efficiency but a larger inductance and/or output capacitance is required for low output voltage ripple. This example uses the TI default PMBus setting, 425 kHz.

8.2.2.3 Inductor (L1)

Determined the inductance to yield a ripple current (I_{IND(ripple)}) of approximately ¼ to ½ of maximum output current. Larger ripple current increases output ripple voltage, improves the signal-to-noise ratio and helps stable operation. Maximum current ripple occurs with the maximum input voltage. [Equation 9](#) calculates the recommended inductance. After choosing the inductance, use [Equation 10](#) to calculate the ripple.

$$L = \frac{1}{I_{IND(ripple)} \times f_{SW}} \times \frac{(V_{IN(max)} - V_{OUT}) \times V_{OUT}}{V_{IN(max)}} = \frac{3}{I_{OUT(max)} \times f_{SW}} \times \frac{(V_{IN(max)} - V_{OUT}) \times V_{OUT}}{V_{IN(max)}} \quad (9)$$

$$I_{IND(ripple)} = \frac{1}{L \times f_{SW}} \times \frac{(V_{IN(max)} - V_{OUT}) \times V_{OUT}}{V_{IN(max)}} \quad (10)$$

The inductor requires a low DCR to achieve good efficiency. The inductor also requires enough margin above the peak inductor current before saturation. The peak inductor current can be estimated in [Equation 11](#).

$$I_{IND(peak)} = I_{OCL} + I_{IND(ripple)} \quad (11)$$

Using Equation 9 the recommended inductance for the example is 0.329 μH . An inductor supplied by Pulse Electronics (PA0513.441NLT) is selected with an inductance of 0.440 μH at 0 A and 0.363 μH at its 30 A rated current. The saturation current is 35 A and the DCR is 0.32 m Ω . Using Equation 10 with the selected inductance and maximum input voltage, the current ripple is estimated to be 6.23 A. Equation 11 calculates the peak current to be 31.3 A, well below the saturation current of the inductor. The output current threshold when the supply operates in DCM or CCM can also be estimated as half the estimated current ripple. With the maximum 14 V input in this design the output current threshold is 3.12 A. With lower input voltages, ripple decreases and so does the threshold.

8.2.2.4 Output Capacitors (C10, C11, C12, C13, C14)

Determine the output capacitance to meet the load transient, ripple requirements, and to meet small-signal stability as shown in Equation 12.

$$5 \times f_{C2} \leq \frac{R_{C1} \times C_{C1} \times 0.6 \times (0.67 + D)}{2\pi \times G \times L \times C_{OUT} \times V_{OUT}} \leq \frac{f_{SW}}{3}$$

where

- $G = 0.25$
 - $R_{C1} \times C_{C1}$ time constant can be referred to Table 1
 - D is the duty cycle
- (12)

Based on Equation 12, the value of C_{OUT} to ensure small signal stability can be calculated using Equation 13 and Equation 14. These equations assume MLCC are used and the ESR effects are negligible. If a high ESR output capacitor is used, the effects may reduce the minimum and maximum capacitance. In the design example using Table 1 for 425-kHz switching frequency, the time constant is 62 μs . The recommended minimum capacitance for a design with an 8-V minimum input voltage is 260 μF . The recommended maximum capacitance for design with a 14-V maximum input voltage is 4842 μF .

$$C_{OUT} \leq \frac{R_{C1} \times C_{C1} \times 0.6 \times \left(0.67 + \frac{V_{OUT}}{V_{IN(max)}}\right)}{2\pi \times G \times L \times 5 \times f_{C2} \times V_{OUT}} \tag{13}$$

$$C_{OUT} \geq \frac{R_{C1} \times C_{C1} \times 0.6 \times \left(0.67 + \frac{V_{OUT}}{V_{IN(min)}}\right)}{2\pi \times G \times L \times \frac{f_{SW}}{3} \times V_{OUT}} \tag{14}$$

Select a larger output capacitance to decrease the output voltage change that occurs during a load transient and the output voltage ripple.

The minimum output capacitance to meet an output voltage ripple requirement can be calculated with Equation 15. In the example the minimum output capacitance for 12 mV_{PP} ripple is 162 μF . If non ceramic capacitors are used Equation 16 calculates the maximum equivalent series resistance (ESR) of the output capacitor to meet the ripple requirement. Equation 17 calculates the required RMS current rating for the output capacitor. In this example with 12-V nominal input voltage it is 1.77 A. Finally the output capacitor must be rated for the output voltage.

$$C_{OUT} \geq \frac{I_{IND(ripple)}}{8 \times V_{RIPPLE} \times f_{SW}} \tag{15}$$

$$ESR \leq \frac{V_{RIPPLE} - \left(\frac{I_{IND(ripple)}}{8 \times C_{OUT} \times f_{SW}}\right)}{I_{IND(ripple)}} \tag{16}$$

$$I_{COUT(RMS)} = \frac{I_{IND(ripple)}}{\sqrt{12}} \tag{17}$$

This example uses five 1210, 100- μ F, 6.3-V, X5R ceramic capacitors with 2 m Ω of ESR. From the data sheet the estimated DC derating of 95% and AC derating of 70% for a total of 66.5% at room temperature. The total output capacitance is approximately 332.5 μ F.

8.2.2.5 Input Capacitors (C1, C2, C3, C4, C5)

Choose an input capacitance that reduces the input voltage ripple. Equation 18 calculates the minimum input capacitance. In the example design to limit the input ripple to 240 mV, assuming all ceramic and ignoring ESR ripple, the minimum input capacitance is 27.8 μ F. The input capacitor must also be rated for the input RMS current calculated in Equation 19. For this design example this current is 8.95 A with the minimum 8-V input voltage. Also, the input capacitors must be rated for the maximum input voltage.

$$C_{IN} \geq \frac{\Delta L}{8 \times V_{INRIPPLE} \times f_{SW}} \quad (18)$$

$$I_{CIN(RMS)} = I_{OUT} \times \sqrt{\frac{V_{OUT}}{V_{IN(min)}} \times \frac{(V_{IN(min)} - V_{OUT})}{V_{IN(min)}}} \quad (19)$$

This example uses four 1206, 22 μ F, 16 V, X5R ceramic capacitors with 3 m Ω of ESR. An additional 0.1- μ F capacitor is placed close to the drain of the high-side MOSFET and the source of the low-side MOSFET.

8.2.2.6 MOSFET (Q1, Q2)

The TPS53819A uses two external N-channel MOSFETs. The V_{DS} rating should be greater than the maximum input voltage and include some tolerance for ringing on the switching node. It must also be rated for the DC current. The high-side MOSFET conducts the input current and the low-side MOSFET conducts the output current. The gate drive voltage is set by the VREG voltage of 5 V typical. The gate capacitance should be reduced to minimize the current required to turn on the MOSFETs and switching losses. However it is recommended the low-side MOSFET have a higher gate capacitance to avoid unintentional shoot-through caused by the high dv/dt on the switching node during the high-side turn-on. A reduction in current also reduces power dissipation in TPS53819A. Choose a low $R_{DS(on)}$ to reduce conduction losses especially for the low-side MOSFET because it conducts the output current.

This design uses the CSD87350Q5D, 30-V, 40-A, NexFET power block with integrated low-side and high-side MOSFETs. This is optimized for applications with a 5 V gate drive. The typical gate to source capacitance of the high-side and low-side MOSFETs is 1341 pF and 2900 pF respectively. Using Equation 1 and Equation 2 the average drive currents are 2.7 mA and 5.9 mA. With Equation 3 the power dissipated in the driver is estimated to 42.4 mW. The $R_{DS(on)}$ of the high-side and low-side MOSFETs with a 5 V gate drive voltage is 5 m Ω and 2.2 m Ω respectively.

A small, 4.7- Ω resistance from R6, is added in series between DRVH and the gate of the high-side MOSFET. This slows down the turn-on time of the high-side MOSFET dv/dt and reduces rising edge ringing on the switching node to help prevent shoot-through. This value should be kept small and if it is too large it may lead to too large of a delay time in the turn-on time of the high-side switch.

8.2.2.7 VREG Bypass Capacitor (C18)

A ceramic capacitor with a recommended value between 0.47- μ F and 2.2- μ F is required on the VREG pin for proper operation. The example uses a 1- μ F capacitor. Choose one rated for the VREG 5.5-V maximum voltage in order to supply the instantaneous drive current of the low-side MOSFET.

8.2.2.8 VDD Bypass Capacitor (C19)

A 1- μ F capacitor should be placed at the VDD pin rated for the maximum input voltage. If power stage switching noise is causing faults, a small resistor (R12) can be added between VDD and all the input capacitors (C1-C5). This creates an R-C filter and reduces any switching noise in the device input.

8.2.2.9 VBST Capacitor (C7)

The bootstrap capacitor is required to generate the high-side gate drive bias voltage and provide the instantaneous drive current for DRVH. A 0.1-μF ceramic capacitor is recommended to limit the ripple voltage.

R5 (0-Ω) resistance, is added in series with the bootstrap capacitor. This resistor can be used to slow down the turn-on time of the high-side MOSFET dv/dt and reduces rising edge ringing on the SW node to help prevent shoot-through. Keep the value small because a higher value may increase the the turn-on delay time of the high-side switch.

8.2.2.10 Snubber (C8 and R9)

Fast-switching edges and parasitic inductance and capacitance cause voltage ringing on the SW node . If the ringing results in excessive voltage on the SW node or erratic operation an R-C snubber can be used to reduce ringing on the SW node and ensure proper operation in all operating conditions.

8.2.2.11 Feedback Resistance, R_{FBH} and R_{FBL} (R17 and R18)

The values of the voltage-divider resistors, R_{FBH} and R_{FBL} determine the output voltage as shown in [Figure 38](#). R_{FBH} is connected between the FB pin and the output, and R_{FBL} is connected between the FB pin and GND. The recommended R_{FBH} value is between 10 kΩ and 20 kΩ. Determine R_{FBL} using [Equation 20](#).

$$R_{FBL} = \frac{R_{FBH}}{\left[\frac{V_{OUT} - \frac{1}{2} \times \left(I_{IND(ripple)} \times \left(ESR + \frac{1}{8 \times C_{OUT} \times f_{SW}} \right) \right)}{0.6 - \left(\frac{1}{2} \times \left(I_{IND(ripple)} \times \frac{L}{4 \times R_{C1} \times C_{C1}} \right) - V_{OFS} \right)} \right] - 1}$$

where

- V_{OFS} is the internal offset voltage (4 mV)
- ESR is the from the output capacitors

In this example R17 has a value of 10-kΩ. R18 is calculated to be 9.91 kΩ. The nearest standard value of 10 kΩ is used for R18.

8.2.2.12 Overcurrent Limit (OCL) Setting Resistance (R10)

Combining [Equation 7](#) and [Equation 8](#), [Equation 21](#) calculates R_{TRIP}.

$$R_{TRIP} = \frac{8 \times \left(I_{OCL} - \left(\frac{(V_{IN} - V_{OUT})}{(2 \times L_X)} \right) \times \frac{V_{OUT}}{(f_{SW} \times V_{IN})} \right) \times R_{DS(on)}}{I_{TRIP}}$$

In this example for a 25-A current limit, R_{TRIP} is calculated as 38.5 kΩ and is rounded up to the nearest standard value of 39.2 kΩ.

8.2.2.13 PMBus Device Address (R3 and R4)

The PMBus address is selected using a resistive divider as shown in [Table 2](#). In this example the address is set to 0010000 with a 300-kΩ resistor (R3) and a 1.00-kΩ (R4).

8.2.2.14 PGOOD Pullup Resistor (R2)

A pullup resistor is required because the PGOOD pin is an open-drain output. Use a value between 10 kΩ to 100 kΩ. The recommended max 100 kΩ resistor is used.

8.2.2.15 SCL and SDA Pulldown Resistors (R14 and R15)

If there is no PMBus (I²C) needed in the system, pull these two pins down to ground. If a PMBus interface is always present, then these resistors are not needed. This example design uses 100-kΩ of resistance to pull these pins down to ground, allowing it to operate with or without a PMBus interface.

8.2.2.16 PMBus Pullup Resistors

Due to the limited drive strength of pulldown MOSFETs on SDA and $\overline{\text{ALERT}}$ pins, the external PMBus pullup resistors must be kept within certain ranges. For example, if the external PMBus supply is 3.3 V, then use a pullup resistance of 1-kΩ. If the external PMBus supply is 5 V, then use a pullup resistance of 1.5 kΩ.

8.2.3 Application Curves

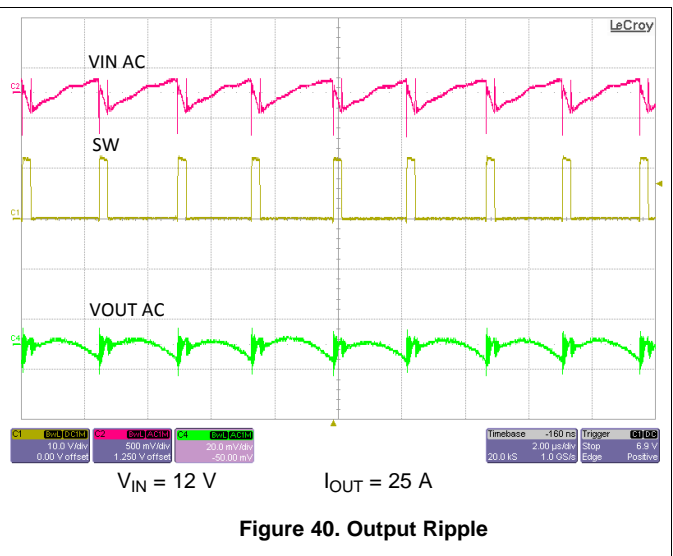
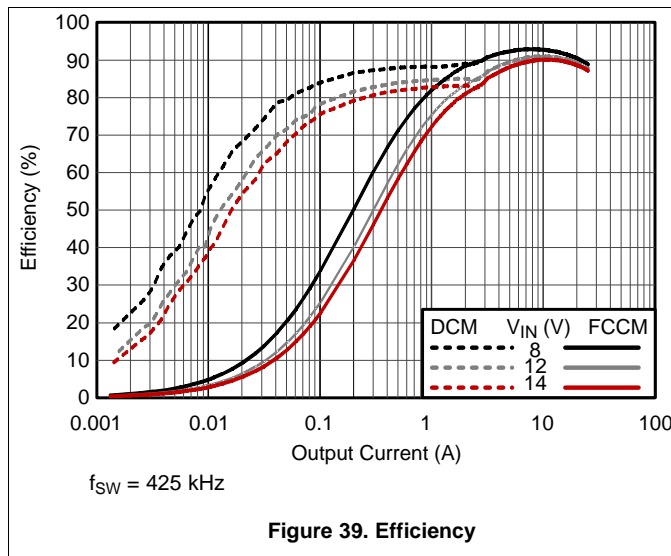

9 Power Supply Recommendations

The TPS53819A device operates using an input voltage supply range between 3 V and 28 V (4.5-V to 28-V biased). This input supply must be well regulated. Proper bypassing of input supplies and internal regulators is also critical for noise performance, as is PCB layout and grounding scheme.

10 Layout

10.1 Layout Guidelines

Note these design considerations before starting a layout work using TPS53819A

- Inductor, V_{IN} capacitors, V_{OUT} capacitors and MOSFETs are the power components and should be placed on one side of the PCB (solder side). Other small signal components can be placed on another side (component side). At least one inner plane should be inserted, connected to ground, in order to shield and isolate the small signal traces from noisy power lines.
- Place all sensitive analog traces and components such as FB, VO, TRIP, PGOOD, and EN away from high-voltage switching nodes such as SW, DRVH, DRVL or VBST to avoid coupling. Use internal layers as ground planes and shield feedback trace from power traces and components.
- Keep PMBus interfacing signals away from the sensitive analog traces.
- The DC/DC converter has several high-current loops. Minimize the area of these loops in order to suppress switching noise.
 - The path from the V_{IN} capacitors through the high and low-side MOSFETs and back to the capacitors through ground, is the most important loop area to minimize. Connect the negative node of the V_{IN} capacitors and the source of the low-side MOSFET at ground as close as possible.
 - The second important loop is the path from the low-side MOSFET through inductor and V_{OUT} capacitors, and back to source of the low-side MOSFET through ground. Connect source of the low-side MOSFET and negative node of V_{OUT} capacitors at ground as close as possible.
 - The third important loop is that of the gate driving system for the low-side MOSFET. To turn on the low-side MOSFET, high current flows from the VDRV capacitor through the gate driver and the low-side MOSFET, and back to negative node of the capacitor through ground. To turn off the low-side MOSFET, high current flows from gate of the low-side MOSFET through the gate driver and PGND of the device, and back to source of the low-side MOSFET through ground. Connect the negative node of the VREG capacitor, source of the low-side MOSFET and PGND of the device at ground as close as possible.
- A separate AGND from the high-current loop PGND should be used for the return of the sensitive analog circuitry. The two grounds should connect at a single point as close to the GND pin as possible.
- Minimize the current loop from the VDD and VREG pins through their respective capacitors to the GND pin.
- Because the TPS53819A controls the output voltage referring to voltage across V_{OUT} capacitor, the top-side resistor of the voltage divider should be connected to the positive node of the V_{OUT} capacitor. In a same manner both bottom side resistor and GND of the device should be connected to the negative node of V_{OUT} capacitor. The trace from these resistors to the VFB pin should be short and thin. Place on the component side and avoid vias between these resistors and the device.
- Connect the overcurrent setting resistor from the TRIP pin to ground and make the connections as close as possible to the device. Avoid coupling a high-voltage switching node to the trace from the TRIP pin to R_{TRIP} and from R_{TRIP} to ground .
- Connections from gate drivers to the respective gate of the high-side or the low-side MOSFET should be as short as possible to reduce stray inductance. Use 0.65 mm (25 mils) or wider trace and vias of at least 0.5 mm (20 mils) diameter along this trace.
- The PCB trace defined as switch node, which connects to source of high-side MOSFET, drain of low-side MOSFET and high-voltage side of the inductor, should be as short and wide as possible.
- Follow any layout considerations for the MOSFET provided by the MOSFET manufacturer.

10.2 Layout Example

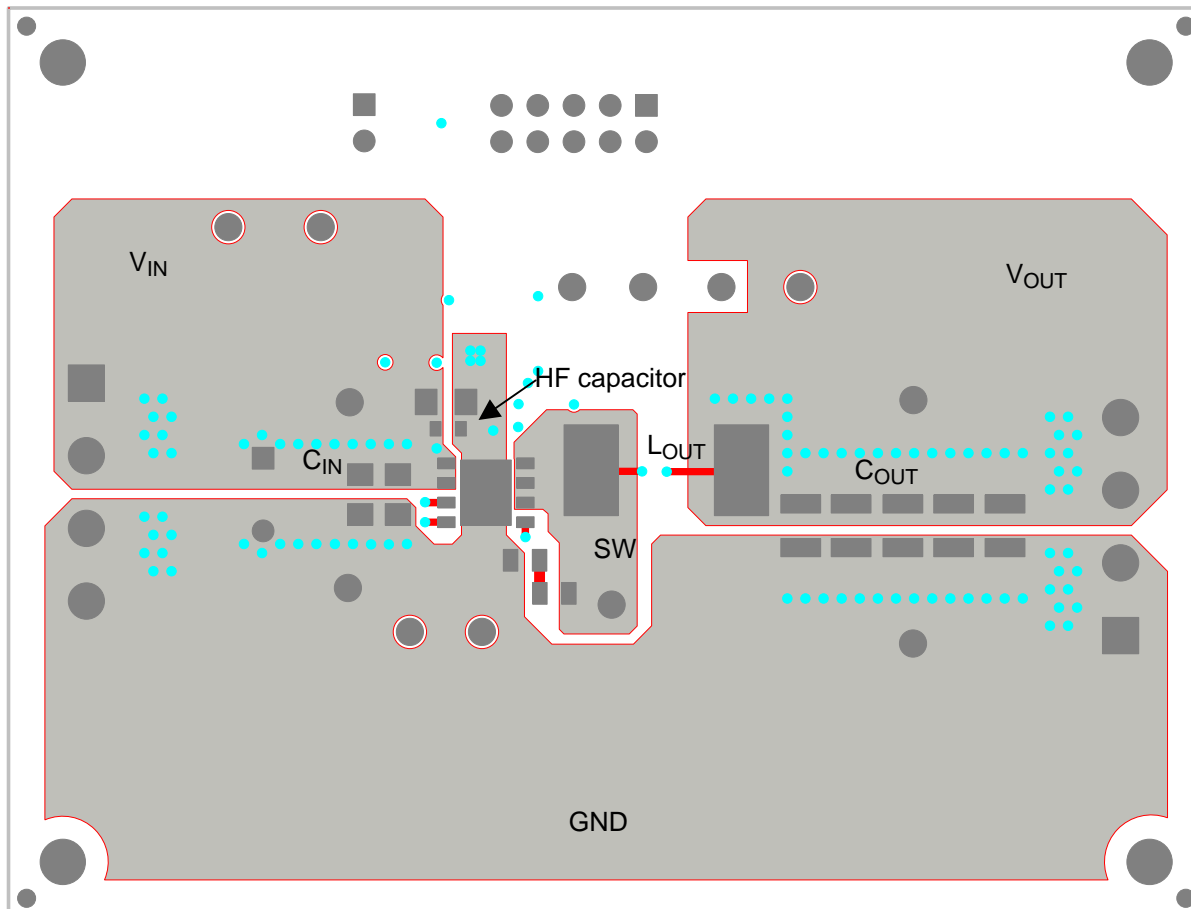

Figure 41. Top Layer

Layout Example (continued)

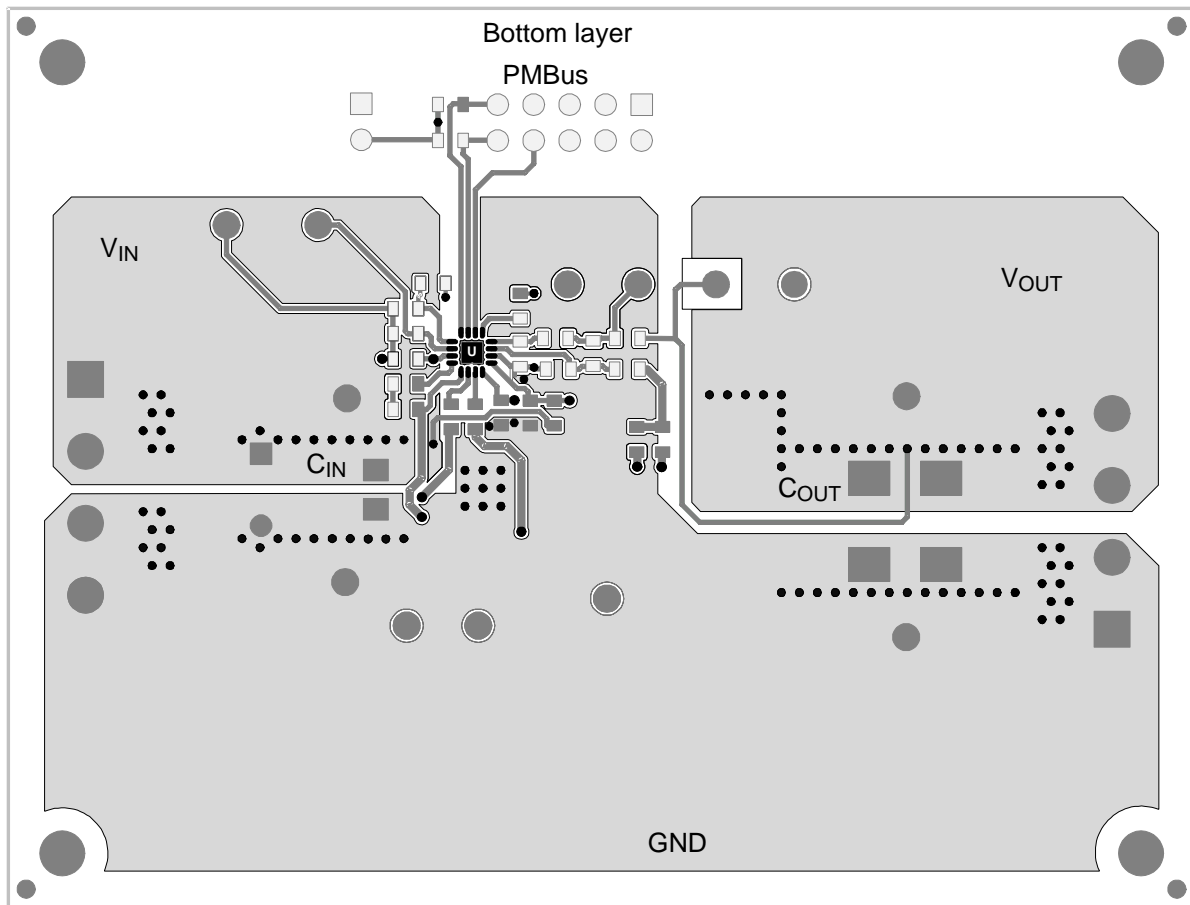

Figure 42. Bottom Layer

11 器件和文档支持

11.1 器件支持

11.1.1 开发支持

11.1.1.1 使用 WEBENCH® 工具创建定制设计

单击[此处](#)使用 TPS53819A 器件并借助 WEBENCH® 电源设计器创建定制设计。

1. 首先输入输入电压 (V_{IN})、输出电压 (V_{OUT}) 和输出电流 (I_{OUT}) 要求。
2. 使用优化器拨盘优化该设计的关键参数，如效率、尺寸和成本。
3. 将生成的设计与德州仪器 (TI) 的其他可行的解决方案进行比较。

WEBENCH 电源设计器可提供定制原理图以及罗列实时价格和组件供货情况的物料清单。

在多数情况下，可执行以下操作：

- 运行电气仿真，观察重要波形以及电路性能
- 运行热性能仿真，了解电路板热性能
- 将定制原理图和布局方案以常用 CAD 格式导出
- 打印设计方案的 PDF 报告并与同事共享

有关 WEBENCH 工具的详细信息，请访问 www.ti.com.cn/WEBENCH。

11.2 接收文档更新通知

要接收文档更新通知，请导航至 TI.com.cn 上的器件产品文件夹。单击右上角的[通知我](#)进行注册，即可每周接收产品信息更改摘要。有关更改的详细信息，请查看任何已修订文档中包含的修订历史记录。

11.3 社区资源

下列[链接](#)提供到 TI 社区资源的连接。链接的内容由各个分销商“按照原样”提供。这些内容并不构成 TI 技术规范，并且不一定反映 TI 的观点；请参阅 TI 的《[使用条款](#)》。

TI E2E™ Online Community *TI's Engineer-to-Engineer (E2E) Community*. Created to foster collaboration among engineers. At e2e.ti.com, you can ask questions, share knowledge, explore ideas and help solve problems with fellow engineers.

Design Support *TI's Design Support* Quickly find helpful E2E forums along with design support tools and contact information for technical support.

11.4 商标

D-CAP2, Eco-mode, E2E are trademarks of Texas Instruments.
 WEBENCH is a registered trademark of Texas Instruments.
 PMBus is a trademark of SMIF, Inc.
 All other trademarks are the property of their respective owners.

11.5 静电放电警告



这些装置包含有限的内置 ESD 保护。存储或装卸时，应将导线一起截短或将装置放置于导电泡棉中，以防止 MOS 门极遭受静电损伤。

11.6 术语表

SLYZ022 — TI 术语表。

这份术语表列出并解释术语、缩写和定义。

12 机械、封装和可订购信息

以下页面包含机械、封装和可订购信息。这些信息是指定器件的最新可用数据。数据如有变更，恕不另行通知，且不会对此文档进行修订。如需获取此数据表的浏览器版本，请查阅左侧的导航栏。

PACKAGING INFORMATION

Orderable Device	Status (1)	Package Type	Package Drawing	Pins	Package Qty	Eco Plan (2)	Lead finish/ Ball material (6)	MSL Peak Temp (3)	Op Temp (°C)	Device Marking (4/5)	Samples
TPS53819ARGTR	ACTIVE	VQFN	RGT	16	3000	RoHS & Green	NIPDAU	Level-2-260C-1 YEAR	-40 to 85	3819A	Samples
TPS53819ARGTT	ACTIVE	VQFN	RGT	16	250	RoHS & Green	NIPDAU	Level-2-260C-1 YEAR	-40 to 85	3819A	Samples

(1) The marketing status values are defined as follows:

ACTIVE: Product device recommended for new designs.

LIFEBUY: TI has announced that the device will be discontinued, and a lifetime-buy period is in effect.

NRND: Not recommended for new designs. Device is in production to support existing customers, but TI does not recommend using this part in a new design.

PREVIEW: Device has been announced but is not in production. Samples may or may not be available.

OBSOLETE: TI has discontinued the production of the device.

(2) **RoHS:** TI defines "RoHS" to mean semiconductor products that are compliant with the current EU RoHS requirements for all 10 RoHS substances, including the requirement that RoHS substance do not exceed 0.1% by weight in homogeneous materials. Where designed to be soldered at high temperatures, "RoHS" products are suitable for use in specified lead-free processes. TI may reference these types of products as "Pb-Free".

RoHS Exempt: TI defines "RoHS Exempt" to mean products that contain lead but are compliant with EU RoHS pursuant to a specific EU RoHS exemption.

Green: TI defines "Green" to mean the content of Chlorine (Cl) and Bromine (Br) based flame retardants meet JS709B low halogen requirements of <=1000ppm threshold. Antimony trioxide based flame retardants must also meet the <=1000ppm threshold requirement.

(3) MSL, Peak Temp. - The Moisture Sensitivity Level rating according to the JEDEC industry standard classifications, and peak solder temperature.

(4) There may be additional marking, which relates to the logo, the lot trace code information, or the environmental category on the device.

(5) Multiple Device Markings will be inside parentheses. Only one Device Marking contained in parentheses and separated by a "~" will appear on a device. If a line is indented then it is a continuation of the previous line and the two combined represent the entire Device Marking for that device.

(6) Lead finish/Ball material - Orderable Devices may have multiple material finish options. Finish options are separated by a vertical ruled line. Lead finish/Ball material values may wrap to two lines if the finish value exceeds the maximum column width.

Important Information and Disclaimer:The information provided on this page represents TI's knowledge and belief as of the date that it is provided. TI bases its knowledge and belief on information provided by third parties, and makes no representation or warranty as to the accuracy of such information. Efforts are underway to better integrate information from third parties. TI has taken and continues to take reasonable steps to provide representative and accurate information but may not have conducted destructive testing or chemical analysis on incoming materials and chemicals. TI and TI suppliers consider certain information to be proprietary, and thus CAS numbers and other limited information may not be available for release.

In no event shall TI's liability arising out of such information exceed the total purchase price of the TI part(s) at issue in this document sold by TI to Customer on an annual basis.

TAPE AND REEL INFORMATION

QUADRANT ASSIGNMENTS FOR PIN 1 ORIENTATION IN TAPE

*All dimensions are nominal

Device	Package Type	Package Drawing	Pins	SPQ	Reel Diameter (mm)	Reel Width W1 (mm)	A0 (mm)	B0 (mm)	K0 (mm)	P1 (mm)	W (mm)	Pin1 Quadrant
TPS53819ARGTR	VQFN	RGT	16	3000	330.0	12.4	3.3	3.3	1.1	8.0	12.0	Q2
TPS53819ARGTT	VQFN	RGT	16	250	180.0	12.4	3.3	3.3	1.1	8.0	12.0	Q2

TAPE AND REEL BOX DIMENSIONS

*All dimensions are nominal

Device	Package Type	Package Drawing	Pins	SPQ	Length (mm)	Width (mm)	Height (mm)
TPS53819ARGTR	VQFN	RGT	16	3000	346.0	346.0	33.0
TPS53819ARGTT	VQFN	RGT	16	250	210.0	185.0	35.0

RGT 16

GENERIC PACKAGE VIEW

VQFN - 1 mm max height

PLASTIC QUAD FLATPACK - NO LEAD



Images above are just a representation of the package family, actual package may vary.
Refer to the product data sheet for package details.

4203495/1



SIDE WALL METAL THICKNESS DIM A	
OPTION 1	OPTION 2
0.1	0.2



4222419/D 04/2022

NOTES:

1. All linear dimensions are in millimeters. Any dimensions in parenthesis are for reference only. Dimensioning and tolerancing per ASME Y14.5M.
2. This drawing is subject to change without notice.
3. The package thermal pad must be soldered to the printed circuit board for thermal and mechanical performance.

EXAMPLE BOARD LAYOUT

RGT0016C

VQFN - 1 mm max height

PLASTIC QUAD FLATPACK - NO LEAD

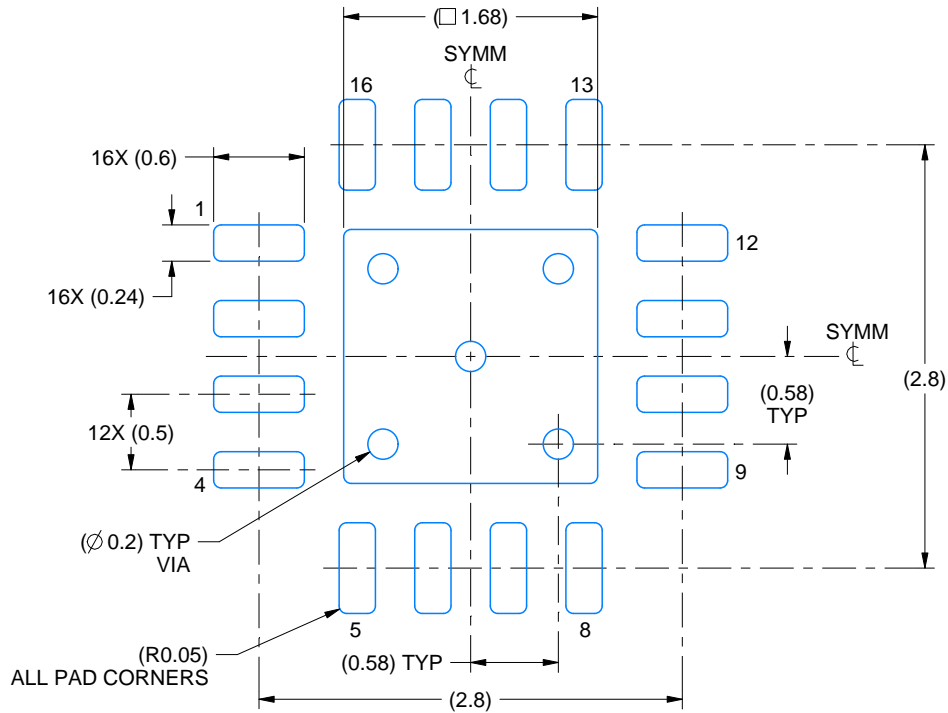

LAND PATTERN EXAMPLE
 EXPOSED METAL SHOWN
 SCALE:20X

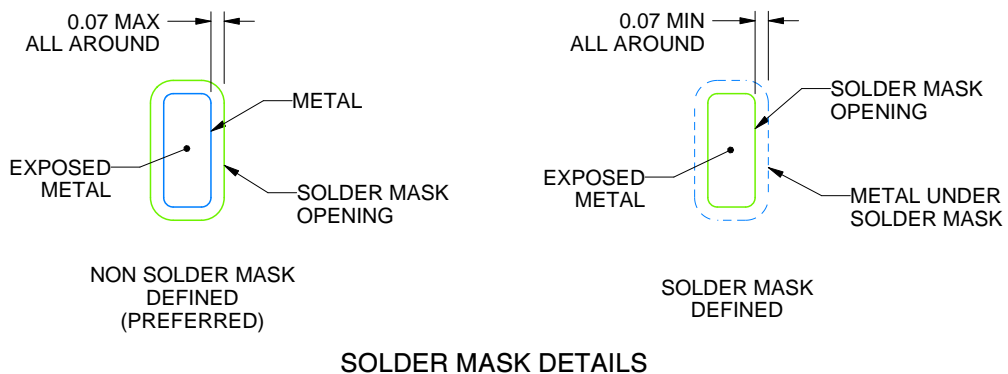

4222419/D 04/2022

NOTES: (continued)

- This package is designed to be soldered to a thermal pad on the board. For more information, see Texas Instruments literature number SLUA271 (www.ti.com/lit/sluea271).
- Vias are optional depending on application, refer to device data sheet. If any vias are implemented, refer to their locations shown on this view. It is recommended that vias under paste be filled, plugged or tented.

EXAMPLE STENCIL DESIGN

RGT0016C

VQFN - 1 mm max height

PLASTIC QUAD FLATPACK - NO LEAD

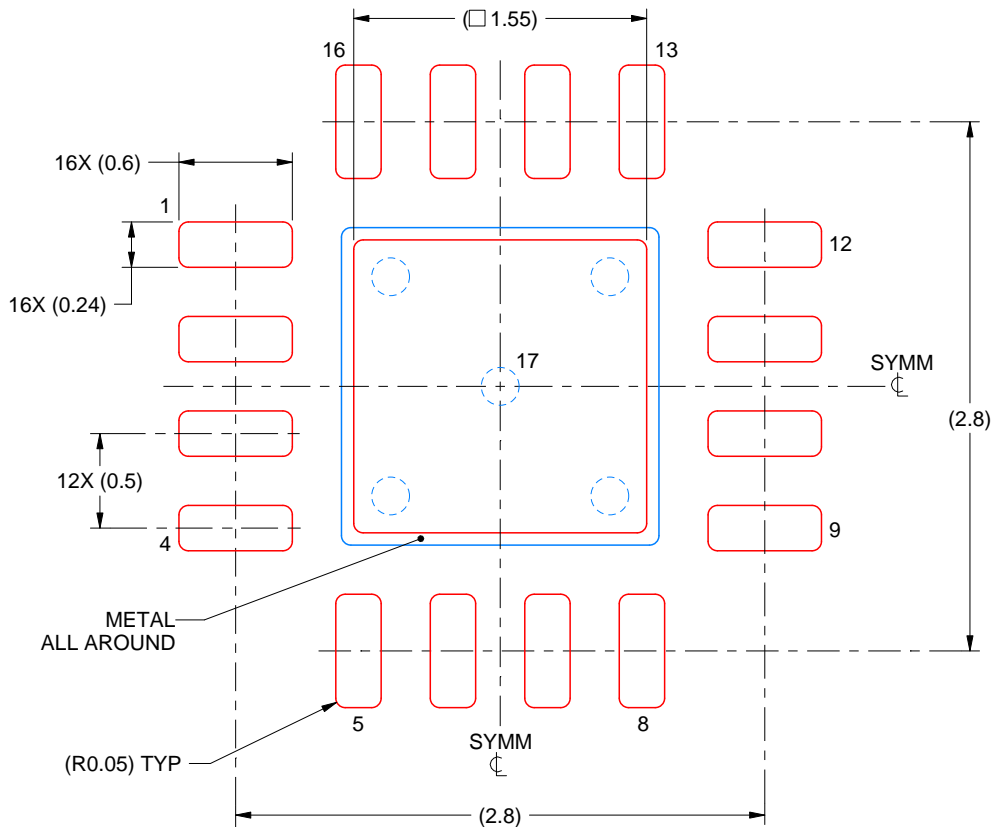

SOLDER PASTE EXAMPLE
BASED ON 0.125 mm THICK STENCIL

EXPOSED PAD 17:
85% PRINTED SOLDER COVERAGE BY AREA UNDER PACKAGE
SCALE:25X

4222419/D 04/2022

NOTES: (continued)

6. Laser cutting apertures with trapezoidal walls and rounded corners may offer better paste release. IPC-7525 may have alternate design recommendations.

重要声明和免责声明

TI“按原样”提供技术和可靠性数据（包括数据表）、设计资源（包括参考设计）、应用或其他设计建议、网络工具、安全信息和其他资源，不保证没有瑕疵且不做任何明示或暗示的担保，包括但不限于对适销性、某特定用途方面的适用性或不侵犯任何第三方知识产权的暗示担保。

这些资源可供使用 TI 产品进行设计的熟练开发人员使用。您将自行承担以下全部责任：(1) 针对您的应用选择合适的 TI 产品，(2) 设计、验证并测试您的应用，(3) 确保您的应用满足相应标准以及任何其他功能安全、信息安全、监管或其他要求。

这些资源如有变更，恕不另行通知。TI 授权您仅可将这些资源用于研发本资源所述的 TI 产品的应用。严禁对这些资源进行其他复制或展示。您无权使用任何其他 TI 知识产权或任何第三方知识产权。您应全额赔偿因在这些资源的使用中对 TI 及其代表造成的任何索赔、损害、成本、损失和债务，TI 对此概不负责。

TI 提供的产品受 [TI 的销售条款](#) 或 [ti.com](#) 上其他适用条款/TI 产品随附的其他适用条款的约束。TI 提供这些资源并不会扩展或以其他方式更改 TI 针对 TI 产品发布的适用的担保或担保免责声明。

TI 反对并拒绝您可能提出的任何其他或不同的条款。

邮寄地址：Texas Instruments, Post Office Box 655303, Dallas, Texas 75265

Copyright © 2023，德州仪器 (TI) 公司