

## TPS56623x 3V 至 18V 输入、6A 同步降压稳压器

### 1 特性

- 专为耐用的应用而设计
  - 3V 至 18V 输入电压范围
  - 输出电压范围为 0.6V 至 7V
  - 6A 持续输出电流
  - 0.6V  $\pm$ 1% 基准电压 (25°C)
  - 98% 最大占空比
  - 600kHz 开关频率
  - 非闭锁, 可提供 OC、OV、UV 和 OT 保护
  - 内置输出放电功能
- 大量兼容引脚的选项
  - 带 SS 引脚可实现可调软启动时间的 TPS566231 和 TPS566238
  - 带 PG 引脚可支持电源正常状态指示器的 TPS566231P 和 TPS566238P
  - 可支持自动跳越模式的 TPS566231 和 TPS566231P
  - 可支持连续电流模式的 TPS566238 和 TPS566238P
- [提供普通话数据表](#)
- 设计小巧且易于使用
  - 具有  $R_{DS(on)}$  20.8m $\Omega$  和 10.6m $\Omega$  的集成功率 MOSFET
  - 可实现快速瞬态响应和内部补偿的 D-CAP3™ 控制模式
  - 1.5mm  $\times$  2.0mm HotRod™ QFN 封装
  - 借助 [WEBENCH® Power Designer](#) 创建定制设计方案

### 2 应用

- [数字电视、机顶盒、游戏机](#)
- [服务器、存储和网络负载点](#)
- [工业 PC、IP 摄像机和工厂自动化应用](#)

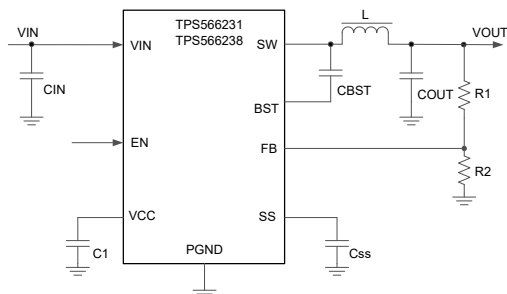

典型应用

### 3 说明

TPS56623x 是采用 QFN 9 引脚 1.5mm  $\times$  2.0mm 封装的简单、易用且高效的 6A 同步降压转换器。

这些器件采用更宽的电源输入电压范围 (3V 至 18V), 通过 D-CAP3 控制模式提供快速瞬态响应, 具有良好的线路和负载调节, 无需外部补偿, 并支持低 ESR 输出电容器。

TPS566231 和 TPS566231P 可在 Eco-mode 下运行, 从而能在轻载运行期间实现高效率。器件设计为 ULQ™ 直流/直流转换器, 可实现 50  $\mu$ A 静态电流, 从而在低功耗应用中延长电池寿命。TPS566238 和 TPS566238P 采用连续电流模式运行, 可在所有负载条件下保持较低的输出纹波。

TPS566231 和 TPS566238 软启动时间可通过 SS 引脚进行调节。TPS566231P 和 TPS566238P 通过 PG 引脚指示电源正常状态。

TPS56623x 可支持以高达 98% 的占空比运行, 并集成了全面的断续模式 OVP、OCP、UVLO、OTP 和 UVP 保护。该器件系列均采用 9 引脚 1.5mm  $\times$  2.0mm HotRod 封装。额定结温范围为 -40°C 至 125°C。

#### 器件信息

器件型号	轻负载模式	引脚 9 定义
TPS566231	自动跳越模式	软启动引脚
TPS566238	连续电流模式	软启动引脚
TPS566231P	自动跳越模式	电源正常引脚
TPS566238P	连续电流模式	电源正常引脚

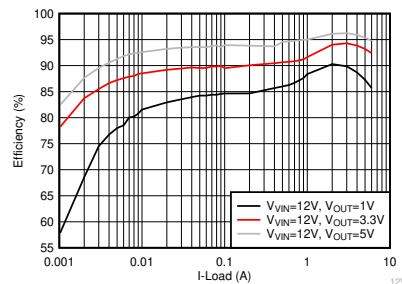

TPS566231 效率与输出电流间的关系



## Table of Contents

<b>1 特性</b> .....	<b>1</b>	<b>7 Application and Implementation</b> .....	<b>16</b>
<b>2 应用</b> .....	<b>1</b>	7.1 Application Information.....	16
<b>3 说明</b> .....	<b>1</b>	7.2 Typical Application.....	16
<b>4 Pin Configuration and Functions</b> .....	<b>3</b>	7.3 Power Supply Recommendations.....	22
<b>5 Specifications</b> .....	<b>4</b>	7.4 Layout.....	23
5.1 Absolute Maximum Ratings.....	4	<b>8 Device and Documentation Support</b> .....	<b>24</b>
5.2 ESD Ratings.....	4	8.1 Device Support.....	24
5.3 Recommended Operating Conditions.....	4	8.2 接收文档更新通知.....	24
5.4 Thermal Information.....	5	8.3 支持资源.....	24
5.5 Electrical Characteristics.....	5	8.4 Trademarks.....	24
5.6 Typical Characteristics.....	8	8.5 静电放电警告.....	24
<b>6 Detailed Description</b> .....	<b>12</b>	8.6 术语表.....	24
6.1 Overview.....	12	<b>9 Revision History</b> .....	<b>25</b>
6.2 Functional Block Diagram.....	12	<b>10 Mechanical, Packaging, and Orderable Information</b> .....	<b>26</b>
6.3 Feature Description.....	13		
6.4 Device Functional Modes.....	15		

## 4 Pin Configuration and Functions



图 4-1. TPS566231, TPS566238 9-Pin RQF, VQFN-HR Package (Top View)



图 4-2. TPS566231P, TPS566238P 9-Pin RQF, VQFN-HR Package (Top View)

表 4-1. Pin Functions

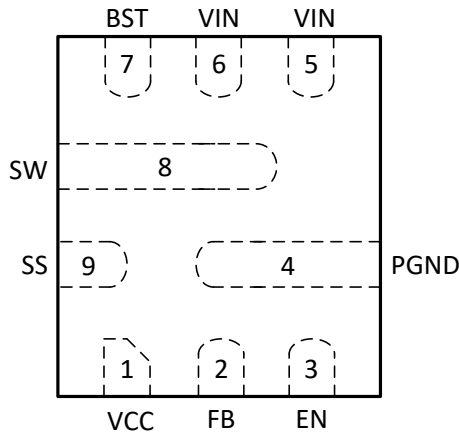
PIN		TYPE	DESCRIPTION
NAME	NO.		
VCC	1	O	5.0-V internal VCC LDO output. This pin supplies voltage to the internal circuitry and gate driver. Bypass this pin with a 1- $\mu$ F capacitor. If $V_{IN}$ is lower than 5 V, VCC follows the $V_{IN}$ voltage.
FB	2	I	Converter feedback input. Connect to the center tap of the resistor divider between output voltage and ground.
EN	3	I	Enable pin of buck converter. The EN pin is a digital input pin, so the pin decides to turn on or turn off the buck converter. If the EN pin is open, the internal pullup current occurs to enable converter.
PGND	4	G	Ground pin. Power ground return for the switching circuit. Connect sensitive SS and FB returns to PGND at a single point.
VIN	5, 6	P	Input voltage supply pin. Connect the input decoupling capacitors between VIN and PGND.
BST	7	O	Supply input for the gate drive voltage of the high-side MOSFET. Connect the bootstrap capacitor between BST and SW. TI recommends 0.1 $\mu$ F.
SW	8	O	Switch node terminal. Connect the output inductor to this pin.
SS/PG	9	O	TPS566231 and TPS566238 soft-start control pin. Connecting an external capacitor sets the soft-start time.
		O	TPS566231P and TPS566238P open-drain power good indicator. This pin is asserted low if output voltage is out of PG threshold, over voltage, or if the device is under thermal shutdown, EN shutdown, or during soft start.

## 5 Specifications

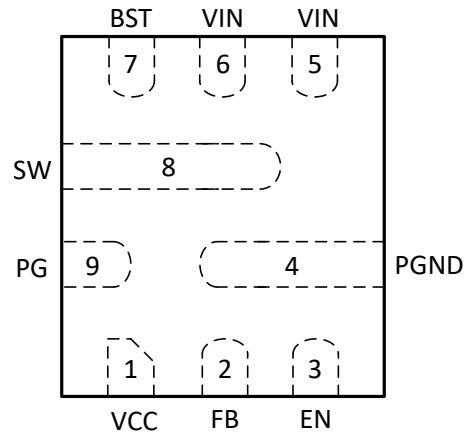
### 5.1 Absolute Maximum Ratings

over operating free-air temperature range (unless otherwise noted)<sup>(1)</sup>

			MIN	MAX	UNIT
Input voltage	VIN		- 0.3	20	V
	BST		- 0.3	26	V
	BST (10-ns transient)		-0.3	28	V
	BST-SW		- 0.3	7	V
	VIN-SW			22	V
	VIN-SW (10-ns transient)			25.5	V
	SS, FB, EN, PG		- 0.3	6	V
	PGND		- 0.3	0.3	V
Output voltage	SW		- 2	20	V
	SW (10-ns transient)		- 5.5	22	V
	VCC		- 0.3	6	V
T <sub>J</sub>	Operating junction temperature		- 40	150	°C
T <sub>stg</sub>	Storage temperature		- 55	150	°C

- (1) Stresses beyond those listed under *Absolute Maximum Rating* may cause permanent damage to the device. These are stress ratings only, which do not imply functional operation of the device at these or any other conditions beyond those indicated under *Recommended Operating Condition*. Exposure to absolute-maximum-rated conditions for extended periods may affect device reliability.

### 5.2 ESD Ratings

			VALUE	UNIT
V <sub>(ESD)</sub>	Electrostatic discharge	Human-body model (HBM), per ANSI/ESDA/JEDEC JS-001 <sup>(1)</sup>	±2000	V
		Charged-device model (CDM), per ANSI/ESDA/JEDEC JS-002 <sup>(2)</sup>	±500	

- (1) JEDEC document JEP155 states that 500-V HBM allows safe manufacturing with a standard ESD control process.  
(2) JEDEC document JEP157 states that 250-V CDM allows safe manufacturing with a standard ESD control process.

### 5.3 Recommended Operating Conditions

over operating free-air temperature range (unless otherwise noted)

			MIN	MAX	UNIT
Input voltage	VIN		3	18	V
	BST		- 0.1	23.5	V
	BST-SW		- 0.1	5.5	V
	SS, FB, EN, PG		- 0.1	5.5	V
	PGND		- 0.1	0.1	V
Output voltage	SW		- 1	18	V
	VCC		- 0.1	5.5	V
I <sub>OUT</sub>	Output current		0	6	A
T <sub>J</sub>	Operating junction temperature		- 40	125	°C

## 5.4 Thermal Information

THERMAL METRIC <sup>(1)</sup>		TPS566231/8, TPS5662381P/8P		UNIT
		RQF(VQFN)		
		9 PINS		
$R_{\theta JA}$	Junction-to-ambient thermal resistance	89.6		°C/W
$R_{\theta JA\_effective}$	Junction-to-ambient thermal resistance with TI EVM	44		°C/W
$R_{\theta JC(top)}$	Junction-to-case (top) thermal resistance	72.2		°C/W
$R_{\theta JB}$	Junction-to-board thermal resistance	25		°C/W
$\Psi_{JT}$	Junction-to-top characterization parameter	2.2		°C/W
$\Psi_{JB}$	Junction-to-board characterization parameter	24.8		°C/W
$R_{\theta JC(bot)}$	Junction-to-case (bottom) thermal resistance	NA		°C/W

(1) For more information about traditional and new thermal metrics, see the [Semiconductor and IC Package Thermal Metrics](#) application report.

## 5.5 Electrical Characteristics

$T_J = -40^{\circ}\text{C}$  to  $125^{\circ}\text{C}$ ,  $V_{IN}=12\text{ V}$  (unless otherwise noted)

PARAMETER		TEST CONDITIONS	MIN	TYP	MAX	UNIT
<b>INPUT SUPPLY VOLTAGE</b>						
$V_{IN}$	Input voltage range	$V_{IN}$	3		18	V
$I_{VIN}$	$V_{IN}$ supply current	No load, $V_{EN} = 5\text{V}$ , non-switching (TPS566231/1P)	25	50	75	$\mu\text{A}$
		No load, $V_{EN} = 5\text{V}$ , non-switching (TPS566238/8P)	275	375	475	$\mu\text{A}$
$I_{INSDN}$	$V_{IN}$ shutdown current	No load, $V_{EN} = 0\text{V}$		3.2	5	$\mu\text{A}$
<b>UVLO</b>						
$V_{UVLOVIN}$	$V_{IN}$ UVLO threshold	Wake up $V_{IN}$ voltage	2.62	2.74	2.86	V
		Shut down $V_{IN}$ voltage	2.44	2.54	2.64	V
		Hysteresis $V_{IN}$ voltage		200		mV
<b>VCC OUTPUT</b>						
$V_{CC}$	$V_{CC}$ output voltage	$V_{IN} = 12\text{V}$	4.7	5	5.2	V
		$V_{IN} = 3\text{V}$		3		V
$I_{CC}$	$V_{CC}$ current limit	$V_{IN}=12\text{V}$	20			$\text{mA}$
		$V_{IN} = 3\text{V}$	5			$\text{mA}$
<b>FEEDBACK VOLTAGE</b>						
$V_{FB}$	FB voltage	$T_J = 25^{\circ}\text{C}$	594	600	606	mV
		$T_J = -40^{\circ}\text{C}$ to $125^{\circ}\text{C}$	591	600	609	mV
<b>MOSFET</b>						
$R_{DS(ON)HI}$	High-side MOSFET $R_{ds(on)}$	$T_J = 25^{\circ}\text{C}$ , $V_{IN} \geq 5\text{V}$		20.8		$\text{m}\Omega$
		$T_J = 25^{\circ}\text{C}$ , $V_{IN} = 3\text{V}$		25.8		$\text{m}\Omega$
$R_{DS(ON)LO}$	Low-side MOSFET $R_{ds(on)}$	$T_J = 25^{\circ}\text{C}$ , $V_{IN} \geq 5\text{V}$		10.6		$\text{m}\Omega$
		$T_J = 25^{\circ}\text{C}$ , $V_{IN} = 3\text{V}$		13		$\text{m}\Omega$
$I_{OCL}$	Over current threshold	Valley current set point	6.1	7.4	8.9	A
$I_{NOCL}$	Negative over current threshold		2	3.4	5.3	A
<b>DUTY CYCLE and FREQUENCY CONTROL</b>						
$F_{SW}$	Switching frequency	$T_J = 25^{\circ}\text{C}$ , $V_{OUT} = 1.0\text{V}$		600		kHz
$T_{ON(MIN)}$	Minimum on-time <sup>(1)</sup>	$T_J = 25^{\circ}\text{C}$		50	90	ns

## 5.5 Electrical Characteristics (续)

$T_J = -40^{\circ}\text{C}$  to  $125^{\circ}\text{C}$ ,  $V_{IN}=12\text{ V}$  (unless otherwise noted)

PARAMETER		TEST CONDITIONS	MIN	TYP	MAX	UNIT
$T_{\text{OFF(MIN)}}$	Minimum off-time <sup>(1)</sup>	$V_{\text{FB}} = 0.5\text{V}$		100		ns

## 5.5 Electrical Characteristics (续)

$T_J = -40^{\circ}\text{C}$  to  $125^{\circ}\text{C}$ ,  $V_{IN}=12\text{ V}$  (unless otherwise noted)

PARAMETER		TEST CONDITIONS	MIN	TYP	MAX	UNIT
<b>LOGIC THRESHOLD</b>						
$V_{EN(ON)}$	EN threshold high-level		1.13	1.19	1.25	V
$V_{EN(OFF)}$	EN threshold low-level		1.01	1.08	1.16	V
$V_{ENHYS}$	EN hysteresis			110		mV
$I_{EN}$	EN pullup current	$V_{EN} = 1.0\text{V}$		2		$\mu\text{A}$
<b>OUTPUT DISCHARGE and SOFT START</b>						
$R_{DIS}$	Discharge resistance	$T_J = 25^{\circ}\text{C}$ , $V_{OUT} = 0.5\text{V}$ , $V_{EN} = 0\text{V}$		114		$\Omega$
$I_{SS}$	Soft-start charge current	TPS566231/TPS566238	5	6.5	8.5	$\mu\text{A}$
$T_{SS}$	Internal soft-start time	TPS566231P/TPS566238P	0.93	1.9	2.9	ms
<b>POWER GOOD (TPS566231P/TPS566238P)</b>						
$T_{PGDLY}$	PG start-up delay	PG from low-to-high		1		ms
		PG from high-to-low		32		$\mu\text{s}$
$V_{PGTH}$	PG threshold	VFB falling (fault)	80	85	90	%
		VFB rising(good)	85	90	95	%
		VFB rising (fault)	110	115	120	%
		VFB falling (good)	105	110	115	%
$V_{PG\_L}$	PG sink current capability	$I_{OL} = 4\text{mA}$			0.4	V
$I_{PGLK}$	PG leak current	$V_{PGOOD} = 5.5\text{V}$			1	$\mu\text{A}$
<b>OUTPUT UNDERVOLTAGE AND OVERVOLTAGE PROTECTION</b>						
$V_{OVP}$	OVP trip threshold		110	115	120	%
$t_{OVPDLY}$	OVP prop deglitch	$T_J = 25^{\circ}\text{C}$		32		$\mu\text{s}$
$V_{UVP}$	UVP trip threshold		55	60	65	%
$t_{UVPDLY}$	UVP prop deglitch			256		$\mu\text{s}$
$t_{UVPDEL}$	Output hiccup delay relative to SS time	UVP detect		256		$\mu\text{s}$
$t_{UVPEN}$	Output hiccup enable delay relative to SS time	UVP detect (TPS566231/TPS566238)		7		cycles
$t_{UVPEN}$	Output hiccup enable delay relative to SS time	UVP detect (TPS566231P/TPS566238P)		19		ms
<b>THERMAL PROTECTION</b>						
$T_{OTP}$	OTP trip threshold <sup>(1)</sup>			160		$^{\circ}\text{C}$
$T_{OTPHYS}$	OTP hysteresis <sup>(1)</sup>			25		$^{\circ}\text{C}$

(1) No production test, specified by design.

## 5.6 Typical Characteristics

$T_J = -40^{\circ}\text{C}$  to  $125^{\circ}\text{C}$ ,  $V_{IN} = 12\text{ V}$  (unless otherwise noted)



图 5-1. Supply Current vs Junction Temperature



图 5-2. Supply Current vs Junction Temperature

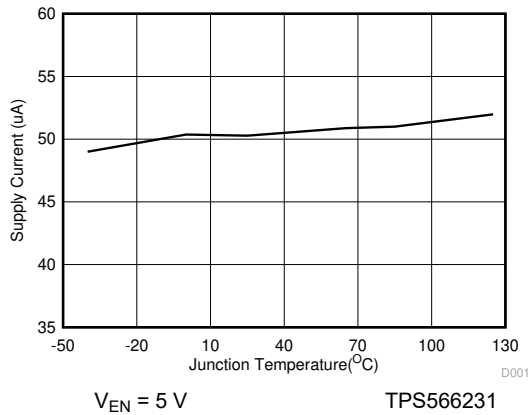

图 5-3. Shutdown Current vs Temperature

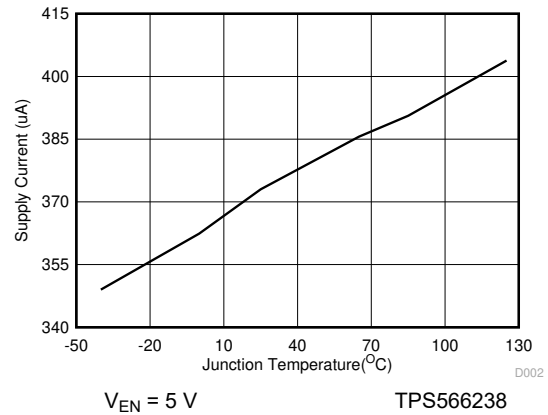

图 5-4. Feedback Voltage vs Junction Temperature

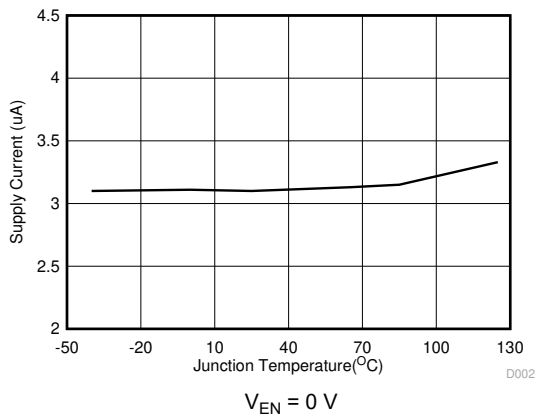

图 5-5. Enable-On Voltage vs Junction Temperature

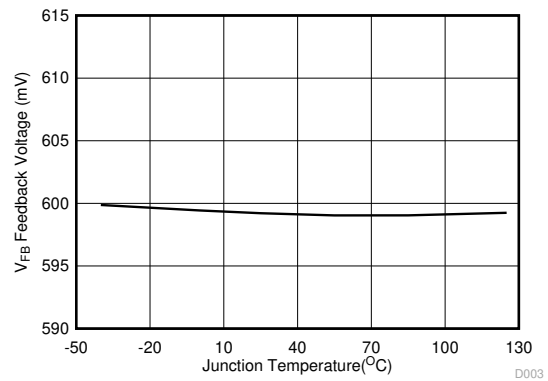

图 5-6. Enable-Off Voltage vs Junction Temperature

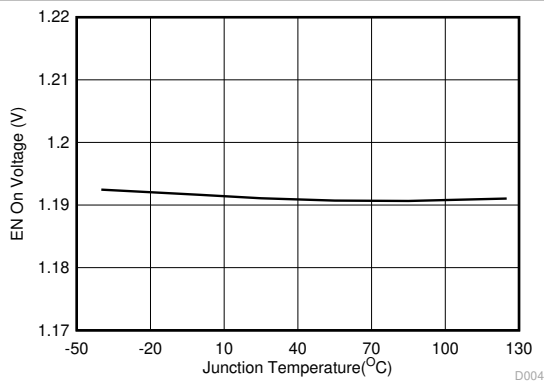

### 5.6 Typical Characteristics (continued)

$T_J = -40^{\circ}\text{C}$  to  $125^{\circ}\text{C}$ ,  $V_{IN} = 12\text{ V}$  (unless otherwise noted)

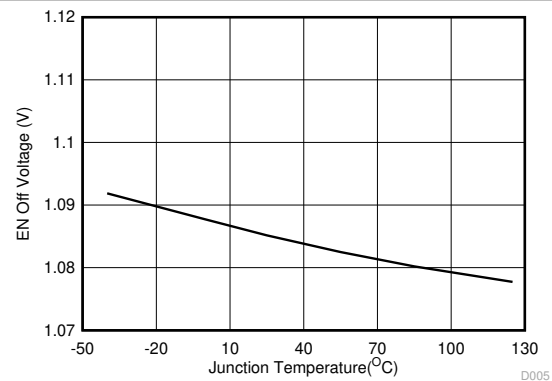

图 5-7. High-Side  $R_{DS(on)}$  vs Junction Temperature



图 5-8. Low-Side  $R_{DS(on)}$  vs Junction Temperature

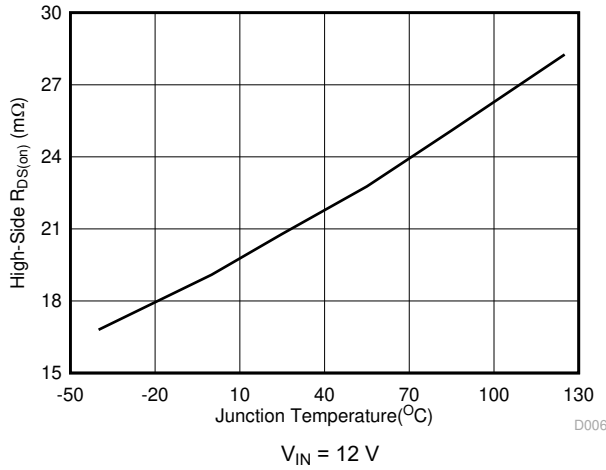

图 5-9. High-Side  $R_{DS(on)}$  vs Junction Temperature

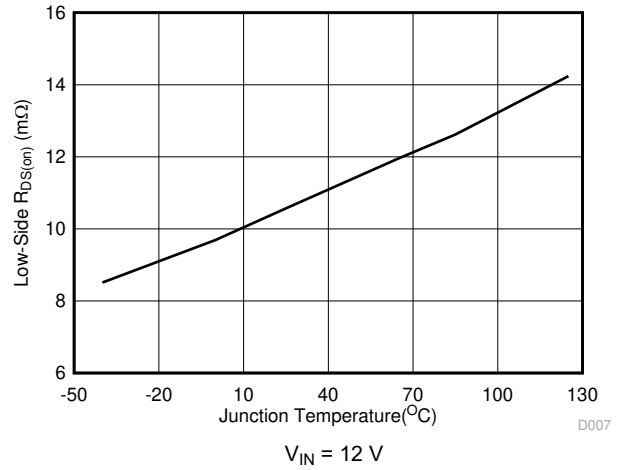

图 5-10. Low-Side  $R_{DS(on)}$  vs Junction Temperature

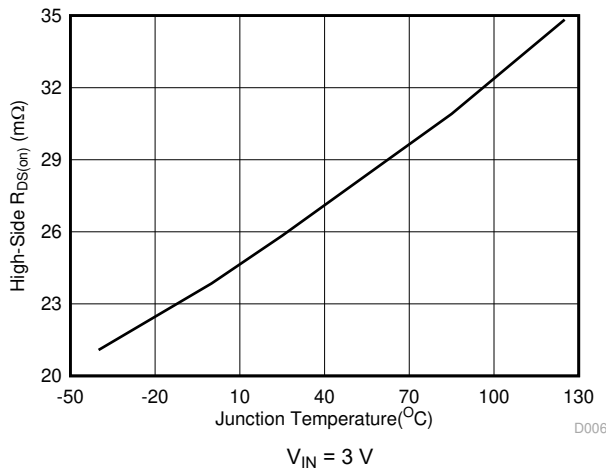

图 5-11. OVP Threshold vs Junction Temperature

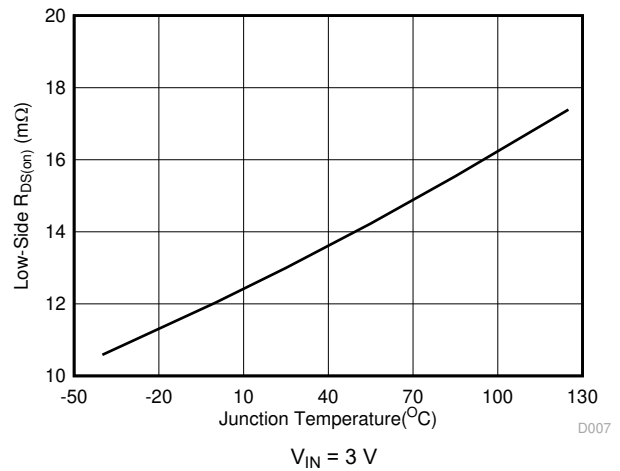

图 5-12. UVP Threshold vs Junction Temperature

## 5.6 Typical Characteristics (continued)

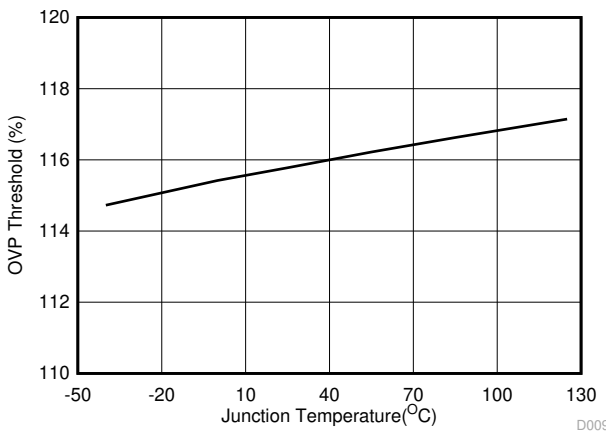
$T_J = -40^{\circ}\text{C}$  to  $125^{\circ}\text{C}$ ,  $V_{IN} = 12\text{ V}$  (unless otherwise noted)

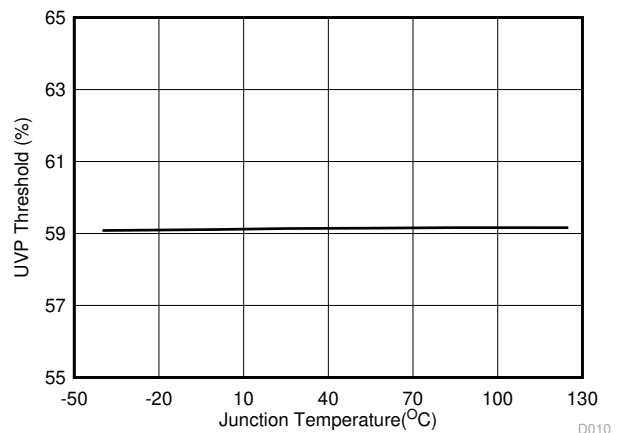

图 5-13. Discharge Resistor vs Junction Temperature



图 5-14. Valley Current Limit vs Junction Temperature

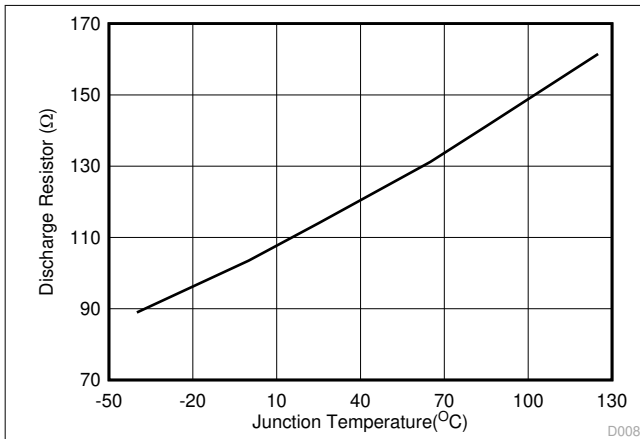

TPS566231 and TPS566238

图 5-15. Soft-Start Charge Current Iss vs Junction Temperature

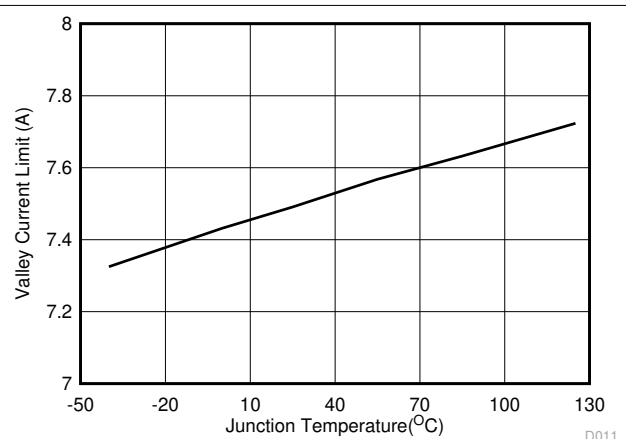
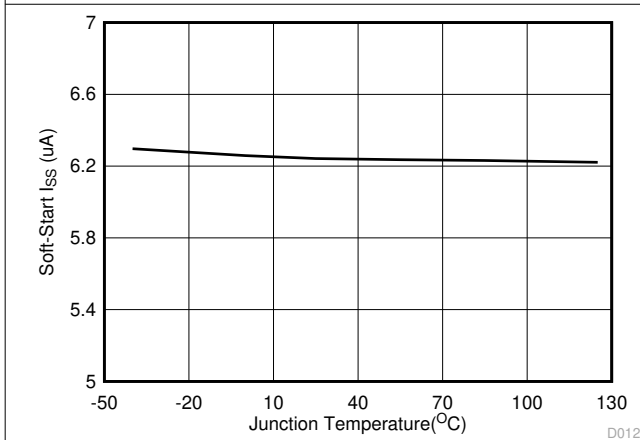
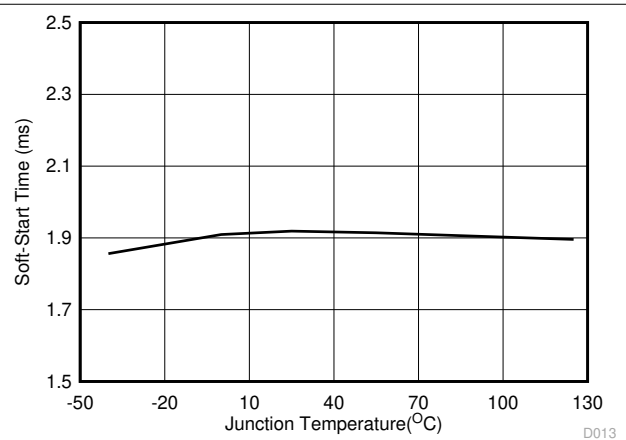

TPS566231P and TPS566238P

图 5-16. Soft-Start Time vs Junction Temperature



图 5-17. Safe Operating Area



图 5-18. TPS566238 and TPS566238P Efficiency

## 5.6 Typical Characteristics (continued)

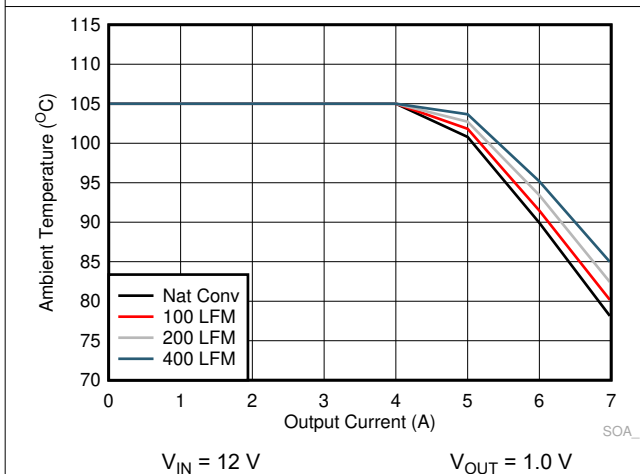
$T_J = -40^{\circ}\text{C}$  to  $125^{\circ}\text{C}$ ,  $V_{IN} = 12\text{ V}$  (unless otherwise noted)

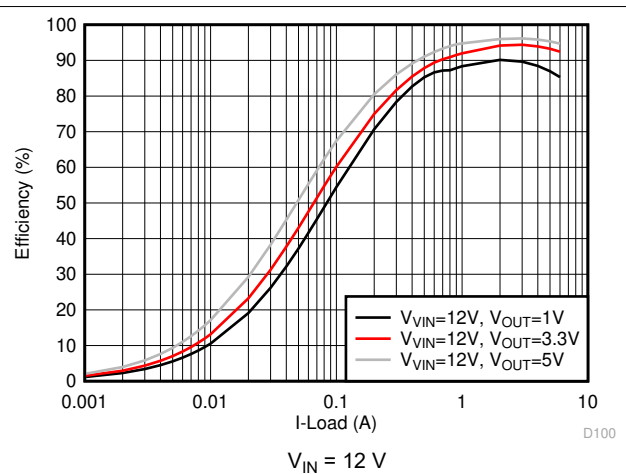
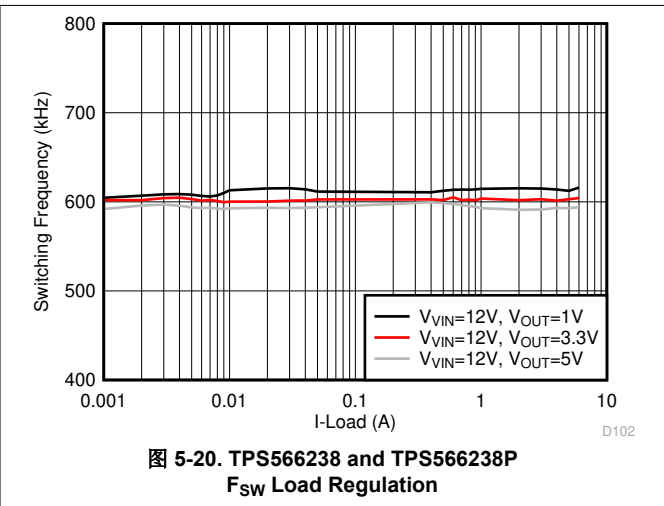
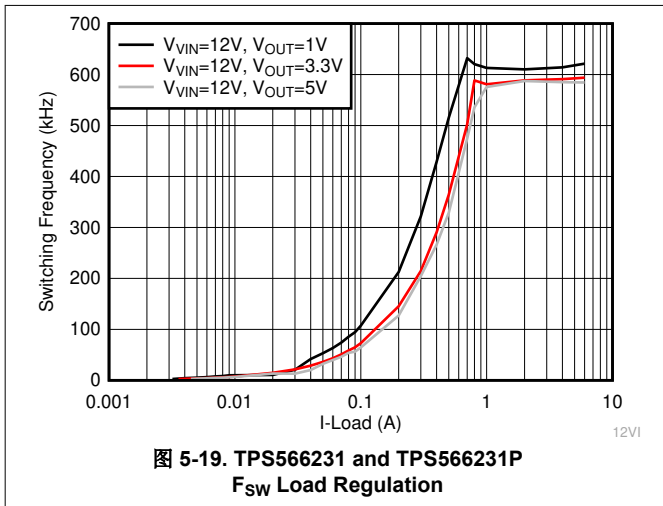

## 6 Detailed Description

### 6.1 Overview

The TPS56623x is a 6-A, integrated, FET, synchronous buck converter that operates from 3-V to 18-V input voltage ( $V_{IN}$ ) and 0.6-V to 7-V output voltage. The proprietary D-CAP3 control mode enables low external component count, ease of design, and optimization of the power design for cost, size, and efficiency. As the ULQ™ DC/DC converter, the device enables long battery life in system standby mode and high efficiency under light load conditions. The devices employ D-CAP3 control mode that provides fast transient response with no external compensation components and an accurate feedback voltage. The control topology provides a seamless transition between CCM operating mode in heavier load conditions and DCM operation in lighter load conditions.

Eco-mode allows the TPS566231 and TPS566231P to maintain high efficiency at light load. The TPS566238 and TPS566238P work in continuous current mode to maintain lower output ripple in all load conditions. The soft-start time of the TPS566231 and TPS566238 can be adjusted through the SS pin. The TPS566231P and TPS566238P indicate power good through the PG pin. The devices are able to adapt to both low equivalent series resistance (ESR) output capacitors, such as POS-CAP or SP-CAP, and ultra-low ESR ceramic capacitors.

### 6.2 Functional Block Diagram

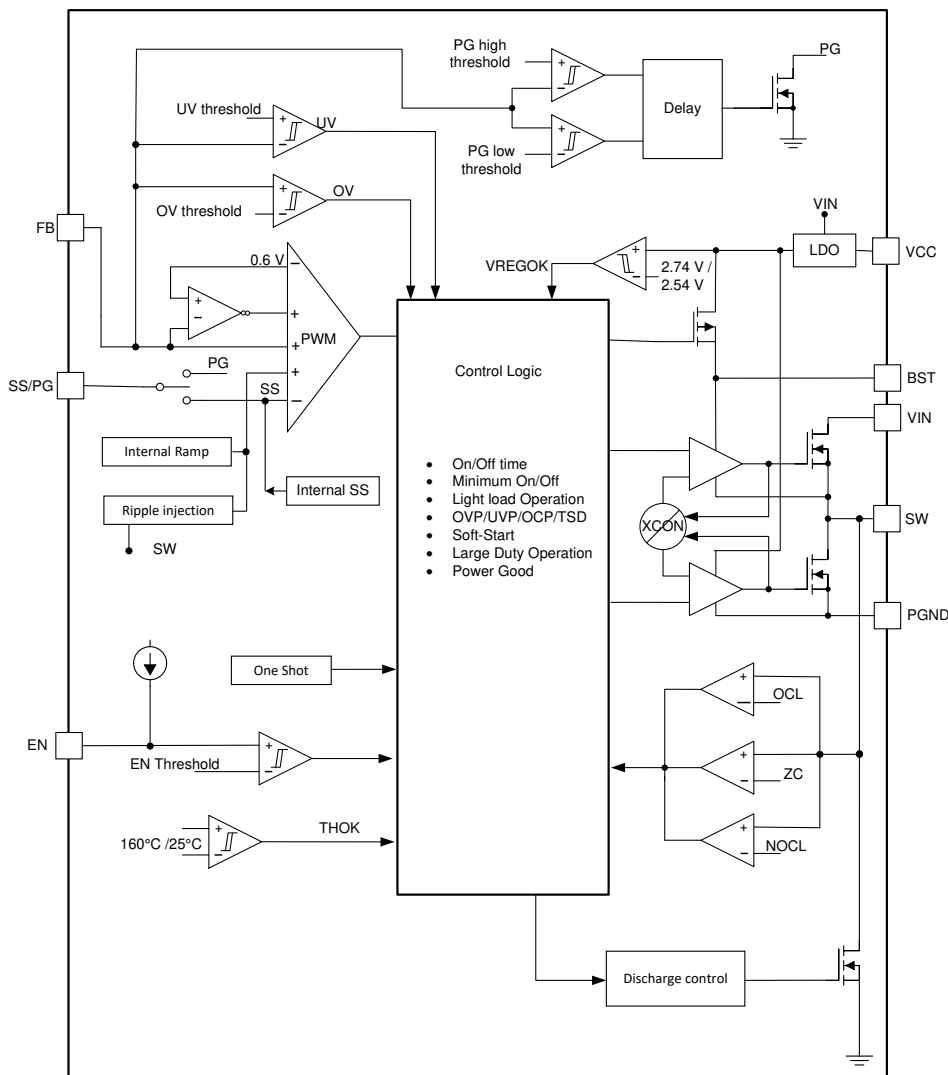

## 6.3 Feature Description

### 6.3.1 PWM Operation and D-CAP3™ Control Mode

The main control loop of the buck is an adaptive on-time pulse width modulation (PWM) controller that supports a proprietary D-CAP3 control mode. D-CAP3 control mode combines adaptive on-time control with an internal compensation circuit for pseudo-fixed frequency and low external component count configuration with both low-ESR and ceramic output capacitors. It is stable even with virtually no ripple at the output. The TPS56623x also includes an error amplifier that makes the output voltage very accurate.

At the beginning of each cycle, the high-side MOSFET is turned on. This MOSFET is turned off after an internal one-shot timer expires. This one-shot duration is set proportional to the output voltage,  $V_{OUT}$ , and is inversely proportional to the converter input voltage,  $V_{IN}$ . This is done to maintain a pseudo-fixed frequency over the input voltage range, hence it is called adaptive on-time control. The one-shot timer is reset and the high-side MOSFET is turned on again when the feedback voltage falls below the reference voltage. An internal ripple generation circuit is added to the reference voltage to emulate the output ripple. This enables the use of very low-ESR output capacitors such as multi-layered ceramic caps (MLCC). No external current sense network or loop compensation is required for D-CAP3 control mode.

For any control topology that is compensated internally, there is a range of the output filter it can support. The output filter used with the devices is a low-pass L-C circuit. This L-C filter has a double-pole frequency described in [方程式 1](#).

$$f_p = \frac{1}{2 \times \pi \times \sqrt{L_{OUT} \times C_{OUT}}} \quad (1)$$

At low frequency, the overall loop gain is set by the output setpoint resistor divider network and the internal gain of the TPS56623x. The low-frequency L-C double pole has a 180 degree drop in-phase. At the output filter frequency, the gain rolls off at a -40-dB per decade rate and the phase drops rapidly. The internal ripple generation network introduces a high-frequency zero that reduces the gain rolloff from -40-dB to -20-dB per decade and leads the 90 degree phase boost. The internal ripple injection high-frequency zero is approximately 45 kHz. The inductor and capacitor selected for the output filter is recommended such that the double pole is located close to 1/3 the high-frequency zero. This is done so that the phase boost provided by this high-frequency zero provides adequate phase margin for the stability requirement. The crossover frequency of the overall system usually must be targeted to be less than one-third of the switching frequency ( $F_{SW}$ ).

### 6.3.2 Soft Start

The TPS566231 and TPS566238 have an external SS pin to set the soft-start time. When the EN pin becomes high, the soft start function begins ramping up the reference voltage to the PWM comparator.

If the application needs a longer soft-start time than 0.5 ms, the time can be set by connecting a capacitor on the SS pin. When the EN pin becomes high, the soft-start charge current ( $I_{SS}$ ) begins charging the external capacitor ( $C_{SS}$ ) connected between SS and ground. The devices track the lower of the internal soft-start voltage or the external soft-start voltage as the reference. The estimated equation for the soft-start time ( $T_{SS}$ ) is shown in [方程式 2](#):

$$T_{ss}(ms) = \frac{1.4 \times C_{ss}(nF) \times V_{REF}(V)}{I_{ss}(\mu A)} \quad (2)$$

where

- $V_{REF}$  is 0.6 V
- $I_{SS}$  is 6.5  $\mu$ A

### 6.3.3 Power Good

The TPS566231P and TPS566238P have the PG pin as a power-good indicator. The PG pin is an open-drain output. After the  $V_{FB}$  is between 90% and 110% of the internal reference voltage ( $V_{REF}$ ), the PG is de-asserted and floats after a 1-ms de-glitch time. TI recommends a 100-k $\Omega$  pullup resistor to pull the voltage up to VCC. The PG pin is pulled low when:

- The FB pin voltage is lower than 85% or greater than 115% of the target output voltage
- The device is in an OVP, UVP, or thermal shutdown event
- Or during the soft-start period

### 6.3.4 Large Duty Operation

The TPS56623x can support large duty operations by smoothly dropping down the switching frequency. When  $V_{IN} / V_{OUT} < 1.6$  and the  $V_{FB}$  is lower than internal  $V_{REF}$ , the switching frequency is allowed to smoothly drop to make  $T_{ON}$  extended. This action is done to implement large duty operation and also improve the performance of the load transient performance. The minimum switching frequency is limited with about 165 kHz with typical 100-ns minimum off-time. The TPS56623x can support up to 98% duty cycle operation.

### 6.3.5 Overcurrent Protection and Undervoltage Protection

The TPS56623x has overcurrent protection and undervoltage protection. The output overcurrent limit (OCL) is implemented using a cycle-by-cycle valley detect circuit. The switch current is monitored during the OFF state by measuring the low-side FET drain-to-source voltage. This voltage is proportional to the switch current. To improve accuracy, the voltage sensing is temperature compensated.

During the on-time of the high-side FET switch, the switch current increases at a linear rate determined by the following:

- $V_{IN}$
- $V_{OUT}$
- the on-time
- the output inductor value

During the on-time of the low-side FET switch, this current decreases linearly. The average value of the switch current is the load current  $I_{OUT}$ . If the monitored current is above the OCL level, the converter maintains low-side FET on and delays the creation of a new set pulse. This is true even if the voltage feedback loop requires one, until the current level becomes OCL level or lower. In subsequent switching cycles, the on-time is set to a fixed value and the current is monitored in the same manner.

There are some important considerations for this type of overcurrent protection. When the load current is higher than the overcurrent threshold by one half of the peak-to-peak inductor ripple current, the OCL is triggered and the current is limited. The output voltage tends to drop because the load demand is higher than what the converter can support. When the output voltage falls below 60% of the target voltage, the UVP comparator detects it and the device shuts off after a 256- $\mu$ s wait time. The device then restarts after the hiccup time (typically  $7 \times T_{SS}$ ). When the overcurrent condition is removed, the output is recovered.

### 6.3.6 Overvoltage Protection

The TPS56623x has the overvoltage protection feature. When the output voltage becomes higher than 115% of the target voltage, the OVP is triggered. The output is discharged after a 32- $\mu$ s wait time, and both the high-side and low-side MOSFET driver turn off. When the overvoltage condition is removed, the output voltage is recovered.

### 6.3.7 UVLO Protection

Undervoltage lockout protection (UVLO) monitors the  $V_{IN}$  power input. When the voltage is lower than UVLO threshold voltage, the device is shut off and output is discharged. This protection is a non-latch protection.

### 6.3.8 Output Voltage Discharge

The TPS56623x has the discharge function by using a 114-Ω  $R_{DS(on)}$  internal MOSFET, which discharges the output  $V_{OUT}$  through the SW node during any event like the following occurs:

- Output overvoltage protection
- Output undervoltage protection
- TSD
- VCC voltage is below the UVLO
- EN pin voltage ( $V_{EN}$ ) is below the turn-on threshold

The discharge is slow due to the lower current capability of the MOSFET.

### 6.3.9 Thermal Shutdown

The TPS56623x monitors the internal die temperature. If the temperature exceeds the threshold value (typically 160°C), the device is shut off and the output is discharged. This protection is a non-latched protection. The device restarts switching when the temperature goes below the thermal shutdown threshold.

## 6.4 Device Functional Modes

### 6.4.1 Advanced Eco-mode Control

The TPS566231 and TPS566231P operate in advanced Eco-mode mode, which maintains high light-load efficiency. As the output current decreases from heavy load conditions, the inductor current is also reduced and eventually the rippled valley touches zero level. This is the boundary between continuous conduction and discontinuous conduction modes. The rectifying MOSFET is turned off when the zero inductor current is detected. As the load current further decreases, the converter runs into discontinuous conduction mode. The on-time is kept almost the same as it was in continuous conduction mode so that it takes longer time to discharge the output capacitor with smaller load current to the level of the reference voltage. This makes the switching frequency lower, proportional to the load current, and keeps the light load efficiency high. Use [方程式 3](#) to calculate the light load current where the transition to Eco-mode operation happens ( $I_{OUT(LL)}$ ).

$$I_{OUT(LL)} = \frac{1}{2 \times L_{OUT} \times F_{SW}} \times \frac{(V_{IN} - V_{OUT}) \times V_{OUT}}{V_{IN}} \quad (3)$$

After identifying the application requirements, design the output inductance ( $L_{OUT}$ ) so that the inductor peak-to-peak ripple current is approximately 20% to 30% of  $I_{OUT(max)}$  (peak current in the application). Make sure to size the inductor properly so that the valley current does not hit the negative low-side current limit.

### 6.4.2 Force CCM Mode

The TPS566238 and TPS566238P operate in Force CCM (FCCM) mode, which keeps the converter operating in continuous current mode during light-load conditions. FCCM allows the inductor current to become negative. During FCCM mode, the switching frequency ( $F_{SW}$ ) is maintained at an almost constant level over the entire load range. This is an excellent choice for applications requiring tight control of the switching frequency and output voltage ripple at the cost of lower efficiency under light load.

### 6.4.3 Standby Operation

The TPS56623x can be placed in standby mode by pulling the EN pin low. The device operates with 3.2-μA shutdown current in standby condition. The EN pin is pulled high internally. When floating, the part is enabled by default.

## 7 Application and Implementation

### 备注

以下应用部分中的信息不属于 TI 器件规格的范围，TI 不担保其准确性和完整性。TI 的客户应负责确定器件是否适用于其应用。客户应验证并测试其设计，以确保系统功能。

### 7.1 Application Information

The schematic in 图 7-1 shows a typical application for the TPS566231 with 1-V output. This design converts an input voltage range of 3 V to 18 V down to 1 V with a maximum output current of 6 A.

### 7.2 Typical Application



图 7-1. 1-V, 6-A Reference Design

#### 7.2.1 Design Requirements

表 7-1 lists the design parameters for this example.

表 7-1. Design Parameters

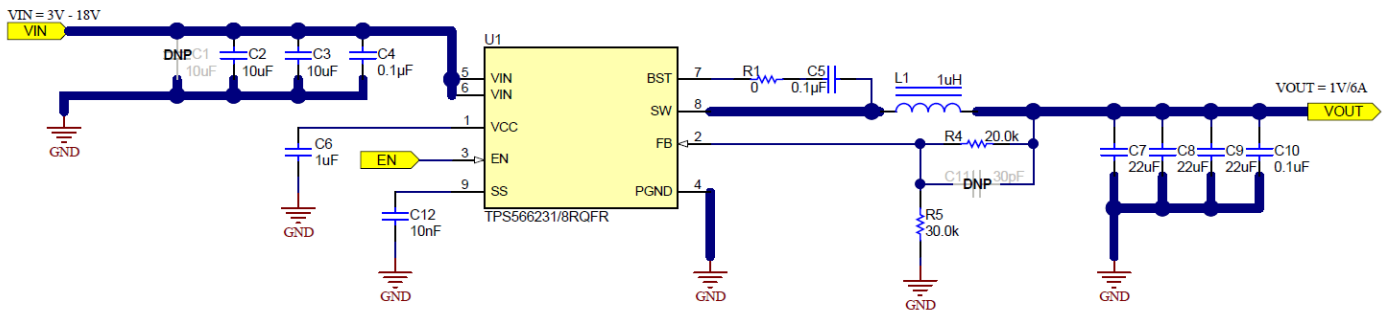
PARAMETER	CONDITIONS	MIN	TYP	MAX	UNIT
$V_{OUT}$	Output voltage		1		V
$I_{OUT}$	Output current		6		A
$\Delta V_{OUT}$	Transient response		$\pm 50$		mV
$V_{IN}$	Input voltage	3	12	18	V
$V_{OUT(ripple)}$	Output voltage ripple		14		mV <sub>(p-p)</sub>
$F_{SW}$	Switching frequency		600		kHz
$T_A$	Ambient temperature		25		°C

#### 7.2.2 Detailed Design Procedure

##### 7.2.2.1 Custom Design with WEBENCH® Tools

[Click here](#) to create a custom design using the TPS56623x device with the WEBENCH Power Designer.

1. Start by entering the input voltage ( $V_{IN}$ ), output voltage ( $V_{OUT}$ ), and output current ( $I_{OUT}$ ) requirements.
2. Optimize the design for key parameters such as efficiency, footprint, and cost.
3. Compare the generated design with other possible solutions from Texas Instruments.

The WEBENCH Power Designer provides a customized schematic along with a list of materials with real-time pricing and component availability.

In most cases, these actions are available:

- Estimate IC thermal and efficiency performance
- Run electrical simulations to see important waveforms and circuit performance



- Export customized schematic and layout into popular CAD formats
- Print PDF reports for the design, and share the design with colleagues

Get more information about WEBENCH tools at [www.ti.com/WEBENCH](http://www.ti.com/WEBENCH).

### 7.2.2.2 Output Voltage Setpoint

To change the output voltage of the application, changing the value of the upper feedback resistor is necessary. By changing this resistor, the user can change the output voltage above 0.6 V. See [方程式 4](#).

$$V_{OUT} = 0.6 \times \left(1 + \frac{R_{UPPER}}{R_{LOWER}}\right) \quad (4)$$

### 7.2.2.3 Inductor Selection

The inductor ripple current is filtered by the output capacitor. A higher inductor ripple current means the output capacitor must have a ripple current rating higher than the inductor ripple current. See [表 7-2](#) for recommended inductor values.

The RMS and peak currents through the inductor can be calculated using [方程式 5](#) and [方程式 6](#). Make sure that the inductor is rated to handle these currents.

$$I_{L(RMS)} = \sqrt{\left[ I_{OUT}^2 + \frac{1}{12} \times \left( \frac{V_{OUT} \times (V_{IN(max)} - V_{OUT})}{V_{IN(max)} \times L_{OUT} \times F_{SW}} \right)^2 \right]} \quad (5)$$

$$I_{L(peak)} = I_{OUT} + \frac{I_{L(ripple)}}{2} \quad (6)$$

During transient and short-circuit conditions, the inductor current can increase up to the current limit of the device. This means that choosing an inductor with a saturation current higher than the peak current under current limit condition is safe.

### 7.2.2.4 Output Capacitor Selection

After selecting the inductor the output capacitor must be optimized. In D-CAP3 control mode, the regulator reacts within one cycle to the change in duty cycle so the good transient performance can be achieved without needing large amounts of output capacitance. The recommended output capacitance range is given in [表 7-2](#). Please note these values are effective capacitance values which take into account the DC-bias applied on the capacitors. TI does not recommend to choose the combination of *minimum* inductance and *minimum* capacitance or *maximum* inductance and *maximum* capacitance.

Ceramic capacitors have very low ESR, otherwise the maximum ESR of the capacitor must be less than  $V_{OUT(ripple)} / I_{OUT(ripple)}$ .

**表 7-2. Recommended Component Values**

V <sub>OUT</sub> (V)	R <sub>LOWER</sub> (kΩ)	R <sub>UPPER</sub> (kΩ)	L <sub>OUT</sub> (μH)			C <sub>OUT</sub> (μF)		C <sub>FF</sub> (PF)
			MIN	TYP	MAX	MIN	MAX	
0.6	10	0	0.68	1	4.7	44	220	-
1	30	20	0.68	1	4.7	44	220	-
1.2	20	20	1	1.2	4.7	44	220	-
1.8	20	40	1	1.5	4.7	44	220	0-50
3.3	20	90	1.5	2.2	4.7	44	220	10-100
5.0	30	220	1.5	2.2	4.7	44	220	10-100

### 7.2.2.5 Input Capacitor Selection

The devices require input decoupling capacitors on power supply input  $V_{IN}$ . Also, bulk capacitors are needed depending on the application. The minimum input capacitance required is given in [方程式 7](#).

$$C_{IN(min)} = \frac{I_{OUT} \times V_{OUT}}{V_{IN(ripple)} \times V_{IN} \times F_{SW}} \quad (7)$$

TI recommends using high-quality X5R or X7R input decoupling capacitors of 30  $\mu$ F on the input voltage pin  $V_{IN}$ . The voltage rating on the input capacitor must be greater than the maximum input voltage. The capacitor must also have a ripple current rating greater than the maximum input current ripple of the application. The input ripple current is calculated by [方程式 8](#):

$$I_{CIN(rms)} = I_{OUT} \times \sqrt{\frac{V_{OUT}}{V_{IN(min)}} \times \frac{(V_{IN(min)} - V_{OUT})}{V_{IN(min)}}} \quad (8)$$

A 1- $\mu$ F ceramic capacitor is needed for the decoupling capacitor on the VCC pin.

### 7.2.3 Application Curves

图 7-2 through 图 7-25 apply to the circuit of 图 7-1.  $V_{IN} = 12\text{ V}$ ,  $T_A = 25^\circ\text{C}$  unless otherwise specified.



图 7-2. TPS566231 Efficiency Curve



图 7-3. TPS566238 Efficiency Curve

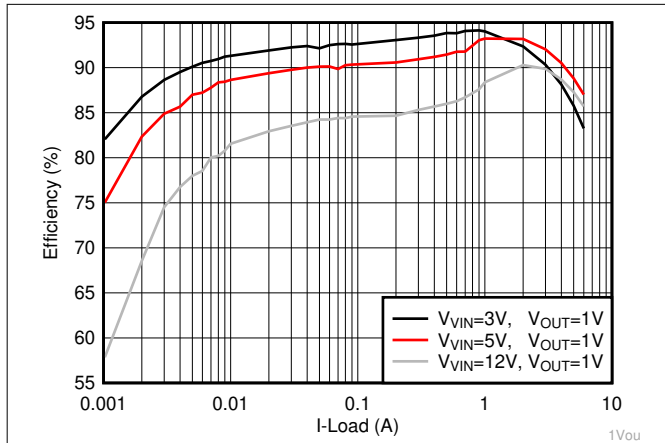

图 7-4. TPS566231 Load Regulation

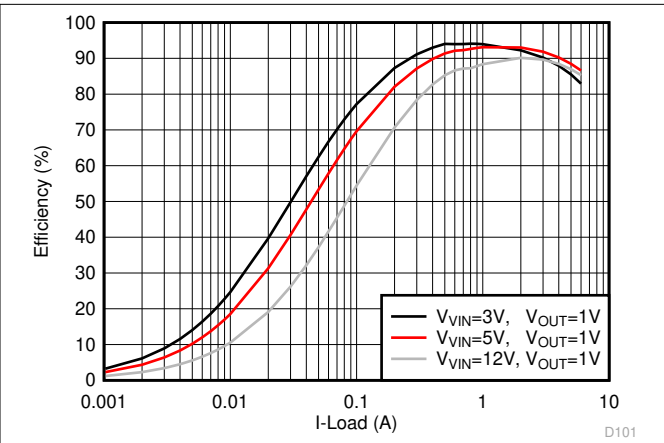

图 7-5. TPS566238 Load Regulation

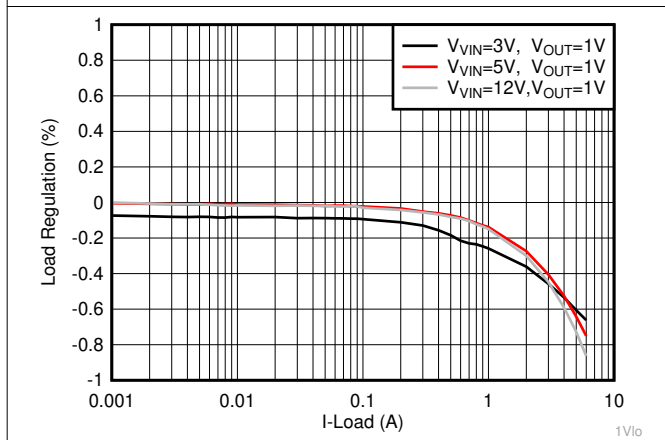

图 7-6. TPS566231  $F_{SW}$  vs Output Load

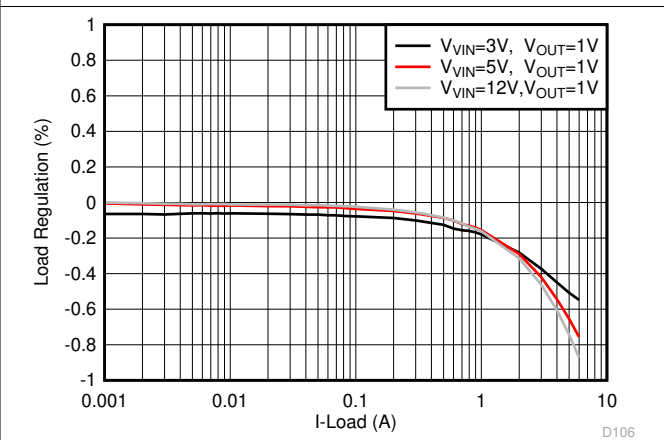

图 7-7. TPS566238  $F_{SW}$  vs Output Load

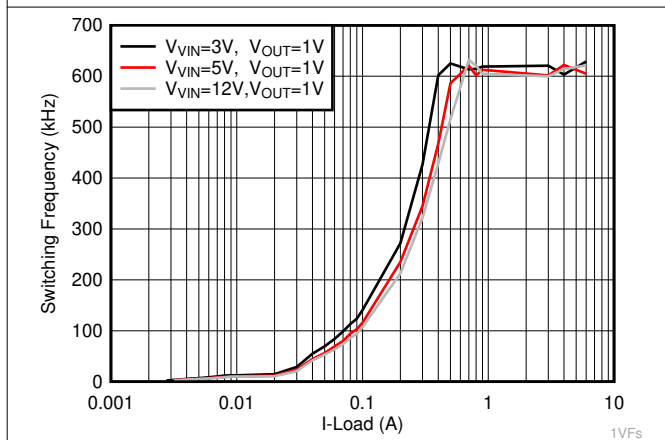

图 7-8. Switching Frequency vs Input Voltage

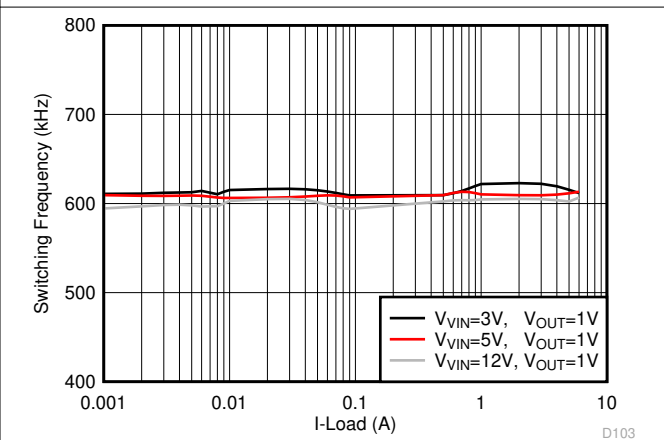

图 7-9. TPS566231 Line Regulation

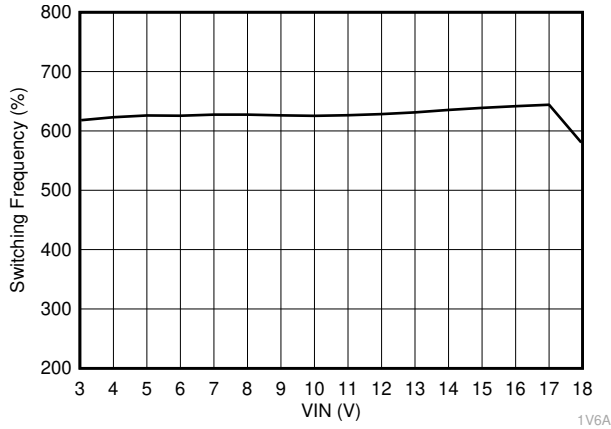

图 7-10. TPS566238 Line Regulation

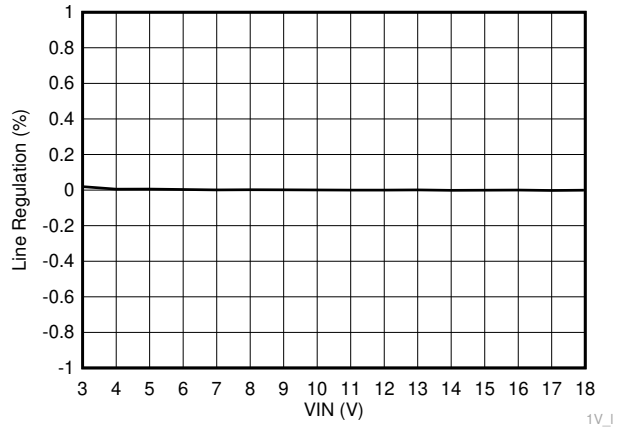

图 7-11. Line Regulation

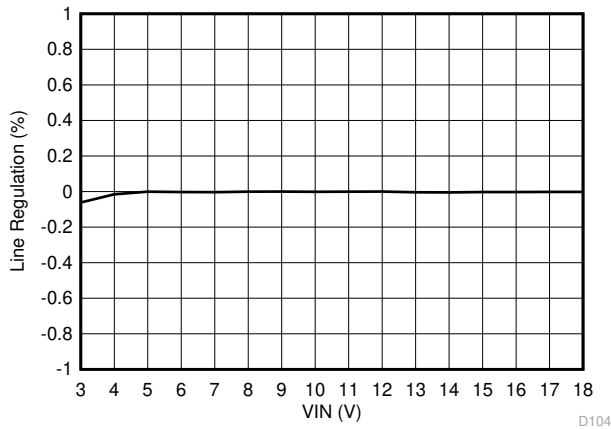

图 7-12. TPS566231 Output Voltage Ripple

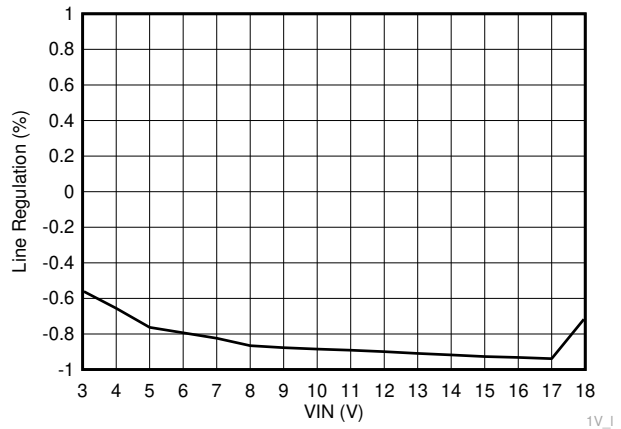

图 7-13. TPS566238 Output Voltage Ripple

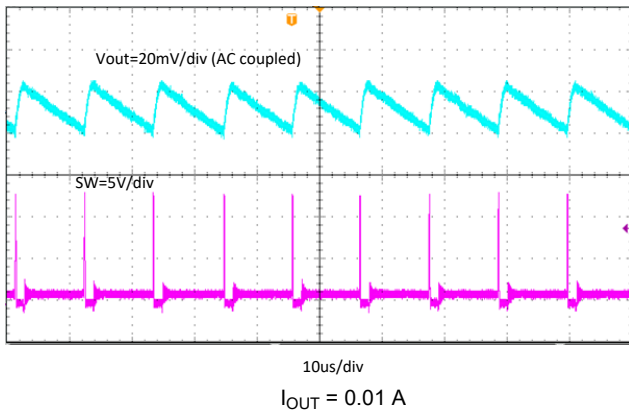

图 7-14. Output Voltage Ripple,  $I_{OUT} = 6 A$

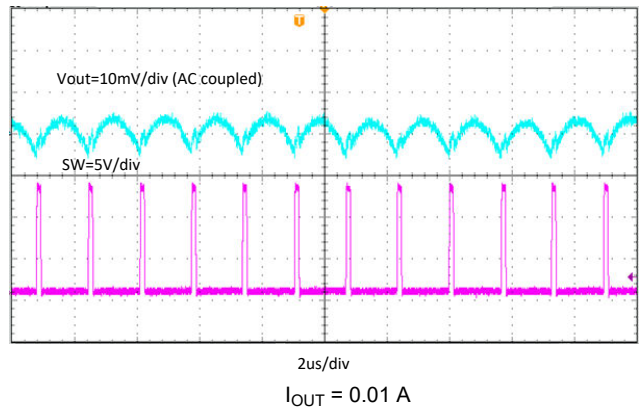

图 7-15. Start-Up Through EN,  $I_{OUT} = 3 A$

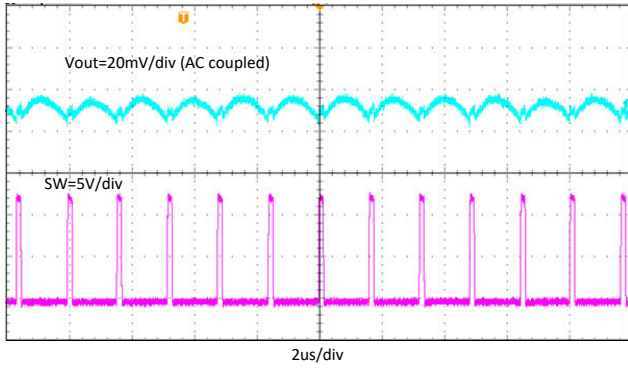

图 7-16. Shutdown Through EN,  $I_{OUT} = 3 A$

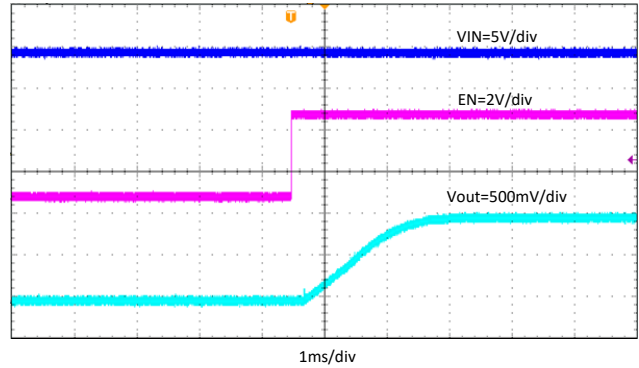

图 7-17. Start-Up with  $V_{IN}$  Rising,  $I_{OUT} = 3 A$

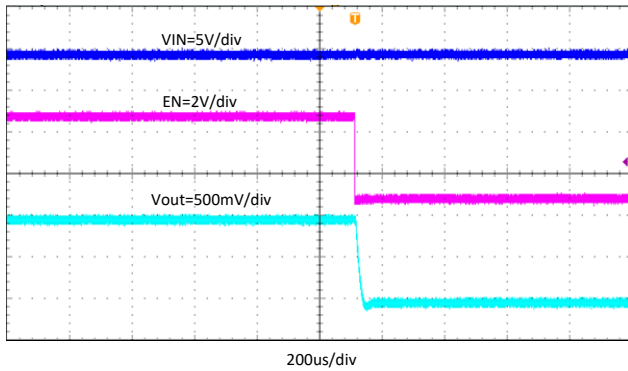

图 7-18. Start-Up with  $V_{IN}$  Falling,  $I_{OUT} = 3 A$

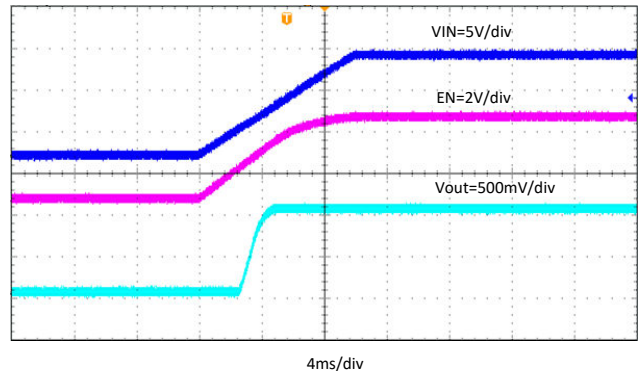

0.6 A to 5.4 A      Slew Rate = 2.5 A/μs  
图 7-19. TPS566231 Transient Response

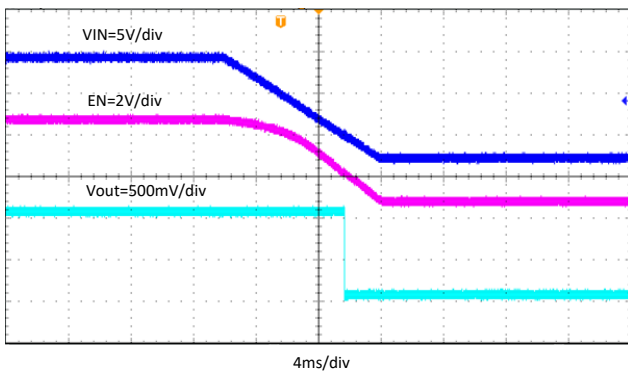
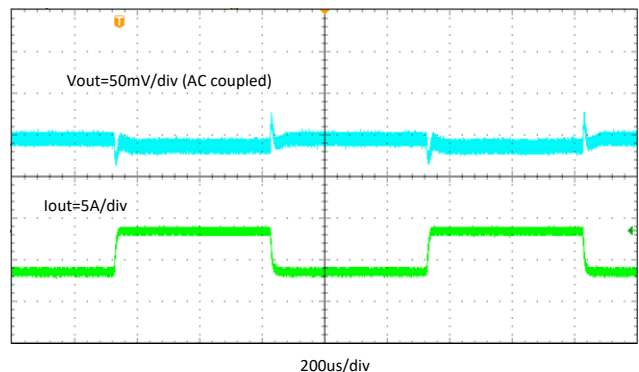

图 7-20. TPS566231 Transient Response



图 7-21. TPS566238 Transient Response

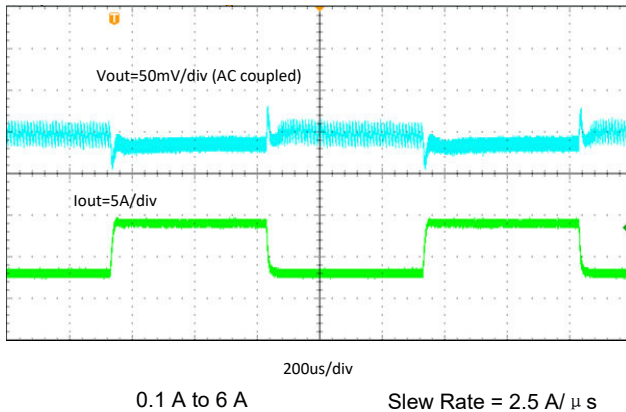

图 7-22. TPS566238 Transient Response

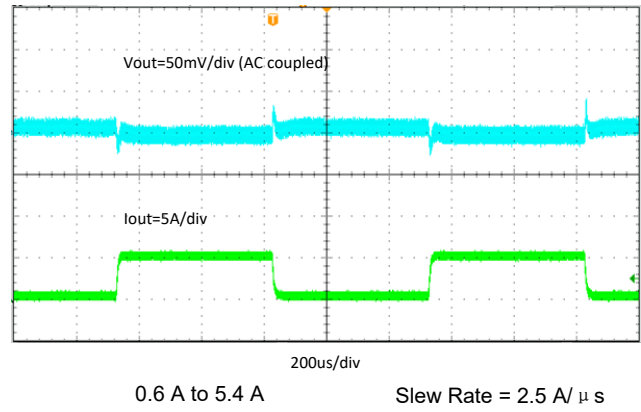

图 7-23. TPS566231 Normal Operation to Output Hard Short

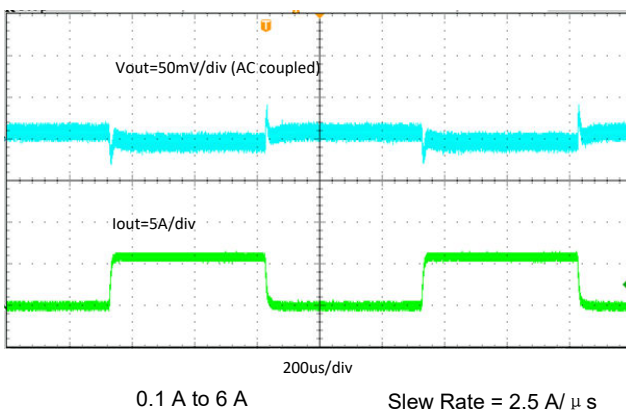

图 7-24. TPS566238 Normal Operation to Output Hard Short

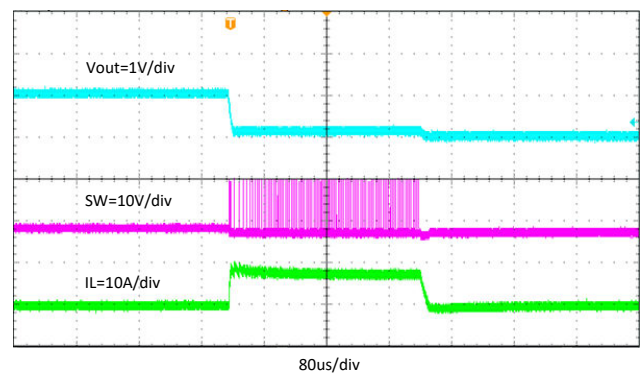

图 7-25. Output Hard Short Hiccup

### 7.3 Power Supply Recommendations

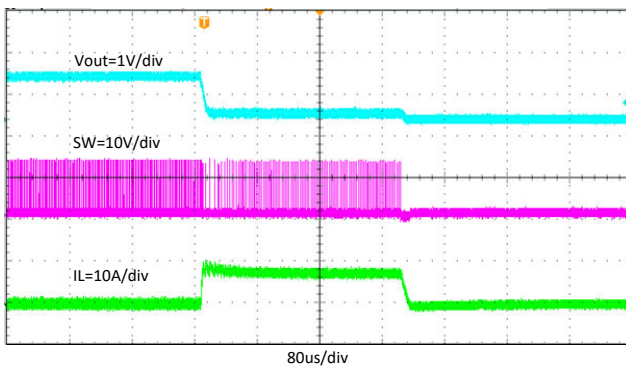
The TPS56623x is intended to be powered by a well-regulated dc voltage. The input voltage range is 3 V to 18 V. The input supply voltage must be greater than the desired output voltage for proper operation. Input supply current must be appropriate for the desired output current. TI recommends additional bulk capacitance if the input voltage supply is located far from the TPS56623x circuit. Typical values are 100 μF to 470 μF.

## 7.4 Layout

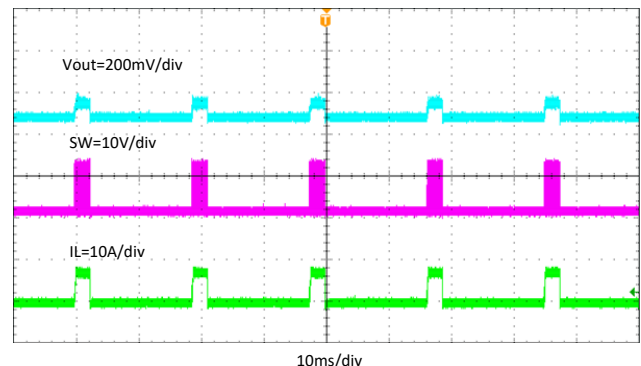
### 7.4.1 Layout Guidelines

- Use a four-layer PCB for good thermal performance and with maximum ground plane. 55-mm × 60-mm, four-layer PCB with 2-1-1-2 oz copper is used as example.
- Place the decoupling capacitors right across VIN and VCC as close as possible.
- Place an output inductor and capacitors with IC at the same layer. SW routing must be as short as possible to minimize EMI, and must be a width plane to carry big current. Enough vias must be added to the PGND connection of the output capacitor and as close to the output pin as possible.
- Place a BST resistor and capacitor with IC at the same layer, close to BST and SW plane. TI recommends a 15-mil width trace to reduce line parasitic inductance.
- Feedback must be routed away from the switching node, BST node, or other high frequency signal.
- The VIN trace must be wide to reduce the trace impedance and provide enough current capability.
- Place multiple vias under the device near VIN and PGND and near input capacitors to reduce parasitic inductance and improve thermal performance.

### 7.4.2 Layout Example

图 7-26 shows the recommended top-side layout. Component reference designators are the same as the circuit shown in 图 7-1. A resistor divider for EN is not used in the circuit of 图 7-1, but are shown in the layout for reference.



图 7-26. Top-Layer Layout

## 8 Device and Documentation Support

### 8.1 Device Support

#### 8.1.1 Development Support

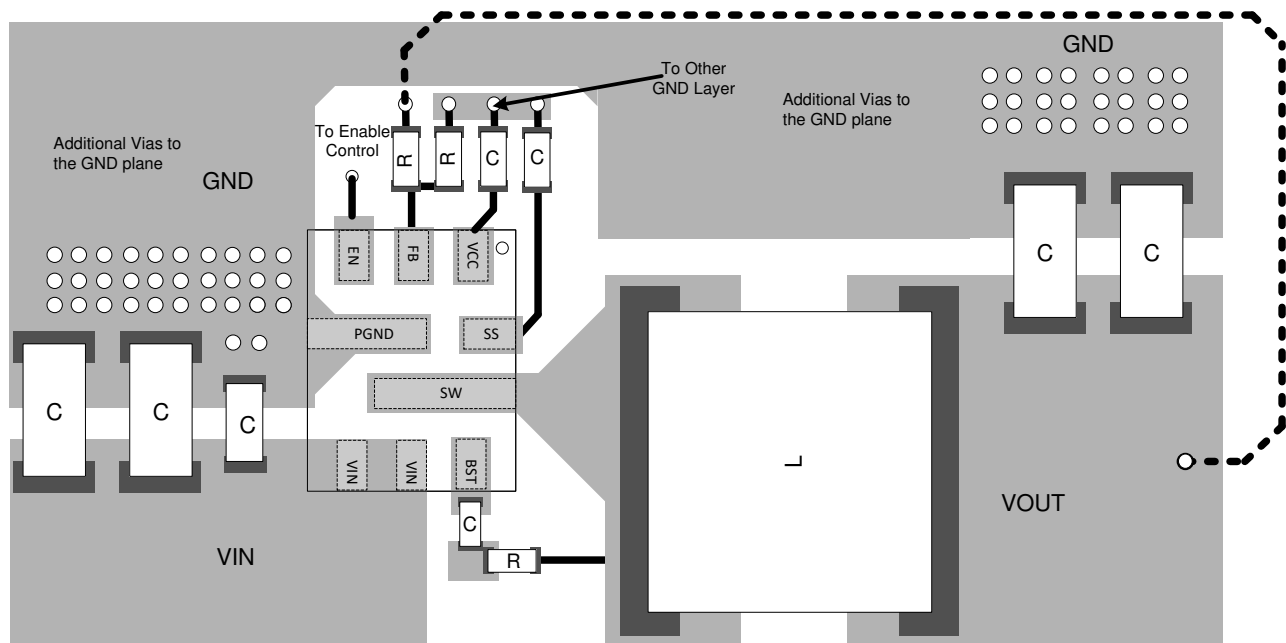
##### 8.1.1.1 Custom Design with WEBENCH® Tools

[Click here](#) to create a custom design using the TPS56623x device with the WEBENCH Power Designer.

1. Start by entering the input voltage ( $V_{IN}$ ), output voltage ( $V_{OUT}$ ), and output current ( $I_{OUT}$ ) requirements.
2. Optimize the design for key parameters such as efficiency, footprint, and cost.
3. Compare the generated design with other possible solutions from Texas Instruments.

The WEBENCH Power Designer provides a customized schematic along with a list of materials with real-time pricing and component availability.

In most cases, these actions are available:

- Estimate IC thermal and efficiency performance
- Run electrical simulations to see important waveforms and circuit performance
- Export customized schematic and layout into popular CAD formats
- Print PDF reports for the design, and share the design with colleagues

Get more information about WEBENCH tools at [www.ti.com/WEBENCH](http://www.ti.com/WEBENCH).

### 8.2 接收文档更新通知

要接收文档更新通知，请导航至 [ti.com](http://ti.com) 上的器件产品文件夹。点击 [通知](#) 进行注册，即可每周接收产品信息更改摘要。有关更改的详细信息，请查看任何已修订文档中包含的修订历史记录。

### 8.3 支持资源

[TI E2E™ 中文支持论坛](#) 是工程师的重要参考资料，可直接从专家处获得快速、经过验证的解答和设计帮助。搜索现有解答或提出自己的问题，获得所需的快速设计帮助。

链接的内容由各个贡献者“按原样”提供。这些内容并不构成 TI 技术规范，并且不一定反映 TI 的观点；请参阅 TI 的 [使用条款](#)。

### 8.4 Trademarks

D-CAP3™, HotRod™, ULQ™, and TI E2E™ are trademarks of Texas Instruments.

WEBENCH® is a registered trademark of Texas Instruments.

所有商标均为其各自所有者的财产。

### 8.5 静电放电警告



静电放电 (ESD) 会损坏这个集成电路。德州仪器 (TI) 建议通过适当的预防措施处理所有集成电路。如果不遵守正确的处理和安装程序，可能会损坏集成电路。

ESD 的损坏小至导致微小的性能降级，大至整个器件故障。精密的集成电路可能更容易受到损坏，这是因为非常细微的参数更改都可能会导致器件与其发布的规格不相符。

### 8.6 术语表

[TI 术语表](#) 本术语表列出并解释了术语、首字母缩略词和定义。



## 9 Revision History

注：以前版本的页码可能与当前版本的页码不同

<b>Changes from Revision A (January 2021) to Revision B (December 2023)</b>	<b>Page</b>
• 在 <i>特性</i> 部分为可用的普通话数据表添加了一个要点；更新了商标信息；删除了首页图像中的随机颜色.....	1
• Updated the <i>ESD Ratings</i> table to show CDM testing was per JS-002.....	4
• Added <i>Custom Design with WEBENCH® Tools</i> section.....	16
• Added text in <i>Output Capacitor Selection</i> to state that the Table 7-2 values are effective values based on DC-bias.....	17
• Added <i>Custom Design with WEBENCH® Tools</i> section.....	24
<b>Changes from Revision * (May 2020) to Revision A (January 2021)</b>	<b>Page</b>
• 将器件状态从“预告信息”更改为“量产数据” .....	1
• 更新了整个文档中的表、图和交叉参考的编号格式。 .....	1

## 10 Mechanical, Packaging, and Orderable Information

The following pages include mechanical, packaging, and orderable information. This information is the most current data available for the designated devices. This data is subject to change without notice and revision of this document. For browser-based versions of this data sheet, refer to the left-hand navigation.

**PACKAGING INFORMATION**

Orderable Device	Status (1)	Package Type	Package Drawing	Pins	Package Qty	Eco Plan (2)	Lead finish/ Ball material (6)	MSL Peak Temp (3)	Op Temp (°C)	Device Marking (4/5)	Samples
TPS566231PRQFR	ACTIVE	VQFN-HR	RQF	9	3000	RoHS & Green	Call TI   SN   NIPDAU	Level-2-260C-1 YEAR	-40 to 125	1ID	<a href="#">Samples</a>
TPS566231RQFR	ACTIVE	VQFN-HR	RQF	9	3000	RoHS & Green	Call TI   SN   NIPDAU	Level-2-260C-1 YEAR	-40 to 125	1H4	<a href="#">Samples</a>
TPS566238PRQFR	ACTIVE	VQFN-HR	RQF	9	3000	RoHS & Green	Call TI   SN   NIPDAU	Level-2-260C-1 YEAR	-40 to 125	1IE	<a href="#">Samples</a>
TPS566238RQFR	ACTIVE	VQFN-HR	RQF	9	3000	RoHS & Green	Call TI   SN   NIPDAU	Level-2-260C-1 YEAR	-40 to 125	1H5	<a href="#">Samples</a>

(1) The marketing status values are defined as follows:

**ACTIVE:** Product device recommended for new designs.

**LIFEBUY:** TI has announced that the device will be discontinued, and a lifetime-buy period is in effect.

**NRND:** Not recommended for new designs. Device is in production to support existing customers, but TI does not recommend using this part in a new design.

**PREVIEW:** Device has been announced but is not in production. Samples may or may not be available.

**OBSELETE:** TI has discontinued the production of the device.

(2) **RoHS:** TI defines "RoHS" to mean semiconductor products that are compliant with the current EU RoHS requirements for all 10 RoHS substances, including the requirement that RoHS substance do not exceed 0.1% by weight in homogeneous materials. Where designed to be soldered at high temperatures, "RoHS" products are suitable for use in specified lead-free processes. TI may reference these types of products as "Pb-Free".

**RoHS Exempt:** TI defines "RoHS Exempt" to mean products that contain lead but are compliant with EU RoHS pursuant to a specific EU RoHS exemption.

**Green:** TI defines "Green" to mean the content of Chlorine (Cl) and Bromine (Br) based flame retardants meet JS709B low halogen requirements of <=1000ppm threshold. Antimony trioxide based flame retardants must also meet the <=1000ppm threshold requirement.

(3) MSL, Peak Temp. - The Moisture Sensitivity Level rating according to the JEDEC industry standard classifications, and peak solder temperature.

(4) There may be additional marking, which relates to the logo, the lot trace code information, or the environmental category on the device.

(5) Multiple Device Markings will be inside parentheses. Only one Device Marking contained in parentheses and separated by a "-" will appear on a device. If a line is indented then it is a continuation of the previous line and the two combined represent the entire Device Marking for that device.

(6) Lead finish/Ball material - Orderable Devices may have multiple material finish options. Finish options are separated by a vertical ruled line. Lead finish/Ball material values may wrap to two lines if the finish value exceeds the maximum column width.

**Important Information and Disclaimer:**The information provided on this page represents TI's knowledge and belief as of the date that it is provided. TI bases its knowledge and belief on information provided by third parties, and makes no representation or warranty as to the accuracy of such information. Efforts are underway to better integrate information from third parties. TI has taken and

continues to take reasonable steps to provide representative and accurate information but may not have conducted destructive testing or chemical analysis on incoming materials and chemicals. TI and TI suppliers consider certain information to be proprietary, and thus CAS numbers and other limited information may not be available for release.

In no event shall TI's liability arising out of such information exceed the total purchase price of the TI part(s) at issue in this document sold by TI to Customer on an annual basis.

**TAPE AND REEL INFORMATION**

**QUADRANT ASSIGNMENTS FOR PIN 1 ORIENTATION IN TAPE**



\*All dimensions are nominal

Device	Package Type	Package Drawing	Pins	SPQ	Reel Diameter (mm)	Reel Width W1 (mm)	A0 (mm)	B0 (mm)	K0 (mm)	P1 (mm)	W (mm)	Pin1 Quadrant
TPS566231PRQFR	VQFN-HR	RQF	9	3000	180.0	8.4	1.75	2.25	1.0	4.0	8.0	Q2
TPS566231PRQFR	VQFN-HR	RQF	9	3000	180.0	8.4	1.8	2.25	1.15	4.0	8.0	Q2
TPS566231RQFR	VQFN-HR	RQF	9	3000	180.0	8.4	1.8	2.25	1.15	4.0	8.0	Q2
TPS566231RQFR	VQFN-HR	RQF	9	3000	180.0	8.4	1.75	2.25	1.0	4.0	8.0	Q2
TPS566238PRQFR	VQFN-HR	RQF	9	3000	180.0	8.4	1.75	2.25	1.0	4.0	8.0	Q2
TPS566238PRQFR	VQFN-HR	RQF	9	3000	180.0	8.4	1.8	2.25	1.15	4.0	8.0	Q2
TPS566238RQFR	VQFN-HR	RQF	9	3000	180.0	8.4	1.75	2.25	1.0	4.0	8.0	Q2
TPS566238RQFR	VQFN-HR	RQF	9	3000	180.0	8.4	1.8	2.25	1.15	4.0	8.0	Q2

**TAPE AND REEL BOX DIMENSIONS**

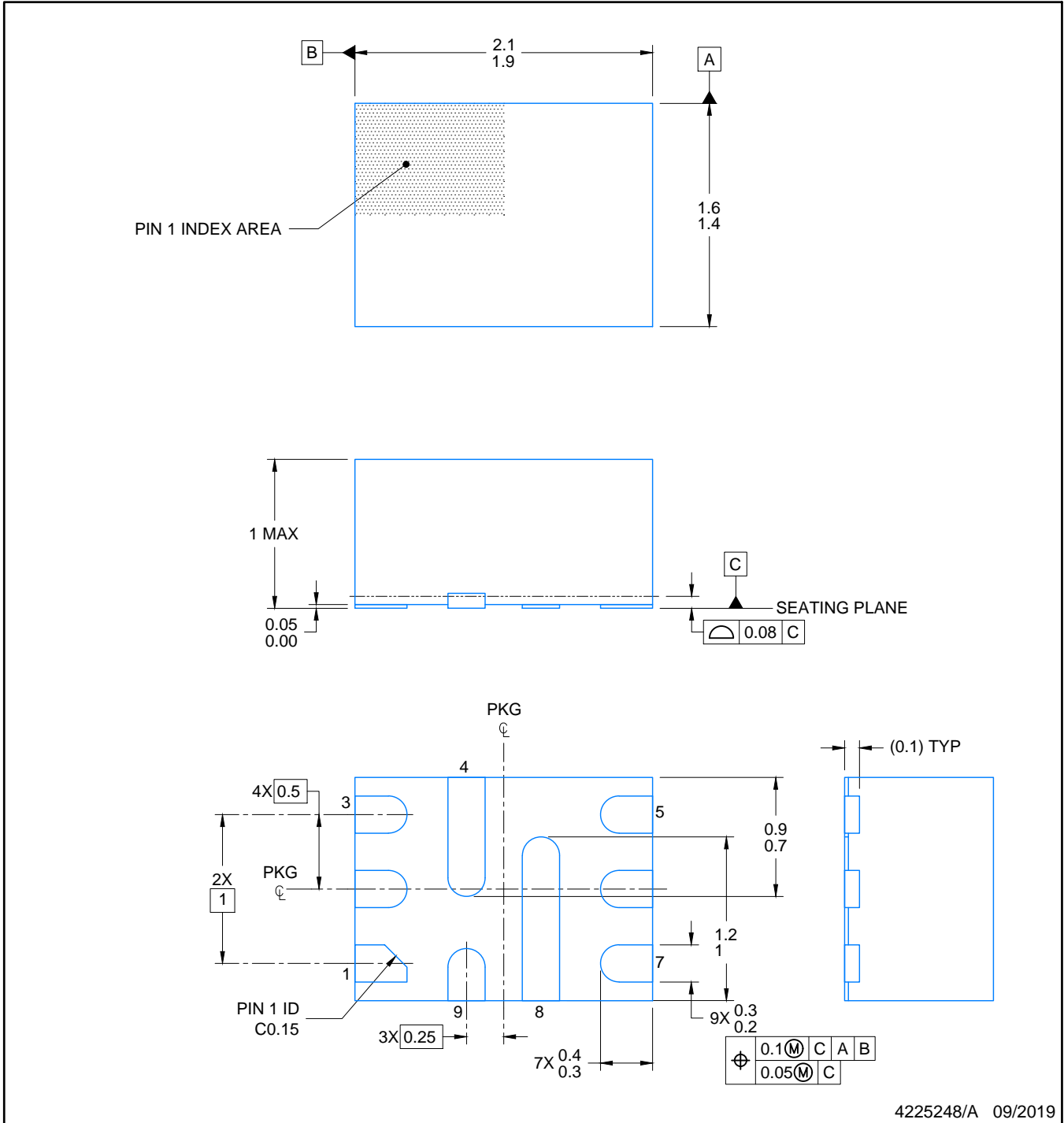

\*All dimensions are nominal

Device	Package Type	Package Drawing	Pins	SPQ	Length (mm)	Width (mm)	Height (mm)
TPS566231PRQFR	VQFN-HR	RQF	9	3000	210.0	185.0	35.0
TPS566231PRQFR	VQFN-HR	RQF	9	3000	210.0	185.0	35.0
TPS566231RQFR	VQFN-HR	RQF	9	3000	210.0	185.0	35.0
TPS566231RQFR	VQFN-HR	RQF	9	3000	210.0	185.0	35.0
TPS566238PRQFR	VQFN-HR	RQF	9	3000	210.0	185.0	35.0
TPS566238PRQFR	VQFN-HR	RQF	9	3000	210.0	185.0	35.0
TPS566238RQFR	VQFN-HR	RQF	9	3000	210.0	185.0	35.0
TPS566238RQFR	VQFN-HR	RQF	9	3000	210.0	185.0	35.0

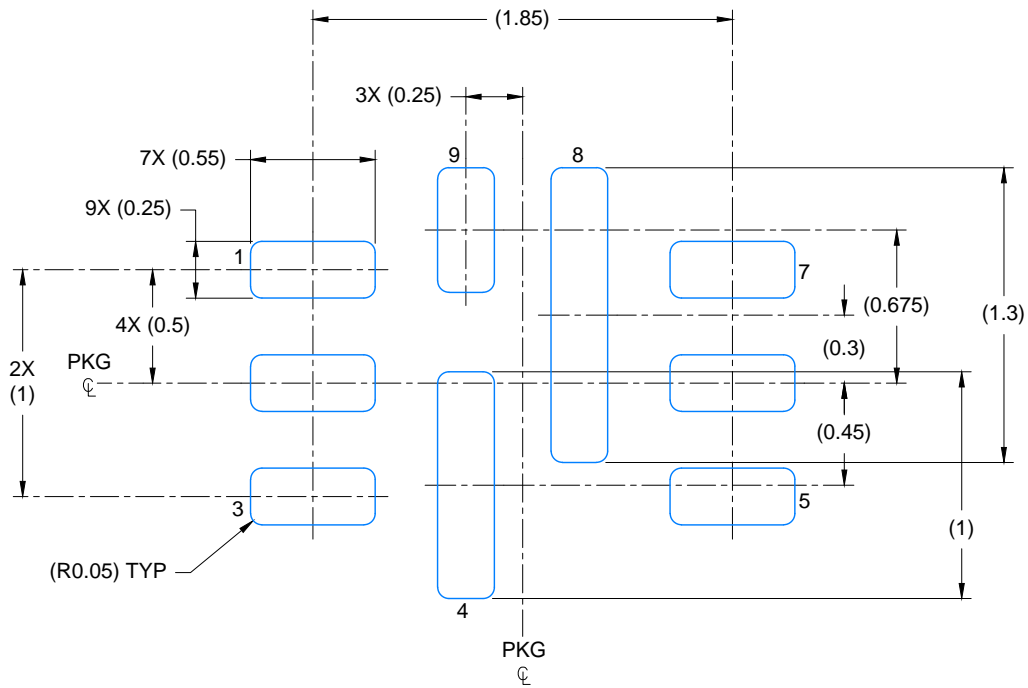

NOTES:

1. All linear dimensions are in millimeters. Any dimensions in parenthesis are for reference only. Dimensioning and tolerancing per ASME Y14.5M.
2. This drawing is subject to change without notice.



LAND PATTERN EXAMPLE  
EXPOSED METAL SHOWN  
SCALE: 30X

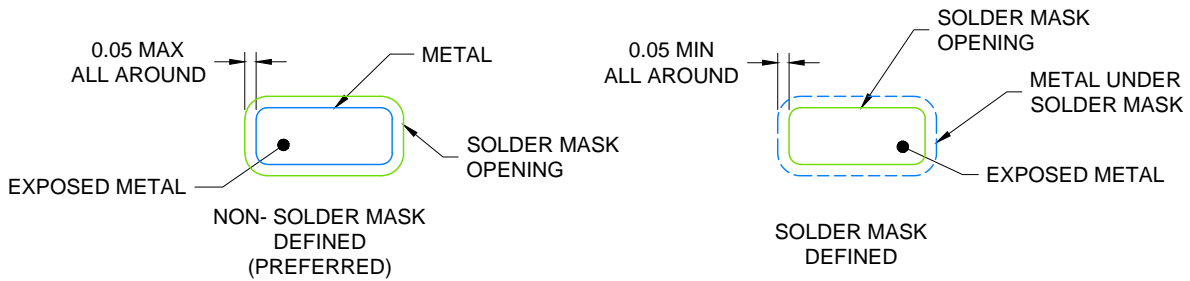

SOLDER MASK DETAILS  
NOT TO SCALE

4225248/A 09/2019

NOTES: (continued)

3. For more information, see Texas Instruments literature number SLUA271 ([www.ti.com/lit/slua271](http://www.ti.com/lit/slua271)).
4. Solder mask tolerances between and around signal pads can vary based on board fabrication site.



# EXAMPLE STENCIL DESIGN

RQF0009A

VQFN-HR - 1 mm max height

PLASTIC QUAD FLATPACK- NO LEAD

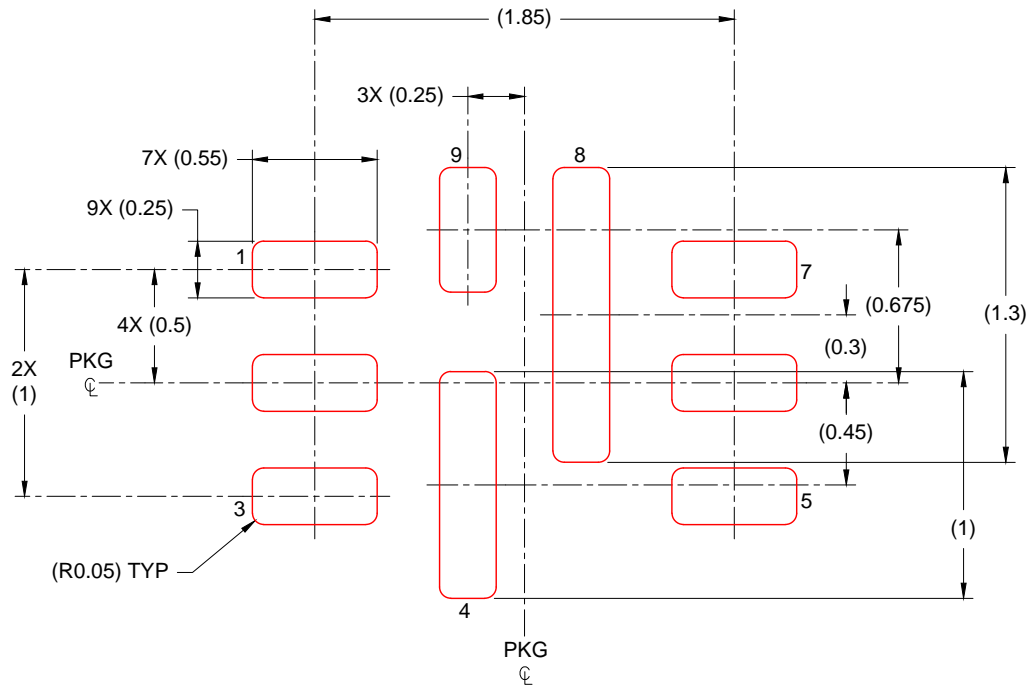

SOLDER PASTE EXAMPLE  
BASED ON 0.100 mm THICK STENCIL  
SCALE: 30X

4225248/A 09/2019

NOTES: (continued)

5. Laser cutting apertures with trapezoidal walls and rounded corners may offer better paste release. IPC-7525 may have alternate design recommendations.

## 重要通知和免责声明

TI“按原样”提供技术和可靠性数据（包括数据表）、设计资源（包括参考设计）、应用或其他设计建议、网络工具、安全信息和其他资源，不保证没有瑕疵且不做任何明示或暗示的担保，包括但不限于对适销性、某特定用途方面的适用性或不侵犯任何第三方知识产权的暗示担保。

这些资源可供使用 TI 产品进行设计的熟练开发人员使用。您将自行承担以下全部责任：(1) 针对您的应用选择合适的 TI 产品，(2) 设计、验证并测试您的应用，(3) 确保您的应用满足相应标准以及任何其他功能安全、信息安全、监管或其他要求。

这些资源如有变更，恕不另行通知。TI 授权您仅可将这些资源用于研发本资源所述的 TI 产品的相关应用。严禁以其他方式对这些资源进行复制或展示。您无权使用任何其他 TI 知识产权或任何第三方知识产权。您应全额赔偿因在这些资源的使用中对 TI 及其代表造成的任何索赔、损害、成本、损失和债务，TI 对此概不负责。

TI 提供的产品受 [TI 的销售条款](#) 或 [ti.com](#) 上其他适用条款/TI 产品随附的其他适用条款的约束。TI 提供这些资源并不会扩展或以其他方式更改 TI 针对 TI 产品发布的适用的担保或担保免责声明。

TI 反对并拒绝您可能提出的任何其他或不同的条款。

邮寄地址：Texas Instruments, Post Office Box 655303, Dallas, Texas 75265  
版权所有 © 2025，德州仪器 (TI) 公司