

## 具有超低静态电流的 TPS62743 TPS627431 300/400mA 高效降压转换器

### 1 特性

- 输入电压范围  $V_{IN}$  : 2.15V 至 5.5V
- 启动后的输入电压低至 2.0V
- 输出电流
  - TPS62743 300mA
  - TPS627431 400mA
- 360nA 工作静态电流
- 10 $\mu$ A 输出电流时的效率高达 90%
- 节能模式操作
- 可选输出电压
  - 8 个电压选项 ( 1.2V 至 3.3V )
- 输出电压放电
- 低输出电压纹波
- 自动转换至无纹波 100% 模式
- 射频友好型 DCS-Control™
- 总体解决方案尺寸小于 10mm<sup>2</sup>
- 小型 1.6mm × 0.9mm 8 焊球 WCSP 封装

### 2 应用

- 可穿戴设备
- 健身追踪器
- 智能手表
- 健康状况监控
- 低功耗蓝牙®、RF4CE、Zigbee
- 高效率、超低功耗应用
- 能量收集

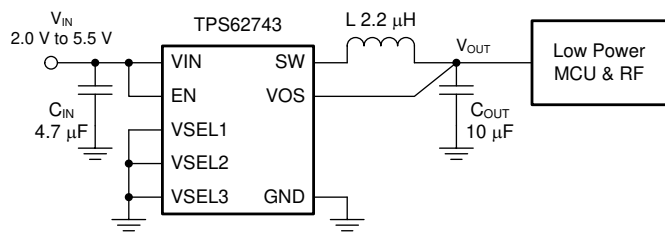

典型应用

### 3 说明

TPS62743 是一款高效降压转换器，具有典型值为 360nA 的超低静态电流。该器件经优化可搭配 2.2 $\mu$ H 电感和 10 $\mu$ F 输出电容正常工作。该器件采用 DCS-Control™ 技术，开关频率典型值为 1.2MHz。在节能模式下，该器件可将轻负载效率向下扩展至 10 $\mu$ A 负载电流及以下。TPS62743 提供 300mA 的输出电流。启动后，该器件可在低至 2.0V 的输入电压下工作。因此，可直接由单节 Li-MnO<sub>2</sub> 纽扣电池为器件供电。

TPS62743 提供了 8 个可编程的输出电压，可通过三个选择引脚在 1.2V 至 3.3V 范围内进行选择。The TPS62743 经过优化，只需使用一个小型输出电容即可获得低输出电压纹波和低噪声。一旦输入电压接近输出电压，器件便会进入无纹波 100% 模式，以防止输出纹波电压增大。在此工作模式下，器件会停止开关操作并导通高侧 MOSFET。

器件信息(1)

器件型号	封装	封装尺寸 (标称值)
TPS62743	DSBGA (8)	1.57mm x 0.88mm
TPS627431	DSBGA (8)	1.57mm x 0.88mm

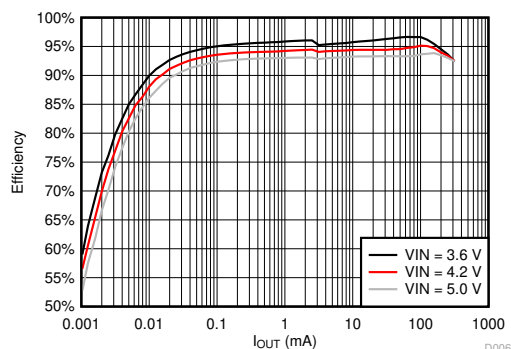

## Table of Contents

<b>1 特性</b> .....	1	8.4 Device Functional Modes.....	10
<b>2 应用</b> .....	1	<b>9 Application and Implementation</b> .....	11
<b>3 说明</b> .....	1	9.1 Application Information.....	11
<b>4 Revision History</b> .....	2	9.2 Typical Application.....	11
<b>5 Device Comparison Table</b> .....	3	9.3 System Example.....	17
<b>6 Pin Configuration and Functions</b> .....	3	<b>10 Power Supply Recommendations</b> .....	18
<b>7 Specifications</b> .....	4	<b>11 Layout</b> .....	19
7.1 Absolute Maximum Ratings.....	4	11.1 Layout Guidelines.....	19
7.2 ESD Ratings.....	4	11.2 Layout Example.....	19
7.3 Recommended Operating Conditions.....	4	<b>12 Device and Documentation Support</b> .....	20
7.4 Thermal Information.....	5	12.1 Device Support.....	20
7.5 Electrical Characteristics.....	5	12.2 接收文档更新通知.....	20
7.6 Timing Requirements.....	6	12.3 支持资源.....	20
7.7 Typical Characteristics.....	7	12.4 Trademarks.....	20
<b>8 Detailed Description</b> .....	8	12.5 静电放电警告.....	20
8.1 Overview.....	8	12.6 术语表.....	20
8.2 Functional Block Diagram.....	8	<b>13 Mechanical, Packaging, and Orderable Information</b> .....	20
8.3 Feature Description.....	8		

## 4 Revision History

注：以前版本的页码可能与当前版本的页码不同

<b>Changes from Revision A (May 2016) to Revision B (March 2021)</b>	<b>Page</b>
• 更新了整个文档的表、图和交叉参考的编号格式。.....	1

---

<b>Changes from Revision * (June 2015) to Revision A (May 2016)</b>	<b>Page</b>
• 向数据表添加了 TPS627431 器件.....	1
• 添加了器件选项 TPS627431 : 400mA 输出电流，不同于 TPS62743 的其他输出电压.....	1
• Added TPS627431 to 节 5 .....	3
• Added 图 9-2 .....	11

## 5 Device Comparison Table

T <sub>A</sub>	PART NUMBER	OUTPUT VOLTAGE SETTINGS (VSEL 1 - 3)	OUTPUT CURRENT	PACKAGE MARKING
- 40°C to 85°C	TPS62743	1.2 V, 1.5 V, 1.8 V, 2.1 V, 2.5 V, 2.8 V, 3.0 V, 3.3 V	300 mA	TPS743
- 40°C to 85°C	TPS627431	1.3 V, 1.4 V, 1.6 V, 1.7 V, 1.9 V, 2.0 V, 2.9 V, 3.1 V	400 mA	627431

## 6 Pin Configuration and Functions



图 6-1. YFP Package 8-Pin DSBGA Top View

表 6-1. Pin Functions

PIN		I/O	DESCRIPTION
NAME	NO		
VIN	A2	PWR	V <sub>IN</sub> power supply pin. Connect the input capacitor close to this pin for best noise and voltage spike suppression. A ceramic capacitor of 4.7 μF is required.
SW	A1	OUT	The switch pin is connected to the internal MOSFET switches. Connect the inductor to this terminal.
GND	B2	PWR	GND supply pin. Connect this pin close to the GND terminal of the input and output capacitor.
VOS	C2	IN	Feedback pin for the internal feedback divider network and regulation loop. Discharges V <sub>OUT</sub> when the converter is disabled. Connect this pin directly to the output capacitor with a short trace.
VSEL3	D2	IN	Output voltage selection pins. See 表 6-2 for V <sub>OUT</sub> selection. These pin must be terminated. The pins can be dynamically changed during operation.
VSEL2	D1	IN	
VSEL1	C1	IN	
EN	B1	IN	High level enables the devices, low level turns the device off. The pin must be terminated.

表 6-2. Output Voltage Setting

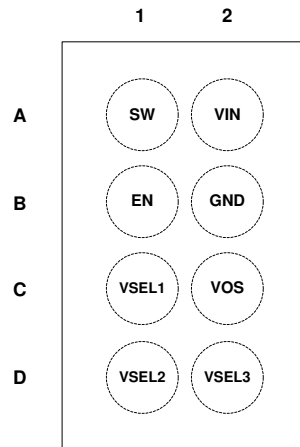
OUTPUT VOLTAGE SETTING V <sub>OUT</sub> [V]		VSEL SETTING		
TPS62743	TPS627431	VSEL3	VSEL2	VSEL1
1.2	1.3	0	0	0
1.5	1.4	0	0	1
1.8	1.6	0	1	0
2.1	1.7	0	1	1
2.5	1.9	1	0	0
2.8	2.0	1	0	1
3.0	2.9	1	1	0
3.3	3.1	1	1	1

## 7 Specifications

### 7.1 Absolute Maximum Ratings

over operating free-air temperature range (unless otherwise noted) <sup>(1)</sup>

		MIN	MAX	UNIT
Pin voltage <sup>(2)</sup>	V <sub>IN</sub>	-0.3	6	V
	SW,	-0.3	V <sub>IN</sub> + 0.3V	V
	EN, VSEL1-3	-0.3	V <sub>IN</sub> + 0.3V	V
	VOS	-0.3	3.7	V
Operating junction temperature, T <sub>J</sub>		-40	125	°C
Storage temperature, T <sub>stg</sub>		-65	150	°C

- (1) Stresses beyond those listed under *absolute maximum ratings* may cause permanent damage to the device. These are stress ratings only and functional operation of the device at these or any other conditions beyond those indicated under *recommended operating conditions* is not implied. Exposure to absolute - maximum - rated conditions for extended periods may affect device reliability.
- (2) All voltage values are with respect to network ground terminal GND.

### 7.2 ESD Ratings

			VALUE	UNIT
V <sub>(ESD)</sub>	Electrostatic discharge	Human body model (HBM), per ANSI/ESDA/JEDEC JS-001, all pins <sup>(1)</sup>	±2000	V
		Charged device model (CDM), per JEDEC specification JESD22-C101, all pins <sup>(2)</sup>	±500	

- (1) JEDEC document JEP155 states that 500-V HBM allows safe manufacturing with a standard ESD control process. The human body model is a 100-pF capacitor discharged through a 1.5-kΩ resistor into each pin.
- (2) JEDEC document JEP157 states that 250-V CDM allows safe manufacturing with a standard ESD control process.

### 7.3 Recommended Operating Conditions

		MIN	NOM	MAX	UNIT
V <sub>IN</sub>	Supply voltage V <sub>IN</sub>	2.15		5.5	V
V <sub>IN</sub>	Supply voltage V <sub>IN</sub> , once started	2.0		5.5	V
I <sub>OUT</sub>	Device output current	TPS62743 / TPS627431 5.5V ≥ V <sub>IN</sub> ≥ (V <sub>OUTnom</sub> + 0.7V) ≥ 2.15V		300	mA
		5.5V ≥ V <sub>IN</sub> ≥ (V <sub>OUTnom</sub> + 0.7V) ≥ 3V		400	
T <sub>J</sub>	Operating junction temperature range	-40		125	°C

## 7.4 Thermal Information

THERMAL METRIC <sup>(1)</sup>		TPS62743	
		YFP	
		8 PINS	
			UNIT
$R_{\theta JA}$	Junction-to-ambient thermal resistance	103	°C/W
$R_{\theta Jctop}$	Junction-to-case (top) thermal resistance	1.0	°C/W
$R_{\theta JB}$	Junction-to-board thermal resistance	20	°C/W
$\psi_{JT}$	Junction-to-top characterization parameter	0.3	°C/W
$\psi_{JB}$	Junction-to-board characterization parameter	20	°C/W
$R_{\theta Jcbot}$	Junction-to-case (bottom) thermal resistance	N/A	°C/W

(1) For more information about traditional and new thermal metrics, see the *Semiconductor and IC Package Thermal Metrics* application report, [SPRA953](#).

## 7.5 Electrical Characteristics

$V_{IN} = 3.6V$ ,  $T_A = -40^{\circ}C$  to  $85^{\circ}C$  typical values are at  $T_A = 25^{\circ}C$  (unless otherwise noted)

PARAMETER		TEST CONDITIONS	MIN	TYP	MAX	UNIT
<b>SUPPLY</b>						
$I_Q$	Operating quiescent current	EN = $V_{IN}$ , $I_{OUT} = 0\mu A$ , $V_{OUT} = 1.8V$ , device not switching		360	1800	nA
		EN = $V_{IN}$ , $I_{OUT} = 0mA$ , $V_{OUT} = 1.8V$ , device switching		460		
$I_{SD}$	Shutdown current	EN = GND, shutdown current into $V_{IN}$		70	1000	nA
$V_{TH\_UVLO+}$	Undervoltage lockout threshold	Rising $V_{IN}$		2.075	2.15	V
$V_{TH\_UVLO-}$		Falling $V_{IN}$		1.925	2	
<b>INPUTS (EN, VSEL1-3)</b>						
$V_{IH\ TH}$	High level input threshold	$2.2V \leq V_{IN} \leq 5.5V$			1.1	V
$V_{IL\ TH}$	Low level input threshold	$2.2V \leq V_{IN} \leq 5.5V$	0.4			V
$I_{IN}$	Input bias Current			10	25	nA
<b>POWER SWITCHES</b>						
$R_{DS(ON)}$	High side MOSFET on-resistance	$I_{OUT} = 50mA$		0.45	1.12	$\Omega$
	Low Side MOSFET on-resistance			0.22	0.65	
$I_{LIMF}$	High side MOSFET switch current limit	TPS62743 $3.0V \leq V_{IN} \leq 5.5V$	480	600	720	mA
		TPS627431 $3.0V \leq V_{IN} \leq 5.5V$	590	650	800	
	Low side MOSFET switch current limit	TPS62743		600		
		TPS627431		650		
<b>OUTPUT VOLTAGE DISCHARGE</b>						
$R_{DSCH\_VOS}$	MOSFET on-resistance	EN = GND, $I_{VOS} = -10mA$ into VOS pin		30	65	$\Omega$
$I_{IN\_VOS}$	Bias current into VOS pin	EN = $V_{IN}$ , $V_{OUT} = 2V$		40	1010	nA

$V_{IN} = 3.6V$ ,  $T_A = -40^{\circ}C$  to  $85^{\circ}C$  typical values are at  $T_A = 25^{\circ}C$  (unless otherwise noted)

PARAMETER		TEST CONDITIONS	MIN	TYP	MAX	UNIT
<b>AUTO 100% MODE TRANSITION</b>						
$V_{TH\_100+}$	Auto 100% Mode leave detection threshold (1)	Rising $V_{IN}$ , 100% Mode is left with $V_{IN} = V_{OUT} + V_{TH\_100+}$	150	250	350	mV
$V_{TH\_100-}$	Auto 100% Mode enter detection threshold (1)	Falling $V_{IN}$ , 100% Mode is entered with $V_{IN} = V_{OUT} + V_{TH\_100-}$	85	200	290	
<b>OUTPUT</b>						
$I_{LIM\_softstart}$	High side softstart switch current limit	EN=low to high	80	150	200	mA
	Low side softstart switch current limit		150			
$V_{OUT}$	Output voltage range	Output voltages are selected with pins VSEL 1 - 3	1.2		3.3	V
	Output voltage accuracy	$I_{OUT} = 10mA$ , $V_{OUT} = 1.8V$	-2.5	0%	2.5	
		$I_{OUT} = 100mA$ , $V_{OUT} = 1.8V$	-2	0%	2	
	DC output voltage load regulation	$V_{OUT} = 1.8V$		0.001		%/mA
	DC output voltage line regulation	$V_{OUT} = 1.8V$ , $I_{OUT} = 100mA$ , $2.2V \leq V_{IN} \leq 5.0V$		0		%/V

(1)  $V_{IN}$  is compared to the programmed output voltage ( $V_{OUT}$ ). When  $V_{IN} - V_{OUT}$  falls below  $V_{TH\_100-}$  the device enters 100% Mode by turning the high side MOSFET on. The 100% Mode is exited when  $V_{IN} - V_{OUT}$  exceeds  $V_{TH\_100+}$  and the device starts switching. The hysteresis for the 100% Mode detection threshold  $V_{TH\_100+} - V_{TH\_100-}$  will always be positive and will be approximately 50 mV(typ)

## 7.6 Timing Requirements

$V_{IN} = 3.6V$ ,  $T_J = -40^{\circ}C$  to  $85^{\circ}C$  typical values are at  $T_A = 25^{\circ}C$  (unless otherwise noted)

PARAMETER		TEST CONDITIONS	MIN	TYP	MAX	UNIT
<b>OUTPUT</b>						
$t_{ONmin}$	Minimum ON time	$V_{OUT} = 2.0V$ , $I_{OUT} = 0 mA$		225		ns
$t_{OFFmin}$	Minimum OFF time	$V_{IN} = 2.3V$		50		ns
$t_{Startup\_delay}$	Regulator start up delay time	From transition EN = low to high until device starts switching		10	25	ms
$t_{Softstart}$	Softstart time	$2.2V \leq V_{IN} \leq 5.5V$ , EN = $V_{IN}$		700	1200	$\mu s$

## 7.7 Typical Characteristics

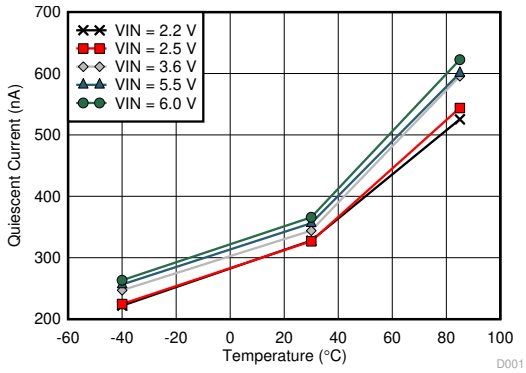

EN = VIN, V<sub>OUT</sub> = 1.8V Device Not Switching

图 7-1. Quiescent Current vs Temperature

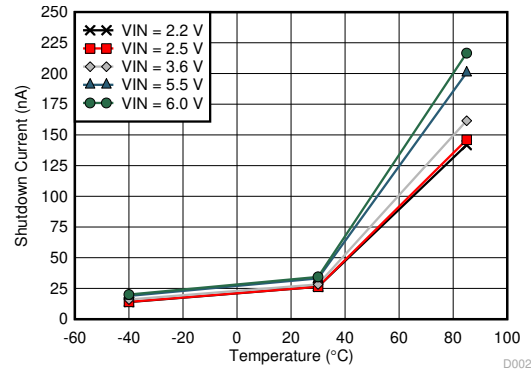

EN = GND

图 7-2. Shutdown Current I<sub>SD</sub> vs Temperature



图 7-3. High Side R<sub>DSON</sub> vs Temperature



图 7-4. Low-side R<sub>DSON</sub> vs Temperature

## 8 Detailed Description

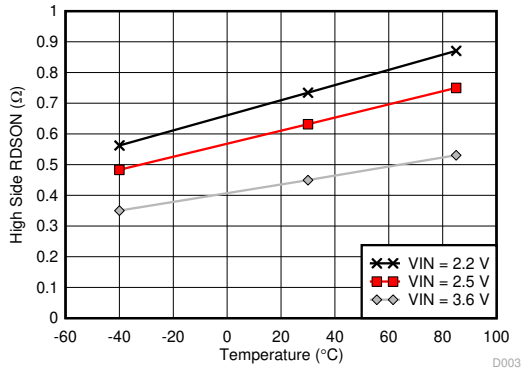
### 8.1 Overview

The TPS62743 is a high frequency step down converter with ultra low quiescent current. The device operates with a quasi fixed switching frequency typically at 1.2 MHz. Using TI's DCS-Control™ topology the device extends the high efficiency operation area down to a few microamperes of load current during Power Save Mode Operation.

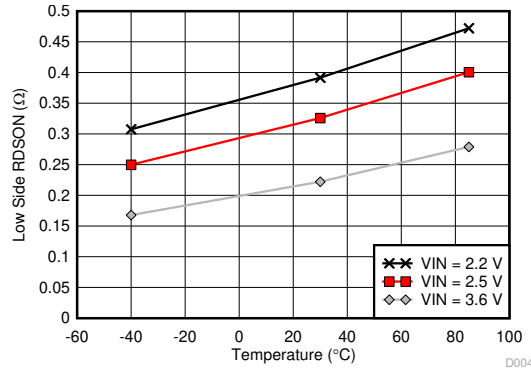
### 8.2 Functional Block Diagram

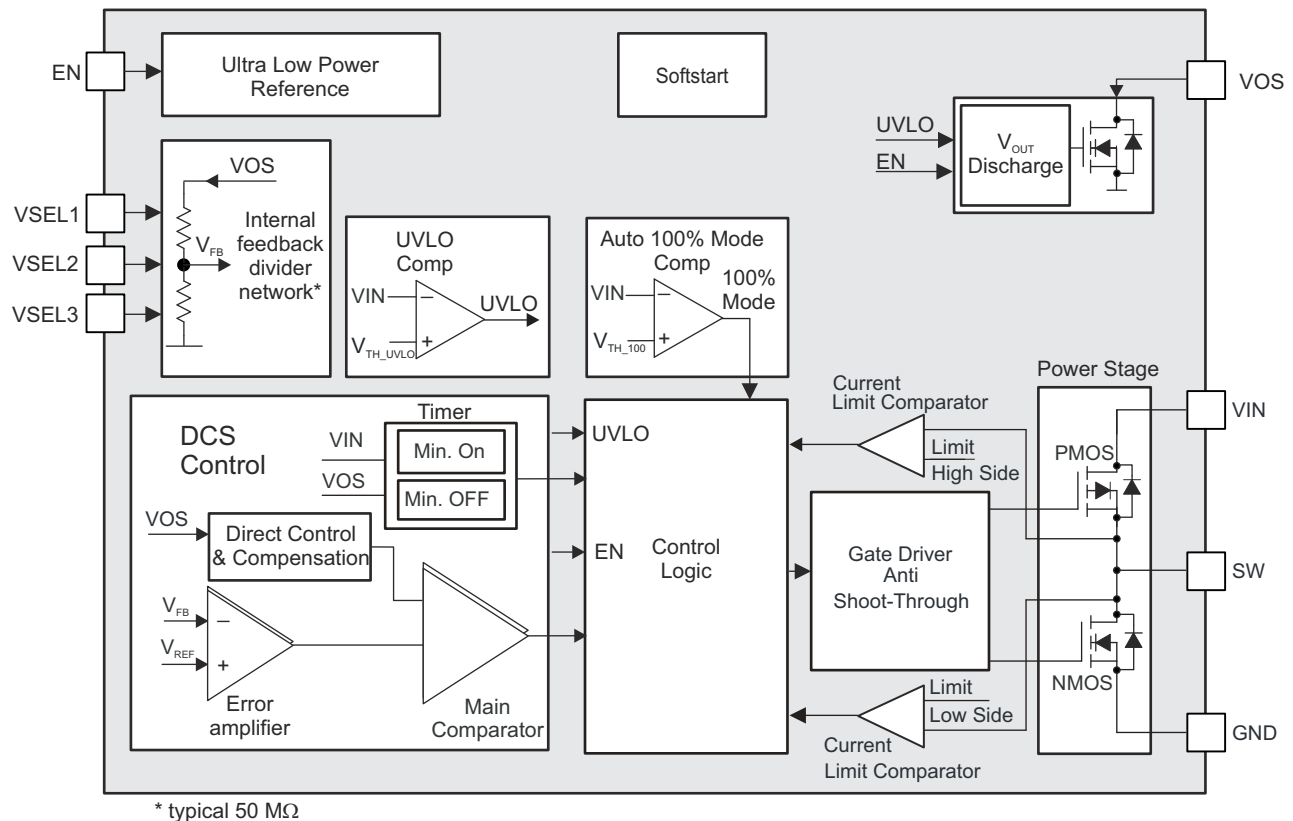

### 8.3 Feature Description

#### 8.3.1 DCS-Control™

TI's DCS-Control™ (Direct Control with Seamless Transition™ into Power Save Mode) is an advanced regulation topology, which combines the advantages of hysteretic and voltage mode control. Characteristics of DCS-Control™ are excellent AC load regulation and transient response, low output ripple voltage and a seamless transition between PFM and PWM mode operation. DCS-Control™ includes an AC loop which senses the output voltage (VOS pin) and directly feeds the information to a fast comparator stage. This comparator sets the switching frequency, which is constant for steady state operating conditions, and provides immediate response to dynamic load changes. In order to achieve accurate DC load regulation, a voltage feedback loop is used. The internally compensated regulation network achieves fast and stable operation with small external components and low ESR capacitors.

The DCS-Control™ topology supports PWM (Pulse Width Modulation) mode for medium and high load conditions and a Power Save Mode at light loads. During PWM mode, it operates in continuous conduction mode. The switching frequency is typically 1.2 MHz with a controlled frequency variation depending on the input voltage and load current. If the load current decreases, the converter seamlessly enters Power Save Mode to maintain high efficiency down to very light loads. In Power Save Mode, the switching frequency varies linearly with the load current. Since DCS-Control™ supports both operation modes within one single building block, the transition from PWM to Power Save Mode is seamless with minimum output voltage ripple. The TPS62743 offers



both excellent DC voltage and superior load transient regulation, combined with low output voltage ripple, minimizing interference with RF circuits.

### 8.3.2 Power Save Mode Operation

In Power Save Mode the device operates in PFM (Pulse Frequency Modulation) that generates a single switching pulse to ramp up the inductor current and recharges the output capacitor, followed by a sleep period where most of the internal circuits are shutdown to achieve lowest operating quiescent current. During this time, the load current is supported by the output capacitor. The duration of the sleep period depends on the load current and the inductor peak current. During the sleep periods, the current consumption of TPS62743 is reduced to 360 nA. This low quiescent current consumption is achieved by an ultra low power voltage reference, an integrated high impedance feedback divider network and an optimized Power Save Mode operation.

### 8.3.3 Output Voltage Selection

The TPS62743 doesn't require an external resistor divider network to program the output voltage. The device integrates a high impedance feedback resistor divider network that is programmed by the pins VSEL1-3. TPS62743 supports an output voltage range from 1.2 V to 3.3 V. The output voltage is programmed according to [表 6-2](#). The output voltage can be changed during operation. This can be used for simple dynamic output voltage scaling.

### 8.3.4 Output Voltage Discharge of the Buck Converter

The device provides automatic output voltage discharge when EN is pulled low or the UVLO is triggered. The output of the buck converter is discharged over VOS. Because of this the output voltage will ramp up from zero once the device is enabled again. This is very helpful for accurate start-up sequencing.

### 8.3.5 Undervoltage Lockout UVLO

To avoid misoperation of the device at low input voltages, an undervoltage lockout is used. The UVLO shuts down the device at a maximum voltage level of 2.0 V. The device will start at a UVLO level of 2.15 V.

### 8.3.6 Short circuit protection

The TPS6274x integrates a current limit on the high side, as well on the low side MOSFETs to protect the device against overload or short circuit conditions. The peak current in the switches is monitored cycle by cycle. If the high side MOSFET current limit is reached, the high side MOSFET is turned off and the low side MOSFET is turned on until the switch current decreases below the low side MOSFET current limit. Once the low side MOSFET current limit trips, the low side MOSFET is turned off and the high side MOSFET turns on again.

## 8.4 Device Functional Modes

### 8.4.1 Enable and Shutdown

The device is turned on with EN=high. With EN=low the device enters shutdown. This pin must be terminated.

### 8.4.2 Device Start-up and Softstart

The device has an internal softstart to minimize input voltage drop during start-up. This allows the operation from high impedance battery cells. Once the device is enabled the device starts switching after a typical delay time of 10ms. Then the softstart time of typical 700  $\mu$ s begins with a reduced current limit of typical 150 mA. When this time passed by the device enters full current limit operation. This allows a smooth start-up and the device can start into full load current. Furthermore, larger output capacitors impact the start-up behaviour of the DC/DC converter. Especially when the output voltage does not reach its nominal value after the typical soft-start time of 700  $\mu$ s, has passed.

### 8.4.3 Automatic Transition Into No Ripple 100% Mode

Once the input voltage comes close to the output voltage, the DC/DC converter stops switching and enters 100% duty cycle operation. It connects the output  $V_{OUT}$  via the inductor and the internal high side MOSFET switch to the input  $V_{IN}$ , once the input voltage  $V_{IN}$  falls below the 100% mode enter threshold,  $V_{TH\_100-}$ . The DC/DC regulator is turned off, switching stops and therefore no output voltage ripple is generated. Since the output is connected to the input, the output voltage follows the input voltage minus the voltage drop across the internal high side switch and the inductor. Once the input voltage increases and trips the 100% mode exit threshold,  $V_{TH\_100+}$ , the DC/DC regulator turns on and starts switching again. See [图 8-1](#) and [100% Mode Entry and Leave Operation](#)  $I_{OUT} = 30$  mA.



图 8-1. Automatic Transition into 100% Mode

## 9 Application and Implementation

### Note

Information in the following applications sections is not part of the TI component specification, and TI does not warrant its accuracy or completeness. TI's customers are responsible for determining suitability of components for their purposes, as well as validating and testing their design implementation to confirm system functionality.

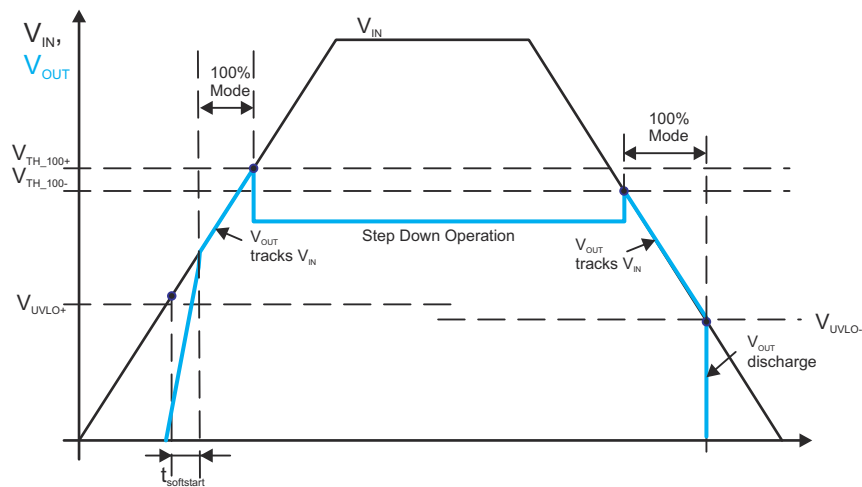
### 9.1 Application Information

The TPS62743 is a high efficiency step down converter with ultra low quiescent current of typically 360 nA. The device operates with a tiny 2.2- $\mu$ H inductor and 10- $\mu$ F output capacitor over the entire recommended operation range. A dedicated measurement set-up is required for the light load efficiency measurement and device quiescent current due to the operation in the sub microampere range. In this range any leakage current in the measurement set-up will impact the measurement results.

### 9.2 Typical Application

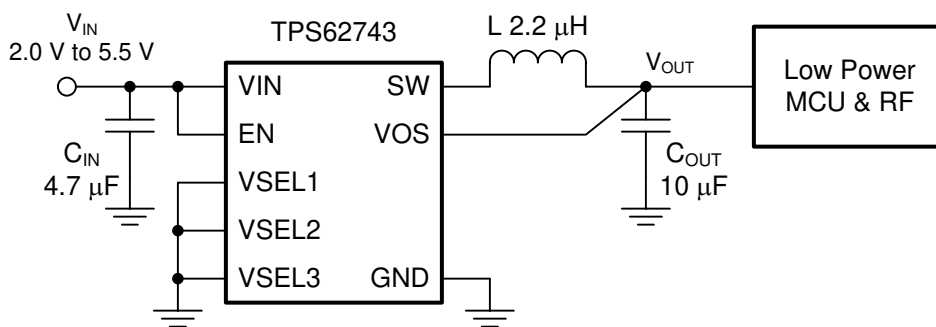

Copyright © 2016, Texas Instruments Incorporated

图 9-1. TPS62743 Typical Application Circuit

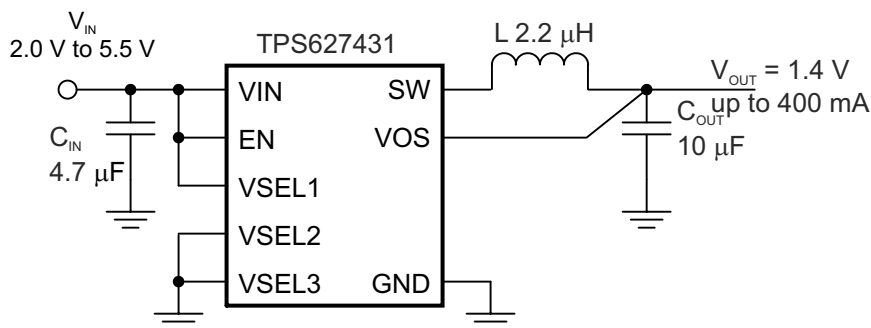

Copyright © 2016, Texas Instruments Incorporated

图 9-2. TPS627431 Typical Application Circuit

#### 9.2.1 Design Requirements

The TPS62743 is a highly integrated DC/DC converter. The output voltage is set via a VSEL pin interface. The design guideline provides a component selection to operate the device within the recommended operating conditions.

表 9-1 shows the list of components for the Application Characteristic Curves.

**表 9-1. Components for Application Characteristic Curves**

Reference	Description	Value	Manufacturer
TPS62743	360nA Iq step down converter		Texas Instruments
CIN	Ceramic capacitor, GRM155R61C475ME15	4.7 $\mu$ F	Murata
COUT	Ceramic capacitor, GRM155R60J106ME11	10 $\mu$ F	Murata
L	Inductor DFE201610C	2.2 $\mu$ H	Toko

## 9.2.2 Detailed Design Procedure

The first step in the design procedure is the selection of the output filter components. To simplify this process, [表 9-2](#) outlines possible inductor and capacitor value combinations.

**表 9-2. Recommended LC Output Filter Combinations**

Inductor Value [ $\mu$ H] <sup>(2)</sup>	Output Capacitor Value [ $\mu$ F] <sup>(1)</sup>				
	4.7 $\mu$ F	10 $\mu$ F	22 $\mu$ F	47 $\mu$ F	100 $\mu$ F
2.2	✓	✓ <sup>(3)</sup>	✓	✓	

(1) Capacitance tolerance and bias voltage de-rating is anticipated. The effective capacitance varies by +20% and - 50%.

(2) Inductor tolerance and current de-rating is anticipated. The effective inductance can vary by 20% and -30%.

(3) Typical application configuration. Other check marks indicate alternative filter combinations.

### 9.2.2.1 Inductor Selection

The inductor value affects the peak-to-peak ripple current, the PWM-to-PFM transition point, the output voltage ripple and the efficiency. The selected inductor has to be rated for its DC resistance and saturation current. The inductor ripple current ( $\Delta I_L$ ) decreases with higher inductance and increases with higher  $V_{IN}$  or  $V_{OUT}$  and can be estimated according to [方程式 1](#).

[方程式 2](#) calculates the maximum inductor current under static load conditions. The saturation current of the inductor should be rated higher than the maximum inductor current, as calculated with [方程式 2](#). This is recommended because during a heavy load transient the inductor current rises above the calculated value. A more conservative way is to select the inductor saturation current according to the high-side MOSFET switch current limit,  $I_{LIMF}$ .

$$\Delta I_L = V_{out} \times \frac{1 - \frac{V_{out}}{V_{in}}}{L \times f} \quad (1)$$

$$I_{Lmax} = I_{outmax} + \frac{\Delta I_L}{2} \quad (2)$$

where

- $f$  = Switching Frequency
- $L$  = Inductor Value
- $\Delta I_L$  = Peak to Peak inductor ripple current
- $I_{Lmax}$  = Maximum Inductor current

[表 9-3](#) shows a list of possible inductors.

**表 9-3. List of Possible Inductors**

INDUCTANCE [ $\mu$ H]	DIMENSIONS [ $\text{mm}^3$ ]	INDUCTOR TYPE	Isat/DCR	SUPPLIER <sup>(1)</sup>	Comment
2.2	2.0 x 1.6 x 1.0	DFE201610C	1.4 A/170 m $\Omega$	TOKO	Efficiency plot Efficiency vs Load Current; V <sub>OUT</sub> = 1.8 V
2.2	2.0 x 1.25 x 1.0	MIPSZ2012D 2R2	0.7 A/230 m $\Omega$	FDK	
2.2	2.0 x 1.2 x 1.0	744 797 752 22	0.7 A/200 m $\Omega$	Würth Elektronik	
2.2	1.6 x 0.8 x 0.8	MDT1608- CH2R2M	0.7 A/300 m $\Omega$	TOKO	

(1) See [Third-party Products Disclaimer](#)

### 9.2.2.2 Output Capacitor Selection

The DCS-Control™ scheme of the TPS62743 allows the use of tiny ceramic capacitors. Ceramic capacitors with low ESR values have the lowest output voltage ripple and are recommended. The output capacitor requires either an X7R or X5R dielectric. At light load currents, the converter operates in Power Save Mode and the output voltage ripple is dependent on the output capacitor value. A larger output capacitors can be used reducing the output voltage ripple. The leakage current of the output capacitor adds to the overall quiescent current.

### 9.2.2.3 Input Capacitor Selection

Because the buck converter has a pulsating input current, a low ESR input capacitor is required for best input voltage filtering to minimize input voltage spikes. For most applications a 4.7- $\mu$ F input capacitor is sufficient. When operating from a high impedance source, like a coin cell a larger input buffer capacitor  $\geq 10\mu\text{F}$  is recommended avoiding voltage drops during start-up and load transients. The input capacitor can be increased without any limit for better input voltage filtering. The leakage current of the input capacitor adds to the overall quiescent current. 表 9-4 shows a selection of input and output capacitors.

**表 9-4. List of Possible Capacitors<sup>(1)</sup>**

CAPACITANCE [ $\mu$ F]	SIZE	CAPACITOR TYPE	SUPPLIER
4.7	0402	GRM155R61C475ME15	Murata
10	0402	GRM155R60J106ME11	Murata

(1) See [Third-party Products Disclaimer](#)

### 9.2.3 Application Curves

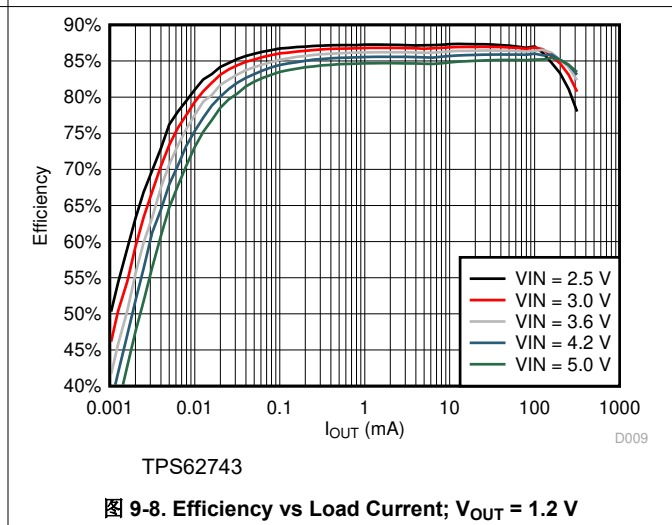
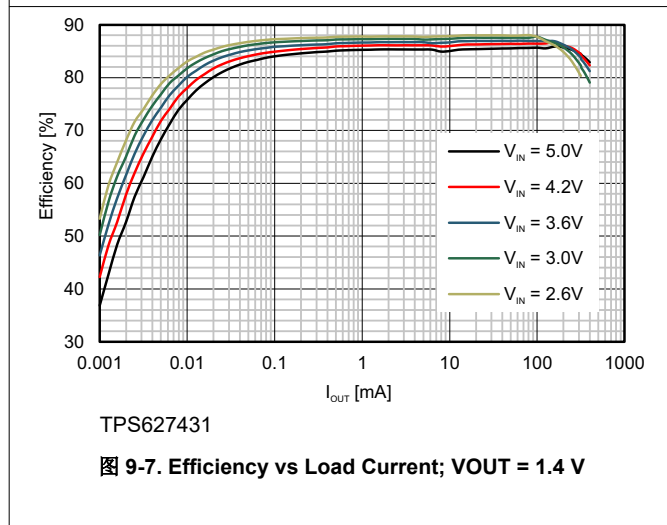
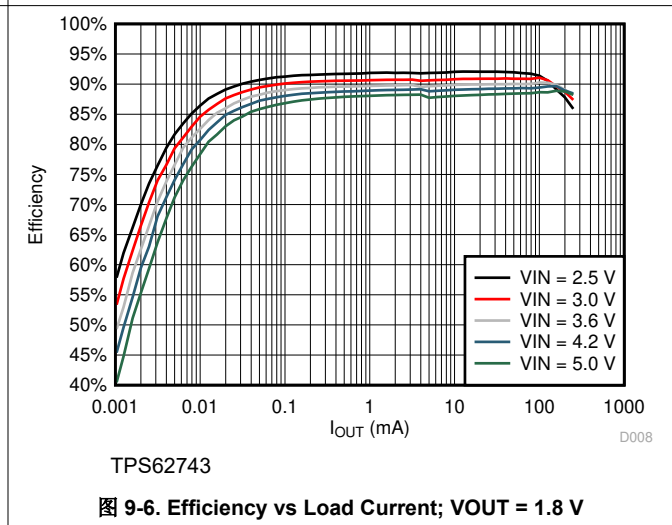
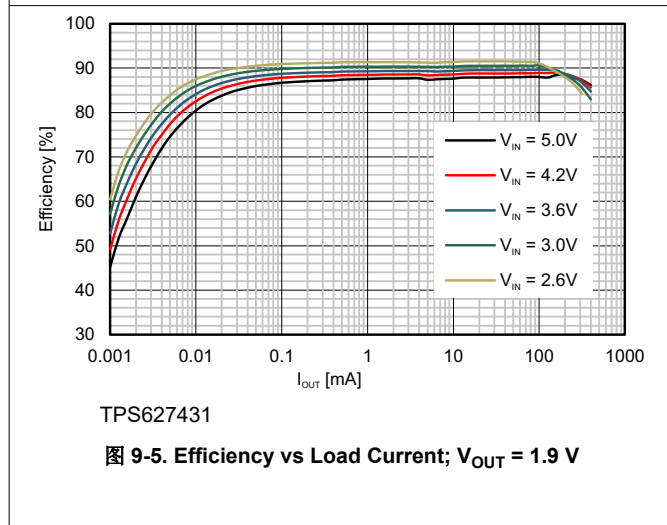
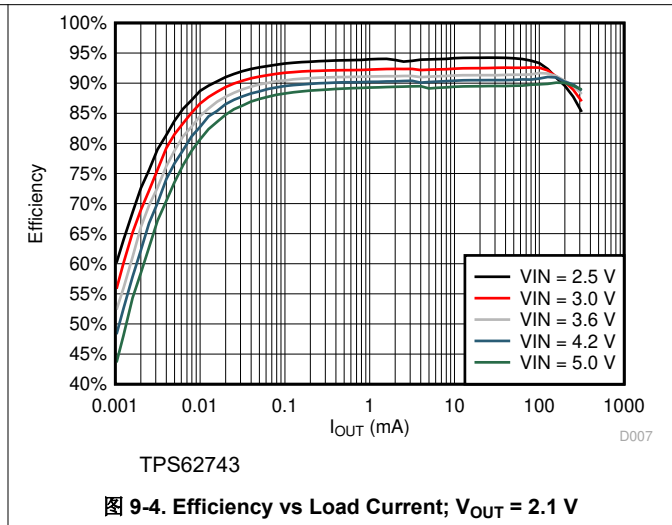
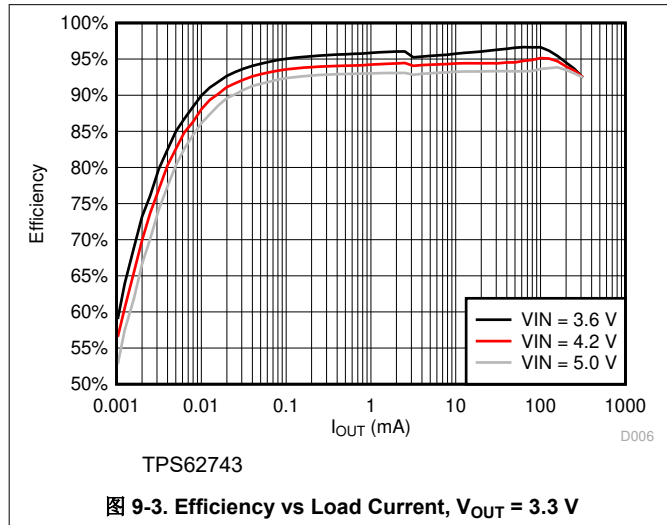

### 9.2.3 Application Curves (continued)



图 9-9. Efficiency vs Load Current;  $V_{OUT} = 1.8\text{ V}$



图 9-10. Switching Frequency vs Load Current  $V_{OUT} = 3.3\text{ V}$

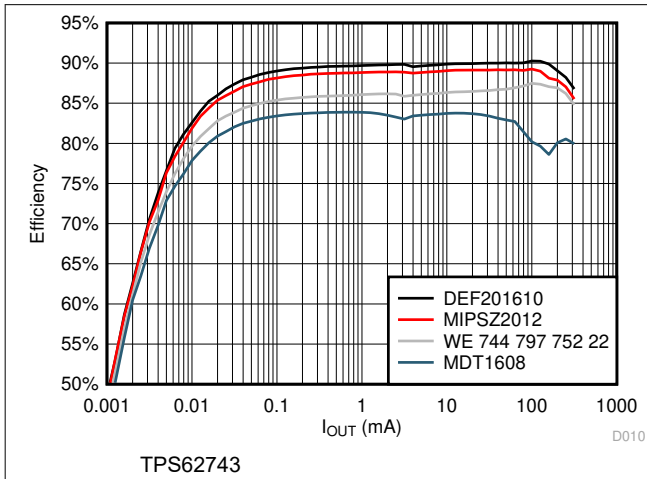

图 9-11. Switching Frequency vs Load Current  $V_{OUT} = 1.8\text{ V}$

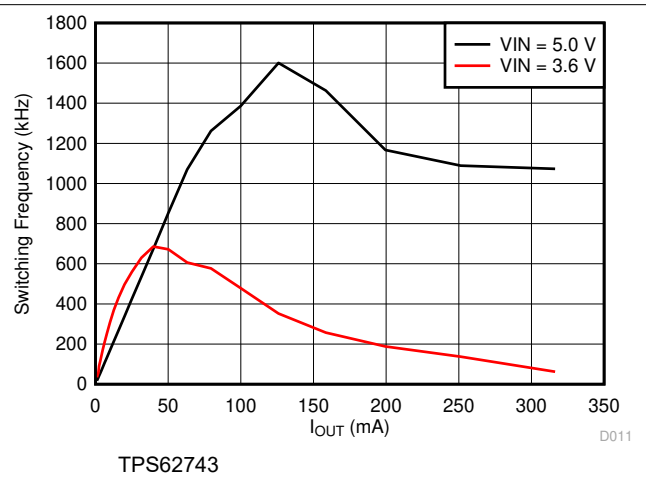

图 9-12. Switching Frequency vs Load Current  $V_{OUT} = 1.4\text{ V}$

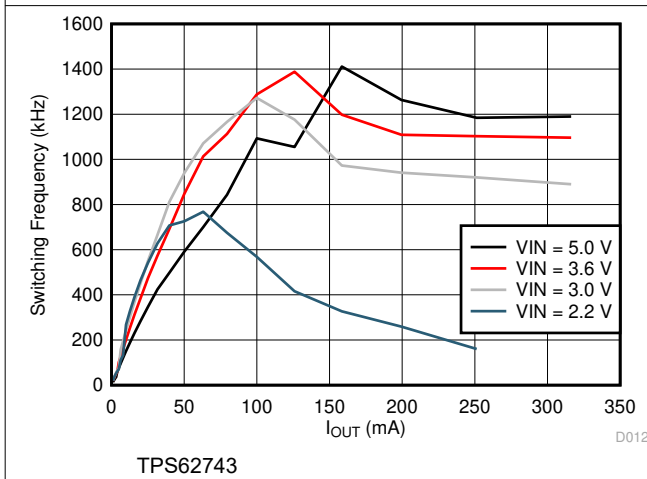

图 9-13. Switching Frequency vs Load Current  $V_{OUT} = 1.2\text{ V}$

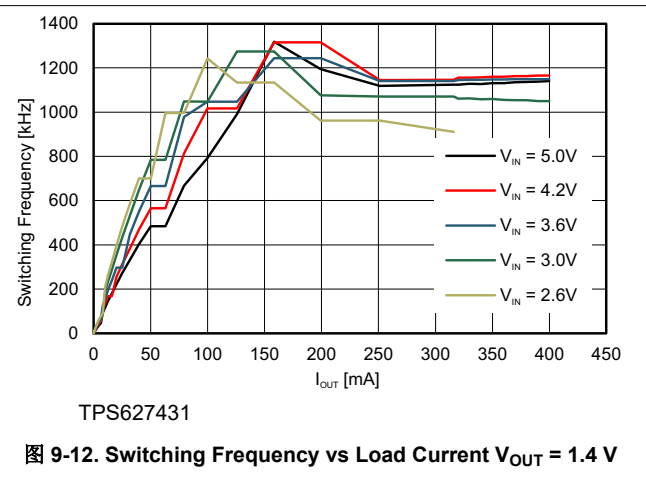

图 9-14. Typical Output Ripple Voltage  $V_{OUT} = 1.4\text{ V}$

### 9.2.3 Application Curves (continued)

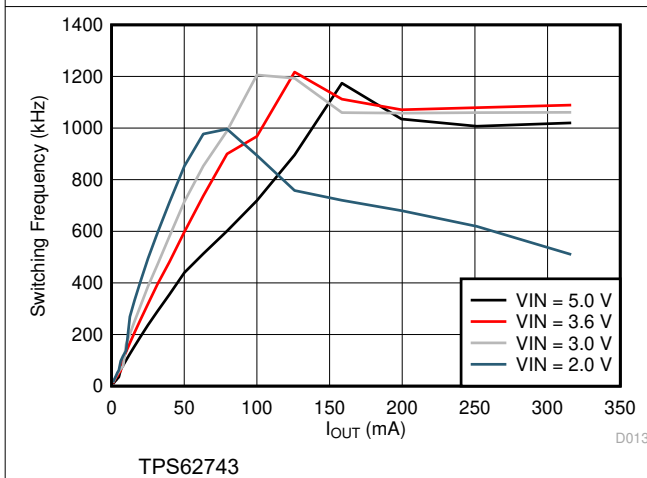

图 9-15. PFM (Power Save Mode) Mode Operation

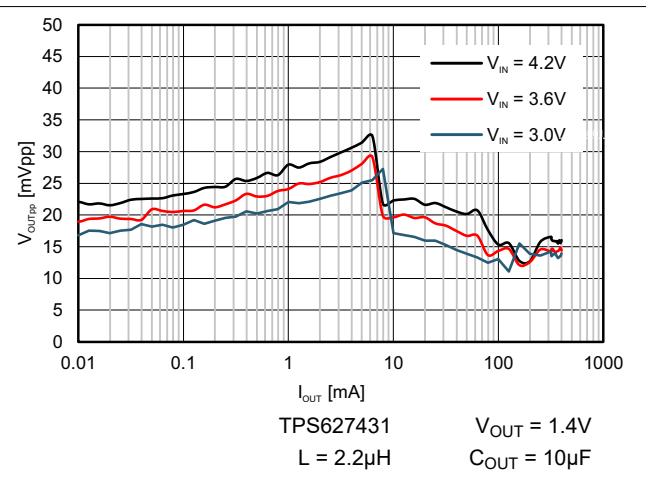

图 9-16. PWM Mode Operation

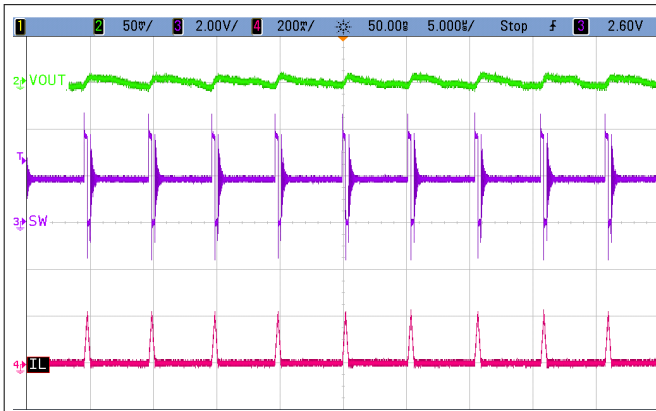

图 9-17. Startup Into 100 mA Electronic Load EN Delay + Soft-Start Delay

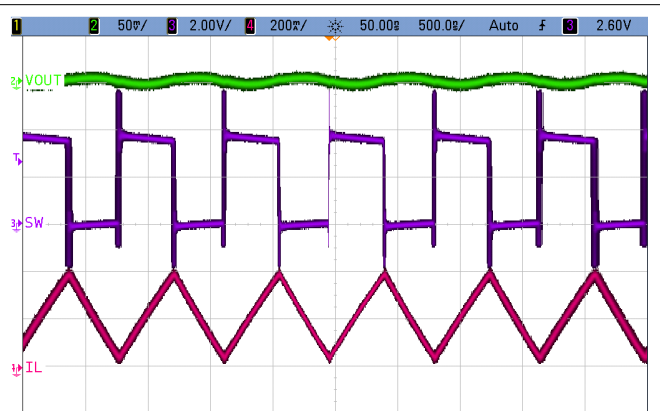

图 9-18. Startup Into 300 mA Electronic Load Soft-Start Delay

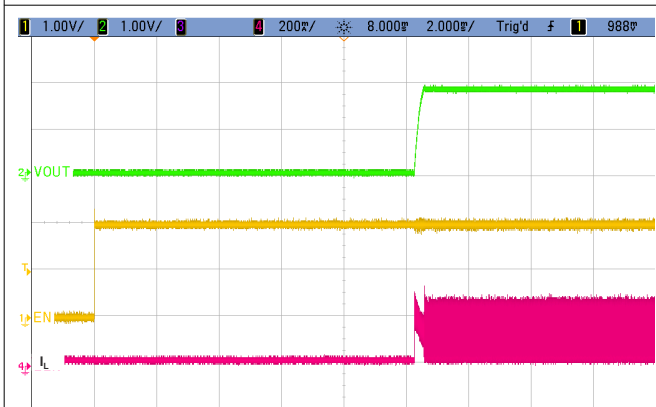

图 9-19. Load Transient Response; 100 mA to 290 mA

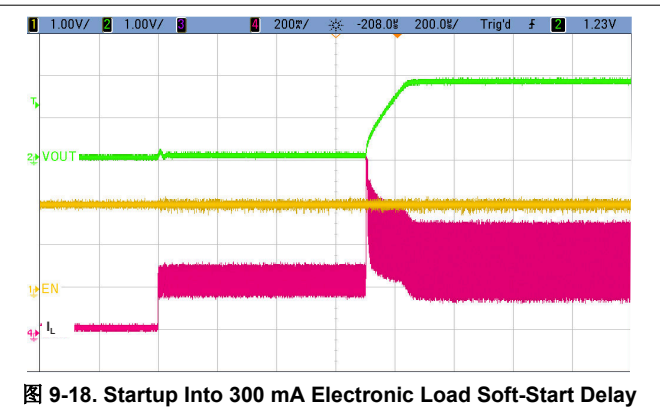

图 9-20. Load Transient Response; 5 mA to 290 mA

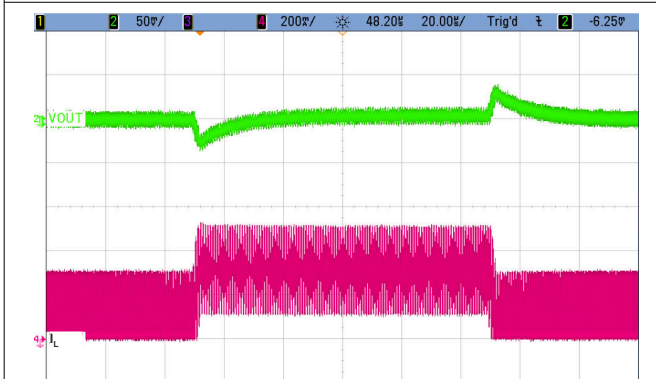

### 9.2.3 Application Curves (continued)

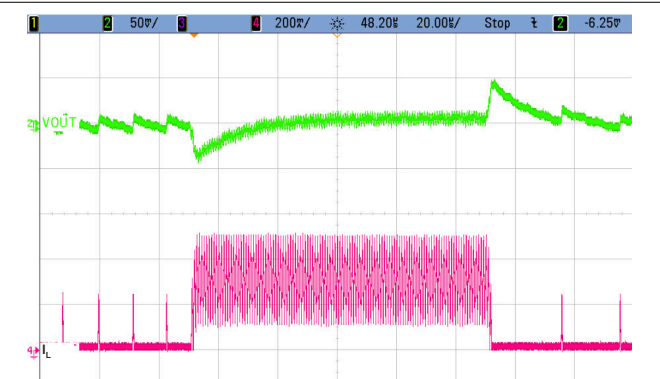
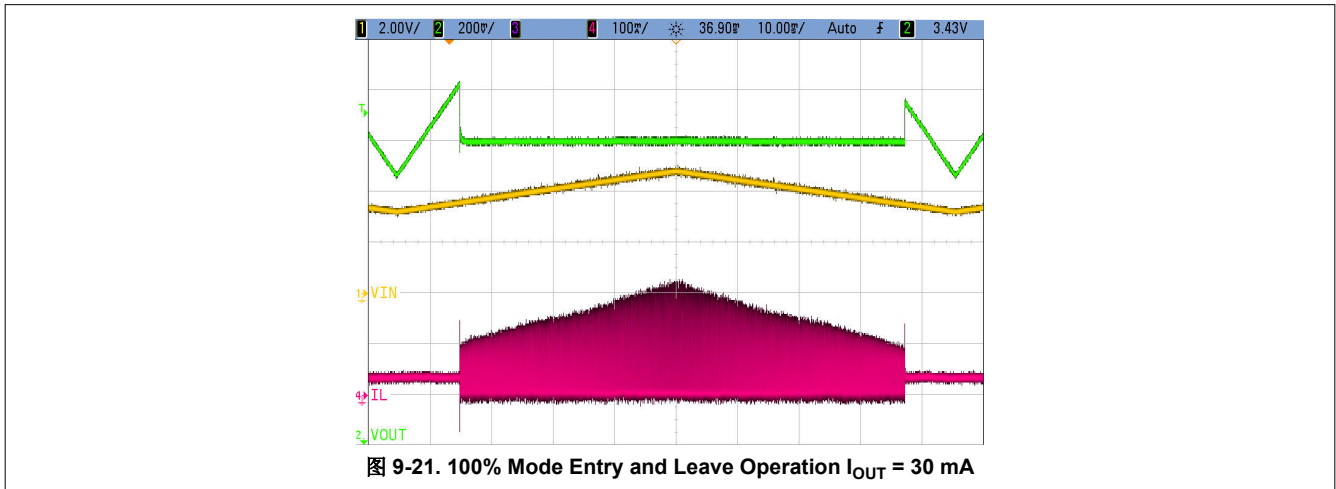

### 9.3 System Example

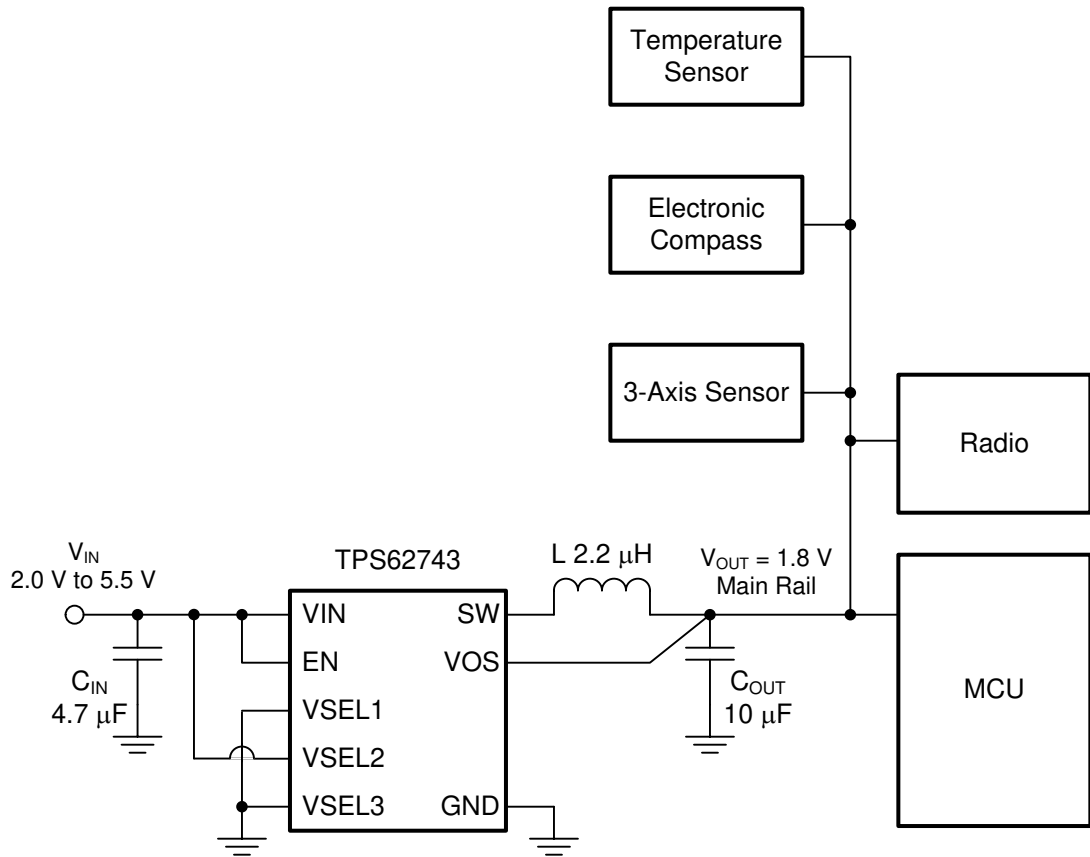

Copyright © 2016, Texas Instruments Incorporated

**图 9-22. Example Of Implementation In A Master MCU Based System**

## 10 Power Supply Recommendations

The power supply must provide a current rating according to the supply voltage, output voltage and output current of the TPS62743.

## 11 Layout

### 11.1 Layout Guidelines

- As for all switching power supplies, the layout is an important step in the design. Care must be taken in board layout to get the specified performance.
- It is critical to provide a low inductance, impedance ground path. Therefore, use wide and short traces for the main current paths.
- The input capacitor should be placed as close as possible to the IC pins VIN and GND. This is the most critical component placement.
- The  $V_{OS}$  line is a sensitive high impedance line and should be connected to the output capacitor and routed away from noisy components and traces (e.g. SW line) or other noise sources.

### 11.2 Layout Example



图 11-1. Recommended PCB Layout

## 12 Device and Documentation Support

### 12.1 Device Support

#### 12.1.1 第三方产品免责声明

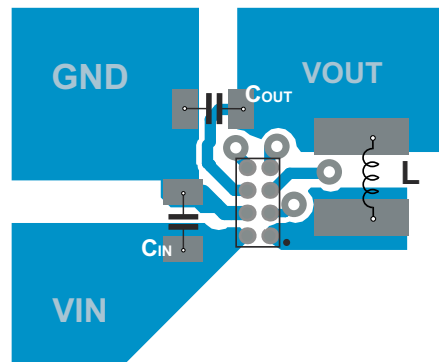
TI 发布的与第三方产品或服务有关的信息，不能构成与此类产品或服务或保修的适用性有关的认可，不能构成此类产品或服务单独或与任何 TI 产品或服务一起的表示或认可。

#### 12.2 接收文档更新通知

要接收文档更新通知，请导航至 [ti.com](http://ti.com) 上的器件产品文件夹。点击 [订阅更新](#) 进行注册，即可每周接收产品信息更改摘要。有关更改的详细信息，请查看任何已修订文档中包含的修订历史记录。

#### 12.3 支持资源

TI E2E™ [支持论坛](#) 是工程师的重要参考资料，可直接从专家获得快速、经过验证的解答和设计帮助。搜索现有解答或提出自己的问题可获得所需的快速设计帮助。

链接的内容由各个贡献者“按原样”提供。这些内容并不构成 TI 技术规范，并且不一定反映 TI 的观点；请参阅 TI 的 [《使用条款》](#)。

#### 12.4 Trademarks

DCS-Control™ and TI E2E™ are trademarks of Texas Instruments.

蓝牙® is a registered trademark of Bluetooth SIG, Inc.

所有商标均为其各自所有者的财产。

#### 12.5 静电放电警告



静电放电 (ESD) 会损坏这个集成电路。德州仪器 (TI) 建议通过适当的预防措施处理所有集成电路。如果不遵守正确的处理和安装程序，可能会损坏集成电路。

ESD 的损坏小至导致微小的性能降级，大至整个器件故障。精密的集成电路可能更容易受到损坏，这是因为非常细微的参数更改都可能会导致器件与其发布的规格不相符。

#### 12.6 术语表

[TI 术语表](#) 本术语表列出并解释了术语、首字母缩略词和定义。

## 13 Mechanical, Packaging, and Orderable Information

The following pages include mechanical, packaging, and orderable information. This information is the most current data available for the designated devices. This data is subject to change without notice and revision of this document. For browser-based versions of this data sheet, refer to the left-hand navigation.

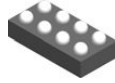

**PACKAGE OUTLINE**

**YFP0008-C01**

**DSBGA - 0.531 mm max height**

DIE SIZE BALL GRID ARRAY

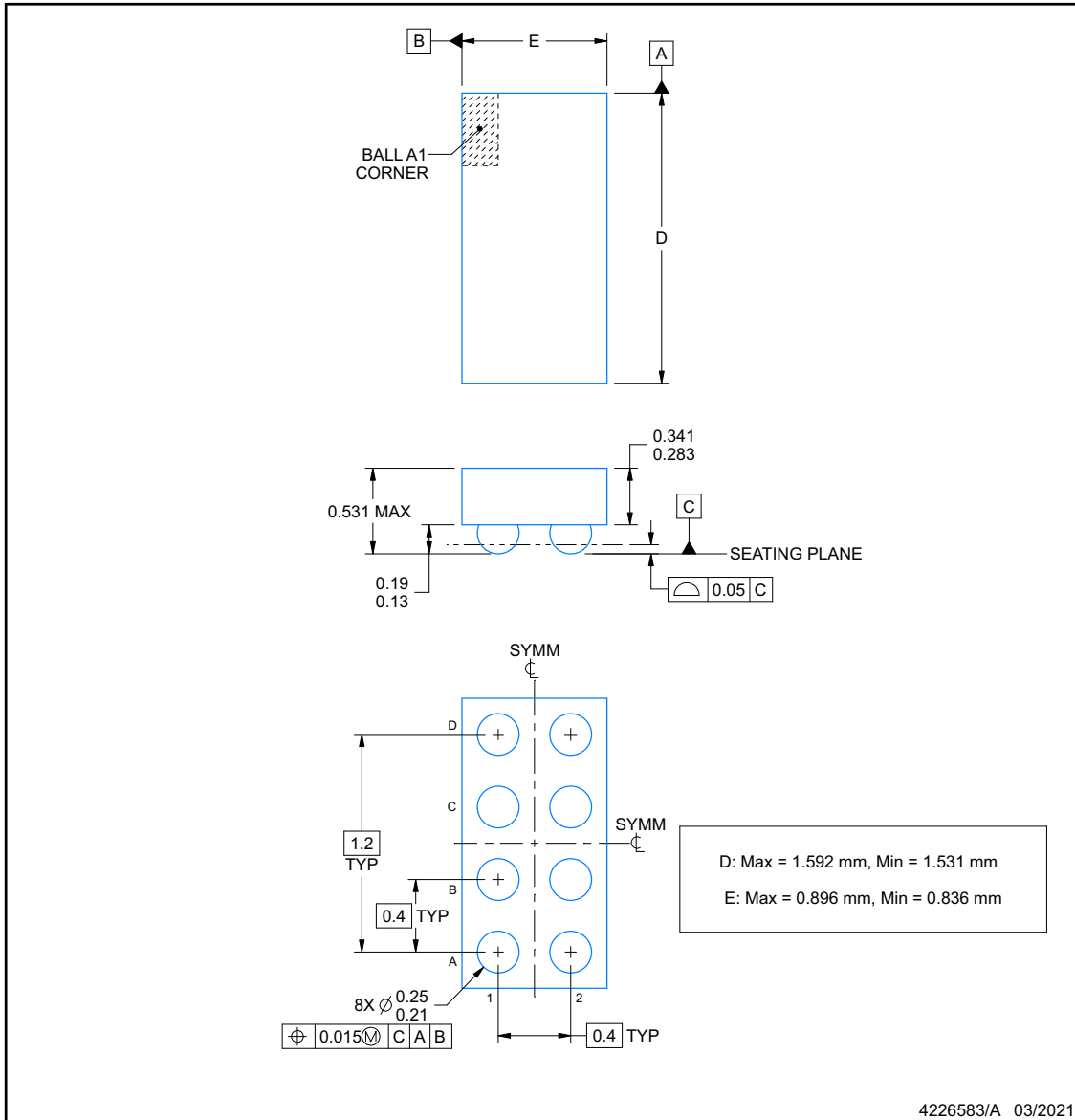

NOTES:

1. All linear dimensions are in millimeters. Any dimensions in parenthesis are for reference only. Dimensioning and tolerancing per ASME Y14.5M.
2. This drawing is subject to change without notice.

## EXAMPLE BOARD LAYOUT

**YFP0008-C01**

**DSBGA - 0.531 mm max height**

DIE SIZE BALL GRID ARRAY

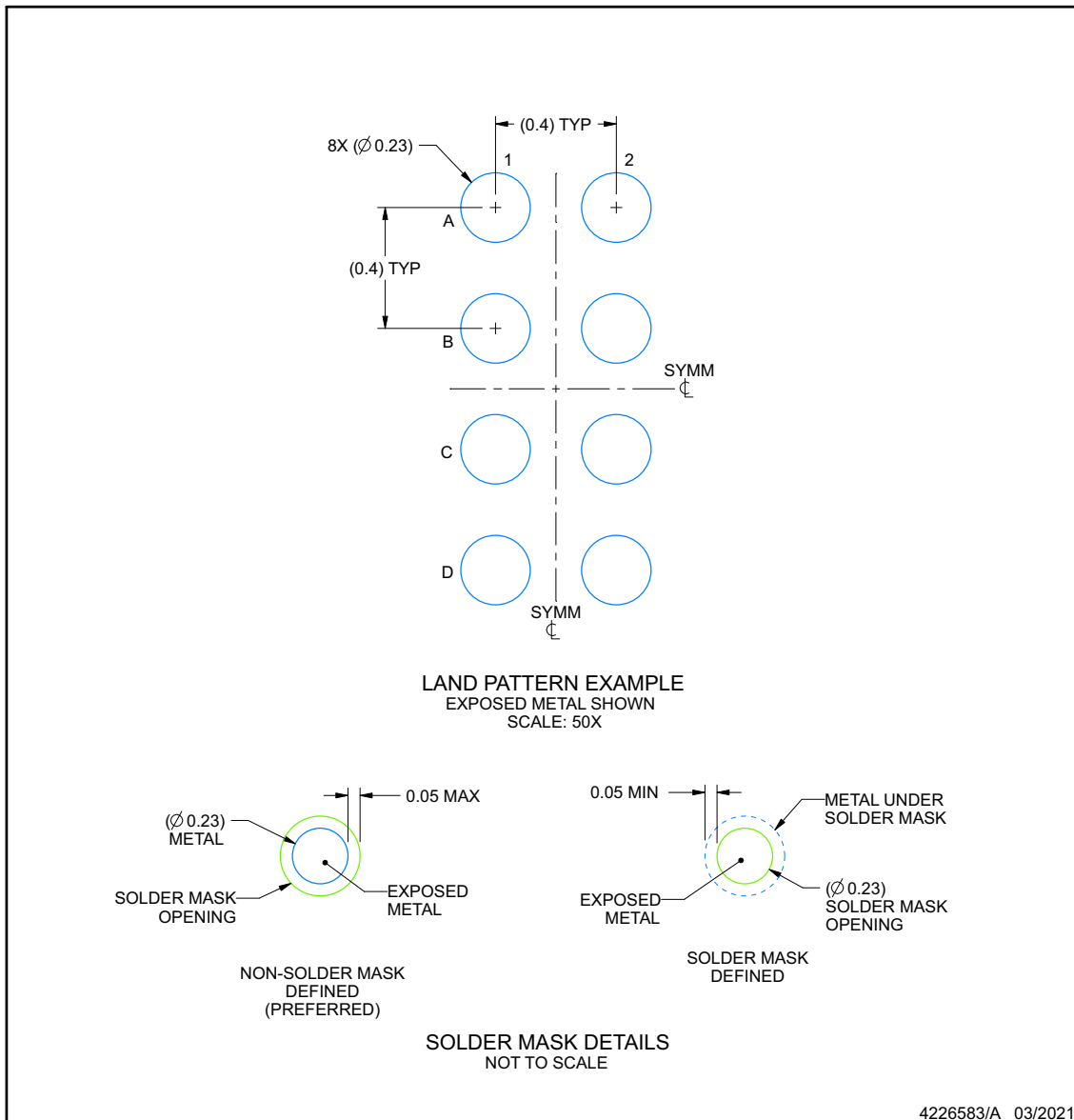

NOTES: (continued)

- Final dimensions may vary due to manufacturing tolerance considerations and also routing constraints. See Texas Instruments Literature No. SNVA009 ([www.ti.com/lit/snva009](http://www.ti.com/lit/snva009)).

## EXAMPLE STENCIL DESIGN

**YFP0008-C01**

**DSBGA - 0.531 mm max height**

DIE SIZE BALL GRID ARRAY

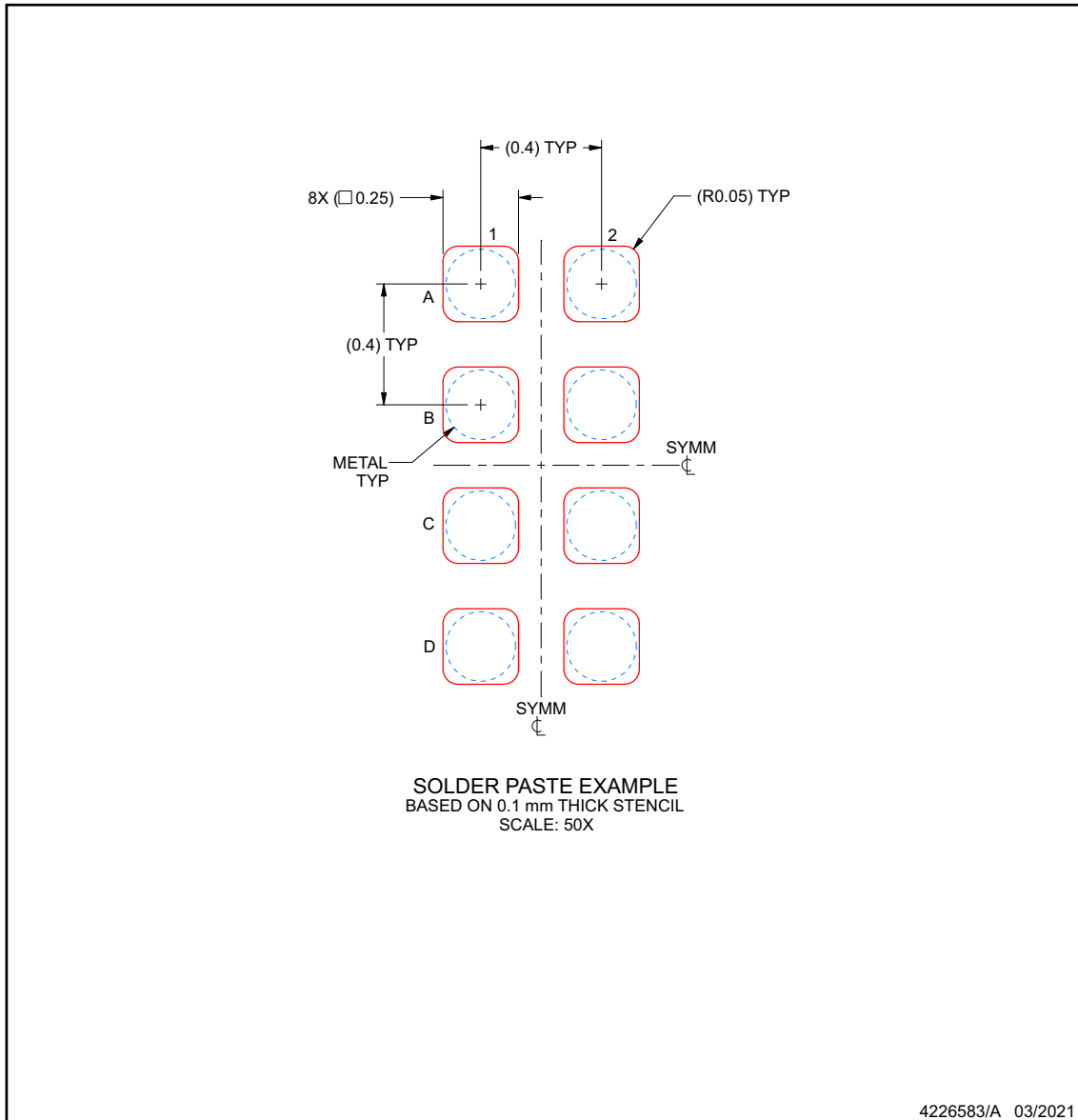

NOTES: (continued)

4. Laser cutting apertures with trapezoidal walls and rounded corners may offer better paste release.

**PACKAGING INFORMATION**

Orderable Device	Status (1)	Package Type	Package Drawing	Pins	Package Qty	Eco Plan (2)	Lead finish/ Ball material (6)	MSL Peak Temp (3)	Op Temp (°C)	Device Marking (4/5)	Samples
TPS627431YFPR	ACTIVE	DSBGA	YFP	8	3000	RoHS & Green	SNAGCU	Level-1-260C-UNLIM	-40 to 85	627431	<a href="#">Samples</a>
TPS627431YFPT	ACTIVE	DSBGA	YFP	8	250	RoHS & Green	SNAGCU	Level-1-260C-UNLIM	-40 to 85	627431	<a href="#">Samples</a>
TPS62743YFPR	ACTIVE	DSBGA	YFP	8	3000	RoHS & Green	SNAGCU	Level-1-260C-UNLIM	-40 to 85	TPS743	<a href="#">Samples</a>
TPS62743YFPT	ACTIVE	DSBGA	YFP	8	250	RoHS & Green	SNAGCU	Level-1-260C-UNLIM	-40 to 85	TPS743	<a href="#">Samples</a>

(1) The marketing status values are defined as follows:

**ACTIVE:** Product device recommended for new designs.

**LIFEBUY:** TI has announced that the device will be discontinued, and a lifetime-buy period is in effect.

**NRND:** Not recommended for new designs. Device is in production to support existing customers, but TI does not recommend using this part in a new design.

**PREVIEW:** Device has been announced but is not in production. Samples may or may not be available.

**OBSELETE:** TI has discontinued the production of the device.

(2) **RoHS:** TI defines "RoHS" to mean semiconductor products that are compliant with the current EU RoHS requirements for all 10 RoHS substances, including the requirement that RoHS substance do not exceed 0.1% by weight in homogeneous materials. Where designed to be soldered at high temperatures, "RoHS" products are suitable for use in specified lead-free processes. TI may reference these types of products as "Pb-Free".

**RoHS Exempt:** TI defines "RoHS Exempt" to mean products that contain lead but are compliant with EU RoHS pursuant to a specific EU RoHS exemption.

**Green:** TI defines "Green" to mean the content of Chlorine (Cl) and Bromine (Br) based flame retardants meet JS709B low halogen requirements of <=1000ppm threshold. Antimony trioxide based flame retardants must also meet the <=1000ppm threshold requirement.

(3) MSL, Peak Temp. - The Moisture Sensitivity Level rating according to the JEDEC industry standard classifications, and peak solder temperature.

(4) There may be additional marking, which relates to the logo, the lot trace code information, or the environmental category on the device.

(5) Multiple Device Markings will be inside parentheses. Only one Device Marking contained in parentheses and separated by a "-" will appear on a device. If a line is indented then it is a continuation of the previous line and the two combined represent the entire Device Marking for that device.

(6) Lead finish/Ball material - Orderable Devices may have multiple material finish options. Finish options are separated by a vertical ruled line. Lead finish/Ball material values may wrap to two lines if the finish value exceeds the maximum column width.

**Important Information and Disclaimer:**The information provided on this page represents TI's knowledge and belief as of the date that it is provided. TI bases its knowledge and belief on information provided by third parties, and makes no representation or warranty as to the accuracy of such information. Efforts are underway to better integrate information from third parties. TI has taken and



continues to take reasonable steps to provide representative and accurate information but may not have conducted destructive testing or chemical analysis on incoming materials and chemicals. TI and TI suppliers consider certain information to be proprietary, and thus CAS numbers and other limited information may not be available for release.

In no event shall TI's liability arising out of such information exceed the total purchase price of the TI part(s) at issue in this document sold by TI to Customer on an annual basis.

**TAPE AND REEL INFORMATION**

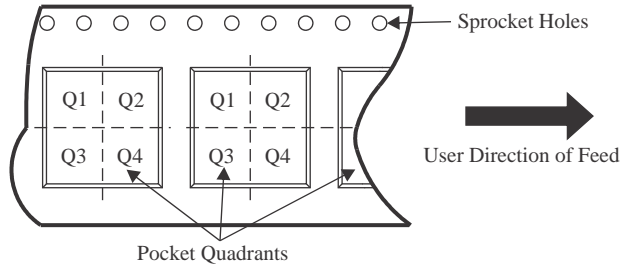
**QUADRANT ASSIGNMENTS FOR PIN 1 ORIENTATION IN TAPE**

\*All dimensions are nominal

Device	Package Type	Package Drawing	Pins	SPQ	Reel Diameter (mm)	Reel Width W1 (mm)	A0 (mm)	B0 (mm)	K0 (mm)	P1 (mm)	W (mm)	Pin1 Quadrant
TPS627431YFPR	DSBGA	YFP	8	3000	180.0	8.4	0.98	1.68	0.59	4.0	8.0	Q1
TPS627431YFPT	DSBGA	YFP	8	250	180.0	8.4	0.98	1.68	0.59	4.0	8.0	Q1
TPS62743YFPR	DSBGA	YFP	8	3000	180.0	8.4	0.98	1.68	0.59	4.0	8.0	Q1
TPS62743YFPT	DSBGA	YFP	8	250	180.0	8.4	0.98	1.68	0.59	4.0	8.0	Q1

**TAPE AND REEL BOX DIMENSIONS**

\*All dimensions are nominal

Device	Package Type	Package Drawing	Pins	SPQ	Length (mm)	Width (mm)	Height (mm)
TPS627431YFPR	DSBGA	YFP	8	3000	182.0	182.0	20.0
TPS627431YFPT	DSBGA	YFP	8	250	182.0	182.0	20.0
TPS62743YFPR	DSBGA	YFP	8	3000	182.0	182.0	20.0
TPS62743YFPT	DSBGA	YFP	8	250	182.0	182.0	20.0

YFP0008

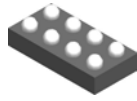

PACKAGE OUTLINE

DSBGA - 0.5 mm max height

DIE SIZE BALL GRID ARRAY

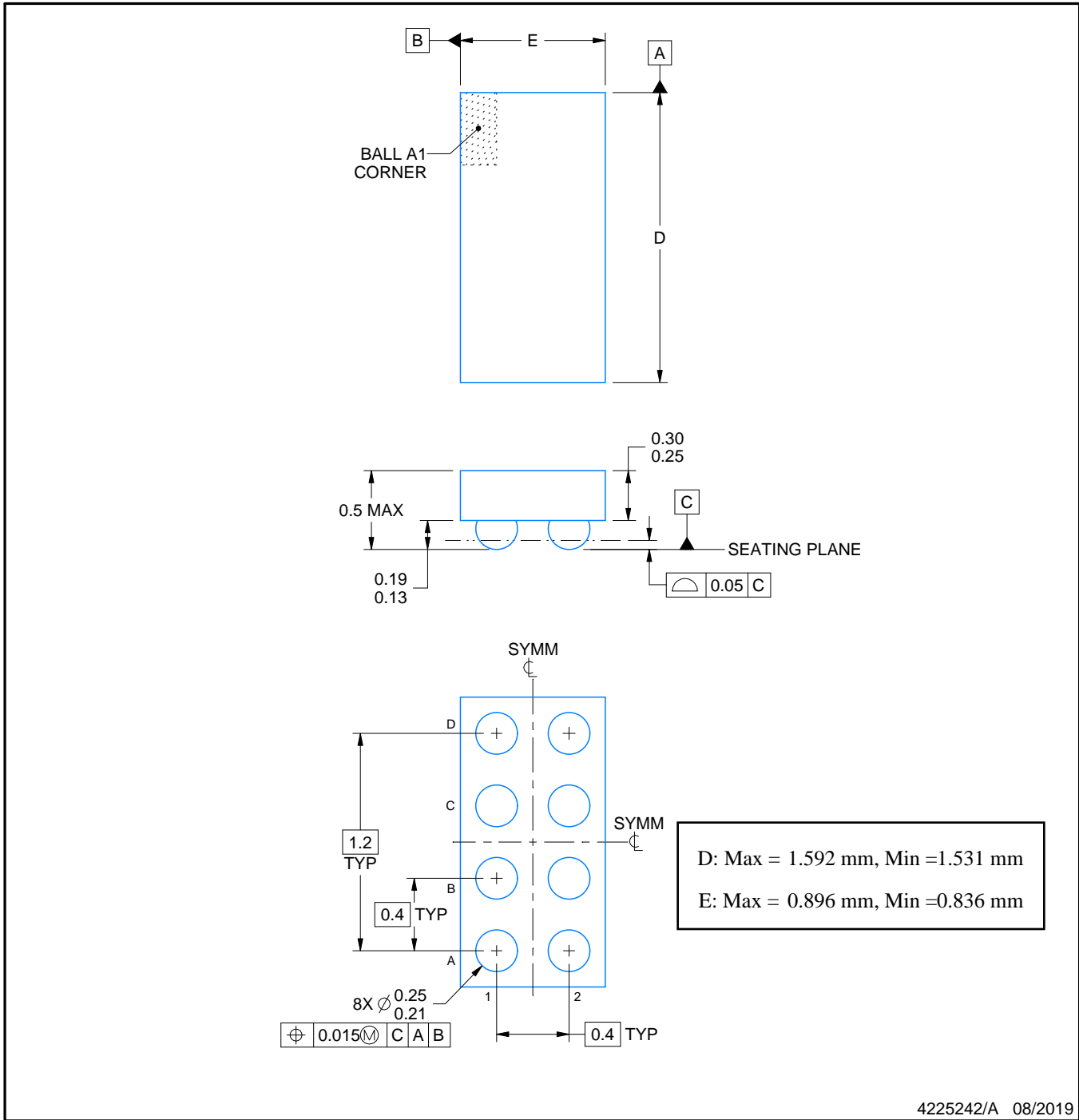

NOTES:

1. All linear dimensions are in millimeters. Any dimensions in parenthesis are for reference only. Dimensioning and tolerancing per ASME Y14.5M.
2. This drawing is subject to change without notice.

# EXAMPLE BOARD LAYOUT

YFP0008

DSBGA - 0.5 mm max height

DIE SIZE BALL GRID ARRAY

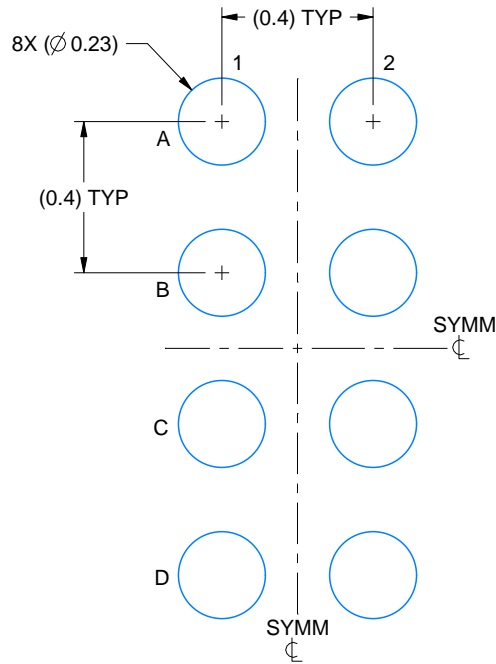

LAND PATTERN EXAMPLE  
EXPOSED METAL SHOWN  
SCALE: 50X

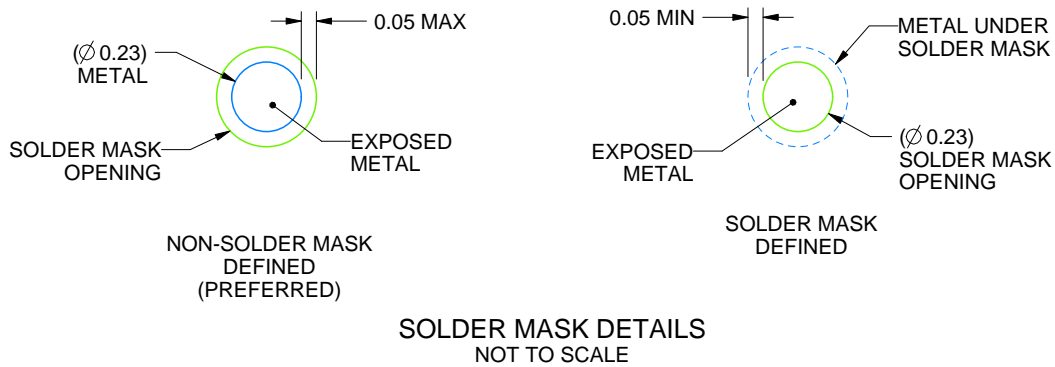

SOLDER MASK DETAILS  
NOT TO SCALE

4225242/A 08/2019

NOTES: (continued)

- Final dimensions may vary due to manufacturing tolerance considerations and also routing constraints. See Texas Instruments Literature No. SNVA009 ([www.ti.com/lit/snva009](http://www.ti.com/lit/snva009)).

# EXAMPLE STENCIL DESIGN

YFP0008

DSBGA - 0.5 mm max height

DIE SIZE BALL GRID ARRAY

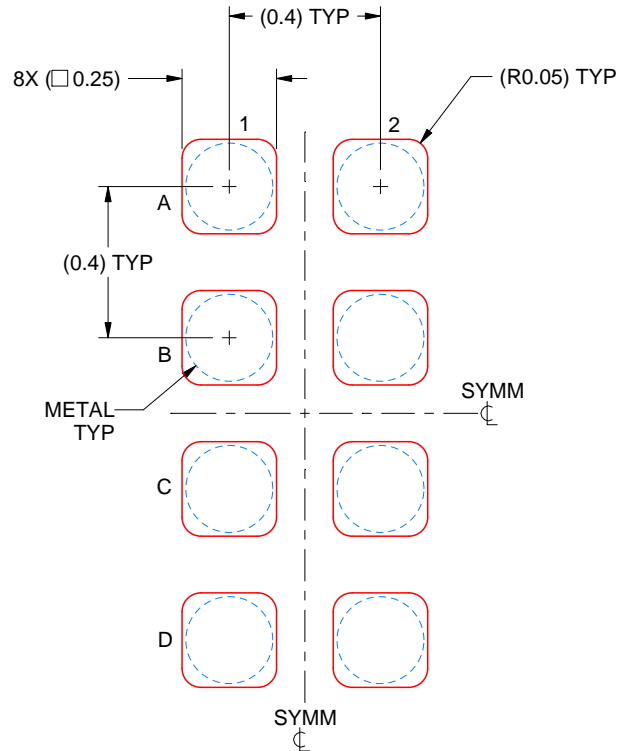

SOLDER PASTE EXAMPLE  
BASED ON 0.1 mm THICK STENCIL  
SCALE: 50X

4225242/A 08/2019

NOTES: (continued)

4. Laser cutting apertures with trapezoidal walls and rounded corners may offer better paste release.

## 重要声明和免责声明

TI“按原样”提供技术和可靠性数据（包括数据表）、设计资源（包括参考设计）、应用或其他设计建议、网络工具、安全信息和其他资源，不保证没有瑕疵且不做任何明示或暗示的担保，包括但不限于对适销性、某特定用途方面的适用性或不侵犯任何第三方知识产权的暗示担保。

这些资源可供使用 TI 产品进行设计的熟练开发人员使用。您将自行承担以下全部责任：(1) 针对您的应用选择合适的 TI 产品，(2) 设计、验证并测试您的应用，(3) 确保您的应用满足相应标准以及任何其他功能安全、信息安全、监管或其他要求。

这些资源如有变更，恕不另行通知。TI 授权您仅可将这些资源用于研发本资源所述的 TI 产品的应用。严禁对这些资源进行其他复制或展示。您无权使用任何其他 TI 知识产权或任何第三方知识产权。您应全额赔偿因在这些资源的使用中对 TI 及其代表造成的任何索赔、损害、成本、损失和债务，TI 对此概不负责。

TI 提供的产品受 [TI 的销售条款](#) 或 [ti.com](#) 上其他适用条款/TI 产品随附的其他适用条款的约束。TI 提供这些资源并不会扩展或以其他方式更改 TI 针对 TI 产品发布的适用的担保或担保免责声明。

TI 反对并拒绝您可能提出的任何其他或不同的条款。

邮寄地址：Texas Instruments, Post Office Box 655303, Dallas, Texas 75265

Copyright © 2024，德州仪器 (TI) 公司