

## TPS6282x 具有 1% 输出精度的 2.4V 至 5.5V 输入、1A/2A/3A/4A 降压转换器

### 1 特性

- 可作为集成电感器的电源模块：[TPSM82821](#)、[TPSM82822](#) 和 [TPSM82823](#)
- DCS-Control 拓扑
- 1% 反馈或输出电压精度（整个温度范围）
- 效率高达 97%
- 26mΩ 和 25mΩ 内部功率 MOSFET
- 2.4V 至 5.5V 输入电压范围
- 运行静态电流 4 μA
- 2.2MHz 开关频率
- 0.6V 至 4V 可调节输出电压
- 可实现轻负载效率的省电模式
- 100% 占空比，可实现超低压降
- 有源输出放电
- 电源正常状态输出
- 热关断保护
- 断续短路保护
- 强制 PWM 版本可支持 CCM 运行
- 使用 TPS6282x 并借助 [WEBENCH® Power Designer](#) 创建定制设计方案

### 2 应用

- [固态硬盘](#)
- [便携式电子产品](#)
- [模拟安防摄像头](#)和 [IP 网络摄像头](#)
- [工业 PC](#)
- [多功能打印机](#)
- [通用负载点](#)

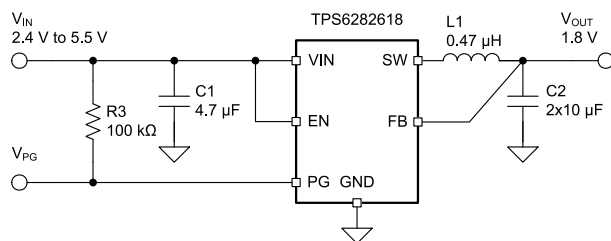

典型应用原理图

### 3 说明

TPS6282x 是易于使用的同步直流/直流降压转换器系列，具有仅 4 μA 的超低静态电流。该器件基于 DCS 控制拓扑，可实现快速瞬态响应。由于具有内部基准，该产品可在 -40°C 至 125°C 的结温范围内以 1% 的高反馈电压精度将输出电压调节到 0.6V 以下。该系列器件具有引脚对引脚和 BOM 对 BOM 兼容性。整个设计需要一个小型 470nH 电感器、一个 4.7μF 输入电容器以及两个 10μF 输出电容器（或一个 22μF 输出电容器）。

TPS6282x 具有两种型号。第一种型号可自动进入省电模式，在超轻负载条件下保持高效率，从而延长系统电池的运行时间。第二种型号可实现强制 PWM 运行，以维持连续导通模式，从而确保超低的输出电压纹波和准固定开关频率。该器件具有电源正常信号和内部软启动电路。该器件能够以 100% 模式运行。在故障保护方面，该器件加入了断续短路保护以及热关断功能。该器件采用 6 引脚 1.5mm x 1.5mm QFN 封装，可实现超功率密度设计。

#### 器件信息

器件型号	封装 <sup>(1)</sup>	封装尺寸 <sup>(2)</sup>
TPS6282xx	DMQ ( VSON-HR, 6 )	1.5mm × 1.5mm

(1) 有关更多信息，请参阅节 11。

(2) 封装尺寸（长 × 宽）为标称值，并包括引脚（如适用）。

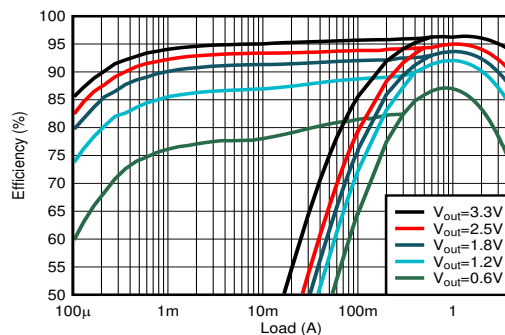

$V_{IN} = 5V$  时的效率



## Table of Contents

<b>1 特性</b> .....	1	7.4 Device Functional Modes.....	10
<b>2 应用</b> .....	1	<b>8 Application and Implementation</b> .....	12
<b>3 说明</b> .....	1	8.1 Application Information.....	12
<b>4 Device Options</b> .....	3	8.2 Typical Application.....	12
<b>5 Pin Configuration and Functions</b> .....	3	8.3 Power Supply Recommendations.....	23
<b>6 Specifications</b> .....	4	8.4 Layout.....	23
6.1 Absolute Maximum Ratings.....	4	<b>9 Device and Documentation Support</b> .....	25
6.2 ESD Ratings.....	4	9.1 Device Support.....	25
6.3 Recommended Operating Conditions.....	4	9.2 Documentation Support.....	25
6.4 Thermal Information.....	4	9.3 支持资源.....	25
6.5 Electrical Characteristics.....	5	9.4 Trademarks.....	25
6.6 Typical Characteristics.....	7	9.5 静电放电警告.....	25
<b>7 Detailed Description</b> .....	8	9.6 术语表.....	25
7.1 Overview.....	8	<b>10 Revision History</b> .....	26
7.2 Functional Block Diagram.....	8	<b>11 Mechanical, Packaging, and Orderable Information</b> .....	26
7.3 Feature Description.....	9		

## 4 Device Options

PART NUMBER	OUTPUT VOLTAGE	OPERATION MODE	OUTPUT CURRENT
TPS62824DMQ	Adjustable	PSM/PWM	1A
TPS62825DMQ	Adjustable		2A
TPS6282518DMQ	1.8V		
TPS6282533DMQ	3.3V		
TPS62826DMQ	Adjustable		3A
TPS6282618DMQ	1.8V		
TPS62827DMQ	Adjustable		4A
TPS62824ADMQ	Adjustable	Forced-PWM	1A
TPS62825ADMQ	Adjustable		2A
TPS62826ADMQ	Adjustable		3A
TPS62827ADMQ	Adjustable		4A

## 5 Pin Configuration and Functions



图 5-1. DMQ Package, 6-Pin VSON-HR (Bottom View)

表 5-1. Pin Functions

PIN		TYPE <sup>(1)</sup>	DESCRIPTION
NAME	NO.		
EN	1	I	Device enable pin. To enable the device, this pin must be pulled high. Pulling this pin low disables the device. Do not leave floating.
PG	2	O	Power-good open-drain output pin. The pullup resistor can be connected to voltages up to 5.5V. If unused, leave the pin floating.
FB	3	I	Feedback pin. For the fixed output voltage versions, this pin must be connected to the output.
GND	4		Ground pin
SW	5	PWR	Switch pin of the power stage
VIN	6	PWR	Input voltage pin

(1) I = input, O = output, PWR = power

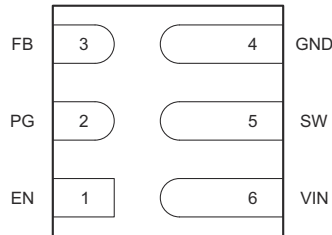
## 6 Specifications

### 6.1 Absolute Maximum Ratings

Over operating junction temperature range (unless otherwise noted) <sup>(1)</sup>

		MIN	MAX	UNIT
Voltage at Pins <sup>(2)</sup>	VIN, FB, EN, PG	- 0.3	6	V
	SW (DC) <sup>(4)</sup>	- 0.3	V <sub>IN</sub> + 0.3	
	SW (DC, in current limit)	- 1.0	V <sub>IN</sub> + 0.3	
	SW (AC, less than 10ns) <sup>(3)</sup>	- 2.5	10	
	SW (AC, PFM Mode, less than 100ns) <sup>(3)</sup>	- 1.0	V <sub>IN</sub> + 1.0	
Temperature	Operating junction temperature, T <sub>J</sub>	- 40	150	°C
	Storage temperature, T <sub>stg</sub>	- 65	150	

- (1) Operation outside the *Absolute Maximum Ratings* may cause permanent device damage. *Absolute Maximum Ratings* do not imply functional operation of the device at these or any other conditions beyond those listed under *Recommended Operating Conditions*. If used outside the *Recommended Operating Conditions* but within the *Absolute Maximum Ratings*, the device may not be fully functional, and this may affect device reliability, functionality, performance, and shorten the device lifetime.
- (2) All voltage values are with respect to network ground terminal.
- (3) While switching.
- (4) After disabling the device, the SW voltage may exceed the MIN specification until the inductor and output capacitor are fully discharged.

### 6.2 ESD Ratings

			VALUE	UNIT
V <sub>(ESD)</sub>	Electrostatic discharge	Human-body model (HBM), per ANSI/ESDA/JEDEC JS-001 <sup>(1)</sup>	±2000	V
		Charged-device model (CDM), per JEDEC specification JESD22-C101 <sup>(2)</sup>	±500	V

- (1) JEDEC document JEP155 states that 500-V HBM allows safe manufacturing with a standard ESD control process.
- (2) JEDEC document JEP157 states that 250-V CDM allows safe manufacturing with a standard ESD control process.

### 6.3 Recommended Operating Conditions

Over operating junction temperature range (unless otherwise noted)

		MIN	NOM	MAX	UNIT
V <sub>IN</sub>	Input voltage range, TPS62824x, TPS62825x and TPS62826x	2.4		5.5	V
V <sub>IN</sub>	Input voltage range, TPS62827x	2.5		5.5	V
V <sub>OUT</sub>	Output voltage range	0.6		4.0	V
I <sub>OUT</sub>	Output current range, TPS62824x	0		1	A
I <sub>OUT</sub>	Output current range, TPS62825x	0		2	A
I <sub>OUT</sub>	Output current range, TPS62826x	0		3	A
I <sub>OUT</sub>	Output current range, TPS62827x	0		4	A
I <sub>SINK_PG</sub>	Sink current at PG pin			1	mA
V <sub>PG</sub>	Pull-up resistor voltage			5.5	V
T <sub>J</sub>	Operating junction temperature	-40		125	°C

### 6.4 Thermal Information

THERMAL METRIC <sup>(1)</sup>		DEVICE		UNIT
		TPS6282x, JEDEC	TPS62826EVM-794	
		6 pins	6 pins	
R <sub>θJA</sub>	Junction-to-ambient thermal resistance	129.5	71.4	°C/W
R <sub>θJC(top)</sub>	Junction-to-case (top) thermal resistance	103.9	n/a <sup>(2)</sup>	°C/W
R <sub>θJB</sub>	Junction-to-board thermal resistance	33.1	n/a <sup>(2)</sup>	°C/W
ψ <sub>JT</sub>	Junction-to-top characterization parameter	3.8	3.9	°C/W

## 6.4 Thermal Information (续)

THERMAL METRIC <sup>(1)</sup>		DEVICE		UNIT
		TPS6282x, JEDEC	TPS62826EVM-794	
		6 pins	6 pins	
$\psi_{JB}$	Junction-to-board characterization parameter	33.1	38.6	°C/W

- (1) For more information about traditional and new thermal metrics, see the [Semiconductor and IC Package Thermal Metrics](#) application report.
- (2) Not applicable to an EVM.

## 6.5 Electrical Characteristics

$T_J = -40\text{ °C}$  to  $125\text{ °C}$ , and  $V_{IN} = 2.4\text{ V}$  to  $5.5\text{ V}$ . Typical values are at  $T_J = 25\text{ °C}$  and  $V_{IN} = 5\text{ V}$ , unless otherwise noted.

PARAMETER		TEST CONDITIONS	MIN	TYP	MAX	UNIT
<b>SUPPLY</b>						
$I_Q$	Quiescent current	EN = High, no load, device not switching		4	10	$\mu\text{A}$
$I_Q$	Quiescent current	EN = High, no load, FPWM devices		8		$\text{mA}$
$I_{SD}$	Shutdown current	EN = Low, $T_J = -40\text{ °C}$ to $85\text{ °C}$		0.05	0.5	$\mu\text{A}$
$V_{UVLO}$	Under voltage lock out threshold	$V_{IN}$ falling	2.1	2.2	2.3	V
	Under voltage lock out hysteresis	$V_{IN}$ rising		160		mV
$T_{JSD}$	Thermal shutdown threshold	$T_J$ rising		150		°C
	Thermal shutdown hysteresis	$T_J$ falling		20		°C
<b>LOGIC INTERFACE EN</b>						
$V_{IH}$	High-level threshold voltage		1.0			V
$V_{IL}$	Low-level threshold voltage				0.4	V
$I_{EN,LKG}$	Input leakage current into EN pin	EN = High		0.01	0.1	$\mu\text{A}$
<b>SOFT START, POWER GOOD</b>						
$t_{SS}$	Soft start time	Time from EN high to 95% of $V_{OUT}$ nominal, TPS62827		1.75		ms
		Time from EN high to 95% of $V_{OUT}$ nominal, TPS62824x/5x/6x/7A		1.25		ms
$V_{PG}$	Power good lower threshold	$V_{PG}$ rising, $V_{FB}$ referenced to $V_{FB}$ nominal	94	96	98	%
		$V_{PG}$ falling, $V_{FB}$ referenced to $V_{FB}$ nominal	90	92	94	%
	Power good upper threshold	$V_{PG}$ rising, $V_{FB}$ referenced to $V_{FB}$ nominal	108	110	112	%
		$V_{PG}$ falling, $V_{FB}$ referenced to $V_{FB}$ nominal	103	105	107	%
$V_{PG,OL}$	Low-level output voltage	$I_{sink} = 1\text{ mA}$			0.4	V
$I_{PG,LKG}$	Input leakage current into PG pin	$V_{PG} = 5.0\text{ V}$		0.01	0.1	$\mu\text{A}$
$t_{PG,DLY}$	Power good deglitch delay	PG rising edge		100		$\mu\text{s}$
		PG falling edge		20		
<b>OUTPUT</b>						
$V_{OUT}$	Output voltage accuracy	TPS6282533, PWM mode	3.267	3.3	3.333	V
$V_{OUT}$	Output voltage accuracy	TPS6282x18, PWM mode	1.78	1.8	1.82	V
$V_{FB}$	Feedback regulation voltage	PWM mode	594	600	606	mV
$I_{FB,LKG}$	Feedback input leakage current for adjustable output voltage	$V_{FB} = 0.6\text{ V}$		0.01	0.05	$\mu\text{A}$
$R_{FB}$	Internal resistor divider connected to FB pin, for fixed output voltage	TPS6282518, TPS6282618, TPS6282533		7.5		$\text{M}\Omega$
$I_{DIS}$	Output discharge current	$V_{SW} = 0.4\text{ V}$ ; EN = LOW	75	400		$\text{mA}$
	Load regulation	$I_{OUT} = 0.5\text{ A}$ to $3\text{ A}$ , $V_{OUT} = 1.8\text{ V}$		0.1		%/A
<b>POWER SWITCH</b>						
$R_{DS(on)}$	High-side FET on-resistance			26		$\text{m}\Omega$
	Low-side FET on-resistance			25		$\text{m}\Omega$

## 6.5 Electrical Characteristics (续)

$T_J = -40\text{ }^\circ\text{C}$  to  $125\text{ }^\circ\text{C}$ , and  $V_{IN} = 2.4\text{ V}$  to  $5.5\text{ V}$ . Typical values are at  $T_J = 25\text{ }^\circ\text{C}$  and  $V_{IN} = 5\text{ V}$ , unless otherwise noted.

PARAMETER		TEST CONDITIONS	MIN	TYP	MAX	UNIT
$I_{LIM}$	High-side FET switch current limit, DC	TPS62824A	1.7	2.1	2.4	A
		TPS62825x	2.74	3.3	3.9	A
		TPS62826x	3.7	4.3	5.0	A
		TPS62827x	4.8	5.6	6.4	A
$I_{LIM}$	Low-side FET negative current limit, DC	TPS62824A/5A/6A/7A	- 1.6		A	
$f_{SW}$	PWM switching frequency	$I_{OUT} = 1\text{ A}$ , $V_{OUT} = 1.8\text{ V}$	2.2		MHz	



### 6.6 Typical Characteristics



图 6-1. High-Side FET On-Resistance



图 6-2. Low-Side FET On-Resistance

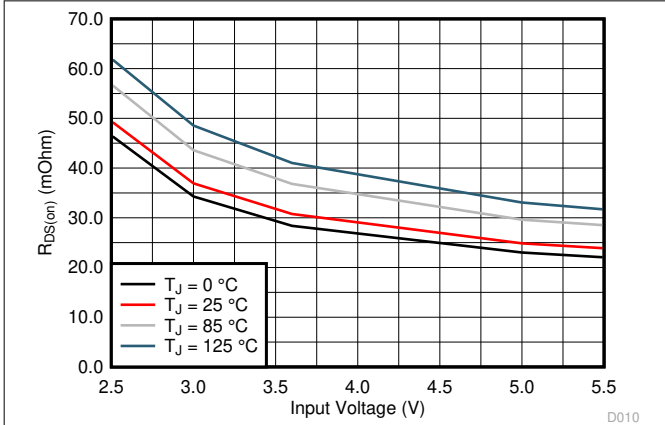

图 6-3. Shutdown Current

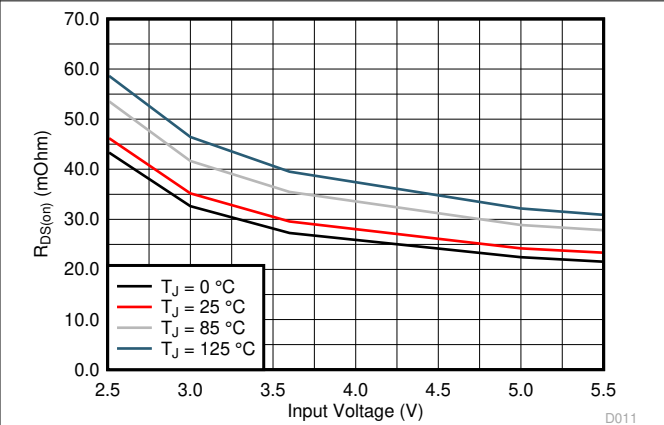

图 6-4. Quiescent Current

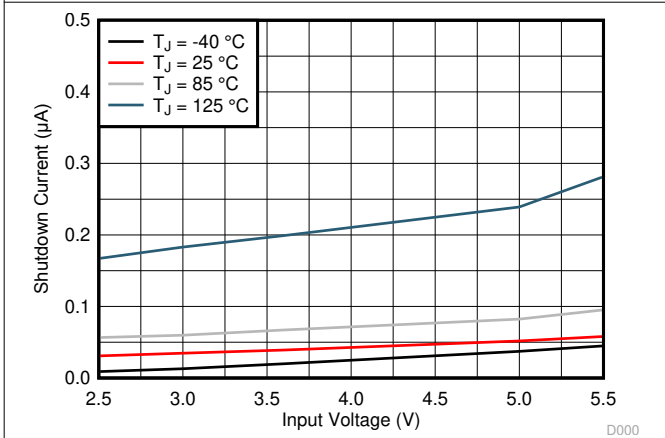

图 6-5. Output Discharge Current

## 7 Detailed Description

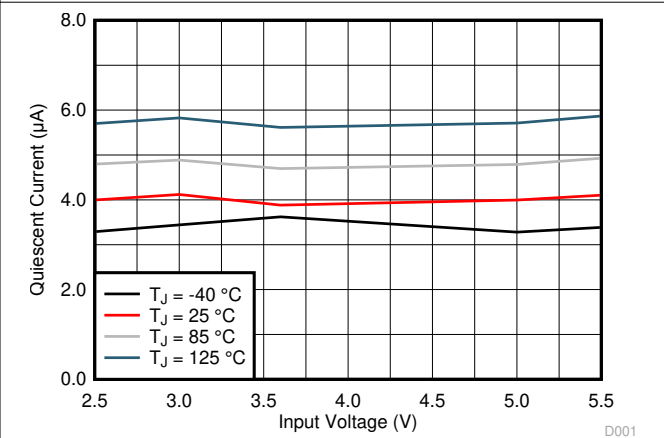
### 7.1 Overview

The TPS6282x are synchronous step-down converters based on the DCS-Control topology with an adaptive constant on-time control and a stabilized switching frequency. The devices operate in PWM (pulse width modulation) mode for medium to heavy loads and in PSM (power save mode) at light load conditions, keeping the output voltage ripple small. The nominal switching frequency is about 2.2MHz with a small and controlled variation over the input voltage range. As the load current decreases, the converter enters PSM, reducing the switching frequency to keep efficiency high over the entire load current range. Because combining both PWM and PSM within a single building block, the transition between modes is seamless and without effect on the output voltage. In forced-PWM devices, the converter maintains a continuous conduction mode operation and keeps the output voltage ripple very low across the whole load range and at a nominal switching frequency of 2.2MHz. The devices offer both excellent dc voltage and fast load transient regulation, combined with a very low output voltage ripple.

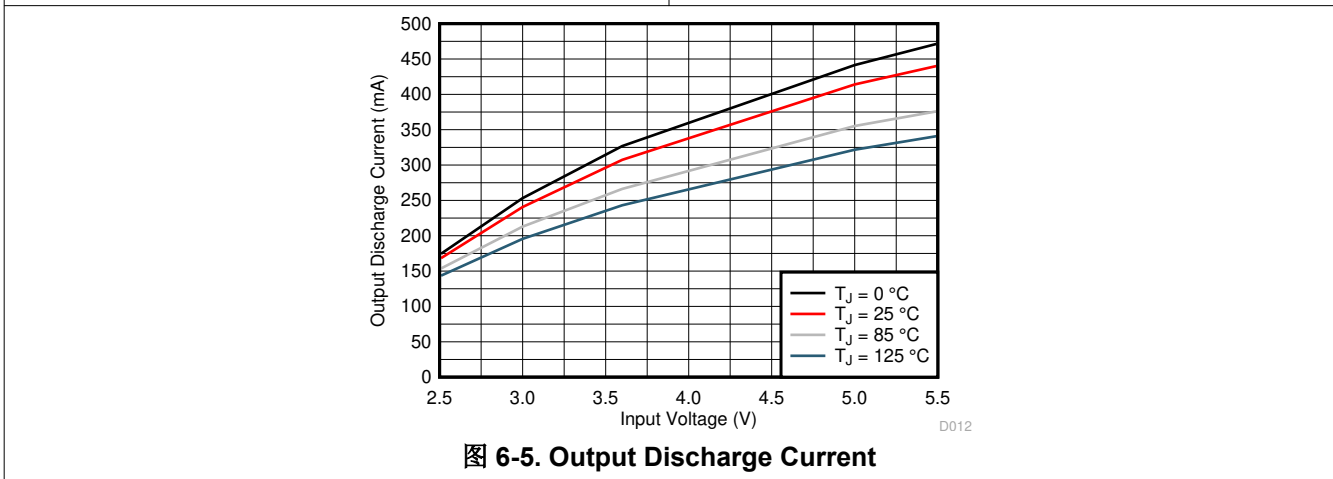
### 7.2 Functional Block Diagram

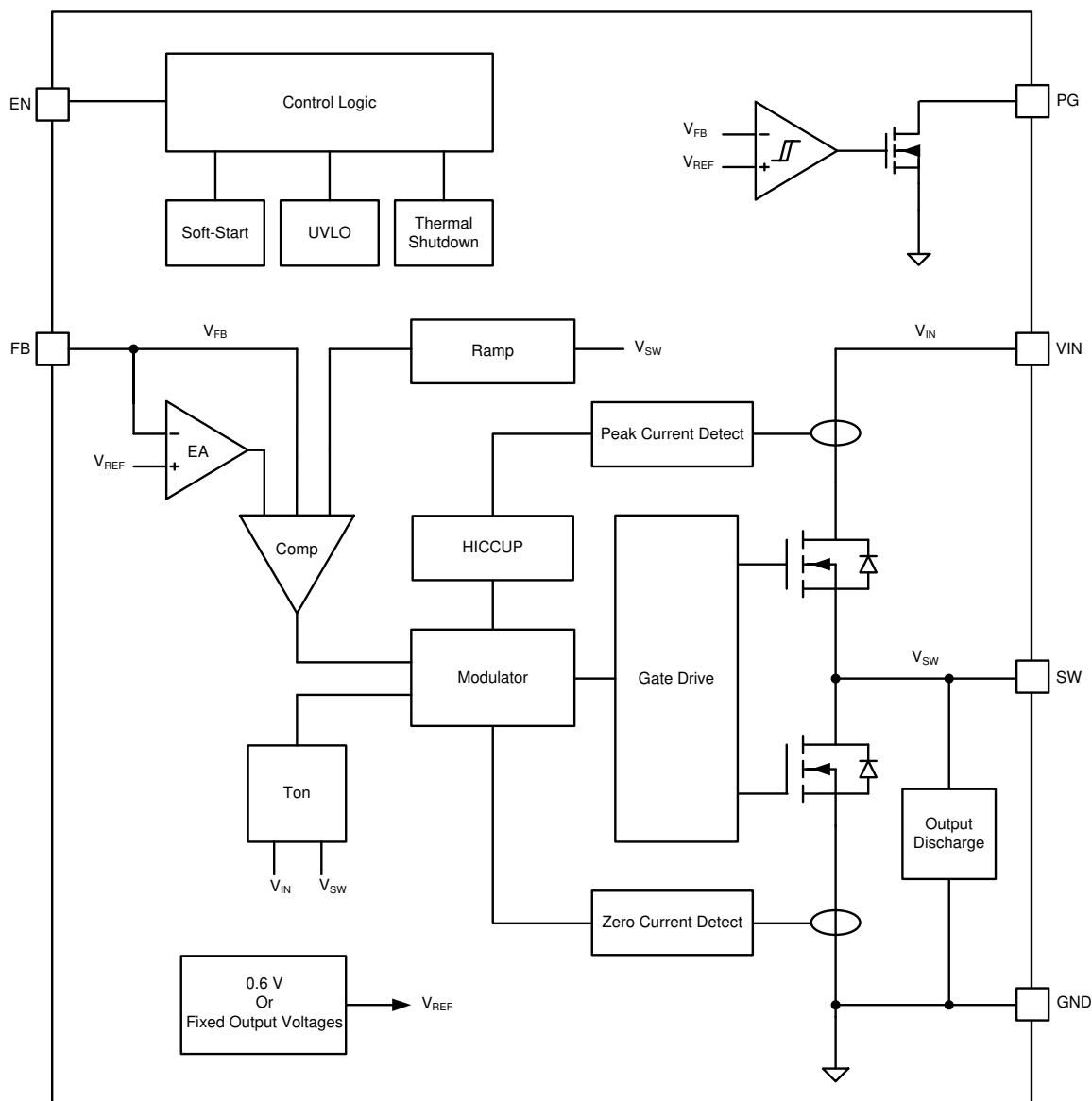



## 7.3 Feature Description

### 7.3.1 Pulse Width Modulation (PWM) Operation

At load currents larger than half the inductor ripple current, the device operates in pulse width modulation in continuous conduction mode (CCM). The PWM operation is based on an adaptive constant on-time control with stabilized switching frequency. To achieve a stable switching frequency in a steady state condition, the on-time is calculated as:

$$T_{ON} = \frac{V_{OUT}}{V_{IN}} \times 450ns \quad (1)$$

In forced-PWM devices, the device always operates in pulse width modulation in continuous conduction mode (CCM).

### 7.3.2 Power Save Mode (PSM) Operation

To maintain high efficiency at light loads, the device enters power save mode (PSM) at the boundary to discontinuous conduction mode (DCM). This event happens when the output current becomes smaller than half of the ripple current of the inductor. The device operates now with a fixed on-time and the switching frequency further decreases proportional to the load current. Use the following equation to calculate:

$$f_{PSM} = \frac{2 \times I_{OUT}}{T_{ON}^2 \times \frac{V_{IN}}{V_{OUT}} \left[ \frac{V_{IN} - V_{OUT}}{L} \right]} \quad (2)$$

In PSM, the output voltage rises slightly above the nominal target, which can be minimized using larger output capacitance. At duty cycles larger than 90%, the device can not enter PSM. The device maintains output regulation in PWM mode.

### 7.3.3 Minimum Duty Cycle and 100% Mode Operation

There is no limitation for small duty cycles, because even at very low duty cycles, the switching frequency is reduced as needed to always make sure of a proper regulation.

If the output voltage level comes close to the input voltage, the device enters 100% mode. While the high-side switch is constantly turned on, the low-side switch is switched off. The difference between VIN and VOUT is determined by the voltage drop across the high-side FET and the DC resistance of the inductor. The minimum VIN that is needed to maintain a specific VOUT value is estimated as:

$$V_{IN,min} = V_{OUT} + I_{OUT,MAX} \times (R_{DS(on)} + R_L) \quad (3)$$

where

- $V_{IN,MIN}$  = Minimum input voltage to maintain an output voltage
- $I_{OUT,MAX}$  = Maximum output current
- $R_{DS(on)}$  = High-side FET ON-resistance
- $R_L$  = Inductor ohmic resistance (DCR)

### 7.3.4 Soft Start

About 250  $\mu$ s after EN goes High, the internal soft-start circuitry controls the output voltage during start-up. This action avoids excessive inrush current and makes sure of a controlled output voltage ramp. This action also prevents unwanted voltage drops from high-impedance power sources or batteries. The TPS6282x can start into a prebiased output.

### 7.3.5 Switch Current Limit and HICCUP Short-Circuit Protection

The switch current limit prevents the device from drawing excessive current in case of externally-caused overcurrent or short-circuit condition. Due to an internal propagation delay (typically 60ns), the actual AC peak current can exceed the static current limit during that time.

If the current limit threshold is reached, the device delivers maximum output current. Detecting this condition for 32 switching cycles (about 13  $\mu$ s), the device turns off the high-side MOSFET for about 100  $\mu$ s which allows the inductor current to decrease through the low-side MOSFET body diode and then restarts again with a soft start cycle. As long as the overload condition is present, the device hiccups that way, limiting the output power.

In forced PWM devices, a negative current limit ( $I_{LIMN}$ ) is enabled to prevent excessive current flowing backwards to the input. When the inductor current reaches  $I_{LIMN}$ , the low-side MOSFET turns off and the high-side MOSFET turns on and kept on until  $T_{ON}$  time expires.

### 7.3.6 Undervoltage Lockout

The undervoltage lockout (UVLO) function prevents misoperation of the device if the input voltage drops below the UVLO threshold. The undervoltage lockout is set to about 2.2V with a hysteresis of typically 160mV.

### 7.3.7 Thermal Shutdown

The junction temperature ( $T_J$ ) of the device is monitored by an internal temperature sensor. If  $T_J$  exceeds 150°C (typ.), the device goes in thermal shutdown with a hysteresis of typically 20°C. After  $T_J$  has decreased enough, the device resumes normal operation.

## 7.4 Device Functional Modes

### 7.4.1 Enable, Disable, and Output Discharge

The device starts operation when Enable (EN) is set High. The input threshold levels are typically 0.9V for rising and 0.7V for falling signals. Do not leave EN floating. Shutdown is forced if EN is pulled Low with a shutdown current of typically 50nA. During shutdown, the internal power MOSFETs as well as the entire control circuitry are turned off and the output voltage is actively discharged through the SW pin by a current sink. Therefore VIN must remain present for the discharge to function.

### 7.4.2 Power Good

The TPS6282x has a built-in power-good (PG) function. The PG pin goes high impedance when the output voltage has reached the nominal value. Otherwise, including when disabled, in UVLO or in thermal shutdown, PG is Low (see 表 7-1). The PG function is formed with a window comparator, which has an upper and lower voltage threshold. The PG pin is an open-drain output and is specified to sink up to 1mA. The power-good output requires a pullup resistor connecting to any voltage rail less than 5.5V.

The PG signal can be used for sequencing of multiple rails by connecting it to the EN pin of other converters. Leave the PG pin unconnected when not used. The PG rising edge has a 100 $\mu$ s blanking time and the PG falling edge has a deglitch delay of 20 $\mu$ s.

表 7-1. PG Pin Logic

DEVICE CONDITIONS		LOGIC STATUS	
		HIGH Z	LOW
Enable	EN = High, $V_{FB} \geq 0.576V$	✓	
	EN = High, $V_{FB} \leq 0.552V$		✓
	EN = High, $V_{FB} \leq 0.63V$	✓	
	EN = High, $V_{FB} \geq 0.66V$		✓
Shutdown	EN = Low		✓
Thermal Shutdown	$T_J > T_{JSD}$		✓
UVLO	$0.7V < V_{IN} < V_{UVLO}$		✓



表 7-1. PG Pin Logic (续)

DEVICE CONDITIONS		LOGIC STATUS	
		HIGH Z	LOW
Power Supply Removal	$V_{IN} < 0.7V$	✓	

## 8 Application and Implementation

### 备注

以下应用部分中的信息不属于 TI 器件规格的范围，TI 不承担其准确性和完整性。TI 的客户应负责确定器件是否适用于其应用。客户应验证并测试其设计，以确保系统功能。

### 8.1 Application Information

The following section discusses the design of the external components to complete the power supply design for several input and output voltage options by using typical applications as a reference.

### 8.2 Typical Application



图 8-1. Typical Application of TPS62826x



图 8-2. Typical Application of TPS62827

#### 8.2.1 Design Requirements

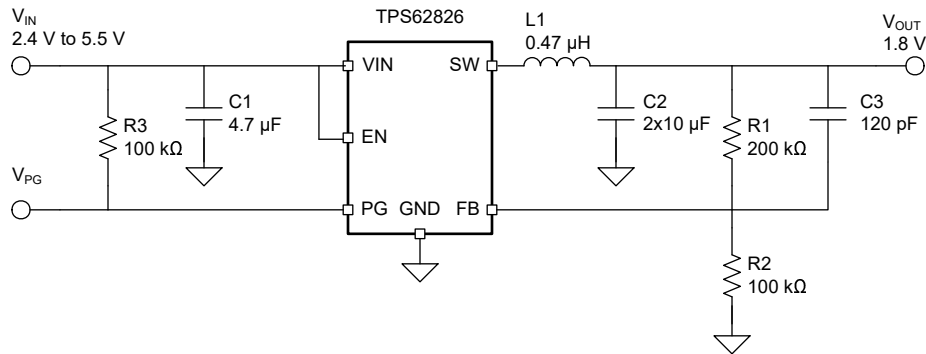
For this design example, use the parameters listed in 表 8-1 as the input parameters.

表 8-1. Design Parameters

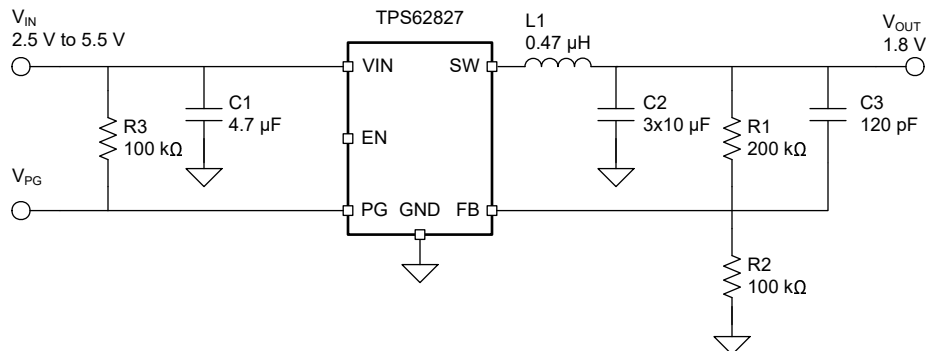
DESIGN PARAMETER	EXAMPLE VALUE
Input voltage, TPS62826x	2.4V to 5.5V
Input voltage, TPS62827x	2.5V to 5.5V
Output voltage	1.8V
Output ripple voltage	< 20mV
Maximum output current, TPS62826x	3A
Maximum output current, TPS62827x	4A

表 8-2 lists the components used for the example.

**表 8-2. List of Components**

REFERENCE	DESCRIPTION	MANUFACTURER
C1	4.7μF, Ceramic capacitor, 6.3V, X7R, size 0603, JMK107BB7475MA	Taiyo Yuden
C2, TPS62824x/5x/6x/7A	2 × 10μF, Ceramic capacitor, 10V, X7R, size 0603, GRM188Z71A106MA73D	Murata
C2, TPS62827	3 × 10μF, Ceramic capacitor, 10V, X7R, size 0603, GRM188Z71A106MA73D	Murata
C3	120pF, Ceramic capacitor, 50V, size 0402	Std
L1	0.47μH, Power Inductor, XFL4015-471MEB	Coilcraft
R1	Depending on the output voltage, 1%, size 0402	Std
R2	100k Ω, Chip resistor, 1/16W, 1%, size 0402	Std
R3	100k Ω, Chip resistor, 1/16W, 1%, size 0402	Std

## 8.2.2 Detailed Design Procedure

### 8.2.2.1 Custom Design With WEBENCH® Tools

[Click here](#) to create a custom design using the TPS6282x device with the WEBENCH® Power Designer.

1. Start by entering the input voltage ( $V_{IN}$ ), output voltage ( $V_{OUT}$ ), and output current ( $I_{OUT}$ ) requirements.
2. Optimize the design for key parameters such as efficiency, footprint, and cost using the optimizer dial.
3. Compare the generated design with other possible solutions from Texas Instruments.

The WEBENCH Power Designer provides a customized schematic along with a list of materials with real-time pricing and component availability.

In most cases, these actions are available:

- Run electrical simulations to see important waveforms and circuit performance
- Run thermal simulations to understand board thermal performance
- Export customized schematic and layout into popular CAD formats
- Print PDF reports for the design, and share the design with colleagues

Get more information about WEBENCH tools at [www.ti.com/WBENCH](http://www.ti.com/WBENCH).

### 8.2.2.2 Setting The Output Voltage

The output voltage is set by an external resistor divider according to [方程式 4](#):

$$R1 = R2 \times \left( \frac{V_{OUT}}{V_{FB}} - 1 \right) = R2 \times \left( \frac{V_{OUT}}{0.6V} - 1 \right) \quad (4)$$

R2 must not be higher than 100k Ω to achieve high efficiency at light load while providing acceptable noise sensitivity. [方程式 5](#) shows how to compute the value of the feedforward capacitor for a given R2 value. For the recommended 100k value for R2, a 120pF feedforward capacitor is used.

$$C3 = \frac{12\mu}{R2} \quad (5)$$

For the fixed output voltage versions, connect the FB pin to the output. R1, R2, and C3 are not needed. The fixed output voltage devices have an internal feedforward capacitor.

### 8.2.2.3 Output Filter Design

The inductor and the output capacitor together provide a low-pass filter. To simplify this process, [表 8-3](#) outlines possible inductor and capacitor value combinations for most applications. Checked cells represent combinations that are proven for stability by simulation and lab test. check further combinations for each individual application.

**表 8-3. Matrix of Output Capacitor and Inductor Combinations, TPS62824x, TPS62825x, TPS62826x, and TPS62827A**

NOMINAL L [ $\mu$ H] <sup>(2)</sup>	NOMINAL C <sub>OUT</sub> [ $\mu$ F] <sup>(3)</sup>			
	10	2 × 10 or 22	47	100
0.33				
0.47	+	+(1)	+	
1.0				

- (1) This LC combination is the standard value and recommended for most applications.  
 (2) Inductor tolerance and current derating is anticipated. The effective inductance can vary by 20% and - 30%.  
 (3) Capacitance tolerance and bias voltage derating is anticipated. The effective capacitance can vary by 20% and - 35%.

**表 8-4. Matrix of Output Capacitor and Inductor Combinations, TPS62827**

NOMINAL L [ $\mu$ H] <sup>(2)</sup>	NOMINAL C <sub>OUT</sub> [ $\mu$ F] <sup>(3)</sup>			
	22	3 × 10	47	100
0.33				
0.47		+(1)	+	+
1.0				

### 8.2.2.4 Inductor Selection

The main parameter for the inductor selection is the inductor value and then the saturation current of the inductor. To calculate the maximum inductor current under static load conditions, 方程式 6 is given.

$$I_{L,MAX} = I_{OUT,MAX} + \frac{\Delta I_L}{2} \tag{6}$$

$$\Delta I_L = V_{OUT} \times \frac{1 - \frac{V_{OUT}}{V_{IN}}}{L \times f_{SW}}$$

where

- I<sub>OUT,MAX</sub> = Maximum output current
- $\Delta I_L$  = Inductor current ripple
- f<sub>SW</sub> = Switching frequency
- L = Inductor value

TI recommends to choose a saturation current for the inductor that is approximately 20% to 30% higher than I<sub>L,MAX</sub>. In addition, DC resistance and size must also be taken into account when selecting an appropriate inductor. 表 8-5 lists recommended inductors.

**表 8-5. List of Recommended Inductors**

INDUCTANCE [ $\mu$ H]	CURRENT RATING [A]	DIMENSIONS [L × W × H mm]	MAX. DC RESISTANCE [m $\Omega$ ]	MFR PART NUMBER <sup>(1)</sup>
0.47	4.8	2.0 × 1.6 × 1.0	32	HTEN20161T-R47MDR, Cyntec
	4.6	2.0 × 1.2 × 1.0	25	HTEH20121T-R47MSR, Cyntec
	4.8	2.0 × 1.6 × 1.0	32	DFE201610E - R47M, MuRata
	4.8	2.0 × 1.6 × 1.0	32	DFE201210S - R47M, MuRata
	5.1	2.0 × 1.6 × 1.0	34	TFM201610ALM-R47MTAA, TDK
	5.2	2.0 × 1.6 × 1.0	25	TFM201610ALC-R47MTAA, TDK
	6.6	4.0 × 4.0 × 1.6	8.36	XFL4015-471ME, Coilcraft
	8.0	3.5 × 3.2 × 2.0	10.85	XEL3520-471ME, Coilcraft
	6.8	4.5 × 4 × 1.8	11.2	WE-LHMI-744373240047, Würth

- (1) See the [Third-party Products Disclaimer](#).



### 8.2.2.5 Capacitor Selection

The input capacitor is the low-impedance energy source for the converters which helps provide stable operation. TI recommends a low-ESR multilayer ceramic capacitor for best filtering and must be placed between VIN and GND as close as possible to those pins. For most applications, a minimum effective input capacitance of 3 $\mu$ F must be present, though a larger value reduces input current ripple.

The architecture of the device allows the use of tiny ceramic output capacitors with low equivalent series resistance (ESR). These capacitors provide low output voltage ripple and are recommended. To keep the low resistance up to high frequencies and to get narrow capacitance variation with temperature, TI recommends using X7R or X5R dielectrics. Considering the DC-bias derating the capacitance, the minimum effective output capacitance is 10 $\mu$ F for TPS62824x, TPS62825x, TPS62826x, and TPS62827A and 20 $\mu$ F for TPS62827.

A feed forward capacitor is required for the adjustable version, as described in [Setting the Output Voltage](#). This capacitor is not required for the fixed output voltage versions.

### 8.2.3 Application Curves

$V_{IN} = 5.0V$ ,  $V_{OUT} = 1.8V$ ,  $T_A = 25^\circ C$ , BOM = 表 8-2, unless otherwise noted.

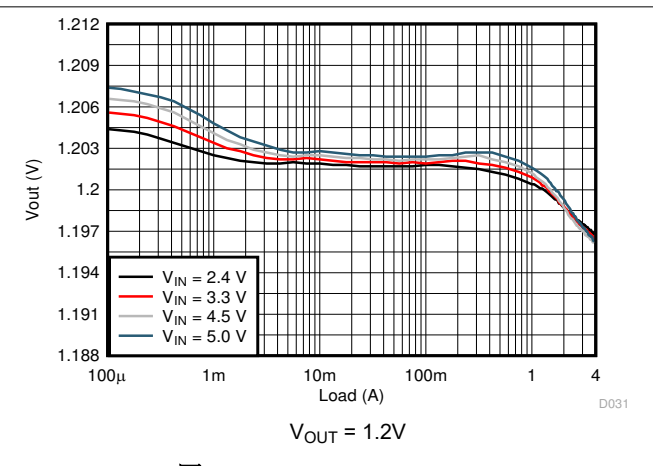
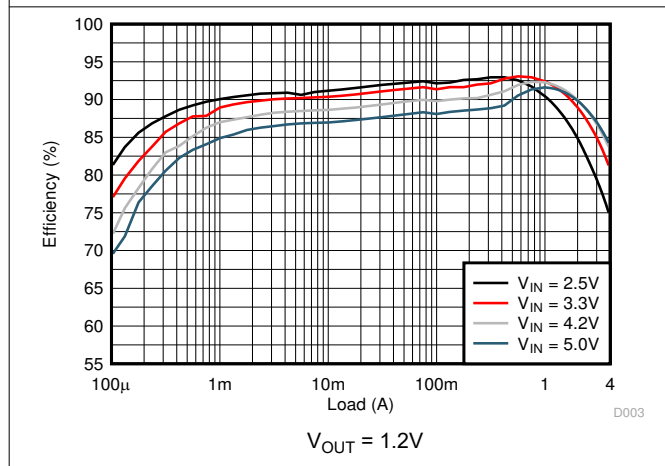
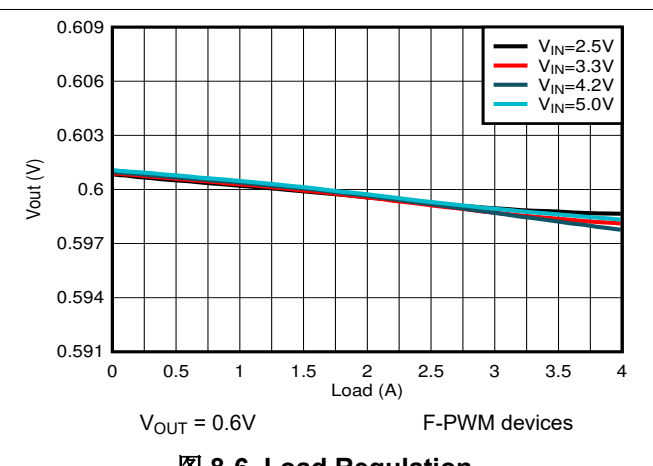
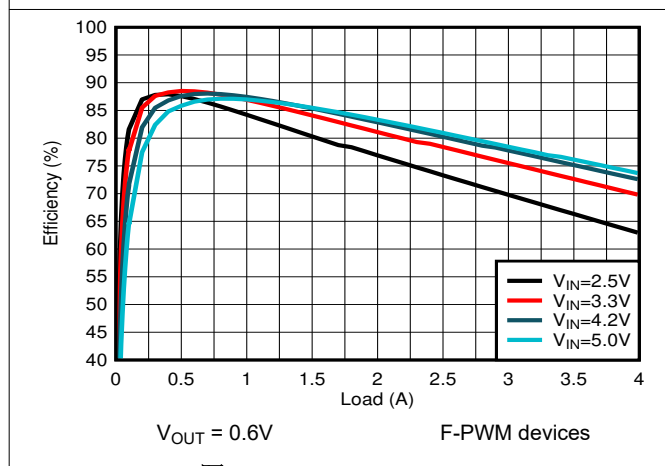
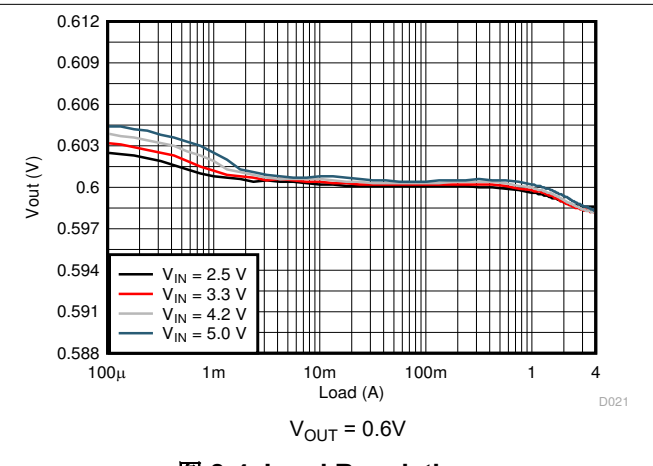
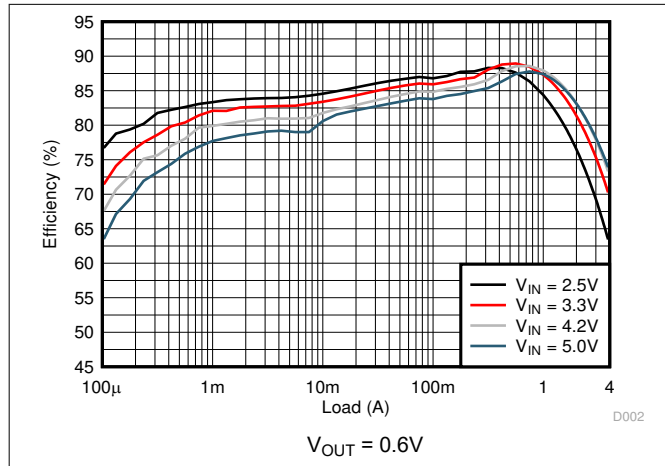





图 8-9. PWM Efficiency



图 8-10. Load Regulation

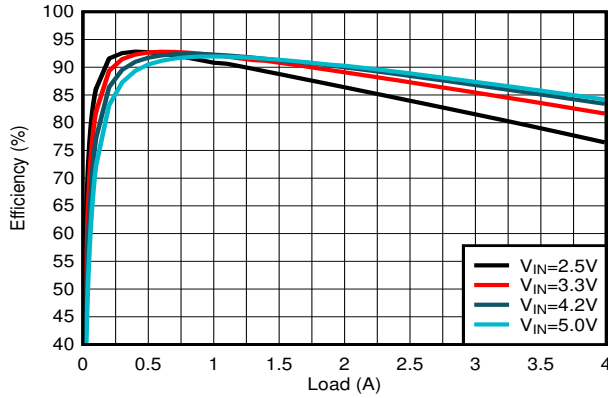

图 8-11. Efficiency

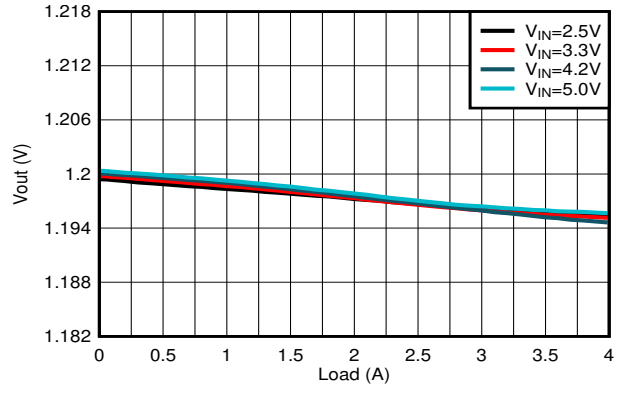

图 8-12. Load Regulation

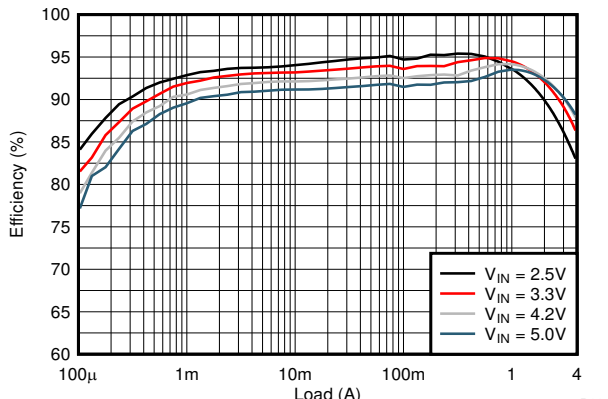

图 8-13. PWM Efficiency

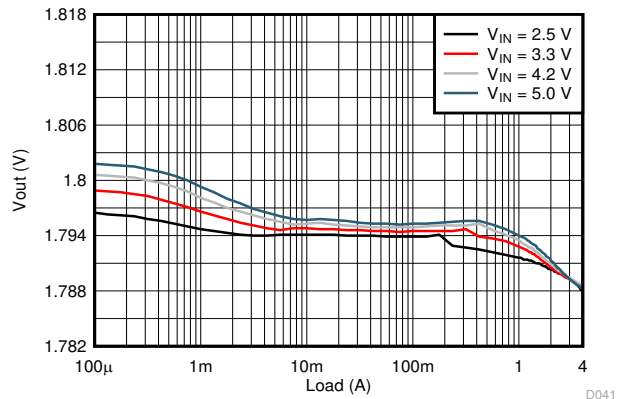

图 8-14. Load Regulation

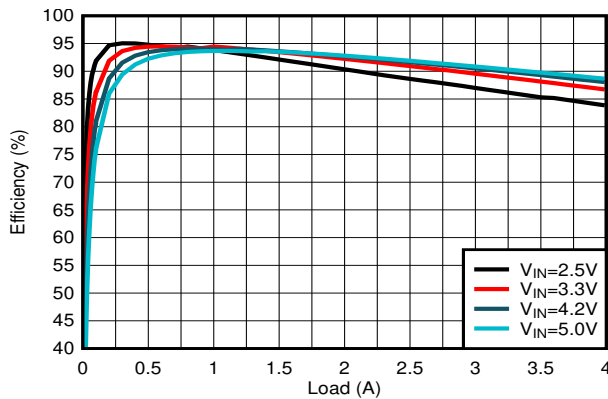

图 8-15. Efficiency

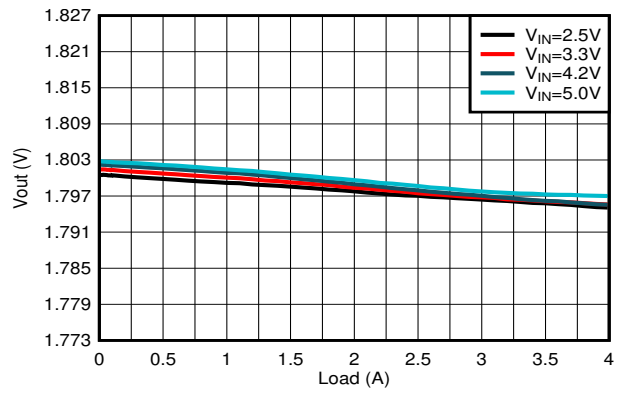

图 8-16. Load Regulation

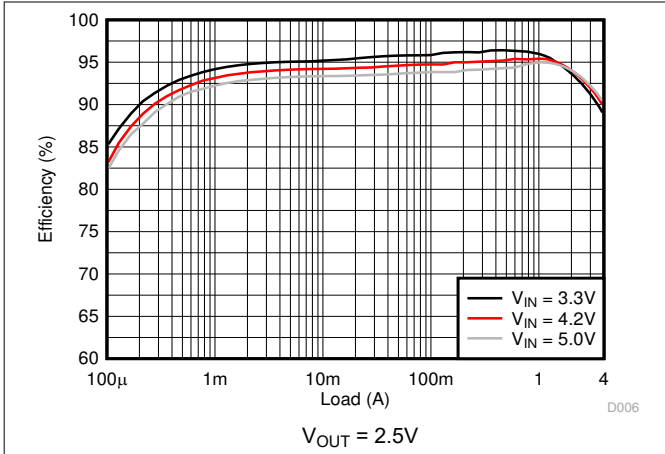

图 8-17. PWM Efficiency

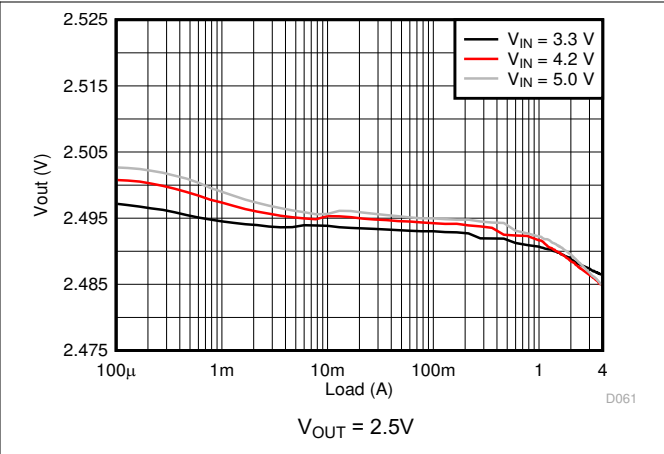

图 8-18. Load Regulation

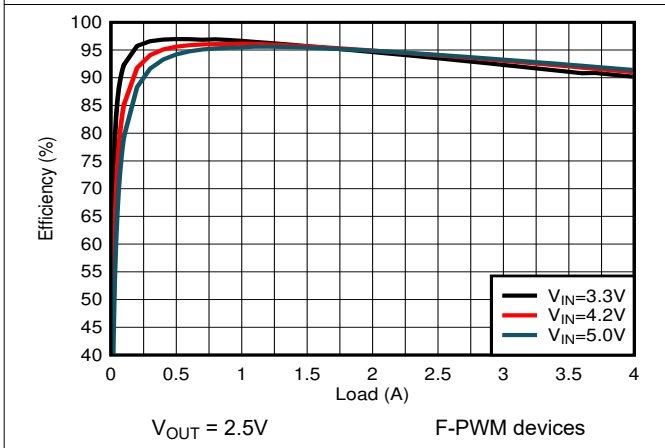

图 8-19. Efficiency

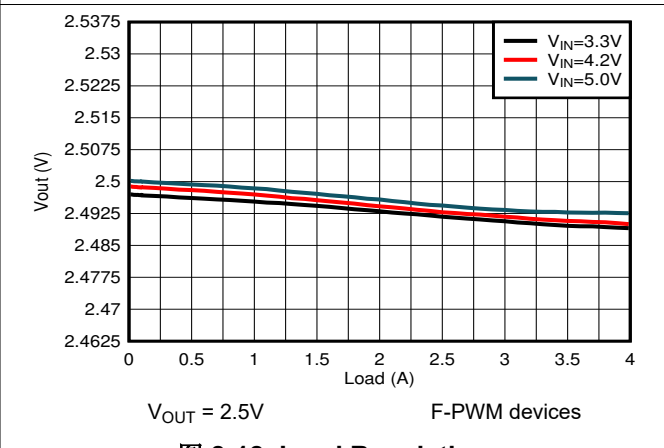

图 8-20. Load Regulation

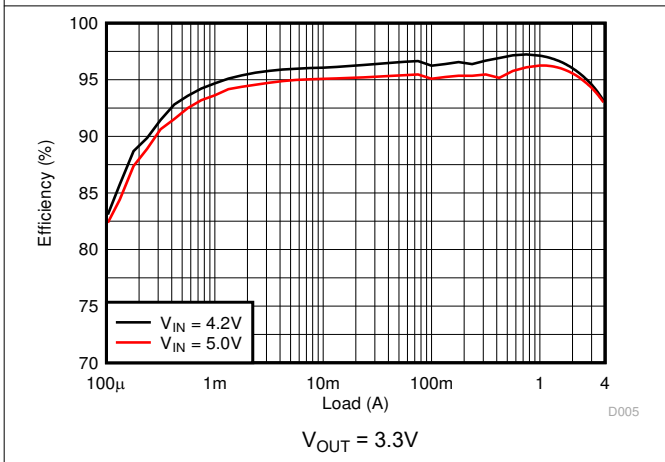

图 8-21. PWM Efficiency

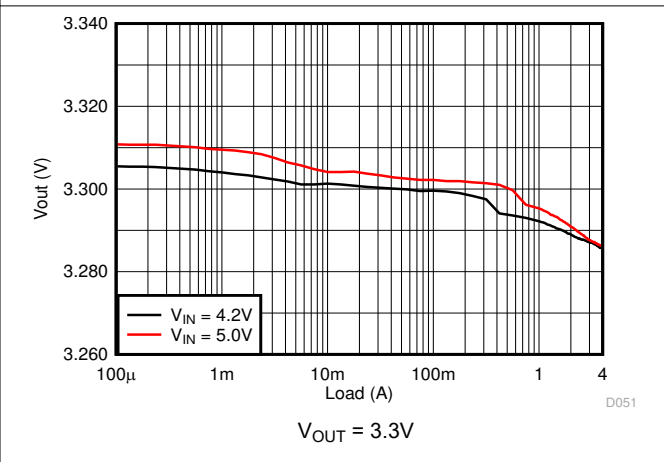

图 8-22. Load Regulation

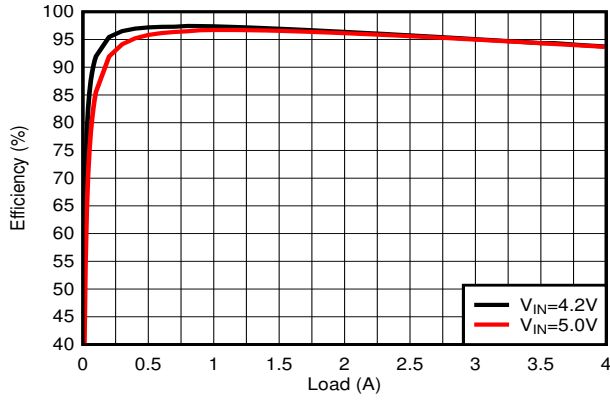

图 8-23. Switching Frequency

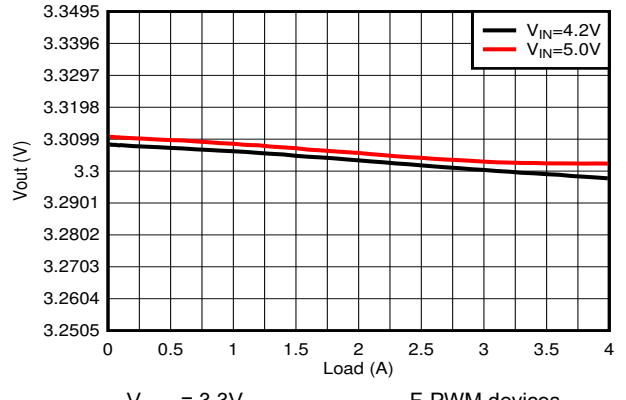

图 8-24. Switching Frequency

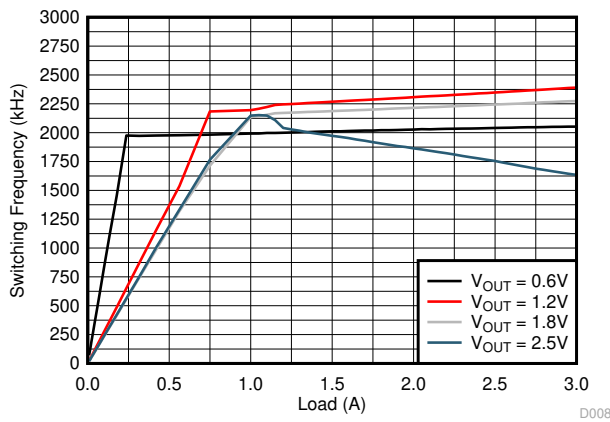

图 8-25. Switching Frequency

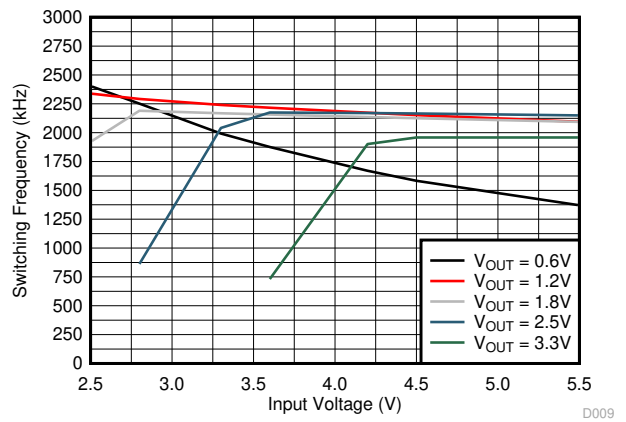

图 8-26. Switching Frequency

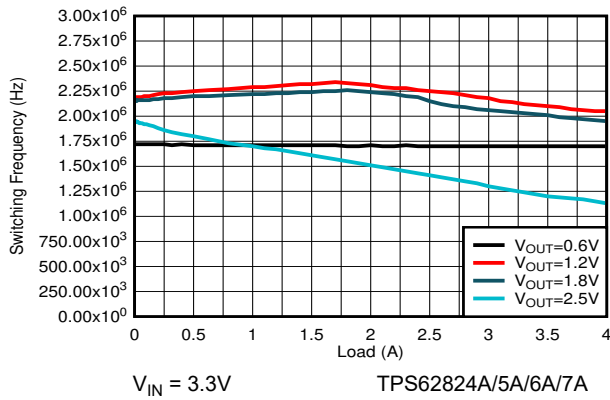

$V_{IN} = 3.3V$  TPS62827

图 8-27. Switching Frequency

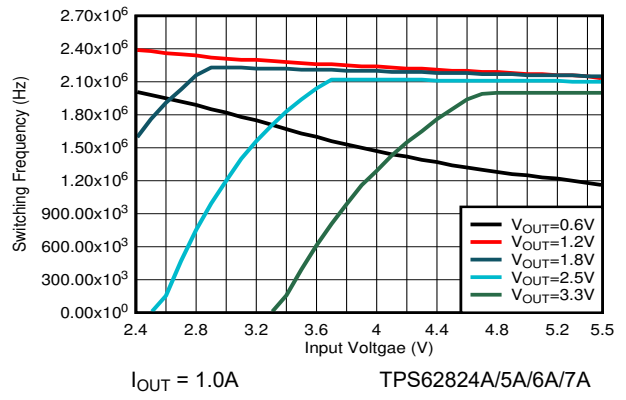
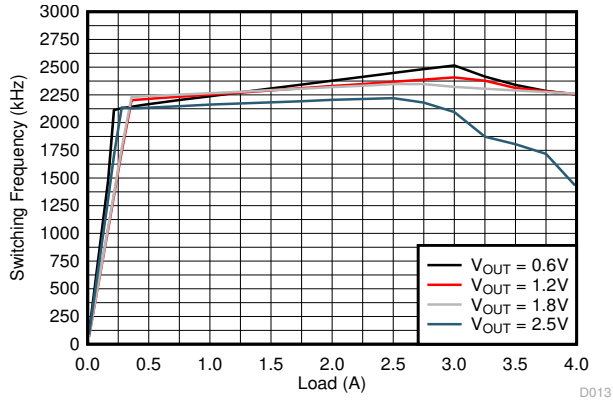
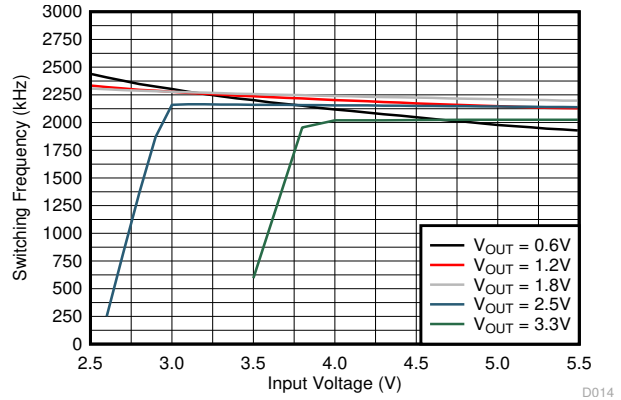

$I_{OUT} = 1.0A$  TPS62827

图 8-28. Switching Frequency

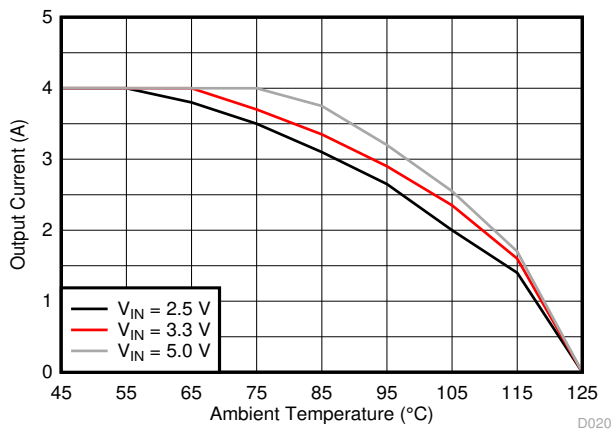

$V_{OUT} = 1.2V$   $\theta_{JA} = 71.4^{\circ}C/W$

图 8-29. Thermal Derating

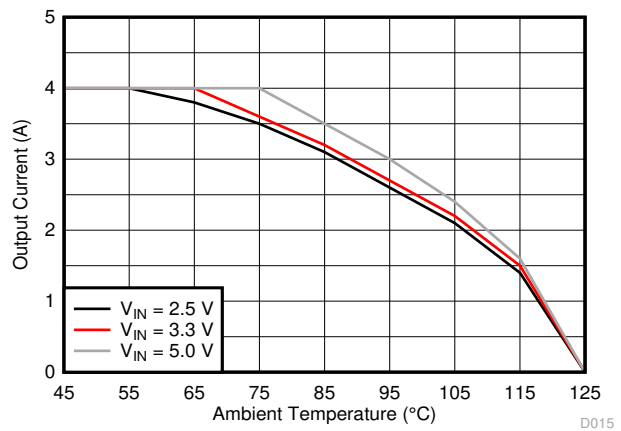

$V_{OUT} = 1.8V$   $\theta_{JA} = 71.4^{\circ}C/W$

图 8-30. Thermal Derating

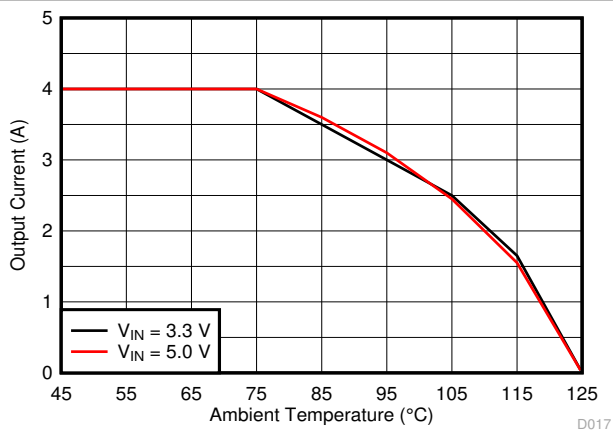

$V_{OUT} = 2.5V$   $\theta_{JA} = 71.4^{\circ}C/W$

图 8-31. Thermal Derating

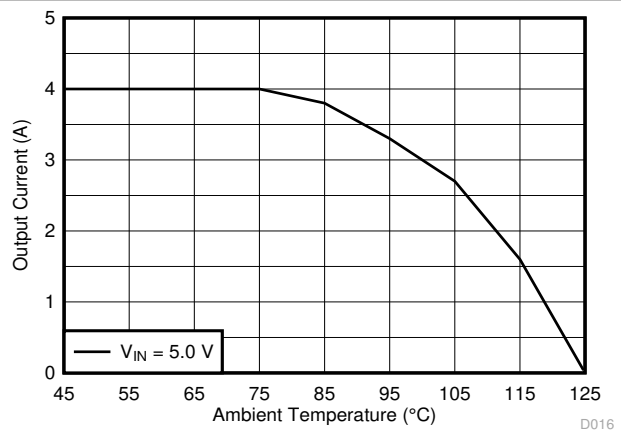

$V_{OUT} = 3.3V$   $\theta_{JA} = 71.4^{\circ}C/W$

图 8-32. Thermal Derating

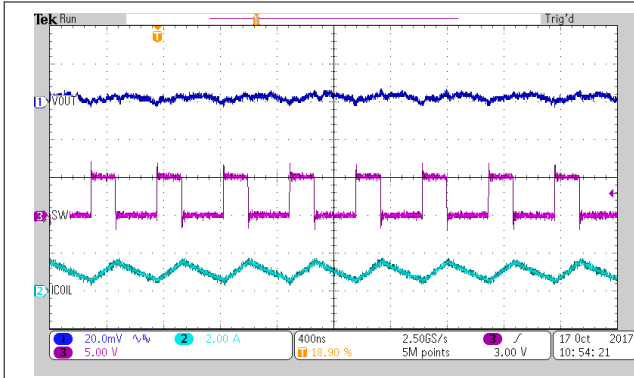

$I_{OUT} = 1.0A$  TPS62824/5/6/7

图 8-33. PWM Operation

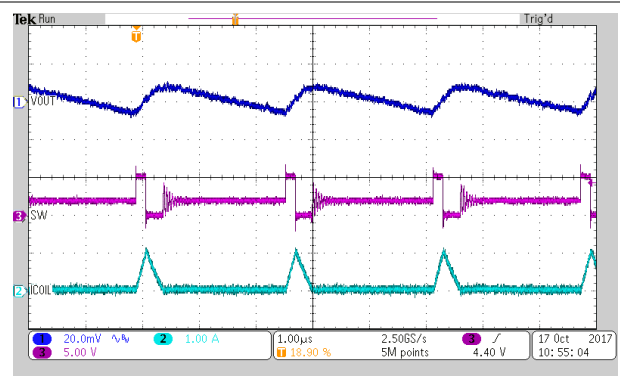

$I_{OUT} = 0.1A$  TPS62824/5/6/7

图 8-34. PSM Operation

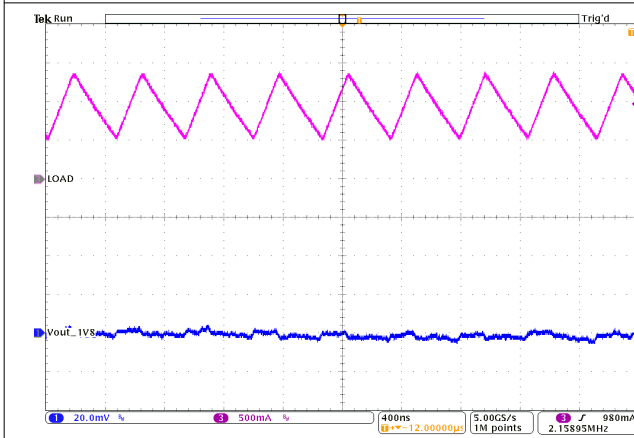

$I_{OUT} = 1.0A$  TPS62824A/5A/6A/7A

图 8-35. PWM Operation at F-PWM

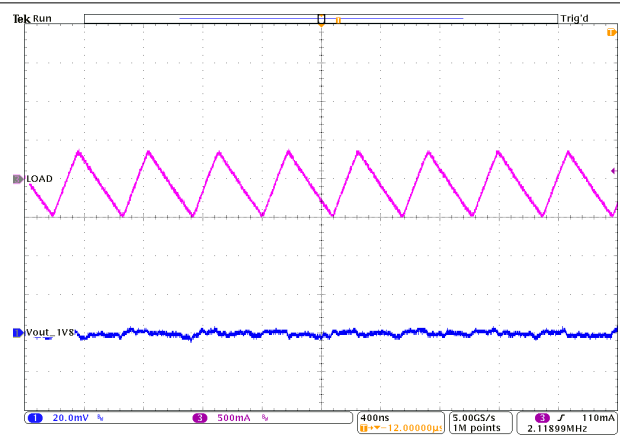

No load TPS62824A/5A/6A/7A

图 8-36. PWM Operation at F-PWM

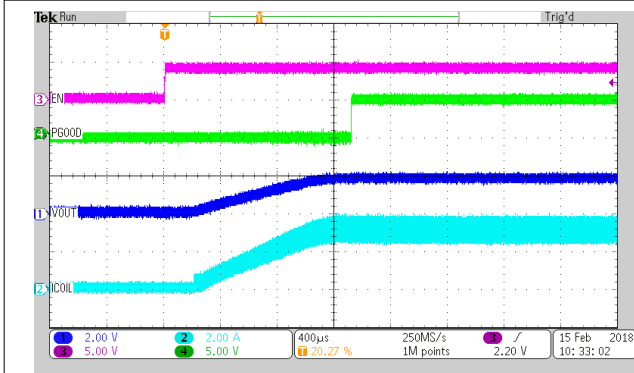

Load = 0.6Ω TPS62826

图 8-37. Start-Up With Load

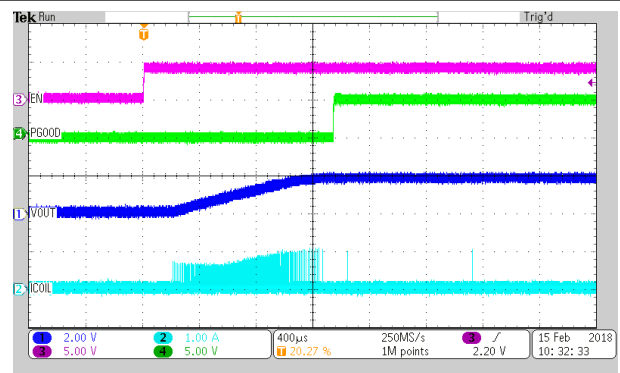

TPS62824/5/6

图 8-38. Start-Up With No Load

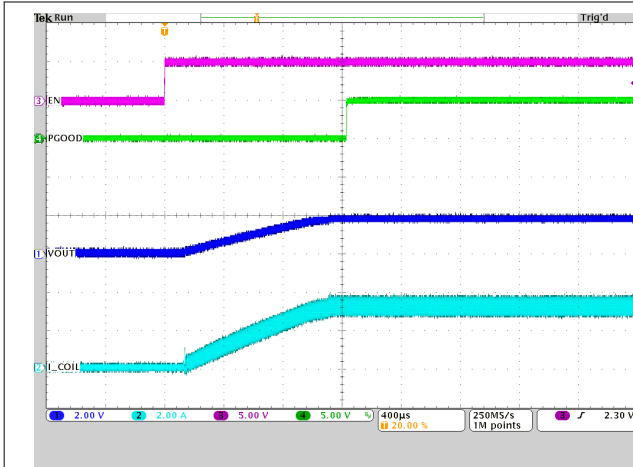

Load = 0.6 Ω TPS62826A/7A

图 8-39. Start-Up With Load

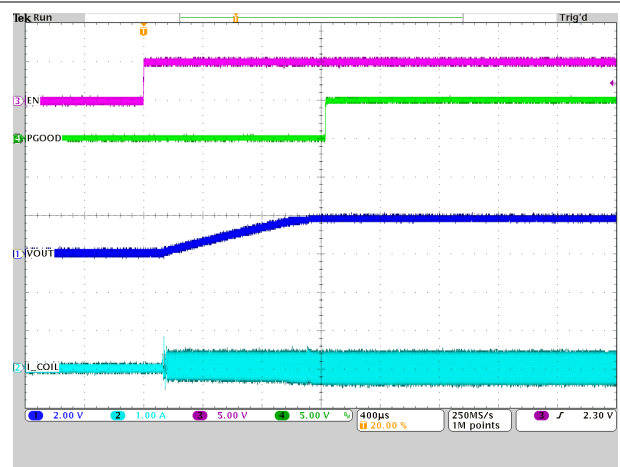

TPS62824A/5A/6A/7A

图 8-40. Start-Up With No Load

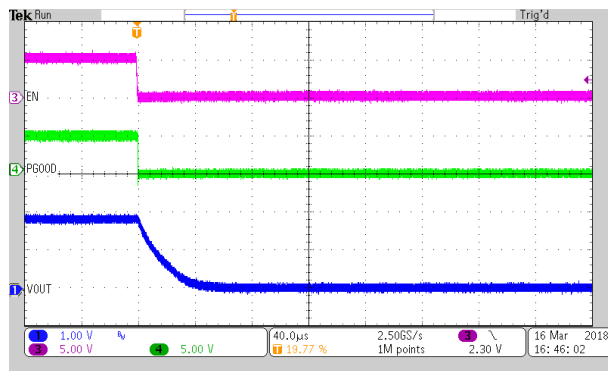

Load = 1.8 Ω TPS6282x

图 8-41. Disable, Active Output Discharge

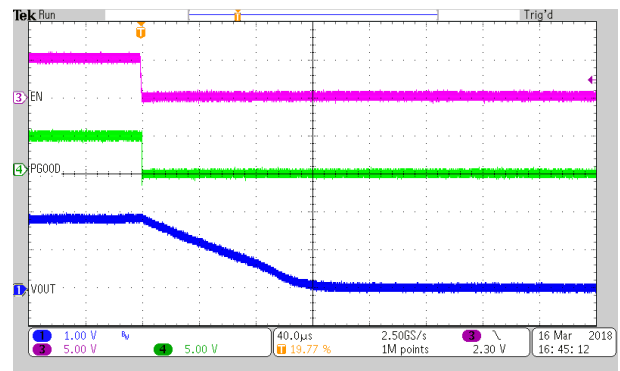

TPS6282x

图 8-42. Disable, Active Output Discharge at No Load

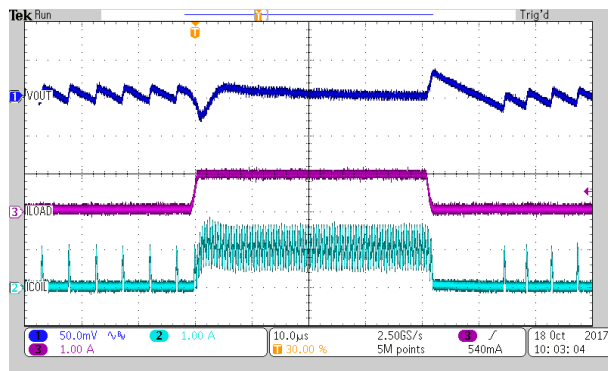

I<sub>OUT</sub> = 0.05A to 1A TPS62824/5/6/7

图 8-43. Load Transient

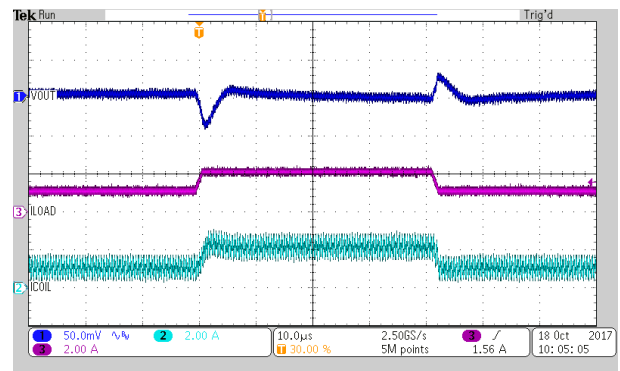

I<sub>OUT</sub> = 1A to 2A TPS62825/6/7

图 8-44. Load Transient

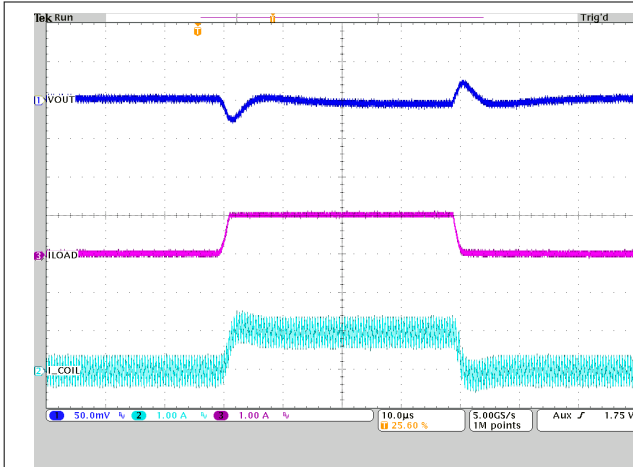

$I_{OUT} = 0.05A$  to  $1A$  TPS62824A/5A/6A/7A

图 8-45. Load Transient

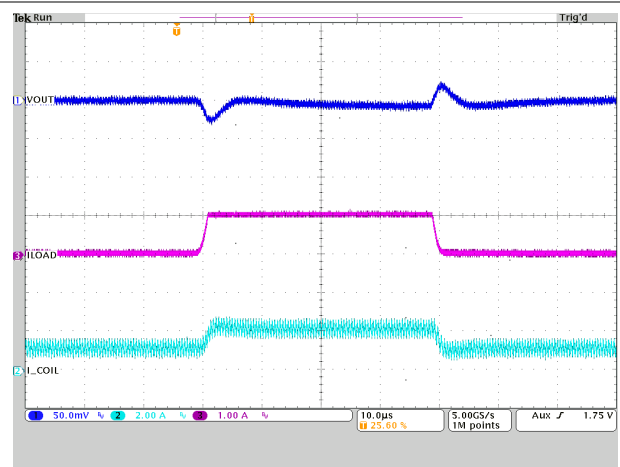

$I_{OUT} = 1A$  to  $2A$  TPS62825A/6A/7A

图 8-46. Load Transient

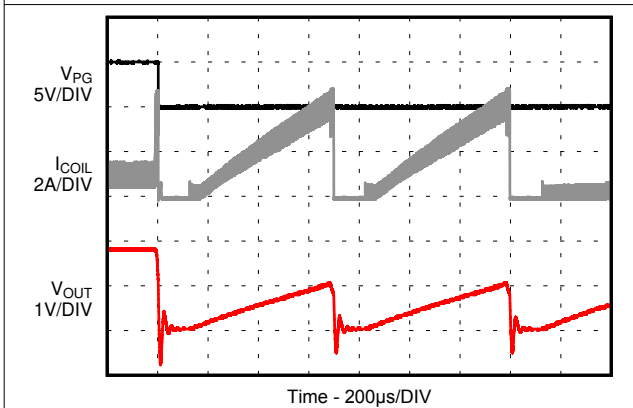

$I_{OUT} = 1A$  TPS6282x

图 8-47. HICCUP Short-Circuit Protection

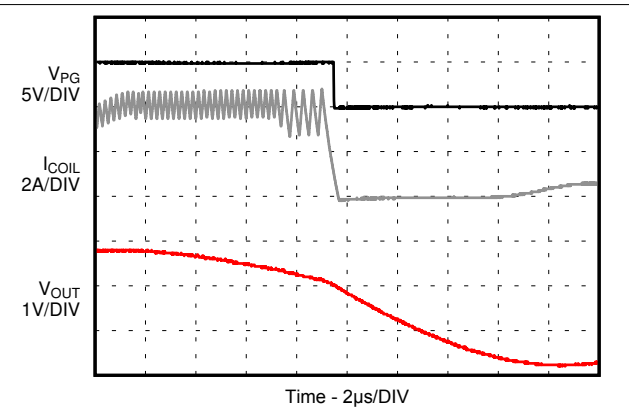

$I_{OUT} = 1A$  TPS6282x

图 8-48. HICCUP Short-Circuit Protection (Zoom In)

### 8.3 Power Supply Recommendations

The device is designed to operate from an input voltage supply range from 2.4V to 5.5V. Make sure that the input power supply has a sufficient current rating for the application.

### 8.4 Layout

#### 8.4.1 Layout Guidelines

The printed-circuit-board (PCB) layout is an important step to maintain the high performance of the device. See [Layout Example](#) for the recommended PCB layout.

- Place the input, output capacitors and the inductor as close as possible to the IC. This placement keeps the power traces short. Routing these power traces direct and wide results in low trace resistance and low parasitic inductance.
- Connect the low side of the input and output capacitors properly to the GND pin to avoid a ground potential shift.
- Note that the sense traces connected to FB is a signal trace. Take special care to avoid noise being induced. Keep these traces away from SW nodes. The connection of the output voltage trace for the FB resistors must be made at the output capacitor.
- Refer to [Layout Example](#) for an example of component placement, routing, and thermal design.

## 8.4.2 Layout Example



图 8-49. PCB Layout Recommendation

### 8.4.2.1 Thermal Considerations

Implementation of integrated circuits in low-profile and fine-pitch surface-mount packages typically requires special attention to power dissipation. Many system-dependent issues such as thermal coupling, airflow, added heat sinks and convection surfaces, and the presence of other heat-generating components affect the power dissipation limits of a given component.

Two basic approaches for enhancing thermal performance are:

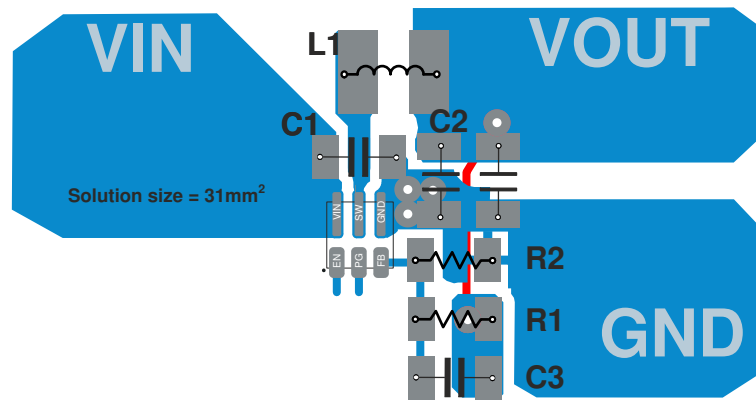
- Improving the power dissipation capability of the PCB design
- Introducing airflow in the system

The Thermal Data section in [Thermal Information](#) provides the thermal metric of the device on the EVM after considering the PCB design of real applications. The big copper planes connecting to the pads of the IC on the PCB improve the thermal performance of the device. For more details on how to use the thermal parameters, see [Thermal Characteristics of Linear and Logic Packages Using JEDEC PCB Designs](#) application note and [Semiconductor and IC Package Thermal Metrics](#) application note.



## 9 Device and Documentation Support

### 9.1 Device Support

#### 9.1.1 第三方产品免责声明

TI 发布的与第三方产品或服务有关的信息，不能构成与此类产品或服务或保修的适用性有关的认可，不能构成此类产品或服务单独或与任何 TI 产品或服务一起的表示或认可。

#### 9.1.2 Development Support

##### 9.1.2.1 Custom Design With WEBENCH® Tools

[Click here](#) to create a custom design using the TPS6282x device with the WEBENCH® Power Designer.

1. Start by entering the input voltage ( $V_{IN}$ ), output voltage ( $V_{OUT}$ ), and output current ( $I_{OUT}$ ) requirements.
2. Optimize the design for key parameters such as efficiency, footprint, and cost using the optimizer dial.
3. Compare the generated design with other possible solutions from Texas Instruments.

The WEBENCH Power Designer provides a customized schematic along with a list of materials with real-time pricing and component availability.

In most cases, these actions are available:

- Run electrical simulations to see important waveforms and circuit performance
- Run thermal simulations to understand board thermal performance
- Export customized schematic and layout into popular CAD formats
- Print PDF reports for the design, and share the design with colleagues

Get more information about WEBENCH tools at [www.ti.com/WEBENCH](http://www.ti.com/WEBENCH).

### 9.2 Documentation Support

#### 9.2.1 Related Documentation

For related documentation, see the following:

- Texas Instruments, [Thermal Characteristics of Linear and Logic Packages Using JEDEC PCB Designs](#) application note
- Texas Instruments, [Semiconductor and IC Package Thermal Metrics](#) application note

### 9.3 支持资源

TI E2E™ 中文支持论坛是工程师的重要参考资料，可直接从专家处获得快速、经过验证的解答和设计帮助。搜索现有解答或提出自己的问题，获得所需的快速设计帮助。

链接的内容由各个贡献者“按原样”提供。这些内容并不构成 TI 技术规范，并且不一定反映 TI 的观点；请参阅 TI 的[使用条款](#)。

### 9.4 Trademarks

TI E2E™ is a trademark of Texas Instruments.

WEBENCH® is a registered trademark of Texas Instruments.

所有商标均为其各自所有者的财产。

### 9.5 静电放电警告



静电放电 (ESD) 会损坏这个集成电路。德州仪器 (TI) 建议通过适当的预防措施处理所有集成电路。如果不遵守正确的处理和安装程序，可能会损坏集成电路。

ESD 的损坏小至导致微小的性能降级，大至整个器件故障。精密的集成电路可能更容易受到损坏，这是因为非常细微的参数更改都可能会导致器件与其发布的规格不相符。

### 9.6 术语表

#### TI 术语表

本术语表列出并解释了术语、首字母缩略词和定义。

## 10 Revision History

Changes from Revision H (August 2023) to Revision I (March 2024)	Page
• Added foot note to include turnoff behavior.....	4
• Updated incorrect Power good upper threshold (swapped rising/falling).....	5
• Updated description of start-up figures to show correct device versions .....	16

Changes from Revision G (March 2022) to Revision H (August 2023)	Page
• 向模块建议中添加了 TPSM82823.....	1
• 更改了公式格式.....	1
• 删除了整个文档中图像的四向连接.....	1
• 删除了 DCS-Control 的商标.....	1
• 更新了首页表格.....	1
• Added an SW pin voltage specification at PFM mode in the <i>Absolute Maximum Ratings</i> table .....	4
• Added the <i>Absolute Maximum Ratings</i> standard table note .....	4

Changes from Revision F (September 2021) to Revision G (March 2022)	Page
• 从数据表标题中删除了“采用 1.5mm × 1.5mm QFN 封装” .....	1

Changes from Revision E (December 2020) to Revision F (September 2021)	Page
• Changed the status of the TPS62824DMQ to Production Data.....	3
• Added the TPS6282533.....	3

## 11 Mechanical, Packaging, and Orderable Information

The following pages include mechanical, packaging, and orderable information. This information is the most current data available for the designated devices. This data is subject to change without notice and revision of this document. For browser-based versions of this data sheet, refer to the left-hand navigation.

**PACKAGING INFORMATION**

Orderable Device	Status (1)	Package Type	Package Drawing	Pins	Package Qty	Eco Plan (2)	Lead finish/ Ball material (6)	MSL Peak Temp (3)	Op Temp (°C)	Device Marking (4/5)	Samples
TPS62824ADMQR	ACTIVE	VSON-HR	DMQ	6	3000	RoHS & Green	Call TI   SN	Level-1-260C-UNLIM	-40 to 125	JM	<a href="#">Samples</a>
TPS62824DMQR	ACTIVE	VSON-HR	DMQ	6	3000	RoHS & Green	Call TI   SN	Level-1-260C-UNLIM	-40 to 125	JL	<a href="#">Samples</a>
TPS6282518DMQR	ACTIVE	VSON-HR	DMQ	6	3000	RoHS & Green	Call TI   SN	Level-1-260C-UNLIM	-40 to 125	CJ	<a href="#">Samples</a>
TPS6282518DMQT	ACTIVE	VSON-HR	DMQ	6	250	RoHS & Green	Call TI   SN   NIPDAU	Level-1-260C-UNLIM	-40 to 125	CJ	<a href="#">Samples</a>
TPS6282533DMQR	ACTIVE	VSON-HR	DMQ	6	3000	RoHS & Green	Call TI   SN	Level-1-260C-UNLIM	-40 to 125	L1	<a href="#">Samples</a>
TPS62825ADMQR	ACTIVE	VSON-HR	DMQ	6	3000	RoHS & Green	Call TI   SN	Level-1-260C-UNLIM	-40 to 125	JN	<a href="#">Samples</a>
TPS62825DMQR	ACTIVE	VSON-HR	DMQ	6	3000	RoHS & Green	Call TI   SN	Level-1-260C-UNLIM	-40 to 125	CI	<a href="#">Samples</a>
TPS62825DMQT	ACTIVE	VSON-HR	DMQ	6	250	RoHS & Green	Call TI   SN	Level-1-260C-UNLIM	-40 to 125	CI	<a href="#">Samples</a>
TPS6282618DMQR	ACTIVE	VSON-HR	DMQ	6	3000	RoHS & Green	Call TI   SN	Level-1-260C-UNLIM	-40 to 125	CK	<a href="#">Samples</a>
TPS6282618DMQT	ACTIVE	VSON-HR	DMQ	6	250	RoHS & Green	Call TI   SN	Level-1-260C-UNLIM	-40 to 125	CK	<a href="#">Samples</a>
TPS62826ADMQR	ACTIVE	VSON-HR	DMQ	6	3000	RoHS & Green	Call TI   SN	Level-1-260C-UNLIM	-40 to 125	JO	<a href="#">Samples</a>
TPS62826DMQR	ACTIVE	VSON-HR	DMQ	6	3000	RoHS & Green	Call TI   SN	Level-1-260C-UNLIM	-40 to 125	CL	<a href="#">Samples</a>
TPS62826DMQT	ACTIVE	VSON-HR	DMQ	6	250	RoHS & Green	Call TI   SN	Level-1-260C-UNLIM	-40 to 125	CL	<a href="#">Samples</a>
TPS62827ADMQR	ACTIVE	VSON-HR	DMQ	6	3000	RoHS & Green	Call TI   SN	Level-1-260C-UNLIM	-40 to 125	JP	<a href="#">Samples</a>
TPS62827DMQR	ACTIVE	VSON-HR	DMQ	6	3000	RoHS & Green	Call TI   SN	Level-1-260C-UNLIM	-40 to 125	EH	<a href="#">Samples</a>
TPS62827DMQT	ACTIVE	VSON-HR	DMQ	6	250	RoHS & Green	Call TI   SN	Level-1-260C-UNLIM	-40 to 125	EH	<a href="#">Samples</a>

(1) The marketing status values are defined as follows:

**ACTIVE:** Product device recommended for new designs.

**LIFEBUY:** TI has announced that the device will be discontinued, and a lifetime-buy period is in effect.

**NRND:** Not recommended for new designs. Device is in production to support existing customers, but TI does not recommend using this part in a new design.

**PREVIEW:** Device has been announced but is not in production. Samples may or may not be available.

**OBSELETE:** TI has discontinued the production of the device.

(2) **RoHS:** TI defines "RoHS" to mean semiconductor products that are compliant with the current EU RoHS requirements for all 10 RoHS substances, including the requirement that RoHS substance do not exceed 0.1% by weight in homogeneous materials. Where designed to be soldered at high temperatures, "RoHS" products are suitable for use in specified lead-free processes. TI may reference these types of products as "Pb-Free".

**RoHS Exempt:** TI defines "RoHS Exempt" to mean products that contain lead but are compliant with EU RoHS pursuant to a specific EU RoHS exemption.

**Green:** TI defines "Green" to mean the content of Chlorine (Cl) and Bromine (Br) based flame retardants meet JS709B low halogen requirements of  $\leq 1000$ ppm threshold. Antimony trioxide based flame retardants must also meet the  $\leq 1000$ ppm threshold requirement.

(3) MSL, Peak Temp. - The Moisture Sensitivity Level rating according to the JEDEC industry standard classifications, and peak solder temperature.

(4) There may be additional marking, which relates to the logo, the lot trace code information, or the environmental category on the device.

(5) Multiple Device Markings will be inside parentheses. Only one Device Marking contained in parentheses and separated by a "~" will appear on a device. If a line is indented then it is a continuation of the previous line and the two combined represent the entire Device Marking for that device.

(6) Lead finish/Ball material - Orderable Devices may have multiple material finish options. Finish options are separated by a vertical ruled line. Lead finish/Ball material values may wrap to two lines if the finish value exceeds the maximum column width.

**Important Information and Disclaimer:** The information provided on this page represents TI's knowledge and belief as of the date that it is provided. TI bases its knowledge and belief on information provided by third parties, and makes no representation or warranty as to the accuracy of such information. Efforts are underway to better integrate information from third parties. TI has taken and continues to take reasonable steps to provide representative and accurate information but may not have conducted destructive testing or chemical analysis on incoming materials and chemicals. TI and TI suppliers consider certain information to be proprietary, and thus CAS numbers and other limited information may not be available for release.

In no event shall TI's liability arising out of such information exceed the total purchase price of the TI part(s) at issue in this document sold by TI to Customer on an annual basis.

**TAPE AND REEL INFORMATION**

**QUADRANT ASSIGNMENTS FOR PIN 1 ORIENTATION IN TAPE**

\*All dimensions are nominal

Device	Package Type	Package Drawing	Pins	SPQ	Reel Diameter (mm)	Reel Width W1 (mm)	A0 (mm)	B0 (mm)	K0 (mm)	P1 (mm)	W (mm)	Pin1 Quadrant
TPS62824DMQR	VSON-HR	DMQ	6	3000	180.0	8.4	1.7	1.7	1.14	4.0	8.0	Q2
TPS6282518DMQR	VSON-HR	DMQ	6	3000	180.0	8.4	1.7	1.7	1.14	4.0	8.0	Q2
TPS6282518DMQT	VSON-HR	DMQ	6	250	180.0	8.4	1.7	1.7	1.14	4.0	8.0	Q2
TPS6282533DMQR	VSON-HR	DMQ	6	3000	180.0	8.4	1.7	1.7	1.14	4.0	8.0	Q2
TPS62825ADMQR	VSON-HR	DMQ	6	3000	180.0	8.4	1.7	1.7	1.14	4.0	8.0	Q2
TPS62825DMQR	VSON-HR	DMQ	6	3000	180.0	8.4	1.7	1.7	1.14	4.0	8.0	Q2
TPS6282618DMQR	VSON-HR	DMQ	6	3000	180.0	8.4	1.7	1.7	1.14	4.0	8.0	Q2
TPS6282618DMQT	VSON-HR	DMQ	6	250	180.0	8.4	1.7	1.7	1.14	4.0	8.0	Q2
TPS62826ADMQR	VSON-HR	DMQ	6	3000	180.0	8.4	1.7	1.7	1.14	4.0	8.0	Q2

Device	Package Type	Package Drawing	Pins	SPQ	Reel Diameter (mm)	Reel Width W1 (mm)	A0 (mm)	B0 (mm)	K0 (mm)	P1 (mm)	W (mm)	Pin1 Quadrant
TPS62827DMQT	VSON-HR	DMQ	6	250	180.0	8.4	1.7	1.7	1.14	4.0	8.0	Q2

**TAPE AND REEL BOX DIMENSIONS**

\*All dimensions are nominal

Device	Package Type	Package Drawing	Pins	SPQ	Length (mm)	Width (mm)	Height (mm)
TPS62824DMQR	VSON-HR	DMQ	6	3000	341.0	182.0	80.0
TPS6282518DMQR	VSON-HR	DMQ	6	3000	210.0	185.0	35.0
TPS6282518DMQT	VSON-HR	DMQ	6	250	210.0	185.0	35.0
TPS6282533DMQR	VSON-HR	DMQ	6	3000	182.0	182.0	20.0
TPS62825ADMQR	VSON-HR	DMQ	6	3000	210.0	185.0	35.0
TPS62825DMQR	VSON-HR	DMQ	6	3000	210.0	185.0	35.0
TPS6282618DMQR	VSON-HR	DMQ	6	3000	341.0	182.0	80.0
TPS6282618DMQT	VSON-HR	DMQ	6	250	341.0	182.0	80.0
TPS62826ADMQR	VSON-HR	DMQ	6	3000	210.0	185.0	35.0
TPS62827DMQT	VSON-HR	DMQ	6	250	341.0	182.0	80.0

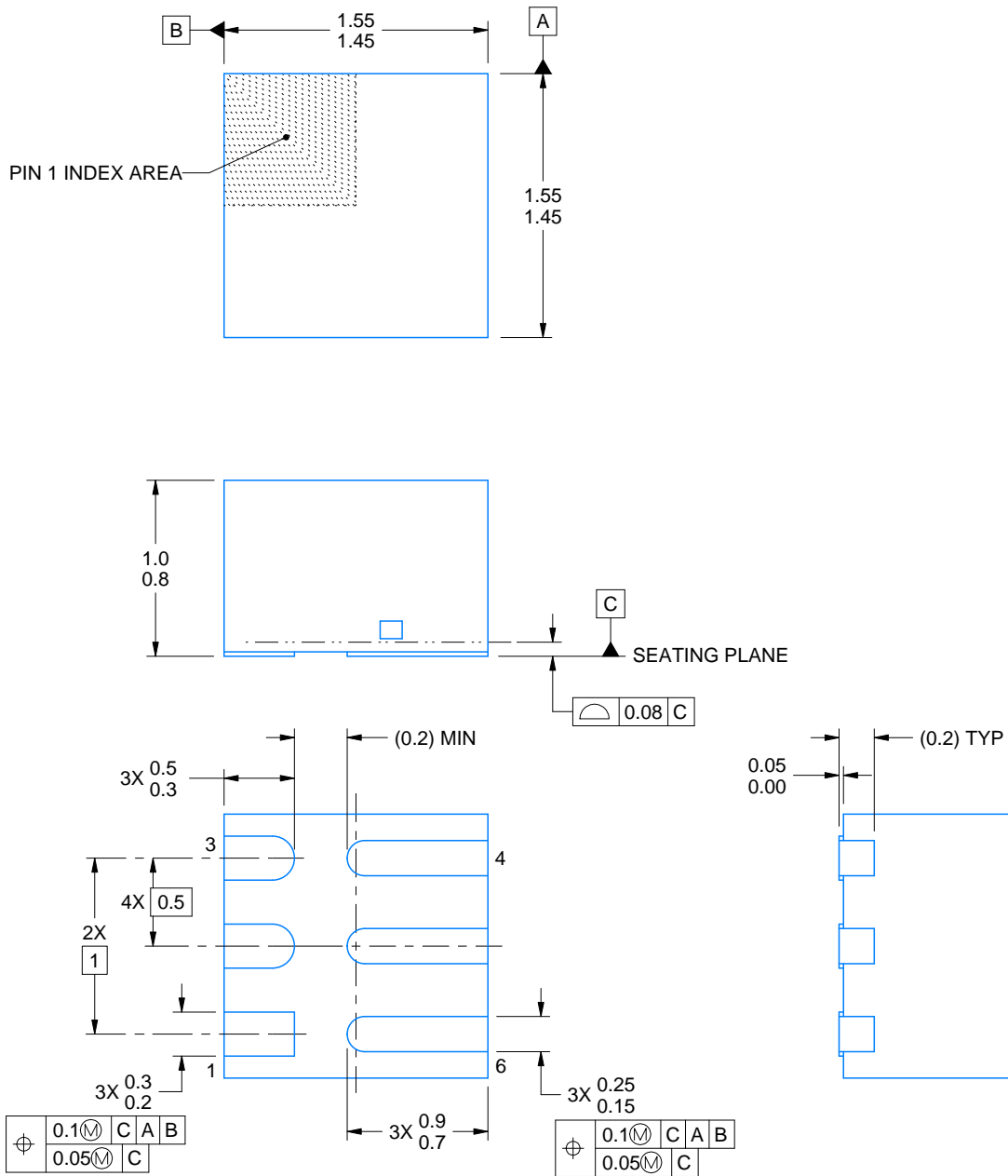
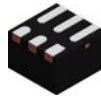

4222645/E 09/2023

NOTES:

1. All linear dimensions are in millimeters. Any dimensions in parenthesis are for reference only. Dimensioning and tolerancing per ASME Y14.5M.
2. This drawing is subject to change without notice.



# EXAMPLE BOARD LAYOUT

DMQ0006A

VSON - 1 mm max height

PLASTIC SMALL OUTLINE - NO LEAD

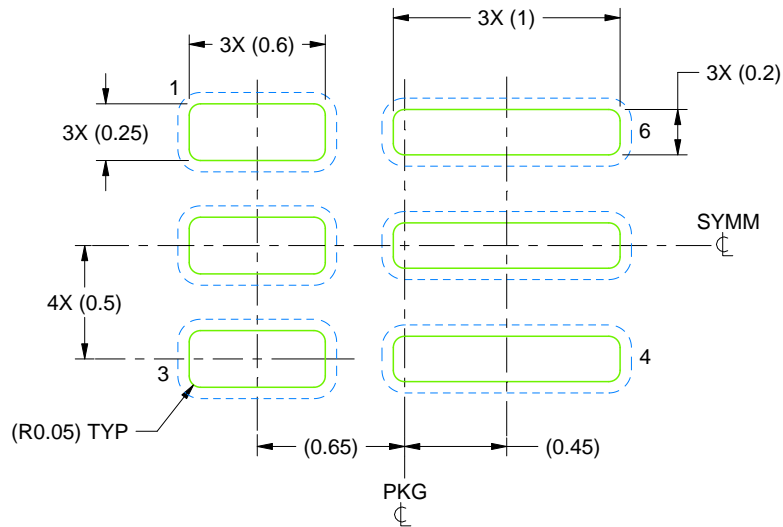

LAND PATTERN EXAMPLE  
SCALE:30X

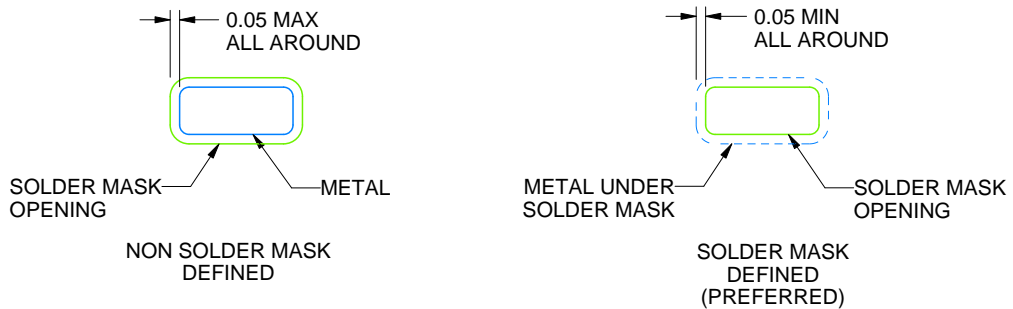

SOLDER MASK DETAILS

4222645/E 09/2023

NOTES: (continued)

3. For more information, see Texas Instruments literature number SLUA271 ([www.ti.com/lit/slua271](http://www.ti.com/lit/slua271)).

# EXAMPLE STENCIL DESIGN

DMQ0006A

VSON - 1 mm max height

PLASTIC SMALL OUTLINE - NO LEAD

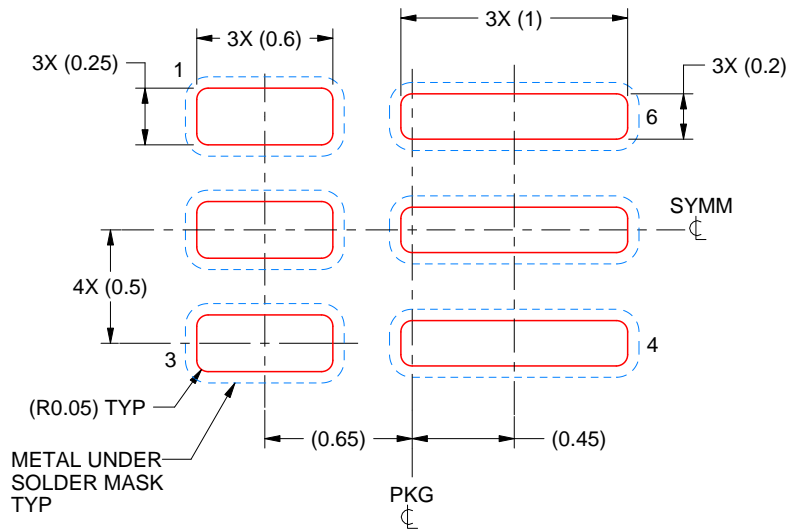

SOLDER PASTE EXAMPLE  
BASED ON 0.125 mm THICK STENCIL  
SCALE:30X

4222645/E 09/2023

NOTES: (continued)

4. Laser cutting apertures with trapezoidal walls and rounded corners may offer better paste release. IPC-7525 may have alternate design recommendations.

## 重要声明和免责声明

TI“按原样”提供技术和可靠性数据（包括数据表）、设计资源（包括参考设计）、应用或其他设计建议、网络工具、安全信息和其他资源，不保证没有瑕疵且不做任何明示或暗示的担保，包括但不限于对适销性、某特定用途方面的适用性或不侵犯任何第三方知识产权的暗示担保。

这些资源可供使用 TI 产品进行设计的熟练开发人员使用。您将自行承担以下全部责任：(1) 针对您的应用选择合适的 TI 产品，(2) 设计、验证并测试您的应用，(3) 确保您的应用满足相应标准以及任何其他功能安全、信息安全、监管或其他要求。

这些资源如有变更，恕不另行通知。TI 授权您仅可将这些资源用于研发本资源所述的 TI 产品的应用。严禁对这些资源进行其他复制或展示。您无权使用任何其他 TI 知识产权或任何第三方知识产权。您应全额赔偿因在这些资源的使用中对 TI 及其代表造成的任何索赔、损害、成本、损失和债务，TI 对此概不负责。

TI 提供的产品受 [TI 的销售条款](#) 或 [ti.com](#) 上其他适用条款/TI 产品随附的其他适用条款的约束。TI 提供这些资源并不会扩展或以其他方式更改 TI 针对 TI 产品发布的适用的担保或担保免责声明。

TI 反对并拒绝您可能提出的任何其他或不同的条款。

邮寄地址：Texas Instruments, Post Office Box 655303, Dallas, Texas 75265

Copyright © 2024，德州仪器 (TI) 公司