

具有小解决方案尺寸的 TPS6380x 高效率、低 I_Q 降压/升压转换器

1 特性

- 三个引脚对引脚器件选项：TPS63805、TPS63806 和 TPS63807 具有特定的应用重点
- 输入电压范围：1.3V 至 5.5V
 - 器件启动时输入电压大于 1.8V
- 输出电压范围：1.8V 至 5.2V (可调节)
- 在整个负载范围内具有高效率
 - 具有省电模式和强制 PWM 模式
- 峰值电流降压/升压模式架构
 - 可在降压、降压/升压和升压操作模式之间定义切换点
 - 正向和反向电流运行
 - 启动至预偏置输出
- 安全、可靠运行的特性
 - 集成软启动
 - 过热和过压保护
 - 带负载断开功能的真正关断功能
 - 正向和反向电流限制
- TPS63805
 - 经优化可实现 18.5 mm^2 的最小解决方案尺寸 (与 $22 \mu\text{F}$ 最小输出电容器配合使用)
 - $V_I \geq 2.3\text{V}$ 、 $V_O = 3.3\text{V}$ 时，输出电流为 2A
 - $11 \mu\text{A}$ 工作静态电流
- TPS63806
 - 经优化可实现最佳负载阶跃响应 (电流阶跃为 2A 时可实现 180mV 负载阶跃响应)
 - 高达 2.5A 的瞬态输出电流
 - $13 \mu\text{A}$ 工作静态电流
- TPS63807
 - 经优化可实现 18.5 mm^2 的最小解决方案尺寸 (与 $22 \mu\text{F}$ 最小输出电容器配合使用)
 - $V_I \geq 2.3\text{V}$ 、 $V_O = 3.3\text{V}$ 时，输出电流为 2A

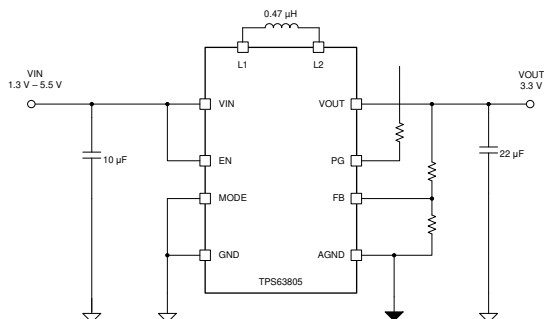

典型应用

- $11 \mu\text{A}$ 工作静态电流
- EN 为低电平时的输出放电功能
- $480 \mu\text{s}$ T_{ramp} ，对于启动期间的小浪涌电流

2 应用

- TPS63805
 - 系统前置稳压器 (智能手机、平板电脑、EFT 终端和远程信息处理)
 - 负载点调节 (有线传感器、端口/电缆适配器和加密狗)
- TPS63806
 - 飞行时间摄像头传感器 (智能手机、电子智能锁和 IP 网络摄像头)
 - 宽带网络无线电或 SoC 电源 (物联网、跟踪、家居自动化和 EPOS)
 - 热电器件电源 (TEC、光纤模块)
 - 通用电压稳定器
- TPS63807
 - 需要输出放电功能的应用

3 说明

TPS63805、TPS63806 和 TPS63807 是高效率、高输出电流降压/升压转换器。根据输入电压不同，当输入电压近似等于输出电压时，它们会自动以升压、降压或全新的 4 周期降压/升压模式运行。

器件信息

器件型号	封装 ⁽¹⁾	封装尺寸 (标称值)
TPS63805	3x5 焊球 WCSP (0.4mm 间距)	2.3mm × 1.4mm
TPS63806		
TPS63807		

(1) 如需了解所有可用封装，请参阅数据表末尾的可订购产品附录。

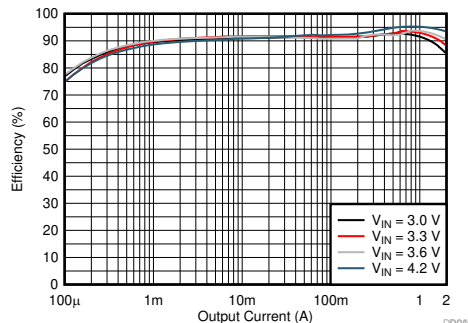

效率与输出电流间的关系曲线 ($V_O = 3.3\text{V}$)



Table of Contents

1 特性	1	9.4 Device Functional Modes.....	12
2 应用	1	10 Application and Implementation	16
3 说明	1	10.1 Application Information.....	16
4 Revision History	2	10.2 Typical Application.....	16
5 说明 (续)	3	11 Power Supply Recommendations	32
6 Device Comparison Table	3	12 Layout	33
7 Pin Configuration and Functions	3	12.1 Layout Guidelines.....	33
8 Specifications	4	12.2 Layout Example.....	33
8.1 Absolute Maximum Ratings.....	4	13 Device and Documentation Support	34
8.2 ESD Ratings.....	4	13.1 Device Support.....	34
8.3 Recommended Operating Conditions.....	4	13.2 接收文档更新通知.....	34
8.4 Thermal Information.....	4	13.3 支持资源.....	34
8.5 Electrical Characteristics.....	6	13.4 Trademarks.....	34
8.6 Typical Characteristics.....	8	13.5 Electrostatic Discharge Caution.....	34
9 Detailed Description	9	13.6 术语表.....	34
9.1 Overview.....	9	14 Mechanical, Packaging, and Orderable Information	35
9.2 Functional Block Diagram.....	9		
9.3 Feature Description.....	10		

4 Revision History

Changes from Revision D (January 2021) to Revision E (August 2021)	Page
• 添加了 TPS63807.....	1

Changes from Revision C (September 2019) to Revision D (January 2021)	Page
• 更新了整个文档中的表格、图和交叉参考的编号格式。.....	1

5 说明 (续)

在定义的阈值内进行模式切换，避免不必要的模式内切换，以减少输出电压纹波。这类器件的输出电压可在较宽输出电压范围内通过电阻式分压器进行单独调整。TPS63805 和 TPS63807 以很少的物料清单实现了超小的解决方案尺寸。静态电流为 11 μA ，可在超小甚至空载条件下实现出色效率。TPS63805、TPS63806 和 TPS63807 采用 1.4mm \times 2.3mm 封装。该器件可与微型无源组件配套使用，从而使整体解决方案尺寸保持小巧。

TPS63806 针对存在重负载曲线下负载阶跃响应问题的应用进行了优化。

6 Device Comparison Table

PART NUMBER	OUTPUT VOLTAGE (V_O)	$I_{(Q;VIN)}$ (TYP.)	$C_{(O,EFF)}$ (MIN.)	V_{PP} LOAD TRANSIENT RESPONDS (TYP.)
TPS63805/ TPS63807	Adjustable	11 μA	7 μF	320 mV
TPS63806	Adjustable	13 μA	21 μF	180 mV

7 Pin Configuration and Functions



图 7-1. WSP Package Top View

表 7-1. Pin Functions

PIN		DESCRIPTION
NO	NAME	
A2, A3	VIN	Supply voltage
B2, B3	L1	Connection for inductor
A1	EN	Device Enable input. Set HIGH to enable and LOW to disable. It must not be left floating.
C2, C3	GND	Power ground
B1	MODE	PFM/PWM mode selection. Set LOW for power save mode, set HIGH for forced PWM mode. It must not be left floating.
C1	AGND	Analog ground
D2, D3	L2	Connection for inductor
E2, E3	VOUT	Power stage output
D1	FB	Voltage feedback sensing pin
E1	PG	Power good indicator, open drain output. If not used can be left floating.

8 Specifications

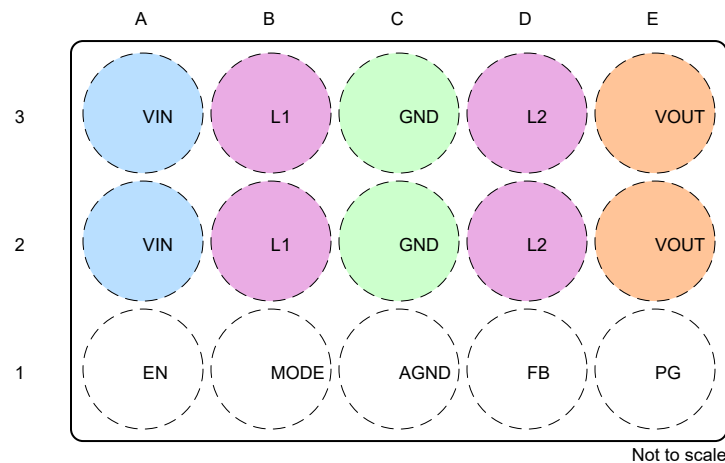
8.1 Absolute Maximum Ratings

over junction temperature range (unless otherwise noted)⁽¹⁾

		MIN	MAX	UNIT
Voltage ⁽²⁾	VIN, L1, L2, EN, MODE, VOUT, FB, PG	- 0.3	6	V
	L1, L2 (AC, less than 10 ns)	- 3	9	V
Operating junction temperature, T _J		- 40	150	°C
Storage temperature, T _{stg}		- 65	150	°C

- (1) Stresses beyond those listed under *Absolute Maximum Ratings* may cause permanent damage to the device. These are stress ratings only, which do not imply functional operation of the device at these or any other conditions beyond those indicated under *Recommended Operating Conditions*. Exposure to absolute-maximum-rated conditions for extended periods may affect device reliability.
- (2) All voltage values are with respect to network ground pin.

8.2 ESD Ratings

			VALUE	UNIT
V _(ESD)	Electrostatic discharge	Human-body model (HBM), per ANSI/ESDA/JEDEC JS-001 ⁽¹⁾	±2000	V
		Charged-device model (CDM), per JEDEC specification JESD22-C101 ⁽²⁾	±500	

- (1) JEDEC document JEP155 states that 500-V HBM allows safe manufacturing with a standard ESD control process.
- (2) JEDEC document JEP157 states that 250-V CDM allows safe manufacturing with a standard ESD control process.

8.3 Recommended Operating Conditions

		MIN	NOM	MAX	UNIT
V _I	Input voltage	1.3 ⁽¹⁾		5.5	V
V _O	Output voltage	1.8		5.2 ⁽²⁾	V
C _I	Effective capacitance connected to V _{IN}	4	5		μF
L	Effective inductance	0.37	0.47	0.57	μH
C _O	TPS63805/TPS63807 Effective capacitance connected to V _{OUT}	1.8 V ≤ V _O ≤ 2.3 V	10		μF
		V _O > 2.3 V	7	8.2	μF
C _O	TPS63806 Effective capacitance connected to V _{OUT}	1.8 V ≤ V _O < 2.3 V	30		μF
		V _O > 2.3 V	21	27	μF
T _J	Operating junction temperature	- 40		125	°C

- (1) Minimum start-up voltage of V_I > 1.8 V until power good
- (2) V_O margin for accuracy and load steps is considered in absolute maximum ratings

8.4 Thermal Information

over operating free-air temperature range (unless otherwise noted)

THERMAL METRIC ⁽¹⁾		TPS6380x	UNIT
		3x5 Ball WCSP	
		15 PINS	
R _{θJA}	Junction-to-ambient thermal resistance	78.8	°C/W
R _{θJC(top)}	Junction-to-case (top) thermal resistance	0.6	°C/W
R _{θJB}	Junction-to-board thermal resistance	19.5	°C/W
Ψ _{JT}	Junction-to-top characterization parameter	0.3	°C/W
Ψ _{JB}	Junction-to-board characterization parameter	19.5	°C/W

over operating free-air temperature range (unless otherwise noted)

THERMAL METRIC ⁽¹⁾		TPS6380x	UNIT
		3x5 Ball WCSP	
		15 PINS	
$R_{\theta JC(bot)}$	Junction-to-case (bottom) thermal resistance	N/A	°C/W

- (1) For more information about traditional and new thermal metrics, see the [Semiconductor and IC Package Thermal Metrics](#) application report.

8.5 Electrical Characteristics

V_{IN} = 1.8 V to 5.5 V, V_{OUT} = 1.8 V to 5.2 V, T_J = -40°C to +125°C, typical values are at V_{IN} = 3.6 V, V_{OUT} = 3.3 V and T_J = 25°C (unless otherwise noted)

PARAMETER		TEST CONDITIONS	MIN	TYP	MAX	UNIT	
SUPPLY							
$V_{IN,LOAD}$	Minimum input voltage for full load, once started	$I_{OUT} = 2\text{ A}$, $V_{OUT} = 3.3\text{ V}$, $T_J = 25^\circ\text{C}$		2.3		V	
$I_{Q,VIN}$	Quiescent current into VIN	TPS63805/TPS63807; $T_J = 25^\circ\text{C}$, $EN = V_{IN} = 3.6\text{ V}$, $V_{OUT} = 3.3\text{ V}$, not switching		11		μA	
$I_{Q,VIN}$	Quiescent current into VIN	TPS63806; $T_J = 25^\circ\text{C}$, $EN = V_{IN} = 3.6\text{ V}$, $V_{OUT} = 3.3\text{ V}$, not switching		13		μA	
I_{SD}	Shutdown current into VIN	$EN = \text{low}$, $-40^\circ\text{C} \leq T_J \leq 85^\circ\text{C}$, $V_{IN} = 3.6\text{ V}$, $V_{OUT} = 0\text{ V}$		45	600	nA	
$UVLO$	Undervoltage lockout threshold	V_{IN} falling, $V_{OUT} \geq 1.8\text{ V}$, once started	1.2	1.25	1.29	V	
	Undervoltage lockout threshold	V_{IN} rising	1.6	1.7	1.79	V	
T_{SD}	Thermal shutdown	Temperature rising		150		°C	
$T_{SD,HYST}$	Thermal shutdown hysteresis			20		°C	
SOFT-START, POWER GOOD							
T_{ramp}	Soft-start, Current limit ramp time	TPS63805/TPS63806 $T_J = 25^\circ\text{C}$, $V_{IN} = 3.6\text{ V}$, $V_{OUT} = 3.3\text{ V}$, $I_O = 3.5\text{ A}$, time from first switching to power good		224		μs	
		TPS63807 $T_J = 25^\circ\text{C}$, $V_{IN} = 3.6\text{ V}$, $V_{OUT} = 3.3\text{ V}$, $I_O = 3.5\text{ A}$, time from first switching to power good		480		μs	
T_{delay}	Delay from EN-edge until rising V_{OUT}	$T_J = 25^\circ\text{C}$, $V_{IN} = 3.6\text{ V}$, $V_{OUT} = 3.3\text{ V}$, Delay from EN-edge until rising first switching		321		μs	
LOGIC SIGNALS EN, MODE							
$V_{THR,EN}$	Threshold Voltage rising for EN-Pin		1.07	1.1	1.13	V	
$V_{THF,EN}$	Threshold Voltage falling for EN-Pin		0.97	1	1.03	V	
V_{IH}	High-level input voltage		1.2			V	
V_{IL}	Low-level input voltage				0.4	V	
$V_{PG,rising}$	Power Good threshold voltage	V_{OUT} rising, referenced to V_{OUT} nominal		95		%	
$V_{PG,falling}$		V_{OUT} falling, referenced to V_{OUT} nominal		90		%	
$V_{PG,Low}$	Power Good low-level output voltage	$I_{SINK} = 1\text{ mA}$			0.4	V	
$t_{PG,delay}$	Power Good delay time	V_{FB} falling		14		μs	
I_{lkg}	Input leakage current			0.01	0.2	μA	
OUTPUT							
I_{SD}	Shutdown current into V_{OUT}	TPS63805/TPS63806 $EN = \text{low}$, $-40^\circ\text{C} \leq T_J \leq 85^\circ\text{C}$, $V_{IN} = 3.6\text{ V}$, $V_{OUT} = 3.3\text{ V}$		± 0.5	± 600	nA	
V_{FB}	Feedback Regulation Voltage			500		mV	
V_{FB}	Feedback Voltage accuracy	PWM mode	-1		1	%	
	Overvoltage Protection Threshold	V_{OUT} rising	5.5	5.7	5.9	V	
		V_{IN} rising	5.5	5.7	5.9	V	
$I_{PWM/PFM}$	Peak Inductor Current to enter PFM-Mode	$V_{IN} = 3.6\text{ V}$; $V_{OUT} = 3.3\text{ V}$		1.06		A	
I_{FB}	Feedback Input Bias Current	$V_{FB} = 500\text{ mV}$		5	100	nA	
I_{PK}	Peak Current Limit, Boost Mode	TPS63805/TPS63807; $V_{IN} \geq 2.5\text{ V}$		4	5	5.75	A
	Peak Current Limit, Buck-Boost Mode			5		A	
	Peak Current Limit, Buck Mode			3.8		A	
I_{PK}	Peak Current Limit, Boost Mode	TPS63806; $V_{IN} \geq 2.5\text{ V}$		4.4	5.5	6.25	A
	Peak Current Limit, Buck-Boost Mode			5.5		A	
	Peak Current Limit, Buck Mode			4		A	
$I_{PK,Reverse}$	Peak Current Limit for Reverse Operation	$V_I = 5\text{ V}$, $V_O = 3.3\text{ V}$		-0.9		A	

V_{IN} = 1.8 V to 5.5 V, V_{OUT} = 1.8 V to 5.2 V, T_J = -40°C to +125°C, typical values are at V_{IN} = 3.6 V, V_{OUT} = 3.3 V and T_J = 25°C (unless otherwise noted)

PARAMETER		TEST CONDITIONS		MIN	TYP	MAX	UNIT
Buck $R_{DS,ON}$	High-side FET on-resistance	$V_{IN} = 3\text{ V}$, $V_{OUT} = 3.3\text{ V}$; $I_{(L2)} = 0.19\text{ A}$	$V_{IN} = 3\text{ V}$, $V_{OUT} = 3.3\text{ V}$; $I_O = 0.5\text{ A}$		47		mΩ
	Low-side FET on-resistance	$V_{IN} = 3\text{ V}$, $V_{OUT} = 3.3\text{ V}$; $I_{(L2)} = 0.19\text{ A}$	$V_{IN} = 3\text{ V}$, $V_{OUT} = 3.3\text{ V}$; $I_O = 0.5\text{ A}$		30		mΩ
Boost $R_{DS,ON}$	High-side FET on-resistance	$V_{IN} = 3\text{ V}$, $V_{OUT} = 3.3\text{ V}$; $I_{(L1)} = 0.19\text{ A}$	$V_{IN} = 3\text{ V}$, $V_{OUT} = 3.3\text{ V}$; $I_O = 0.5\text{ A}$		43		mΩ
	Low-side FET on-resistance	$V_{IN} = 3\text{ V}$, $V_{OUT} = 3.3\text{ V}$; $I_{(L1)} = 0.19\text{ A}$	$V_{IN} = 3\text{ V}$, $V_{OUT} = 3.3\text{ V}$; $I_O = 0.5\text{ A}$		18		mΩ
f_{sw}	Inductor Switching Frequency, Boost Mode	$V_{IN} = 2.3\text{ V}$, $V_{OUT} = 3.3\text{ V}$, no Load, MODE = HIGH, $T_J = 25^\circ\text{C}$			2.1		MHz
	Inductor Switching Frequency, Buck-Boost Mode	$V_{IN} = 3.3\text{ V}$, $V_{OUT} = 3.3\text{ V}$, no Load, MODE = HIGH, $T_J = 25^\circ\text{C}$			1.4		MHz
	Inductor Switching Frequency, Buck Mode	$V_{IN} = 4.3\text{ V}$, $V_{OUT} = 3.3\text{ V}$, no Load, MODE = HIGH, $T_J = 25^\circ\text{C}$			1.6		MHz
	Line regulation	$V_{IN} = 2.4\text{ V to } 5.5\text{ V}$, $V_{OUT} = 3.3\text{ V}$, $I_{OUT} = 2\text{ A}$			0.3		%
	Load regulation	$V_{IN} = 3.6\text{ V}$, $V_{OUT} = 3.3\text{ V}$, $I_{OUT} = 0\text{ A to } 2\text{ A}$, forced-PWM mode			0.1		%

8.6 Typical Characteristics



图 8-1. TPS63805/TPS63807 Quiescent Current vs. Temperature



图 8-2. Quiescent Current vs. Temperature

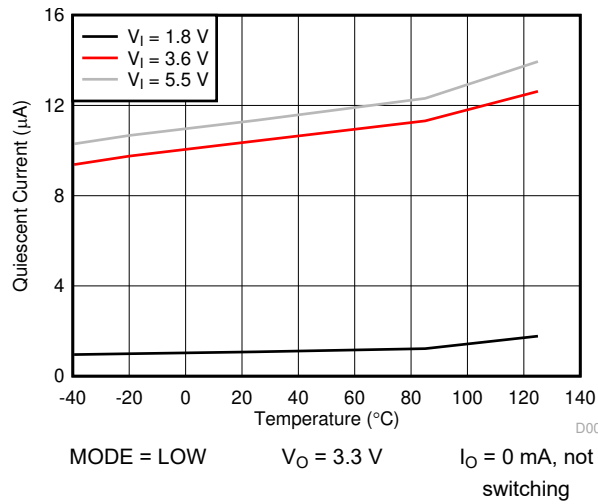

图 8-3. Shutdown Current vs. Temperature

9 Detailed Description

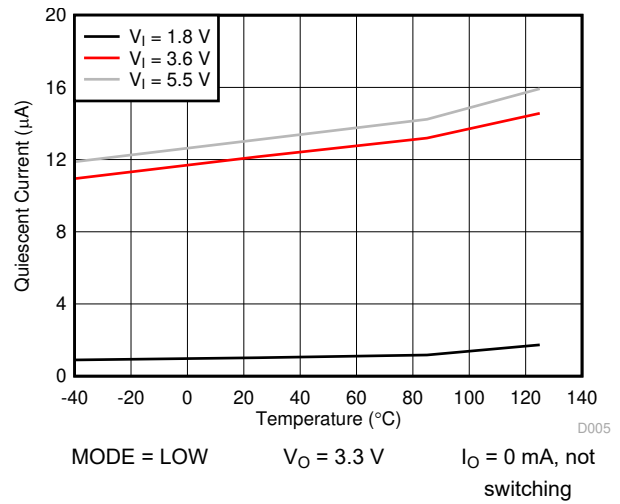
9.1 Overview

The TPS63805, TPS63806, and TPS63807 buck-boost converter use four internal switches to maintain synchronous power conversion at all possible operating conditions. This enables the device to keep high efficiency over a wide input voltage and output load range. To regulate the output voltage at all possible input voltage conditions, the device automatically transitions between buck, buck-boost, and boost operation as required by the operating conditions. Therefore, it operates as a buck converter when the input voltage is higher than the output voltage, and as a boost converter when the input voltage is lower than the output voltage. When the input voltage is close to the output voltage, it operates in a 3-cycle buck-boost operation. In this mode, all four switches are active (see [# 9.4.1.3](#)). The RMS current through the switches and the inductor is kept at a minimum to minimize switching and conduction losses. Controlling the switches this way allows the converter to always keep high efficiency over the complete input voltage range. The device provides a seamless transition between all modes.

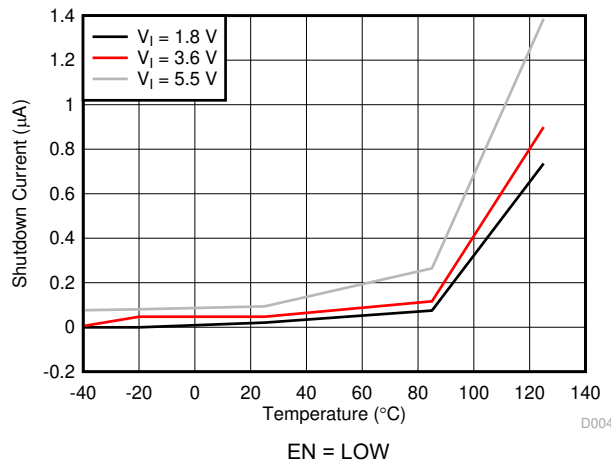
9.2 Functional Block Diagram

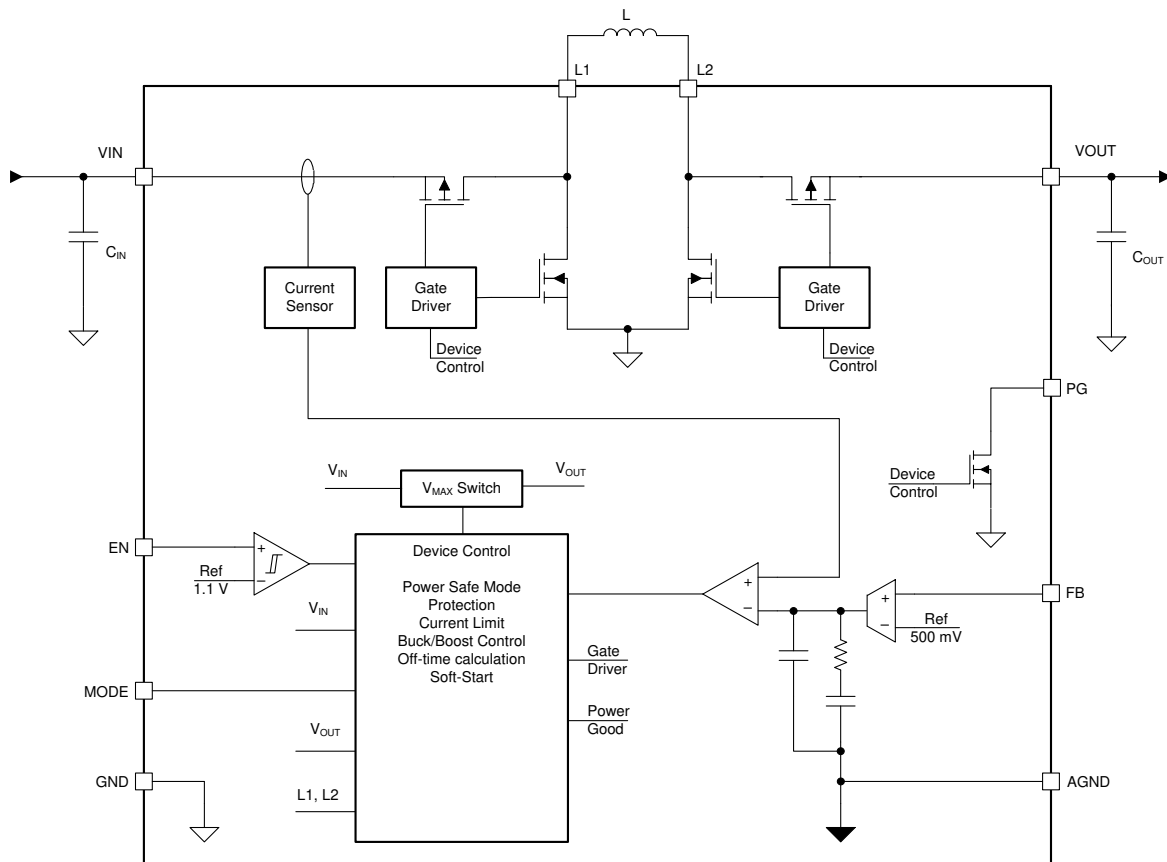

9.3 Feature Description

9.3.1 Control Loop Description

The TPS63805, TPS63806, and TPS63807 use a peak current mode control architecture. It has an inner current loop where it measures the peak current of the boost high-side MOSFET and compares it to a reference current. This current is the output of the outer voltage loop. It measures the output voltage via the FB-pin and compares it with the internal voltage reference. That means, the outer voltage loop measures the voltage error ($V_{REF}-V_{FB}$), and transforms it into the system current demand (I_{REF}) for the inner current loop.

图 9-1 shows the simplified schematic of the control loop. The error amplifier and the type-2 compensation represent the voltage loop. The voltage output is converted into the reference current I_{REF} and fed into the current comparator.

The scheme shows the skip-comparator handling the power-save mode (PFM) to achieve high efficiency at light loads. See 节 9.4.2 for further details.



图 9-1. Control Loop Architecture Scheme

9.3.2 Precise Device Enable: Threshold- or Delayed Enable

The enable-pin is a digital input to enable or disable the device by applying a high or low level. The device enters shutdown when EN is set low. In addition, this input features a precise threshold and can be used as a comparator that enables and disables the part at a defined threshold. This allows you to drive the state by a slowly changing voltage and enables the use of an external RC network to achieve a precise power-up delay. The enable pin can also be used with an external voltage divider to set a user-defined minimum supply voltage. For proper operation, the EN pin must be terminated and must not be left floating.

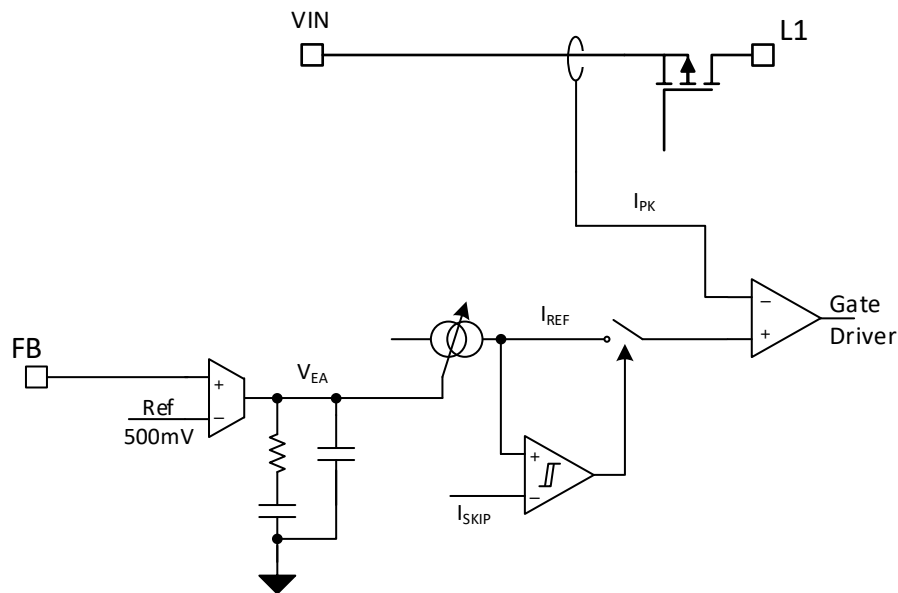

图 9-2. Circuit Example for How to Use the Precise Device Enable Feature

9.3.3 Mode Selection (PFM/PWM)

The mode-pin is a digital input to enable the automatic PWM/PFM mode that features the highest efficiency by allowing pulse-frequency-modulation for lower output currents. This mode is enabled by applying a low level. The device can be forced in PWM operation regardless of the output current to achieve minimum output ripple by applying a high level. This pin must not be left floating.

9.3.4 Undervoltage Lockout (UVLO)

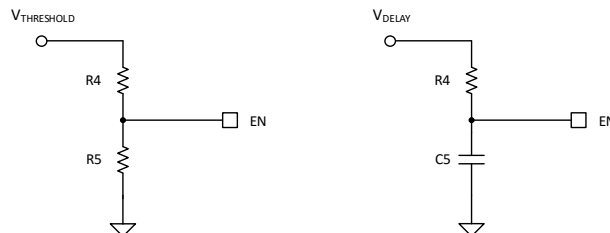
To avoid mis-operation of the device at low input voltages, an undervoltage lockout is included. It activates the device once the input voltage (V_I) has increased the $UVLO_{rising}$ value. Once active, the device allows operation down to even smaller input voltages, which is determined by the $UVLO_{falling}$. This behavior requires V_O to be higher than the minimum value of 1.8 V.



图 9-3. Rising and Falling Undervoltage Lockout Behavior

9.3.5 Soft Start

To minimize inrush current and output voltage overshoot during start-up, the device features a controlled soft start. After the device is enabled, the device starts all internal reference and control circuits within the enable delay time, T_{delay} . After that, the maximum switch current limit rises monotonically from 0 mA to the current limit. The loop stops switching once V_O is reached. This allows a quick output voltage ramp for small capacitors at the output. The bigger the output capacitor, the longer it takes to settle V_O . A potential load during start-up will lengthen the duration of the output voltage ramp as well. The gradual ramp of the current limit allows a small inrush current for no-load conditions, as well as the possibility to start into high loads at start-up.

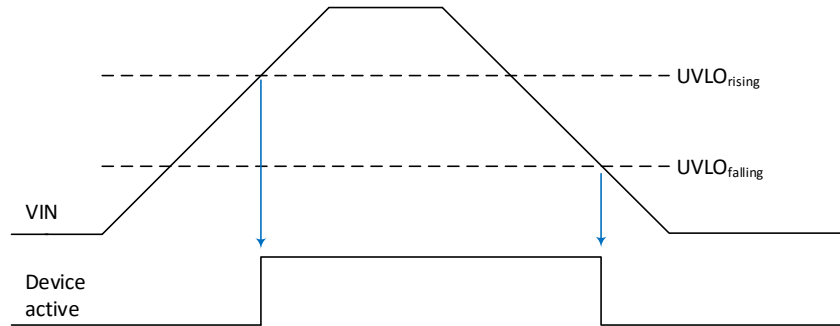

图 9-4. Device Start-up Scheme

9.3.6 Adjustable Output Voltage

The device's output voltage is adjusted by applying an external resistive divider between V_O , the FB-pin, and GND. This allows you to program the output voltage in the recommended range. The divider must provide a low-side resistor of less than 100 k Ω . The high-side resistor is chosen accordingly.

9.3.7 Overtemperature Protection - Thermal Shutdown

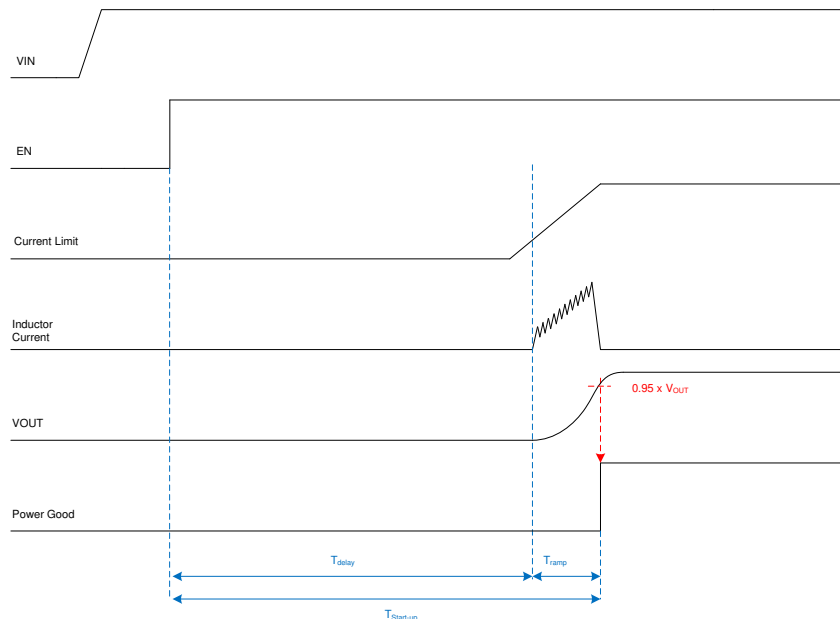
The device has a built-in temperature sensor which monitors the junction temperature. If the temperature exceeds the threshold, the device stops operating. As soon as the IC temperature has decreased below the programmed threshold, it starts operating again. There is a built-in hysteresis to avoid unstable operation at junction temperatures at the overtemperature threshold.

9.3.8 Input Overvoltage - Reverse-Boost Protection (IVP)

The TPS63805, TPS63806, and TPS63807 can operate in reverse mode where the device transfers energy from the output back to the input. If the source is not able to sink the reverse current, the negative current builds up a charge to the input capacitance and V_{IN} rises. To protect the device and other components from that scenario, the device features an input voltage protection (IVP) for reverse boost operation. Once the input voltage is above the threshold, the converter forces PFM mode and the negative current operation is interrupted.

The PG signal goes low to indicate that behavior.

9.3.9 Output Overvoltage Protection (OVP)

In case of a broken feedback-path connection, the device can lose V_O information and is not able to regulate. To avoid an uncontrolled boosting of V_O , the TPS63805, TPS63806, and TPS63807 feature output overvoltage protection. It measures the voltage on the VOUT pin and stops switching when V_O is greater than the threshold to avoid harm to the converter and other components.

9.3.10 Power-Good Indicator

The power good goes high-impedance once the output is above 95% of the nominal voltage, and is driven low once the output voltage falls below typically 90% of the nominal voltage. This feature also indicates overvoltage and device shutdown cases as shown in 表 9-1. The PG pin is an open-drain output and is specified to sink up to 1 mA. The power-good output requires a pullup resistor connecting to any voltage rail less than 5.5 V. The PG signal can be used to sequence multiple rails by connecting it to the EN pin of other converters. Leave the PG pin unconnected when not used.

表 9-1. Power-Good Indicator Truth Table

LOGIC SIGNALS					PG LOGIC STATUS
EN	V_O	V_I	OVP	IVP	
X	< 1.8 V	< UVLO_R	X	X	Undefined
LOW	X	> UVLO_F	X	X	LOW
HIGH	$V_O < 0.9 \times \text{target-}V_O$	> 1.3V	X	X	LOW
HIGH	X	> UVLO_F	HIGH	X	LOW
HIGH	X	> UVLO_F	X	HIGH	LOW
HIGH	$V_O > 0.95 \times \text{target-}V_O$	> UVLO_F	LOW	LOW	HIGH Z

9.4 Device Functional Modes

9.4.1 Peak-Current Mode Architecture

The TPS63805, TPS63806, and TPS63807 are based on a peak-current mode architecture. The error amplifier provides a peak-current target (voltage that is translated into an equivalent current, see 图 9-1), based on the current demand from the voltage loop. This target is compared to the actual inductor current during the ON-time. The ON-time is ended once the inductor current is equal to the current target and OFF-time is initiated. The OFF-time is calculated by the control and a function of V_I and V_O .



图 9-5. Peak-Current Architecture Operation

9.4.1.1 Reverse Current Operation, Negative Current

When the TPS63805, TPS63806, and TPS63807 are forced to PWM operation (MODE = HIGH), the device current can flow in reverse direction. This happens by the negative current capability of the TPS63805, TPS63806, and TPS63807. The error amplifier provides a peak-current target (voltage that is translated into an equivalent current, see 图 9-1), even if the target has a negative value. The maximum average current is even more negative than the peak current.

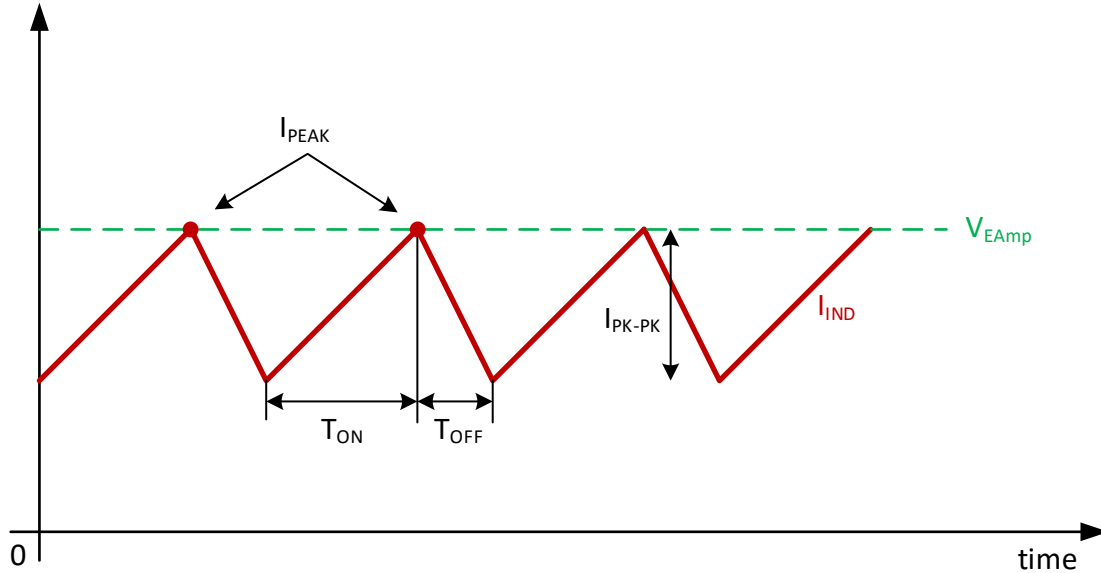

图 9-6. Peak-Current Operation, Reverse Current

9.4.1.2 Boost Operation

When V_I is smaller than V_O (and the voltages are not close enough to trigger buck-boost operation), the TPS63805, TPS63806, and TPS63807 operate in boost mode where the boost high-side and low-side switches are active. The buck high-side switch is always turned on and the buck low-side switch is always turned off. This lets the TPS63805, TPS63806, and TPS63807 operate as a classical boost converter.

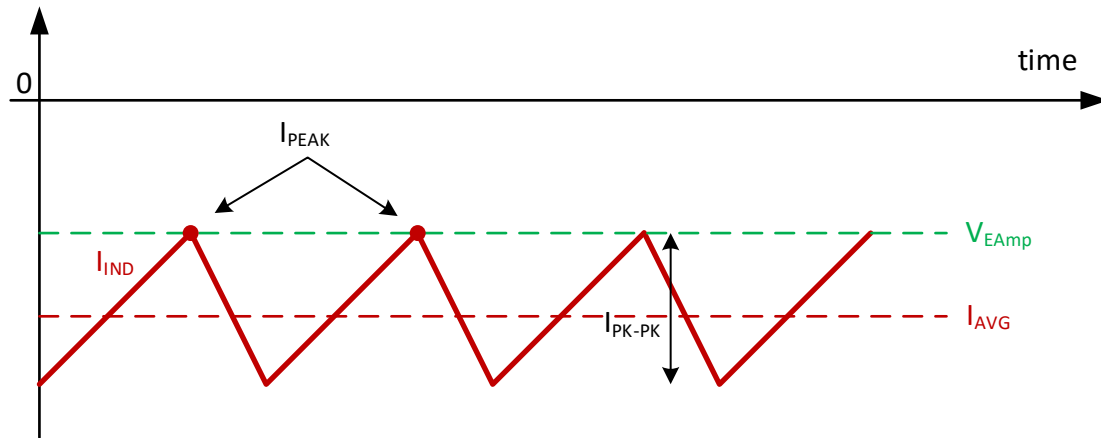

图 9-7. Peak-Current Boost Operation

9.4.1.3 Buck-Boost Operation

When V_I is close to V_O , the TPS63805, TPS63806, and TPS63807 operate in buck-boost mode where all switches are active and the device repeats 3-cycles:

- T_{ON} : Boost-charge phase where boost low-side and buck high-side are closed and the inductor current is built up
- T_{OFF} : Buck discharge phase where boost high-side and buck low-side are closed and the inductor is discharged
- T_{COM} : V_I connected to V_O where all high-side switches are closed and the input is connected to the output

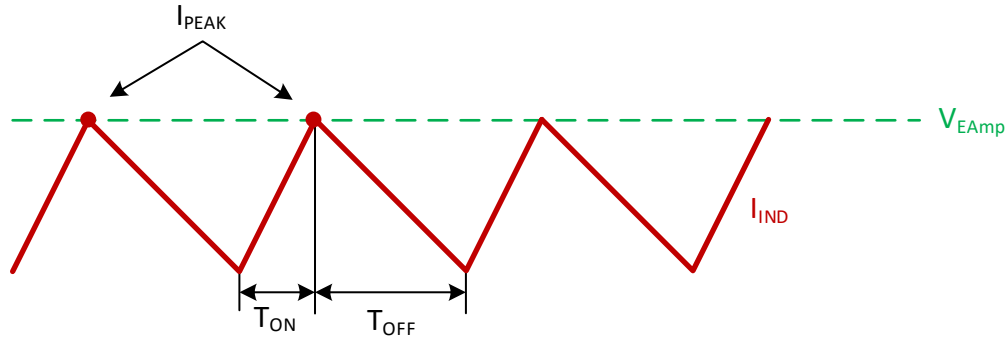

图 9-8. Peak-Current Buck-Boost Operation

9.4.1.4 Buck Operation

When V_I is greater than V_O (and the voltages are not close enough to trigger buck-boost operation), the TPS63805, TPS63806, and TPS63807 operate in buck mode where the buck high-side and low-side switches are active. The boost high-side switch is always turned on and the boost low-side switch is always turned off. This lets the TPS63805, TPS63806, and TPS63807 operate as a classical buck converter.

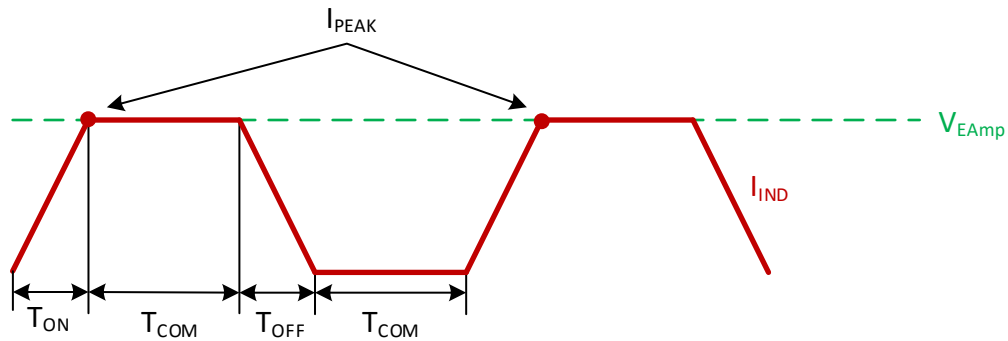

图 9-9. Peak-Current Buck Operation

9.4.2 Power Save Mode Operation

Besides continuous conduction mode (PWM), the TPS63805, TPS63806, and TPS63807 feature power safe mode (PFM) operation to achieve high efficiency at light load currents. This is implemented by pausing the switching operation, depending on the load current.

The skip comparator manages the switching or pause operation. It compares the current demand signal from the voltage loop, I_{REF} , with the skip threshold, I_{SKIP} , as shown in 图 9-1. If the current demand is lower than the skip value, the comparator pauses switching. If the current demand goes higher (due to falling V_O), the comparator activates the current loop and allows switching according to the loop behavior. Whenever the current loop has risen V_O by bringing charge to the output, the voltage loop output, I_{REF} (respectively V_{EA}), decreases. When I_{REF} falls below I_{SKIP} -hysteresis, it automatically pauses again.

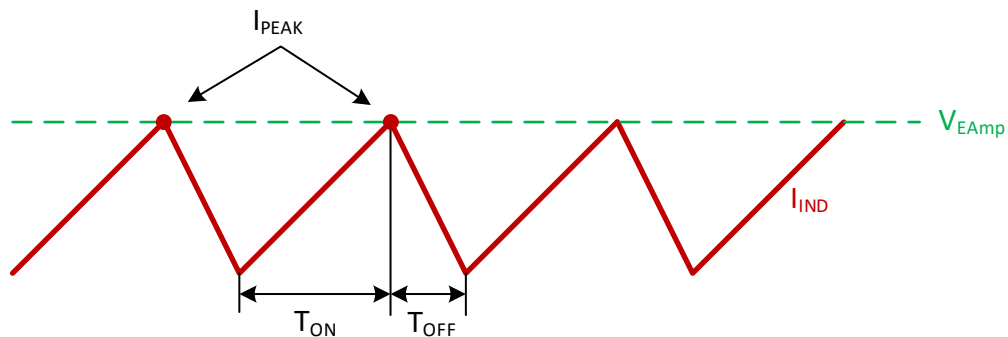

图 9-10. Power Safe Mode Operation Curves

9.4.2.1 Current Limit Operation

To limit current and protect the device and application, the maximum peak inductor current is limited internally on the IC. It is measured at the buck high-side switch which turns into an input current detection. To provide a certain load current across all operation modes, the boost and buck-boost peak current limit is higher than in buck mode. It limits the input current and allows no further increase of the delivered current. When using the device in this mode, it behaves similar to a current source.

The current limit depends on the operation mode (buck, buck-boost, or boost mode).

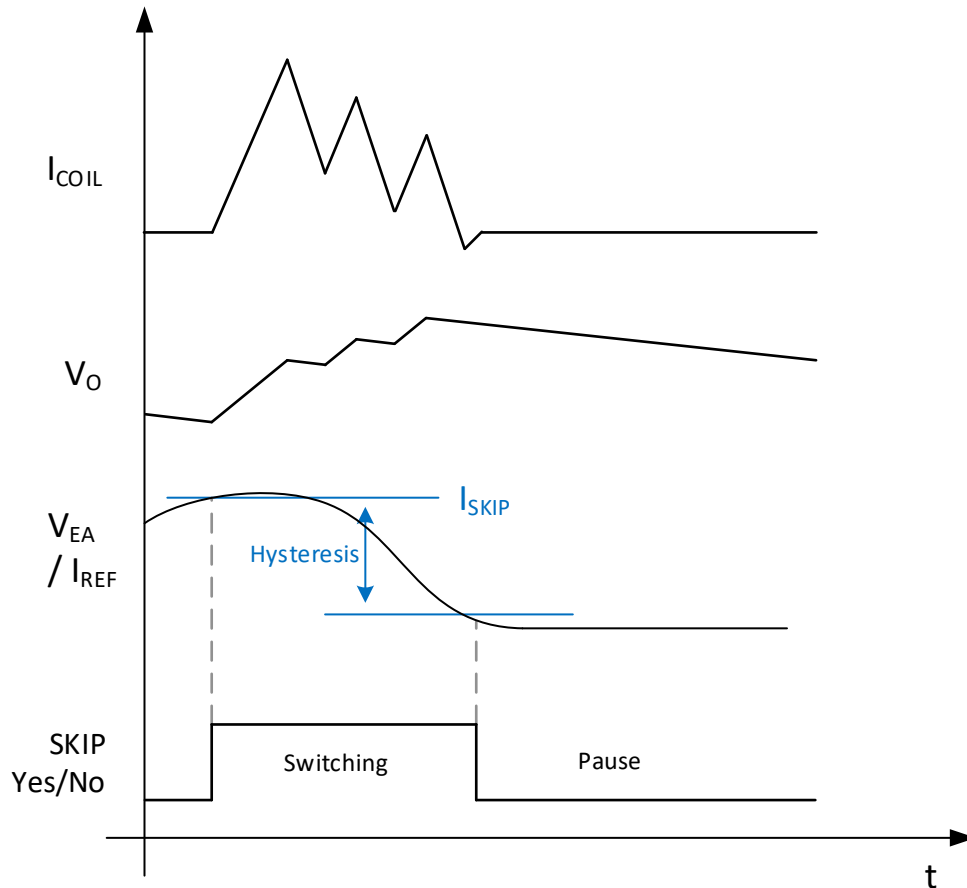
10 Application and Implementation

Note

以下应用部分中的信息不属于 TI 器件规格的范围，TI 不担保其准确性和完整性。TI 的客户应负责确定器件是否适用于其应用。客户应验证并测试其设计，以确保系统功能。

10.1 Application Information

The TPS63805, TPS63806, and TPS63807 are high efficiency, low quiescent current, non-inverting buck-boost converters, suitable for applications that need a regulated output voltage from an input supply that can be higher or lower than the output voltage.

10.2 Typical Application



图 10-1. TPS63805/TPS63807 3.3 V_{OUT} Typical Application



图 10-2. TPS63806 3.3 V_{OUT} Typical Application

10.2.1 Design Requirements

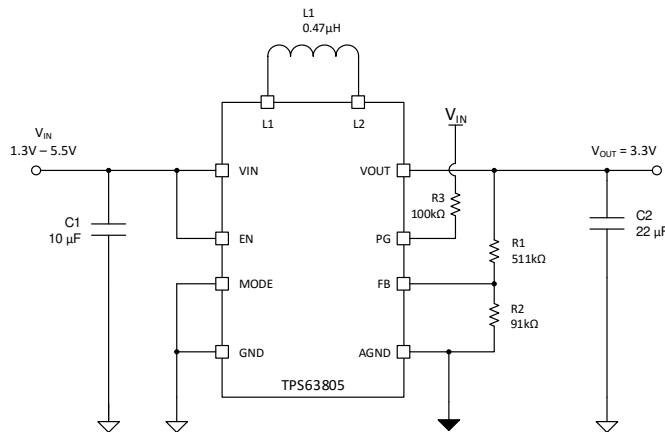
The design guideline provides a component selection to operate the device within 表 10-1.

表 10-1 shows the list of components for the application characteristic curves.

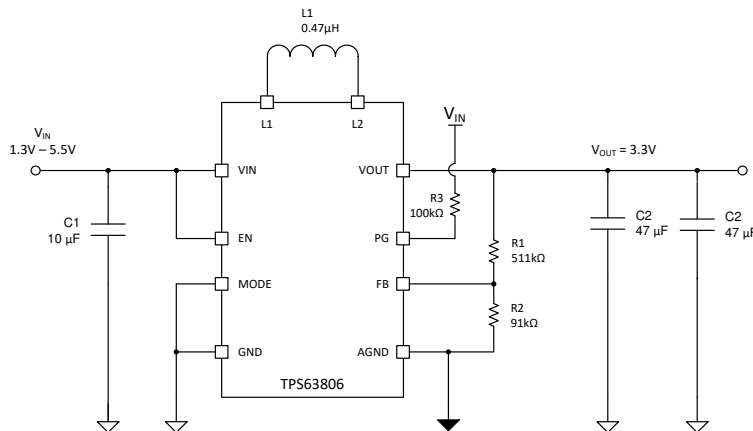
表 10-1. Matrix of Output Capacitor and Inductor Combinations for the TPS63805/TPS63807

NOMINAL INDUCTOR VALUE [μ H] ⁽¹⁾	NOMINAL OUTPUT CAPACITOR VALUE [μ F] ⁽²⁾				
	10	22	47	66	100
0.47	-	+ ⁽³⁾	+	+	+

- (1) Inductor tolerance and current derating is anticipated. The effective inductance can vary by 20% and - 30%.
(2) Capacitance tolerance and DC bias voltage derating is anticipated. The effective capacitance can vary by 20% and - 50%.
(3) TPS63805/TPS63807 typical application. Other check marks indicate possible filter combinations.

表 10-2. Matrix of Output Capacitor and Inductor Combinations for TPS63806

NOMINAL INDUCTOR VALUE [μ H] ⁽¹⁾	NOMINAL OUTPUT CAPACITOR VALUE [μ F] ⁽²⁾				
	10	22	47	66	100
0.47	-	-	+ ⁽¹⁾	+	+

- (1) TPS63806 typical application. Other check marks indicate possible filter combinations.

10.2.2 Detailed Design Procedure

The first step is the selection of the output filter components. To simplify this process, [# 8.1](#) outlines minimum and maximum values for inductance and capacitance. Take tolerance and derating into account when selecting nominal inductance and capacitance.

10.2.2.1 Custom Design With WEBENCH® Tools

[Click here](#) to create a custom design using the TPS63805/TPS63807 device with the WEBENCH® Power Designer. [Click here](#) to create a custom design using the TPS63806 device with the WEBENCH® Power Designer.

1. Start by entering the input voltage (V_{IN}), output voltage (V_{OUT}), and output current (I_{OUT}) requirements.
2. Optimize the design for key parameters such as efficiency, footprint, and cost using the optimizer dial.
3. Compare the generated design with other possible solutions from Texas Instruments.

The WEBENCH Power Designer provides a customized schematic along with a list of materials with real-time pricing and component availability.

In most cases, these actions are available:

- Run electrical simulations to see important waveforms and circuit performance
- Run thermal simulations to understand board thermal performance
- Export customized schematic and layout into popular CAD formats
- Print PDF reports for the design, and share the design with colleagues

Get more information about WEBENCH tools at www.ti.com/WEBENCH.

10.2.2.2 Inductor Selection

The inductor selection is affected by several parameters such as the following:

- Inductor ripple current
- Output voltage ripple
- Transition point into power save mode
- Efficiency

See [表 10-3](#) for typical inductors.

For high efficiencies, the inductor must have a low DC resistance to minimize conduction losses. Especially at high-switching frequencies, the core material has a high impact on efficiency. When using small chip inductors, the efficiency is reduced, mainly due to higher inductor core losses. This needs to be considered when selecting the appropriate inductor. The inductor value determines the inductor ripple current. The larger the inductor value, the smaller the inductor ripple current and the lower the conduction losses of the converter. Conversely, larger inductor values cause a slower load transient response. To avoid saturation of the inductor, the peak current for

the inductor in steady-state operation is calculated using 方程式 2. Only the equation which defines the switch current in boost mode is shown because this provides the highest value of current and represents the critical current value for selecting the right inductor.

$$\text{Duty Cycle Boost} \quad D = \frac{V_{\text{OUT}} - V_{\text{IN}}}{V_{\text{OUT}}} \quad (1)$$

$$I_{\text{PEAK}} = \frac{I_{\text{out}}}{\eta \times (1 - D)} + \frac{V_{\text{in}} \times D}{2 \times f \times L} \quad (2)$$

where

- D = Duty Cycle in Boost mode
- f = Converter switching frequency
- L = Inductor value
- η = Estimated converter efficiency (use the number from the efficiency curves or 0.9 as an assumption)

Note

The calculation must be done for the minimum input voltage in boost mode.

Calculating the maximum inductor current using the actual operating conditions gives the minimum saturation current of the inductor needed. It is recommended to choose an inductor with a saturation current 20% higher than the value calculated using 方程式 2. 表 10-3 lists the possible inductors.

表 10-3. List of Recommended Inductors

INDUCTOR VALUE [μH]	SATURATION CURRENT [A]	DCR [m Ω]	PART NUMBER	MANUFACTURER ⁽¹⁾	SIZE (LxWxH mm)
0.47	5.4	7.6	XFL4015-471ME	Coilcraft	4 x 4 x 2
0.47	5.5	26	DFE201612E	Toko	2.0 x 1.6 x 1.2

(1) See [Third-party Products Disclaimer](#).

10.2.2.3 Output Capacitor Selection

For the output capacitor, it is recommended to use small ceramic capacitors placed as close as possible to the VOUT and PGND pins of the IC. The recommended nominal output capacitor value is a single 22 μF for the TPS63805/TPS63807 and 2x47 μF for the TPS63806 for all programmed output voltages ≤ 3.6 V. Above that voltage, 2x22 μF for the TPS63805/TPS63807 and 3x47 μF for the TPS63806 capacitors are recommended.

It is important that the effective capacitance is given according to the recommended value in 节 8.3. In general, consider DC bias effects resulting in less effective capacitance. The choice of the output capacitance is mainly a trade-off between size and transient behavior since higher capacitance reduces transient response overshoot and undershoot and increases transient response time. 表 10-4 lists possible output capacitors.

There is no upper limit for the output capacitance value.

表 10-4. List of Recommended Capacitors⁽¹⁾

CAPACITOR [μF]	VOLTAGE RATING [V]	ESR [m Ω]	PART NUMBER	MANUFACTURER	SIZE (METRIC)
22	6.3	10	GRM188R60J226MEA0	Murata	0603 (1608)
22	6.3	10	GRM187R61A226ME15	Murata	0603 (1608)
22	10	40	GRM188R61A226ME15	Murata	0603 (1608)
22	10	10	GRM187R60J226ME15	Murata	0603 (1608)
47	6.3	43	GRM188R60J476ME15	Murata	0603 (1608)

表 10-4. List of Recommended Capacitors⁽¹⁾ (continued)

CAPACITOR [μF]	VOLTAGE RATING [V]	ESR [mΩ]	PART NUMBER	MANUFACTURER	SIZE (METRIC)
47	6.3	43	GRM219R60J476ME44	Murata	0805 (2012)

(1) See [Third-party Products Disclaimer](#).

10.2.2.4 Input Capacitor Selection

A 10 μF input capacitor is recommended to improve line transient behavior of the regulator and EMI behavior of the total power supply circuit. An X5R or X7R ceramic capacitor placed as close as possible to the VIN and PGND pins of the IC is recommended. This capacitance can be increased without limit. If the input supply is located more than a few inches from the TPS63805, TPS63806, and TPS63807 converter, additional bulk capacitance can be required in addition to the ceramic bypass capacitors. An electrolytic or tantalum capacitor with a value of 47 μF is a typical choice.

表 10-5. List of Recommended Capacitors⁽¹⁾

CAPACITOR [μF]	VOLTAGE RATING [V]	ESR [mΩ]	PART NUMBER	MANUFACTURER	SIZE (METRIC)
10	6.3	10	GRM188R60J106ME84	Murata	0603 (1608)
10	10	40	GRM188R61A106ME69	Murata	0603 (1608)
22	6.3	10	GRM188R60J226MEA0	Murata	0603 (1608)

10.2.2.5 Setting The Output Voltage

The output voltage is set by an external resistor divider. The resistor divider must be connected between VOUT, FB, and GND. The feedback voltage is 500 mV nominal. The low-side resistor R2 (between FB and GND) must not exceed 100 kΩ. The high-side resistor (between FB and VOUT) R1 is calculated by [方程式 3](#).

$$R1 = R2 \times \left(\frac{V_{OUT}}{V_{FB}} - 1 \right) \quad (3)$$

where

- $V_{FB} = 500 \text{ mV}$

表 10-6. Resistor Selection for Typ. Voltages

V_O [V]	R1 [kΩ]	R2 [kΩ]
2.5	365	91
3.3	511	91
3.6	562	91
5	806	91

10.2.3 Application Curves

表 10-7. Components for Application Characteristic Curves⁽¹⁾

REFERENCE	DESCRIPTION	PART NUMBER	MANUFACTURER	COMMENT
L1	0.47μH, 4 mm x 4 mm x 1.5 mm, 5.4 A, 7.6 mΩ	XFL4015-471ME	Coilcraft	
C1	10 μF, 0603, Ceramic Capacitor, ±20%, 6.3 V	GRM188R60J106ME84	Murata	
C2	TPS63805 1x 22 μF, 0603, Ceramic Capacitor, ±20%, 10 V	GRM188R61A226ME15	Murata	TPS63805/TPS63807, $V_O \leq 3.6 \text{ V}$
C2	TPS63806 2x 47 μF, 0603, Ceramic Capacitor, ±20%, 6.3 V	GRM188R60J476ME15	Murata	TPS63806, $V_O \leq 3.6 \text{ V}$
C2	TPS63805 2x 22 μF, 0603, Ceramic Capacitor, ±20%, 10 V	GRM188R61A226ME15	Murata	TPS63805/TPS63807, $V_O > 3.6 \text{ V}$

表 10-7. Components for Application Characteristic Curves ⁽¹⁾ (continued)

REFERENCE	DESCRIPTION	PART NUMBER	MANUFACTURER	COMMENT
C2	TPS63806 3x 47 μ F, 0603, Ceramic Capacitor, \pm 20%, 6.3 V	GRM188R60J476ME15	Murata	TPS63806, $V_O > 3.6$ V
R1	511 k Ω , 0603 Resistor, 1%, 100 mW	Standard	Standard	$V_O = 3.3$ V
R1	562 k Ω , 0603 Resistor, 1%, 100 mW	Standard	Standard	$V_O = 3.6$ V
R1	806 k Ω , 0603 Resistor, 1%, 100 mW	Standard	Standard	$V_O = 5$ V
R2	91 k Ω , 0603 Resistor, 1%, 100 mW	Standard	Standard	
R3	100 k Ω , 0603 Resistor, 1%, 100 mW	Standard	Standard	

(1) See [Third-party Products Disclaimer](#).

表 10-8. Typical Characteristics Curves

PARAMETER	CONDITIONS	FIGURE
Output Current Capability		
Typical Output Current Capability versus Input Voltage	$V_O = 3.3\text{ V}$, TPS63805/TPS63807	图 10-3
Typical Output Current Capability versus Input Voltage	$V_O = 3.3\text{ V}$, TPS63806	图 10-4
Switching Frequency (TPS63805, TPS63806, TPS63807)		
Typical Inductor Switching Frequency versus Input Voltage	$I_O = 0\text{ A}$, MODE = High	图 10-5
Typical Inductor Burst Frequency versus Output Current	$V_O = 3.3\text{ V}$	图 10-6
Efficiency (TPS63805/TPS63807)		
Efficiency versus Output Current (PFM/PWM)	$V_I = 2.5\text{ V to }4.2\text{ V}$, $V_O = 3.3\text{ V}$, MODE = Low	图 10-7
Efficiency versus Output Current (PWM only)	$V_I = 2.5\text{ V to }4.2\text{ V}$, $V_O = 3.3\text{ V}$, MODE = High	图 10-8
Efficiency versus Output Current (PFM/PWM)	$V_I = 1.8\text{ V to }5\text{ V}$, $V_O = 3.3\text{ V}$, MODE = Low	图 10-9
Efficiency versus Output Current (PWM only)	$V_I = 1.8\text{ V to }5\text{ V}$, $V_O = 3.3\text{ V}$, MODE = High	图 10-10
Efficiency versus Input Voltage (PFM/PWM)	$V_O = 3.3\text{ V}$, MODE = Low	图 10-11
Efficiency versus Input Voltage (PWM only)	$I_O = 1\text{ A}$, MODE = High	图 10-12
Efficiency (TPS63806)		
Efficiency versus Output Current (PFM/PWM)	$V_I = 2.5\text{ V to }4.2$, $V_O = 3.3\text{ V}$, MODE = Low	图 10-13
Efficiency versus Output Current (PWM only)	$V_I = 2.5\text{ V to }4.2$, $V_O = 3.3\text{ V}$, MODE = High	图 10-14
Efficiency versus Output Current (PFM/PWM)	$V_I = 1.8\text{ V to }5$, $V_O = 3.3\text{ V}$, MODE = Low	图 10-15
Efficiency versus Output Current (PWM only)	$V_I = 2.5\text{ V to }5$, $V_O = 3.3\text{ V}$, MODE = High	图 10-18
Efficiency versus Input Voltage (PFM/PWM)	$V_O = 3.3\text{ V}$, MODE = Low	图 10-17
Efficiency versus Input Voltage (PWM only)	$I_O = 1\text{ A}$, MODE = High	图 10-18
Regulation Accuracy (TPS63805/TPS63807)		
Load Regulation, PWM Operation	$V_O = 3.3\text{ V}$, MODE = High	图 10-19
Load Regulation, PFM/PWM Operation	$V_O = 3.3\text{ V}$, MODE = Low	图 10-20
Line Regulation, PWM Operation	$I_O = 1\text{ A}$, MODE = High	图 10-21
Line Regulation, PFM/PWM Operation	$I_O = 1\text{ A}$, MODE = Low	图 10-22
Regulation Accuracy (TPS63806)		
Load Regulation, PWM Operation	$V_O = 3.3\text{ V}$, MODE = High	图 10-23
Load Regulation, PFM/PWM Operation	$V_O = 3.3\text{ V}$, MODE = Low	图 10-24
Line Regulation, PWM Operation	$I_O = 1\text{ A}$, MODE = High	图 10-25
Line Regulation, PFM/PWM Operation	$I_O = 1\text{ A}$, MODE = Low	图 10-26
Switching Waveforms (TPS63805, TPS63806, TPS63807)		
Switching Waveforms, PFM Boost Operation	$V_I = 2.3\text{ V}$, $V_O = 3.3\text{ V}$, MODE = Low	图 10-27
Switching Waveforms, PFM Buck-Boost Operation	$V_I = 3.3\text{ V}$, $V_O = 3.3\text{ V}$, MODE = Low	图 10-28
Switching Waveforms, PFM Buck Operation	$V_I = 4.3\text{ V}$, $V_O = 3.3\text{ V}$, MODE = Low	图 10-29
Switching Waveforms, PWM Boost Operation	$V_I = 2.3\text{ V}$, $V_O = 3.3\text{ V}$, MODE = High	图 10-30
Switching Waveforms, PWM Buck-Boost Operation	$V_I = 3.3\text{ V}$, $V_O = 3.3\text{ V}$, MODE = High	图 10-31
Switching Waveforms, PWM Buck Operation	$V_I = 4.3\text{ V}$, $V_O = 3.3\text{ V}$, MODE = High	图 10-32
Transient Performance (TPS63805/TPS63807)		
Load Transient, PFM/PWM Boost Operation	$V_I = 2.5\text{ V}$, $V_O = 3.3\text{ V}$, Load = 100 mA to 1A, MODE = Low	图 10-33
Load Transient, PFM/PWM Buck-Boost Operation	$V_I = 3.3\text{ V}$, $V_O = 3.3\text{ V}$, Load = 100 mA to 1A, MODE = Low	图 10-34
Load Transient, PFM/PWM Buck Operation	$V_I = 4.2\text{ V}$, $V_O = 3.3\text{ V}$, Load = 100 mA to 1A, MODE = Low	图 10-35

表 10-8. Typical Characteristics Curves (continued)

PARAMETER	CONDITIONS	FIGURE
Load Transient, PWM Boost Operation	$V_I = 2.5\text{ V}$, $V_O = 3.3\text{ V}$, Load = 100 mA to 1A, MODE = High	图 10-36
Load Transient, PWM Buck-Boost Operation	$V_I = 3.3\text{ V}$, $V_O = 3.3\text{ V}$, Load = 100 mA to 1A, MODE = High	图 10-37
Load Transient, PWM Buck Operation	$V_I = 4.2\text{ V}$, $V_O = 3.3\text{ V}$, Load = 100 mA to 1A, MODE = High	图 10-38
Line Transient, PWM Operation	$V_I = 2.3\text{ V}$ to 4.3 V , $V_O = 3.3\text{ V}$, Load = 0.5 A, MODE = Low	图 10-39
Line Transient, PWM Operation	$V_I = 2.3\text{ V}$ to 4.3 V , $V_O = 3.3\text{ V}$, Load = 1 A, MODE = Low	图 10-40
Line Transient, PWM Operation	$V_I = 3\text{ V}$ to 3.6 V , $V_O = 3.3\text{ V}$, Load = 0.5 A, MODE = Low	图 10-41
Transient Performance (TPS63806)		
Load Transient, PFM/PWM Boost Operation	$V_I = 2.3\text{ V}$, $V_O = 3.3\text{ V}$, Load = 25% to 75%, MODE = Low	图 10-42
Load Transient, PFM/PWM Buck-Boost Operation	$V_I = 3.3\text{ V}$, $V_O = 3.3\text{ V}$, Load = 25% to 75%, MODE = Low	图 10-43
Load Transient, PFM/PWM Buck Operation	$V_I = 4.3\text{ V}$, $V_O = 3.3\text{ V}$, Load = 25% to 75%, MODE = Low	图 10-44
Load Transient, PWM Boost Operation	$V_I = 2.3\text{ V}$, $V_O = 3.3\text{ V}$, Load = 25% to 75%, MODE = High	图 10-45
Load Transient, PWM Buck-Boost Operation	$V_I = 3.3\text{ V}$, $V_O = 3.3\text{ V}$, Load = 25% to 75%, MODE = High	图 10-46
Load Transient, PWM Buck Operation	$V_I = 4.3\text{ V}$, $V_O = 3.3\text{ V}$, Load = 25% to 75%, MODE = High	图 10-47
Line Transient, PWM Operation	$V_I = 2.3\text{ V}$ to 4.3 V , $V_O = 3.3\text{ V}$, Load = 0.5 A, MODE = Low	图 10-48
Line Transient, PWM Operation	$V_I = 2.3\text{ V}$ to 4.3 V , $V_O = 3.3\text{ V}$, Load = 1 A, MODE = Low	图 10-49
Line Transient, PWM Operation	$V_I = 3\text{ V}$ to 3.6 V , $V_O = 3.3\text{ V}$, Load = 0.5 A, MODE = Low	图 10-50
Pulsed load, PWM Operation	$V_I = 2.8\text{ V}$, $V_O = 3.3\text{ V}$, Load = 50 mA to 5 A, with 1 MHz and 50% duty cycle, $t_r = 120\text{ ns}$, $t_f = 60\text{ ns}$, MODE = High	图 10-51
Pulsed load, PWM Operation	$V_I = 3.3\text{ V}$, $V_O = 3.3\text{ V}$, Load = 50 mA to 5 A, with 1 MHz and 50% duty cycle, $t_r = 120\text{ ns}$, $t_f = 60\text{ ns}$, MODE = High	图 10-52
Pulsed load, PWM Operation	$V_I = 4.2\text{ V}$, $V_O = 3.3\text{ V}$, Load = 50 mA to 5 A, with 1 MHz and 50% duty cycle, $t_r = 120\text{ ns}$, $t_f = 60\text{ ns}$, MODE = High	图 10-53
Start-up (TPS63805, TPS63806, TPS63807)		
Start-up Behavior from Rising Enable, PFM Operation	$V_I = 2.2\text{ V}$, $V_O = 3.3\text{ V}$, Load = 10 mA, MODE = Low	图 10-54
Start-up Behavior from Rising Enable, PWM Operation	$V_I = 2.2\text{ V}$, $V_O = 3.3\text{ V}$, Load = 10 mA, MODE = High	图 10-55



图 10-3. Typical Output Current Capability versus Input Voltage



图 10-4. Typical Output Current Capability versus Input Voltage

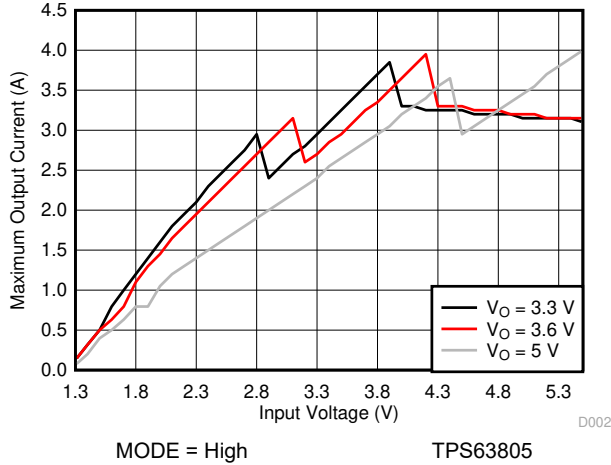

图 10-5. Typical Inductor Switching Frequency versus Input Voltage

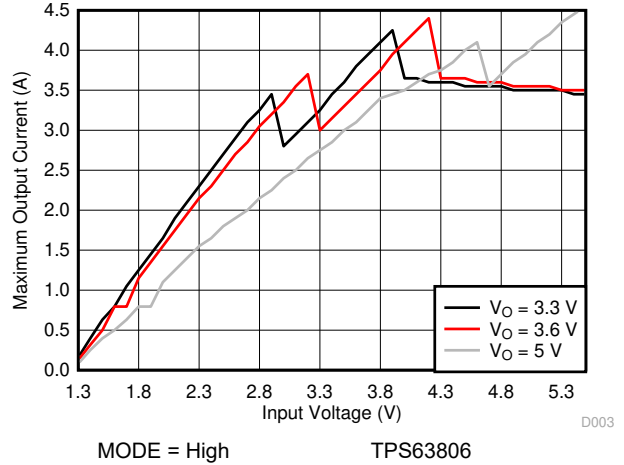

图 10-6. Typical Inductor Burst Frequency versus Output Current

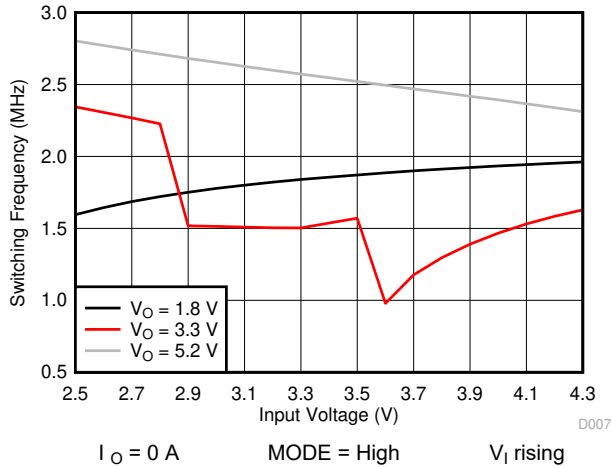

图 10-7. Efficiency versus Output Current (PFM/PWM)

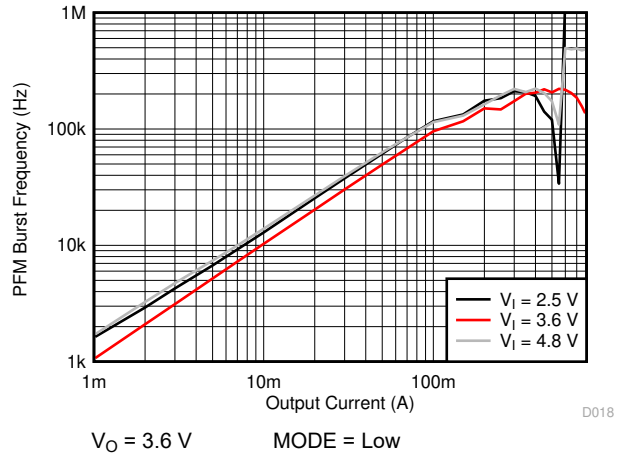

图 10-8. Efficiency versus Output Current (PWM Only)

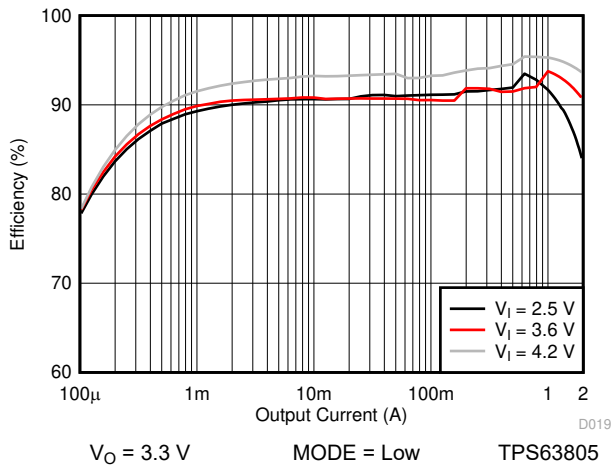

图 10-9. Efficiency versus Output Current (PFM/PWM)

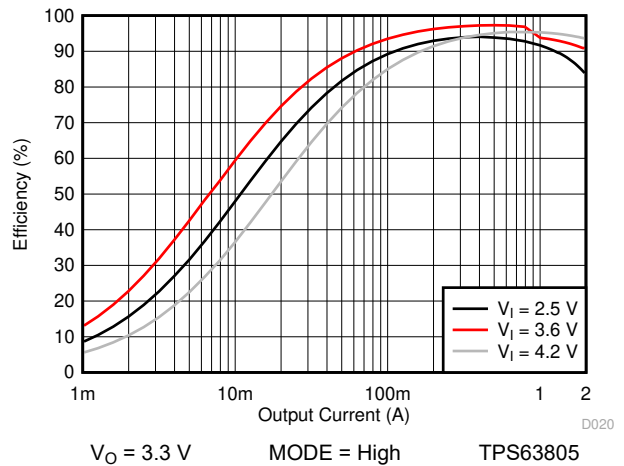

图 10-10. Efficiency versus Input Voltage (PWM Only)

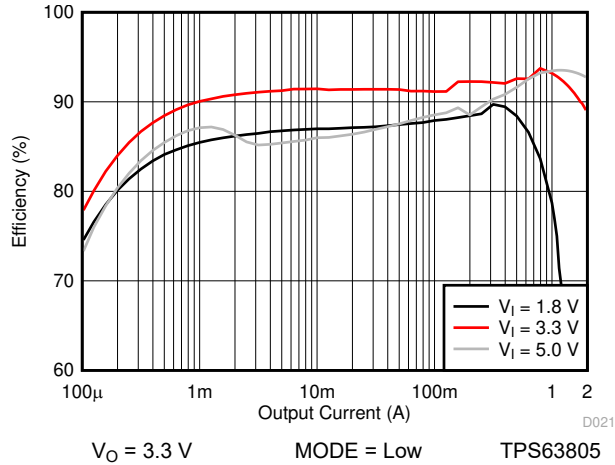

图 10-11. Efficiency versus Input Voltage (PFM/PWM)

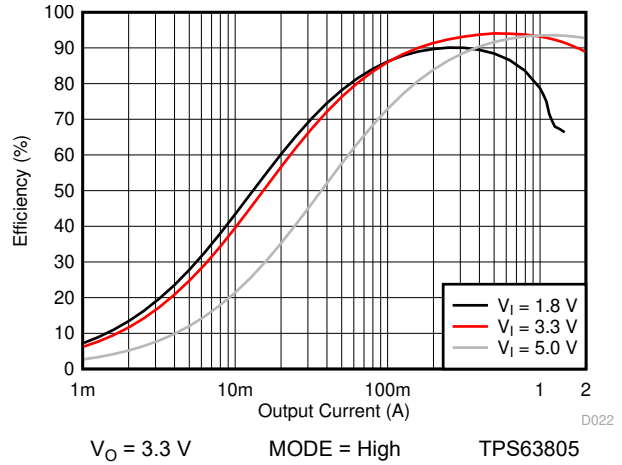

图 10-12. Efficiency versus Input Voltage (PWM Only)

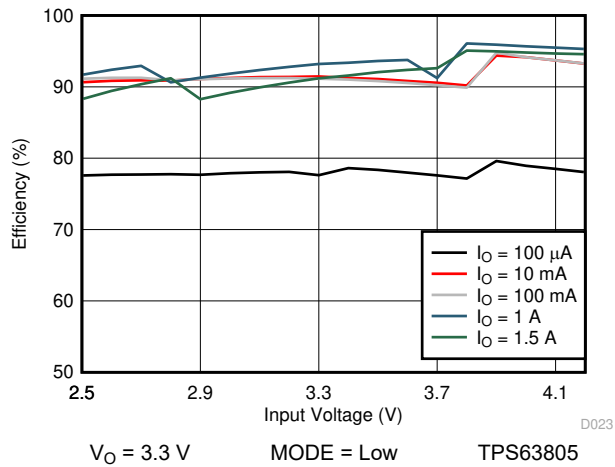

图 10-13. Efficiency versus Output Current (PFM/PWM)

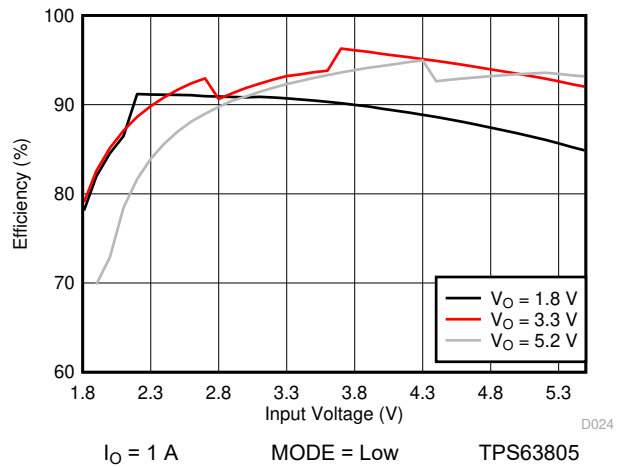

图 10-14. Efficiency versus Output Current (PWM Only)

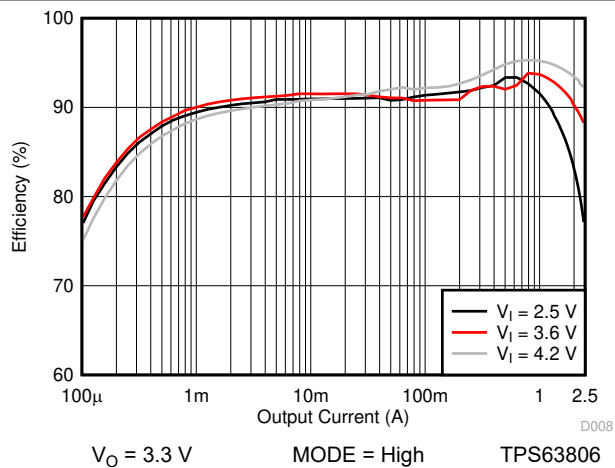

图 10-15. Efficiency versus Output Current (PFM/PWM)

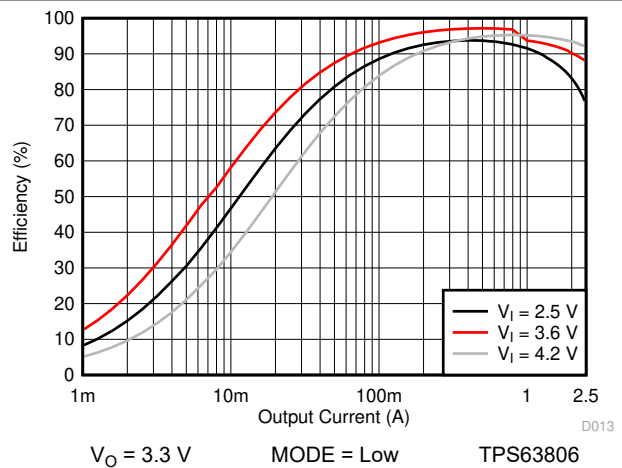

图 10-16. Efficiency versus Input Voltage (PWM Only)

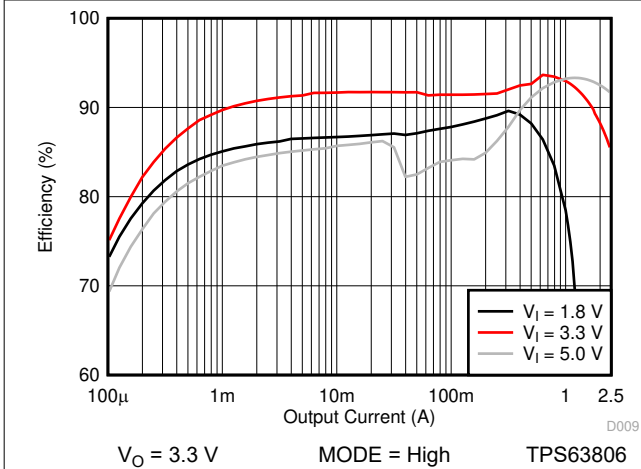

图 10-17. Efficiency versus Input Voltage (PFM/PWM)

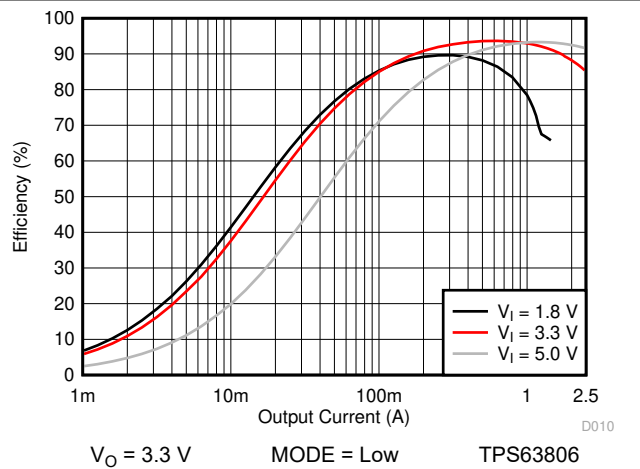

图 10-18. Efficiency versus Input Voltage (PWM Only)

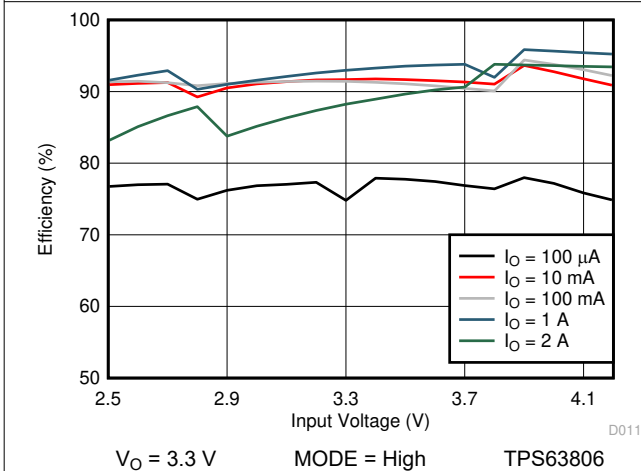

图 10-19. Load Regulation (PWM Only)

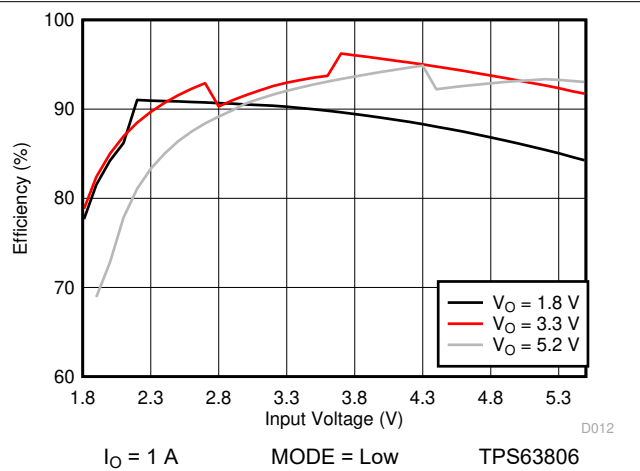

图 10-20. Load Regulation (PFM/PWM)

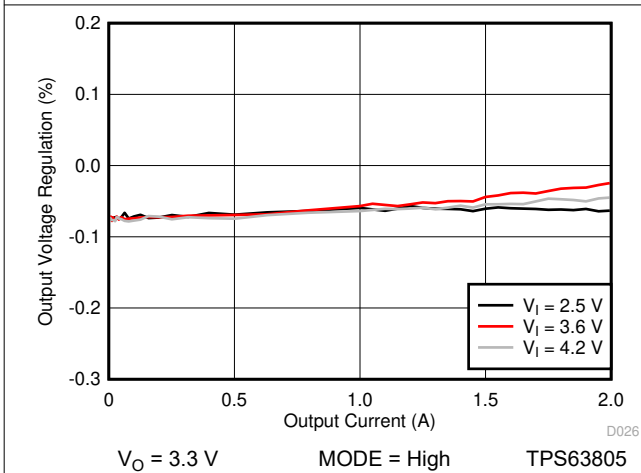

图 10-21. Line Regulation (PWM Only)

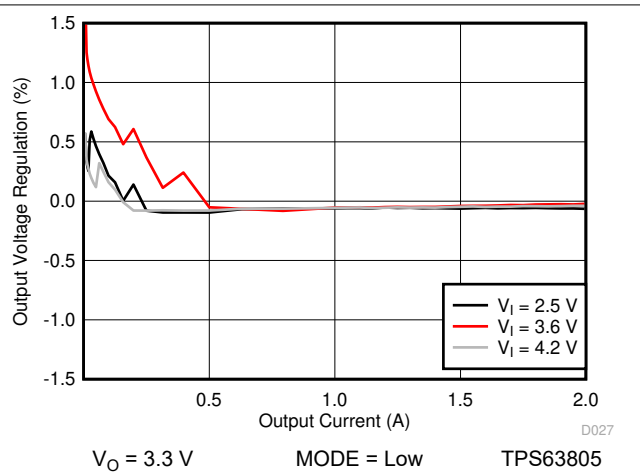

图 10-22. Line Regulation (PFM/PWM)

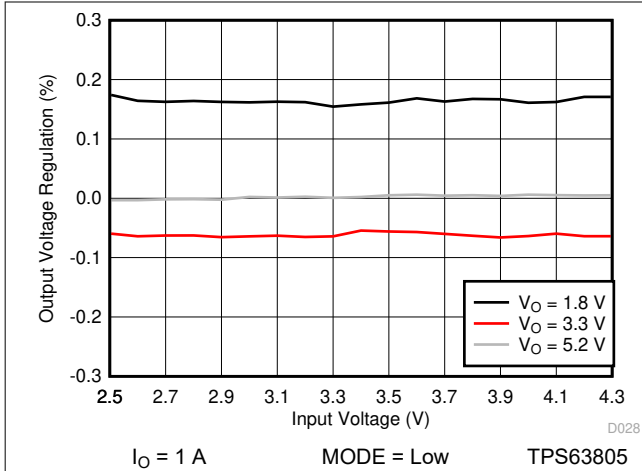

图 10-23. Load Regulation (PWM Only)

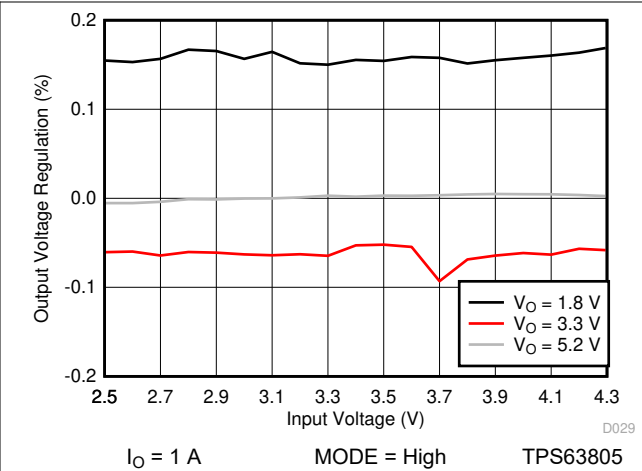

图 10-24. Load Regulation (PFM/PWM)

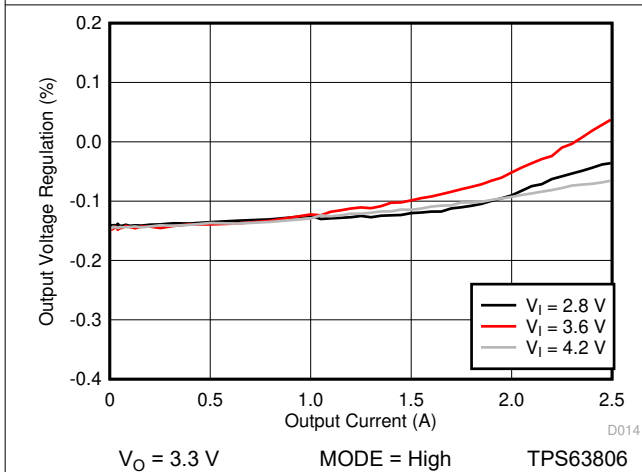

图 10-25. Line Regulation (PWM Only)

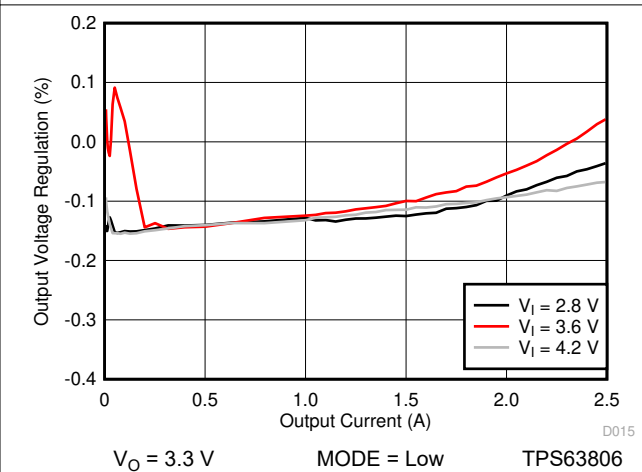

图 10-26. Line Regulation (PFM/PWM)

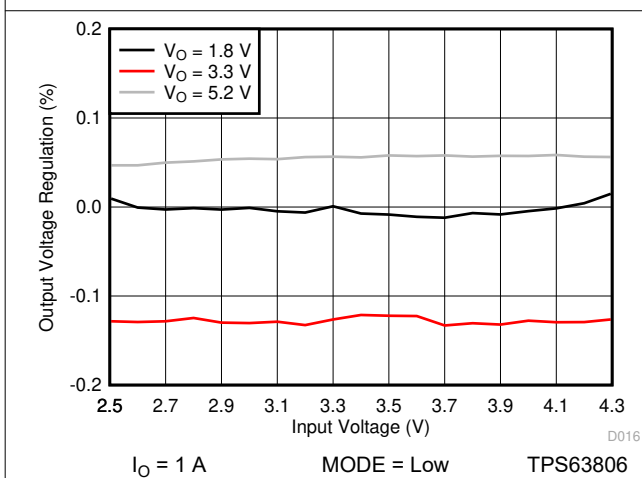

$V_I = 2.3 \text{ V}, V_O = 3.3 \text{ V}$
MODE = Low $I_O = 40 \text{ mA}$

图 10-27. Switching Waveforms, PFM Boost Operation

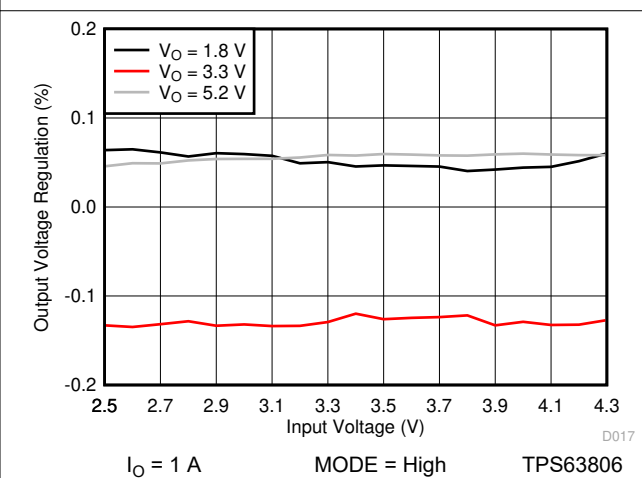
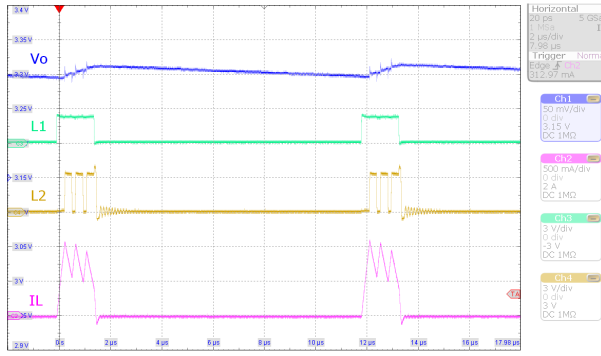
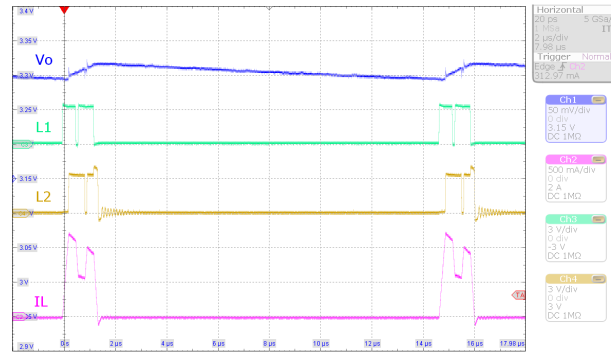

$V_I = 3.3 \text{ V}, V_O = 3.3 \text{ V}$
MODE = Low $I_O = 40 \text{ mA}$

图 10-28. Switching Waveforms, PFM Buck-Boost Operation

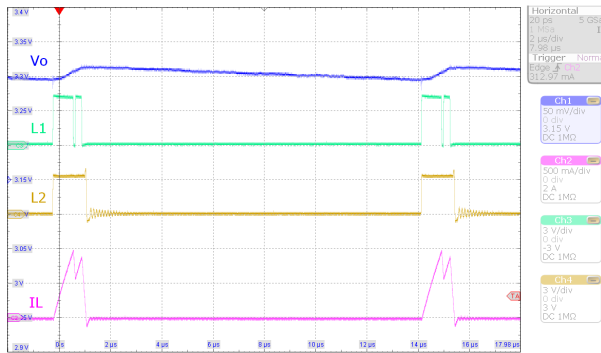

$V_I = 4.2 \text{ V}, V_O = 3.3 \text{ V}$ MODE = Low $I_O = 40 \text{ mA}$

图 10-29. Switching Waveforms, PFM Buck Operation

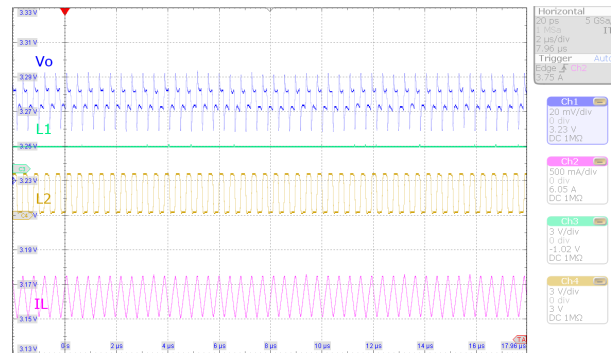

$V_I = 2.3 \text{ V}, V_O = 3.3 \text{ V}$
MODE = Low $I_O = 2 \text{ A}$

图 10-30. Switching Waveforms, PWM Boost Operation

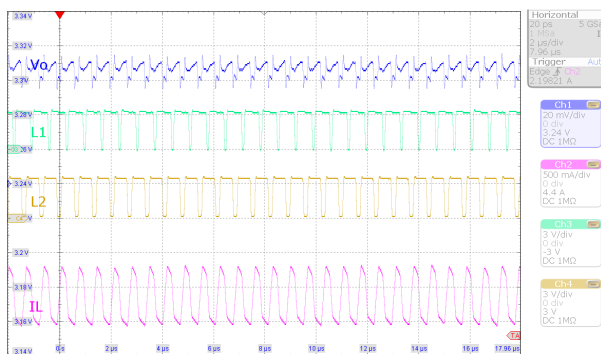

$V_I = 3.3 \text{ V}, V_O = 3.3 \text{ V}$
MODE = Low $I_O = 2 \text{ A}$

图 10-31. Switching Waveforms, PWM Buck-Boost Operation

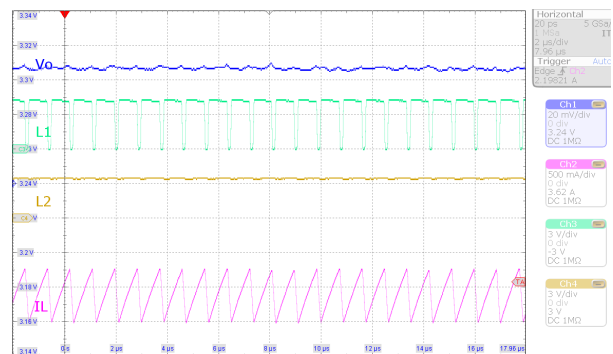

$V_I = 4.2 \text{ V}, V_O = 3.3 \text{ V}$
MODE = Low $I_O = 2 \text{ A}$

图 10-32. Switching Waveforms, PWM Buck Operation

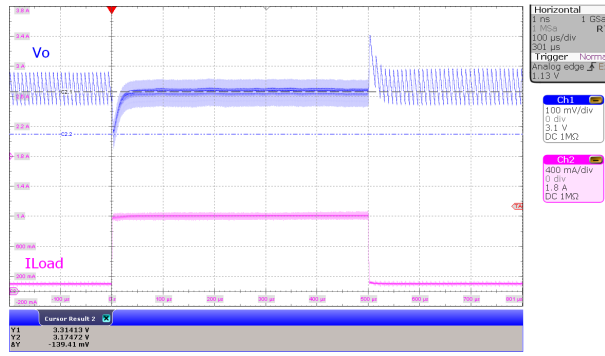

$V_I = 2.5\text{ V}, V_O = 3.3\text{ V}$
 I_O from 100 mA to 1 A $t_r = 1\ \mu\text{s}, t_f = 1\ \mu\text{s}$
TPS63805 MODE = Low

图 10-33. Load Transient, PFM/PWM Boost Operation

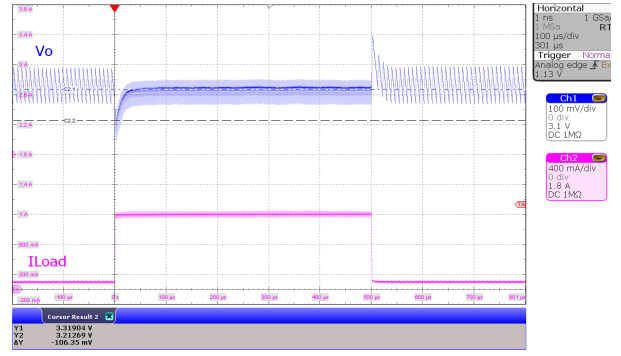

$V_I = 3.3\text{ V}, V_O = 3.3\text{ V}$
 I_O from 100 mA to 1 A $t_r = 1\ \mu\text{s}, t_f = 1\ \mu\text{s}$
TPS63805 MODE = Low

图 10-34. Load Transient, PFM/PWM Buck-Boost Operation

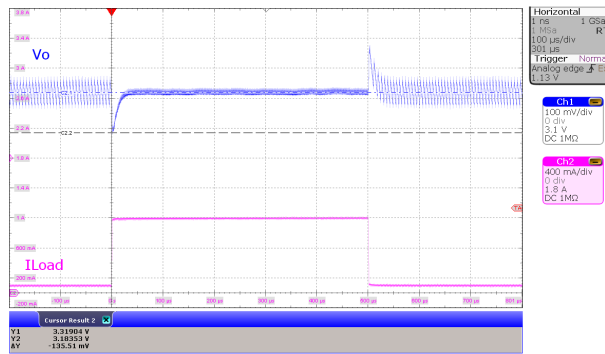

$V_I = 5\text{ V}, V_O = 3.3\text{ V}$
 I_O from 100 mA to 1 A $t_r = 1\ \mu\text{s}, t_f = 1\ \mu\text{s}$
TPS63805 MODE = Low

图 10-35. Load Transient, PFM/PWM Buck Operation

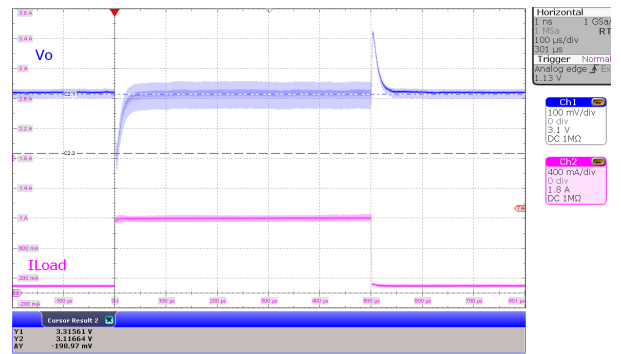

$V_I = 2.5\text{ V}, V_O = 3.3\text{ V}$
 I_O from 100 mA to 1 A $t_r = 1\ \mu\text{s}, t_f = 1\ \mu\text{s}$
TPS63805 MODE = High

图 10-36. Load Transient, PWM Boost Operation

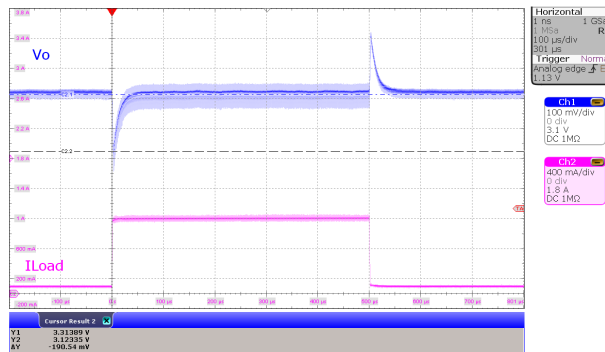

$V_I = 3.3\text{ V}, V_O = 3.3\text{ V}$
 I_O from 100 mA to 1 A $t_r = 1\ \mu\text{s}, t_f = 1\ \mu\text{s}$
TPS63805 MODE = High

图 10-37. Load Transient, PWM Buck-Boost Operation

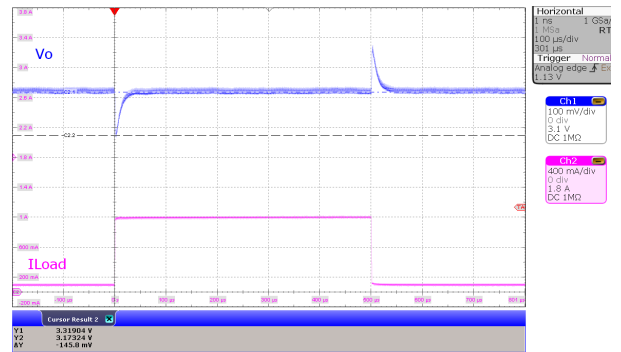

$V_I = 5\text{ V}, V_O = 3.3\text{ V}$
 I_O from 100 mA to 1 A $t_r = 1\ \mu\text{s}, t_f = 1\ \mu\text{s}$
TPS63805 MODE = High

图 10-38. Load Transient, PWM Buck Operation

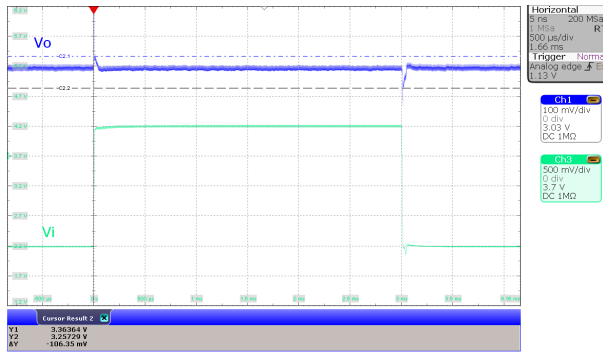

$I_O = 0.5\text{ A}$ V_I from 2.2 V to 4.2 V $t_r = 1\ \mu\text{s}$, $t_f = 1\ \mu\text{s}$ TPS63805 MODE = High

图 10-39. Line Transient, PWM Operation

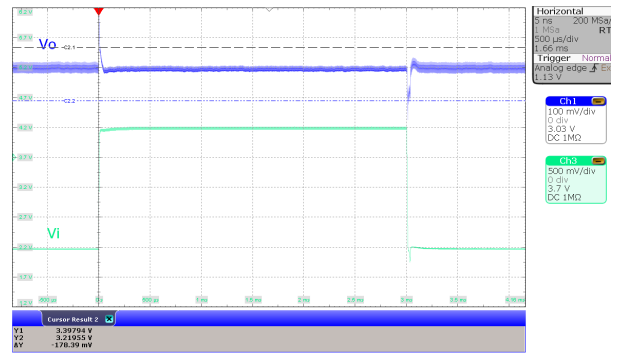

$I_O = 1\text{ A}$ V_I from 2.2 V to 4.2 V $t_r = 1\ \mu\text{s}$, $t_f = 1\ \mu\text{s}$ TPS63805 MODE = High

图 10-40. Line Transient, PWM Operation

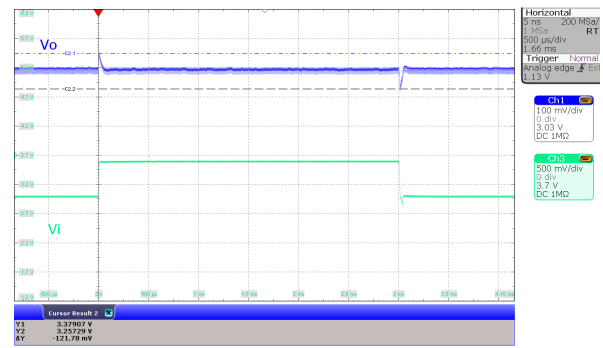

$I_O = 0.5\text{ A}$ V_I from 3 V to 3.6 V $t_r = 1\ \mu\text{s}$, $t_f = 1\ \mu\text{s}$ TPS63805 MODE = High

图 10-41. Line Transient, PWM Operation

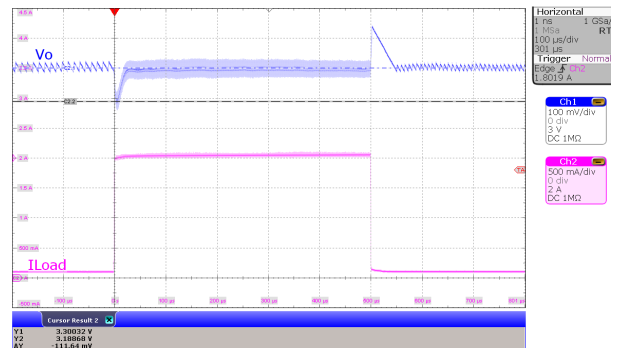

$V_I = 2.8\text{ V}$, $V_O = 3.3\text{ V}$ I_O from 100 mA to 2 A $t_r = 1\ \mu\text{s}$, $t_f = 1\ \mu\text{s}$ TPS63806 MODE = Low

图 10-42. Load Transient, PFM/PWM Boost Operation

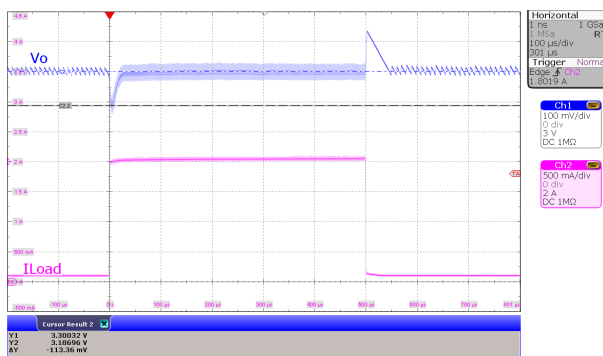

$V_I = 3.3\text{ V}$, $V_O = 3.3\text{ V}$ I_O from 100 mA to 2 A $t_r = 1\ \mu\text{s}$, $t_f = 1\ \mu\text{s}$ TPS63806 MODE = Low

图 10-43. Load Transient, PFM/PWM Buck-Boost Operation

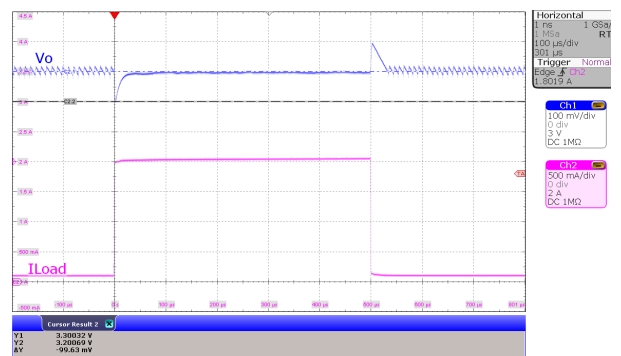

$V_I = 4.2\text{ V}$, $V_O = 3.3\text{ V}$ I_O from 100 mA to 2 A $t_r = 1\ \mu\text{s}$, $t_f = 1\ \mu\text{s}$ TPS63806 MODE = Low

图 10-44. Load Transient, PFM/PWM Buck Operation

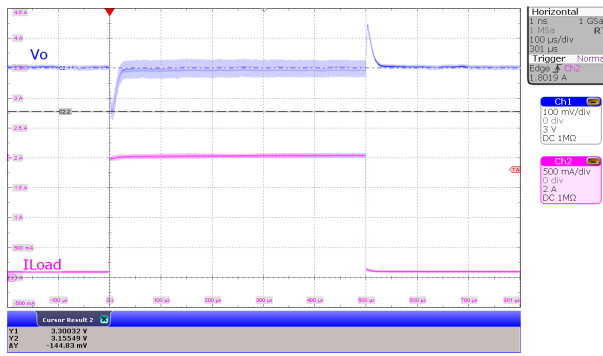

$V_I = 2.8\text{ V}$, $V_O = 3.3\text{ V}$ I_O from 100 mA to 2 A $t_r = t_f = 1\ \mu\text{s}$ TPS63806 MODE = High

图 10-45. Load Transient, PWM Boost Operation

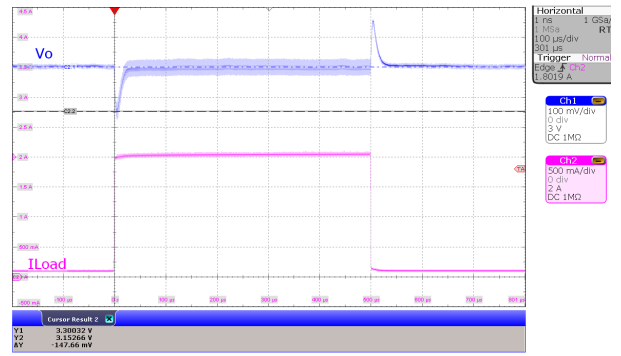

$V_I = 3.3\text{ V}$, $V_O = 3.3\text{ V}$ I_O 100 mA to 2 A $t_r = t_f = 1\ \mu\text{s}$ TPS63806 MODE = High

图 10-46. Load Transient, PWM Buck-Boost Operation

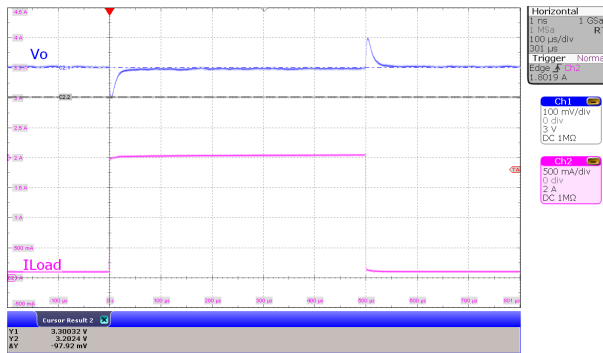

$V_I = 4.2\text{ V}$, $V_O = 3.3\text{ V}$ I_O 100 mA to 2 A $t_r = t_f = 1\ \mu\text{s}$ TPS63806 MODE = High

图 10-47. Load Transient, PWM Buck Operation

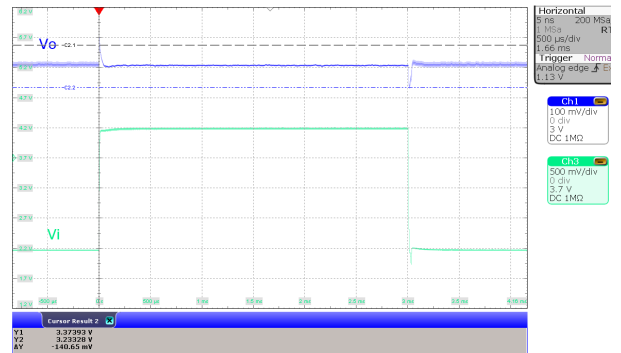

$I_O = 1\text{ A}$ V_I 2.2 V to 4.2 V $t_r = t_f = 1\ \mu\text{s}$ TPS63806 MODE = High

图 10-48. Line Transient, PWM Operation

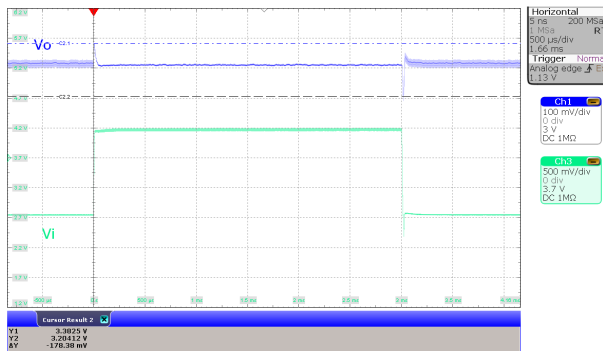

$I_O = 2\text{ A}$ V_I 2.2 V to 4.2 V $t_r = t_f = 1\ \mu\text{s}$ TPS63806 MODE = High

图 10-49. Line Transient, PWM Operation

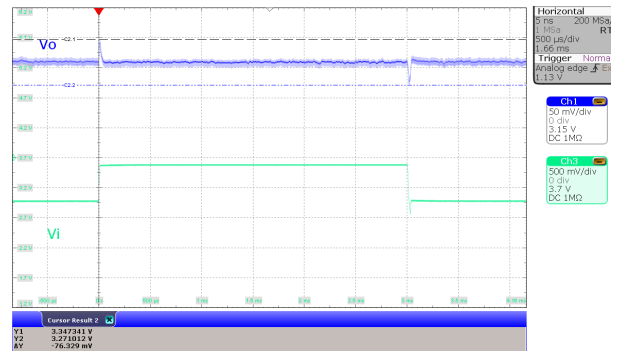

$I_O = 1\text{ A}$ V_I 3.0 V to 3.6 V $t_r = t_f = 1\ \mu\text{s}$ TPS63806 MODE = High

图 10-50. Line Transient, PWM Operation

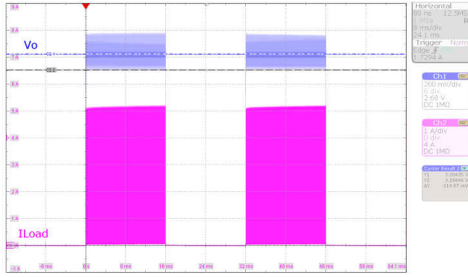

$V_I = 2.8\text{ V}, V_O = 3.3\text{ V}$
 I_O 50 mA to 5 A with 1 MHz and 50% duty cycle $t_r = 120\text{ ns}, t_f = 60\text{ ns}$
 TPS63806
 MODE = High

图 10-51. Pulsed Load, PWM Operation

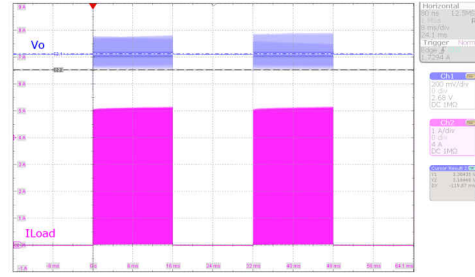

$V_I = 3.3\text{ V}, V_O = 3.3\text{ V}$
 I_O 50 mA to 5 A with 1 MHz and 50% duty cycle $t_r = 120\text{ ns}, t_f = 60\text{ ns}$
 TPS63806
 MODE = High

图 10-52. Pulsed Load, PWM Operation

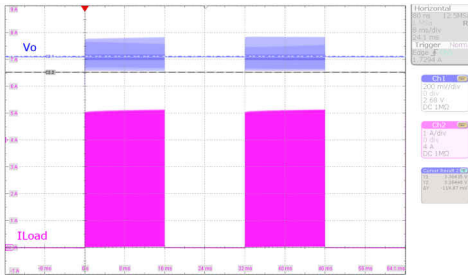

$V_I = 4.2\text{ V}, V_O = 3.3\text{ V}$
 I_O 50 mA to 5 A with 1 MHz and 50% duty cycle $t_r = 120\text{ ns}, t_f = 60\text{ ns}$
 TPS63806
 MODE = High

图 10-53. Pulsed Load, PWM Operation

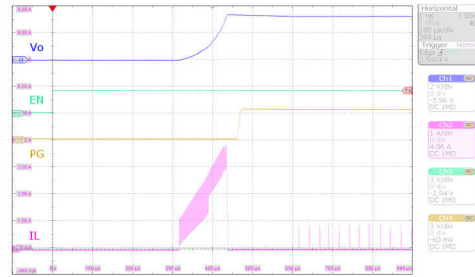

$V_I = 4.2\text{ V}, V_O = 3.3\text{ V}$
 MODE = Low
 100 mΩ resistive load

图 10-54. Start-up Behavior from Rising Enable, PFM Operation

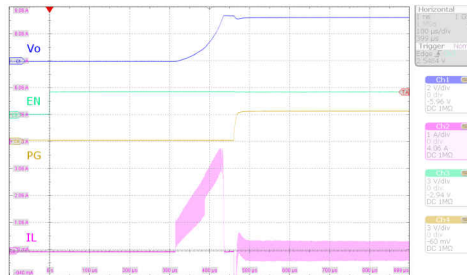

$V_I = 4.2\text{ V}, V_O = 3.3\text{ V}$
 MODE = High
 100 mΩ resistive load

图 10-55. Start-up Behavior from Rising Enable, PWM Operation

11 Power Supply Recommendations

The TPS63805, TPS63806, and TPS63807 device families have no special requirements for its input power supply. The input power supply output current needs to be rated according to the supply voltage, output voltage, and output current of the TPS63805, TPS63806, and TPS63807.

12 Layout

12.1 Layout Guidelines

The PCB layout is an important step to maintain the high performance of the TPS63805, TPS63806, and TPS63807 device.

1. Place input and output capacitors as close as possible to the IC. Traces need to be kept short. Route wide and direct traces to the input and output capacitor results in low trace resistance and low parasitic inductance.
2. Use a common ground node for power ground and a different one for control ground to minimize the effects of ground noise. Connect these ground nodes at any place close to one of the ground pins of the IC.
3. Use separate traces for the supply voltage of the power stage and the supply voltage of the analog stage.
4. The sense trace connected to FB is signal trace. Keep these traces away from L1 and L2 nodes.

12.2 Layout Example



图 12-1. TPS63805, TPS63806, and TPS63807 Layout

13 Device and Documentation Support

13.1 Device Support

13.1.1 第三方产品免责声明

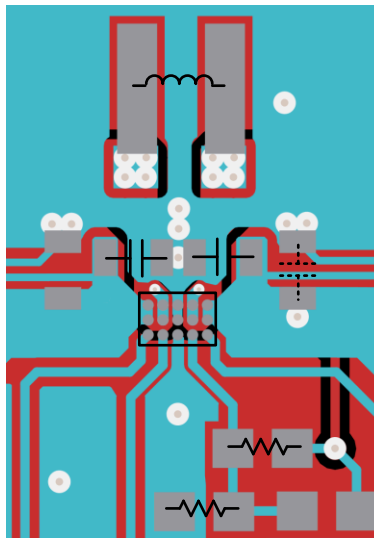
TI 发布的与第三方产品或服务有关的信息，不能构成与此类产品或服务或保修的适用性有关的认可，不能构成此类产品或服务单独或与任何 TI 产品或服务一起的表示或认可。

13.1.2 Development Support

[QFN/SON Package FAQs](#)

13.1.2.1 Custom Design With WEBENCH® Tools

[Click here](#) to create a custom design using the TPS63805/TPS63807 device with the WEBENCH® Power Designer. [Click here](#) to create a custom design using the TPS63806 device with the WEBENCH® Power Designer.

1. Start by entering the input voltage (V_{IN}), output voltage (V_{OUT}), and output current (I_{OUT}) requirements.
2. Optimize the design for key parameters such as efficiency, footprint, and cost using the optimizer dial.
3. Compare the generated design with other possible solutions from Texas Instruments.

The WEBENCH Power Designer provides a customized schematic along with a list of materials with real-time pricing and component availability.

In most cases, these actions are available:

- Run electrical simulations to see important waveforms and circuit performance
- Run thermal simulations to understand board thermal performance
- Export customized schematic and layout into popular CAD formats
- Print PDF reports for the design, and share the design with colleagues

Get more information about WEBENCH tools at www.ti.com/WEBENCH.

13.2 接收文档更新通知

要接收文档更新通知，请导航至 ti.com 上的器件产品文件夹。点击 [订阅更新](#) 进行注册，即可每周接收产品信息更改摘要。有关更改的详细信息，请查看任何已修订文档中包含的修订历史记录。

13.3 支持资源

TI E2E™ [支持论坛](#) 是工程师的重要参考资料，可直接从专家获得快速、经过验证的解答和设计帮助。搜索现有解答或提出自己的问题可获得所需的快速设计帮助。

链接的内容由各个贡献者“按原样”提供。这些内容并不构成 TI 技术规范，并且不一定反映 TI 的观点；请参阅 TI 的 [《使用条款》](#)。

13.4 Trademarks

TI E2E™ is a trademark of Texas Instruments.

所有商标均为其各自所有者的财产。

13.5 Electrostatic Discharge Caution



This integrated circuit can be damaged by ESD. Texas Instruments recommends that all integrated circuits be handled with appropriate precautions. Failure to observe proper handling and installation procedures can cause damage.

ESD damage can range from subtle performance degradation to complete device failure. Precision integrated circuits may be more susceptible to damage because very small parametric changes could cause the device not to meet its published specifications.

13.6 术语表

[TI 术语表](#) 本术语表列出并解释了术语、首字母缩略词和定义。

14 Mechanical, Packaging, and Orderable Information

The following pages include mechanical, packaging, and orderable information. This information is the most current data available for the designated devices. This data is subject to change without notice and revision of this document. For browser-based versions of this data sheet, refer to the left-hand navigation.

重要声明和免责声明

TI 提供技术和可靠性数据 (包括数据表)、设计资源 (包括参考设计)、应用或其他设计建议、网络工具、安全信息和其他资源, 不保证没有瑕疵且不做任何明示或暗示的担保, 包括但不限于对适销性、某特定用途方面的适用性或不侵犯任何第三方知识产权的暗示担保。

这些资源可供使用 TI 产品进行设计的熟练开发人员使用。您将自行承担以下全部责任: (1) 针对您的应用选择合适的 TI 产品, (2) 设计、验证并测试您的应用, (3) 确保您的应用满足相应标准以及任何其他安全、安保或其他要求。这些资源如有变更, 恕不另行通知。TI 授权您仅可将这些资源用于研发本资源所述的 TI 产品的应用。严禁对这些资源进行其他复制或展示。您无权使用任何其他 TI 知识产权或任何第三方知识产权。您应全额赔偿因在这些资源的使用中对 TI 及其代表造成的任何索赔、损害、成本、损失和债务, TI 对此概不负责。

TI 提供的产品受 TI 的销售条款 (<https://www.ti.com/legal/termsofsale.html>) 或 [ti.com](https://www.ti.com) 上其他适用条款/TI 产品随附的其他适用条款的约束。TI 提供这些资源并不会扩展或以其他方式更改 TI 针对 TI 产品发布的适用的担保或担保免责声明。

邮寄地址: Texas Instruments, Post Office Box 655303, Dallas, Texas 75265
Copyright © 2021, 德州仪器 (TI) 公司

PACKAGING INFORMATION

Orderable Device	Status (1)	Package Type	Package Drawing	Pins	Package Qty	Eco Plan (2)	Lead finish/ Ball material (6)	MSL Peak Temp (3)	Op Temp (°C)	Device Marking (4/5)	Samples
TPS63805YFFR	ACTIVE	DSBGA	YFF	15	3000	RoHS & Green	SNAGCU	Level-1-260C-UNLIM	-40 to 125	TPS63805	Samples
TPS63805YFFT	ACTIVE	DSBGA	YFF	15	250	RoHS & Green	SNAGCU	Level-1-260C-UNLIM	-40 to 125	TPS63805	Samples
TPS63806YFFR	ACTIVE	DSBGA	YFF	15	3000	RoHS & Green	SNAGCU	Level-1-260C-UNLIM	-40 to 125	TPS63806	Samples
TPS63807YFFR	ACTIVE	DSBGA	YFF	15	3000	RoHS & Green	SNAGCU	Level-1-260C-UNLIM	-40 to 125	TPS63807	Samples

(1) The marketing status values are defined as follows:

ACTIVE: Product device recommended for new designs.

LIFEBUY: TI has announced that the device will be discontinued, and a lifetime-buy period is in effect.

NRND: Not recommended for new designs. Device is in production to support existing customers, but TI does not recommend using this part in a new design.

PREVIEW: Device has been announced but is not in production. Samples may or may not be available.

OBSOLETE: TI has discontinued the production of the device.

(2) **RoHS:** TI defines "RoHS" to mean semiconductor products that are compliant with the current EU RoHS requirements for all 10 RoHS substances, including the requirement that RoHS substance do not exceed 0.1% by weight in homogeneous materials. Where designed to be soldered at high temperatures, "RoHS" products are suitable for use in specified lead-free processes. TI may reference these types of products as "Pb-Free".

RoHS Exempt: TI defines "RoHS Exempt" to mean products that contain lead but are compliant with EU RoHS pursuant to a specific EU RoHS exemption.

Green: TI defines "Green" to mean the content of Chlorine (Cl) and Bromine (Br) based flame retardants meet JS709B low halogen requirements of <=1000ppm threshold. Antimony trioxide based flame retardants must also meet the <=1000ppm threshold requirement.

(3) MSL, Peak Temp. - The Moisture Sensitivity Level rating according to the JEDEC industry standard classifications, and peak solder temperature.

(4) There may be additional marking, which relates to the logo, the lot trace code information, or the environmental category on the device.

(5) Multiple Device Markings will be inside parentheses. Only one Device Marking contained in parentheses and separated by a "-" will appear on a device. If a line is indented then it is a continuation of the previous line and the two combined represent the entire Device Marking for that device.

(6) Lead finish/Ball material - Orderable Devices may have multiple material finish options. Finish options are separated by a vertical ruled line. Lead finish/Ball material values may wrap to two lines if the finish value exceeds the maximum column width.

Important Information and Disclaimer:The information provided on this page represents TI's knowledge and belief as of the date that it is provided. TI bases its knowledge and belief on information provided by third parties, and makes no representation or warranty as to the accuracy of such information. Efforts are underway to better integrate information from third parties. TI has taken and

continues to take reasonable steps to provide representative and accurate information but may not have conducted destructive testing or chemical analysis on incoming materials and chemicals. TI and TI suppliers consider certain information to be proprietary, and thus CAS numbers and other limited information may not be available for release.

In no event shall TI's liability arising out of such information exceed the total purchase price of the TI part(s) at issue in this document sold by TI to Customer on an annual basis.

TAPE AND REEL INFORMATION

QUADRANT ASSIGNMENTS FOR PIN 1 ORIENTATION IN TAPE

*All dimensions are nominal

Device	Package Type	Package Drawing	Pins	SPQ	Reel Diameter (mm)	Reel Width W1 (mm)	A0 (mm)	B0 (mm)	K0 (mm)	P1 (mm)	W (mm)	Pin1 Quadrant
TPS63805YFFR	DSBGA	YFF	15	3000	180.0	8.4	1.5	2.42	0.75	4.0	8.0	Q1
TPS63805YFFT	DSBGA	YFF	15	250	180.0	8.4	1.5	2.42	0.75	4.0	8.0	Q1
TPS63806YFFR	DSBGA	YFF	15	3000	180.0	8.4	1.5	2.42	0.75	4.0	8.0	Q1
TPS63807YFFR	DSBGA	YFF	15	3000	180.0	8.4	1.5	2.42	0.75	4.0	8.0	Q1

TAPE AND REEL BOX DIMENSIONS

*All dimensions are nominal

Device	Package Type	Package Drawing	Pins	SPQ	Length (mm)	Width (mm)	Height (mm)
TPS63805YFFR	DSBGA	YFF	15	3000	182.0	182.0	20.0
TPS63805YFFT	DSBGA	YFF	15	250	182.0	182.0	20.0
TPS63806YFFR	DSBGA	YFF	15	3000	182.0	182.0	20.0
TPS63807YFFR	DSBGA	YFF	15	3000	182.0	182.0	20.0

YFF0015

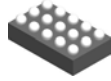

PACKAGE OUTLINE

DSBGA - 0.625 mm max height

DIE SIZE BALL GRID ARRAY

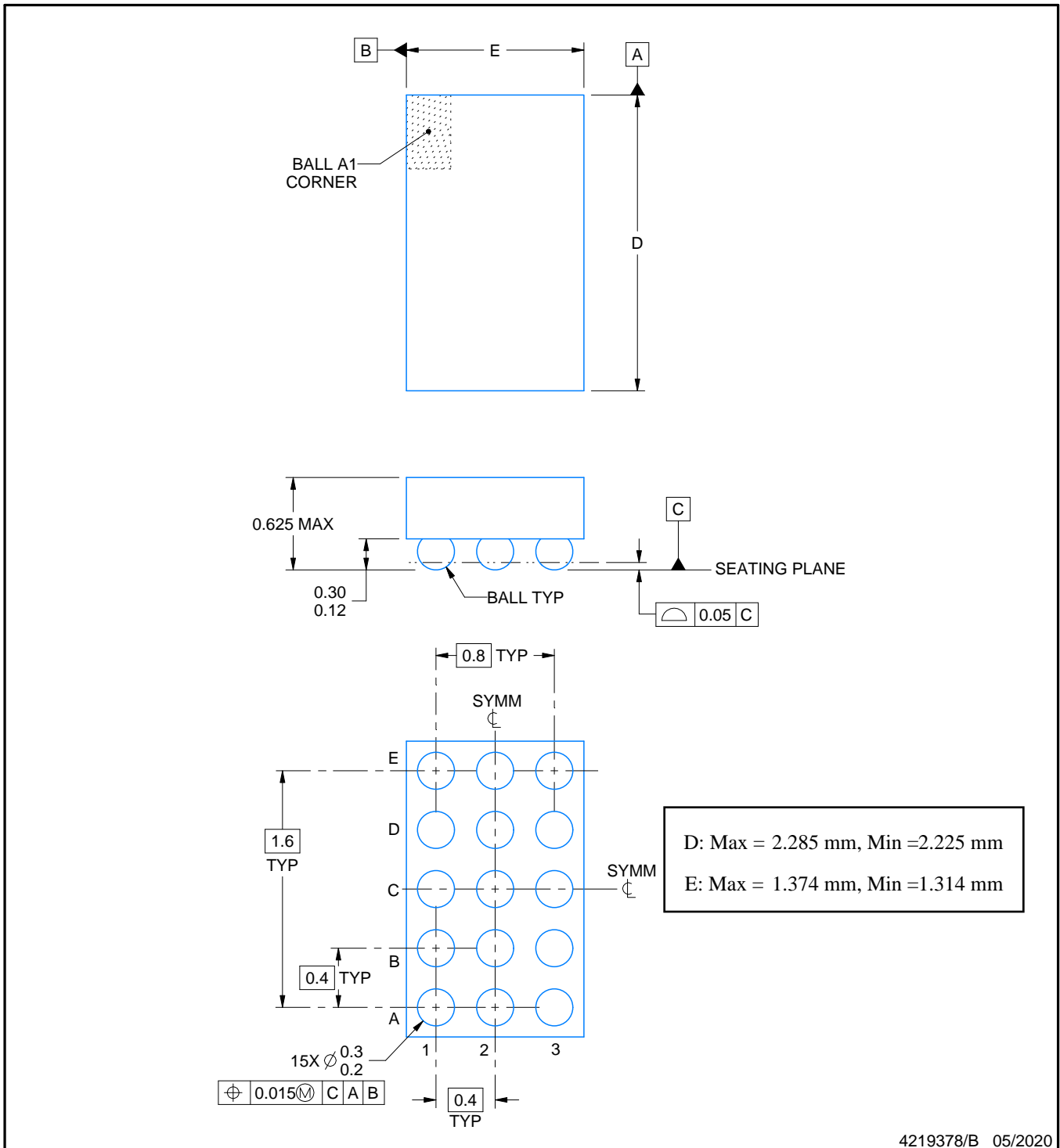

NOTES:

1. All linear dimensions are in millimeters. Any dimensions in parenthesis are for reference only. Dimensioning and tolerancing per ASME Y14.5M.
2. This drawing is subject to change without notice.

EXAMPLE BOARD LAYOUT

YFF0015

DSBGA - 0.625 mm max height

DIE SIZE BALL GRID ARRAY

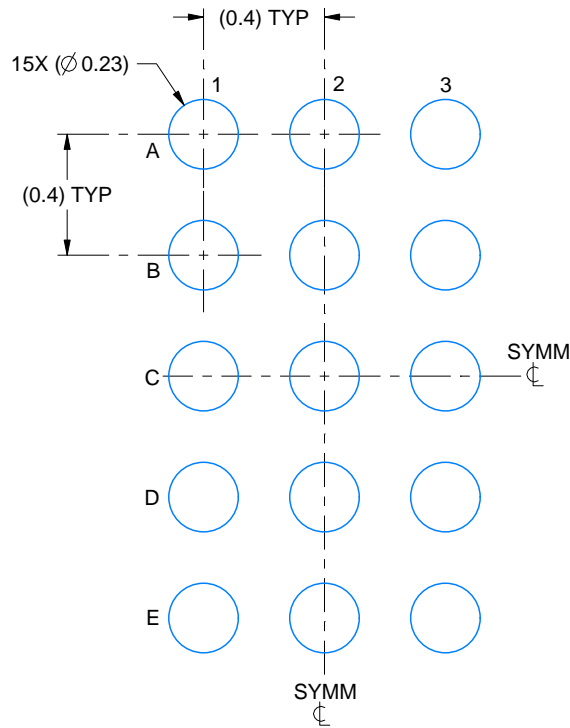

LAND PATTERN EXAMPLE
EXPOSED METAL SHOWN
SCALE:40X

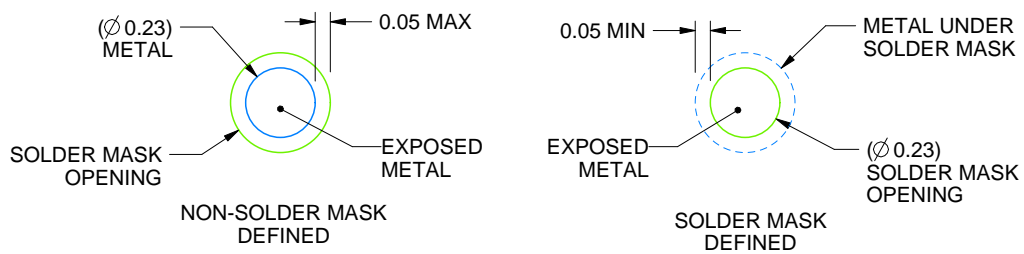

SOLDER MASK DETAILS
NOT TO SCALE

4219378/B 05/2020

NOTES: (continued)

- Final dimensions may vary due to manufacturing tolerance considerations and also routing constraints. For more information, see Texas Instruments literature number SNVA009 (www.ti.com/lit/snva009).

EXAMPLE STENCIL DESIGN

YFF0015

DSBGA - 0.625 mm max height

DIE SIZE BALL GRID ARRAY

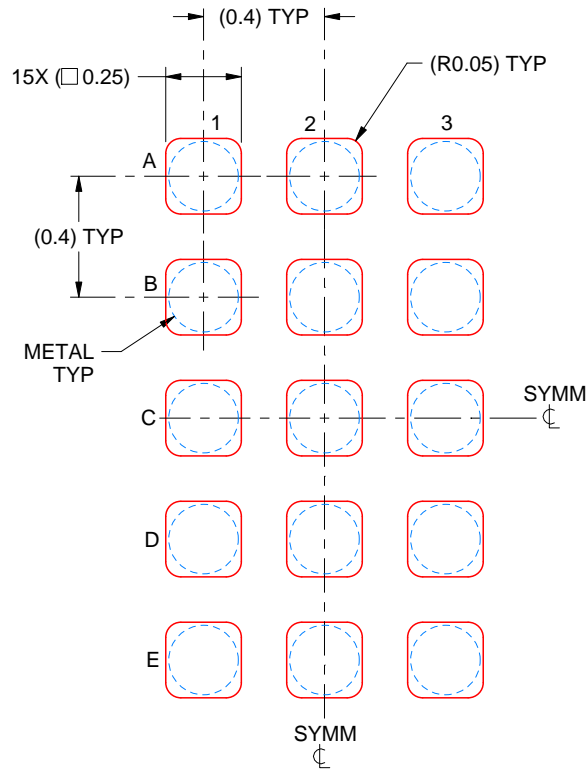

SOLDER PASTE EXAMPLE
BASED ON 0.1 mm THICK STENCIL
SCALE:40X

4219378/B 05/2020

NOTES: (continued)

4. Laser cutting apertures with trapezoidal walls and rounded corners may offer better paste release.

重要通知和免责声明

TI“按原样”提供技术和可靠性数据（包括数据表）、设计资源（包括参考设计）、应用或其他设计建议、网络工具、安全信息和其他资源，不保证没有瑕疵且不做任何明示或暗示的担保，包括但不限于对适销性、某特定用途方面的适用性或不侵犯任何第三方知识产权的暗示担保。

这些资源可供使用 TI 产品进行设计的熟练开发人员使用。您将自行承担以下全部责任：(1) 针对您的应用选择合适的 TI 产品，(2) 设计、验证并测试您的应用，(3) 确保您的应用满足相应标准以及任何其他功能安全、信息安全、监管或其他要求。

这些资源如有变更，恕不另行通知。TI 授权您仅可将这些资源用于研发本资源所述的 TI 产品的相关应用。严禁以其他方式对这些资源进行复制或展示。您无权使用任何其他 TI 知识产权或任何第三方知识产权。您应全额赔偿因在这些资源的使用中对 TI 及其代表造成的任何索赔、损害、成本、损失和债务，TI 对此概不负责。

TI 提供的产品受 [TI 的销售条款](#) 或 [ti.com](#) 上其他适用条款/TI 产品随附的其他适用条款的约束。TI 提供这些资源并不会扩展或以其他方式更改 TI 针对 TI 产品发布的适用的担保或担保免责声明。

TI 反对并拒绝您可能提出的任何其他或不同的条款。

邮寄地址：Texas Instruments, Post Office Box 655303, Dallas, Texas 75265
版权所有 © 2025，德州仪器 (TI) 公司