

TPS714 80mA、10V、3.2 μ A 静态电流、低压降线性稳压器

1 特性

- 输入电压范围：2.5V 至 10V
- 可配置的输出电压选项：
 - 固定：1.8V 至 5V
 - 可调节：1.205V 至 8.8V
- 输出电流：高达 80mA
- 超低 I_Q ：80mA 负载电流下为 3.2 μ A
- 压降电压：50mA 负载下为 415mV
- 过流保护
- 工作结温：-40°C 至 +125°C
- 封装：
 - 2mm \times 1.25mm SC-70 (DCK)
 - 2mm \times 2mm WSON (DRV)
- 有关 MSP430 特定的输出电压，请参见 [TPS715](#)

2 应用

- 家庭和楼宇自动化
- 零售自动化和支付
- 电网基础设施
- 医疗应用
- 照明应用

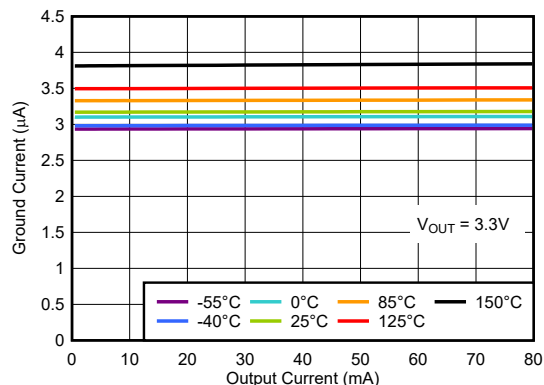

静态电流与负载电流之间的关系
(新芯片)

3 说明

TPS714 低压降 (LDO) 线性稳压器是低静态电流器件，可提供采用微型封装、具有宽输入电压范围和实现低功耗运行的优势。因此，TPS714 专为电池供电型应用而设计，可用作低功耗微控制器的电源管理附件。

TPS714 有固定电压和可调节电压两种版本可供选用。为了获得更大的灵活性或更高的输出电压，可调节电压版本使用外部反馈电阻器将输出电压设置为 1.205V 至 8.8V。TPS714 LDO 在负载电流为 80mA 时支持 650mV (典型值) 的低压降。低静态电流 (典型值为 3.2 μ A) 在整个输出负载电流 (0mA 至 80mA) 范围内都是稳定的。TPS714 (仅限新芯片) 还具有内部软启动功能，可降低浪涌电流。内置过流限制有助于在发生负载短路或故障时保护稳压器。

TPS714 可采用适用于高功率耗散应用的 2mm \times 2mm 封装，也可以采用适用于手持和超便携式应用的 SC70-5 封装。

封装信息

器件型号	封装 ⁽¹⁾	封装尺寸 ⁽²⁾
TPS714	DRV (WSON, 6)	2mm \times 2mm
	DCK (SC70, 5)	2mm \times 2.1mm

- (1) 如需更多信息，请参阅 [机械、封装和可订购信息](#)。
- (2) 封装尺寸 (长 \times 宽) 为标称值，并包括引脚 (如适用)。

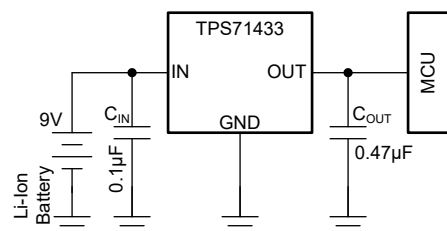

典型应用原理图



Table of Contents

1 特性	1	7 Application and Implementation	16
2 应用	1	7.1 Application Information.....	16
3 说明	1	7.2 Typical Applications.....	16
4 Pin Configuration and Functions	3	7.3 Power Supply Recommendations.....	21
5 Specifications	4	7.4 Layout.....	21
5.1 Absolute Maximum Ratings.....	4	8 Device and Documentation Support	23
5.2 ESD Ratings.....	4	8.1 Device Support.....	23
5.3 Recommended Operating Conditions.....	4	8.2 接收文档更新通知.....	23
5.4 Thermal Information.....	5	8.3 支持资源.....	23
5.5 Electrical Characteristics.....	6	8.4 Trademarks.....	23
5.6 Typical Characteristics.....	7	8.5 静电放电警告.....	23
6 Detailed Description	12	8.6 术语表.....	23
6.1 Overview.....	12	9 Revision History	24
6.2 Functional Block Diagrams.....	12	10 Mechanical, Packaging, and Orderable Information	24
6.3 Feature Description.....	13		
6.4 Device Functional Modes.....	14		

4 Pin Configuration and Functions



图 4-1. DRV Package, 6-Pin WSON (Top View)



图 4-2. DCK Package, 5-Pin SC70 (Top View)

Pin Functions

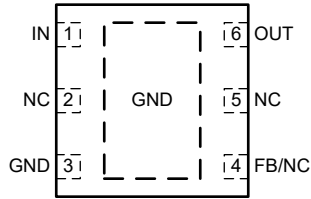
TPS714					DESCRIPTION
NAME	DCK		DRV		
	FIXED	ADJ.	FIXED	ADJ.	
FB	—	1	—	4	In the adjustable configuration, this pin sets the output voltage with the help of the external feedback divider.
GND	2	2	3, Pad	3, Pad	Ground pin.
NC	1,3	3	2, 4, 5	2, 5	No connect pin. This pin is not connected internally. Connect this pin to ground for best thermal performance or leave floating.
IN	4	4	1	1	Input supply pin. Use a capacitor with a value of 0.1 μF or larger from this pin to ground. ⁽²⁾ See the Input and Output Capacitor Requirements section for more information.
OUT	5	5	6	6	Output of the regulator. For the new chip, a capacitor with a value of 1 μF or larger is required from this pin to ground. ⁽¹⁾ See the Input and Output Capacitor Requirements section for more information.

- (1) The nominal output capacitance must be greater than 0.47 μF . Throughout this document, the nominal derating on these capacitors is 50%. Make sure that the effective capacitance at the pin is greater than 0.47 μF . The legacy chip is stable for any capacitor value \geq 0.47 μF .
- (2) For the legacy chip, use a capacitor with a value of 0.047 μF or larger from IN to ground.

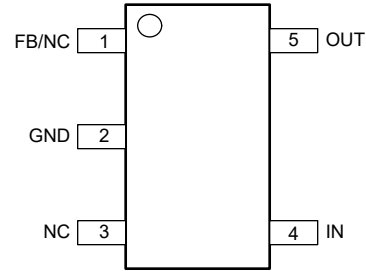
5 Specifications

5.1 Absolute Maximum Ratings

over operating temperature range (unless otherwise noted)⁽¹⁾ ⁽²⁾

		MIN	MAX	UNIT
Voltage	V _{IN} (for legacy chip only)	- 0.3	24	V
	V _{IN} (for new chip only)	- 0.3	30	
	V _{OUT} (for fixed output new chip only)	- 0.3	2 × V _{OUT(typ)} or V _{IN} + 0.3 or 5.5 (whichever is lower)	
Voltage	V _{OUT} (for legacy chip only)	- 0.3	9.9	V
Voltage	V _{OUT} (for adjustable output new chip only)	- 0.3	V _{IN} + 0.3	V
	V _{FB} (for adjustable output new chip only)		2.4	
	V _{FB} (for adjustable output legacy chip only)	- 0.3	4.5	
Current	Peak output current	Internally limited		
Temperature	Junction, T _J	- 40	150	°C
	Storage, T _{stg}	- 65	150	

- (1) Stresses beyond those listed under *Absolute Maximum Ratings* may cause permanent damage to the device. These are stress ratings only, which do not imply functional operation of the device at these or any other conditions beyond those indicated under *Recommended Operating Conditions*. Exposure to absolute-maximum-rated conditions for extended periods may affect device reliability.
- (2) All voltage values are with respect to network ground terminal.

5.2 ESD Ratings

		VALUE	UNIT
V _(ESD)	Electrostatic discharge	Human body model (HBM), per ANSI/ESDA/JEDEC JS-001, all pins ⁽¹⁾	±2000
		Charged device model (CDM), per JEDEC specification JESD22-C101, all pins ⁽²⁾	±500

- (1) JEDEC document JEP155 states that 500-V HBM allows safe manufacturing with a standard ESD control process.
- (2) JEDEC document JEP157 states that 250-V CDM allows safe manufacturing with a standard ESD control process.

5.3 Recommended Operating Conditions

over operating free-air temperature range (unless otherwise noted)⁽¹⁾

		MIN	NOM	MAX	UNIT
V _{IN}	Input supply voltage	2.5		10	V
V _{OUT}	Output voltage	1.205		8.8	V
I _{OUT}	Output current	0		80	mA
C _{IN}	Input capacitor ⁽²⁾	0	0.047		μF
C _{OUT}	Output capacitor (for legacy chip only)	0.47	1		
	Output capacitor (for new chip only) ⁽³⁾	1			
T _J	Operating junction temperature	-40		125	°C

- (1) All voltages are with respect to GND.
- (2) An input capacitor is not required for LDO stability. However, an input capacitor with an effective value of 0.047 μF is recommended to counteract the effect of source resistance and inductance, which may in some cases cause symptoms of system level instability such as ringing or oscillation, especially in the presence of load transients.
- (3) All capacitor values are assumed to derate to 50% of the nominal capacitor value. Maintain an effective output capacitance of 0.47 μF minimum for the stability.

5.4 Thermal Information

THERMAL METRIC		TPS714				UNIT
		DCK (SC-70) 5 Pins		DRV (WSON) 6 Pins		
		Legacy chip	New chip	Legacy chip	New chip	
$R_{\theta JA}$	Junction-to-ambient thermal resistance	253.8	195.7	79.5	69.5	°C/W
$R_{\theta JC(top)}$	Junction-to-case (top) thermal resistance	73.7	88.2	110.5	108.0	°C/W
$R_{\theta JB}$	Junction-to-board thermal resistance	84.6	40.7	48.9	35.4	°C/W
ψ_{JT}	Junction-to-top characterization parameter	1.1	11.2	5.2	5.9	°C/W
ψ_{JB}	Junction-to-board characterization parameter	83.9	40.5	49.3	35.4	°C/W
$R_{\theta JC(bot)}$	Junction-to-case (bottom) thermal resistance	-	-	18.3	7.2	°C/W

5.5 Electrical Characteristics

over operating junction temperature range ($T_J = -40^\circ\text{C}$ to 125°C), $V_{IN} = V_{OUT(nom)} + 1\text{ V}$, $I_{OUT} = 1\text{ mA}$, and $C_{OUT} = 1\ \mu\text{F}$ (unless otherwise noted); typical values are at $T_J = 25^\circ\text{C}$

PARAMETER		TEST CONDITIONS	MIN	TYP	MAX	UNIT
V_{IN}	Input voltage range ⁽¹⁾	$I_O = 10\text{ mA}$	2.5		10	V
		$I_O = 80\text{mA}$	3		10	
V_{OUT}	Output voltage range (TPS71401) ⁽¹⁾		V_{FB}		8.8	V
V_{FB}	Internal reference (legacy chip) (TPS71401) ⁽¹⁾		1.12	1.2	1.24	V
	Internal reference (new chip) (TPS71401) ⁽¹⁾		1.16	1.2	1.24	
V_{OUT}	Accuracy ⁽¹⁾	TPS71433 over V_{IN} , I_{OUT} and Temp $4.3\text{ V} \leq V_{IN} \leq 10\text{ V}$, $1\text{ mA} \leq I_{OUT} \leq 80\text{ mA}$	3.135	3.3	3.465	V
I_{GND}	Ground pin current (legacy chip) ⁽³⁾	$1\text{ mA} \leq I_{OUT} \leq 80\text{mA}$, $T_J = -40^\circ\text{C}$ to 85°C		3.2	4.2	$\mu\text{ A}$
		$1\text{ mA} \leq I_{OUT} \leq 80\text{mA}$		3.2	5.8	
		$1\text{ mA} \leq I_{OUT} \leq 80\text{mA}$, $V_{IN} = 10\text{ V}$			7.4	
	Ground pin current (new chip) ⁽³⁾	$1\text{ mA} \leq I_{OUT} \leq 80\text{mA}$, $T_J = -40^\circ\text{C}$ to 85°C		3.2	4.1	
		$1\text{ mA} \leq I_{OUT} \leq 80\text{mA}$		3.2	4.3	
		$1\text{ mA} \leq I_{OUT} \leq 80\text{mA}$, $V_{IN} = 10\text{ V}$			4.5	
$\Delta V_{OUT} (\Delta I_{OUT})$	Load regulation	$I_{OUT} = 1\text{ mA}$ to 80 mA		30		mV
$\Delta V_{OUT} (\Delta V_{IN})$	Output voltage line regulation ⁽¹⁾	$V_{OUT} + 1\text{ V} < V_{IN} \leq 10\text{ V}$		5		mV
$I_{FB\ BIAS}$	Feedback pin bias current	$I_{OUT} = 0\text{ mA}$, $V_{IN} = 3\text{V}$ to 10V , $V_{OUT} = 1.2\text{V}$		2		nA
V_n	Output noise voltage (legacy chip)	$BW = 200\text{ Hz}$ to 100 kHz , $C_{OUT} = 10\ \mu\text{F}$, $I_{OUT} = 50\text{ mA}$		575		$\mu\text{ Vrms}$
	Output noise voltage (new chip)	$BW = 200\text{ Hz}$ to 100 kHz , $C_{OUT} = 10\ \mu\text{F}$, $I_{OUT} = 50\text{ mA}$		425		
I_{CL}	Output current limit (legacy chip)	$V_{OUT} = 0\text{ V}$	100		1100	mA
	Output current limit (new chip)	$V_{OUT} = 0\text{ V}$, $V_{IN} \geq 3.5\text{ V}$	160		500	
	Output current limit (new chip)	$V_{OUT} = 0\text{ V}$, $V_{IN} < 3.5\text{ V}$	90		500	
V_{DO}	Dropout voltage (legacy chip)	$V_{IN} = V_{OUT(nom)} - 0.1\text{ V}$, $I_{OUT} = 80\text{ mA}$		670	1300	mV
	Dropout voltage (new chip)	$V_{IN} = V_{OUT(nom)} - 0.1\text{ V}$, $I_{OUT} = 80\text{ mA}$		670	900	

(1) Minimum $V_{IN} = V_{OUT} + V_{DO}$ or the value shown for *Input voltage* in this table, whichever is greater.

(2) This device employs a leakage null control circuit. This circuit is active only if output current is less than pass transistor leakage current. The circuit is typically active when output load is less than $5\ \mu\text{A}$, V_{IN} is greater than 18 V , and die temperature is greater than 100°C .

5.6 Typical Characteristics

at operating temperature $T_J = 25^\circ\text{C}$, $V_{IN} = V_{OUT(NOM)} + 1.0\text{ V}$ or 2.5 V (whichever is greater), $I_{OUT} = 1\text{ mA}$, $C_{IN} = 1\text{ }\mu\text{F}$, and $C_{OUT} = 1\text{ }\mu\text{F}$ (unless otherwise noted)



图 5-1. TPS71433 Output Voltage vs Output Current (Legacy Chip)



图 5-2. TPS71433 Output Voltage vs Output Current (New Chip)

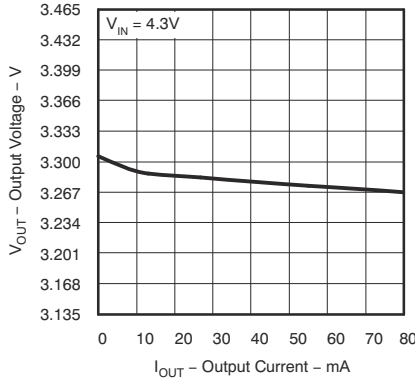

图 5-3. TPS71433 Output Voltage vs Input Voltage (New Chip)

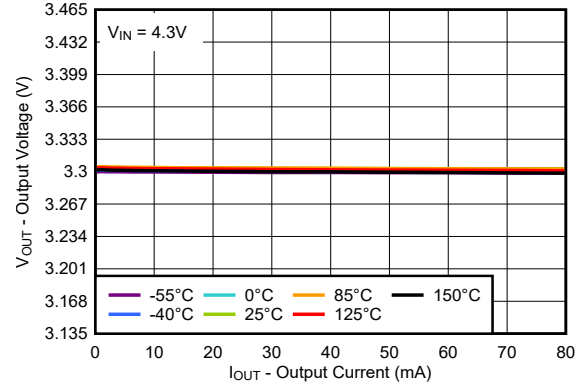

图 5-4. TPS71433 Output Voltage vs Junction Temperature (Legacy Chip)

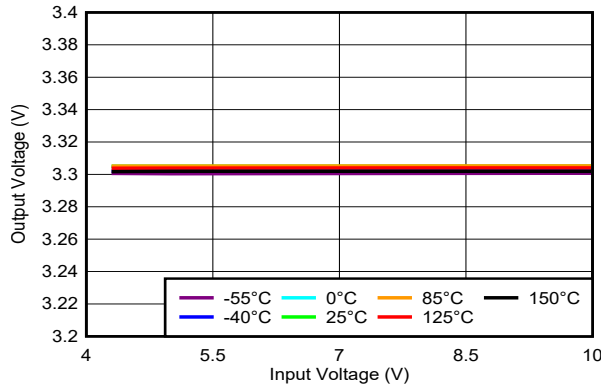

图 5-5. TPS71433 Output Voltage vs Junction Temperature (New Chip)

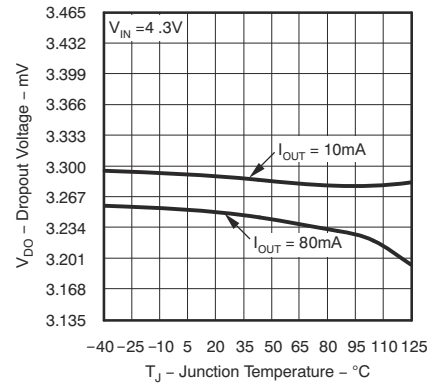

图 5-6. TPS71433 Quiescent Current vs Junction Temperature (Legacy Chip)

5.6 Typical Characteristics (continued)

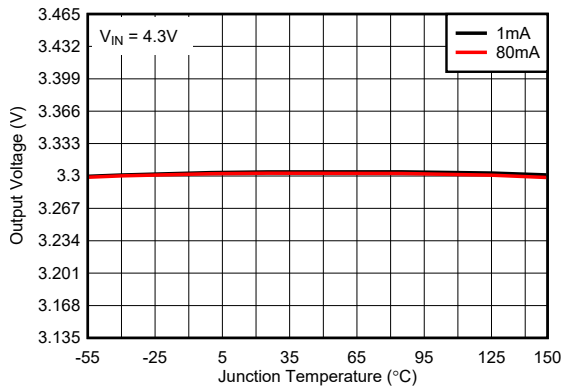
at operating temperature $T_J = 25^\circ\text{C}$, $V_{IN} = V_{OUT(NOM)} + 1.0\text{ V}$ or 2.5 V (whichever is greater), $I_{OUT} = 1\text{ mA}$, $C_{IN} = 1\text{ }\mu\text{F}$, and $C_{OUT} = 1\text{ }\mu\text{F}$ (unless otherwise noted)

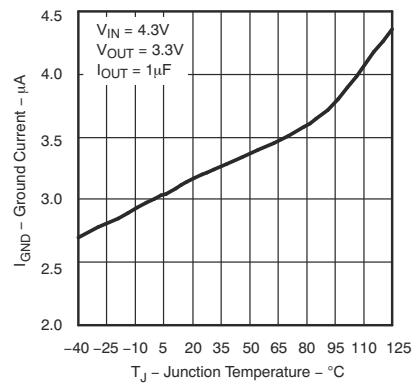

图 5-7. TPS71433 Quiescent Current vs Junction Temperature (New Chip)



图 5-8. TPS71433 Quiescent Current vs Input Voltage (New Chip)

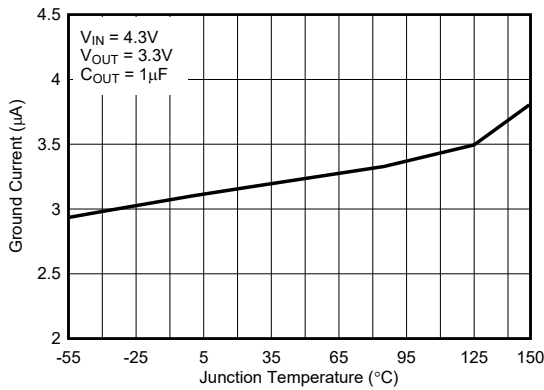

图 5-9. TPS71433 Quiescent Current vs Load Current (New Chip)

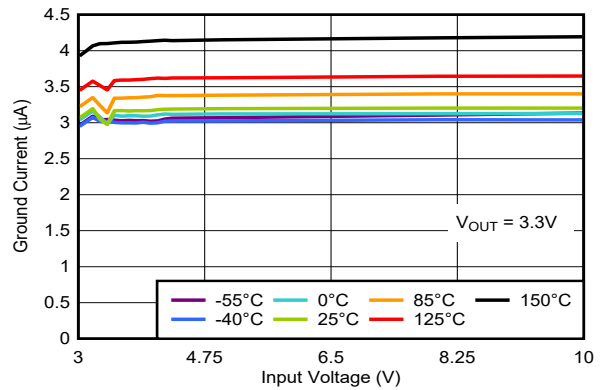

图 5-10. TPS71433 Dropout Voltage vs Output Current (Legacy Chip)

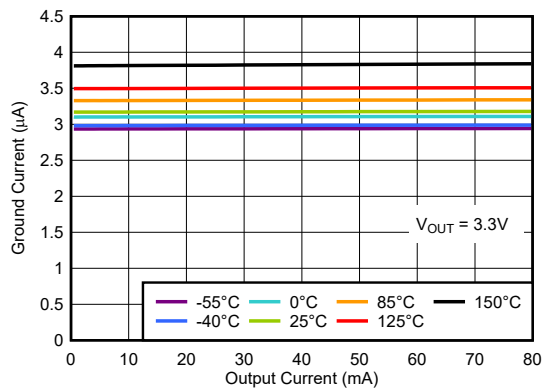

图 5-11. TPS71433 Dropout Voltage vs Output Current (New Chip)

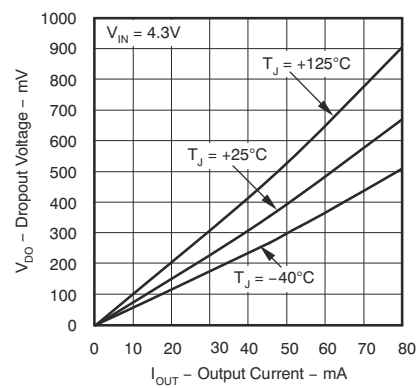

图 5-12. TPS71433 Dropout Voltage vs Junction Temperature (Legacy Chip)

5.6 Typical Characteristics (continued)

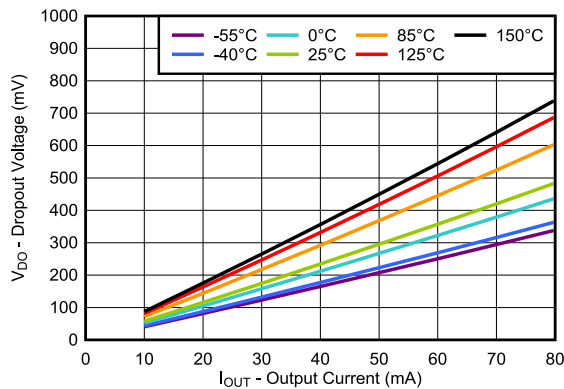
at operating temperature $T_J = 25^\circ\text{C}$, $V_{IN} = V_{OUT(NOM)} + 1.0\text{ V}$ or 2.5 V (whichever is greater), $I_{OUT} = 1\text{ mA}$, $C_{IN} = 1\text{ }\mu\text{F}$, and $C_{OUT} = 1\text{ }\mu\text{F}$ (unless otherwise noted)

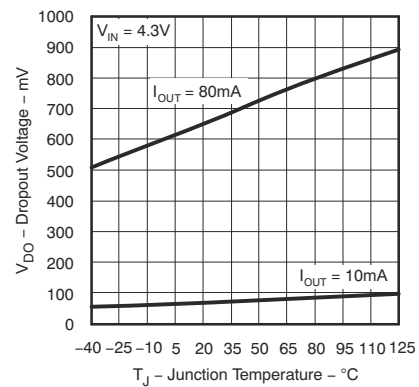

图 5-13. TPS71433 Dropout Voltage vs Junction Temperature (New Chip)



图 5-14. TPS71401 Dropout Voltage vs Input Voltage (New Chip)

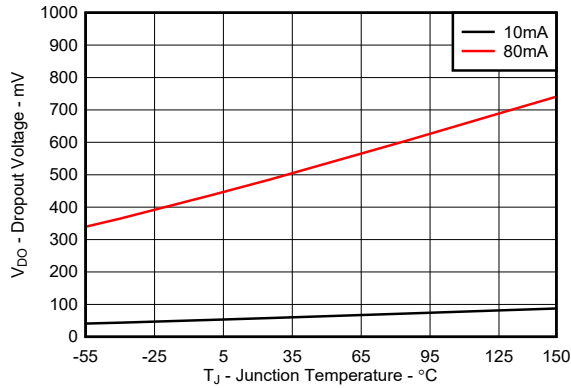

图 5-15. TPS71433 Output Spectral Noise Density vs Frequency (Legacy Chip)

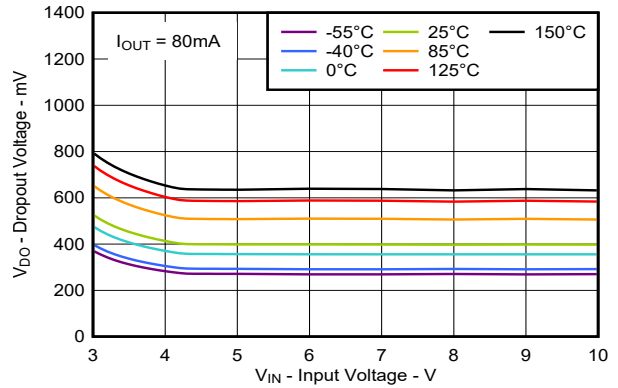

图 5-16. TPS71433 Output Spectral Noise Density vs Frequency (New Chip)

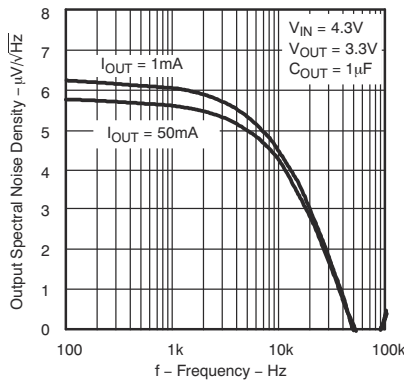

图 5-17. TPS71433 Output Impedance vs Frequency (Legacy Chip)

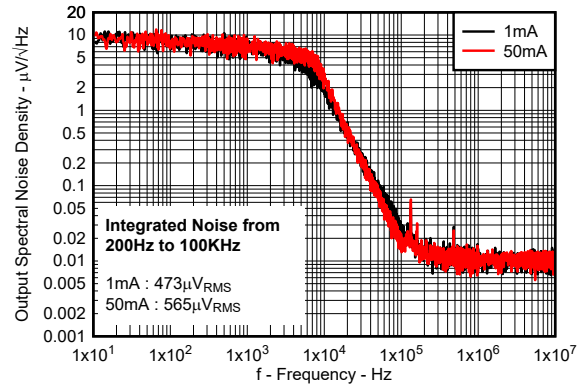

图 5-18. TPS71433 V_{OUT} vs Current Limit (Legacy Chip)

5.6 Typical Characteristics (continued)

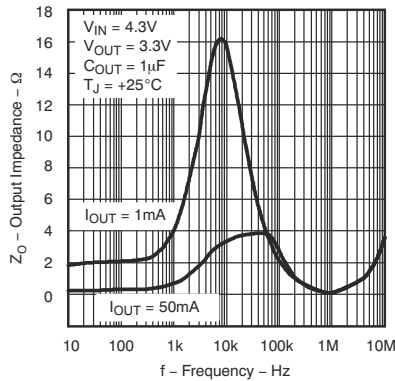
at operating temperature $T_J = 25^\circ\text{C}$, $V_{IN} = V_{OUT(NOM)} + 1.0\text{ V}$ or 2.5 V (whichever is greater), $I_{OUT} = 1\text{ mA}$, $C_{IN} = 1\text{ }\mu\text{F}$, and $C_{OUT} = 1\text{ }\mu\text{F}$ (unless otherwise noted)

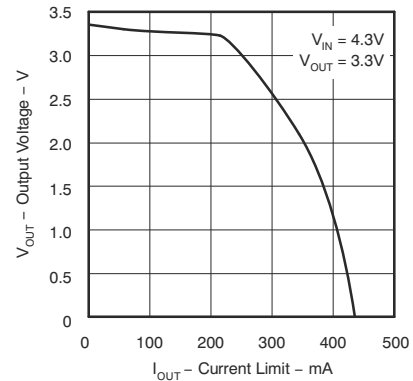

图 5-19. TPS71433 V_{OUT} vs Current Limit (New Chip)



图 5-20. TPS71433 Current Limit vs Junction Temperature (New Chip)

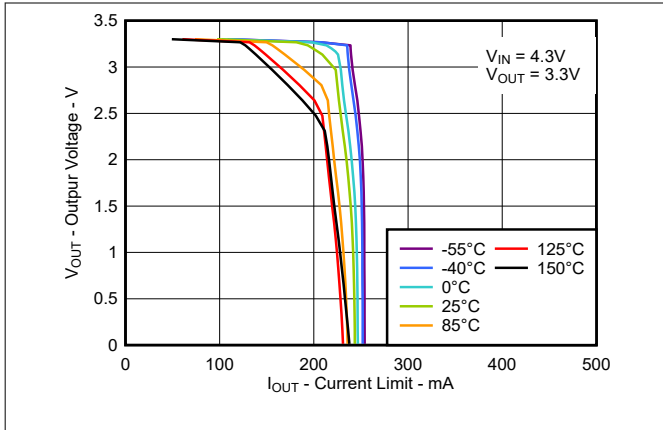

图 5-21. TPS71433 Power-Supply Ripple Rejection vs Frequency (Legacy Chip)

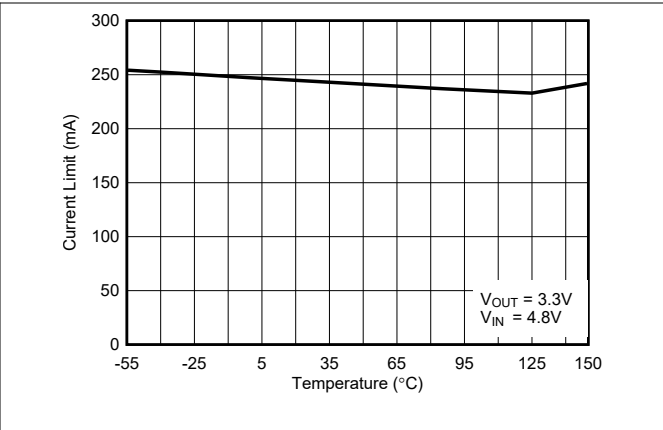

图 5-22. TPS71433 Power-Supply Ripple Rejection vs Frequency (New Chip)

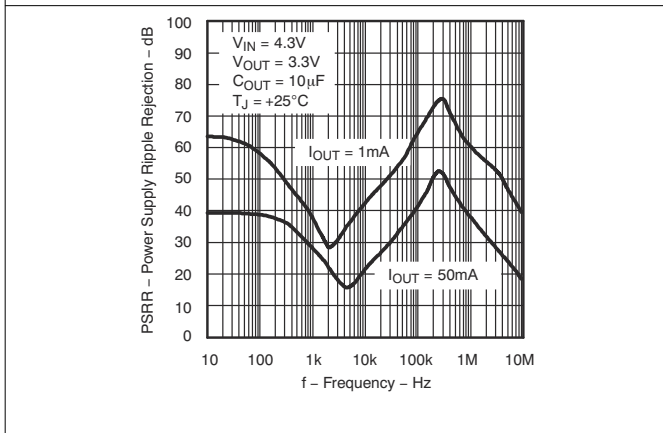

图 5-23. TPS71433 Power-Up, Power-Down (Legacy Chip)

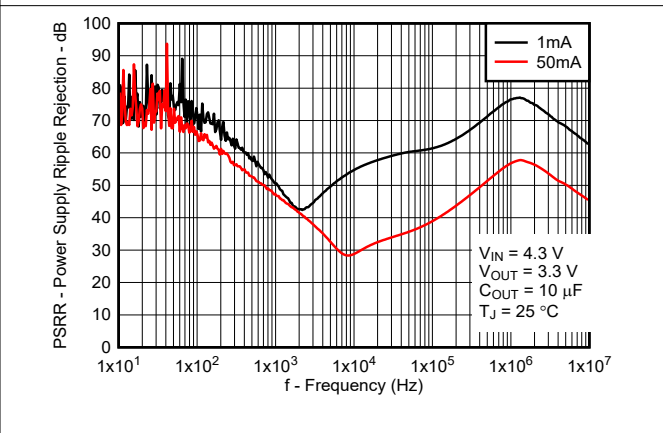

图 5-24. TPS71433 Power-Up, Power-Down (New Chip)

5.6 Typical Characteristics (continued)

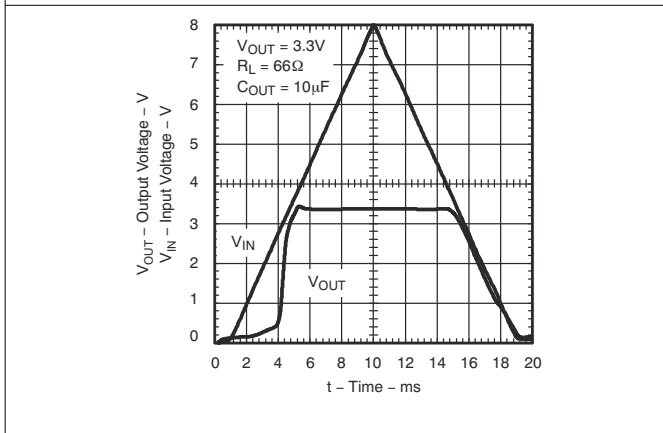
at operating temperature $T_J = 25^\circ\text{C}$, $V_{IN} = V_{OUT(\text{NOM})} + 1.0\text{ V}$ or 2.5 V (whichever is greater), $I_{OUT} = 1\text{ mA}$, $C_{IN} = 1\text{ }\mu\text{F}$, and $C_{OUT} = 1\text{ }\mu\text{F}$ (unless otherwise noted)

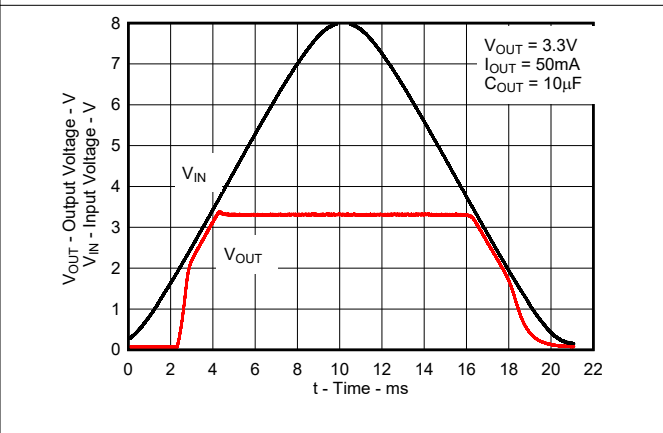

图 5-25. TPS71433 Fast Power-Up (Legacy Chip)



图 5-26. TPS71433 Fast Power-Up (New Chip)

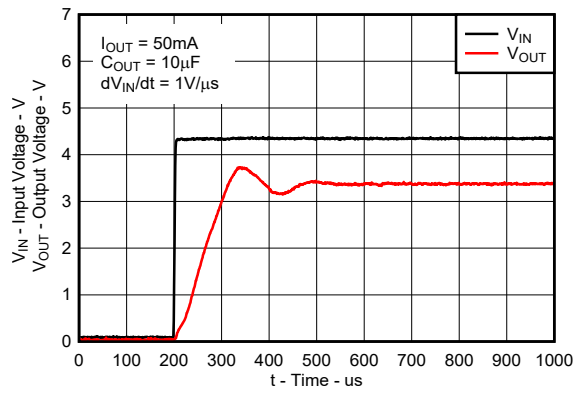

图 5-27. TPS71433 Line Transient Response (Legacy Chip)

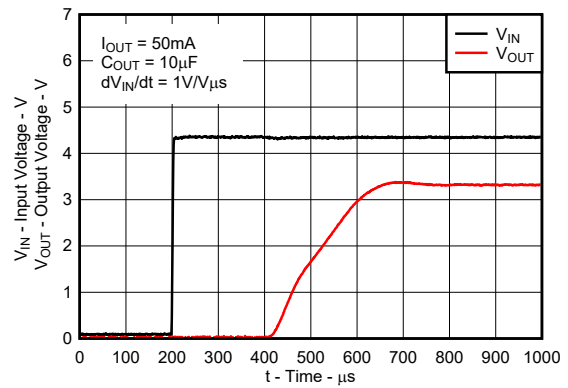

图 5-28. TPS71433 Line Transient Response (New Chip)

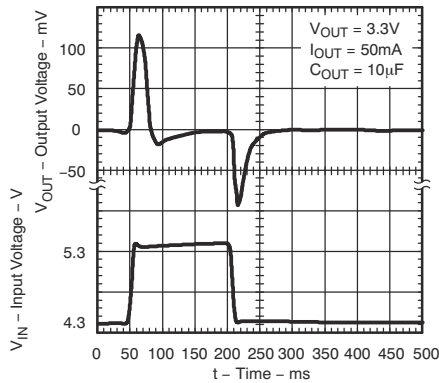

图 5-29. TPS71433 Load Transient Response (Legacy Chip)

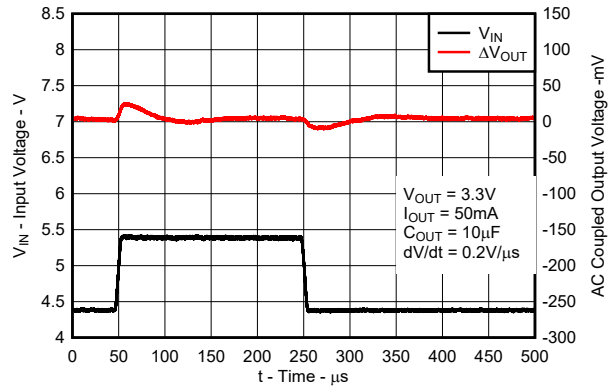

图 5-30. TPS71433 Load Transient Response (New Chip)

6 Detailed Description

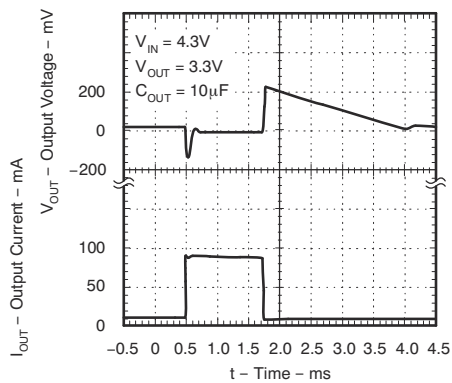
6.1 Overview

The TPS714 low-dropout regulator (LDO) consumes only 3.2 μA (typ) of quiescent current across the entire output current range, while offering a wide input voltage range and low-dropout voltage in small packaging. The device, which operates over an input voltage range of 2.5 V to 10 V, is stable with any output capacitance greater than or equal to 0.47 μF . The low quiescent current across the complete load current range makes the TPS714 designed for powering battery-operated applications. The TPS714 (new chip only) has an internal soft-start to control inrush current into the output capacitor. This LDO also has overcurrent protection during a load-short or fault condition on the output.

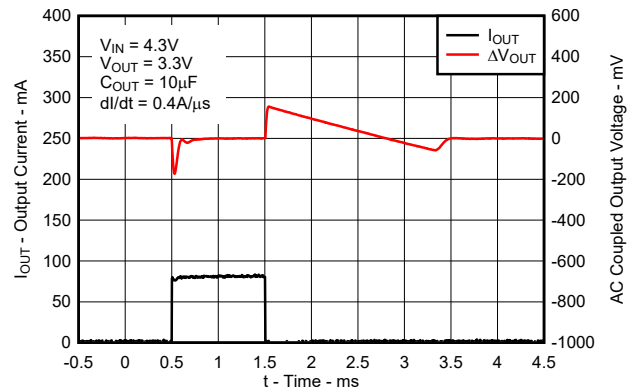
6.2 Functional Block Diagrams



图 6-1. Adjustable Voltage Version



图 6-2. Fixed Voltage Version

6.3 Feature Description

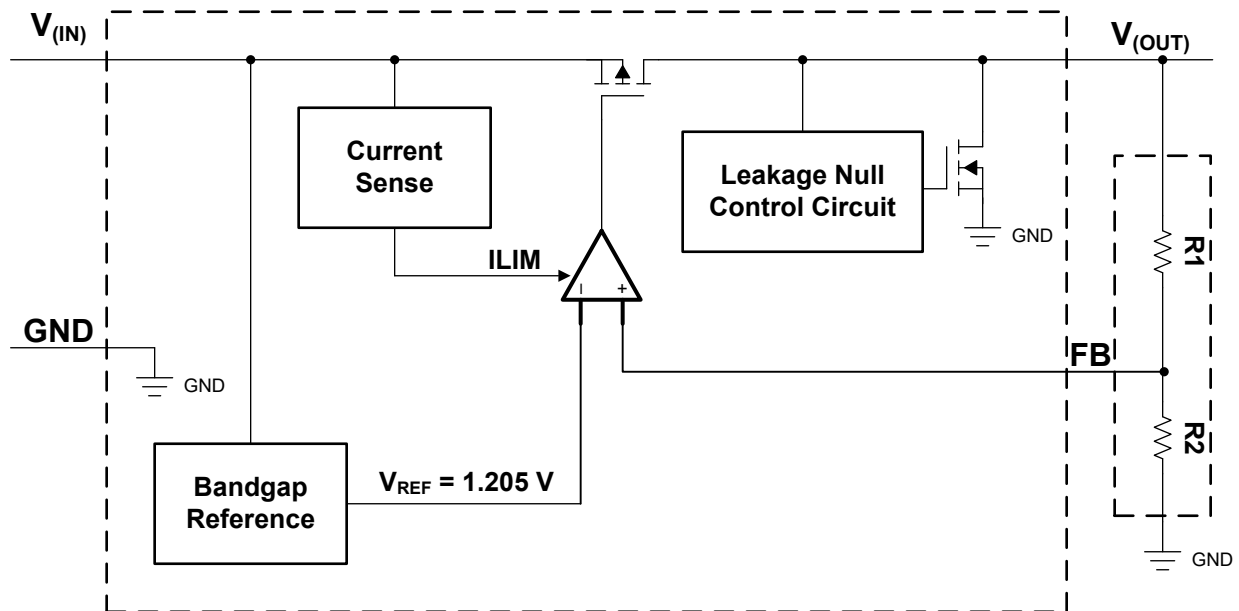
6.3.1 Wide Supply Range

This device has an operational input supply range of 2.5 V to 10 V, allowing for a wide range of applications. This wide supply range is ideal for applications that have either large transients or high dc voltage supplies.

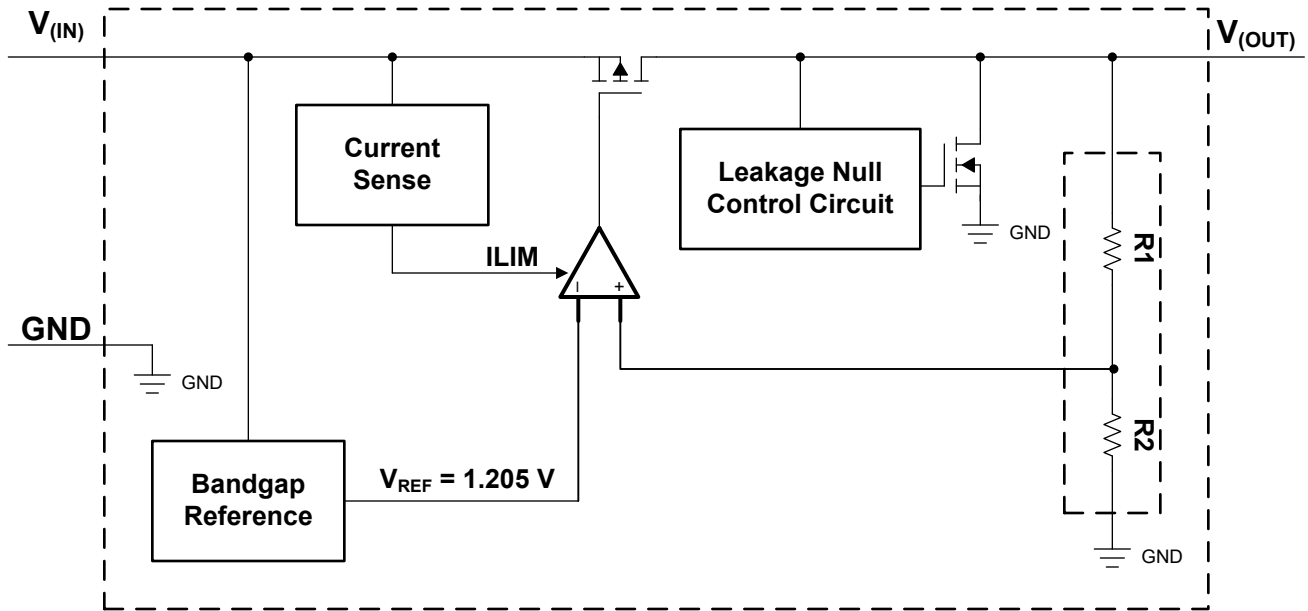
6.3.2 Low Supply Current

This device only requires 3.2 μ A (typical) of quiescent current across the complete load current range (0 mA to 80 mA) and has a maximum current consumption of 4.8 μ A (for new device only) at -40°C to $+125^{\circ}\text{C}$.

6.3.3 Current Limit

The device has an internal current-limit circuit that protects the regulator during transient high-load current faults or shorting events. The current limit is a brick-wall scheme. In a high-load current fault, the brick-wall scheme limits the output current to the current limit (I_{CL}). I_{CL} is listed in the [Electrical Characteristics](#) table.

The output voltage is not regulated when the device is in current limit. When a current limit event occurs, the device begins to heat up because of the increase in power dissipation. When the device is in brick-wall current limit, the pass transistor dissipates power $[(V_{IN} - V_{OUT}) \times I_{CL}]$. For more information on current limits, see the [Know Your Limits application note](#). The LDO is not designed to operate in a steady-state current limit.

图 6-3 shows a diagram of the current limit.



图 6-3. Current Limit

6.3.4 Dropout Voltage (V_{DO})

Dropout voltage (V_{DO}) is defined as the input voltage minus the output voltage ($V_{IN} - V_{OUT}$) at the rated output current (I_{RATED}), where the pass transistor is fully on. I_{RATED} is the maximum I_{OUT} listed in the [Recommended Operating Conditions](#) table. In dropout operation, the pass transistor is in the ohmic or triode region of operation, and acts as a switch. The dropout voltage indirectly specifies a minimum input voltage greater than the nominal programmed output voltage at which the output voltage is expected to stay in regulation. If the input voltage falls to less than the value required to maintain output regulation, the output voltage falls as well.

For a CMOS regulator, the dropout voltage is determined by the drain-source, on-state resistance ($R_{DS(ON)}$) of the pass transistor. Therefore, if the linear regulator operates at less than the rated current, the dropout voltage for that current scales accordingly. Use [方程式 1](#) to calculate the $R_{DS(ON)}$ of the device.

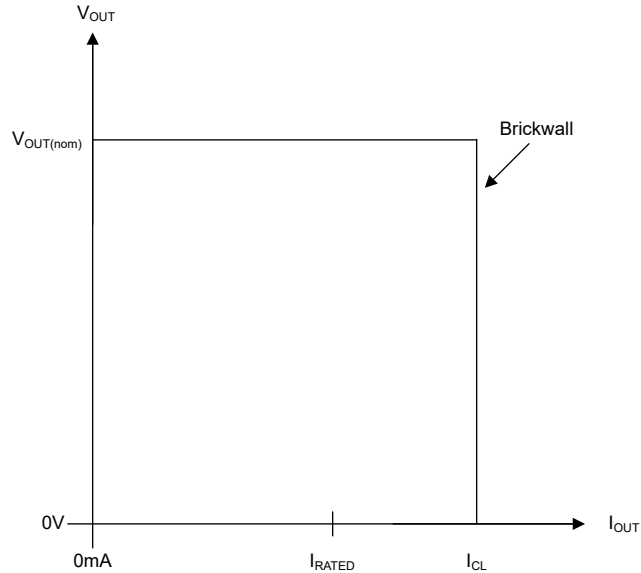
$$R_{DS(ON)} = \frac{V_{DO}}{I_{RATED}} \quad (1)$$

6.4 Device Functional Modes

[表 6-1](#) provides a quick comparison between the normal and dropout modes of operation.

表 6-1. Device Functional Mode Comparison

OPERATING MODE	PARAMETER	
	V_{IN}	I_{OUT}
Normal	$V_{IN} > V_{OUT(nom)} + V_{DO}$	$I_{OUT} < I_{CL}$
Dropout	$V_{IN} < V_{OUT(nom)} + V_{DO}$	$I_{OUT} < I_{CL}$

6.4.1 Normal Operation

The device regulates to the nominal output voltage under the following conditions:

- The input voltage is greater than the nominal output voltage plus the dropout voltage ($V_{OUT(nom)} + V_{DO}$)
- The output current is less than the current limit ($I_{OUT} < I_{CL}$)
- The device junction temperature is greater than -40°C and less than $+125^{\circ}\text{C}$

6.4.2 Dropout Operation

If the input voltage is lower than the nominal output voltage plus the specified dropout voltage, but all other conditions are met for normal operation, the device operates in dropout mode. In this mode, the output voltage tracks the input voltage. During this mode, the transient performance of the device becomes significantly degraded because the pass transistor is in the ohmic or triode region, and acts as a switch. Line or load transients in dropout can result in large output voltage deviations.

When the device is in a steady dropout state (defined as when the device is in dropout, $V_{IN} < V_{OUT(NOM)} + V_{DO}$, directly after being in a normal regulation state, but *not* during start up), the pass transistor is driven into the ohmic or triode region. When the input voltage returns to a value greater than or equal to the nominal output voltage plus the dropout voltage ($V_{OUT(NOM)} + V_{DO}$), the output voltage can overshoot for a short period of time while the device pulls the pass transistor back into the linear region.

7 Application and Implementation

备注

以下应用部分中的信息不属于 TI 器件规格的范围，TI 不担保其准确性和完整性。TI 的客户应负责确定器件是否适用于其应用。客户应验证并测试其设计，以确保系统功能。

7.1 Application Information

The TPS714 LDO regulator is designed for battery-powered applications and is a good supply for low-power microcontrollers (such as the [MSP430](#)) because of the device low I_Q performance across load current range. The ultra-low-supply current of the TPS714 maximizes efficiency at light loads, and the high input voltage range and flexibility of output voltage selection in the adjustable configuration and fixed output levels makes the device an optimal supply for building automation and power tools.

7.2 Typical Applications



图 7-1. Typical Application Circuit (Fixed-Voltage Version)



图 7-2. TPS714 Adjustable LDO Regulator Programming

7.2.1 Design Requirements

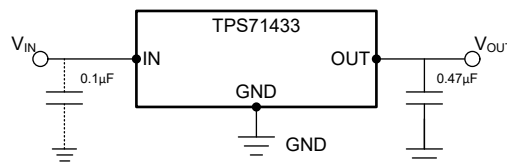
The minimum output capacitor (C_{OUT}) value for stability is needed, as suggested in the [Recommended Operating Conditions](#).

表 7-1 summarizes the design requirements for this application.

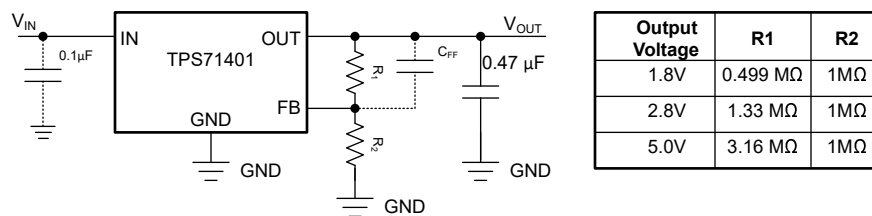
表 7-1. Design Parameters

PARAMETER	VALUE
Input voltage	4.3 V
Output voltage	3.3 V
Output current	50 mA

7.2.2 Detailed Design Procedure

7.2.2.1 Setting V_{OUT} for the TPS71401 Adjustable LDO

The TPS714 contains an adjustable version, the TPS71401, which sets the output voltage using an external resistor divider, as shown in 图 7-2. The output voltage operating range is 1.205 V to 8.8 V, and is calculated using:

$$V_{OUT} = V_{REF} \times \left(1 + \frac{R1}{R2} \right) \quad (2)$$

where:

- $V_{REF} = 1.205 \text{ V}$ (typical)

Choosing resistors R1 and R2 allows approximately $1.5 \mu\text{A}$ of current through the resistor divider. Lower value resistors can be used for improved noise performance, but consume more power. Avoid higher resistor values because leakage current into or out of FB across R1 / R2 creates an offset voltage that is proportional to V_{OUT} divided by V_{REF} . The recommended design procedure is to choose $R2 = 1 \text{ M}\Omega$ to set the divider current at $1.5 \mu\text{A}$, and then calculate R1 using [方程式 3](#):

$$R1 = \left(\frac{V_{OUT}}{V_{REF}} - 1 \right) \times R2 \quad (3)$$

[图 7-2](#) depicts this configuration.

7.2.2.2 External Capacitor Requirements

The device is designed to be stable using low equivalent series resistance (ESR) ceramic capacitors at the input and output. Multilayer ceramic capacitors have become the industry standard for these types of applications and are recommended, but must be used with good judgment. Ceramic capacitors that employ X7R-, X5R-, and C0G-rated dielectric materials provide relatively good capacitive stability across temperature, whereas the use of Y5V-rated capacitors is discouraged because of large variations in capacitance.

Regardless of the ceramic capacitor type selected, the effective capacitance varies with operating voltage and temperature. Generally, expect the effective capacitance to decrease by as much as 50%. The input and output capacitors recommended in the [Recommended Operating Conditions](#) table account for an effective capacitance of approximately 50% of the nominal value. For the legacy chip, Any capacitor (including ceramic and tantalum) greater than or equal to $0.47 \mu\text{F}$ properly stabilizes the output regulation loop.

Although not required, a $0.1\text{-}\mu\text{F}$ or larger input bypass capacitor, connected between IN and GND and located close to the device, improves transient response and noise rejection of the power supply as a whole. A higher-value input capacitor can be necessary if large, fast-rise-time load transients are anticipated and the device is located several inches from the power source.

7.2.2.3 Input and Output Capacitor Requirements

Although an input capacitor is not required for stability, good analog design practice is to connect a capacitor from IN to GND. This capacitor counteracts reactive input sources and improves transient response, input ripple, and PSRR. Use an input capacitor if the source impedance is more than 0.5Ω . A higher value capacitor can be necessary if large, fast rise-time load or line transients are anticipated or if the device is located several inches from the input power source.

Dynamic performance of the device is improved with the use of a large output capacitor. Use an output capacitor within the range specified in the [Recommended Operating Conditions](#) table for stability.

7.2.2.4 Reverse Current

Excessive reverse current can damage this device. Reverse current flows through the intrinsic body diode of the PMOS pass transistor instead of the normal conducting channel. At high magnitudes, this current flow degrades the long-term reliability of the device.

Conditions where reverse current can occur are outlined in this section, all of which can exceed the absolute maximum rating of $V_{OUT} \leq V_{IN} + 0.3 \text{ V}$. These conditions are:

- If the device has a large C_{OUT} and the input supply collapses with little or no load current
- The output is biased when the input supply is not established
- The output is biased above the input supply

If reverse current flow is expected in the application, external protection is recommended to protect the device. Reverse current is not limited in the device, so external limiting is required if extended reverse voltage operation

is anticipated. Limit reverse current to 5% or less of the rated output current of the device in the event this current cannot be avoided.

图 7-3 shows one approach for protecting the device.



图 7-3. Example Circuit for Reverse Current Protection Using a Schottky Diode

7.2.2.5 Feed-Forward Capacitor (C_{FF})

For the adjustable-voltage version device, a feed-forward capacitor (C_{FF}) can be connected from the OUT pin to the FB pin. C_{FF} improves transient, noise, and PSRR performance, but is not required for regulator stability. Recommended C_{FF} values are listed in the [Recommended Operating Conditions](#) table. A higher capacitance C_{FF} can be used; however, the start-up time increases. For a detailed description of C_{FF} tradeoffs, see the [Pros and Cons of Using a Feedforward Capacitor with a Low-Dropout Regulator application note](#).

C_{FF} and R_1 form a zero in the loop gain at frequency f_z , while C_{FF} , R_1 , and R_2 form a pole in the loop gain at frequency f_p . C_{FF} zero and pole frequencies can be calculated from the following equations:

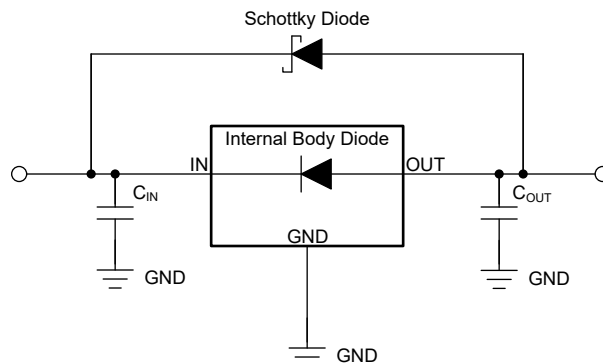
$$f_z = 1 / (2 \times \pi \times C_{FF} \times R_1) \quad (4)$$

$$f_p = 1 / (2 \times \pi \times C_{FF} \times (R_1 \parallel R_2)) \quad (5)$$

$C_{FF} \geq 10$ pF is required for stability if the feedback divider current is less than 5 μ A. 方程式 6 calculates the feedback divider current.

$$I_{FB_Divider} = V_{OUT} / (R_1 + R_2) \quad (6)$$

To avoid start-up time increases from C_{FF} , limit the product $C_{FF} \times R_1 < 50$ μ s.

For an output voltage of 1.205 V with the FB pin tied to the OUT pin, no C_{FF} is used.

7.2.2.6 Power Dissipation (P_D)

Circuit reliability requires consideration of the device power dissipation, location of the circuit on the printed circuit board (PCB), and correct sizing of the thermal plane. The PCB area around the regulator must have few or no other heat-generating devices that cause added thermal stress.

To first-order approximation, power dissipation in the regulator depends on the input-to-output voltage difference and load conditions. The following equation calculates power dissipation (P_D).

$$P_D = (V_{IN} - V_{OUT}) \times I_{OUT} \quad (7)$$

备注

Power dissipation can be minimized, and therefore greater efficiency can be achieved, by correct selection of the system voltage rails. For the lowest power dissipation, use the minimum input voltage required for correct output regulation.

For devices with a thermal pad, the primary heat conduction path for the device package is through the thermal pad to the PCB. Solder the thermal pad to a copper pad area under the device. This pad area must contain an array of plated vias that conduct heat to additional copper planes for increased heat dissipation.

The maximum power dissipation determines the maximum allowable ambient temperature (T_A) for the device. According to the following equation, power dissipation and junction temperature are most often related by the junction-to-ambient thermal resistance ($R_{\theta JA}$) of the combined PCB and device package and the temperature of the ambient air (T_A).

$$T_J = T_A + (R_{\theta JA} \times P_D) \quad (8)$$

Thermal resistance ($R_{\theta JA}$) is highly dependent on the heat-spreading capability built into the particular PCB design, and therefore varies according to the total copper area, copper weight, and location of the planes. The junction-to-ambient thermal resistance listed in the *Thermal Information* table is determined by the JEDEC standard PCB and copper-spreading area, and is used as a relative measure of package thermal performance.

7.2.2.7 Estimating Junction Temperature

The JEDEC standard now recommends the use of psi (Ψ) thermal metrics to estimate the junction temperatures of the linear regulator when in-circuit on a typical PCB board application. These metrics are not thermal resistance parameters and instead offer a practical and relative way to estimate junction temperature. These psi metrics are determined to be significantly independent of the copper area available for heat-spreading. The *Thermal Information* table lists the primary thermal metrics, which are the junction-to-top characterization parameter (ψ_{JT}) and junction-to-board characterization parameter (ψ_{JB}). These parameters provide two methods for calculating the junction temperature (T_J), as described in the following equations. Use the junction-to-top characterization parameter (ψ_{JT}) with the temperature at the center-top of device package (T_T) to calculate the junction temperature. Use the junction-to-board characterization parameter (ψ_{JB}) with the PCB surface temperature 1 mm from the device package (T_B) to calculate the junction temperature.

$$T_J = T_T + \psi_{JT} \times P_D \quad (9)$$

where:

- P_D is the dissipated power
- T_T is the temperature at the center-top of the device package

$$T_J = T_B + \psi_{JB} \times P_D \quad (10)$$

where:

- T_B is the PCB surface temperature measured 1 mm from the device package and centered on the package edge

For detailed information on the thermal metrics and how to use them, see the [Semiconductor and IC Package Thermal Metrics application note](#).

7.2.3 Application Curves

at operating temperature $T_J = 25^\circ\text{C}$, $V_{IN} = V_{OUT(\text{NOM})} + 1.0\text{ V}$ or 2.5 V (whichever is greater), $I_{OUT} = 1\text{ mA}$, $C_{IN} = 1\text{ }\mu\text{F}$, and $C_{OUT} = 1\text{ }\mu\text{F}$ (unless otherwise noted)



图 7-4. Power-Up and Power-Down (Legacy Chip)



图 7-5. Power-Up and Power-Down (New Chip)

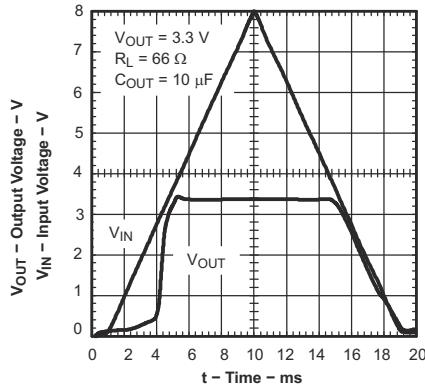

图 7-6. TPS71433 Fast Power-Up (Legacy Chip)

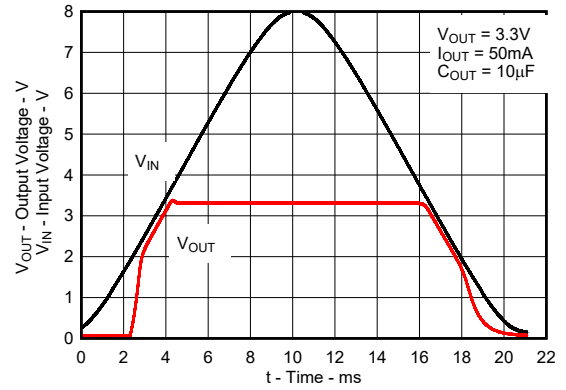

图 7-7. TPS71433 Fast Power-Up (New Chip)

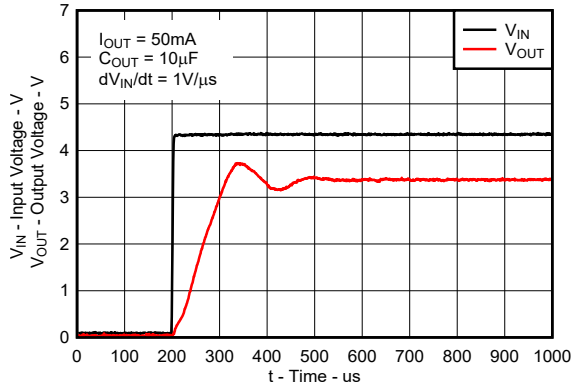

图 7-8. Line Transient Response (Legacy Chip)

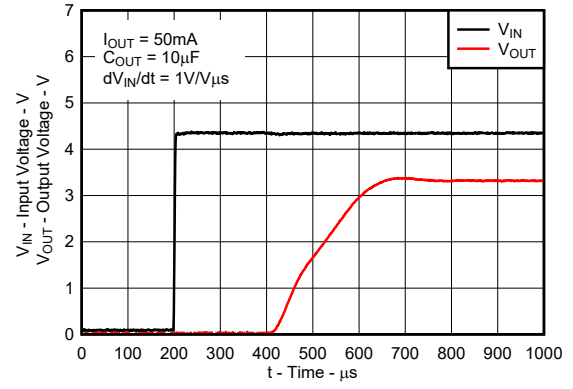

图 7-9. Line Transient Response (New Chip)

7.2.3 Application Curves (continued)

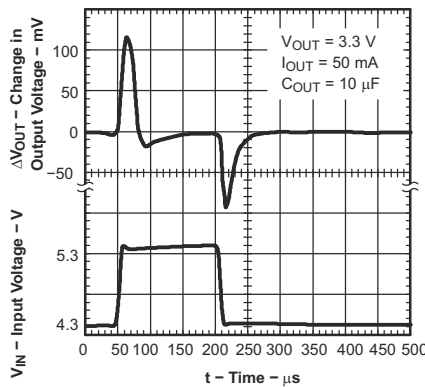
at operating temperature $T_J = 25^\circ\text{C}$, $V_{IN} = V_{OUT(NOM)} + 1.0\text{ V}$ or 2.5 V (whichever is greater), $I_{OUT} = 1\text{ mA}$, $C_{IN} = 1\text{ }\mu\text{F}$, and $C_{OUT} = 1\text{ }\mu\text{F}$ (unless otherwise noted)

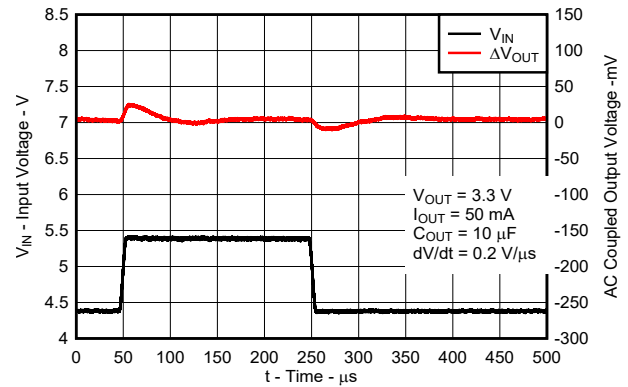

图 7-10. Load Transient Response (Legacy Chip)



图 7-11. Load Transient Response (New Chip)

7.3 Power Supply Recommendations

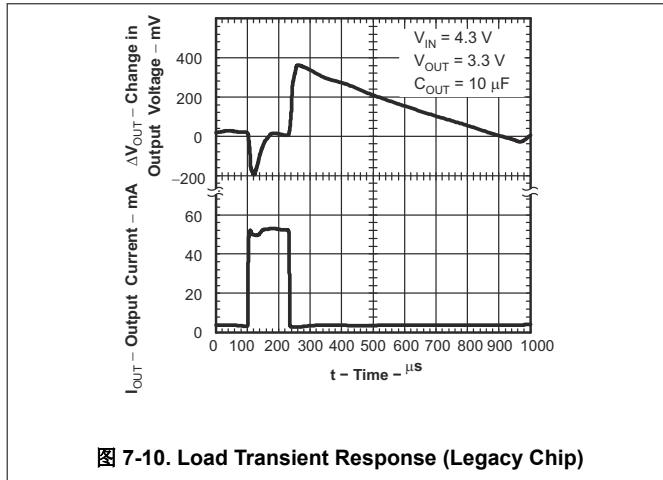
The TPS714 is designed to operate from an input voltage supply range between 2.5 V and 10 V. The input voltage range provides adequate headroom for the device to have a regulated output. If the input supply is noisy, additional input capacitors with low ESR can help improve the output noise performance.

7.4 Layout

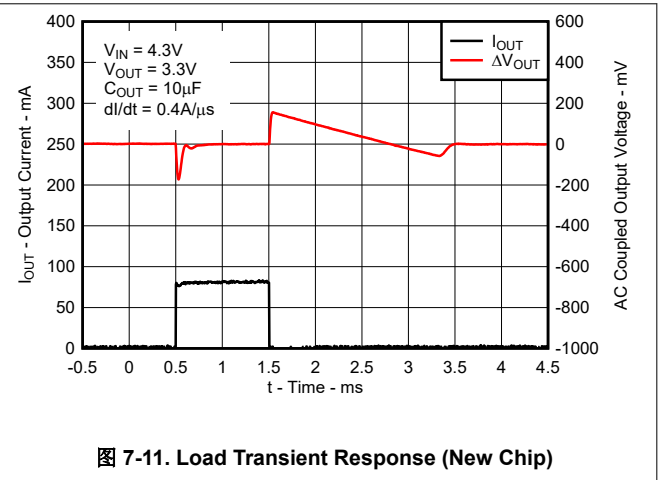
7.4.1 Layout Guidelines

For best overall performance, place all circuit components on the same side of the printed-circuit-board and as near as practical to the respective LDO pin connections. Place ground return connections for the input and output capacitors as close to the GND pin as possible, using wide, component-side, copper planes. Avoid using vias and long traces to create LDO circuit connections to the input capacitor, output capacitor, or the resistor divider because doing so negatively affects system performance. This grounding and layout scheme minimizes inductive parasitics, and thereby reduces load-current transients, minimizes noise, and increases circuit stability. A ground reference plane is recommended to be embedded either in the PCB or located on the bottom side of the PCB opposite the components. This reference plane provides accuracy of the output voltage and shields the LDO from noise.

7.4.1.1 Power Dissipation

To provide reliable operation, worst-case junction temperature must not exceed 125°C . This restriction limits the power dissipation the regulator can handle in any given application. To make sure the junction temperature is within acceptable limits, calculate the maximum allowable dissipation, $P_{D(max)}$, and the actual dissipation, P_D , which must be less than or equal to $P_{D(max)}$.

The maximum-power-dissipation limit is determined using [方程式 11](#).

$$P_{D(max)} = \frac{T_{Jmax} - T_A}{R_{\theta JA}} \quad (11)$$

where:

- T_{Jmax} is the maximum allowable junction temperature
- $R_{\theta JA}$ is the thermal resistance junction-to-ambient for the package (see the *Thermal Information* table)
- T_A is the ambient temperature

The regulator power dissipation is calculated using [方程式 12](#).

$$P_D = (V_{IN} - V_{OUT}) \times I_{OUT} \tag{12}$$

For wider input range requirement, see the [TPS715A](#).

7.4.2 Layout Example



图 7-12. Example Layout for the TPS714DCK



图 7-13. Example Layout for the TPS714DRV

8 Device and Documentation Support

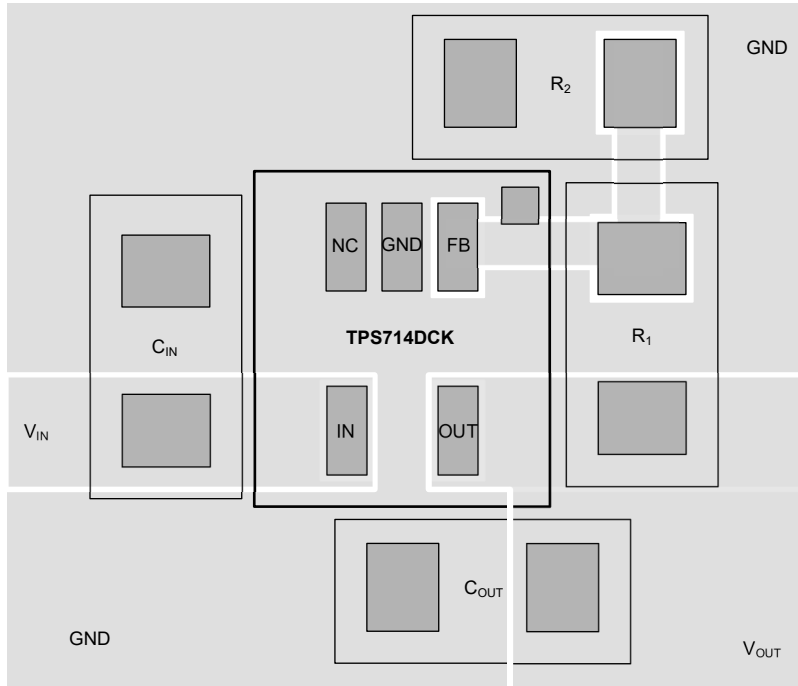
8.1 Device Support

8.1.1 Device Nomenclature

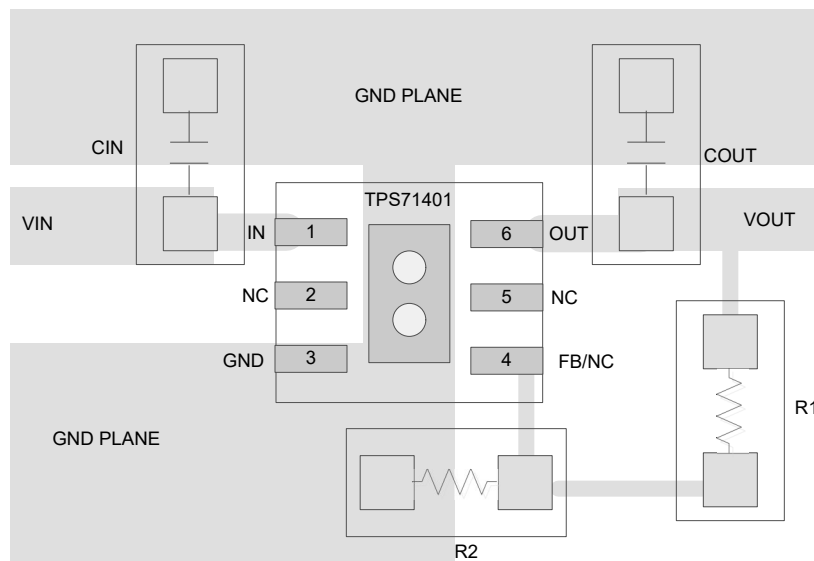
Device Information⁽¹⁾

PRODUCT	V _{OUT} ⁽²⁾
TPS714xyyyz	XX is nominal output voltage (for example 33 = 3.3 V, 01 = adjustable). YYY is package designator. Z is package quantity.
TPS714xyyyz M3	xx is nominal output voltage (for example 33 = 3.3V, 01 = adjustable) yyy is package designator z is package quantity M3 is a suffix designator for new chip redesigns on the latest TI process technology.

- (1) For the most current package and ordering information see the Package Option Addendum at the end of this document, or see the TI web site at www.ti.com.
- (2) Custom output voltages are available on a quick-turn basis for prototyping. Production quantities are available; minimum package order quantities apply. Contact factory for details and availability.

8.2 接收文档更新通知

要接收文档更新通知，请导航至 ti.com 上的器件产品文件夹。点击 [通知](#) 进行注册，即可每周接收产品信息更改摘要。有关更改的详细信息，请查看任何已修订文档中包含的修订历史记录。

8.3 支持资源

TI E2E™ 中文支持论坛是工程师的重要参考资料，可直接从专家处获得快速、经过验证的解答和设计帮助。搜索现有解答或提出自己的问题，获得所需的快速设计帮助。

链接的内容由各个贡献者“按原样”提供。这些内容并不构成 TI 技术规范，并且不一定反映 TI 的观点；请参阅 TI 的 [使用条款](#)。

8.4 Trademarks

TI E2E™ is a trademark of Texas Instruments.

所有商标均为其各自所有者的财产。

8.5 静电放电警告



静电放电 (ESD) 会损坏这个集成电路。德州仪器 (TI) 建议通过适当的预防措施处理所有集成电路。如果不遵守正确的处理和安装程序，可能会损坏集成电路。

ESD 的损坏小至导致微小的性能降级，大至整个器件故障。精密的集成电路可能更容易受到损坏，这是因为非常细微的参数更改都可能会导致器件与其发布的规格不相符。

8.6 术语表

TI 术语表 本术语表列出并解释了术语、首字母缩略词和定义。

9 Revision History

注：以前版本的页码可能与当前版本的页码不同

Changes from Revision C (March 2011) to Revision D (November 2023)	Page
• 更新了整个文档中的表格、图和交叉参考的编号格式.....	1
• 添加了器件信息表、第 1 页上的图、ESD 等级、建议运行条件、热性能信息、概述、特性说明、器件功能模式、应用和实施、器件和文档支持以及机械、封装和可订购信息部分.....	1
• 通篇将 SON 更改为 WSON	1
• 更改了特性、应用和说明部分.....	1
• Changed <i>Description</i> column of <i>Pin Functions</i> table and added table footnotes.....	3
• Added curves for new chip to <i>Typical Characteristics</i> section.....	7
<hr/>	
Changes from Revision B (December 2009) to Revision C (March 2011)	Page
• Changed <i>Ground pin current</i> maximum specifications in <i>Electrical Characteristics</i> table.....	4

10 Mechanical, Packaging, and Orderable Information

The following pages include mechanical, packaging, and orderable information. This information is the most current data available for the designated devices. This data is subject to change without notice and revision of this document. For browser-based versions of this data sheet, refer to the left-hand navigation.

PACKAGING INFORMATION

Orderable Device	Status (1)	Package Type	Package Drawing	Pins	Package Qty	Eco Plan (2)	Lead finish/ Ball material (6)	MSL Peak Temp (3)	Op Temp (°C)	Device Marking (4/5)	Samples
TPS71401DCKR	ACTIVE	SC70	DCK	5	3000	RoHS & Green	NIPDAU NIPDAUAG	Level-1-260C-UNLIM	-40 to 125	CVG	Samples
TPS71401DCKT	ACTIVE	SC70	DCK	5	250	RoHS & Green	NIPDAUAG	Level-1-260C-UNLIM	-40 to 125	CVG	Samples
TPS71401DRVR	ACTIVE	WSON	DRV	6	3000	RoHS & Green	NIPDAU	Level-1-260C-UNLIM	-40 to 125	CVG	Samples
TPS71401DRVRM3	ACTIVE	WSON	DRV	6	3000	RoHS & Green	NIPDAU	Level-1-260C-UNLIM	-40 to 125	CVG	Samples
TPS71401DRVT	ACTIVE	WSON	DRV	6	250	RoHS & Green	NIPDAU	Level-1-260C-UNLIM	-40 to 125	CVG	Samples
TPS71433DCKR	ACTIVE	SC70	DCK	5	3000	RoHS & Green	NIPDAU NIPDAUAG	Level-1-260C-UNLIM	-40 to 125	CVH	Samples
TPS71433DCKT	OBSOLETE	SC70	DCK	5		TBD	Call TI	Call TI	-40 to 125	CVH	
TPS71433DRVR	ACTIVE	WSON	DRV	6	3000	RoHS & Green	NIPDAU	Level-1-260C-UNLIM	-40 to 125	CVH	Samples
TPS71433DRVT	ACTIVE	WSON	DRV	6	250	RoHS & Green	NIPDAU	Level-1-260C-UNLIM	-40 to 125	CVH	Samples

(1) The marketing status values are defined as follows:

ACTIVE: Product device recommended for new designs.

LIFEBUY: TI has announced that the device will be discontinued, and a lifetime-buy period is in effect.

NRND: Not recommended for new designs. Device is in production to support existing customers, but TI does not recommend using this part in a new design.

PREVIEW: Device has been announced but is not in production. Samples may or may not be available.

OBSOLETE: TI has discontinued the production of the device.

(2) **RoHS:** TI defines "RoHS" to mean semiconductor products that are compliant with the current EU RoHS requirements for all 10 RoHS substances, including the requirement that RoHS substance do not exceed 0.1% by weight in homogeneous materials. Where designed to be soldered at high temperatures, "RoHS" products are suitable for use in specified lead-free processes. TI may reference these types of products as "Pb-Free".

RoHS Exempt: TI defines "RoHS Exempt" to mean products that contain lead but are compliant with EU RoHS pursuant to a specific EU RoHS exemption.

Green: TI defines "Green" to mean the content of Chlorine (Cl) and Bromine (Br) based flame retardants meet JS709B low halogen requirements of <=1000ppm threshold. Antimony trioxide based flame retardants must also meet the <=1000ppm threshold requirement.

(3) MSL, Peak Temp. - The Moisture Sensitivity Level rating according to the JEDEC industry standard classifications, and peak solder temperature.

(4) There may be additional marking, which relates to the logo, the lot trace code information, or the environmental category on the device.

⁽⁵⁾ Multiple Device Markings will be inside parentheses. Only one Device Marking contained in parentheses and separated by a "~" will appear on a device. If a line is indented then it is a continuation of the previous line and the two combined represent the entire Device Marking for that device.

⁽⁶⁾ Lead finish/Ball material - Orderable Devices may have multiple material finish options. Finish options are separated by a vertical ruled line. Lead finish/Ball material values may wrap to two lines if the finish value exceeds the maximum column width.

Important Information and Disclaimer:The information provided on this page represents TI's knowledge and belief as of the date that it is provided. TI bases its knowledge and belief on information provided by third parties, and makes no representation or warranty as to the accuracy of such information. Efforts are underway to better integrate information from third parties. TI has taken and continues to take reasonable steps to provide representative and accurate information but may not have conducted destructive testing or chemical analysis on incoming materials and chemicals. TI and TI suppliers consider certain information to be proprietary, and thus CAS numbers and other limited information may not be available for release.

In no event shall TI's liability arising out of such information exceed the total purchase price of the TI part(s) at issue in this document sold by TI to Customer on an annual basis.

TAPE AND REEL INFORMATION

QUADRANT ASSIGNMENTS FOR PIN 1 ORIENTATION IN TAPE

*All dimensions are nominal

Device	Package Type	Package Drawing	Pins	SPQ	Reel Diameter (mm)	Reel Width W1 (mm)	A0 (mm)	B0 (mm)	K0 (mm)	P1 (mm)	W (mm)	Pin1 Quadrant
TPS71401DCKR	SC70	DCK	5	3000	178.0	9.0	2.4	2.5	1.2	4.0	8.0	Q3
TPS71401DCKT	SC70	DCK	5	250	180.0	8.4	2.41	2.41	1.2	4.0	8.0	Q3
TPS71401DRVR	WS0N	DRV	6	3000	180.0	8.4	2.3	2.3	1.15	4.0	8.0	Q2
TPS71401DRVRM3	WS0N	DRV	6	3000	180.0	8.4	2.3	2.3	1.15	4.0	8.0	Q2
TPS71401DRVT	WS0N	DRV	6	250	179.0	8.4	2.2	2.2	1.2	4.0	8.0	Q2
TPS71433DCKR	SC70	DCK	5	3000	178.0	9.0	2.4	2.5	1.2	4.0	8.0	Q3
TPS71433DRVR	WS0N	DRV	6	3000	179.0	8.4	2.2	2.2	1.2	4.0	8.0	Q2
TPS71433DRVT	WS0N	DRV	6	250	179.0	8.4	2.2	2.2	1.2	4.0	8.0	Q2

TAPE AND REEL BOX DIMENSIONS

*All dimensions are nominal

Device	Package Type	Package Drawing	Pins	SPQ	Length (mm)	Width (mm)	Height (mm)
TPS71401DCKR	SC70	DCK	5	3000	180.0	180.0	18.0
TPS71401DCKT	SC70	DCK	5	250	183.0	183.0	20.0
TPS71401DRVR	WSON	DRV	6	3000	210.0	185.0	35.0
TPS71401DRVRM3	WSON	DRV	6	3000	210.0	185.0	35.0
TPS71401DRVT	WSON	DRV	6	250	203.0	203.0	35.0
TPS71433DCKR	SC70	DCK	5	3000	180.0	180.0	18.0
TPS71433DRVR	WSON	DRV	6	3000	200.0	183.0	25.0
TPS71433DRVT	WSON	DRV	6	250	203.0	203.0	35.0



4214834/G 11/2024

NOTES:

1. All linear dimensions are in millimeters. Any dimensions in parenthesis are for reference only. Dimensioning and tolerancing per ASME Y14.5M.
2. This drawing is subject to change without notice.
3. Reference JEDEC MO-203.
4. Support pin may differ or may not be present.
5. Lead width does not comply with JEDEC.
6. Body dimensions do not include mold flash, protrusions, or gate burrs. Mold flash, protrusions, or gate burrs shall not exceed 0.25mm per side

EXAMPLE BOARD LAYOUT

DCK0005A

SOT - 1.1 max height

SMALL OUTLINE TRANSISTOR



LAND PATTERN EXAMPLE
EXPOSED METAL SHOWN
SCALE:18X

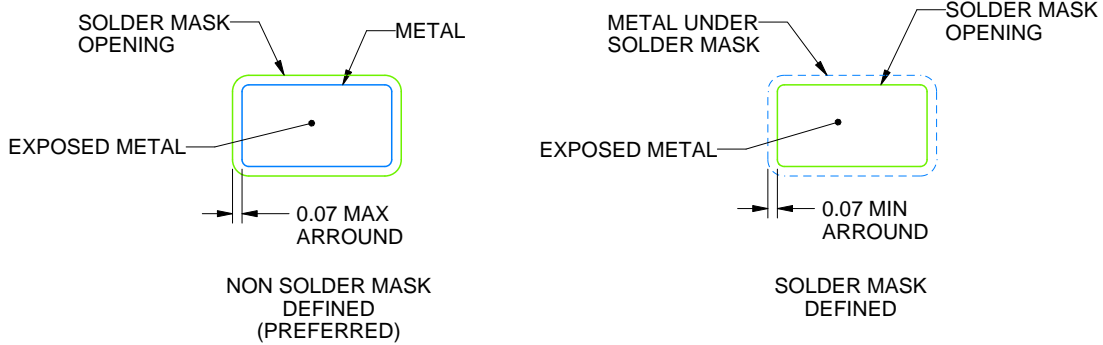

SOLDER MASK DETAILS

4214834/G 11/2024

NOTES: (continued)

- 7. Publication IPC-7351 may have alternate designs.
- 8. Solder mask tolerances between and around signal pads can vary based on board fabrication site.

EXAMPLE STENCIL DESIGN

DCK0005A

SOT - 1.1 max height

SMALL OUTLINE TRANSISTOR



SOLDER PASTE EXAMPLE
BASED ON 0.125 THICK STENCIL
SCALE: 18X

4214834/G 11/2024

NOTES: (continued)

9. Laser cutting apertures with trapezoidal walls and rounded corners may offer better paste release. IPC-7525 may have alternate design recommendations.
10. Board assembly site may have different recommendations for stencil design.

GENERIC PACKAGE VIEW

DRV 6

WSON - 0.8 mm max height

PLASTIC SMALL OUTLINE - NO LEAD



Images above are just a representation of the package family, actual package may vary.
Refer to the product data sheet for package details.

4206925/F



4222173/B 04/2018

NOTES:

1. All linear dimensions are in millimeters. Any dimensions in parenthesis are for reference only. Dimensioning and tolerancing per ASME Y14.5M.
2. This drawing is subject to change without notice.
3. The package thermal pad must be soldered to the printed circuit board for thermal and mechanical performance.

EXAMPLE BOARD LAYOUT

DRV0006A

WSON - 0.8 mm max height

PLASTIC SMALL OUTLINE - NO LEAD



LAND PATTERN EXAMPLE
SCALE:25X



SOLDER MASK DETAILS

4222173/B 04/2018

NOTES: (continued)

- This package is designed to be soldered to a thermal pad on the board. For more information, see Texas Instruments literature number SLUA271 (www.ti.com/lit/slua271).
- Vias are optional depending on application, refer to device data sheet. If some or all are implemented, recommended via locations are shown.

EXAMPLE STENCIL DESIGN

DRV0006A

WSON - 0.8 mm max height

PLASTIC SMALL OUTLINE - NO LEAD



SOLDER PASTE EXAMPLE
BASED ON 0.125 mm THICK STENCIL

EXPOSED PAD #7
88% PRINTED SOLDER COVERAGE BY AREA UNDER PACKAGE
SCALE:30X

4222173/B 04/2018

NOTES: (continued)

6. Laser cutting apertures with trapezoidal walls and rounded corners may offer better paste release. IPC-7525 may have alternate design recommendations.

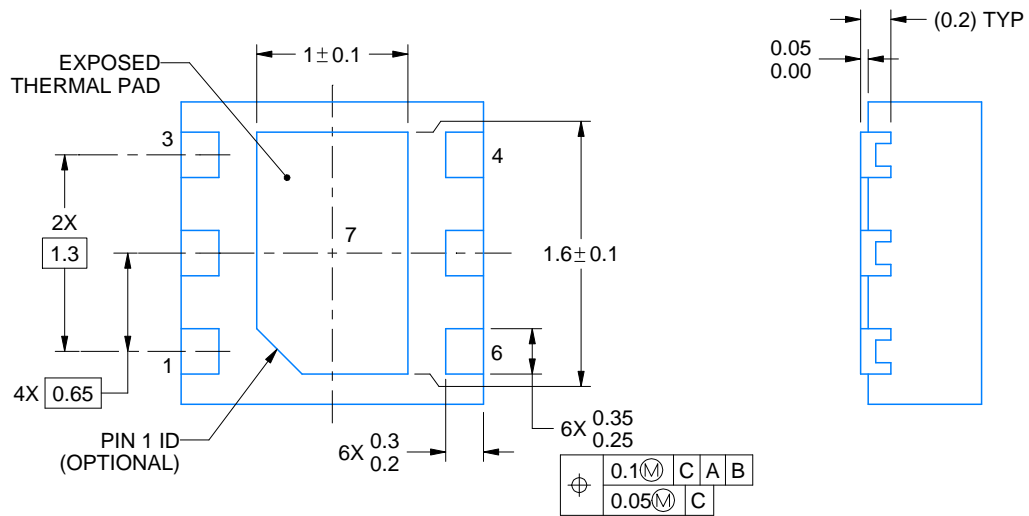

4225563/A 12/2019

NOTES:

1. All linear dimensions are in millimeters. Any dimensions in parenthesis are for reference only. Dimensioning and tolerancing per ASME Y14.5M.
2. This drawing is subject to change without notice.
3. The package thermal pad must be soldered to the printed circuit board for thermal and mechanical performance.

EXAMPLE BOARD LAYOUT

DRV0006D

WSON - 0.8 mm max height

PLASTIC SMALL OUTLINE - NO LEAD



LAND PATTERN EXAMPLE
EXPOSED METAL SHOWN
SCALE:25X

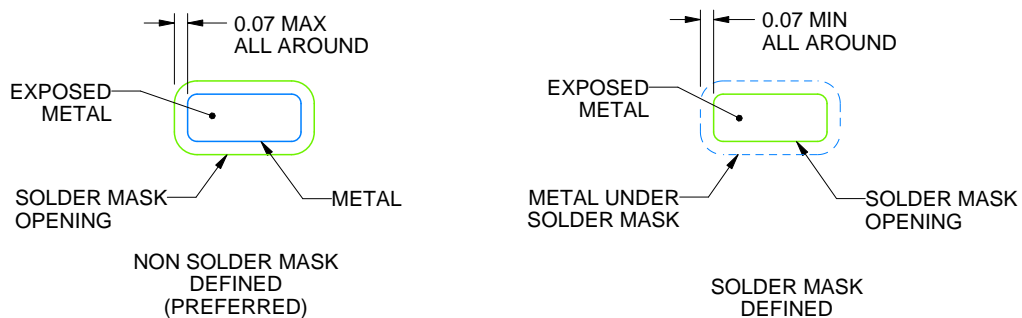

SOLDER MASK DETAILS

4225563/A 12/2019

NOTES: (continued)

4. This package is designed to be soldered to a thermal pad on the board. For more information, see Texas Instruments literature number SLUA271 (www.ti.com/lit/sluea271).
5. Vias are optional depending on application, refer to device data sheet. If some or all are implemented, recommended via locations are shown.

EXAMPLE STENCIL DESIGN

DRV0006D

WSON - 0.8 mm max height

PLASTIC SMALL OUTLINE - NO LEAD



SOLDER PASTE EXAMPLE
BASED ON 0.125 mm THICK STENCIL

EXPOSED PAD #7
88% PRINTED SOLDER COVERAGE BY AREA UNDER PACKAGE
SCALE:30X

4225563/A 12/2019

NOTES: (continued)

6. Laser cutting apertures with trapezoidal walls and rounded corners may offer better paste release. IPC-7525 may have alternate design recommendations.

重要通知和免责声明

TI“按原样”提供技术和可靠性数据（包括数据表）、设计资源（包括参考设计）、应用或其他设计建议、网络工具、安全信息和其他资源，不保证没有瑕疵且不做任何明示或暗示的担保，包括但不限于对适销性、某特定用途方面的适用性或不侵犯任何第三方知识产权的暗示担保。

这些资源可供使用 TI 产品进行设计的熟练开发人员使用。您将自行承担以下全部责任：(1) 针对您的应用选择合适的 TI 产品，(2) 设计、验证并测试您的应用，(3) 确保您的应用满足相应标准以及任何其他功能安全、信息安全、监管或其他要求。

这些资源如有变更，恕不另行通知。TI 授权您仅可将这些资源用于研发本资源所述的 TI 产品的相关应用。严禁以其他方式对这些资源进行复制或展示。您无权使用任何其他 TI 知识产权或任何第三方知识产权。您应全额赔偿因在这些资源的使用中对 TI 及其代表造成的任何索赔、损害、成本、损失和债务，TI 对此概不负责。

TI 提供的产品受 [TI 的销售条款](#) 或 [ti.com](#) 上其他适用条款/TI 产品随附的其他适用条款的约束。TI 提供这些资源并不会扩展或以其他方式更改 TI 针对 TI 产品发布的适用的担保或担保免责声明。

TI 反对并拒绝您可能提出的任何其他或不同的条款。

邮寄地址：Texas Instruments, Post Office Box 655303, Dallas, Texas 75265
版权所有 © 2025，德州仪器 (TI) 公司