

TPS717xx 低噪声、高带宽 PSRR、 低压降、150mA 线性稳压器

1 特性

- 输入电压: +2.5V 至 +6.5V
- 提供多个输出版本:
 - 固定输出电压范围: 0.9V 至 5V
 - 可调节输出电压范围为 0.9V 至 6.2V
- 超高 PSRR:
 - 1kHz 时 70dB, 100kHz 时 67dB, 1MHz 时 45dB
- 出色的负载和线路瞬态响应
- 超低压降: 150mA 时为 170mV (典型值)
- 低噪声: 30 μ V_{RMS} 典型值 (100Hz 至 100kHz)
- 小型 5 引脚 SC-70、2mm x 2mm 晶圆级小外形无引线 (WSON)-6 封装和 1.5mm x 1.5mm WSON-6 封装

2 应用

- 摄像机传感器电源
- 移动电话耳机
- 掌上电脑 (PDA) 和智能手机
- 无线 LAN, Bluetooth®

3 说明

TPS717xx 系列低压降 (LDO)、低功耗线性稳压器采用超小型 5 引脚小外形尺寸晶体管 (SOT) 封装, 其具有非常高的电源抑制比 (PSRR), 同时能够保持 45 μ A 的超低接地电流。该系列稳压器采用先进的双极 CMOS (BiCMOS) 工艺和功率金属氧化物半导体场效应晶体管 (PMOSFET) 无源器件, 可实现快速启动、超低噪声、优异的瞬态响应以及出色的 PSRR 性能。TPS717xx 器件与 1 μ F 陶瓷输出电容一起工作时可保持稳定, 并且使用了一个精确的电压基准和反馈环路, 以在所有负载、线路、过程和温度变化范围内实现至少 3% 的精度。该器件系列的额定温度范围为 $T_J = -40^{\circ}\text{C}$ 至 125°C , 并且提供小型 SOT (SC70-5) 封装、带有散热焊盘的

2mm x 2mm WSON-6 封装以及 1.5mm x 1.5mm WSON-6 封装, 非常适合小尺寸便携式设备 (例如无线手持设备和 PDA)。

器件信息⁽¹⁾

器件型号	封装	封装尺寸 (标称值)
TPS717xx	SC70 (5)	2.00mm x 1.25mm
	WSON (6)	2.00mm x 2.00mm
	WSON (6)	1.50mm x 1.50mm

(1) 如需了解所有可用封装和电压选项, 请见数据表末尾的可订购产品附录。

针对固定电压版本的典型应用电路

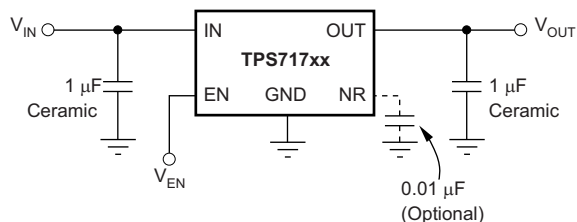

PSRR 与频率间的关系

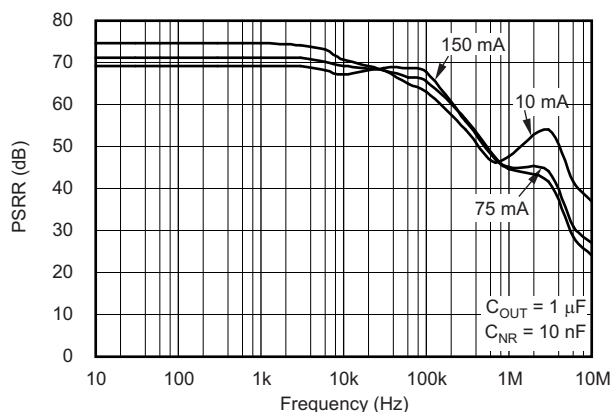

Power-Supply Rejection Ratio ($V_{IN} - V_{OUT} = 1\text{ V}$)



目录

<p>1 特性 1</p> <p>2 应用 1</p> <p>3 说明 1</p> <p>4 修订历史记录 2</p> <p>5 Pin Configuration and Functions 3</p> <p>6 Specifications 4</p> <p> 6.1 Absolute Maximum Ratings 4</p> <p> 6.2 ESD Ratings 4</p> <p> 6.3 Recommended Operating Conditions 4</p> <p> 6.4 Thermal Information 4</p> <p> 6.5 Electrical Characteristics 5</p> <p> 6.6 Typical Characteristics 6</p> <p>7 Detailed Description 11</p> <p> 7.1 Overview 11</p> <p> 7.2 Functional Block Diagrams 11</p> <p> 7.3 Feature Description 12</p> <p> 7.4 Device Functional Modes 13</p>	<p>8 Application and Implementation 15</p> <p> 8.1 Application Information 15</p> <p> 8.2 Typical Applications 16</p> <p> 8.3 Do's and Don'ts 18</p> <p>9 Power Supply Recommendations 18</p> <p>10 Layout 19</p> <p> 10.1 Layout Guidelines 19</p> <p> 10.2 Layout Example 19</p> <p> 10.3 Power Dissipation 20</p> <p>11 器件和文档支持 22</p> <p> 11.1 器件支持 22</p> <p> 11.2 文档支持 22</p> <p> 11.3 商标 22</p> <p> 11.4 静电放电警告 22</p> <p> 11.5 术语表 22</p> <p>12 机械封装和可订购信息 22</p>
--	---

4 修订历史记录

Changes from Revision G (April 2009) to Revision H	Page
• Changed pin descriptions throughout <i>Pin Functions</i> table 3	3
• Added <i>ESD Ratings</i> table, <i>Feature Description</i> section, <i>Device Functional Modes</i> , <i>Application and Implementation</i> section, <i>Power Supply Recommendations</i> section, <i>Layout</i> section, <i>Device and Documentation Support</i> section, and <i>Mechanical, Packaging, and Orderable Information</i> section 4	4
• Changed load regulation typical specification from 120 μ V to 70 μ V to better reflect device performance 5	5
• Changed condition for $C_{NR} = \text{none}$ for V_n parameter 5	5
• Changed Figure 1 , Figure 2 , Figure 3 , and Figure 4 : removed legend, added call-outs for clarity 6	6
• Changed titles of Figure 15 , Figure 17 , and Figure 25 7	7
• Corrected input and output symbols in operational amplifiers in <i>Functional Block Diagrams</i> 11	11
• Changed <i>Undervoltage Lockout (UVLO)</i> section text: reworded for clarity 13	13
• Deleted <i>Reverse Current Protection</i> section 15	15

Changes from Revision F (February 2009) to Revision G	Page
• Changed min and max specs for <i>Output accuracy</i> , $V_{OUT} \geq 1.0V$ 5	5

5 Pin Configuration and Functions

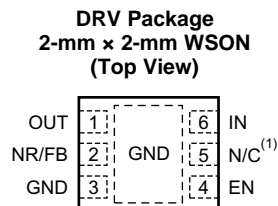
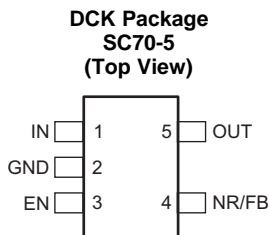

(1) N/C = No connection

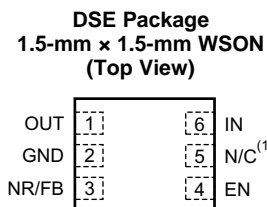

Pin Functions

NAME	PIN			I/O	DESCRIPTION
	DCK	DRV	DSE		
EN	3	4	4	I	Driving the enable pin (EN) above $V_{EN(\text{high})}$ turns on the regulator. Driving this pin below $V_{EN(\text{low})}$ puts the regulator into standby mode, thereby disabling the output and reducing operating current.
FB	4	2	3	I	Adjustable voltage version only. The voltage at this pin is fed to the error amplifier. A resistor divider from OUT to FB sets the output voltage when in regulation.
GND	2	3	2	—	Ground
IN	1	6	6	I	Input to the device. A 0.1- μF to 1- μF capacitor is recommended for better performance.
N/C	—	5	5	—	Not connected. This pin can be tied to ground to improve thermal dissipation.
NR	4	2	3	—	Fixed voltage versions only. The noise reduction capacitor filters the noise generated by the internal band gap, thus lowering output noise.
OUT	5	1	1	O	This pin is the regulated output voltage. A minimum capacitance of 1 μF is required for stability from this pin to ground.

6 Specifications

6.1 Absolute Maximum Ratings

over operating temperature range (unless otherwise noted), all voltages are with respect to GND⁽¹⁾

		MIN	MAX	UNIT
Voltage	V _{IN}	-0.3	7	V
	V _{FB}	-0.3	3.6	V
	V _{NR}	-0.3	3.6	V
	V _{EN}	-0.3	V _{IN} + 0.3 V ⁽²⁾	V
	V _{OUT}	-0.3	7	V
Current	I _{OUT}	Internally limited		A
Continuous total power dissipation	P _{DISS}	See Thermal Information		
Operating junction temperature	T _J	-55	150	°C
Storage temperature	T _{stg}	-55	150	°C

- (1) Stresses beyond those listed under *Absolute Maximum Ratings* may cause permanent damage to the device. These are stress ratings only, which do not imply functional operation of the device at these or any other conditions beyond those indicated under *Recommended Operating Conditions*. Exposure to absolute-maximum-rated conditions for extended periods may affect device reliability.
- (2) V_{EN} absolute maximum rating is V_{IN} + 0.3 V or 7 V, whichever is greater.

6.2 ESD Ratings

		VALUE	UNIT
V _(ESD) Electrostatic discharge	Human body model (HBM), per ANSI/ESDA/JEDEC JS-001, all pins ⁽¹⁾	±2000	V
	Charged device model (CDM), per JEDEC specification JESD22-C101, all pins ⁽²⁾	±500	

- (1) JEDEC document JEP155 states that 500-V HBM allows safe manufacturing with a standard ESD control process.
- (2) JEDEC document JEP157 states that 250-V CDM allows safe manufacturing with a standard ESD control process.

6.3 Recommended Operating Conditions

over operating junction temperature range (unless otherwise noted)

		MIN	NOM	MAX	UNIT
V _{IN}	Input voltage	2.5		6.5	V
V _{OUT}	Output voltage	0.9		5	V
I _{OUT}	Output current	0		150	mA
V _{EN}	Enable voltage	0		V _{IN}	V
C _{OUT}	Output capacitor	1		100	µF
T _J	Junction temperature	-40		125	°C

6.4 Thermal Information

THERMAL METRIC ⁽¹⁾	TPS717xx			UNIT
	DCK	DRV	DSE	
	5 PINS	6 PINS	6 PINS	
R _{θJA} Junction-to-ambient thermal resistance	279.2	71.1	190.5	°C/W
R _{θJC(top)} Junction-to-case (top) thermal resistance	57.5	96.5	94.9	
R _{θJB} Junction-to-board thermal resistance	74.1	40.5	149.3	
Ψ _{JT} Junction-to-top characterization parameter	0.8	2.7	6.4	
Ψ _{JB} Junction-to-board characterization parameter	73.1	40.9	152.8	
R _{θJC(bot)} Junction-to-case (bottom) thermal resistance	n/a	10.7	n/a	

- (1) For more information about traditional and new thermal metrics, see the *IC Package Thermal Metrics* application report, [SPRA953](#).

6.5 Electrical Characteristics

Over operating temperature range ($T_J = -40^\circ\text{C}$ to 125°C), $V_{IN} = V_{OUT(nom)} + 0.5\text{ V}$ or 2.5 V , whichever is greater;
 $I_{OUT} = 0.5\text{ mA}$, $V_{EN} = V_{IN}$, $C_{OUT} = 1.0\text{ }\mu\text{F}$, $C_{NR} = 0.01\text{ }\mu\text{F}$, unless otherwise noted. For TPS71701, $V_{OUT} = 2.8\text{ V}$.
Typical values are at $T_J = 25^\circ\text{C}$.

PARAMETER		TEST CONDITIONS		MIN	TYP	MAX	UNIT
V_{IN}	Input voltage range ⁽¹⁾			2.5		6.5	V
V_{FB}	Internal reference (TPS71701)			0.790	0.800	0.810	V
V_{OUT}	Output voltage range	(TPS717xx)		0.9		5.0	V
		(TPS71701)		0.9		$6.5 - V_{DO}$	V
V_{OUT}	Output accuracy	Nominal	$T_J = 25^\circ\text{C}$		± 2.5		mV
	Output accuracy ($V_{OUT} < 1.0\text{ V}$)	Over V_{IN} , I_{OUT} , Temp ⁽²⁾	$V_{OUT} + 0.5\text{ V} \leq V_{IN} \leq 6.5\text{ V}$ $0\text{ mA} \leq I_{OUT} \leq 150\text{ mA}$	-30		+30	mV
	Output accuracy ($V_{OUT} \geq 1.0\text{ V}$)	Over V_{IN} , I_{OUT} , Temp ⁽²⁾	$V_{OUT} + 0.5\text{ V} \leq V_{IN} \leq 6.5\text{ V}$ $0\text{ mA} \leq I_{OUT} \leq 150\text{ mA}$	-3.0%		+3.0%	
$\Delta V_{OUT(\Delta V_{IN})}$	Line regulation ⁽¹⁾	$V_{OUT(nom)} + 0.5\text{ V} \leq V_{IN} \leq 6.5\text{ V}$, $I_{OUT} = 5\text{ mA}$			125		$\mu\text{V/V}$
$\Delta V_{OUT(\Delta I_{OUT})}$	Load regulation	$0\text{ mA} \leq I_{OUT} \leq 150\text{ mA}$			70		$\mu\text{V/mA}$
V_{DO}	Dropout voltage ⁽³⁾ ($V_{IN} = V_{OUT(nom)} - 0.1\text{ V}$)	$I_{OUT} = 150\text{ mA}$			170	300	mV
I_{LIM} (fixed)	Output current limit (fixed output)	$V_{OUT} = 0.9 \times V_{OUT(nom)}$		200	325	575	mA
I_{LIM} (adjustable)	Output current limit (TPS71701)	$V_{OUT} = 0.9 \times V_{OUT(nom)}$		200	325	575	mA
I_{GND}	Ground pin current	$I_{OUT} = 0.1\text{ mA}$			45	80	μA
		$I_{OUT} = 150\text{ mA}$			100		μA
I_{SHDN}	Shutdown current (I_{GND})	$V_{EN} \leq 0.4\text{ V}$, $T_J = -40^\circ\text{C}$ to 85°C	$2.5\text{ V} \leq V_{IN} < 4.5\text{ V}$		0.20	1.5	μA
			$4.5\text{ V} \leq V_{IN} \leq 6.5\text{ V}$		0.90		μA
I_{FB}	Feedback pin current (TPS71701)				0.02	1.0	μA
PSRR	Power-supply rejection ratio	$V_{IN} = 3.8\text{ V}$, $V_{OUT} = 2.8\text{ V}$, $I_{OUT} = 150\text{ mA}$	$f = 100\text{ Hz}$		70		dB
			$f = 1\text{ kHz}$		70		dB
			$f = 10\text{ kHz}$		67		dB
			$f = 100\text{ kHz}$		67		dB
			$f = 1\text{ MHz}$		45		dB
V_n	Output noise voltage	BW = 100 Hz to 100 kHz, $V_{IN} = 3.8\text{ V}$, $V_{OUT} = 2.8\text{ V}$, $I_{OUT} = 10\text{ mA}$	$C_{NR} = \text{none}$		$95 \times V_{OUT}$		μV_{RMS}
			$C_{NR} = 0.001\text{ }\mu\text{F}$		$25 \times V_{OUT}$		μV_{RMS}
			$C_{NR} = 0.01\text{ }\mu\text{F}$		$12.5 \times V_{OUT}$		μV_{RMS}
			$C_{NR} = 0.1\text{ }\mu\text{F}$		$11.5 \times V_{OUT}$		μV_{RMS}
t_{STR}	Startup time	$V_{OUT} = 90\%$ $V_{OUT(nom)}$, $R_L = 19\text{ }\Omega$, $C_{OUT} = 1\text{ }\mu\text{F}$	$0.9\text{ V} \leq V_{OUT} \leq 1.6\text{ V}$, $C_{NR} = 0.001\text{ }\mu\text{F}$		0.700		ms
			$1.6\text{ V} < V_{OUT} < V_{MAX}$, $C_{NR} = 0.01\text{ }\mu\text{F}$		0.160		ms
$V_{EN(high)}$	Enable high (enabled)	$V_{IN} \leq 5.5\text{ V}$		1.2		$6.5^{(4)}$	V
		$5.5\text{ V} < V_{IN} \leq 6.5\text{ V}$		1.25		6.5	V
$V_{EN(low)}$	Enable low (shutdown)			0		0.4	V
$I_{EN(high)}$	Enable pin current, enabled	$EN = 6.5\text{ V}$			0.02	1.0	μA
UVLO	Undervoltage lockout	V_{IN} rising		2.41	2.45	2.49	V
	Hysteresis	V_{IN} falling			150		mV
T_{sd}	Thermal shutdown temperature	Shutdown, temperature increasing			160		$^\circ\text{C}$
		Reset, temperature decreasing			140		$^\circ\text{C}$
T_J	Operating junction temperature			-40		125	$^\circ\text{C}$

- (1) Minimum $V_{IN} = V_{OUT} + V_{DO}$ or 2.5 V , whichever is greater.
- (2) Does not include external resistor tolerances.
- (3) V_{DO} is not measured for devices with $V_{OUT(nom)} < 2.6\text{ V}$ because the minimum V_{IN} is 2.5 V .
- (4) Maximum $V_{EN(high)} = V_{IN} + 0.3$ or 6.5 V , whichever is smaller.

6.6 Typical Characteristics

Over operating temperature range ($T_J = -40^\circ\text{C}$ to 125°C), $V_{IN} = V_{OUT(nom)} + 0.5\text{ V}$ or 2.5 V , whichever is greater; $I_{OUT} = 0.5\text{ mA}$, $V_{EN} = V_{IN}$, $C_{OUT} = 1\text{ }\mu\text{F}$, $C_{NR} = 0.01\text{ }\mu\text{F}$, unless otherwise noted. For the adjustable version (TPS71701,) $V_{OUT} = 2.8\text{ V}$. Typical values are at $T_A = 25^\circ\text{C}$.

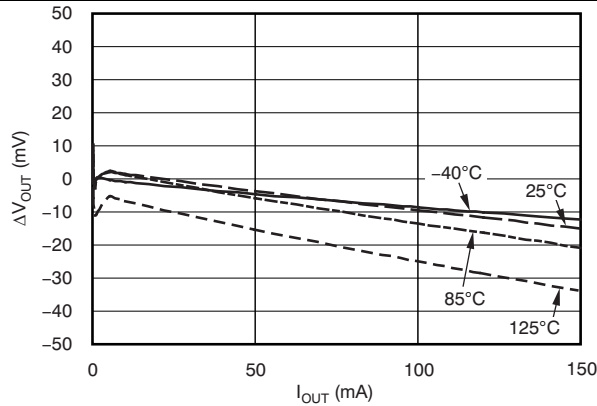

Figure 1. Load Regulation

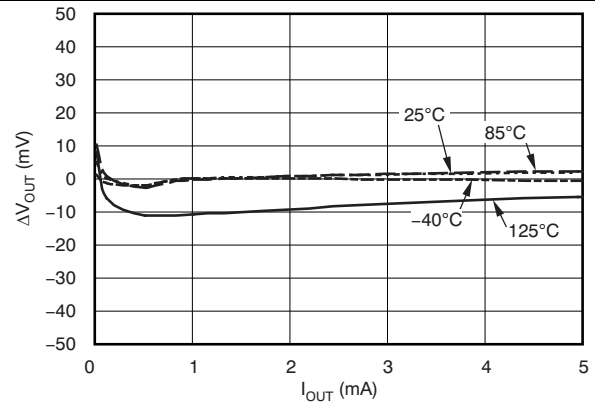

Figure 2. Load Regulation Under Light Loads

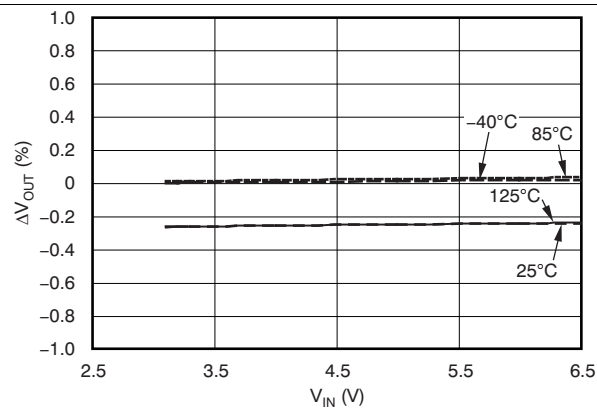

Figure 3. Line Regulation ($I_{OUT} = 5\text{ mA}$)

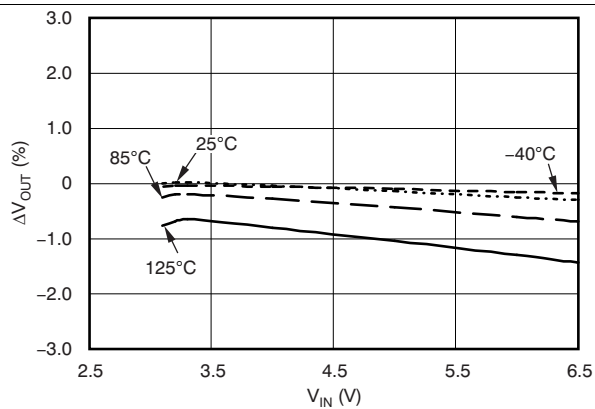

Figure 4. Line Regulation ($I_{OUT} = 150\text{ mA}$)

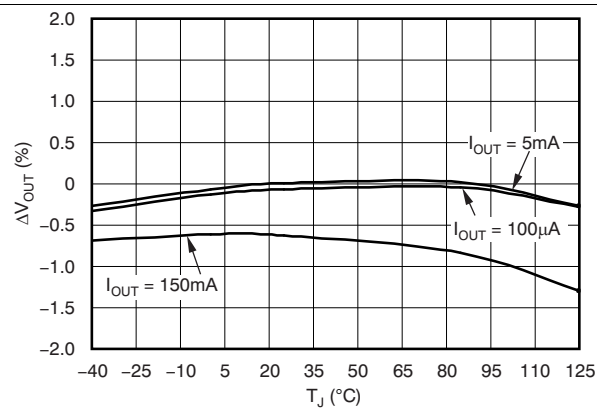

Figure 5. Output Voltage vs Temperature

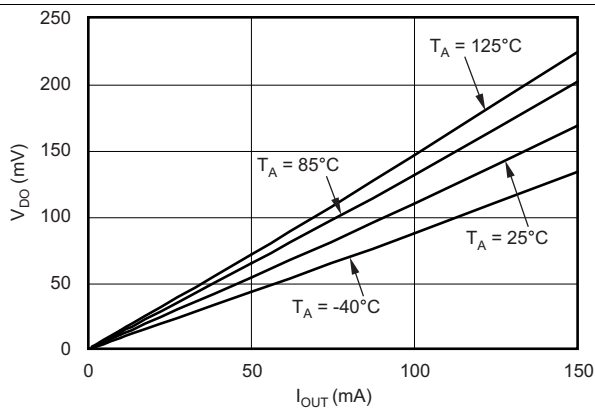

Figure 6. Dropout Voltage vs Output Current

Typical Characteristics (continued)

Over operating temperature range ($T_J = -40^{\circ}\text{C}$ to 125°C), $V_{IN} = V_{OUT(nom)} + 0.5\text{ V}$ or 2.5 V , whichever is greater; $I_{OUT} = 0.5\text{ mA}$, $V_{EN} = V_{IN}$, $C_{OUT} = 1\text{ }\mu\text{F}$, $C_{NR} = 0.01\text{ }\mu\text{F}$, unless otherwise noted. For the adjustable version (TPS71701,) $V_{OUT} = 2.8\text{ V}$. Typical values are at $T_A = 25^{\circ}\text{C}$.

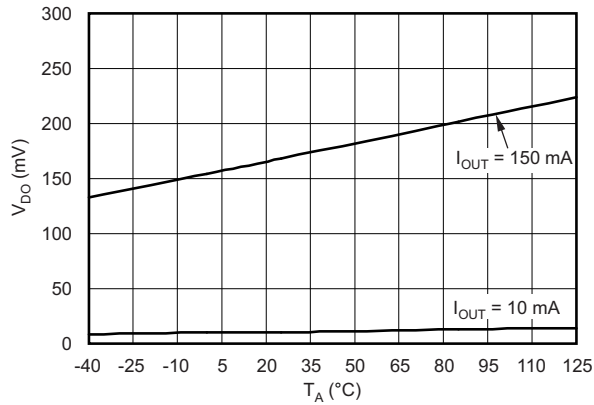

Figure 7. Dropout Voltage vs Temperature

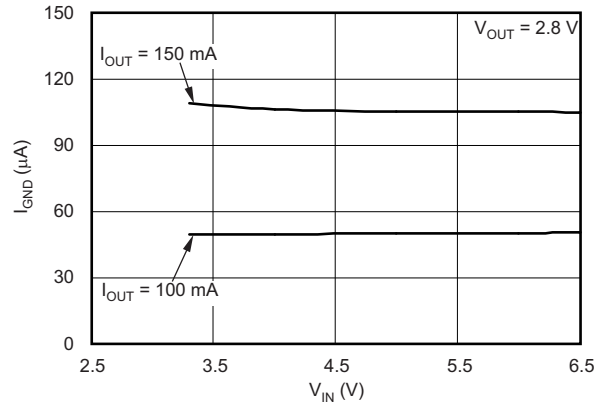

Figure 8. Ground Pin Current vs Input Voltage

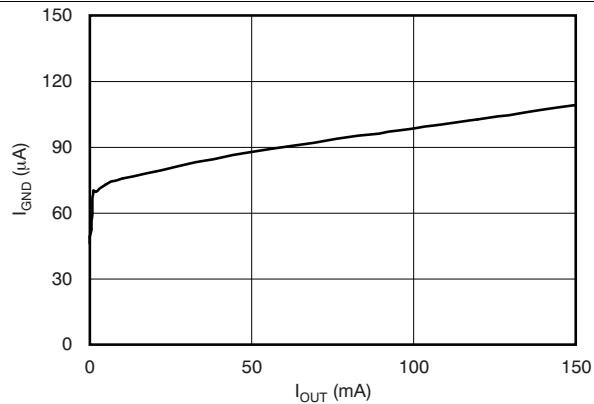

Figure 9. Ground Pin Current vs Output Current

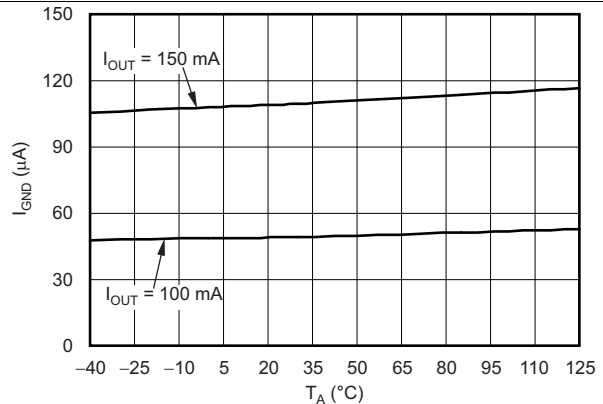

Figure 10. Ground Pin Current vs Temperature (Enabled)

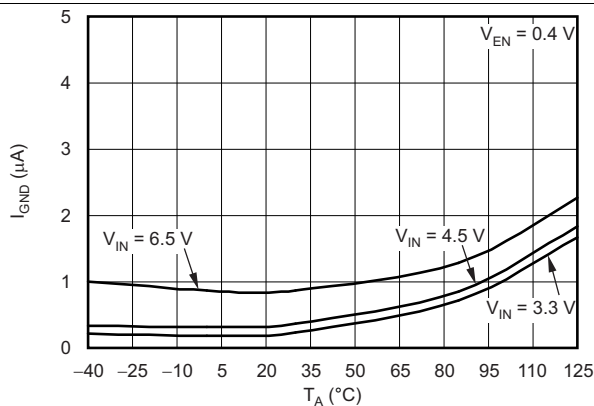

Figure 11. Ground Pin Current vs Temperature (Disabled)

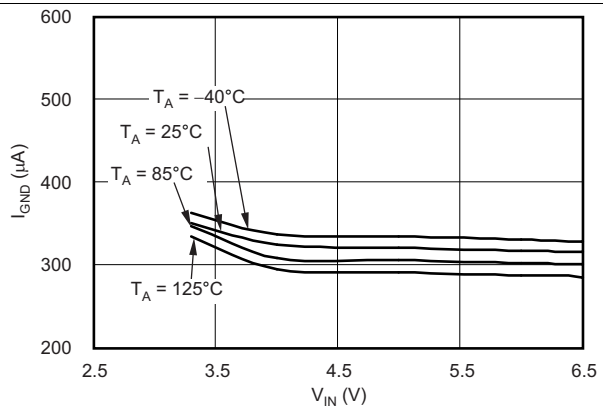

Figure 12. Current Limit vs Input Voltage

Typical Characteristics (continued)

Over operating temperature range ($T_J = -40^\circ\text{C}$ to 125°C), $V_{IN} = V_{OUT(nom)} + 0.5\text{ V}$ or 2.5 V , whichever is greater; $I_{OUT} = 0.5\text{ mA}$, $V_{EN} = V_{IN}$, $C_{OUT} = 1\text{ }\mu\text{F}$, $C_{NR} = 0.01\text{ }\mu\text{F}$, unless otherwise noted. For the adjustable version (TPS71701,) $V_{OUT} = 2.8\text{ V}$. Typical values are at $T_A = 25^\circ\text{C}$.

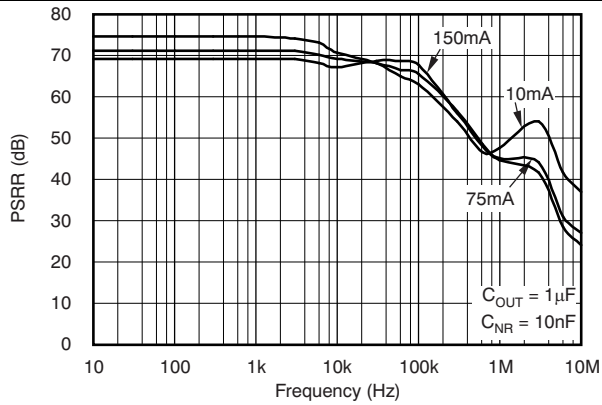

Figure 13. Power-Supply Ripple Rejection vs Frequency ($V_{IN} - V_{OUT} = 1\text{ V}$)

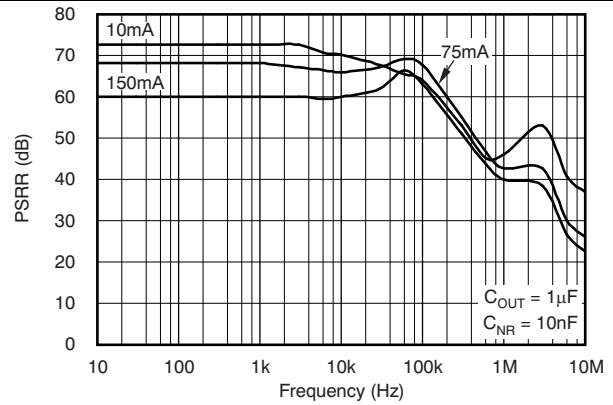

Figure 14. Power-Supply Ripple Rejection vs Frequency ($V_{IN} - V_{OUT} = 0.5\text{ V}$)

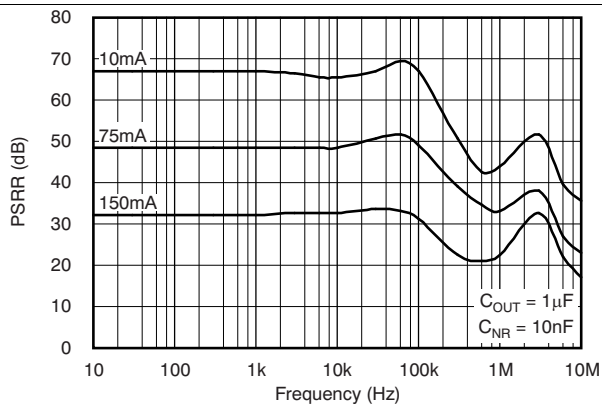

Figure 15. Power-Supply Ripple Rejection vs Frequency in Dropout Conditions ($V_{IN} - V_{OUT} = 0.25\text{ V}$)

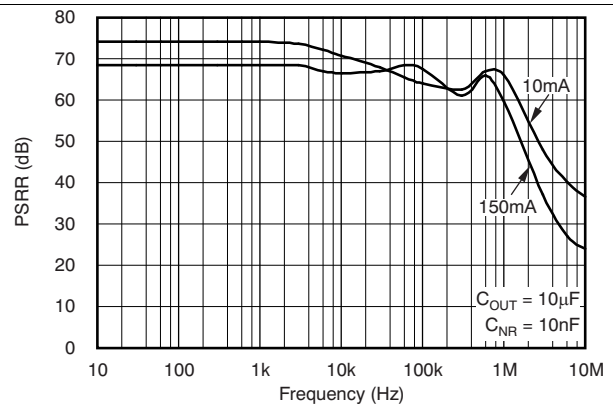

Figure 16. Power-Supply Ripple Rejection vs Frequency ($V_{IN} - V_{OUT} = 1\text{ V}$)

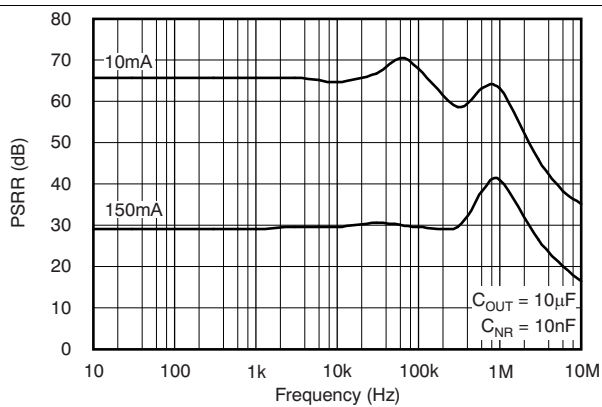

Figure 17. Power-Supply Ripple Rejection vs Frequency in Dropout Conditions ($V_{IN} - V_{OUT} = 0.25\text{ V}$)

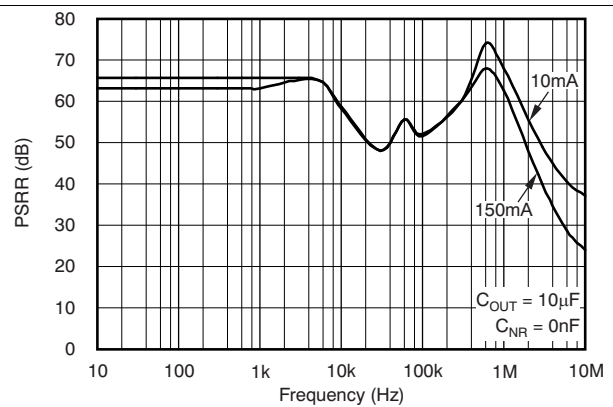

Figure 18. Power-Supply Ripple Rejection vs Frequency ($V_{IN} - V_{OUT} = 1\text{ V}$)

Typical Characteristics (continued)

Over operating temperature range ($T_J = -40^{\circ}\text{C}$ to 125°C), $V_{IN} = V_{OUT(nom)} + 0.5\text{ V}$ or 2.5 V , whichever is greater; $I_{OUT} = 0.5\text{ mA}$, $V_{EN} = V_{IN}$, $C_{OUT} = 1\text{ }\mu\text{F}$, $C_{NR} = 0.01\text{ }\mu\text{F}$, unless otherwise noted. For the adjustable version (TPS71701,) $V_{OUT} = 2.8\text{ V}$. Typical values are at $T_A = 25^{\circ}\text{C}$.

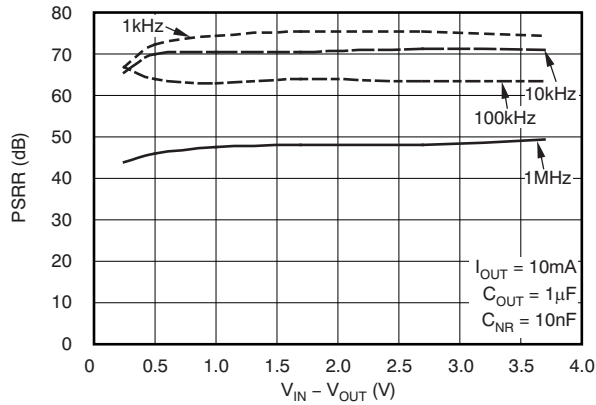

Figure 19. Power-Supply Ripple Rejection vs ($V_{IN} - V_{OUT}$)

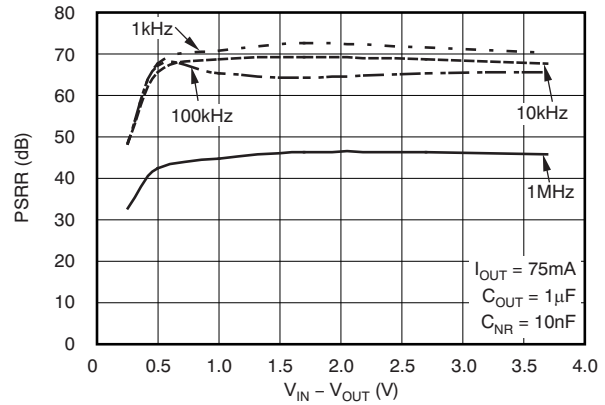

Figure 20. Power-Supply Ripple Rejection vs ($V_{IN} - V_{OUT}$)

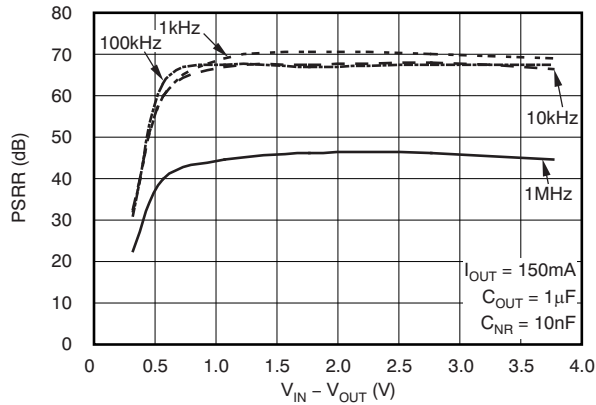

Figure 21. Power-Supply Ripple Rejection vs ($V_{IN} - V_{OUT}$)

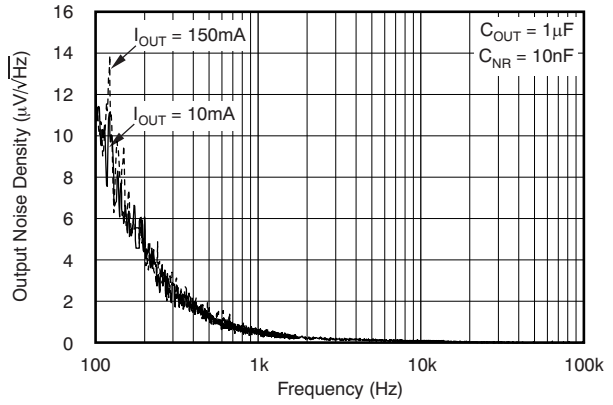

Figure 22. Output Spectral Noise Density vs Output Current

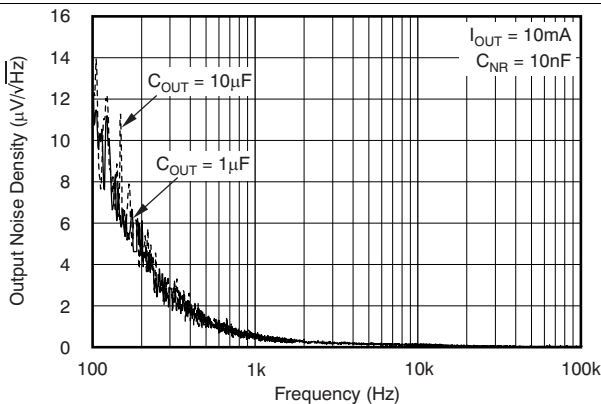

Figure 23. Output Spectral Noise Density vs Output Capacitance

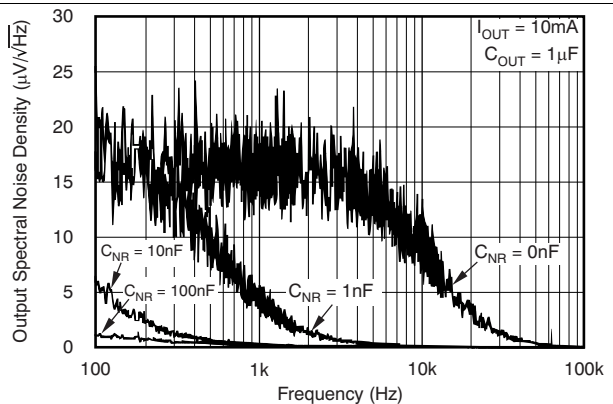

Figure 24. Output Spectral Noise Density vs Noise Reduction

Typical Characteristics (continued)

Over operating temperature range ($T_J = -40^{\circ}\text{C}$ to 125°C), $V_{IN} = V_{OUT(nom)} + 0.5\text{ V}$ or 2.5 V , whichever is greater; $I_{OUT} = 0.5\text{ mA}$, $V_{EN} = V_{IN}$, $C_{OUT} = 1\text{ }\mu\text{F}$, $C_{NR} = 0.01\text{ }\mu\text{F}$, unless otherwise noted. For the adjustable version (TPS71701,) $V_{OUT} = 2.8\text{ V}$. Typical values are at $T_A = 25^{\circ}\text{C}$.

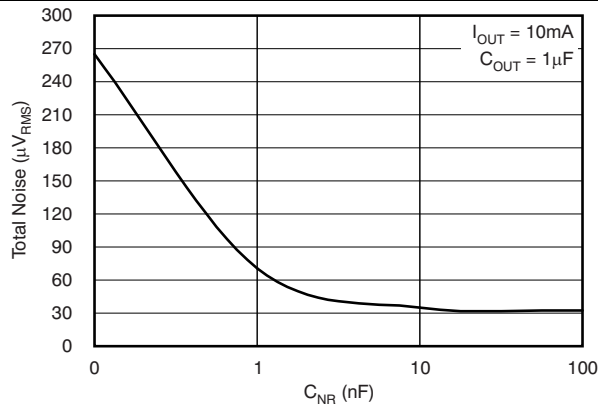

Figure 25. Total Output Noise vs Noise Reduction Capacitor

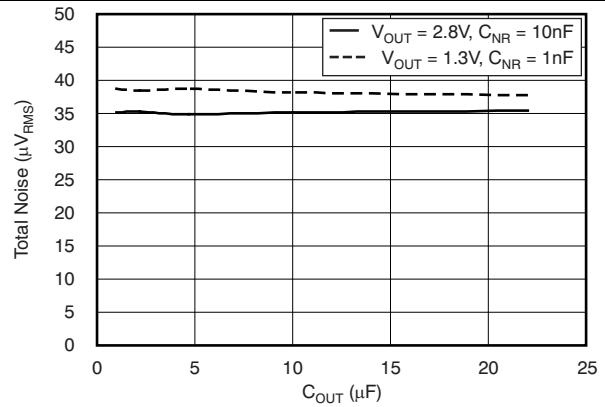

Figure 26. Total Output Noise vs Output Capacitance

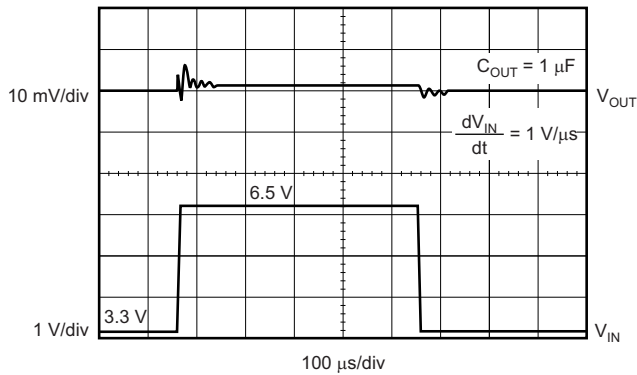

Figure 27. Line Transient Response

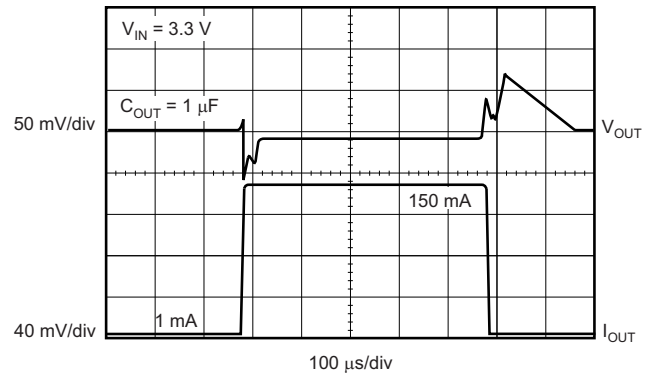

Figure 28. Load Transient Response

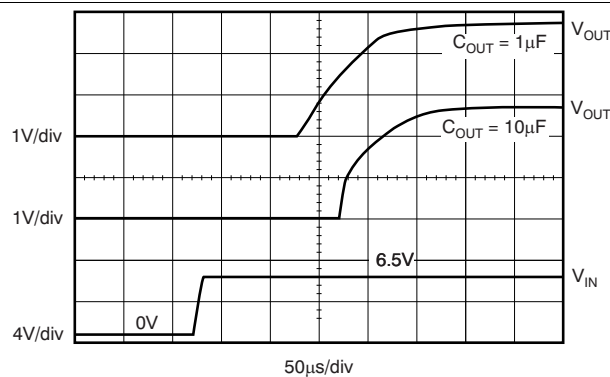

Figure 29. Turn-On Response

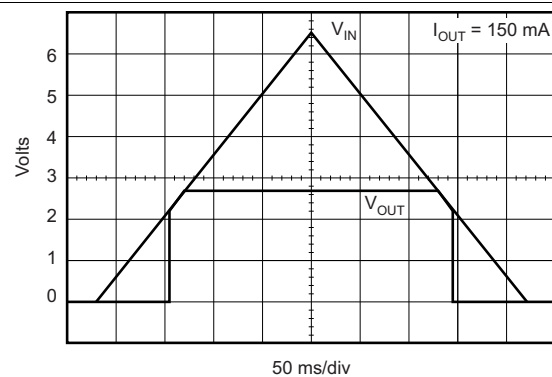

Figure 30. Power-Up and Power-Down

7 Detailed Description

7.1 Overview

The TPS717xx family of low-dropout (LDO) regulators combines the high performance required by many RF and precision analog applications with ultra-low current consumption. High PSRR is provided by a high-gain, high-bandwidth error loop with good supply rejection with very low headroom ($V_{IN} - V_{OUT}$). Fixed voltage versions provide a noise reduction pin to bypass noise generated by the band-gap reference and to improve PSRR. A quick-start circuit fast-charges this capacitor at startup. The combination of high performance and low ground current also make the TPS717xx family of devices an excellent choice for battery-powered applications. All versions have thermal and overcurrent protection.

7.2 Functional Block Diagrams

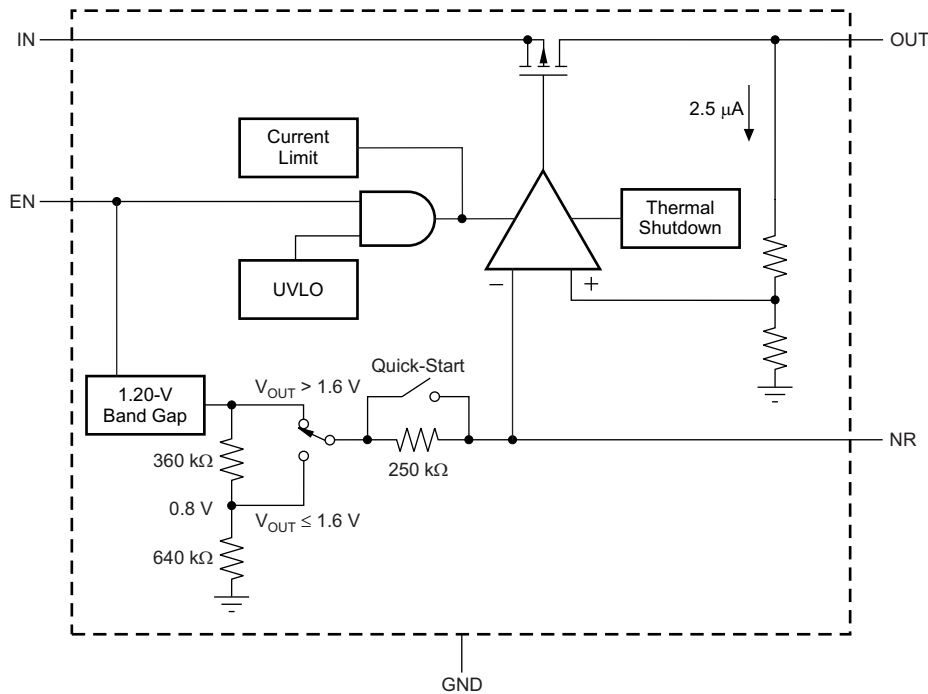
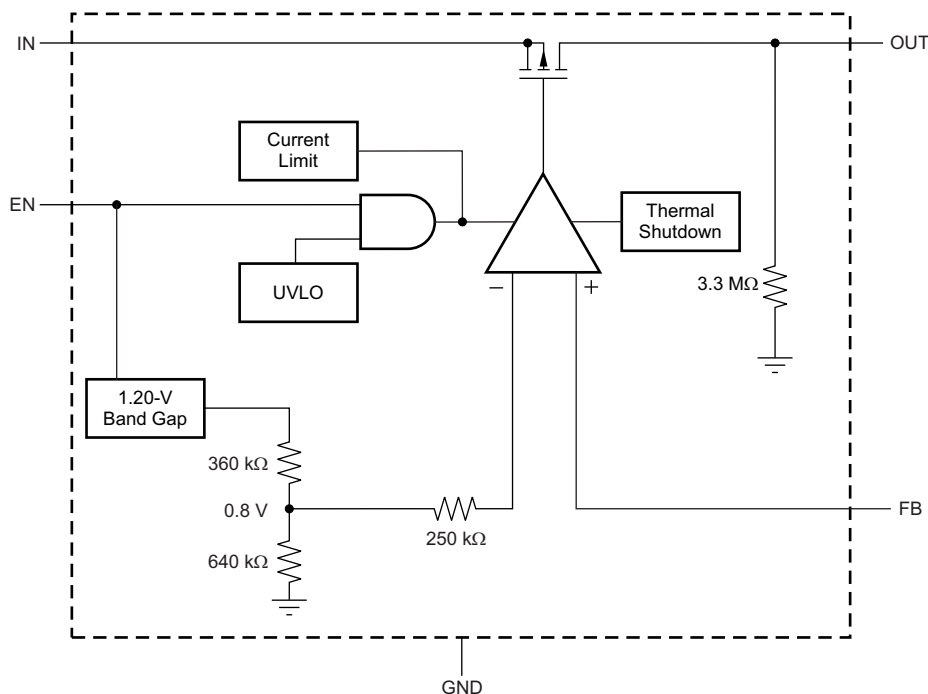

Figure 31. Fixed Voltage Versions

Functional Block Diagrams (continued)

Figure 32. Adjustable Voltage Version
7.3 Feature Description
7.3.1 Internal Current Limit

The TPS717xx internal current limit helps protect the regulator during fault conditions. During current limit, the output sources a fixed amount of current that is largely independent of output voltage. For reliable operation, do not operate the device in a current-limit state for extended periods of time.

The PMOS pass element in the TPS717xx has a built-in body diode that conducts current when the voltage at OUT exceeds the voltage at IN. This current is not limited, so if extended reverse voltage operation is anticipated, external limiting may be appropriate.

7.3.2 Shutdown

The enable pin (EN) is active high and compatible with standard and low voltage, TTL-CMOS levels. When shutdown capability is not required, EN can be connected to IN.

7.3.3 Startup and Noise Reduction Capacitor

Fixed voltage versions of the TPS717xx use a quick-start circuit to fast-charge the noise reduction capacitor, C_{NR} , if present (see [Figure 31](#)). This circuit allows the combination of very low output noise and fast start-up times. The NR pin is high impedance, so a low-leakage C_{NR} capacitor must be used; most ceramic capacitors are appropriate in this configuration.

Note that for fastest startup, apply V_{IN} first, then the enable pin (EN) driven high. If EN is tied to IN, startup is somewhat slower. Refer to [Figure 29](#) in *Typical Characteristics*. The quick-start switch is closed for approximately 135 μ s. To ensure that C_{NR} is fully charged during the quick-start time, use a 0.01- μ F or smaller capacitor.

Feature Description (continued)

For output voltages below 1.6 V, a voltage divider on the band-gap reference voltage is employed to optimize output regulation performance for lower output voltages. This configuration results in an additional resistor in the quick-start path and combined with the noise reduction capacitor (C_{NR}) results in slower start-up times for output voltages below 1.6 V.

Equation 1 approximates the start-up time as a function of C_{NR} for output voltages below 1.6 V:

$$t_{START} = 160\mu\text{s} + (540 \frac{\mu\text{s}}{\text{nF}} \times C_{NR}\text{nF})\mu\text{s} \quad (1)$$

7.3.4 Undervoltage Lockout (UVLO)

The TPS717xx uses an undervoltage lockout circuit to keep the output shut off until the internal circuitry is operating properly. The UVLO circuit has a limited glitch immunity so undershoot transients are typically ignored on the input if these transients are less than 5 μs in duration.

7.3.5 Minimum Load

The TPS717xx is stable with no output load. Traditional PMOS LDO regulators suffer from lower loop gain at very light output loads. The TPS717xx employs an innovative low-current mode circuit to increase loop gain under very light or no-load conditions, resulting in improved output voltage regulation performance down to zero output current.

7.3.6 Thermal Protection

Thermal protection disables the output when the junction temperature rises to approximately 160°C, allowing the device to cool. When the junction temperature cools to approximately 140°C the output circuitry is again enabled. Depending on power dissipation, thermal resistance, and ambient temperature, the thermal protection circuit can cycle on and off. This cycling limits the dissipation of the regulator, protecting it from damage because of overheating.

Any tendency to activate the thermal protection circuit indicates excessive power dissipation or an inadequate heatsink. For reliable operation, limit junction temperature to 125°C maximum. To estimate the margin of safety in a complete design (including heatsink), increase the ambient temperature until the thermal protection is triggered; use worst-case loads and signal conditions. For good reliability, trigger thermal protection at least 35°C above the maximum expected ambient condition of a particular application. This configuration produces a worst-case junction temperature of 125°C at the highest expected ambient temperature and worst-case load.

The internal protection circuitry of the TPS717xx is designed to protect against overload conditions. This circuitry is not intended to replace proper heatsinking. Continuously running the TPS717xx into thermal shutdown degrades device reliability.

7.4 Device Functional Modes

7.4.1 Normal Operation

The device regulates to the nominal output voltage under the following conditions:

- The input voltage has previously exceeded the UVLO rising voltage and has not decreased below the UVLO falling threshold.
- The input voltage is greater than the nominal output voltage added to the dropout voltage.
- The enable voltage has previously exceeded the enable rising threshold voltage and has not decreased below the enable falling threshold.
- The output current is less than the current limit.
- The device junction temperature is less than the maximum specified junction temperature.

Device Functional Modes (continued)

7.4.2 Dropout Operation

If the input voltage is lower than the nominal output voltage plus the specified dropout voltage, but all other conditions are met for normal operation, the device operates in dropout mode. In this condition, the output voltage is the same as the input voltage minus the dropout voltage. The transient performance of the device is significantly degraded because the pass device is in a triode state and no longer controls the current through the LDO. Line or load transients in dropout can result in large output voltage deviations.

7.4.3 Disabled

The device is disabled under the following conditions:

- The input voltage is less than the UVLO falling voltage, or has not yet exceeded the UVLO rising threshold.
- The enable voltage is less than the enable falling threshold voltage or has not yet exceeded the enable rising threshold.
- The device junction temperature is greater than the thermal shutdown temperature.

Table 1 shows the conditions that lead to the different modes of operation.

Table 1. Device Functional Mode Comparison

OPERATING MODE	PARAMETER			
	V_{IN}	V_{EN}	I_{OUT}	T_J
Normal mode	$V_{IN} > V_{OUT(nom)} + V_{DO}$ and $V_{IN} > UVLO$	$V_{EN} > V_{EN(high)}$	$I_{OUT} < I_{LIM}$	$T_J < 125^{\circ}C$
Dropout mode	$UVLO < V_{IN} < V_{OUT(nom)} + V_{DO}$	$V_{EN} > V_{EN(high)}$	—	$T_J < 125^{\circ}C$
Disabled mode (any true condition disables the device)	$V_{IN} < UVLO - V_{hys}$	$V_{EN} < V_{EN(low)}$	—	$T_J > 165^{\circ}C$

8 Application and Implementation

NOTE

Information in the following applications sections is not part of the TI component specification, and TI does not warrant its accuracy or completeness. TI's customers are responsible for determining suitability of components for their purposes. Customers should validate and test their design implementation to confirm system functionality.

8.1 Application Information

The TPS717xx belongs to a family of new generation LDO regulators that use innovative circuitry to achieve ultra-wide bandwidth and high loop gain, resulting in extremely high PSRR at very low headroom ($V_{IN} - V_{OUT}$). Fixed voltage versions provide a noise reduction pin to bypass noise generated by the band-gap reference and to improve PSRR while a quick-start circuit fast-charges this capacitor. These features, combined with low noise, enable, low ground pin current, and ultra-small packaging, make this part ideal for automotive applications. This family of regulators offers sub-band-gap output voltages, current limit, and thermal protection, and is fully specified from -40°C to 125°C .

8.1.1 Transient Response

As with any regulator, increasing the size of the output capacitor reduces overshoot or undershoot magnitude but increases duration of the transient. The TPS717xx has an ultra-wide loop bandwidth that allows it to respond quickly to load transient events. As with any regulator, the loop bandwidth is finite and the initial transient voltage peak is controlled by the sizing of the output capacitor. Typically, larger output capacitors reduce the peak while also reducing the bandwidth of the LDO, slowing the response time.

8.1.2 Input and Output Capacitor Requirements

Although an input capacitor is not required for stability, good analog design practice is to connect a $0.1\text{-}\mu\text{F}$ or larger low equivalent series resistance (ESR) capacitor from IN to GND near the regulator. This capacitor counteracts reactive input sources and improves transient response, noise rejection, and ripple rejection. A higher-value capacitor may be necessary if large, fast rise-time load transients are anticipated or if the device is located several inches from the power source. If source impedance is not sufficiently low, a $0.1\text{-}\mu\text{F}$ input capacitor may be necessary to ensure stability.

The TPS717xx is designed to be stable with ceramic output capacitors of values $1\ \mu\text{F}$ or larger. The X5R- and X7R-type capacitors are best because they have minimal variation in value and ESR over temperature. The maximum ESR of the output capacitor must be less than $1\ \Omega$.

8.1.3 Dropout Voltage

The TPS717xx uses a PMOS pass transistor to achieve low dropout. When ($V_{IN} - V_{OUT}$) is less than the dropout voltage (V_{DO}), the PMOS pass device is in its linear region of operation and the input-to-output resistance is the R_{DSon} of the PMOS pass element. V_{DO} scales approximately with output current because the PMOS device functions as a resistor in dropout.

As with any linear regulator, PSRR and transient response are degraded when ($V_{IN} - V_{OUT}$) approaches dropout. This effect is illustrated in [Figure 15](#) through [Figure 17](#) in *Typical Characteristics*.

Application Information (continued)

8.1.4 Output Noise

In most LDOs, the band gap is the dominant noise source. If a noise reduction capacitor (C_{NR}) is used with the TPS717xx, the band gap does not contribute significantly to noise. Instead, noise is dominated by the output resistor divider and the error amplifier input. To minimize noise in a given application, use a 0.01- μ F (minimum) noise reduction capacitor; for the adjustable version, smaller value resistors in the output resistor divider reduce noise. A parallel combination that gives 2.5 μ A of divider current has the same noise performance as a fixed voltage version.

Equation 2 approximates the total noise referred to the feedback point (FB pin) when $C_{NR} = 0.01 \mu\text{F}$:

$$V_N = 11.5 \frac{\mu\text{V}_{\text{RMS}}}{\text{V}} \times V_{\text{OUT}} \tag{2}$$

8.2 Typical Applications

8.2.1 Application for Fixed Voltage Versions and Adjustable Voltage Version

Figure 33 shows the basic circuit connections for the fixed voltage options. Figure 34 gives the connections for the adjustable output version (TPS71701). **Note that the NR pin is not available on the adjustable version.**

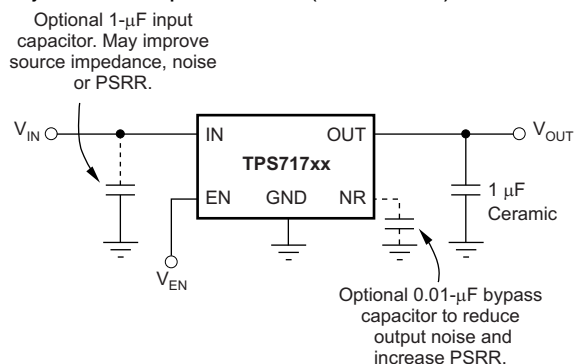

Figure 33. Typical Application Circuit (Fixed Voltage Versions)

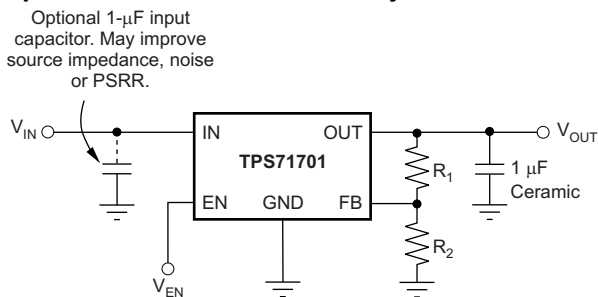

Figure 34. Typical Application Circuit (Adjustable Voltage Version)

8.2.1.1 Design Requirements

Table 2 summarizes the design requirements for Figure 36.

Table 2. Design Parameters

PARAMETER	DESIGN REQUIREMENT
Input voltage	3.3 V, $\pm 10\%$
Output voltage	2.8 V, $\pm 5\%$
Output current	100 mA typical, 150 mA peak
Output voltage transient deviation	5%
Maximum ambient temperature	85°C

8.2.1.2 Detailed Design Procedure

For the adjustable version (TPS71701), the NR pin is replaced with a feedback (FB) pin. The voltage on this pin sets the output voltage and is determined by the values of R_1 and R_2 . The values of R_1 and R_2 can be calculated for any voltage using the formula given in Equation 3:

$$R_1 = R_2 * (V_{\text{OUT}} / V_{\text{REF}} - 1) \tag{3}$$

The value of R_2 directly impacts the operation of the device and must be chosen in the range of approximately 160 k Ω to 320 k Ω . Sample resistor values for common output voltages are shown in Table 3.

Table 3. Sample 1% Resistor Values for Common Output Voltages

V _{OUT}	R ₁	R ₂
1	80.6 kΩ	324 kΩ
1.2	162 kΩ	324 kΩ
1.5	294 kΩ	332 kΩ
1.8	402 kΩ	324 kΩ
2.5	665 kΩ	316 kΩ
3.3	1.02 MΩ	324 kΩ
5	1.74 MΩ	332 kΩ

8.2.1.3 Application Curve

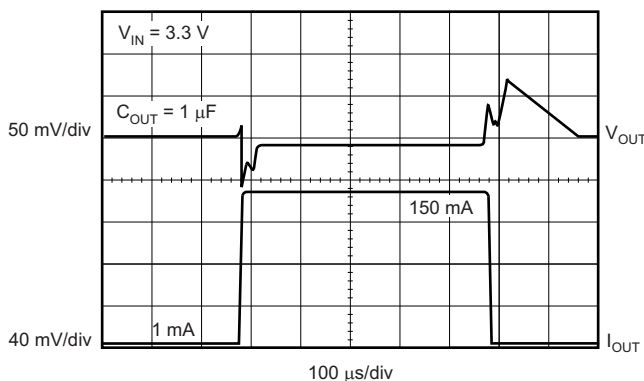

Figure 35. Load Transient Response

8.2.2 Powering a PLL Integrated on an SOC

Figure 36 shows the TPS71701 powering a phase-locked loop (PLL) that is integrated into a system-on-a-chip (SOC).

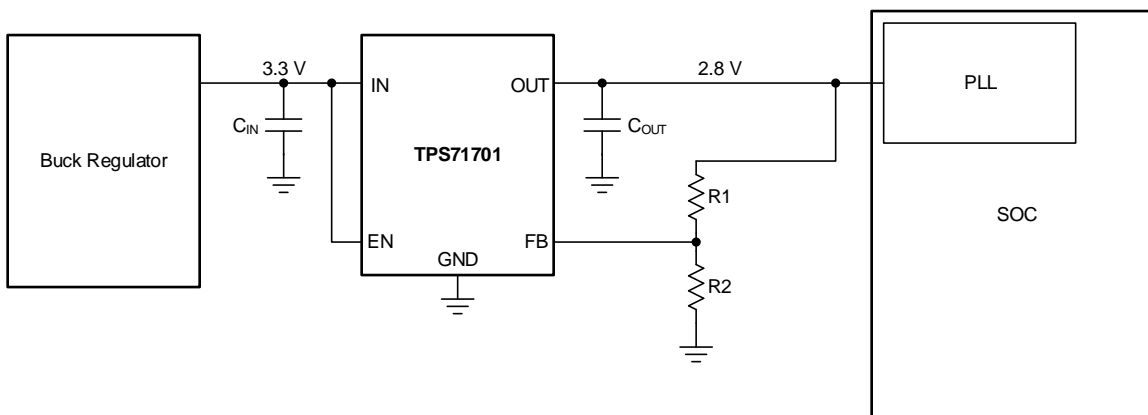

Figure 36. Typical Application Circuit: PLL on an SOC

Use the input and output capacitors to ensure the voltage transient requirements. A 1-μF input and 1-μF output capacitor are selected to maximize the capacitance and minimize capacitor size.

R₂ is chosen to be 158 kΩ for optimal noise and PSRR, and by Equation 4, R₁ is selected to be 402 kΩ. Both R₁ and R₂ must be 1% tolerance resistors to meet the dc accuracy specification over line, load, and temperature.

8.3 Do's and Don'ts

Do place at least one 1- μ F ceramic capacitor as close as possible in the range of the regulator.

Do not place the output capacitor more than 10 mm away from the regulator.

Do not place any components in the feedback loop except for the output capacitor and feedback resistors.

Do not exceed the device absolute maximum ratings.

Do not float the enable (EN) pin.

9 Power Supply Recommendations

The TPS717xx is designed to operate from an input voltage between 2.5 V and 6.5 V. The input supply must provide adequate headroom for the device to operate in a normal mode of operation.

Connect a low output impedance power supply directly to the IN pin of the TPS717xx. Inductive impedances between the input supply and the IN pin can create significant voltage excursions at the IN pin during startup or load transient events. If inductive impedances are unavoidable, use an input capacitor. To increase the overall PSRR of the power solution, use a pi-filter before the input of the LDO or after the FB network of the LDO.

10 Layout

10.1 Layout Guidelines

For best overall performance, place all circuit components on the same side of the circuit board and as near as practical to the respective LDO pin connections. Place ground return connections to the input and output capacitor, and to the LDO ground pin as close to the GND pin as possible, connected by wide, component-side, copper surface area. The use of vias and long traces to create LDO component connections is strongly discouraged and negatively affects system performance. This grounding and layout scheme minimizes inductive parasitics, and thereby reduces load-current transients, minimizes noise, and increases circuit stability. A ground reference plane is also recommended and is either embedded in the printed circuit board (PCB) itself or located on the bottom side of the PCB opposite the components. This reference plane serves to assure accuracy of the output voltage, shields the LDO from noise, and functions similar to a thermal plane to spread (or sink) heat from the LDO device when connected to the thermal pad. In most applications, this ground plane is necessary to meet thermal requirements.

10.1.1 Board Layout Recommendations to Improve PSRR and Noise Performance

To improve ac performance (such as PSRR, output noise, and transient response), TI recommends that the board be designed with separate ground planes for V_{IN} and V_{OUT} , with each ground plane connected only at the GND pin of the device. In addition, the ground connection for the bypass capacitor must connect directly to the GND pin of the device.

10.2 Layout Example

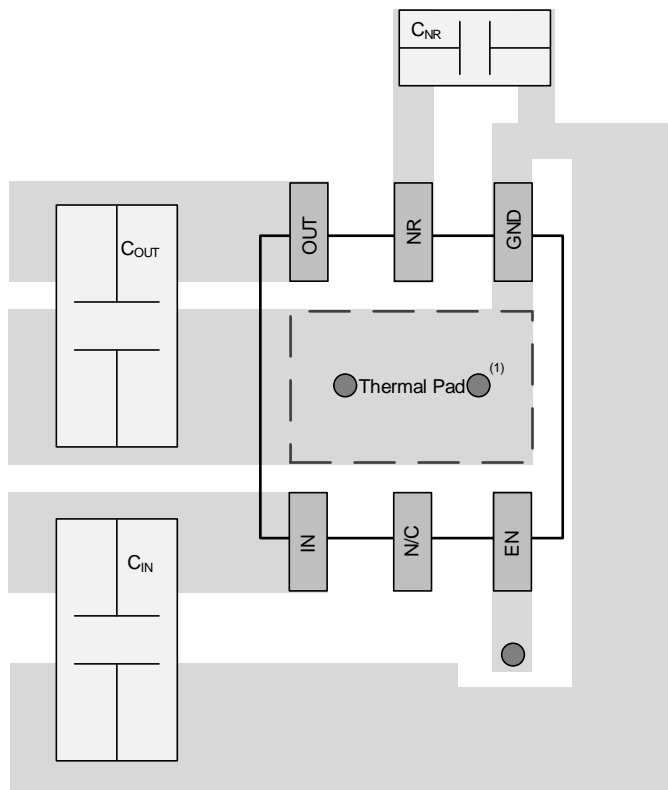

- (1) Circles within thermal pad area indicate vias to other layers on the board, for electrical connections or thermal conduction.

Figure 37. Fixed Voltage Layout

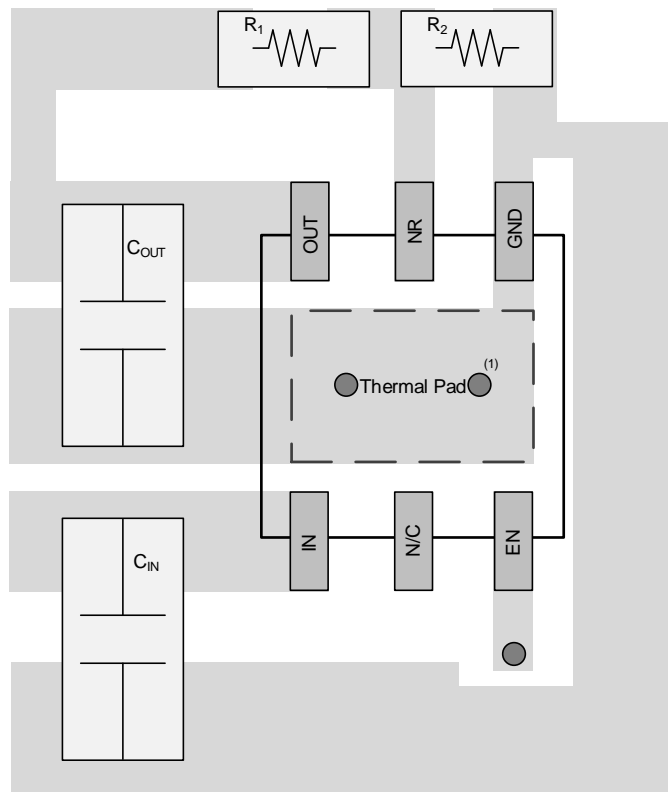
Layout Example (continued)

- (1) Circles within thermal pad area indicate vias to other layers on the board, for electrical connections or thermal conduction.

Figure 38. Adjustable Voltage Layout
10.3 Power Dissipation

The ability to remove heat from the die is different for each package type, presenting different considerations in the printed circuit board (PCB) layout. The PCB area around the device that is free of other components moves the heat from the device to the ambient air. Performance data for JEDEC low- and high-K boards are given in [Thermal Information](#). Using heavier copper increases the effectiveness in removing heat from the device. The addition of plated through-holes to heat-dissipating layers also improves the heatsink effectiveness.

Power dissipation depends on input voltage and load conditions. Power dissipation (P_D) is equal to the product of the output current times the voltage drop across the output pass element (V_{IN} to V_{OUT}), as shown in [Equation 4](#):

$$P_D = (V_{IN} - V_{OUT}) \times I_{OUT} \quad (4)$$

A better method of estimating the thermal measure comes from using the thermal metrics Ψ_{JT} and Ψ_{JB} , shown in [Thermal Information](#). These metrics are a more accurate representation of the heat transfer characteristics of the die and the package than $R_{\theta JA}$. The junction temperature can be estimated with [Equation 5](#).

$$\Psi_{JT}: T_J = T_T + \Psi_{JT} \cdot P_D$$

$$\Psi_{JB}: T_J = T_B + \Psi_{JB} \cdot P_D$$

where

- P_D is the power dissipation shown by [Equation 4](#),
 - T_T is the temperature at the center-top of the IC package,
 - T_B is the PCB temperature measured 1 mm away from the IC package *on the PCB surface*.
- (5)

Power Dissipation (接下页)

NOTE

Both T_T and T_B can be measured on actual application boards using a thermo-gun (an infrared thermometer).

For more information about measuring T_T and T_B , see the application note *Using New Thermal Metrics (SBVA025)*, available for download at www.ti.com.

11 器件和文档支持

11.1 器件支持

11.1.1 开发支持

11.1.1.1 评估模块

评估模块 (EVM) 可与 TPS717 配套使用，帮助评估初始电路性能。TPS717xxEVM-134 评估模块（和相关的用户指南）可在德州仪器 (TI) 网站上的产品文件夹中获取，也可直接从 TI 网上商店购买。

11.1.2 器件命名规则

表 4. 器件命名规则⁽¹⁾

产品	V _{OUT}
TPS717xx(x)yyyz	<p>xx(x) 为标称输出电压。对于分辨率为 100mV 的输出电压，订货编号中使用两位数字；否则，使用三位数字（例如，28 = 2.8V；125 = 1.25V）。01 表示可调电压版本。</p> <p>yyy 为封装标识符。</p> <p>z 为封装数量。R 表示卷（3000 片），T 表示带（250 片）。</p>

(1) 要获得最新的封装和订货信息，请参见本文档末尾的封装选项附录，或者访问器件产品文件夹（www.ti.com）。

11.2 文档支持

11.2.1 相关文档

《TPS717xxEVM-134 评估模块用户指南》，SLVU148

11.3 商标

Bluetooth is a registered trademark of Bluetooth SIG, Inc.
All other trademarks are the property of their respective owners.

11.4 静电放电警告



ESD 可能会损坏该集成电路。德州仪器 (TI) 建议通过适当的预防措施处理所有集成电路。如果不遵守正确的处理措施和安装程序，可能会损坏集成电路。

ESD 的损坏小至导致微小的性能降级，大至整个器件故障。精密的集成电路可能更容易受到损坏，这是因为非常细微的参数更改都可能会导致器件与其发布的规格不相符。

11.5 术语表

SLYZ022 — TI 术语表。

这份术语表列出并解释术语、首字母缩略词和定义。

12 机械封装和可订购信息

以下页中包括机械封装和可订购信息。 这些信息是针对指定器件可提供的最新数据。 这些数据会在无通知且不对本文档进行修订的情况下发生改变。 欲获得该数据表的浏览器版本，请查阅左侧的导航栏。

PACKAGING INFORMATION

Orderable part number	Status (1)	Material type (2)	Package Pins	Package qty Carrier	RoHS (3)	Lead finish/ Ball material (4)	MSL rating/ Peak reflow (5)	Op temp (°C)	Part marking (6)
TPS71701DCKR	Active	Production	SC70 (DCK) 5	3000 LARGE T&R	Yes	NIPDAU	Level-1-260C-UNLIM	-40 to 125	BMT
TPS71701DCKR.B	Active	Production	SC70 (DCK) 5	3000 LARGE T&R	Yes	NIPDAU	Level-1-260C-UNLIM	-40 to 125	BMT
TPS71701DCKR1G4	Active	Production	SC70 (DCK) 5	3000 LARGE T&R	Yes	NIPDAU	Level-1-260C-UNLIM	-40 to 125	BMT
TPS71701DCKR1G4.B	Active	Production	SC70 (DCK) 5	3000 LARGE T&R	Yes	NIPDAU	Level-1-260C-UNLIM	-40 to 125	BMT
TPS71701DCKRG4	Active	Production	SC70 (DCK) 5	3000 LARGE T&R	-	Call TI	Call TI	-40 to 125	
TPS71701DCKT	Active	Production	SC70 (DCK) 5	250 SMALL T&R	Yes	NIPDAU	Level-1-260C-UNLIM	-40 to 125	BMT
TPS71701DCKT.B	Active	Production	SC70 (DCK) 5	250 SMALL T&R	Yes	NIPDAU	Level-1-260C-UNLIM	-40 to 125	BMT
TPS71701DCKTG4	Active	Production	SC70 (DCK) 5	250 SMALL T&R	-	Call TI	Call TI	-40 to 125	
TPS71709DSER	Active	Production	WSON (DSE) 6	3000 LARGE T&R	Yes	NIPDAUAG	Level-1-260C-UNLIM	-40 to 125	FY
TPS71709DSER.B	Active	Production	WSON (DSE) 6	3000 LARGE T&R	Yes	NIPDAUAG	Level-1-260C-UNLIM	-40 to 125	FY
TPS71709DSET	Active	Production	WSON (DSE) 6	250 SMALL T&R	Yes	NIPDAUAG	Level-1-260C-UNLIM	-40 to 125	FY
TPS71709DSET.B	Active	Production	WSON (DSE) 6	250 SMALL T&R	Yes	NIPDAUAG	Level-1-260C-UNLIM	-40 to 125	FY
TPS71709DSETG4	Active	Production	WSON (DSE) 6	250 SMALL T&R	Yes	NIPDAUAG	Level-1-260C-UNLIM	-40 to 125	FY
TPS71710DCKR	Active	Production	SC70 (DCK) 5	3000 LARGE T&R	Yes	NIPDAU	Level-1-260C-UNLIM	-40 to 125	BMU
TPS71710DCKR.B	Active	Production	SC70 (DCK) 5	3000 LARGE T&R	Yes	NIPDAU	Level-1-260C-UNLIM	-40 to 125	BMU
TPS71710DCKT	Active	Production	SC70 (DCK) 5	250 SMALL T&R	Yes	NIPDAU	Level-1-260C-UNLIM	-40 to 125	BMU
TPS71710DCKT.B	Active	Production	SC70 (DCK) 5	250 SMALL T&R	Yes	NIPDAU	Level-1-260C-UNLIM	-40 to 125	BMU
TPS71710DCKT1G4	Active	Production	SC70 (DCK) 5	250 SMALL T&R	Yes	NIPDAU	Level-1-260C-UNLIM	-40 to 125	BMU
TPS71710DCKT1G4.B	Active	Production	SC70 (DCK) 5	250 SMALL T&R	Yes	NIPDAU	Level-1-260C-UNLIM	-40 to 125	BMU
TPS71710DCKTG4	Active	Production	SC70 (DCK) 5	250 SMALL T&R	-	Call TI	Call TI	-40 to 125	
TPS71710DRVR	Active	Production	WSON (DRV) 6	3000 LARGE T&R	Yes	NIPDAUAG	Level-1-260C-UNLIM	-40 to 125	BMU
TPS71710DRVR.B	Active	Production	WSON (DRV) 6	3000 LARGE T&R	Yes	NIPDAUAG	Level-1-260C-UNLIM	-40 to 125	BMU
TPS71710DRVT	Active	Production	WSON (DRV) 6	250 SMALL T&R	Yes	NIPDAUAG	Level-1-260C-UNLIM	-40 to 125	BMU
TPS71710DRVT.B	Active	Production	WSON (DRV) 6	250 SMALL T&R	Yes	NIPDAUAG	Level-1-260C-UNLIM	-40 to 125	BMU
TPS71711DCKR	Active	Production	SC70 (DCK) 5	3000 LARGE T&R	Yes	NIPDAU	Level-1-260C-UNLIM	-40 to 125	BRL
TPS71711DCKR.B	Active	Production	SC70 (DCK) 5	3000 LARGE T&R	Yes	NIPDAU	Level-1-260C-UNLIM	-40 to 125	BRL
TPS71711DCKT	Active	Production	SC70 (DCK) 5	250 SMALL T&R	Yes	NIPDAU	Level-1-260C-UNLIM	-40 to 125	BRL
TPS71711DCKT.B	Active	Production	SC70 (DCK) 5	250 SMALL T&R	Yes	NIPDAU	Level-1-260C-UNLIM	-40 to 125	BRL
TPS71711DCKTG4	Active	Production	SC70 (DCK) 5	250 SMALL T&R	-	Call TI	Call TI	-40 to 125	

Orderable part number	Status (1)	Material type (2)	Package Pins	Package qty Carrier	RoHS (3)	Lead finish/ Ball material (4)	MSL rating/ Peak reflow (5)	Op temp (°C)	Part marking (6)
TPS71712DCKR	Active	Production	SC70 (DCK) 5	3000 LARGE T&R	Yes	NIPDAU	Level-1-260C-UNLIM	-40 to 125	CKE
TPS71712DCKR.B	Active	Production	SC70 (DCK) 5	3000 LARGE T&R	Yes	NIPDAU	Level-1-260C-UNLIM	-40 to 125	CKE
TPS71712DCKR1G4	Active	Production	SC70 (DCK) 5	3000 LARGE T&R	Yes	NIPDAU	Level-1-260C-UNLIM	-40 to 125	CKE
TPS71712DCKR1G4.B	Active	Production	SC70 (DCK) 5	3000 LARGE T&R	Yes	NIPDAU	Level-1-260C-UNLIM	-40 to 125	CKE
TPS71712DCKRG4	Active	Production	SC70 (DCK) 5	3000 LARGE T&R	-	Call TI	Call TI	-40 to 125	
TPS71712DCKT	Active	Production	SC70 (DCK) 5	250 SMALL T&R	Yes	NIPDAU	Level-1-260C-UNLIM	-40 to 125	CKE
TPS71712DCKT.B	Active	Production	SC70 (DCK) 5	250 SMALL T&R	Yes	NIPDAU	Level-1-260C-UNLIM	-40 to 125	CKE
TPS71712DCKTG4	Active	Production	SC70 (DCK) 5	250 SMALL T&R	-	Call TI	Call TI	-40 to 125	
TPS71713DCKR	Active	Production	SC70 (DCK) 5	3000 LARGE T&R	Yes	NIPDAU	Level-1-260C-UNLIM	-40 to 125	BMW
TPS71713DCKR.B	Active	Production	SC70 (DCK) 5	3000 LARGE T&R	Yes	NIPDAU	Level-1-260C-UNLIM	-40 to 125	BMW
TPS71713DCKRG4	Active	Production	SC70 (DCK) 5	3000 LARGE T&R	Yes	NIPDAU	Level-1-260C-UNLIM	-40 to 125	BMW
TPS71713DCKRG4.B	Active	Production	SC70 (DCK) 5	3000 LARGE T&R	Yes	NIPDAU	Level-1-260C-UNLIM	-40 to 125	BMW
TPS71713DCKT	Active	Production	SC70 (DCK) 5	250 SMALL T&R	Yes	NIPDAU	Level-1-260C-UNLIM	-40 to 125	BMW
TPS71713DCKT.B	Active	Production	SC70 (DCK) 5	250 SMALL T&R	Yes	NIPDAU	Level-1-260C-UNLIM	-40 to 125	BMW
TPS71715DCKR	Active	Production	SC70 (DCK) 5	3000 LARGE T&R	Yes	NIPDAU	Level-1-260C-UNLIM	-40 to 125	CAA
TPS71715DCKR.B	Active	Production	SC70 (DCK) 5	3000 LARGE T&R	Yes	NIPDAU	Level-1-260C-UNLIM	-40 to 125	CAA
TPS71715DCKRG4	Active	Production	SC70 (DCK) 5	3000 LARGE T&R	Yes	NIPDAU	Level-1-260C-UNLIM	-40 to 125	CAA
TPS71715DCKRG4.B	Active	Production	SC70 (DCK) 5	3000 LARGE T&R	Yes	NIPDAU	Level-1-260C-UNLIM	-40 to 125	CAA
TPS71715DCKT	Active	Production	SC70 (DCK) 5	250 SMALL T&R	Yes	NIPDAU	Level-1-260C-UNLIM	-40 to 125	CAA
TPS71715DCKT.B	Active	Production	SC70 (DCK) 5	250 SMALL T&R	Yes	NIPDAU	Level-1-260C-UNLIM	-40 to 125	CAA
TPS71715DCKTG4	Active	Production	SC70 (DCK) 5	250 SMALL T&R	-	Call TI	Call TI	-40 to 125	
TPS717185DSER	Active	Production	WSON (DSE) 6	3000 LARGE T&R	Yes	NIPDAUAG	Level-1-260C-UNLIM	-40 to 125	KB
TPS717185DSER.B	Active	Production	WSON (DSE) 6	3000 LARGE T&R	Yes	NIPDAUAG	Level-1-260C-UNLIM	-40 to 125	KB
TPS717185DSET	Active	Production	WSON (DSE) 6	250 SMALL T&R	Yes	NIPDAUAG	Level-1-260C-UNLIM	-40 to 125	KB
TPS717185DSET.B	Active	Production	WSON (DSE) 6	250 SMALL T&R	Yes	NIPDAUAG	Level-1-260C-UNLIM	-40 to 125	KB
TPS71718DCKR	Active	Production	SC70 (DCK) 5	3000 LARGE T&R	Yes	NIPDAU	Level-1-260C-UNLIM	-40 to 125	BMX
TPS71718DCKR.B	Active	Production	SC70 (DCK) 5	3000 LARGE T&R	Yes	NIPDAU	Level-1-260C-UNLIM	-40 to 125	BMX
TPS71718DCKRG4	Active	Production	SC70 (DCK) 5	3000 LARGE T&R	-	Call TI	Call TI	-40 to 125	
TPS71718DCKT	Active	Production	SC70 (DCK) 5	250 SMALL T&R	Yes	NIPDAU	Level-1-260C-UNLIM	-40 to 125	BMX
TPS71718DCKT.B	Active	Production	SC70 (DCK) 5	250 SMALL T&R	Yes	NIPDAU	Level-1-260C-UNLIM	-40 to 125	BMX
TPS71718DCKT1G4	Active	Production	SC70 (DCK) 5	250 SMALL T&R	Yes	NIPDAU	Level-1-260C-UNLIM	-40 to 125	BMX

Orderable part number	Status (1)	Material type (2)	Package Pins	Package qty Carrier	RoHS (3)	Lead finish/ Ball material (4)	MSL rating/ Peak reflow (5)	Op temp (°C)	Part marking (6)
TPS71718DCKT1G4.B	Active	Production	SC70 (DCK) 5	250 SMALL T&R	Yes	NIPDAU	Level-1-260C-UNLIM	-40 to 125	BMX
TPS71718DCKTG4	Active	Production	SC70 (DCK) 5	250 SMALL T&R	-	Call TI	Call TI	-40 to 125	
TPS71718DSER	Active	Production	WSON (DSE) 6	3000 LARGE T&R	Yes	NIPDAUAG	Level-1-260C-UNLIM	-40 to 125	G6
TPS71718DSER.B	Active	Production	WSON (DSE) 6	3000 LARGE T&R	Yes	NIPDAUAG	Level-1-260C-UNLIM	-40 to 125	G6
TPS71718DSET	Active	Production	WSON (DSE) 6	250 SMALL T&R	Yes	NIPDAUAG	Level-1-260C-UNLIM	-40 to 125	G6
TPS71718DSET.B	Active	Production	WSON (DSE) 6	250 SMALL T&R	Yes	NIPDAUAG	Level-1-260C-UNLIM	-40 to 125	G6
TPS71719DCKR	Active	Production	SC70 (DCK) 5	3000 LARGE T&R	Yes	NIPDAU	Level-1-260C-UNLIM	-40 to 125	CCZ
TPS71719DCKR.B	Active	Production	SC70 (DCK) 5	3000 LARGE T&R	Yes	NIPDAU	Level-1-260C-UNLIM	-40 to 125	CCZ
TPS71719DCKT	Active	Production	SC70 (DCK) 5	250 SMALL T&R	Yes	NIPDAU	Level-1-260C-UNLIM	-40 to 125	CCZ
TPS71719DCKT.B	Active	Production	SC70 (DCK) 5	250 SMALL T&R	Yes	NIPDAU	Level-1-260C-UNLIM	-40 to 125	CCZ
TPS71719DCKTG4	Active	Production	SC70 (DCK) 5	250 SMALL T&R	-	Call TI	Call TI	-40 to 125	
TPS71721DCKR	Active	Production	SC70 (DCK) 5	3000 LARGE T&R	Yes	NIPDAU	Level-1-260C-UNLIM	-40 to 125	NXL
TPS71721DCKR.B	Active	Production	SC70 (DCK) 5	3000 LARGE T&R	Yes	NIPDAU	Level-1-260C-UNLIM	-40 to 125	NXL
TPS71721DCKT	Active	Production	SC70 (DCK) 5	250 SMALL T&R	Yes	NIPDAU	Level-1-260C-UNLIM	-40 to 125	NXL
TPS71721DCKT.B	Active	Production	SC70 (DCK) 5	250 SMALL T&R	Yes	NIPDAU	Level-1-260C-UNLIM	-40 to 125	NXL
TPS71725DCKR	Active	Production	SC70 (DCK) 5	3000 LARGE T&R	Yes	NIPDAU	Level-1-260C-UNLIM	-40 to 125	CAF
TPS71725DCKR.B	Active	Production	SC70 (DCK) 5	3000 LARGE T&R	Yes	NIPDAU	Level-1-260C-UNLIM	-40 to 125	CAF
TPS71725DCKR1G4	Active	Production	SC70 (DCK) 5	3000 LARGE T&R	Yes	NIPDAU	Level-1-260C-UNLIM	-40 to 125	CAF
TPS71725DCKR1G4.B	Active	Production	SC70 (DCK) 5	3000 LARGE T&R	Yes	NIPDAU	Level-1-260C-UNLIM	-40 to 125	CAF
TPS71725DCKRG4	Active	Production	SC70 (DCK) 5	3000 LARGE T&R	-	Call TI	Call TI	-40 to 125	
TPS71725DCKT	Active	Production	SC70 (DCK) 5	250 SMALL T&R	Yes	NIPDAU	Level-1-260C-UNLIM	-40 to 125	CAF
TPS71725DCKT.B	Active	Production	SC70 (DCK) 5	250 SMALL T&R	Yes	NIPDAU	Level-1-260C-UNLIM	-40 to 125	CAF
TPS71726DCKR	Active	Production	SC70 (DCK) 5	3000 LARGE T&R	Yes	NIPDAU	Level-1-260C-UNLIM	-40 to 125	BRK
TPS71726DCKR.B	Active	Production	SC70 (DCK) 5	3000 LARGE T&R	Yes	NIPDAU	Level-1-260C-UNLIM	-40 to 125	BRK
TPS71726DCKT	Active	Production	SC70 (DCK) 5	250 SMALL T&R	Yes	NIPDAU	Level-1-260C-UNLIM	-40 to 125	BRK
TPS71726DCKT.B	Active	Production	SC70 (DCK) 5	250 SMALL T&R	Yes	NIPDAU	Level-1-260C-UNLIM	-40 to 125	BRK
TPS71727DCKR	Active	Production	SC70 (DCK) 5	3000 LARGE T&R	Yes	NIPDAU	Level-1-260C-UNLIM	-40 to 125	BSC
TPS71727DCKR.B	Active	Production	SC70 (DCK) 5	3000 LARGE T&R	Yes	NIPDAU	Level-1-260C-UNLIM	-40 to 125	BSC
TPS71727DCKT	Active	Production	SC70 (DCK) 5	250 SMALL T&R	Yes	NIPDAU	Level-1-260C-UNLIM	-40 to 125	BSC
TPS71727DCKT.B	Active	Production	SC70 (DCK) 5	250 SMALL T&R	Yes	NIPDAU	Level-1-260C-UNLIM	-40 to 125	BSC
TPS71727DSER	Active	Production	WSON (DSE) 6	3000 LARGE T&R	Yes	NIPDAUAG	Level-1-260C-UNLIM	-40 to 125	KU

Orderable part number	Status (1)	Material type (2)	Package Pins	Package qty Carrier	RoHS (3)	Lead finish/ Ball material (4)	MSL rating/ Peak reflow (5)	Op temp (°C)	Part marking (6)
TPS71727DSER.B	Active	Production	WSON (DSE) 6	3000 LARGE T&R	Yes	NIPDAUAG	Level-1-260C-UNLIM	-40 to 125	KU
TPS71727DSET	Active	Production	WSON (DSE) 6	250 SMALL T&R	Yes	NIPDAUAG	Level-1-260C-UNLIM	-40 to 125	KU
TPS71727DSET.B	Active	Production	WSON (DSE) 6	250 SMALL T&R	Yes	NIPDAUAG	Level-1-260C-UNLIM	-40 to 125	KU
TPS717285DCKR	Active	Production	SC70 (DCK) 5	3000 LARGE T&R	Yes	NIPDAU	Level-1-260C-UNLIM	-40 to 125	BRJ
TPS717285DCKR.B	Active	Production	SC70 (DCK) 5	3000 LARGE T&R	Yes	NIPDAU	Level-1-260C-UNLIM	-40 to 125	BRJ
TPS717285DCKRG4	Active	Production	SC70 (DCK) 5	3000 LARGE T&R	Yes	NIPDAU	Level-1-260C-UNLIM	-40 to 125	BRJ
TPS717285DCKRG4.B	Active	Production	SC70 (DCK) 5	3000 LARGE T&R	Yes	NIPDAU	Level-1-260C-UNLIM	-40 to 125	BRJ
TPS717285DCKT	Active	Production	SC70 (DCK) 5	250 SMALL T&R	Yes	NIPDAU	Level-1-260C-UNLIM	-40 to 125	BRJ
TPS717285DCKT.B	Active	Production	SC70 (DCK) 5	250 SMALL T&R	Yes	NIPDAU	Level-1-260C-UNLIM	-40 to 125	BRJ
TPS71728DCKR	Active	Production	SC70 (DCK) 5	3000 LARGE T&R	Yes	NIPDAU	Level-1-260C-UNLIM	-40 to 125	BMZ
TPS71728DCKR.B	Active	Production	SC70 (DCK) 5	3000 LARGE T&R	Yes	NIPDAU	Level-1-260C-UNLIM	-40 to 125	BMZ
TPS71728DCKRG4	Active	Production	SC70 (DCK) 5	3000 LARGE T&R	Yes	NIPDAU	Level-1-260C-UNLIM	-40 to 125	BMZ
TPS71728DCKRG4.B	Active	Production	SC70 (DCK) 5	3000 LARGE T&R	Yes	NIPDAU	Level-1-260C-UNLIM	-40 to 125	BMZ
TPS71728DCKT	Active	Production	SC70 (DCK) 5	250 SMALL T&R	Yes	NIPDAU	Level-1-260C-UNLIM	-40 to 125	BMZ
TPS71728DCKT.B	Active	Production	SC70 (DCK) 5	250 SMALL T&R	Yes	NIPDAU	Level-1-260C-UNLIM	-40 to 125	BMZ
TPS71728DSER	Active	Production	WSON (DSE) 6	3000 LARGE T&R	Yes	NIPDAUAG	Level-1-260C-UNLIM	-40 to 125	FU
TPS71728DSER.B	Active	Production	WSON (DSE) 6	3000 LARGE T&R	Yes	NIPDAUAG	Level-1-260C-UNLIM	-40 to 125	FU
TPS71728DSET	Active	Production	WSON (DSE) 6	250 SMALL T&R	Yes	NIPDAUAG	Level-1-260C-UNLIM	-40 to 125	FU
TPS71728DSET.B	Active	Production	WSON (DSE) 6	250 SMALL T&R	Yes	NIPDAUAG	Level-1-260C-UNLIM	-40 to 125	FU
TPS71729DCKR	Active	Production	SC70 (DCK) 5	3000 LARGE T&R	Yes	NIPDAU	Level-1-260C-UNLIM	-40 to 125	CJR
TPS71729DCKR.B	Active	Production	SC70 (DCK) 5	3000 LARGE T&R	Yes	NIPDAU	Level-1-260C-UNLIM	-40 to 125	CJR
TPS71729DCKT	Active	Production	SC70 (DCK) 5	250 SMALL T&R	Yes	NIPDAU	Level-1-260C-UNLIM	-40 to 125	CJR
TPS71729DCKT.B	Active	Production	SC70 (DCK) 5	250 SMALL T&R	Yes	NIPDAU	Level-1-260C-UNLIM	-40 to 125	CJR
TPS71730DCKR	Active	Production	SC70 (DCK) 5	3000 LARGE T&R	Yes	NIPDAU	Level-1-260C-UNLIM	-40 to 125	BNA
TPS71730DCKR.B	Active	Production	SC70 (DCK) 5	3000 LARGE T&R	Yes	NIPDAU	Level-1-260C-UNLIM	-40 to 125	BNA
TPS71730DCKRG4	Active	Production	SC70 (DCK) 5	3000 LARGE T&R	Yes	NIPDAU	Level-1-260C-UNLIM	-40 to 125	BNA
TPS71730DCKRG4.B	Active	Production	SC70 (DCK) 5	3000 LARGE T&R	Yes	NIPDAU	Level-1-260C-UNLIM	-40 to 125	BNA
TPS71730DCKT	Active	Production	SC70 (DCK) 5	250 SMALL T&R	Yes	NIPDAU	Level-1-260C-UNLIM	-40 to 125	BNA
TPS71730DCKT.B	Active	Production	SC70 (DCK) 5	250 SMALL T&R	Yes	NIPDAU	Level-1-260C-UNLIM	-40 to 125	BNA
TPS71730DCKTG4	Active	Production	SC70 (DCK) 5	250 SMALL T&R	-	Call TI	Call TI	-40 to 125	
TPS71733DCKR	Active	Production	SC70 (DCK) 5	3000 LARGE T&R	Yes	NIPDAU	Level-1-260C-UNLIM	-40 to 125	BNB

Orderable part number	Status (1)	Material type (2)	Package Pins	Package qty Carrier	RoHS (3)	Lead finish/ Ball material (4)	MSL rating/ Peak reflow (5)	Op temp (°C)	Part marking (6)
TPS71733DCKR.B	Active	Production	SC70 (DCK) 5	3000 LARGE T&R	Yes	NIPDAU	Level-1-260C-UNLIM	-40 to 125	BNB
TPS71733DCKR1G4	Active	Production	SC70 (DCK) 5	3000 LARGE T&R	Yes	NIPDAU	Level-1-260C-UNLIM	-40 to 125	BNB
TPS71733DCKR1G4.B	Active	Production	SC70 (DCK) 5	3000 LARGE T&R	Yes	NIPDAU	Level-1-260C-UNLIM	-40 to 125	BNB
TPS71733DCKRG4	Active	Production	SC70 (DCK) 5	3000 LARGE T&R	-	Call TI	Call TI	-40 to 125	
TPS71733DCKT	Active	Production	SC70 (DCK) 5	250 SMALL T&R	Yes	NIPDAU	Level-1-260C-UNLIM	-40 to 125	BNB
TPS71733DCKT.B	Active	Production	SC70 (DCK) 5	250 SMALL T&R	Yes	NIPDAU	Level-1-260C-UNLIM	-40 to 125	BNB
TPS71733DCKTG4	Active	Production	SC70 (DCK) 5	250 SMALL T&R	-	Call TI	Call TI	-40 to 125	
TPS71733DRVR	Active	Production	WSON (DRV) 6	3000 LARGE T&R	Yes	NIPDAU	Level-1-260C-UNLIM	-40 to 125	BNB
TPS71733DRVR.B	Active	Production	WSON (DRV) 6	3000 LARGE T&R	Yes	NIPDAU	Level-1-260C-UNLIM	-40 to 125	BNB
TPS71733DRVRG4	Active	Production	WSON (DRV) 6	3000 LARGE T&R	Yes	NIPDAU	Level-1-260C-UNLIM	-40 to 125	BNB
TPS71733DRVT	Active	Production	WSON (DRV) 6	250 SMALL T&R	Yes	NIPDAUAG	Level-1-260C-UNLIM	-40 to 125	BNB
TPS71733DRVT.B	Active	Production	WSON (DRV) 6	250 SMALL T&R	Yes	NIPDAUAG	Level-1-260C-UNLIM	-40 to 125	BNB
TPS71733DSER	Active	Production	WSON (DSE) 6	3000 LARGE T&R	Yes	NIPDAUAG	Level-1-260C-UNLIM	-40 to 125	FV
TPS71733DSER.B	Active	Production	WSON (DSE) 6	3000 LARGE T&R	Yes	NIPDAUAG	Level-1-260C-UNLIM	-40 to 125	FV
TPS71733DSET	Active	Production	WSON (DSE) 6	250 SMALL T&R	Yes	NIPDAUAG	Level-1-260C-UNLIM	-40 to 125	FV
TPS71733DSET.B	Active	Production	WSON (DSE) 6	250 SMALL T&R	Yes	NIPDAUAG	Level-1-260C-UNLIM	-40 to 125	FV
TPS71745DSER	Active	Production	WSON (DSE) 6	3000 LARGE T&R	Yes	NIPDAU	Level-1-260C-UNLIM	-40 to 125	GL
TPS71745DSER.B	Active	Production	WSON (DSE) 6	3000 LARGE T&R	Yes	NIPDAU	Level-1-260C-UNLIM	-40 to 125	GL
TPS71745DSET	Active	Production	WSON (DSE) 6	250 SMALL T&R	Yes	NIPDAU	Level-1-260C-UNLIM	-40 to 125	GL
TPS71745DSET.B	Active	Production	WSON (DSE) 6	250 SMALL T&R	Yes	NIPDAU	Level-1-260C-UNLIM	-40 to 125	GL
TPS71750DSER	Active	Production	WSON (DSE) 6	3000 LARGE T&R	Yes	NIPDAUAG	Level-1-260C-UNLIM	-40 to 125	PD
TPS71750DSER.B	Active	Production	WSON (DSE) 6	3000 LARGE T&R	Yes	NIPDAUAG	Level-1-260C-UNLIM	-40 to 125	PD
TPS71750DSET	Active	Production	WSON (DSE) 6	250 SMALL T&R	Yes	NIPDAUAG	Level-1-260C-UNLIM	-40 to 125	PD
TPS71750DSET.B	Active	Production	WSON (DSE) 6	250 SMALL T&R	Yes	NIPDAUAG	Level-1-260C-UNLIM	-40 to 125	PD

⁽¹⁾ **Status:** For more details on status, see our [product life cycle](#).

⁽²⁾ **Material type:** When designated, preproduction parts are prototypes/experimental devices, and are not yet approved or released for full production. Testing and final process, including without limitation quality assurance, reliability performance testing, and/or process qualification, may not yet be complete, and this item is subject to further changes or possible discontinuation. If available for ordering, purchases will be subject to an additional waiver at checkout, and are intended for early internal evaluation purposes only. These items are sold without warranties of any kind.

⁽³⁾ **RoHS values:** Yes, No, RoHS Exempt. See the [TI RoHS Statement](#) for additional information and value definition.

(4) **Lead finish/Ball material:** Parts may have multiple material finish options. Finish options are separated by a vertical ruled line. Lead finish/Ball material values may wrap to two lines if the finish value exceeds the maximum column width.

(5) **MSL rating/Peak reflow:** The moisture sensitivity level ratings and peak solder (reflow) temperatures. In the event that a part has multiple moisture sensitivity ratings, only the lowest level per JEDEC standards is shown. Refer to the shipping label for the actual reflow temperature that will be used to mount the part to the printed circuit board.

(6) **Part marking:** There may be an additional marking, which relates to the logo, the lot trace code information, or the environmental category of the part.

Multiple part markings will be inside parentheses. Only one part marking contained in parentheses and separated by a "~" will appear on a part. If a line is indented then it is a continuation of the previous line and the two combined represent the entire part marking for that device.

Important Information and Disclaimer: The information provided on this page represents TI's knowledge and belief as of the date that it is provided. TI bases its knowledge and belief on information provided by third parties, and makes no representation or warranty as to the accuracy of such information. Efforts are underway to better integrate information from third parties. TI has taken and continues to take reasonable steps to provide representative and accurate information but may not have conducted destructive testing or chemical analysis on incoming materials and chemicals. TI and TI suppliers consider certain information to be proprietary, and thus CAS numbers and other limited information may not be available for release.

In no event shall TI's liability arising out of such information exceed the total purchase price of the TI part(s) at issue in this document sold by TI to Customer on an annual basis.

OTHER QUALIFIED VERSIONS OF TPS717 :

- Automotive : [TPS717-Q1](#)

NOTE: Qualified Version Definitions:

- Automotive - Q100 devices qualified for high-reliability automotive applications targeting zero defects

TAPE AND REEL INFORMATION

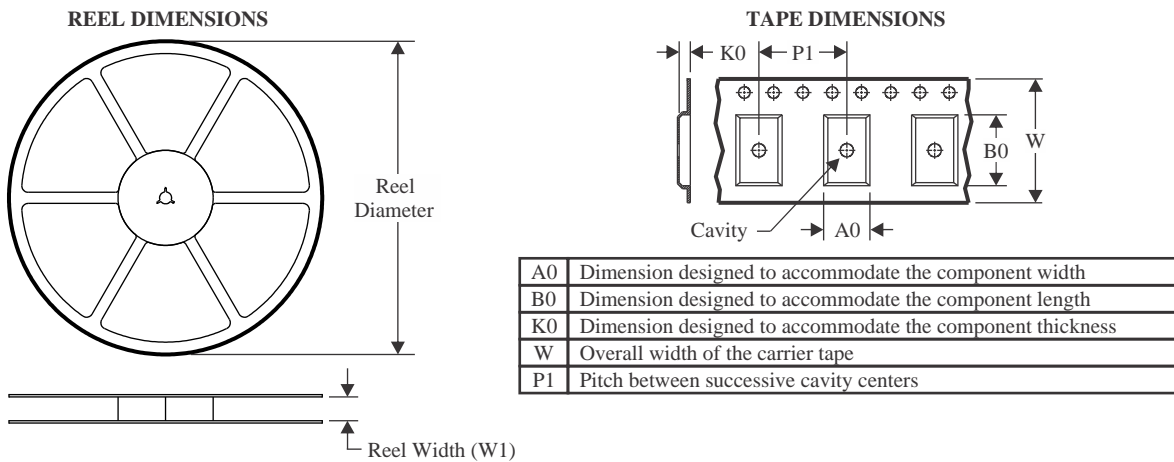

QUADRANT ASSIGNMENTS FOR PIN 1 ORIENTATION IN TAPE



*All dimensions are nominal

Device	Package Type	Package Drawing	Pins	SPQ	Reel Diameter (mm)	Reel Width W1 (mm)	A0 (mm)	B0 (mm)	K0 (mm)	P1 (mm)	W (mm)	Pin1 Quadrant
TPS71701DCKR	SC70	DCK	5	3000	178.0	9.0	2.4	2.5	1.2	4.0	8.0	Q3
TPS71701DCKR	SC70	DCK	5	3000	179.0	8.4	2.25	2.4	1.22	4.0	8.0	Q3
TPS71701DCKR1G4	SC70	DCK	5	3000	178.0	9.0	2.4	2.5	1.2	4.0	8.0	Q3
TPS71701DCKT	SC70	DCK	5	250	178.0	9.0	2.4	2.5	1.2	4.0	8.0	Q3
TPS71709DSE	WSON	DSE	6	3000	179.0	8.4	1.8	1.8	1.0	4.0	8.0	Q2
TPS71709DSET	WSON	DSE	6	250	179.0	8.4	1.8	1.8	1.0	4.0	8.0	Q2
TPS71710DCKR	SC70	DCK	5	3000	179.0	8.4	2.25	2.4	1.22	4.0	8.0	Q3
TPS71710DCKR	SC70	DCK	5	3000	178.0	9.0	2.4	2.5	1.2	4.0	8.0	Q3
TPS71710DCKT	SC70	DCK	5	250	179.0	8.4	2.25	2.4	1.22	4.0	8.0	Q3
TPS71710DCKT	SC70	DCK	5	250	178.0	9.0	2.4	2.5	1.2	4.0	8.0	Q3
TPS71710DCKT1G4	SC70	DCK	5	250	178.0	9.0	2.4	2.5	1.2	4.0	8.0	Q3
TPS71710DRV	WSON	DRV	6	3000	179.0	8.4	2.2	2.2	1.2	4.0	8.0	Q2
TPS71710DRV	WSON	DRV	6	250	179.0	8.4	2.2	2.2	1.2	4.0	8.0	Q2
TPS71711DCKR	SC70	DCK	5	3000	179.0	8.4	2.25	2.4	1.22	4.0	8.0	Q3
TPS71711DCKR	SC70	DCK	5	3000	178.0	9.0	2.4	2.5	1.2	4.0	8.0	Q3
TPS71711DCKT	SC70	DCK	5	250	178.0	9.0	2.4	2.5	1.2	4.0	8.0	Q3

Device	Package Type	Package Drawing	Pins	SPQ	Reel Diameter (mm)	Reel Width W1 (mm)	A0 (mm)	B0 (mm)	K0 (mm)	P1 (mm)	W (mm)	Pin1 Quadrant
TPS71711DCKT	SC70	DCK	5	250	179.0	8.4	2.25	2.4	1.22	4.0	8.0	Q3
TPS71712DCKR	SC70	DCK	5	3000	178.0	9.0	2.4	2.5	1.2	4.0	8.0	Q3
TPS71712DCKR	SC70	DCK	5	3000	179.0	8.4	2.25	2.4	1.22	4.0	8.0	Q3
TPS71712DCKR1G4	SC70	DCK	5	3000	178.0	9.0	2.4	2.5	1.2	4.0	8.0	Q3
TPS71712DCKT	SC70	DCK	5	250	178.0	9.0	2.4	2.5	1.2	4.0	8.0	Q3
TPS71712DCKT	SC70	DCK	5	250	179.0	8.4	2.25	2.4	1.22	4.0	8.0	Q3
TPS71713DCKR	SC70	DCK	5	3000	179.0	8.4	2.25	2.4	1.22	4.0	8.0	Q3
TPS71713DCKR	SC70	DCK	5	3000	178.0	9.0	2.4	2.5	1.2	4.0	8.0	Q3
TPS71713DCKRG4	SC70	DCK	5	3000	178.0	9.0	2.4	2.5	1.2	4.0	8.0	Q3
TPS71713DCKT	SC70	DCK	5	250	178.0	9.0	2.4	2.5	1.2	4.0	8.0	Q3
TPS71715DCKR	SC70	DCK	5	3000	179.0	8.4	2.2	2.5	1.2	4.0	8.0	Q3
TPS71715DCKR	SC70	DCK	5	3000	178.0	9.0	2.4	2.5	1.2	4.0	8.0	Q3
TPS71715DCKRG4	SC70	DCK	5	3000	178.0	9.0	2.4	2.5	1.2	4.0	8.0	Q3
TPS71715DCKT	SC70	DCK	5	250	178.0	9.0	2.4	2.5	1.2	4.0	8.0	Q3
TPS71715DCKT	SC70	DCK	5	250	179.0	8.4	2.2	2.5	1.2	4.0	8.0	Q3
TPS717185DSER	WS0N	DSE	6	3000	179.0	8.4	1.8	1.8	1.0	4.0	8.0	Q2
TPS717185DSET	WS0N	DSE	6	250	179.0	8.4	1.8	1.8	1.0	4.0	8.0	Q2
TPS71718DCKR	SC70	DCK	5	3000	178.0	9.0	2.4	2.5	1.2	4.0	8.0	Q3
TPS71718DCKR	SC70	DCK	5	3000	179.0	8.4	2.2	2.5	1.2	4.0	8.0	Q3
TPS71718DCKT	SC70	DCK	5	250	178.0	9.0	2.4	2.5	1.2	4.0	8.0	Q3
TPS71718DCKT1G4	SC70	DCK	5	250	178.0	9.0	2.4	2.5	1.2	4.0	8.0	Q3
TPS71718DSER	WS0N	DSE	6	3000	179.0	8.4	1.8	1.8	1.0	4.0	8.0	Q2
TPS71718DSET	WS0N	DSE	6	250	179.0	8.4	1.8	1.8	1.0	4.0	8.0	Q2
TPS71719DCKR	SC70	DCK	5	3000	179.0	8.4	2.25	2.4	1.22	4.0	8.0	Q3
TPS71719DCKR	SC70	DCK	5	3000	178.0	9.0	2.4	2.5	1.2	4.0	8.0	Q3
TPS71719DCKT	SC70	DCK	5	250	178.0	9.0	2.4	2.5	1.2	4.0	8.0	Q3
TPS71719DCKT	SC70	DCK	5	250	179.0	8.4	2.25	2.4	1.22	4.0	8.0	Q3
TPS71721DCKR	SC70	DCK	5	3000	178.0	9.0	2.4	2.5	1.2	4.0	8.0	Q3
TPS71721DCKR	SC70	DCK	5	3000	179.0	8.4	2.2	2.5	1.2	4.0	8.0	Q3
TPS71721DCKT	SC70	DCK	5	250	178.0	9.0	2.4	2.5	1.2	4.0	8.0	Q3
TPS71721DCKT	SC70	DCK	5	250	179.0	8.4	2.2	2.5	1.2	4.0	8.0	Q3
TPS71725DCKR	SC70	DCK	5	3000	178.0	9.0	2.4	2.5	1.2	4.0	8.0	Q3
TPS71725DCKR	SC70	DCK	5	3000	179.0	8.4	2.2	2.5	1.2	4.0	8.0	Q3
TPS71725DCKR1G4	SC70	DCK	5	3000	178.0	9.0	2.4	2.5	1.2	4.0	8.0	Q3
TPS71725DCKT	SC70	DCK	5	250	178.0	9.0	2.4	2.5	1.2	4.0	8.0	Q3
TPS71725DCKT	SC70	DCK	5	250	179.0	8.4	2.2	2.5	1.2	4.0	8.0	Q3
TPS71726DCKR	SC70	DCK	5	3000	178.0	9.0	2.4	2.5	1.2	4.0	8.0	Q3
TPS71726DCKR	SC70	DCK	5	3000	179.0	8.4	2.25	2.4	1.22	4.0	8.0	Q3
TPS71726DCKT	SC70	DCK	5	250	178.0	9.0	2.4	2.5	1.2	4.0	8.0	Q3
TPS71726DCKT	SC70	DCK	5	250	179.0	8.4	2.25	2.4	1.22	4.0	8.0	Q3
TPS71727DCKR	SC70	DCK	5	3000	179.0	8.4	2.25	2.4	1.22	4.0	8.0	Q3

Device	Package Type	Package Drawing	Pins	SPQ	Reel Diameter (mm)	Reel Width W1 (mm)	A0 (mm)	B0 (mm)	K0 (mm)	P1 (mm)	W (mm)	Pin1 Quadrant
TPS71727DCKR	SC70	DCK	5	3000	178.0	9.0	2.4	2.5	1.2	4.0	8.0	Q3
TPS71727DCKT	SC70	DCK	5	250	178.0	9.0	2.4	2.5	1.2	4.0	8.0	Q3
TPS71727DCKT	SC70	DCK	5	250	179.0	8.4	2.25	2.4	1.22	4.0	8.0	Q3
TPS71727DSER	WSON	DSE	6	3000	179.0	8.4	1.8	1.8	1.0	4.0	8.0	Q2
TPS71727DSET	WSON	DSE	6	250	179.0	8.4	1.8	1.8	1.0	4.0	8.0	Q2
TPS717285DCKR	SC70	DCK	5	3000	178.0	9.0	2.4	2.5	1.2	4.0	8.0	Q3
TPS717285DCKR	SC70	DCK	5	3000	179.0	8.4	2.25	2.4	1.22	4.0	8.0	Q3
TPS717285DCKRG4	SC70	DCK	5	3000	178.0	9.0	2.4	2.5	1.2	4.0	8.0	Q3
TPS717285DCKT	SC70	DCK	5	250	178.0	9.0	2.4	2.5	1.2	4.0	8.0	Q3
TPS717285DCKT	SC70	DCK	5	250	179.0	8.4	2.25	2.4	1.22	4.0	8.0	Q3
TPS71728DCKR	SC70	DCK	5	3000	179.0	8.4	2.2	2.5	1.2	4.0	8.0	Q3
TPS71728DCKR	SC70	DCK	5	3000	178.0	9.0	2.4	2.5	1.2	4.0	8.0	Q3
TPS71728DCKRG4	SC70	DCK	5	3000	178.0	9.0	2.4	2.5	1.2	4.0	8.0	Q3
TPS71728DCKT	SC70	DCK	5	250	178.0	9.0	2.4	2.5	1.2	4.0	8.0	Q3
TPS71728DSER	WSON	DSE	6	3000	179.0	8.4	1.8	1.8	1.0	4.0	8.0	Q2
TPS71728DSET	WSON	DSE	6	250	179.0	8.4	1.8	1.8	1.0	4.0	8.0	Q2
TPS71729DCKR	SC70	DCK	5	3000	178.0	9.0	2.4	2.5	1.2	4.0	8.0	Q3
TPS71729DCKR	SC70	DCK	5	3000	179.0	8.4	2.25	2.4	1.22	4.0	8.0	Q3
TPS71729DCKT	SC70	DCK	5	250	178.0	9.0	2.4	2.5	1.2	4.0	8.0	Q3
TPS71729DCKT	SC70	DCK	5	250	179.0	8.4	2.25	2.4	1.22	4.0	8.0	Q3
TPS71730DCKR	SC70	DCK	5	3000	178.0	9.0	2.4	2.5	1.2	4.0	8.0	Q3
TPS71730DCKR	SC70	DCK	5	3000	179.0	8.4	2.25	2.4	1.22	4.0	8.0	Q3
TPS71730DCKRG4	SC70	DCK	5	3000	178.0	9.0	2.4	2.5	1.2	4.0	8.0	Q3
TPS71730DCKT	SC70	DCK	5	250	178.0	9.0	2.4	2.5	1.2	4.0	8.0	Q3
TPS71733DCKR	SC70	DCK	5	3000	179.0	8.4	2.2	2.5	1.2	4.0	8.0	Q3
TPS71733DCKR	SC70	DCK	5	3000	178.0	9.0	2.4	2.5	1.2	4.0	8.0	Q3
TPS71733DCKR1G4	SC70	DCK	5	3000	178.0	9.0	2.4	2.5	1.2	4.0	8.0	Q3
TPS71733DCKT	SC70	DCK	5	250	178.0	9.0	2.4	2.5	1.2	4.0	8.0	Q3
TPS71733DCKT	SC70	DCK	5	250	179.0	8.4	2.25	2.4	1.22	4.0	8.0	Q3
TPS71733DRVR	WSON	DRV	6	3000	179.0	8.4	2.2	2.2	1.2	4.0	8.0	Q2
TPS71733DRVT	WSON	DRV	6	250	179.0	8.4	2.2	2.2	1.2	4.0	8.0	Q2
TPS71733DSER	WSON	DSE	6	3000	179.0	8.4	1.8	1.8	1.0	4.0	8.0	Q2
TPS71733DSET	WSON	DSE	6	250	179.0	8.4	1.8	1.8	1.0	4.0	8.0	Q2
TPS71745DSER	WSON	DSE	6	3000	180.0	8.4	1.75	1.75	1.0	4.0	8.0	Q2
TPS71745DSET	WSON	DSE	6	250	180.0	8.4	1.75	1.75	1.0	4.0	8.0	Q2
TPS71750DSER	WSON	DSE	6	3000	179.0	8.4	1.8	1.8	1.0	4.0	8.0	Q2
TPS71750DSET	WSON	DSE	6	250	179.0	8.4	1.8	1.8	1.0	4.0	8.0	Q2

TAPE AND REEL BOX DIMENSIONS



*All dimensions are nominal

Device	Package Type	Package Drawing	Pins	SPQ	Length (mm)	Width (mm)	Height (mm)
TPS71701DCKR	SC70	DCK	5	3000	180.0	180.0	18.0
TPS71701DCKR	SC70	DCK	5	3000	200.0	183.0	25.0
TPS71701DCKR1G4	SC70	DCK	5	3000	180.0	180.0	18.0
TPS71701DCKT	SC70	DCK	5	250	180.0	180.0	18.0
TPS71709DSE	WSON	DSE	6	3000	200.0	183.0	25.0
TPS71709DSET	WSON	DSE	6	250	200.0	183.0	25.0
TPS71710DCKR	SC70	DCK	5	3000	200.0	183.0	25.0
TPS71710DCKR	SC70	DCK	5	3000	180.0	180.0	18.0
TPS71710DCKT	SC70	DCK	5	250	203.0	203.0	35.0
TPS71710DCKT	SC70	DCK	5	250	340.0	340.0	38.0
TPS71710DCKT1G4	SC70	DCK	5	250	340.0	340.0	38.0
TPS71710DRVR	WSON	DRV	6	3000	200.0	183.0	25.0
TPS71710DRVT	WSON	DRV	6	250	203.0	203.0	35.0
TPS71711DCKR	SC70	DCK	5	3000	203.0	203.0	35.0
TPS71711DCKR	SC70	DCK	5	3000	180.0	180.0	18.0
TPS71711DCKT	SC70	DCK	5	250	340.0	340.0	38.0
TPS71711DCKT	SC70	DCK	5	250	203.0	203.0	35.0
TPS71712DCKR	SC70	DCK	5	3000	180.0	180.0	18.0

Device	Package Type	Package Drawing	Pins	SPQ	Length (mm)	Width (mm)	Height (mm)
TPS71712DCKR	SC70	DCK	5	3000	200.0	183.0	25.0
TPS71712DCKR1G4	SC70	DCK	5	3000	180.0	180.0	18.0
TPS71712DCKT	SC70	DCK	5	250	180.0	180.0	18.0
TPS71712DCKT	SC70	DCK	5	250	200.0	183.0	25.0
TPS71713DCKR	SC70	DCK	5	3000	200.0	183.0	25.0
TPS71713DCKR	SC70	DCK	5	3000	180.0	180.0	18.0
TPS71713DCKRG4	SC70	DCK	5	3000	180.0	180.0	18.0
TPS71713DCKT	SC70	DCK	5	250	180.0	180.0	18.0
TPS71715DCKR	SC70	DCK	5	3000	203.0	203.0	35.0
TPS71715DCKR	SC70	DCK	5	3000	180.0	180.0	18.0
TPS71715DCKRG4	SC70	DCK	5	3000	180.0	180.0	18.0
TPS71715DCKT	SC70	DCK	5	250	180.0	180.0	18.0
TPS71715DCKT	SC70	DCK	5	250	200.0	183.0	25.0
TPS717185DSER	WSON	DSE	6	3000	203.0	203.0	35.0
TPS717185DSET	WSON	DSE	6	250	200.0	183.0	25.0
TPS71718DCKR	SC70	DCK	5	3000	180.0	180.0	18.0
TPS71718DCKR	SC70	DCK	5	3000	200.0	183.0	25.0
TPS71718DCKT	SC70	DCK	5	250	180.0	180.0	18.0
TPS71718DCKT1G4	SC70	DCK	5	250	180.0	180.0	18.0
TPS71718DSER	WSON	DSE	6	3000	200.0	183.0	25.0
TPS71718DSET	WSON	DSE	6	250	203.0	203.0	35.0
TPS71719DCKR	SC70	DCK	5	3000	203.0	203.0	35.0
TPS71719DCKR	SC70	DCK	5	3000	180.0	180.0	18.0
TPS71719DCKT	SC70	DCK	5	250	180.0	180.0	18.0
TPS71719DCKT	SC70	DCK	5	250	203.0	203.0	35.0
TPS71721DCKR	SC70	DCK	5	3000	180.0	180.0	18.0
TPS71721DCKR	SC70	DCK	5	3000	203.0	203.0	35.0
TPS71721DCKT	SC70	DCK	5	250	180.0	180.0	18.0
TPS71721DCKT	SC70	DCK	5	250	203.0	203.0	35.0
TPS71725DCKR	SC70	DCK	5	3000	180.0	180.0	18.0
TPS71725DCKR	SC70	DCK	5	3000	200.0	183.0	25.0
TPS71725DCKR1G4	SC70	DCK	5	3000	180.0	180.0	18.0
TPS71725DCKT	SC70	DCK	5	250	180.0	180.0	18.0
TPS71725DCKT	SC70	DCK	5	250	203.0	203.0	35.0
TPS71726DCKR	SC70	DCK	5	3000	180.0	180.0	18.0
TPS71726DCKR	SC70	DCK	5	3000	200.0	183.0	25.0
TPS71726DCKT	SC70	DCK	5	250	180.0	180.0	18.0
TPS71726DCKT	SC70	DCK	5	250	203.0	203.0	35.0
TPS71727DCKR	SC70	DCK	5	3000	200.0	183.0	25.0
TPS71727DCKR	SC70	DCK	5	3000	180.0	180.0	18.0
TPS71727DCKT	SC70	DCK	5	250	180.0	180.0	18.0
TPS71727DCKT	SC70	DCK	5	250	203.0	203.0	35.0
TPS71727DSER	WSON	DSE	6	3000	200.0	183.0	25.0

Device	Package Type	Package Drawing	Pins	SPQ	Length (mm)	Width (mm)	Height (mm)
TPS71727DSET	WSON	DSE	6	250	200.0	183.0	25.0
TPS717285DCKR	SC70	DCK	5	3000	180.0	180.0	18.0
TPS717285DCKR	SC70	DCK	5	3000	203.0	203.0	35.0
TPS717285DCKRG4	SC70	DCK	5	3000	180.0	180.0	18.0
TPS717285DCKT	SC70	DCK	5	250	180.0	180.0	18.0
TPS717285DCKT	SC70	DCK	5	250	203.0	203.0	35.0
TPS71728DCKR	SC70	DCK	5	3000	203.0	203.0	35.0
TPS71728DCKR	SC70	DCK	5	3000	180.0	180.0	18.0
TPS71728DCKRG4	SC70	DCK	5	3000	180.0	180.0	18.0
TPS71728DCKT	SC70	DCK	5	250	180.0	180.0	18.0
TPS71728DSER	WSON	DSE	6	3000	200.0	183.0	25.0
TPS71728DSET	WSON	DSE	6	250	203.0	203.0	35.0
TPS71729DCKR	SC70	DCK	5	3000	180.0	180.0	18.0
TPS71729DCKR	SC70	DCK	5	3000	200.0	183.0	25.0
TPS71729DCKT	SC70	DCK	5	250	180.0	180.0	18.0
TPS71729DCKT	SC70	DCK	5	250	200.0	183.0	25.0
TPS71730DCKR	SC70	DCK	5	3000	180.0	180.0	18.0
TPS71730DCKR	SC70	DCK	5	3000	200.0	183.0	25.0
TPS71730DCKRG4	SC70	DCK	5	3000	180.0	180.0	18.0
TPS71730DCKT	SC70	DCK	5	250	180.0	180.0	18.0
TPS71733DCKR	SC70	DCK	5	3000	200.0	183.0	25.0
TPS71733DCKR	SC70	DCK	5	3000	180.0	180.0	18.0
TPS71733DCKR1G4	SC70	DCK	5	3000	180.0	180.0	18.0
TPS71733DCKT	SC70	DCK	5	250	180.0	180.0	18.0
TPS71733DCKT	SC70	DCK	5	250	203.0	203.0	35.0
TPS71733DRVR	WSON	DRV	6	3000	200.0	183.0	25.0
TPS71733DRVT	WSON	DRV	6	250	200.0	183.0	25.0
TPS71733DSER	WSON	DSE	6	3000	200.0	183.0	25.0
TPS71733DSET	WSON	DSE	6	250	200.0	183.0	25.0
TPS71745DSER	WSON	DSE	6	3000	182.0	182.0	20.0
TPS71745DSET	WSON	DSE	6	250	182.0	182.0	20.0
TPS71750DSER	WSON	DSE	6	3000	200.0	183.0	25.0
TPS71750DSET	WSON	DSE	6	250	200.0	183.0	25.0

GENERIC PACKAGE VIEW

DRV 6

WSON - 0.8 mm max height

PLASTIC SMALL OUTLINE - NO LEAD

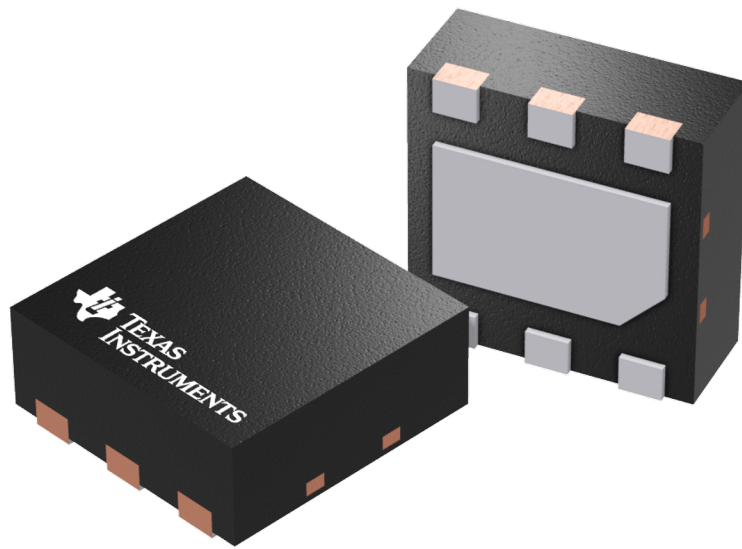

Images above are just a representation of the package family, actual package may vary.
Refer to the product data sheet for package details.

4206925/F

EXAMPLE STENCIL DESIGN

DRV0006D

WSON - 0.8 mm max height

PLASTIC SMALL OUTLINE - NO LEAD



SOLDER PASTE EXAMPLE
BASED ON 0.125 mm THICK STENCIL

EXPOSED PAD #7
88% PRINTED SOLDER COVERAGE BY AREA UNDER PACKAGE
SCALE:30X

4225563/A 12/2019

NOTES: (continued)

6. Laser cutting apertures with trapezoidal walls and rounded corners may offer better paste release. IPC-7525 may have alternate design recommendations.

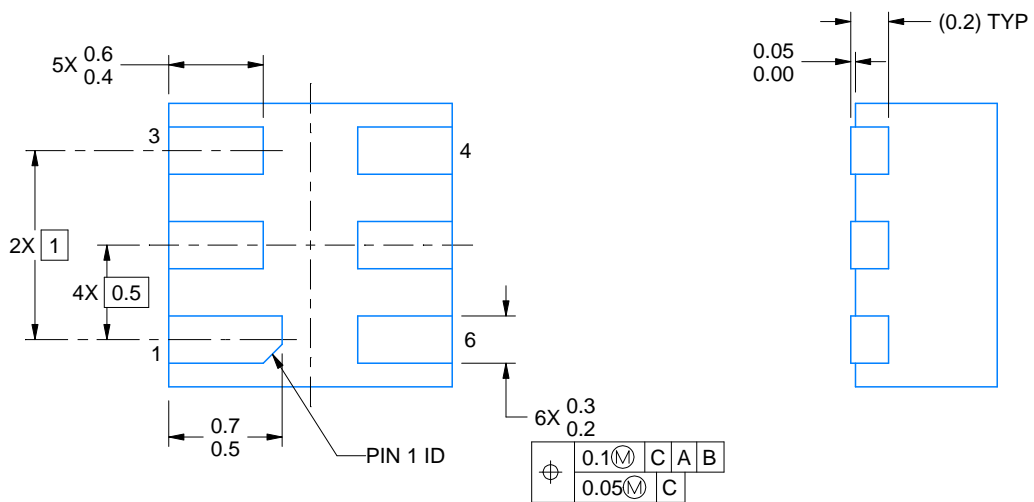
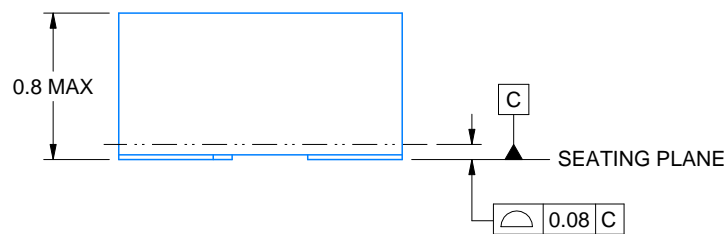
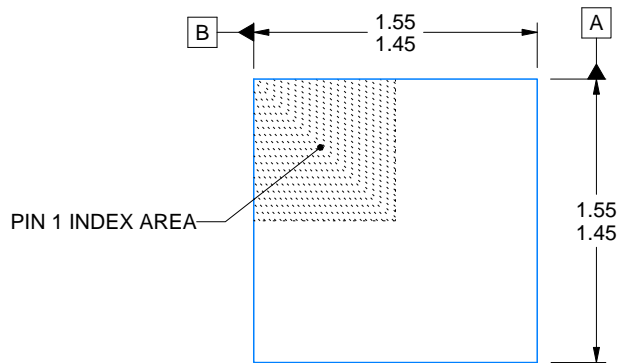

4220552/B 01/2024

NOTES:

1. All linear dimensions are in millimeters. Any dimensions in parenthesis are for reference only. Dimensioning and tolerancing per ASME Y14.5M.
2. This drawing is subject to change without notice.

EXAMPLE BOARD LAYOUT

DSE0006A

WSON - 0.8 mm max height

PLASTIC SMALL OUTLINE - NO LEAD

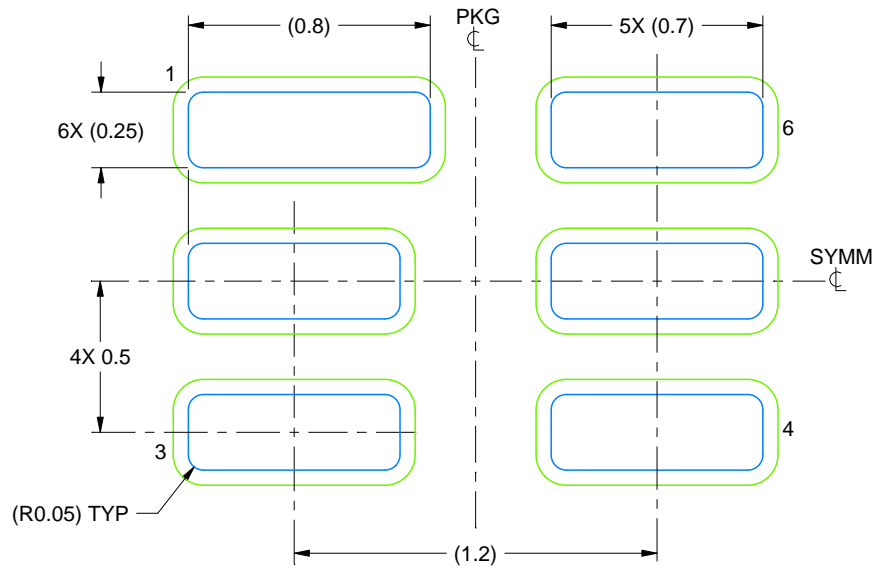

LAND PATTERN EXAMPLE
SCALE:40X

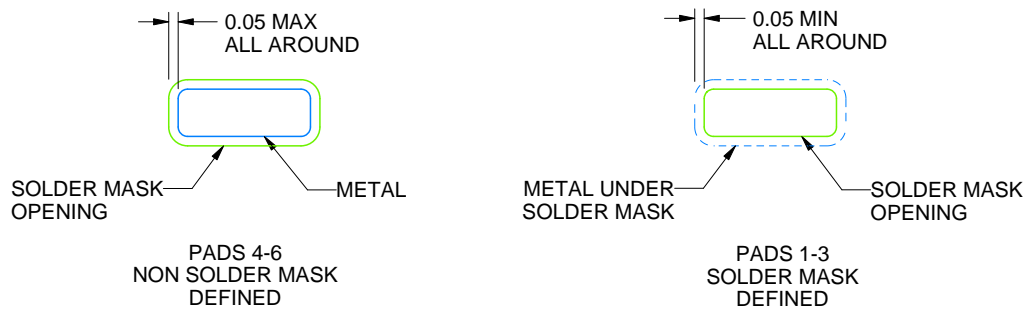

SOLDER MASK DETAILS

4220552/B 01/2024

NOTES: (continued)

3. For more information, see Texas Instruments literature number SLUA271 (www.ti.com/lit/slua271).

EXAMPLE STENCIL DESIGN

DSE0006A

WSON - 0.8 mm max height

PLASTIC SMALL OUTLINE - NO LEAD

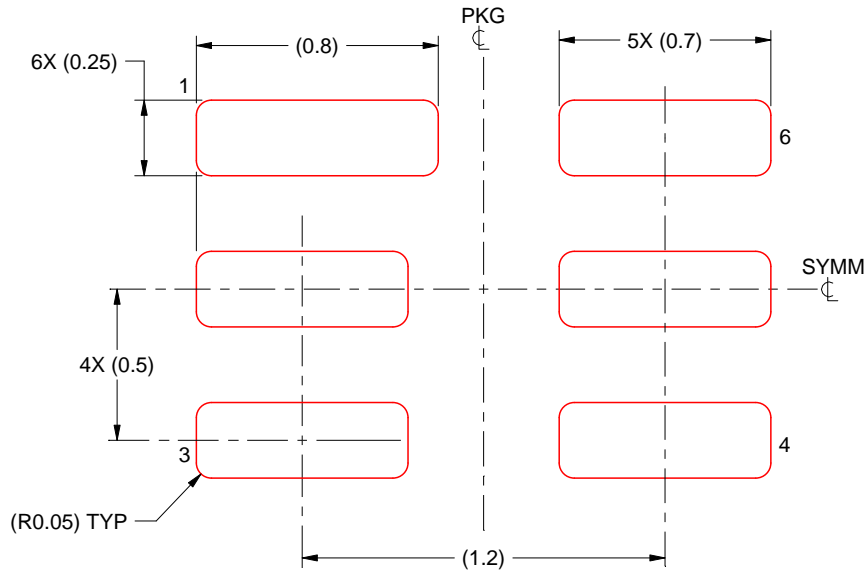

SOLDER PASTE EXAMPLE
BASED ON 0.125 mm THICK STENCIL
SCALE:40X

NOTES: (continued)

4. Laser cutting apertures with trapezoidal walls and rounded corners may offer better paste release. IPC-7525 may have alternate design recommendations.

EXAMPLE BOARD LAYOUT

DCK0005A

SOT - 1.1 max height

SMALL OUTLINE TRANSISTOR



LAND PATTERN EXAMPLE
EXPOSED METAL SHOWN
SCALE:18X

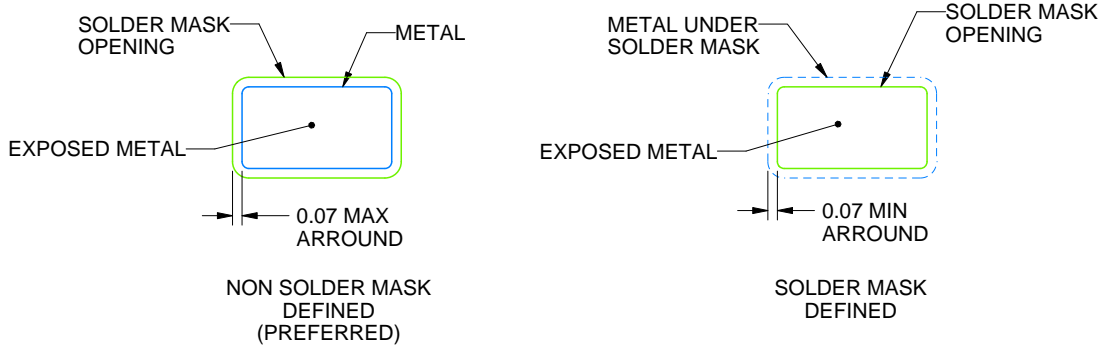

SOLDER MASK DETAILS

4214834/G 11/2024

NOTES: (continued)

- 7. Publication IPC-7351 may have alternate designs.
- 8. Solder mask tolerances between and around signal pads can vary based on board fabrication site.

EXAMPLE STENCIL DESIGN

DCK0005A

SOT - 1.1 max height

SMALL OUTLINE TRANSISTOR



SOLDER PASTE EXAMPLE
BASED ON 0.125 THICK STENCIL
SCALE: 18X

4214834/G 11/2024

NOTES: (continued)

9. Laser cutting apertures with trapezoidal walls and rounded corners may offer better paste release. IPC-7525 may have alternate design recommendations.
10. Board assembly site may have different recommendations for stencil design.

重要通知和免责声明

TI“按原样”提供技术和可靠性数据（包括数据表）、设计资源（包括参考设计）、应用或其他设计建议、网络工具、安全信息和其他资源，不保证没有瑕疵且不做任何明示或暗示的担保，包括但不限于对适销性、与某特定用途的适用性或不侵犯任何第三方知识产权的暗示担保。

这些资源可供使用 TI 产品进行设计的熟练开发人员使用。您将自行承担以下全部责任：(1) 针对您的应用选择合适的 TI 产品，(2) 设计、验证并测试您的应用，(3) 确保您的应用满足相应标准以及任何其他安全、安保法规或其他要求。

这些资源如有变更，恕不另行通知。TI 授权您仅可将这些资源用于研发本资源所述的 TI 产品的相关应用。严禁以其他方式对这些资源进行复制或展示。您无权使用任何其他 TI 知识产权或任何第三方知识产权。对于因您对这些资源的使用而对 TI 及其代表造成的任何索赔、损害、成本、损失和债务，您将全额赔偿，TI 对此概不负责。

TI 提供的产品受 [TI 销售条款](#)、[TI 通用质量指南](#) 或 [ti.com](#) 上其他适用条款或 TI 产品随附的其他适用条款的约束。TI 提供这些资源并不会扩展或以其他方式更改 TI 针对 TI 产品发布的适用的担保或担保免责声明。除非德州仪器 (TI) 明确将某产品指定为定制产品或客户特定产品，否则其产品均为按确定价格收入目录的标准通用器件。

TI 反对并拒绝您可能提出的任何其他或不同的条款。

版权所有 © 2026，德州仪器 (TI) 公司

最后更新日期：2025 年 10 月