

## TPS7A14 1A、低 $V_{IN}$ 、低 $V_{OUT}$ 、超低压降稳压器

### 1 特性

- 超低输入电压范围：0.7V 至 2.2V
- 高效率：
  - 1A 时的压降电压为：70mV (最大值, YBK)
  - 适用于  $V_{IN} = V_{OUT} + 100\text{mV}$
- 出色的负载瞬态响应：
  - $I_{LOAD}$  在 20 $\mu\text{s}$  内从 3mA 变化到 600mA 时为 20mV
- 在负载、线路和温度范围内的精度为：1%
- 高 PSRR：
  - 在 1kHz 下为 80dB ( $V_{OUT} = 0.8\text{V}$ ,  $I_{OUT} = 500\text{mA}$ )
- 可提供固定输出电压：
  - 0.5V 至 2.0V (阶跃为 25mV)
- $V_{BIAS}$  范围：2.2V 至 5.5V
- 封装：
  - 6 引脚 DSBGA：0.71mm × 1.16mm
  - 6 引脚 WSON：2mm × 2mm
- 有源输出放电

### 2 应用

- 摄像头模块
- 无线耳机和耳塞
- 智能手表和健身追踪器
- 智能手机和平板电脑
- 便携式医疗设备
- 固态硬盘 (SSD)

### 3 说明

TPS7A14 是一款小型超低压差稳压器 (LDO)，具有出色的瞬态响应。该器件可提供 1A 电流，并具有出色的交流性能 (负载和线路瞬态响应)。输入电压范围为 0.7V 至 2.2V，输出范围为 0.5V 至 2.0V，且在负载、线路和温度范围内具有 1% 的超高精度。

主电源路径通过 IN 引脚，可连接至电压至少高于输出电压 50mV 的电源。所有电气特性 (包括出色的输出电压容差、瞬态响应和 PSRR) 均针对输入电压 (比输出电压高 100mV) 进行规定，因此可实现高效率。该稳压器使用一个为 LDO 内部电路供电的外部较高  $V_{BIAS}$  电压轨，支持很低的输入电压。例如，IN 引脚的电源电压可以是高效直流/直流降压稳压器的输出，而 BIAS 引脚电源电压可来自可再充电电池。

TPS7A14 配备了一个有源下拉电路，用于在输出处于禁用状态时使其快速放电，并提供已知的启动状态。

TPS7A14 采用 2mm × 2mm、6 引脚 WSON 封装和超小型 0.71mm × 1.16mm、6 凸点 WCSP 封装。

#### 封装信息

器件型号	封装 <sup>(1)</sup>	封装尺寸 <sup>(2)</sup>
TPS7A14	YBK (WCSP, 6)	1.16mm × 0.71mm
	DRV (WSON, 6)	2mm × 2mm

(1) 如需了解所有可用封装，请参阅数据表末尾的可订购产品附录。

(2) 封装尺寸 (长 × 宽) 为标称值，并包括引脚 (如适用)。

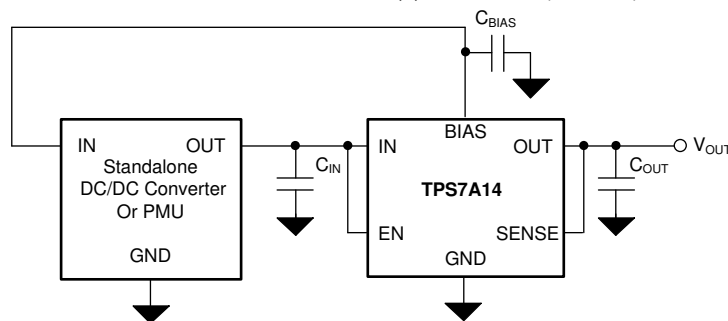

典型应用电路



## Table of Contents

1 特性.....	1	7.3 Feature Description.....	16
2 应用.....	1	7.4 Device Functional Modes.....	18
3 说明.....	1	<b>8 Application and Implementation.....</b>	<b>19</b>
<b>4 Revision History.....</b>	<b>2</b>	8.1 Application Information.....	19
<b>5 Pin Configuration and Functions.....</b>	<b>3</b>	8.2 Typical Application.....	23
<b>6 Specifications.....</b>	<b>5</b>	8.3 Power Supply Recommendations.....	25
6.1 Absolute Maximum Ratings.....	5	8.4 Layout.....	26
6.2 ESD Ratings.....	5	<b>9 Device and Documentation Support.....</b>	<b>27</b>
6.3 Recommended Operating Conditions.....	5	9.1 Device Support.....	27
6.4 Thermal Information.....	6	9.2 Documentation Support.....	27
6.5 Electrical Characteristics.....	6	9.3 接收文档更新通知.....	27
6.6 Switching Characteristics.....	9	9.4 支持资源.....	27
6.7 Typical Characteristics.....	10	9.5 Trademarks.....	27
<b>7 Detailed Description.....</b>	<b>15</b>	9.6 静电放电警告.....	27
7.1 Overview.....	15	9.7 术语表.....	27
7.2 Functional Block Diagram.....	15		

## 4 Revision History

注：以前版本的页码可能与当前版本的页码不同

Changes from Revision C (July 2023) to Revision D (August 2023)	Page
• 将 DRV (WSO) 封装从 预告信息 更改为 量产数据 .....	1
• Changed specifications for DRV package.....	6
• Added <i>Output Noise vs Frequency and I<sub>OUT</sub></i> curve for the DRV package.....	10
• Added <i>Recommended Layout (DRV Package)</i> figure.....	26

Changes from Revision B (May 2022) to Revision C (July 2023)	Page
• 向文档中添加了 DRV (WSO) 封装作为 预告信息 .....	1
• 通篇将固定输出电压从 0.5V 至 2.05V 更改为 0.5V 至 2.0V .....	1
• 更改了 说明 部分最后一段中的封装说明.....	1

## 5 Pin Configuration and Functions



图 5-1. YBK Package, 6-Pin WCSP (Top View)

表 5-1. Pin Functions: YBK Package

PIN		TYPE	DESCRIPTION
NO.	NAME		
A1	OUT	Output	Regulated output pin. A 2.2- $\mu$ F or greater capacitance is required from OUT to ground for stability. For best transient response, use an 8- $\mu$ F (nominal) or larger ceramic capacitor from OUT to ground. Place the output capacitor as close to OUT as possible.
A2	IN	Input	Input pin. A 0.75- $\mu$ F or greater capacitance is required from IN to ground for stability. Place the input capacitor as close to IN as possible.
B1	SENSE	Input	SENSE input. This pin is a feedback input to the regulator for SENSE connections. Connecting SENSE to the load helps eliminate voltage errors resulting from trace resistance between OUT and the load.
B2	EN	Input	Enable pin. Driving this pin to logic high enables the LDO. Driving this pin to logic low disables the LDO. If enable functionality is not required, EN must be connected to IN or BIAS.
C1	GND	—	Ground pin. This pin must be connected to ground.
C2	BIAS	Input	BIAS pin. This pin enables operation in low-input voltage, low-output voltage (LILLO) conditions. For best performance, use 0.47- $\mu$ F or larger ceramic capacitor from BIAS to ground. Place the bias capacitor as close to BIAS as possible.

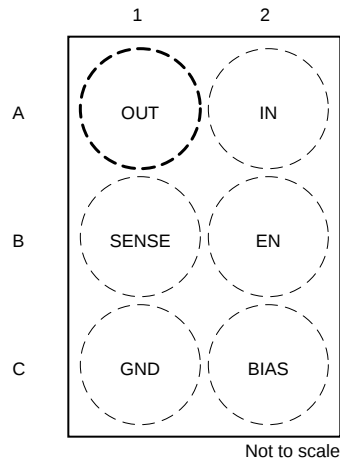

图 5-2. DRV Package, 6-Pin WSON With Exposed Thermal Pad (Top View)

表 5-2. Pin Functions: DRV Package

PIN		TYPE	DESCRIPTION
NO.	NAME		
1	OUT	Output	Regulated output pin. A 2.2- $\mu$ F or greater capacitance is required from OUT to ground for stability. For best transient response, use an 8- $\mu$ F (nominal) or larger ceramic capacitor from OUT to ground. Place the output capacitor as close to OUT as possible.
2	SENSE	Input	SENSE input. This pin is a feedback input to the regulator for SENSE connections. Connecting SENSE to the load helps eliminate voltage errors resulting from trace resistance between OUT and the load.
3	EN	Input	Enable pin. Driving this pin to logic high enables the LDO. Driving this pin to logic low disables the LDO. If enable functionality is not required, EN must be connected to IN or BIAS.
4	BIAS	Input	BIAS pin. This pin enables operation in LILLO conditions. For best performance, use 0.47- $\mu$ F or larger ceramic capacitor from BIAS to ground. Place the bias capacitor as close to BIAS as possible.
5	GND	—	Ground pin. This pin must be connected to ground.
6	IN	Input	Input pin. A 0.75- $\mu$ F or greater capacitance is required from IN to ground for stability. Place the input capacitor as close to IN as possible.
Thermal Pad		—	The thermal pad is electrically connected to the GND node. Connect to the GND plane for improved thermal performance.

## 6 Specifications

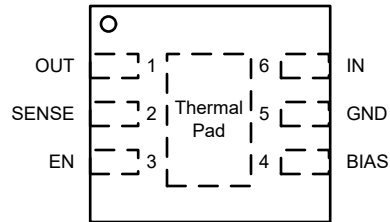
### 6.1 Absolute Maximum Ratings

over operating free-air temperature range unless otherwise noted.<sup>(1)</sup>

		MIN	MAX	UNIT
Voltage	Input, $V_{IN}$	- 0.3	2.4	V
	Enable, $V_{EN}$	- 0.3	6.0	
	Bias, $V_{BIAS}$	- 0.3	6.0	
	Sense, $V_{SENSE}$	- 0.3	$V_{IN} + 0.3$ <sup>(2)</sup>	
	Output, $V_{OUT}$	- 0.3	$V_{IN} + 0.3$ <sup>(2)</sup>	
Current	Maximum output	Internally limited		A
Temperature	Operating junction, $T_J$	- 40	150	°C
	Storage, $T_{stg}$	- 65	150	°C

- Operation outside the Absolute Maximum Ratings may cause permanent device damage. Absolute maximum ratings do not imply functional operation of the device at these or any other conditions beyond those listed under Recommended Operating Conditions. If briefly operating outside the Recommended Operating Conditions but within the Absolute Maximum Ratings, the device may not sustain damage, but it may not be fully functional. Operating the device in this manner may affect device reliability, functionality, performance, and shorten the device lifetime.
- The absolute maximum rating is 2.4 V or ( $V_{IN} + 0.3$  V), whichever is less.

### 6.2 ESD Ratings

			VALUE	UNIT
$V_{(ESD)}$	Electrostatic discharge	Human-body model (HBM), per ANSI/ESDA/JEDEC JS-001 <sup>(1)</sup>	±3000	V
		Charged-device model (CDM), per JEDEC specification JESD22-C101 <sup>(2)</sup>	±750	

- JEDEC document JEP155 states that 500-V HBM allows safe manufacturing with a standard ESD control process.
- JEDEC document JEP157 states that 250-V CDM allows safe manufacturing with a standard ESD control process.

### 6.3 Recommended Operating Conditions

over operating junction temperature range (unless otherwise noted).<sup>(1)</sup>

		MIN	NOM	MAX	UNIT
$V_{IN}$	Input voltage	0.7		2.2	V
$V_{BIAS}$	Bias voltage	Greater of 2.2 or $V_{OUT(NOM)} + 1.4$		5.5	V
$V_{OUT}$	Output voltage	0.5		2.0	V
$I_{OUT}$	Peak output current	0		1	A
$C_{IN}$	Input capacitance <sup>(2)</sup>	0.75			µF
$C_{BIAS}$	Bias capacitance <sup>(4)</sup>		0.1		µF
$C_{OUT}$	Output capacitance, DRV package	2.2		22	µF
$C_{OUT}$	Output capacitance, YBK package	2.2		47	µF
ESR	Output capacitor series resistance			100	mΩ
$T_J$	Operating junction temperature	- 40		125	°C

- All voltages are with respect to GND.
- An input capacitor is required to counteract the effect of source resistance and inductance, which may in some cases cause symptoms of system level instability such as ringing or oscillation, especially in the presence of load transients. A larger input capacitor may be necessary depending on the source impedance and system requirements.
- A BIAS input capacitor is not required for LDO stability. However, a capacitor with a derated value of at least 0.1 µF is recommended to maintain transient, PSRR, and noise performance.

## 6.4 Thermal Information

THERMAL METRIC <sup>(1)</sup>		TPS7A14		UNIT
		WSN	DSBGA	
		6 PINS	6 PINS	
$R_{\theta JA}$	Junction-to-ambient thermal resistance	72.7	136.7	°C/W
$R_{\theta JC(top)}$	Junction-to-case (top) thermal resistance	84.9	1.1	°C/W
$R_{\theta JB}$	Junction-to-board thermal resistance	32.7	38.1	°C/W
$\psi_{JT}$	Junction-to-top characterization parameter	3.2	0.5	°C/W
$\psi_{JB}$	Junction-to-board characterization parameter	32.6	38.1	°C/W
$R_{\theta JC(bot)}$	Junction-to-case (bottom) thermal resistance	16.8	n/a	°C/W

- (1) For more information about traditional and new thermal metrics, see the [Semiconductor and IC Package Thermal Metrics](#) application report.

## 6.5 Electrical Characteristics

specified at  $T_J = -40^{\circ}\text{C}$  to  $+125^{\circ}\text{C}$ ,  $V_{IN} = V_{OUT(NOM)} + 0.1\text{ V}$ ,  $V_{BIAS} = \text{greater of } 2.2\text{ V or } V_{OUT(NOM)} + 1.4\text{ V}$ ,  $I_{OUT} = 1\text{ mA}$ ,  $V_{EN} = 1.0\text{ V}$ ,  $C_{IN} = 1\ \mu\text{F}$ ,  $C_{OUT} = 2.2\ \mu\text{F}$ , and  $C_{BIAS} = 0.1\ \mu\text{F}$  (unless otherwise noted); all typical values are at  $T_J = 25^{\circ}\text{C}$

PARAMETER	TEST CONDITIONS	MIN	TYP	MAX	UNIT
$V_{OUT}$	Accuracy over temperature $V_{OUT(NOM)} + 0.1\text{ V} \leq V_{IN} \leq 2.2\text{ V}$ , Greater of 2.2 V or $V_{OUT(NOM)} + 1.4\text{ V} \leq V_{BIAS} \leq 5.5\text{ V}$ , $1\text{ mA} \leq I_{OUT} \leq 1\text{ A}$	$T_J = -40^{\circ}\text{C}$ to $+125^{\circ}\text{C}$ , DRV package	-1.25	1	%
		$T_J = -40^{\circ}\text{C}$ to $+125^{\circ}\text{C}$ , YBK package	-1.5	1	
		$T_J = -40^{\circ}\text{C}$ to $+85^{\circ}\text{C}$	-1	1	
$\Delta V_{OUT} / \Delta V_{IN}$	$V_{IN}$ line regulation $V_{OUT(NOM)} + 0.1\text{ V} \leq V_{IN} \leq 2.2\text{ V}$ , $T_J = -40^{\circ}\text{C}$ to $+85^{\circ}\text{C}$ , YBK package	$V_{OUT(NOM)} + 0.1\text{ V} \leq V_{IN} \leq 2.2\text{ V}$ , DRV package	-3	3	mV
		$V_{OUT(NOM)} + 0.1\text{ V} \leq V_{IN} \leq 2.2\text{ V}$ , $T_J = -40^{\circ}\text{C}$ to $+85^{\circ}\text{C}$ , YBK package	-2.5	2.5	
$\Delta V_{OUT} / \Delta V_{BIAS}$	$V_{BIAS}$ line regulation $V_{OUT(NOM)} + 1.4\text{ V} \leq V_{BIAS} \leq 5.5\text{ V}$ , DRV package $V_{OUT(NOM)} + 1.4\text{ V} \leq V_{BIAS} \leq 5.5\text{ V}$ , $T_J = -40^{\circ}\text{C}$ to $+85^{\circ}\text{C}$ , YBK package	$V_{OUT(NOM)} + 1.4\text{ V} \leq V_{BIAS} \leq 5.5\text{ V}$ , DRV package	-3	$\pm 0.15$	mV
		$V_{OUT(NOM)} + 1.4\text{ V} \leq V_{BIAS} \leq 5.5\text{ V}$ , $T_J = -40^{\circ}\text{C}$ to $+85^{\circ}\text{C}$ , YBK package	-2.5	$\pm 0.15$	
$\Delta V_{OUT} / \Delta I_{OUT}$	Load regulation $1\text{ mA} \leq I_{OUT} \leq 1\text{ A}$		0.2		%/A
$I_{Q(BIAS)}$	Bias pin current	$I_{OUT} = 0\text{ mA}$ , DRV package		43	$\mu\text{A}$
		$I_{OUT} = 0\text{ mA}$ , $T_J = -40^{\circ}\text{C}$ to $+85^{\circ}\text{C}$ , YBK package		26	
		$I_{OUT} = 1\text{ A}$ , DRV package		17	mA
		$I_{OUT} = 1\text{ A}$ , $T_J = -40^{\circ}\text{C}$ to $+85^{\circ}\text{C}$ , YBK package		12	
$I_{Q(IN)}$	Input pin current <sup>(1)</sup>	$I_{OUT} = 0\text{ mA}$ , DRV package		118	$\mu\text{A}$
		$I_{OUT} = 0\text{ mA}$ , $T_J = -40^{\circ}\text{C}$ to $+85^{\circ}\text{C}$		5.7	
$I_{GND}$	Ground pin current	$I_{OUT} = 1\text{ A}$ , DRV package	480	660	$\mu\text{A}$
		$I_{OUT} = 1\text{ A}$ , $T_J = -40^{\circ}\text{C}$ to $+85^{\circ}\text{C}$	480	620	
$I_{SHDN(BIAS)}$	$V_{BIAS}$ shutdown current	$V_{IN} = 2.2\text{ V}$ , $V_{BIAS} = 5.5\text{ V}$ , $V_{EN} \leq 0.2\text{ V}$ , DRV package	0.3	9	$\mu\text{A}$
		$V_{IN} = 2.2\text{ V}$ , $V_{BIAS} = 5.5\text{ V}$ , $V_{EN} \leq 0.2\text{ V}$ , $T_J = -40^{\circ}\text{C}$ to $+85^{\circ}\text{C}$	0.3	3.8	
$I_{SHDN(IN)}$	$V_{IN}$ shutdown current	$V_{IN} = 1.8\text{ V}$ , $V_{BIAS} = 5.5\text{ V}$ , $V_{EN} \leq 0.2\text{ V}$ , DRV package	1	41	$\mu\text{A}$
		$V_{IN} = 1.8\text{ V}$ , $V_{BIAS} = 5.5\text{ V}$ , $V_{EN} \leq 0.2\text{ V}$ , $T_J = -40^{\circ}\text{C}$ to $+85^{\circ}\text{C}$	1	9.2	
$I_{CL}$	Output current limit	$V_{OUT} = 0.95 \times V_{OUT(NOM)}$	1.035	1.6	A
$I_{SC}$	Short circuit current limit	$V_{OUT} = 0\text{ V}$		600	mA

## 6.5 Electrical Characteristics (continued)

specified at  $T_J = -40^\circ\text{C}$  to  $+125^\circ\text{C}$ ,  $V_{IN} = V_{OUT(NOM)} + 0.1\text{ V}$ ,  $V_{BIAS} = \text{greater of } 2.2\text{ V or } V_{OUT(NOM)} + 1.4\text{ V}$ ,  $I_{OUT} = 1\text{ mA}$ ,  $V_{EN} = 1.0\text{ V}$ ,  $C_{IN} = 1\ \mu\text{F}$ ,  $C_{OUT} = 2.2\ \mu\text{F}$ , and  $C_{BIAS} = 0.1\ \mu\text{F}$  (unless otherwise noted); all typical values are at  $T_J = 25^\circ\text{C}$

PARAMETER		TEST CONDITIONS		MIN	TYP	MAX	UNIT
$V_{DO(IN)}$	$V_{IN}$ dropout voltage <sup>(2)</sup>	$V_{IN} = 0.95 \times V_{OUT(NOM)}$ , $I_{OUT} = 1\text{ A}$	$T_J = -40^\circ\text{C}$ to $+125^\circ\text{C}$			99	mV
			$T_J = -40^\circ\text{C}$ to $+85^\circ\text{C}$ , DRV package			77	
			$T_J = -40^\circ\text{C}$ to $+85^\circ\text{C}$ , YBK package			70	
$V_{DO(BIAS)}$	$V_{BIAS}$ dropout voltage <sup>(2)</sup>	$V_{BIAS} = \text{greater of } 1.7\text{V or } V_{OUT(nom)} + 0.6\text{ V}$ , $V_{SENSE} = 0.95 \times V_{OUT(nom)}$ , $I_{OUT} = 1\text{ A}$ , DRV package				1.115	V
			$V_{BIAS} = \text{greater of } 1.7\text{V or } V_{OUT(nom)} + 0.6\text{ V}$ , $V_{SENSE} = 0.95 \times V_{OUT(nom)}$ , $I_{OUT} = 1\text{ A}$ , YBK package				
$V_{IN}$ PSRR	$V_{IN}$ power-supply rejection ratio		f = 100 Hz	$I_{OUT} = 3\text{ mA}$		90	dB
				$I_{OUT} = 500\text{ mA}$		80	
				$I_{OUT} = 1\text{ A}$		80	
			f = 1 kHz	$I_{OUT} = 3\text{ mA}$		90	
				$I_{OUT} = 500\text{ mA}$		80	
				$I_{OUT} = 1\text{ A}$		70	
			f = 10 kHz	$I_{OUT} = 3\text{ mA}$		70	
				$I_{OUT} = 500\text{ mA}$		60	
				$I_{OUT} = 1\text{ A}$		50	
			f = 100 kHz	$I_{OUT} = 3\text{ mA}$		60	
				$I_{OUT} = 500\text{ mA}$		43	
				$I_{OUT} = 1\text{ A}$		33	
f = 1 MHz	$I_{OUT} = 3\text{ mA}$		60				
	$I_{OUT} = 500\text{ mA}$		24				
	$I_{OUT} = 1\text{ A}$		15				
f = 1 MHz, $V_{IN} = V_{OUT} + 150\text{ mV}$	$I_{OUT} = 3\text{ mA}$		69				
	$I_{OUT} = 500\text{ mA}$		42				
	$I_{OUT} = 1\text{ A}$		33				
$V_{BIAS}$ PSRR	$V_{BIAS}$ power-supply rejection ratio	f = 1 kHz f = 100 kHz f = 1 MHz	$I_{OUT} = 500\text{ mA}$			65	dB
						45	
						25	
$V_n$	Output voltage noise	Bandwidth = 10 Hz to 100 kHz, $V_{OUT} = 0.8\text{ V}$ , $5\text{ mA} \leq I_{OUT} \leq 1\text{ A}$			7.2		$\mu\text{V}_{RMS}$
$V_{UVLO(BIAS)}$	Bias supply UVLO	$V_{BIAS}$ rising		1.15	1.42	1.7	V
		$V_{BIAS}$ falling		1.0	1.3	1.63	
$V_{UVLO\_HYST(BIAS)}$	Bias supply hysteresis	$V_{BIAS}$ hysteresis			100		mV
$V_{UVLO(IN)}$	Input supply UVLO	$V_{IN}$ rising		584	603	623	mV
		$V_{IN}$ falling		530	552	566	
$V_{UVLO\_HYST(IN)}$	Input supply hysteresis	$V_{IN}$ hysteresis			50		mV
$t_{STR}$	Start-up time <sup>(3)</sup>				186		$\mu\text{s}$
$V_{EN(HI)}$	EN pin logic high voltage <sup>(4)</sup>			0.6		6	V
$V_{EN(LOW)}$	EN pin logic low voltage <sup>(4)</sup>			0		0.25	V
$I_{EN}$	EN pin current	EN = 5.5 V, DRV package		-25	10	25	nA
		EN = 5.5 V, $T_J = -40^\circ\text{C}$ to $+85^\circ\text{C}$		-20	10	20	
$R_{PULLDOWN}$	Pulldown resistor	$V_{IN} = 0.9\text{ V}$ , $V_{OUT(nom)} = 0.8\text{ V}$ , $V_{BIAS} = 1\text{ V}$ , $V_{EN} = 0\text{ V}$ , P version only			36		$\Omega$

## 6.5 Electrical Characteristics (continued)

specified at  $T_J = -40^\circ\text{C}$  to  $+125^\circ\text{C}$ ,  $V_{IN} = V_{OUT(NOM)} + 0.1\text{ V}$ ,  $V_{BIAS} = \text{greater of } 2.2\text{ V or } V_{OUT(NOM)} + 1.4\text{ V}$ ,  $I_{OUT} = 1\text{ mA}$ ,  $V_{EN} = 1.0\text{ V}$ ,  $C_{IN} = 1\ \mu\text{F}$ ,  $C_{OUT} = 2.2\ \mu\text{F}$ , and  $C_{BIAS} = 0.1\ \mu\text{F}$  (unless otherwise noted); all typical values are at  $T_J = 25^\circ\text{C}$

PARAMETER		TEST CONDITIONS	MIN	TYP	MAX	UNIT
$T_{SD}$	Thermal shutdown temperature	Shutdown, temperature rising		165		°C
		Reset, temperature falling		140		

- (1) This is the current flowing from  $V_{IN}$  to GND.
- (2) Dropout is not measured for  $V_{OUT} < 0.6\text{ V}$ .  $V_{BIAS}$  dropout applies only for  $V_{BIAS}$  of 2.2 V or greater.
- (3) Startup time = time from EN assertion to  $0.95 \times V_{OUT(NOM)}$ .
- (4) An input voltage within the minimum to maximum range is interpreted as the correct logic level.



## 6.6 Switching Characteristics

specified at  $T_J = -40^\circ\text{C}$  to  $+125^\circ\text{C}$ ,  $V_{IN} = V_{OUT(NOM)} + 0.1\text{ V}$ ,  $V_{BIAS} = \text{greater of } 2.2\text{ V or } V_{OUT(NOM)} + 1.4\text{ V}$ ,  $I_{OUT} = 1\text{ mA}$ ,  $V_{EN} = 1.0\text{ V}$ ,  $C_{IN} = 1\ \mu\text{F}$ ,  $C_{OUT} = 2.2\ \mu\text{F}$ , and  $C_{BIAS} = 0.1\ \mu\text{F}$  (unless otherwise noted); all typical values are at  $T_J = 25^\circ\text{C}$ ; all transients values are over multiple load or line pulses with periods of  $100\ \mu\text{s}$  on (high load) and  $100\ \mu\text{s}$  off (low load)

PARAMETER		TEST CONDITIONS		MIN	TYP	MAX	UNIT
$\Delta V_{OUT}$	Line transient <sup>(1)</sup>	$V_{IN} = (V_{OUT(NOM)} + 0.1\text{ V})$ to $2.1\text{ V}$	Transition time, $t_R = 1\text{ V} / \mu\text{s}$			1	% $V_{OUT}$
		$V_{IN} = 2.1\text{ V}$ to $(V_{OUT(NOM)} + 0.1\text{ V})$	Transition time, $t_F = 1\text{ V} / \mu\text{s}$	- 1			
$\Delta V_{OUT}$	Load transient <sup>(1)</sup>	$I_{OUT} = 3\text{ mA}$ to $600\text{ mA}$	Transition time, $t_R = 20\ \mu\text{s}$ , $t_F = 20\ \mu\text{s}$ , $t_{OFF} = 200\ \mu\text{s}$ , $t_{ON} = 1\text{ ms}$ , $C_{IN} = 5\ \mu\text{F}$ , $C_{OUT} = 5\ \mu\text{F}$			- 2	% $V_{OUT}$
		$I_{OUT} = 600\text{ mA}$ to $3\text{ mA}$				2	

(1) This specification is verified by design.

### 6.7 Typical Characteristics

at operating temperature  $T_J = 25^\circ\text{C}$ ,  $V_{OUT(NOM)} = 0.8\text{ V}$ ,  $V_{IN} = V_{OUT(NOM)} + 0.1\text{ V}$ ,  $V_{BIAS} = V_{OUT(NOM)} + 1.4\text{ V}$ ,  $I_{OUT} = 1\text{ mA}$ ,  $V_{EN} = V_{IN}$ ,  $C_{IN} = 2.2\text{ }\mu\text{F}$ ,  $C_{OUT} = 2.2\text{ }\mu\text{F}$ , and  $C_{BIAS} = 0.47\text{ }\mu\text{F}$  (unless otherwise noted)



图 6-1. Output Voltage Accuracy vs  $V_{IN}$



图 6-2. Output Voltage Accuracy vs  $V_{BIAS}$

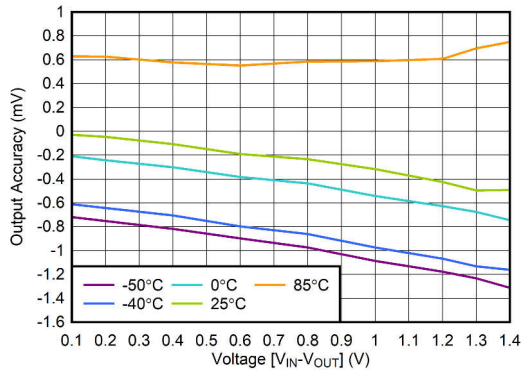

图 6-3. Output Voltage Accuracy vs  $I_{OUT}$

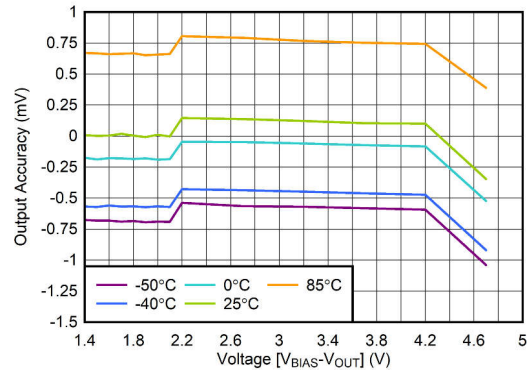

图 6-4.  $V_{IN}$  Dropout Voltage vs  $I_{OUT}$

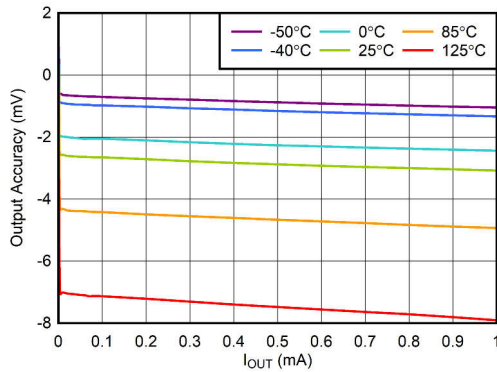

图 6-5.  $V_{BIAS}$  Dropout Voltage vs  $I_{OUT}$

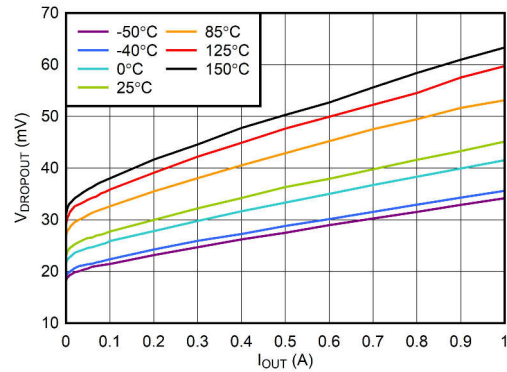

图 6-6.  $V_{BIAS}$  Input Current vs  $V_{BIAS}$

### 6.7 Typical Characteristics (continued)

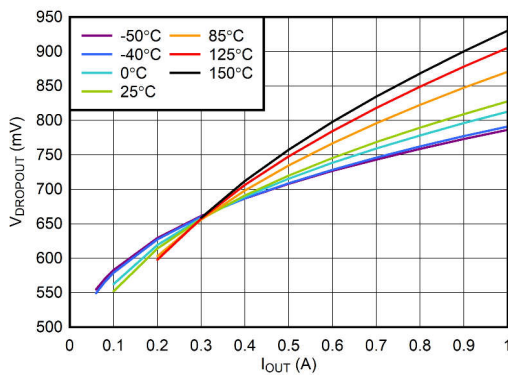
at operating temperature  $T_J = 25^\circ\text{C}$ ,  $V_{\text{OUT(NOM)}} = 0.8\text{ V}$ ,  $V_{\text{IN}} = V_{\text{OUT(NOM)}} + 0.1\text{ V}$ ,  $V_{\text{BIAS}} = V_{\text{OUT(NOM)}} + 1.4\text{ V}$ ,  $I_{\text{OUT}} = 1\text{ mA}$ ,  $V_{\text{EN}} = V_{\text{IN}}$ ,  $C_{\text{IN}} = 2.2\text{ }\mu\text{F}$ ,  $C_{\text{OUT}} = 2.2\text{ }\mu\text{F}$ , and  $C_{\text{BIAS}} = 0.47\text{ }\mu\text{F}$  (unless otherwise noted)

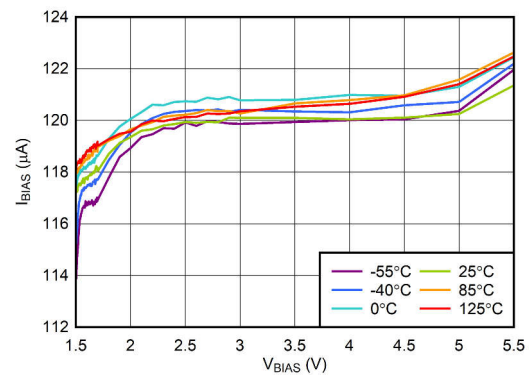

图 6-7.  $V_{\text{BIAS}}$  Input Current vs  $V_{\text{BIAS}}$



图 6-8.  $V_{\text{IN}}$  Shutdown  $I_{\text{Q}}$  vs  $V_{\text{IN}}$

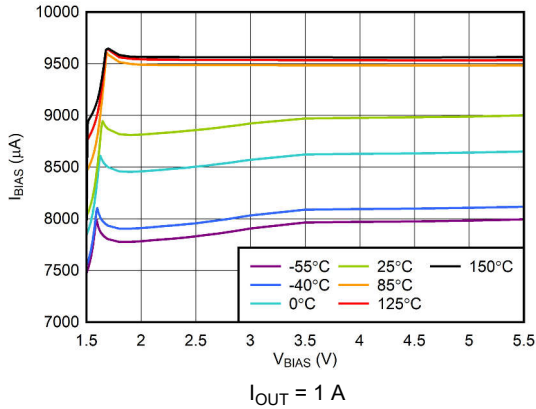

图 6-9.  $V_{\text{BIAS}}$  Shutdown  $I_{\text{Q}}$  vs  $V_{\text{BIAS}}$

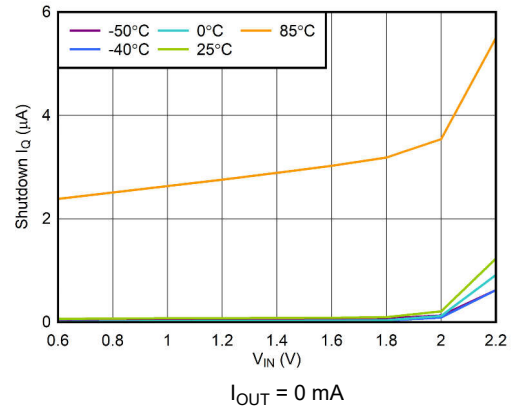

图 6-10.  $V_{\text{OUT}}$  Foldback Current Limit vs Output Current

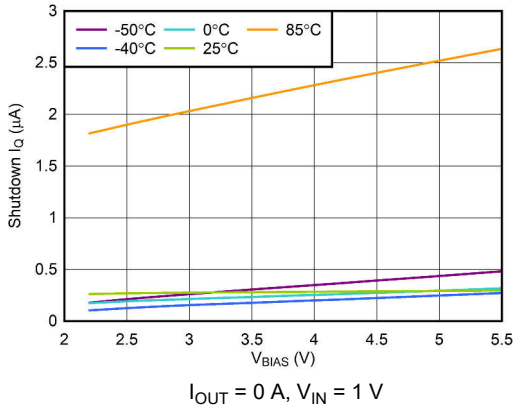

图 6-11. Enable Threshold vs Temperature

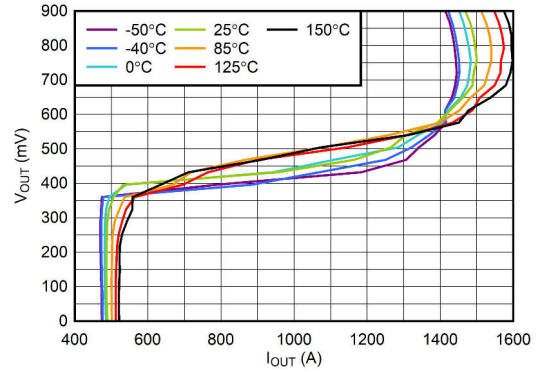

图 6-12.  $V_{\text{IN}}$  UVLO vs Temperature

### 6.7 Typical Characteristics (continued)

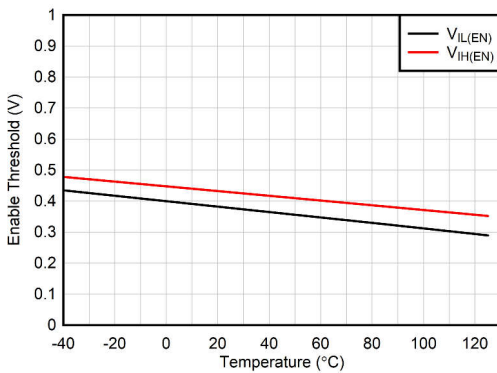
at operating temperature  $T_J = 25^\circ\text{C}$ ,  $V_{\text{OUT(NOM)}} = 0.8\text{ V}$ ,  $V_{\text{IN}} = V_{\text{OUT(NOM)}} + 0.1\text{ V}$ ,  $V_{\text{BIAS}} = V_{\text{OUT(NOM)}} + 1.4\text{ V}$ ,  $I_{\text{OUT}} = 1\text{ mA}$ ,  $V_{\text{EN}} = V_{\text{IN}}$ ,  $C_{\text{IN}} = 2.2\text{ }\mu\text{F}$ ,  $C_{\text{OUT}} = 2.2\text{ }\mu\text{F}$ , and  $C_{\text{BIAS}} = 0.47\text{ }\mu\text{F}$  (unless otherwise noted)

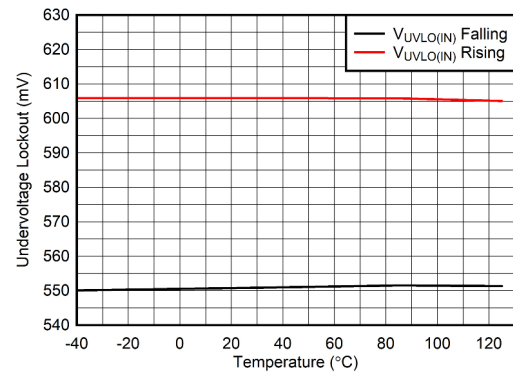

图 6-13.  $V_{\text{BIAS}}$  UVLO vs Temperature



$t_r = 1\text{ }\mu\text{s}$

图 6-14. Start-Up With  $V_{\text{BIAS}}$  Before  $V_{\text{IN}}$

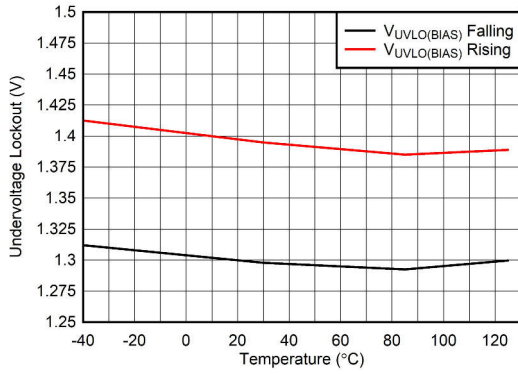
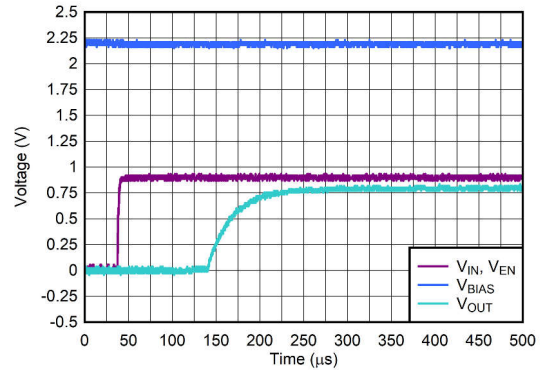
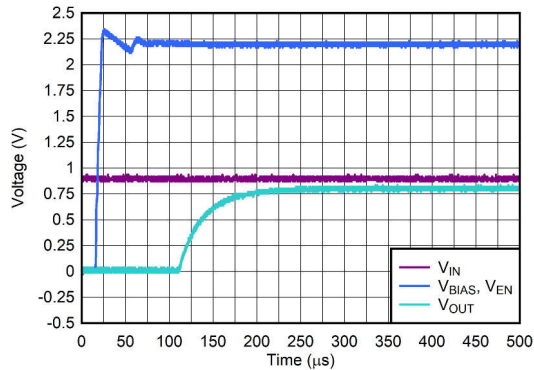

$t_r = 1\text{ }\mu\text{s}$

图 6-15. Start-Up With  $V_{\text{IN}}$  Before  $V_{\text{BIAS}}$  and  $V_{\text{EN}}$

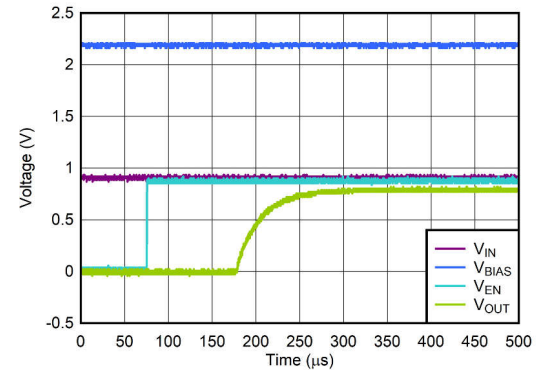

$t_r = 1\text{ }\mu\text{s}$

图 6-16. Start-Up With  $V_{\text{IN}}$  and  $V_{\text{BIAS}}$  Before  $V_{\text{EN}}$

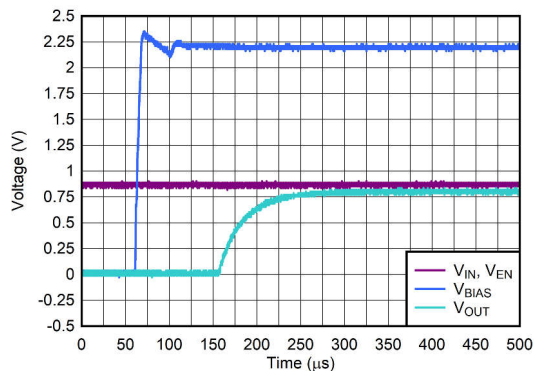

$t_r = 1\text{ }\mu\text{s}$

图 6-17. Start-Up With  $V_{\text{IN}}$  and  $V_{\text{EN}}$  Before  $V_{\text{BIAS}}$

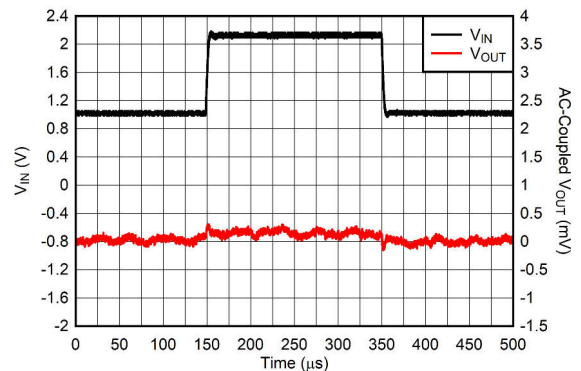

$t_r = t_f = 10\text{ }\mu\text{s}$ ,  $I_{\text{OUT}} = 1\text{ mA}$

图 6-18. Line Transient From 1 V to 2.2 V

### 6.7 Typical Characteristics (continued)

at operating temperature  $T_J = 25^\circ\text{C}$ ,  $V_{OUT(NOM)} = 0.8\text{ V}$ ,  $V_{IN} = V_{OUT(NOM)} + 0.1\text{ V}$ ,  $V_{BIAS} = V_{OUT(NOM)} + 1.4\text{ V}$ ,  $I_{OUT} = 1\text{ mA}$ ,  $V_{EN} = V_{IN}$ ,  $C_{IN} = 2.2\text{ }\mu\text{F}$ ,  $C_{OUT} = 2.2\text{ }\mu\text{F}$ , and  $C_{BIAS} = 0.47\text{ }\mu\text{F}$  (unless otherwise noted)

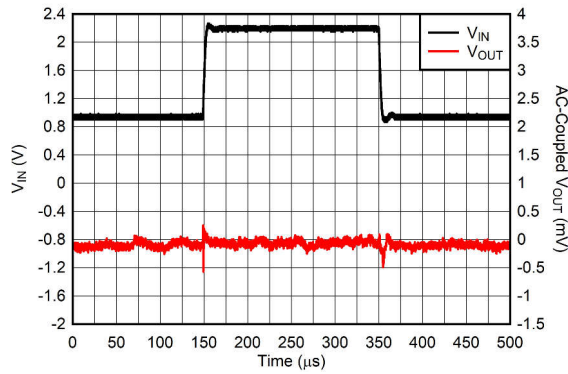

$t_r = t_f = 10\text{ }\mu\text{s}$ ,  $I_{OUT} = 500\text{ mA}$

图 6-19. Line Transient From 1 V to 2.2 V

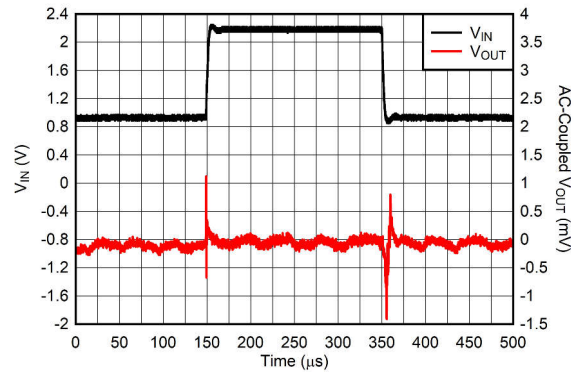

$t_r = t_f = 10\text{ }\mu\text{s}$ ,  $I_{OUT} = 1\text{ A}$

图 6-20. Line Transient From 1 V to 2.2 V

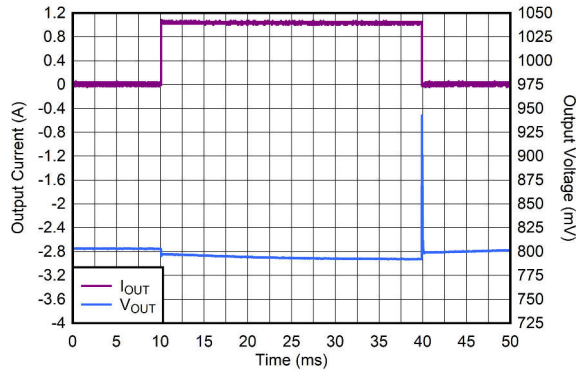

$t_r = t_f = 1\text{ }\mu\text{s}$

图 6-21. Load Transient From 100  $\mu\text{A}$  to 1 A

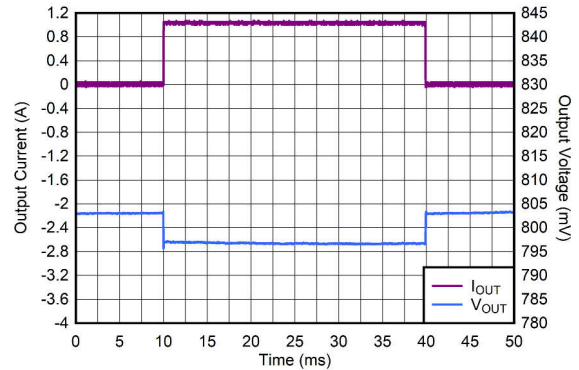

$t_r = t_f = 20\text{ }\mu\text{s}$

图 6-22. Load Transient From 100  $\mu\text{A}$  to 1 A

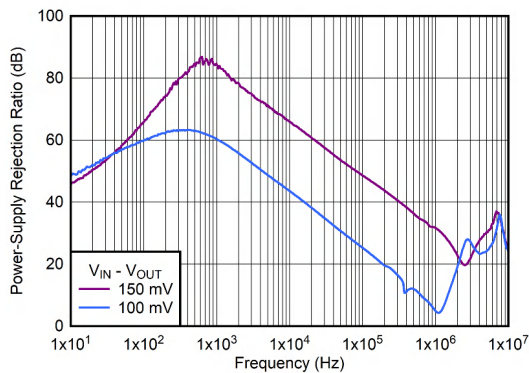

$C_{BIAS} = 0\text{ }\mu\text{F}$ ,  $I_{OUT} = 1\text{ A}$

图 6-23. PSRR vs Frequency and  $V_{IN} - V_{OUT}$

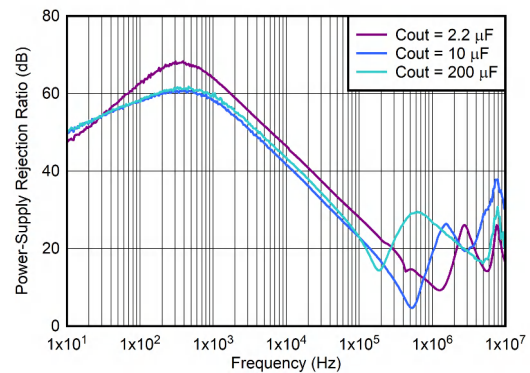

$C_{BIAS} = 0\text{ }\mu\text{F}$ ,  $I_{OUT} = 1\text{ A}$

图 6-24. PSRR vs Frequency and  $C_{OUT}$

### 6.7 Typical Characteristics (continued)

at operating temperature  $T_J = 25^\circ\text{C}$ ,  $V_{OUT(NOM)} = 0.8\text{ V}$ ,  $V_{IN} = V_{OUT(NOM)} + 0.1\text{ V}$ ,  $V_{BIAS} = V_{OUT(NOM)} + 1.4\text{ V}$ ,  $I_{OUT} = 1\text{ mA}$ ,  $V_{EN} = V_{IN}$ ,  $C_{IN} = 2.2\text{ }\mu\text{F}$ ,  $C_{OUT} = 2.2\text{ }\mu\text{F}$ , and  $C_{BIAS} = 0.47\text{ }\mu\text{F}$  (unless otherwise noted)



图 6-25. PSRR vs Frequency and  $I_{OUT}$



图 6-26. PSRR vs Frequency and  $V_{BIAS} - V_{OUT}$

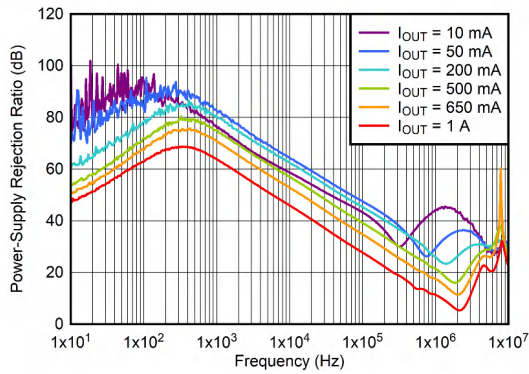

图 6-27. Output Noise vs Frequency and  $I_{OUT}$

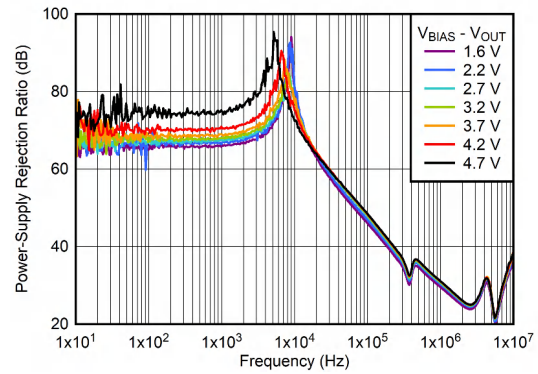

图 6-28. Output Noise vs Frequency and  $I_{OUT}$

## 7 Detailed Description

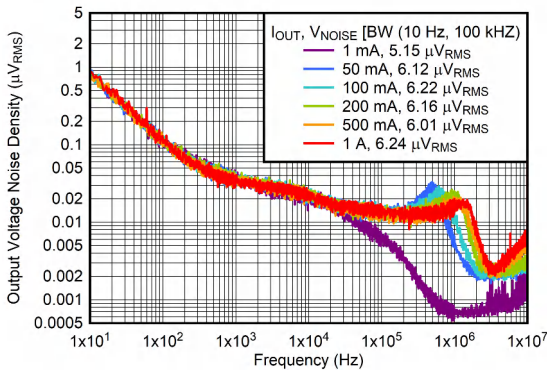
### 7.1 Overview

The TPS7A14 is a low-input, ultra-low dropout, low-quiescent-current linear regulator that is optimized for excellent transient performance. These characteristics make the device designed for most battery-powered applications. The low operating  $V_{IN} - V_{OUT}$ , combined with the BIAS pin, dramatically improve the efficiency of low-voltage output applications by powering the voltage reference and control circuitry and allowing the use of a pre-regulated, low-voltage input supply (IN) for the main power path. This low-dropout regulator (LDO) offers foldback current limit, shutdown, thermal protection, and an optional active discharge.

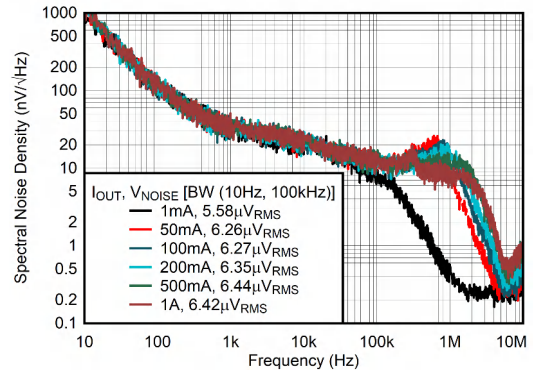
### 7.2 Functional Block Diagram

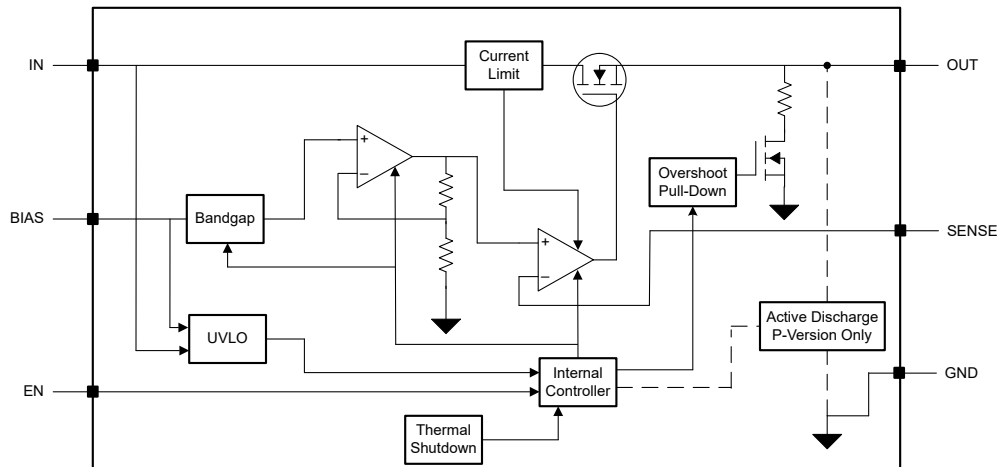

## 7.3 Feature Description

### 7.3.1 Excellent Transient Response

The TPS7A14 responds quickly to a change on the input supply (line transient) or the output current (load transient) given the device high input impedance and low output impedance across frequency. This same capability also means that this LDO has a high power-supply rejection ratio (PSRR) and, when coupled with a low internal noise floor ( $e_n$ ), the LDO can be used to create an excellent power supply with outstanding line and load transient performance.

The choice of external component values optimizes the transient response; see the [Input, Output, and Bias Capacitor Requirements](#) section for proper capacitor selection.

### 7.3.2 Global Undervoltage Lockout (UVLO)

The TPS7A14 uses two undervoltage lockout circuits: one on the BIAS pin and one on the IN pin to prevent the device from turning on before both  $V_{BIAS}$  and  $V_{IN}$  rise above their lockout voltages. The two UVLO signals are connected internally through an AND gate, as shown in [Figure 7-1](#), that turns off the device when the voltage on either input is below their respective UVLO thresholds.

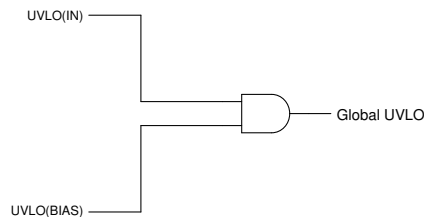

**图 7-1. Global UVLO circuit**

### 7.3.3 Enable Input

The enable input (EN) is active high. Applying a voltage greater than  $V_{EN(HI)}$  to EN enables the regulator output voltage, and applying a voltage less than  $V_{EN(LOW)}$  to EN disables the regulator output. If independent control of the output voltage is not needed, connect EN to either IN or BIAS.

### 7.3.4 Internal Foldback Current Limit

The device has an internal current limit circuit that protects the regulator during transient high-load current faults or shorting events. The current limit is a hybrid brick-wall foldback scheme. The current limit transitions from a brick-wall scheme to a foldback scheme at the foldback voltage ( $V_{FOLDBACK}$ ). In a high-load current fault with the output voltage above  $V_{FOLDBACK}$ , the brick-wall scheme limits the output current to the current limit ( $I_{CL}$ ). When the voltage drops below  $V_{FOLDBACK}$ , a foldback current limit activates that scales back the current as the output voltage approaches GND. When the output is shorted, the device supplies a typical current called the short-circuit current limit ( $I_{SC}$ ).  $I_{CL}$  and  $I_{SC}$  are listed in the [Electrical Characteristics](#) table.

For this device,  $V_{FOLDBACK}$  is approximately  $60\% \times V_{OUT(nom)}$ .

The output voltage is not regulated when the device is in current limit. When a current limit event occurs, the device begins to heat up because of the increase in power dissipation. When the device is in brick-wall current limit, the pass transistor dissipates power  $[(V_{IN} - V_{OUT}) \times I_{CL}]$ . When the device output is shorted and the output is below  $V_{FOLDBACK}$ , the pass transistor dissipates power  $[(V_{IN} - V_{OUT}) \times I_{SC}]$ . If thermal shutdown is triggered, the device turns off. After the device cools down, the internal thermal shutdown circuit turns the device back on. If the output current fault condition continues, the device cycles between current limit and thermal shutdown. For more information on current limits, see the [Know Your Limits application report](#).



图 7-2 shows a diagram of the foldback current limit.



图 7-2. Foldback Current Limit

### 7.3.5 Active Discharge

The active discharge function uses an internal MOSFET that connects a resistor ( $R_{PULLDOWN}$ ) to ground when the LDO is disabled in order to actively discharge the output voltage. The active discharge circuit is activated by driving EN to logic low to disable the device, when the voltage at IN or BIAS is below the UVLO threshold, or when the regulator is in thermal shutdown.

The discharge time after disabling the device depends on the output capacitance ( $C_{OUT}$ ) and the load resistance ( $R_L$ ) in parallel with the pull-down resistor.

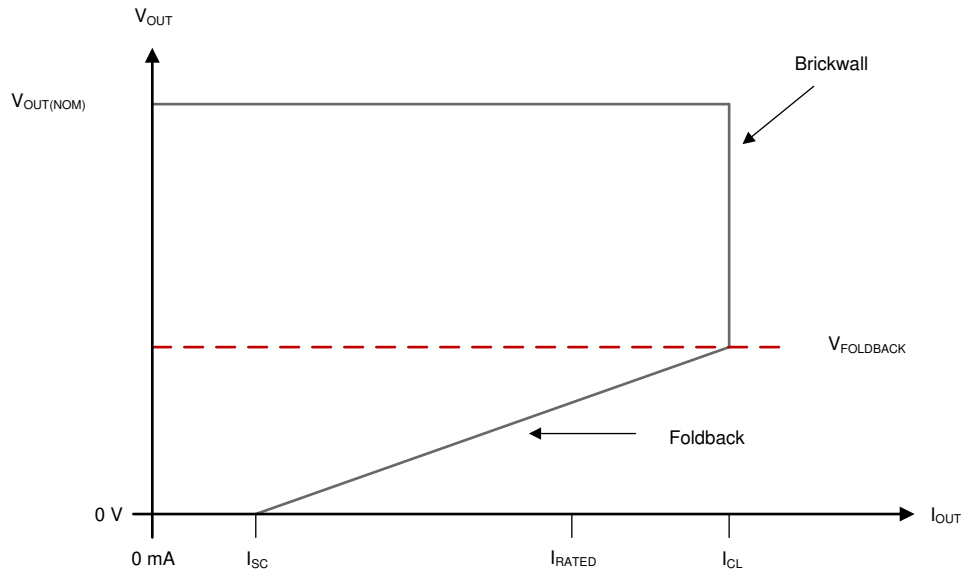
Do not rely on the active discharge circuit for discharging a large amount of output capacitance after the input supply has collapsed because reverse current can flow from the output to the input. This reverse current flow can cause damage to the device. Limit reverse current to no more than 5% of the rated output current for a short period of time.

### 7.3.6 Thermal Shutdown

The internal thermal shutdown protection circuit disables the output when the thermal junction temperature ( $T_J$ ) of the pass transistor rises to the thermal shutdown temperature threshold,  $T_{SD(shutdown)}$  (typical). The thermal shutdown circuit hysteresis makes sure that the LDO resets (turns on) when the temperature falls to  $T_{SD(reset)}$  (typical).

The thermal time constant of the semiconductor die is fairly short; thus, the device can cycle on and off when thermal shutdown is reached until the power dissipation is reduced. Power dissipation during start up can be high from large  $V_{IN} - V_{OUT}$  voltage drops across the device or from high inrush currents charging large output capacitors. Under some conditions, the thermal shutdown protection disables the device before start up completes.

For reliable operation, limit the junction temperature to the maximum listed in the [Recommended Operating Conditions](#) table. Operation above this maximum temperature causes the device to exceed operational specifications. Although the internal protection circuitry is designed to protect against thermal overload

conditions, this circuitry is not intended to replace proper heat sinking. Continuously running the regulator into thermal shutdown or above the maximum recommended junction temperature reduces long-term reliability.

## 7.4 Device Functional Modes

表 7-1 shows the conditions that lead to the different modes of operation. See the [Electrical Characteristics](#) table for parameter values.

表 7-1. Device Functional Mode Comparison

OPERATING MODE	PARAMETER				
	$V_{IN}$	$V_{BIAS}$	$V_{EN}$	$I_{OUT}$	$T_J$
Normal mode	$V_{IN} \geq V_{OUT(nom)} + V_{DO}$ and $V_{IN} \geq V_{IN(min)}$	$V_{BIAS} \geq V_{OUT} + V_{DO(BIAS)}$	$V_{EN} \geq V_{IH(EN)}$	$I_{OUT} < I_{CL}$	$T_J < T_{SD}$ for shutdown
Dropout mode	$V_{IN(min)} < V_{IN} < V_{OUT(nom)} + V_{DO(IN)}$	$V_{BIAS} < V_{OUT} + V_{DO(BIAS)}$	$V_{EN} > V_{IH(EN)}$	$I_{OUT} < I_{CL}$	$T_J < T_{SD}$ for shutdown
Disabled mode (any true condition disables the device)	$V_{IN} < V_{UVLO(IN)}$	$V_{BIAS} < V_{BIAS(UVLO)}$	$V_{EN} < V_{IL(EN)}$	—	$T_J \geq T_{SD}$ for shutdown

### 7.4.1 Normal Operation

The device regulates to the nominal output voltage when the following conditions are met:

- The input voltage is greater than the nominal output voltage plus the dropout voltage ( $V_{OUT(nom)} + V_{DO}$ )
- The bias voltage is greater than the nominal output voltage plus the dropout voltage ( $V_{OUT(nom)} + V_{DO}$ )
- The output current is less than the current limit ( $I_{OUT} < I_{CL}$ )
- The device junction temperature is less than the thermal shutdown temperature ( $T_J < T_{SD(shutdown)}$ )
- The enable voltage has previously exceeded the enable rising threshold voltage and has not yet decreased to less than the enable falling threshold

### 7.4.2 Dropout Operation

If the input voltage is lower than the nominal output voltage plus the specified dropout voltage, but all other conditions are met for normal operation, the device operates in dropout mode. Similarly, if the bias voltage is lower than the nominal output voltage plus the specified dropout voltage, but all other conditions are met for normal operation, the device operates in dropout mode as well. In this mode, the output voltage tracks the input voltage. During this mode, the transient performance of the device becomes significantly degraded because the pass transistor is in the ohmic or triode region, and acts as a switch. Line or load transients in dropout can result in large output voltage deviations.

When the device is in a steady dropout state, defined as when the device is in dropout, ( $V_{IN} < V_{OUT} + V_{DO}$  or  $V_{BIAS} < V_{OUT} + V_{DO}$  directly after being in normal regulation state, but not during start up), the pass transistor is driven into the ohmic or triode region. When the input voltage returns to a value greater than or equal to the nominal output voltage plus the dropout voltage ( $V_{OUT(NOM)} + V_{DO}$ ), the output voltage can overshoot for a short time when the device pulls the pass transistor back into the linear region.

### 7.4.3 Disable Mode

The output of the device can be shutdown by forcing the voltage of the enable pin to less than  $V_{IL(EN)}$  (see the [Electrical Characteristics](#) table). When disabled, the pass transistor is turned off, internal circuits are shutdown, and the output voltage is actively discharged to ground by an internal discharge circuit from the output to ground.

## 8 Application and Implementation

### 备注

以下应用部分中的信息不属于 TI 器件规格的范围，TI 不担保其准确性和完整性。TI 的客户应负责确定器件是否适用于其应用。客户应验证并测试其设计，以确保系统功能。

### 8.1 Application Information

Successfully implementing an LDO in a system depends on the system requirements. This section discusses key device features and how to best implement them to achieve a reliable design.

#### 8.1.1 Recommended Capacitor Types

The regulator is designed to be stable using low equivalent series resistance (ESR) ceramic capacitors at the input, output, and bias pins. Multilayer ceramic capacitors are the industry standard for use with LDOs, but must be used with good judgment. Ceramic capacitors that use X7R-, X5R-, and COG-rated dielectric materials provide relatively good capacitive stability across temperature, whereas the use of Y5V-rated capacitors is discouraged because of large variations in capacitance. Regardless of the ceramic capacitor type selected, ceramic capacitance varies with operating voltage and temperature. Generally, assume that effective capacitance decreases by as much as 50%. The input, output, and bias capacitors recommended in the [Recommended Operating Conditions](#) table account for an effective capacitance of approximately 50% of the nominal value.

#### 8.1.2 Input, Output, and Bias Capacitor Requirements

A minimum input ceramic capacitor is required for stability. A minimum output ceramic capacitor is also required for stability, see the [Recommended Operating Conditions](#) table for the minimum capacitors values.

The input capacitor counteracts reactive input sources and improves transient response, input ripple, and PSRR. A higher-value input capacitor can be necessary if large, fast rise-time load or line transients are anticipated, or if the device is located several inches from the input power source. Dynamic performance of the device is improved with the use of an output capacitor larger than the minimum value specified in the [Recommended Operating Conditions](#) table.

Although a bias capacitor is not required, good design practice is to connect a 0.1- $\mu$ F ceramic capacitor from BIAS to GND. This capacitor counteracts reactive bias source if the source impedance is not sufficiently low. Place the input, output, and bias capacitors as close as possible to the device to minimize trace parasitics.

If the BIAS source is susceptible to fast voltage drops (for example, a 2-V drop in less than 1  $\mu$ s) when the LDO load current is near the maximum value, the BIAS voltage drop can cause the output voltage to fall briefly. In such cases, use a BIAS capacitor large enough to slow the voltage ramp rate to less than 0.5 V/ $\mu$ s. For smaller or slower BIAS transients, any output voltage dips must be less than 5% of the nominal voltage.

#### 8.1.3 Dropout Voltage

Dropout voltage ( $V_{DO}$ ) is defined as the input voltage minus the output voltage ( $V_{IN} - V_{OUT}$ ) at the rated output current ( $I_{RATED}$ ), where the pass transistor is fully on.  $I_{RATED}$  is the maximum  $I_{OUT}$  listed in the [Recommended Operating Conditions](#) table. The pass transistor is in the ohmic or triode region of operation, and acts as a switch. The dropout voltage indirectly specifies a minimum input voltage greater than the nominal programmed output voltage at which the output voltage is expected to stay in regulation. If the input voltage falls to less than the nominal output regulation, then the output voltage falls as well.

For a CMOS regulator, the dropout voltage is determined by the drain-source on-state resistance ( $R_{DS(ON)}$ ) of the pass transistor. Therefore, if the linear regulator operates at less than the rated current, the dropout voltage for that current scales accordingly. Use [方程式 1](#) to calculate the  $R_{DS(ON)}$  of the device.

$$R_{DS(ON)} = \frac{V_{DO}}{I_{RATED}} \quad (1)$$

The use of bias rail enables the TPS7A14 to achieve a lower dropout voltage between IN and OUT. However, a minimum bias voltage above the nominal programmed output voltage must be maintained. 图 6-13 specifies the minimum  $V_{BIAS}$  headroom required to maintain output regulation.

#### 8.1.4 Behavior During Transition From Dropout Into Regulation

Some applications can have transients that place this device into dropout, especially when this device can be powered from a battery with relatively high ESR. The load transient saturates the output stage of the error amplifier when the pass transistor is driven fully on, making the pass transistor function like a resistor from  $V_{IN}$  to  $V_{OUT}$ . The error amplifier response time to this load transient is extended because the error amplifier must first recover from saturation and then must place the pass transistor back into active mode. During this recovery period,  $V_{OUT}$  overshoots because the pass transistor is functioning as a resistor from  $V_{IN}$  to  $V_{OUT}$ .

When  $V_{IN}$  ramps up slowly for start up, the slow ramp-up voltage can place the device in dropout. As with many other LDOs, the output can overshoot on recovery from this condition. However, this condition is easily avoided through the use of the enable signal.

If operating under these conditions, apply a higher dc load current or increase the output capacitance to reduce the overshoot. These approaches provide a path to absorb the excess charge.

#### 8.1.5 Device Enable Sequencing Requirement

The IN, BIAS, and EN pin voltages can be sequenced in any order without causing damage to the device. Start up is always monotonic regardless of the sequencing order or the ramp rates of the IN, BIAS, and EN pins. See the [Recommended Operating Conditions](#) table for proper voltage ranges of the IN, BIAS, and EN pins.

#### 8.1.6 Load Transient Response

The load-step transient response is the output voltage response by the LDO to a step in load current while output voltage regulation is maintained. See 图 6-21 and 图 6-22 for typical load transient response plots. There are two key transitions during a load transient response: the transition from a light to a heavy load, and the transition from a heavy to a light load. The regions in 图 8-1 are broken down as described in this section. Regions A, E, and H are where the output voltage is in steady-state operation.



图 8-1. Load Transient Waveform

During transitions from a light load to a heavy load, the following behavior can be observed:

- The initial voltage dip is a result of the depletion of the output capacitor charge and parasitic impedance to the output capacitor (region B)
- Recovery from the dip results from the LDO increasing the sourcing current, and leads to output voltage regulation (region C)

During transitions from a heavy load to a light load, the following behavior can be observed:

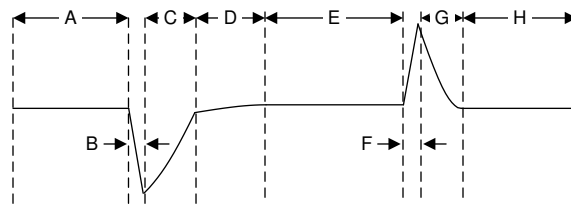
- The initial voltage rise results from the LDO sourcing a large current, and leads to an increase in the output capacitor charge (region F)
- Recovery from the rise results from the LDO decreasing the sourcing current in combination with the load discharging the output capacitor (region G)

A larger output capacitance reduces the peaks during a load transient but slows down the response time of the device. A larger dc load also reduces the peaks because the amplitude of the transition is lowered and a higher current discharge path is provided for the output capacitor.

### 8.1.7 Undervoltage Lockout Circuit Operation

The  $V_{IN}$  UVLO circuit makes sure that the regulator remains disabled when the input supply voltage is below the minimum operational voltage range, and makes sure that the regulator shuts down when the input supply collapses. Similarly, the  $V_{BIAS}$  UVLO circuit makes sure that the regulator remains disabled when the bias supply voltage is less than the minimum operational voltage range, and makes sure that the regulator shuts down when the bias supply collapses.

图 8-2 shows the UVLO circuit response to various input or bias voltage events. The diagram can be separated into the following parts:

- Region A: The output remains off while the input or bias voltage is below the UVLO rising threshold
- Region B: Normal operation, regulating device
- Region C: Brownout event above the UVLO falling threshold (UVLO rising threshold - UVLO hysteresis). The output can possibly fall out of regulation but the device remains enabled.
- Region D: Normal operation, regulating device
- Region E: Brownout event below the UVLO falling threshold. The device is disabled in most cases and the output falls as a result of the load and active discharge circuit. The device is re-enabled when the UVLO rising threshold is reached and a normal start up follows.
- Region F: Normal operation followed by the input or bias falling to the UVLO falling threshold
- Region G: The device is disabled when the input or bias voltages fall below the UVLO falling threshold to 0 V. The output falls as a result of the load and active discharge circuit.



图 8-2. Typical  $V_{IN}$  or  $V_{BIAS}$  UVLO Circuit Operation

### 8.1.8 Power Dissipation ( $P_D$ )

Circuit reliability demands that proper consideration be given to device power dissipation, location of the circuit on the printed circuit board (PCB), and correct sizing of the thermal plane. The PCB area around the regulator must be as free as possible of other heat-generating devices that cause added thermal stresses.

方程式 2 calculates the maximum allowable power dissipation for the device in a given package:

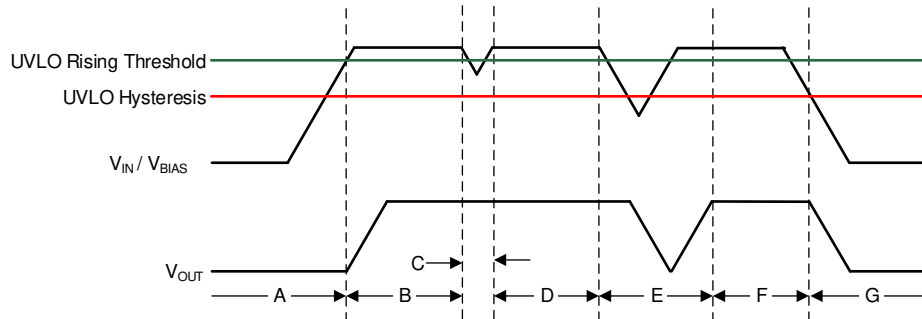
$$P_{D-MAX} = [(T_J - T_A) / R_{\theta JA}] \quad (2)$$

方程式 3 represents the actual power being dissipated in the device:

$$P_D = ((I_{GND(IN)} + I_{IN}) \times V_{IN} + I_{GND(BIAS)} \times V_{BIAS}) - (I_{OUT} \times V_{OUT}) \quad (3)$$

If the load current is much greater than  $I_{GND(IN)}$  and  $I_{GND(BIAS)}$  方程式 3 can be simplified as:

$$P_D = (V_{IN} - V_{OUT}) \times I_{OUT} \quad (4)$$

Power dissipation can be minimized, and thus greater efficiency achieved, by proper selection of the system voltage rails. Proper selection allows the minimum input-to-output voltage differential to be obtained. The low dropout of the TPS7A14 allows for maximum efficiency across a wide range of output voltages.

The main heat conduction path depends on the ambient temperature and the thermal resistance across the various interfaces between the die junction and ambient air.

The maximum allowable junction temperature ( $T_J$ ) determines the maximum power dissipation for the device. According to [方程式 5](#), maximum power dissipation and junction temperature are most often related by the junction-to-ambient thermal resistance ( $R_{\theta JA}$ ) of the combined PCB and device package and the temperature of the ambient air ( $T_A$ ). The equation is rearranged in [方程式 6](#) for output current.

$$T_J = T_A + (R_{\theta JA} \times P_D) \quad (5)$$

$$I_{OUT} = (T_J - T_A) / [R_{\theta JA} \times (V_{IN} - V_{OUT})] \quad (6)$$

Unfortunately, this thermal resistance ( $R_{\theta JA}$ ) is highly dependent on the heat-spreading capability built into the particular PCB design, and therefore varies according to the total copper area, copper weight, and location of the planes. The  $R_{\theta JA}$  recorded in the [Electrical Characteristics](#) table is determined by the JEDEC standard, PCB, and copper-spreading area, and is only used as a relative measure of package thermal performance. For a well-designed thermal layout,  $R_{\theta JA}$  is actually the sum of the YBK package junction-to-case (bottom) thermal resistance ( $R_{\theta JC(bot)}$ ) plus the thermal resistance contribution by the PCB copper.

### 8.1.9 Estimating Junction Temperature

The JEDEC standard now recommends the use of psi ( $\Psi$ ) thermal metrics to estimate the junction temperatures of the LDO when in-circuit on a typical PCB board application. These metrics are not strictly speaking thermal resistances, but rather offer practical and relative means of estimating junction temperatures. These psi metrics are determined to be significantly independent of the copper-spreading area. The key thermal metrics ( $\Psi_{JT}$  and  $\Psi_{JB}$ ) are used in accordance with [方程式 7](#) and are given in the [Electrical Characteristics](#) table.

$$\Psi_{JT} : T_J = T_T + \Psi_{JT} \times P_D \text{ and } \Psi_{JB} : T_J = T_B + \Psi_{JB} \times P_D \quad (7)$$

where:

- $P_D$  is the power dissipated as explained in [方程式 3](#) and the [Power Dissipation \( \$P\_D\$ \)](#) section
- $T_T$  is the temperature at the center-top of the device package
- $T_B$  is the PCB surface temperature measured 1 mm from the device package and centered on the package edge

### 8.1.10 Recommended Area for Continuous Operation

The operational area of an LDO is limited by the dropout voltage, output current, junction temperature, and input voltage. The recommended area for continuous operation for a linear regulator is provided in [图 8-3](#) and can be separated into the following regions:

- Dropout voltage limits the minimum differential voltage between the input and the output ( $V_{IN} - V_{OUT}$ ) at a given output current level; see the [Dropout Operation](#) section for more details.
- The rated output current limits the maximum recommended output current level. Exceeding this rating causes the device to fall out of specification.
- The rated junction temperature limits the maximum junction temperature of the device. Exceeding this rating causes the device to fall out of specification and reduces long-term reliability.
  - [方程式 6](#) provides the shape of the slope. The slope is nonlinear because the maximum rated junction temperature of the LDO is controlled by the power dissipation across the LDO, thus when  $V_{IN} - V_{OUT}$  increases the output current must decrease.
- The rated input voltage range governs both the minimum and maximum of  $V_{IN} - V_{OUT}$ .



图 8-3. Continuous Operation Diagram With Description of Regions

## 8.2 Typical Application

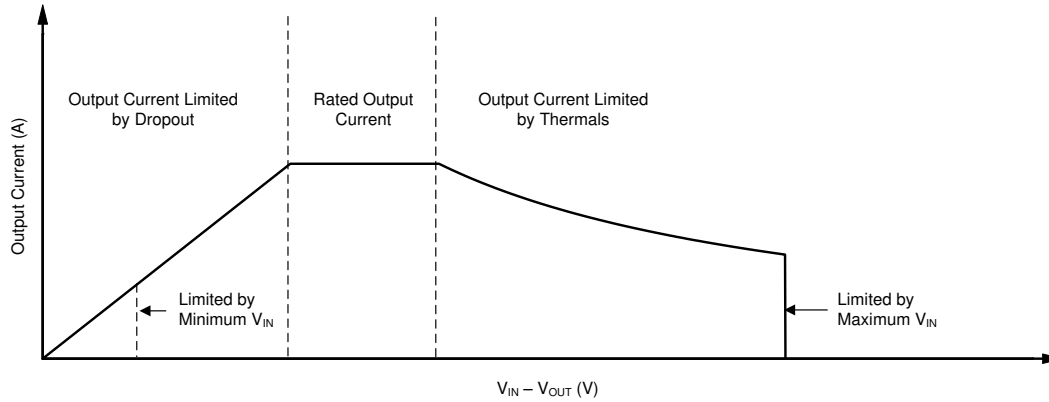

图 8-4. High-Efficiency Supply From a Rechargeable Battery

### 8.2.1 Design Requirements

表 8-1 lists the parameters for this design example.

表 8-1. Design Parameters

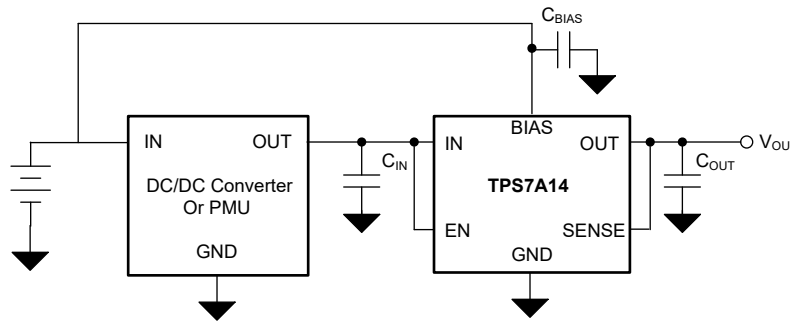
DESIGN PARAMETER	EXAMPLE VALUE
$V_{IN}$	0.95 V
$V_{BIAS}$	2.4 V to 5.5 V
$V_{OUT}$	0.8 V
$I_{OUT}$	600 mA (typical), 900 mA (peak)

### 8.2.2 Detailed Design Procedure

This design example is powered by a rechargeable battery that can be a building block in many portable applications. Noise-sensitive portable electronics require an efficient, small-size solution for their power supply. Traditional LDOs are known for their low efficiency in contrast to low-input, low-output voltage (LILO) LDOs such as the TPS7A14. The use of a bias rail in the TPS7A14 allows the main power path of the LDO to operate at a lower input voltage, thus reducing the voltage drop across the pass transistor and maximizing device efficiency. Because the voltage drop across the pass transistor can be so low, the efficiency of the TPS7A14 can approximate that of a dc-dc converter. 方程式 8 calculates the efficiency for this design.

$$\text{Efficiency} = \eta = P_{OUT} / P_{IN} \times 100 \% = (V_{OUT} \times I_{OUT}) / (V_{IN} \times I_{IN} + V_{BIAS} \times I_{BIAS}) \times 100 \% \quad (8)$$

方程式 8 reduces to 方程式 9 because the design example load current is much greater than the quiescent current of the bias rail.

$$\text{Efficiency} = \eta = (V_{\text{OUT}} \times I_{\text{OUT}}) / (V_{\text{IN}} \times I_{\text{IN}}) \times 100\% \quad (9)$$



### 8.2.3 Application Curve

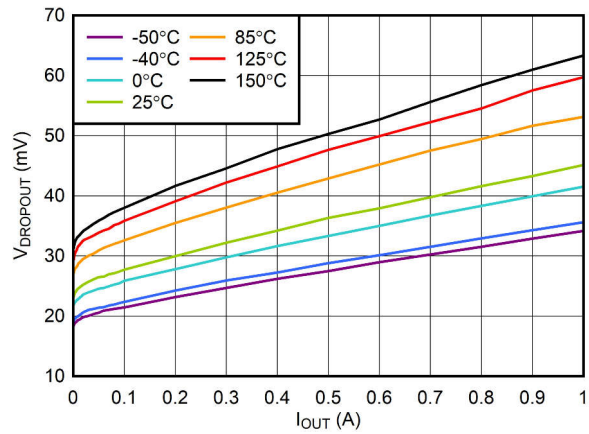

$$V_{BIAS} = V_{OUT(NOM)} + 1.4 \text{ V}, V_{EN} = V_{IN}, C_{IN} = 2.2 \mu\text{F}, C_{OUT} = 2.2 \mu\text{F}, \text{ and } C_{BIAS} = 0.47 \mu\text{F}$$

图 8-5. V<sub>IN</sub> Dropout Voltage vs I<sub>OUT</sub>

### 8.3 Power Supply Recommendations

This device is designed to operate from an input supply voltage range of 0.6 V to 2.2 V and a bias supply voltage range of 1.5 V to 5.5 V. The input and bias supplies must be well regulated and free of spurious noise. To make sure that the output voltage is well regulated and dynamic performance is optimum, the input supply must be at least  $V_{OUT(nom)} + V_{DO}$  and  $V_{BIAS} = V_{OUT(nom)} + V_{DO(BIAS)}$ .

## 8.4 Layout

### 8.4.1 Layout Guidelines

For correct printed circuit board (PCB) layout, follow these guidelines:

- Place input, output, and bias capacitors as close to the device as possible
- Use copper planes for device connections to optimize thermal performance
- Place thermal vias around the device to distribute heat

### 8.4.2 Layout Examples



图 8-6. Recommended Layout (YBK Package)



图 8-7. Recommended Layout (DRV Package)

## 9 Device and Documentation Support

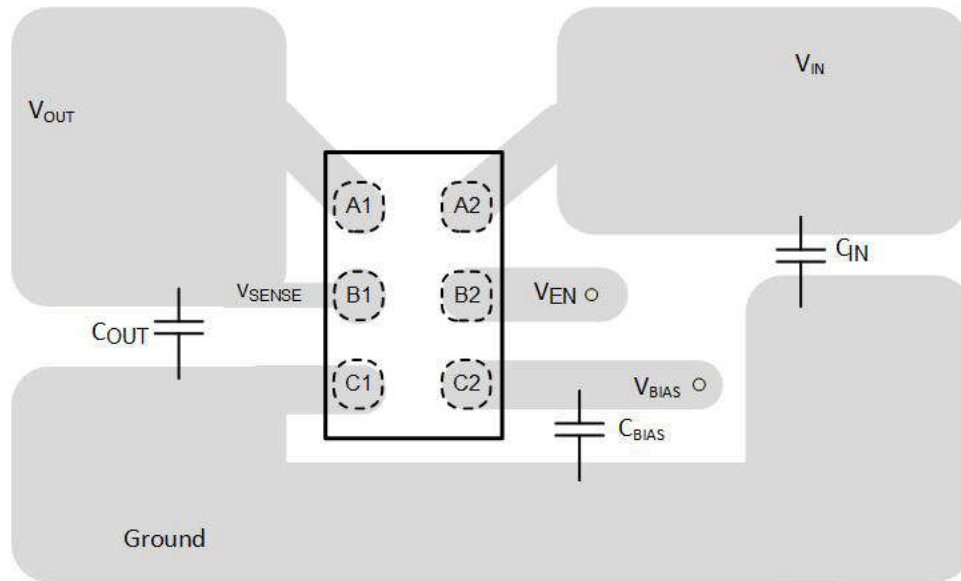
### 9.1 Device Support

#### 9.1.1 Development Support

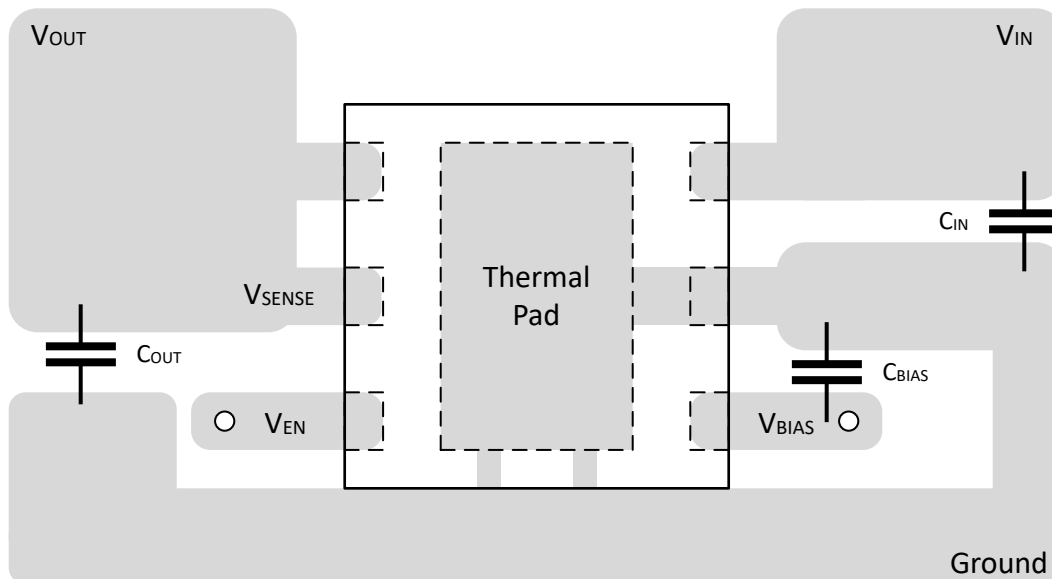
##### 9.1.1.1 Evaluation Module

An evaluation module (EVM) is available to assist in the initial circuit performance evaluation using the TPS7A14. The EVM can be requested at the Texas Instruments web site through the [product folder](#) or purchased directly from the TI eStore.

#### 9.1.2 Device Nomenclature

**表 9-1. Device Nomenclature<sup>(1)(2)</sup>**

PRODUCT	DESCRIPTION
TPS7A14xx(x)(P)yyyz	<p><b>xx(x)</b> is the nominal output voltage. Two or more digits are used in the ordering number (for example, 09 = 0.9 V, 95 = 0.95 V, 125 = 1.25 V).</p> <p><b>P</b> indicates active pull down; if there is no P, then the device does not have the active pull down feature.</p> <p><b>yyy</b> is the package designator.</p> <p><b>z</b> is the package quantity. R indicates reel (12000 pieces for YBK package; 3000 pieces for DRV package).</p>

- (1) For the most current package and ordering information see the Package Option Addendum at the end of this document, or visit the device product folder on [www.ti.com](http://www.ti.com).
- (2) Output voltages from 0.5 V to 2.0 V in 25-mV increments are available. Contact the factory for details and availability.

## 9.2 Documentation Support

### 9.2.1 Related Documentation

For related documentation see the following:

- Texas Instruments, [Using New Thermal Metrics application report](#)
- Texas Instruments, [AN-1112 DSBGA Wafer Level Chip Scale Package application report](#)
- Texas Instruments, [TPS7A14EVM-058 Evaluation Module user guide](#)

## 9.3 接收文档更新通知

要接收文档更新通知，请导航至 [ti.com](http://ti.com) 上的器件产品文件夹。点击 [订阅更新](#) 进行注册，即可每周接收产品信息更改摘要。有关更改的详细信息，请查看任何已修订文档中包含的修订历史记录。

## 9.4 支持资源

[TI E2E™ 支持论坛](#) 是工程师的重要参考资料，可直接从专家获得快速、经过验证的解答和设计帮助。搜索现有解答或提出自己的问题可获得所需的快速设计帮助。

链接的内容由各个贡献者“按原样”提供。这些内容并不构成 TI 技术规范，并且不一定反映 TI 的观点；请参阅 TI 的 [《使用条款》](#)。

## 9.5 Trademarks

TI E2E™ is a trademark of Texas Instruments.

所有商标均为其各自所有者的财产。

## 9.6 静电放电警告



静电放电 (ESD) 会损坏这个集成电路。德州仪器 (TI) 建议通过适当的预防措施处理所有集成电路。如果不遵守正确的处理和安装程序，可能会损坏集成电路。

ESD 的损坏小至导致微小的性能降级，大至整个器件故障。精密的集成电路可能更容易受到损坏，这是因为非常细微的参数更改都可能会导致器件与其发布的规格不相符。

## 9.7 术语表

[TI 术语表](#) 本术语表列出并解释了术语、首字母缩略词和定义。

## Mechanical, Packaging, and Orderable Information

The following pages include mechanical, packaging, and orderable information. This information is the most current data available for the designated devices. This data is subject to change without notice and revision of this document. For browser-based versions of this data sheet, refer to the left-hand navigation.

10.1 Mechanical Data

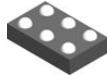

**YBK0006-C02**

**PACKAGE OUTLINE**

**DSBGA - 0.33 mm max height**

DIE SIZE BALL GRID ARRAY

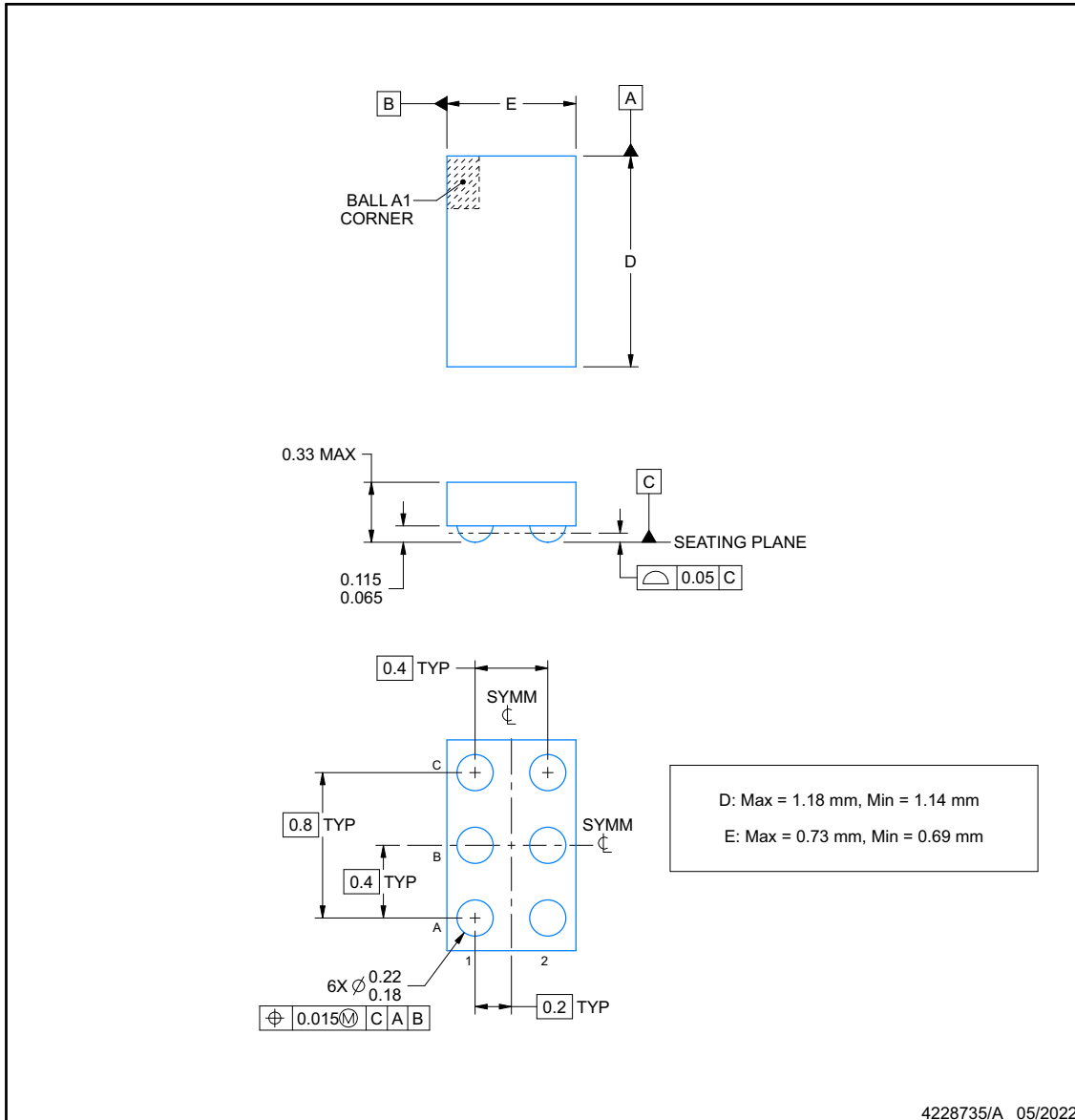

NOTES:

1. All linear dimensions are in millimeters. Any dimensions in parenthesis are for reference only. Dimensioning and tolerancing per ASME Y14.5M.
2. This drawing is subject to change without notice.

## EXAMPLE BOARD LAYOUT

**YBK0006-C02**

**DSBGA - 0.33 mm max height**

DIE SIZE BALL GRID ARRAY

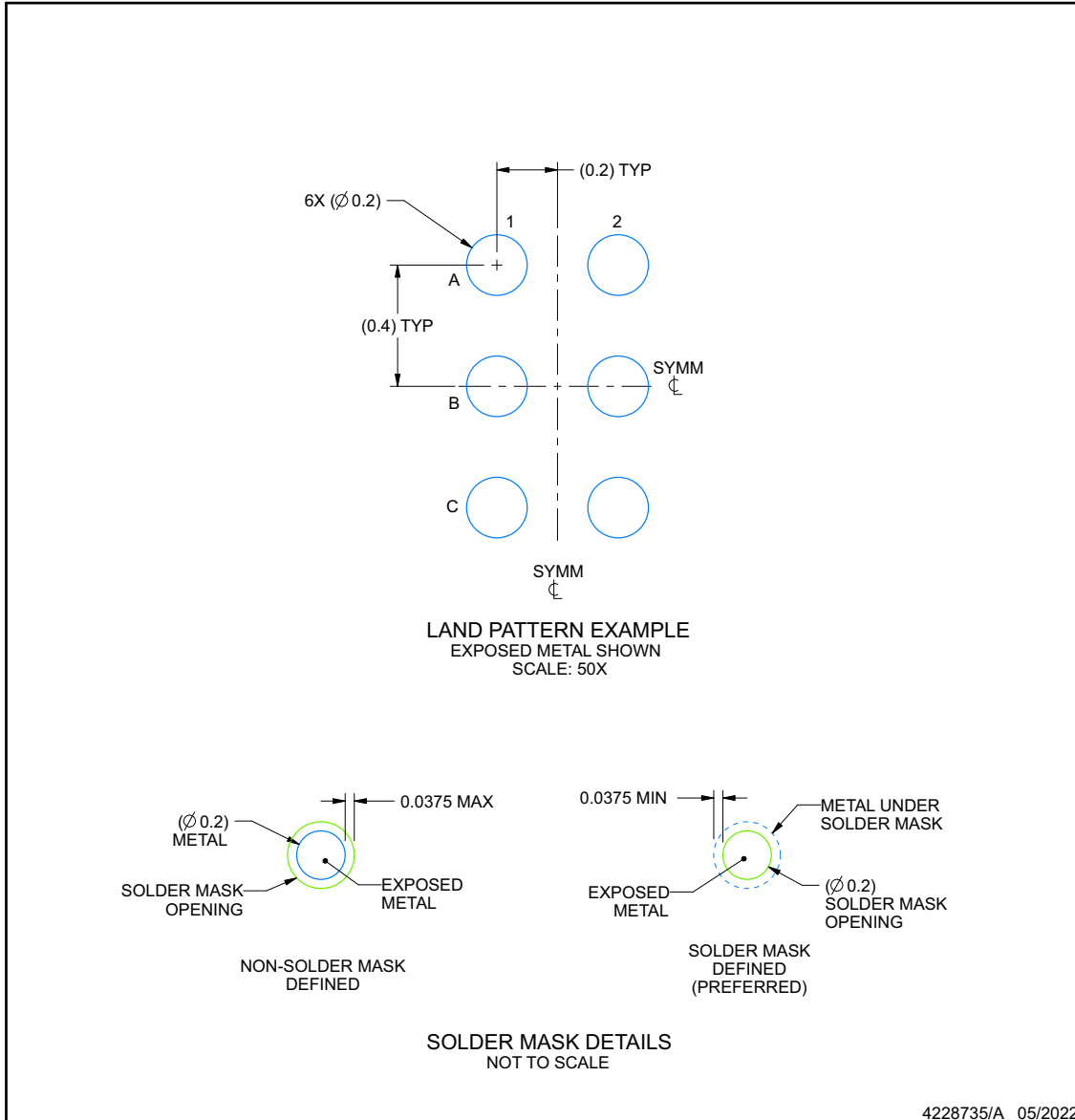

NOTES: (continued)

- Final dimensions may vary due to manufacturing tolerance considerations and also routing constraints. See Texas Instruments Literature No. SNVA009 ([www.ti.com/lit/snva009](http://www.ti.com/lit/snva009)).

## EXAMPLE STENCIL DESIGN

**YBK0006-C02**

**DSBGA - 0.33 mm max height**

DIE SIZE BALL GRID ARRAY

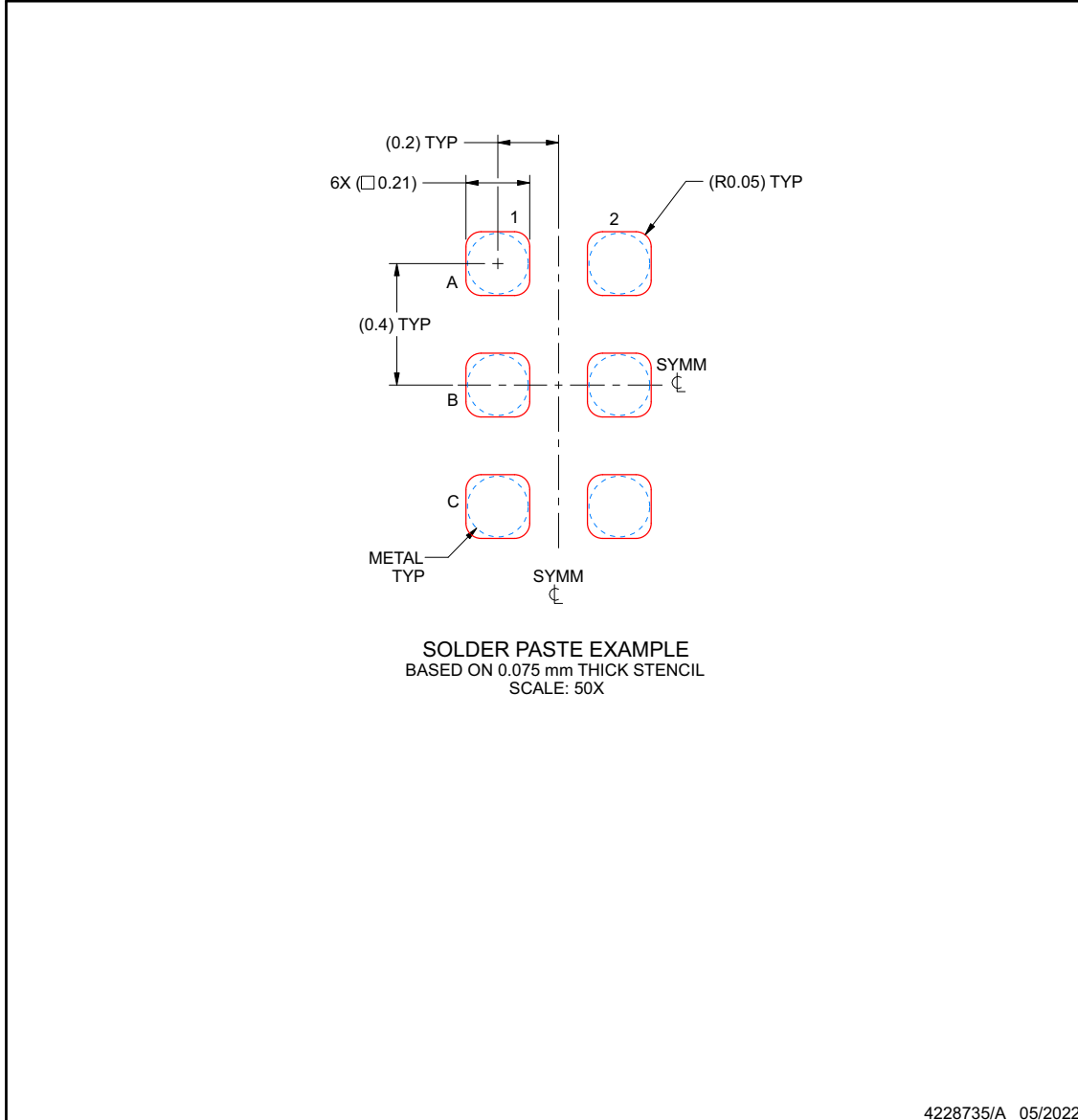

NOTES: (continued)

4. Laser cutting apertures with trapezoidal walls and rounded corners may offer better paste release.

**PACKAGING INFORMATION**

Orderable Device	Status (1)	Package Type	Package Drawing	Pins	Package Qty	Eco Plan (2)	Lead finish/ Ball material (6)	MSL Peak Temp (3)	Op Temp (°C)	Device Marking (4/5)	Samples
TPS7A1408PDRVR	ACTIVE	WSON	DRV	6	3000	RoHS & Green	NIPDAU	Level-1-260C-UNLIM	-40 to 125	33PH	<a href="#">Samples</a>
TPS7A1408PYBKR	ACTIVE	DSBGA	YBK	6	12000	RoHS & Green	SNAGCU	Level-1-260C-UNLIM	-40 to 125	M8	<a href="#">Samples</a>
TPS7A1409PDRVR	ACTIVE	WSON	DRV	6	3000	RoHS & Green	NIPDAU	Level-1-260C-UNLIM	-40 to 125	33QH	<a href="#">Samples</a>
TPS7A1409PYBKR	ACTIVE	DSBGA	YBK	6	12000	RoHS & Green	SNAGCU	Level-1-260C-UNLIM	-40 to 125	MD	<a href="#">Samples</a>
TPS7A14105PDRVR	ACTIVE	WSON	DRV	6	3000	RoHS & Green	NIPDAU	Level-1-260C-UNLIM	-40 to 125	33SH	<a href="#">Samples</a>
TPS7A1410PDRVR	ACTIVE	WSON	DRV	6	3000	RoHS & Green	NIPDAU	Level-1-260C-UNLIM	-40 to 125	33RH	<a href="#">Samples</a>
TPS7A1411PYBKR	ACTIVE	DSBGA	YBK	6	12000	RoHS & Green	SNAGCU	Level-1-260C-UNLIM	-40 to 125	P6	<a href="#">Samples</a>
TPS7A1412PDRVR	ACTIVE	WSON	DRV	6	3000	RoHS & Green	NIPDAU	Level-1-260C-UNLIM	-40 to 125	33UH	<a href="#">Samples</a>
TPS7A1412PYBKR	ACTIVE	DSBGA	YBK	6	12000	RoHS & Green	SNAGCU	Level-1-260C-UNLIM	-40 to 125	MG	<a href="#">Samples</a>
TPS7A1413PYBKR	ACTIVE	DSBGA	YBK	6	12000	RoHS & Green	SNAGCU	Level-1-260C-UNLIM	-40 to 125	MH	<a href="#">Samples</a>
TPS7A1418PDRVR	ACTIVE	WSON	DRV	6	3000	RoHS & Green	NIPDAU	Level-1-260C-UNLIM	-40 to 125	33WH	<a href="#">Samples</a>
TPS7A1485PYBKR	ACTIVE	DSBGA	YBK	6	12000	RoHS & Green	SNAGCU	Level-1-260C-UNLIM	-40 to 125	M9	<a href="#">Samples</a>

(1) The marketing status values are defined as follows:

**ACTIVE:** Product device recommended for new designs.

**LIFEBUY:** TI has announced that the device will be discontinued, and a lifetime-buy period is in effect.

**NRND:** Not recommended for new designs. Device is in production to support existing customers, but TI does not recommend using this part in a new design.

**PREVIEW:** Device has been announced but is not in production. Samples may or may not be available.

**OBSELETE:** TI has discontinued the production of the device.

(2) **RoHS:** TI defines "RoHS" to mean semiconductor products that are compliant with the current EU RoHS requirements for all 10 RoHS substances, including the requirement that RoHS substance do not exceed 0.1% by weight in homogeneous materials. Where designed to be soldered at high temperatures, "RoHS" products are suitable for use in specified lead-free processes. TI may reference these types of products as "Pb-Free".

**RoHS Exempt:** TI defines "RoHS Exempt" to mean products that contain lead but are compliant with EU RoHS pursuant to a specific EU RoHS exemption.

**Green:** TI defines "Green" to mean the content of Chlorine (Cl) and Bromine (Br) based flame retardants meet JS709B low halogen requirements of <=1000ppm threshold. Antimony trioxide based flame retardants must also meet the <=1000ppm threshold requirement.



- (3) MSL, Peak Temp. - The Moisture Sensitivity Level rating according to the JEDEC industry standard classifications, and peak solder temperature.
- (4) There may be additional marking, which relates to the logo, the lot trace code information, or the environmental category on the device.
- (5) Multiple Device Markings will be inside parentheses. Only one Device Marking contained in parentheses and separated by a "~" will appear on a device. If a line is indented then it is a continuation of the previous line and the two combined represent the entire Device Marking for that device.
- (6) Lead finish/Ball material - Orderable Devices may have multiple material finish options. Finish options are separated by a vertical ruled line. Lead finish/Ball material values may wrap to two lines if the finish value exceeds the maximum column width.

**Important Information and Disclaimer:**The information provided on this page represents TI's knowledge and belief as of the date that it is provided. TI bases its knowledge and belief on information provided by third parties, and makes no representation or warranty as to the accuracy of such information. Efforts are underway to better integrate information from third parties. TI has taken and continues to take reasonable steps to provide representative and accurate information but may not have conducted destructive testing or chemical analysis on incoming materials and chemicals. TI and TI suppliers consider certain information to be proprietary, and thus CAS numbers and other limited information may not be available for release.

In no event shall TI's liability arising out of such information exceed the total purchase price of the TI part(s) at issue in this document sold by TI to Customer on an annual basis.

**TAPE AND REEL INFORMATION**

**QUADRANT ASSIGNMENTS FOR PIN 1 ORIENTATION IN TAPE**

\*All dimensions are nominal

Device	Package Type	Package Drawing	Pins	SPQ	Reel Diameter (mm)	Reel Width W1 (mm)	A0 (mm)	B0 (mm)	K0 (mm)	P1 (mm)	W (mm)	Pin1 Quadrant
TPS7A1408PDRVR	WSO	DRV	6	3000	180.0	8.4	2.3	2.3	1.15	4.0	8.0	Q2
TPS7A1408PYBKR	DSBGA	YBK	6	12000	180.0	8.4	0.8	1.26	0.36	2.0	8.0	Q1
TPS7A1408PYBKR	DSBGA	YBK	6	12000	180.0	8.4	0.8	1.26	0.36	2.0	8.0	Q1
TPS7A1409PDRVR	WSO	DRV	6	3000	180.0	8.4	2.3	2.3	1.15	4.0	8.0	Q2
TPS7A1409PYBKR	DSBGA	YBK	6	12000	180.0	8.4	0.8	1.26	0.36	2.0	8.0	Q1
TPS7A1409PYBKR	DSBGA	YBK	6	12000	180.0	8.4	0.81	1.26	0.36	2.0	8.0	Q1
TPS7A14105PDRVR	WSO	DRV	6	3000	180.0	8.4	2.3	2.3	1.15	4.0	8.0	Q2
TPS7A1410PDRVR	WSO	DRV	6	3000	180.0	8.4	2.3	2.3	1.15	4.0	8.0	Q2
TPS7A1411PYBKR	DSBGA	YBK	6	12000	180.0	8.4	0.8	1.26	0.36	2.0	8.0	Q1
TPS7A1412PDRVR	WSO	DRV	6	3000	180.0	8.4	2.3	2.3	1.15	4.0	8.0	Q2
TPS7A1412PYBKR	DSBGA	YBK	6	12000	180.0	8.4	0.8	1.26	0.36	2.0	8.0	Q1
TPS7A1412PYBKR	DSBGA	YBK	6	12000	180.0	8.4	0.8	1.26	0.36	2.0	8.0	Q1
TPS7A1413PYBKR	DSBGA	YBK	6	12000	180.0	8.4	0.81	1.26	0.36	2.0	8.0	Q1
TPS7A1413PYBKR	DSBGA	YBK	6	12000	180.0	8.4	0.8	1.26	0.36	2.0	8.0	Q1
TPS7A1418PDRVR	WSO	DRV	6	3000	180.0	8.4	2.3	2.3	1.15	4.0	8.0	Q2
TPS7A1485PYBKR	DSBGA	YBK	6	12000	180.0	8.4	0.8	1.26	0.36	2.0	8.0	Q1

Device	Package Type	Package Drawing	Pins	SPQ	Reel Diameter (mm)	Reel Width W1 (mm)	A0 (mm)	B0 (mm)	K0 (mm)	P1 (mm)	W (mm)	Pin1 Quadrant
TPS7A1485PYBKR	DSBGA	YBK	6	12000	180.0	8.4	0.8	1.26	0.36	2.0	8.0	Q1

## TAPE AND REEL BOX DIMENSIONS



\*All dimensions are nominal

Device	Package Type	Package Drawing	Pins	SPQ	Length (mm)	Width (mm)	Height (mm)
TPS7A1408PDRVR	WSON	DRV	6	3000	210.0	185.0	35.0
TPS7A1408PYBKR	DSBGA	YBK	6	12000	182.0	182.0	20.0
TPS7A1408PYBKR	DSBGA	YBK	6	12000	182.0	182.0	20.0
TPS7A1409PDRVR	WSON	DRV	6	3000	210.0	185.0	35.0
TPS7A1409PYBKR	DSBGA	YBK	6	12000	182.0	182.0	20.0
TPS7A1409PYBKR	DSBGA	YBK	6	12000	182.0	182.0	20.0
TPS7A14105PDRVR	WSON	DRV	6	3000	210.0	185.0	35.0
TPS7A1410PDRVR	WSON	DRV	6	3000	210.0	185.0	35.0
TPS7A1411PYBKR	DSBGA	YBK	6	12000	182.0	182.0	20.0
TPS7A1412PDRVR	WSON	DRV	6	3000	210.0	185.0	35.0
TPS7A1412PYBKR	DSBGA	YBK	6	12000	182.0	182.0	20.0
TPS7A1412PYBKR	DSBGA	YBK	6	12000	182.0	182.0	20.0
TPS7A1413PYBKR	DSBGA	YBK	6	12000	182.0	182.0	20.0
TPS7A1413PYBKR	DSBGA	YBK	6	12000	182.0	182.0	20.0
TPS7A1418PDRVR	WSON	DRV	6	3000	210.0	185.0	35.0
TPS7A1485PYBKR	DSBGA	YBK	6	12000	182.0	182.0	20.0
TPS7A1485PYBKR	DSBGA	YBK	6	12000	182.0	182.0	20.0

## 重要声明和免责声明

TI“按原样”提供技术和可靠性数据（包括数据表）、设计资源（包括参考设计）、应用或其他设计建议、网络工具、安全信息和其他资源，不保证没有瑕疵且不做任何明示或暗示的担保，包括但不限于对适销性、某特定用途方面的适用性或不侵犯任何第三方知识产权的暗示担保。

这些资源可供使用 TI 产品进行设计的熟练开发人员使用。您将自行承担以下全部责任：(1) 针对您的应用选择合适的 TI 产品，(2) 设计、验证并测试您的应用，(3) 确保您的应用满足相应标准以及任何其他功能安全、信息安全、监管或其他要求。

这些资源如有变更，恕不另行通知。TI 授权您仅可将这些资源用于研发本资源所述的 TI 产品的应用。严禁对这些资源进行其他复制或展示。您无权使用任何其他 TI 知识产权或任何第三方知识产权。您应全额赔偿因在这些资源的使用中对 TI 及其代表造成的任何索赔、损害、成本、损失和债务，TI 对此概不负责。

TI 提供的产品受 [TI 的销售条款](#) 或 [ti.com](#) 上其他适用条款/TI 产品随附的其他适用条款的约束。TI 提供这些资源并不会扩展或以其他方式更改 TI 针对 TI 产品发布的适用的担保或担保免责声明。

TI 反对并拒绝您可能提出的任何其他或不同的条款。

邮寄地址：Texas Instruments, Post Office Box 655303, Dallas, Texas 75265

Copyright © 2024，德州仪器 (TI) 公司